

PROCEEDINGS OF THE 51ST
RENCONTRE ASSYRIOLOGIQUE
INTERNATIONALE



Dedicated to the Memory of Erica Reiner

PROCEEDINGS OF THE
51ST RENCONTRE ASSYRIOLOGIQUE
INTERNATIONALE
Held at
THE ORIENTAL INSTITUTE
of
THE UNIVERSITY OF CHICAGO
JULY 18–22, 2005

edited by

ROBERT D. BIGGS,
JENNIE MYERS,
and
MARTHA T. ROTH

THE ORIENTAL INSTITUTE OF THE UNIVERSITY OF CHICAGO
STUDIES IN ANCIENT ORIENTAL CIVILIZATION • NO. 62
CHICAGO • ILLINOIS

Library of Congress Control Number: 2007937452

ISBN-13: 978-1-885923-54-7

ISBN-10: 1-885923-54-6

ISSN: 0081-7554

The Oriental Institute, Chicago

© 2008 by The University of Chicago. All rights reserved.
Published 2008. Printed in the United States of America.

Studies in Ancient Oriental Civilization • No. 62

Series Editors

Leslie Schramer

and

Thomas G. Urban

Series Editors' Acknowledgments

Lindsay DeCarlo and Katie L. Johnson helped with the production of this volume.

Cover Illustration

The Outer Portal of Citadel Gate A, with the Partially Excavated Central Portal Behind. *Khorsabad*, Part 2: *The Citadel and the Town*, by Gordon Loud and Charles B. Altman, pl. 7. Oriental Institute Publications 40. Chicago: The University of Chicago Press, 1938.

Printed by McNaughton & Gunn, Saline, Michigan

The paper used in this publication meets the minimum requirements of American National Standard for Information Services — Permanence of Paper for Printed Library Materials, ANSI Z39.48-1984.

TABLE OF CONTENTS

PREFACE	vii
DEDICATION	ix
ABBREVIATIONS	xi
LEXICOGRAPHY, PHILOLOGY, AND TEXTUAL STUDIES	1
Archivage et classification: Un récapitulatif de créances à Mari sous Zimri-Lim. <i>Dominique Charpin</i>	3
Identifying Sumerian Compound Nouns. <i>Graham Cunningham</i>	17
Babylon as a Name for Other Cities Including Nineveh. <i>Stephanie Dalley</i>	25
Reflections on the Past and the Future of the <i>Reallexikon der Assyriologie und Vorderasiatischen Archäologie (RIA)</i> . <i>Gabriella Frantz-Szabó</i>	35
Reconsidering ŠU.II ₂ .LA ₍₂₎ as a Classifier of the <i>āšipu</i> in Light of the Iconography of Reciprocal Hand-lifting Gestures. <i>Christopher Frechette, S.J.</i>	41
The Akkadian Word for “Third Gender”: The <i>kalû</i> (gala) Once Again. <i>Uri Gabbay</i>	49
On the Alphabetic Scribal Curriculum at Ugarit. <i>Robert Hawley</i>	57
Corpus-driven Models of Lexicography and Mesopotamian Cultural Heritage Preservation at the CDLI. <i>J. Cale Johnson</i>	69
Storage and Organization of Hittite Grammatical Knowledge. <i>Carol F. Justus†</i>	75
Sumerian Enclitic -àm and Akkadian Enclitic -ma: From Copula to Focus Marker. <i>Fumi Karahashi</i>	85
The Classification of Incantations. <i>W. G. Lambert</i>	93
Texts and Labels: A Case Study from Neo-Sumerian Umma. <i>Romina Laurito, Alessandra Mezzasalma, and Lorenzo Verderame</i>	99
The CAD and Biblical Hebrew Lexicography: The Role of Akkadian Cognates. <i>Baruch A. Levine</i>	111
The Scribes of Nuzi: Date Formulae and Their Use in the Nuzi Corpus. <i>Paola Negri Scafa</i>	119
Classifying Assurbanipal’s Inscriptions: Prisms C, Kh (= CND), and G. <i>Jamie Novotny</i>	127
Les listes et les tables métrologiques, entre mathématiques et lexicographie. <i>Christine Proust</i>	137
Classification de l’utilisation du cunéiforme mésopotamien dans les textes ougaritiques. <i>Carole Roche</i>	155
On Some Terms for Leatherworking in Ancient Mesopotamia. <i>JoAnn Scurlock</i>	171
Computer Algorithm to Detect Similar Administrative Documents from the Ur III Archives. <i>Marek Stępień and Jerzy Tyszkiewicz</i>	177
KADP 36: Inventory, Plant List, or Lexical Exercise. <i>Jan Tavernier</i>	191
Lexicographical Study of the Already-Ancient in Antiquity. <i>Jon Taylor</i>	203
A Classified Past: Classification of Knowledge in the Hittite Empire. <i>Theo van den Hout</i>	211
The Measure of Man: The Lexical Series Ugu-mu. <i>Joan Goodnick Westenholz and Marcel Sigrist</i>	221
ICONOGRAPHY AND ART HISTORY	
King of Sumer and Akkad, King of Ur: Figural Types, Astral Symbols, and Royal Titles in the Neo-Sumerian Period. <i>Mehmet-Ali Ataç</i>	233
The Knowledge of Tradition: A Textual and Iconographic Interpretation. <i>Anna Maria Gloria Capomacchia and Marta Rivaroli</i>	247

Reconstructing Lexicography in Glyptic Art: Structural Relations between the Akkadian Age and the Ur III Period. <i>Alessandro di Ludovico and Marco Ramazzotti</i>	263
Knowing the Foreign: Power, Exotica, and Frescoes in the Middle Bronze Age Levant. <i>Marian H. Feldman</i>	281
Austin’s Asiatic Antiquities: The First Cuneiform Inscriptions Published in America. <i>Steven W. Holloway</i>	287
Bovine Stone Vessels of the Late Uruk Period. <i>Trudy S. Kawami</i>	299
The Akkadian “Bello Stile.” <i>Davide Nadali and Lorenzo Verderame</i>	309
The Classification of Methods of Pictorial Narrative in Assurbanipal’s Reliefs. <i>Chikako E. Watanabe</i>	321
Sennacherib’s Expert Knowledge: Skill and Mastery as Components of Royal Display. <i>Irene J. Winter</i>	333
ARCHAEOLOGY AND STRATIGRAPHY	
The Occupation Levels of Tell Tweini and Their Historical Implications. <i>M. al-Maqdissi, M. Badawy, J. Bretschneider, H. Hameeuw, G. Jans, K. Vansteenhuyse, G. Voet, and K. Van Lerberghe</i>	341
Pottery from the Archaic Ishtar Temples in Assur. <i>Claudia Beuger</i>	351
Mesopotamian Altar Deposits. <i>Judy Bjorkman</i>	361
Classification of Knowledge, an Archaeological Approach: The Case of Nuzi. <i>Simona Bracci</i>	371
The Oriental Institute and Its Role in Mesopotamian Archaeology. <i>McGuire Gibson</i>	383
Bronze Reliefs from Khorsabad. <i>Eleanor Guralnick</i>	389
“Layer By Layer...” Of Digging and Drawing: The Genealogy of an Idea. <i>Maria Gabriella Micale and Davide Nadali</i>	405
Classifying Women: The “Harem” and What It Does and Doesn’t Tell Us about Women. <i>Elna K. Solvang</i>	415
Persepolis-Pasargadae Field Investigations. <i>Mohammad Hassan Talebian</i>	421
AFTERWORD	
De Brevitate Vitae <i>Tupšarrūti</i> : Carmen Amoebaeum vel <i>Zamār Mihrī</i> . <i>Walter Farber</i>	433

PREFACE

In anticipation of the completion of the Chicago Assyrian Dictionary, the Oriental Institute invited the Rencontre Assyriologique to hold its fifty-first Rencontre at the University of Chicago from 18 to 22 July 2005 with the theme “Classifications of Knowledge in the Ancient Near East: Lexicography, Iconography, Stratigraphy.” The Organizing Committee for the meeting was Martha T. Roth, Jennie Myers, and Walter Farber.

While the Editors of this publication of selected contributions to the Rencontre have sought to achieve general uniformity in style of citations, we have left to individual authors the choice of the transliteration system, indication of vowel quality, and such matters. Thus we have, for example, both É and E₂, h and ḫ, Sin and Su'en, etc.

The Editors are grateful to the Director of the Oriental Institute, Professor Gil Stein, for his support of the publication of this volume; and to the Oriental Institute Publications Office, especially Leslie Schramer, Thomas Urban, Lindsay DeCarlo, and Katie L. Johnson for their diligence and attention to all editorial details.

Robert D. Biggs
Jennie Myers
Martha T. Roth

DEDICATION

The CAD is one of the monumental enterprises of twentieth-century assyriological tool-making, along with the *Akkadisches Handwörterbuch* and the *Reallexikon der Assyriologie*. It is impossible for students and scholars today to fathom how to do their work without these fundamental tools. And the CAD, like those other major enterprises, was largely impelled by the energies of one or two dedicated scholars. In the case of the CAD, those scholars were A. Leo Oppenheim (1904–74) and Erica Reiner (1924–2005).

At the time that Martha Roth, Editor in Charge of the Chicago Assyrian Dictionary (CAD), and Gene Gragg, then Director of the Oriental Institute, extended an invitation to the RAI Executive Committee for Chicago to host a future Rencontre, the hope was that the project's final volume would be published or in press by the date of that Rencontre and that we would have the occasion to celebrate Erica Reiner's fifty year commitment to the project. Fortunately, although the final volume was not in fact ready, we were able to honor and to fete Erica at the social and scholarly events in Chicago. In fact, Erica herself hosted one of her legendary garden parties for all those many RAI participants who had been contributors over the years to the CAD project. Unbeknownst to all, it was to be one of her last parties.

When Erica fell ill in October 2005, she chose to live her remaining time with dignity and privacy. Many of her closest friends and colleagues knew nothing of her health condition until her death on December 31. Her death stunned those who had seen her so active and involved just months before at the Rencontre. We dedicate this volume to her enduring memory, just as we had dedicated the Rencontre itself to her enduring legacy, the Chicago Assyrian Dictionary.

ABBREVIATIONS

cf.	<i>confer</i> , compare
col.	column
diss.	dissertation
ed(s).	editor(s)
et al.	<i>et alii</i> , and others
ETCSL	Electronic Text Corpus of Sumerian Literature
fig(s).	figure(s)
i.e.	<i>id est</i> , that is
f(f).	and following page(s)
l(l).	line(s)
n(n).	note(s)
No(s).	number(s)
obv.	obverse
p(p).	page(s)
pl(s).	plate(s)
RAI	Rencontre Assyriologique Internationale
rev.	reverse
s.v(v).	<i>sub voce</i> , under the word(s)
vol(s).	volume(s)

Other abbreviations may be found in the List of Abbreviations of the most recent volume of *The Assyrian Dictionary of the Oriental Institute of the University of Chicago* (CAD), Volume 19, T. Chicago: The Oriental Institute, 2006.

**LEXICOGRAPHY, PHILOLOGY, AND
TEXTUAL STUDIES**

ARCHIVAGE ET CLASSIFICATION: UN RÉCAPITULATIF DE CRÉANCES À MARI SOUS ZIMRI-LIM*

Dominique Charpin, École pratique des hautes études, Paris

L'activité de classification est généralement envisagée par les assyriologues d'un point de vue purement intellectuel: on met en avant la "science des listes" qui serait caractéristique des scribes mésopotamiens. Mais on ne doit pas oublier qu'ils pouvaient aussi se livrer à un travail de classification lorsqu'ils procédaient aux nombreux inventaires qui nous ont été conservés. C'est le cas, par exemple, des fonctionnaires de Mari qui étaient chargés de veiller sur les trésors royaux, en particulier sur la vaisselle de luxe que le souverain utilisait lors des grandes réceptions dans son palais et qu'il emportait avec lui lorsqu'il voyageait: les inventaires qui nous en ont été conservés, étudiés de manière adéquate, se révèlent d'une grande richesse en dépit de leur apparente monotonie.¹ Une autre circonstance qui conduisait à la rédaction d'inventaires était la mort des personnages les plus importants du royaume. C'est ainsi qu'après le décès du ministre Sammêtar, au mois ii ou iii de l'an 7 de Zimrî-Lîm, on procéda à l'inventaire de ses possessions (notamment sa maison à Terqa, etc.).² On retrouva en particulier des créances, dans lesquelles on mit de l'ordre.³ Quelques mois plus tard, une procédure similaire eut lieu, qui toucha cette fois les possessions d'Inibšina, prêtresse-*ugbaltum* du dieu Addu;⁴ les tablettes d'inventaire sont datées du 8/xii/ZL 7 (= ZL 6').⁵ Les raisons d'une telle procédure sont obscures, parce qu'il semble qu'Inibšina était encore en vie. Le nombre de tablettes d'inventaire n'est pas aussi élevé que dans le cas de Sammêtar, mais le scribe chargé de mettre de l'ordre dans les archives retrouva toutes sortes de créances non recouvrées et rédigea alors le texte M.15119+. C'est la fin, écrite sur la tranche latérale de la tablette, qui nous permet de saisir le sens du document: "Total (général): 51 *ugâr* 7 *kur* de grain, (capital) auquel s'ajoutera (un intérêt) de 40 *qa* par *kur*. Šûbnalû a reçu 2 tablettes scellées, copie de la présente tablette, pour recouvrer (ces créances)." Il s'agit donc du récapitulatif de dettes non remboursées, contractées par de nombreux individus envers deux des plus hautes dames de Mari, Addu-dûrî et Inibšina. Il permet de voir la manière dont le scribe cita et ordonna les créances, confiées à Šûbnalû pour recouvrement: c'est cet exercice de classification qu'on voudrait ici analyser.

* Cette contribution s'inscrit dans le cadre du projet "Archives et vie économique dans le Proche-Orient amorrite" désormais intégré à la FRE 2454 (CNRS / Collège de France / EPHE / INALCO), qui a déjà donné lieu aux publications suivantes: "Les prêteurs et le palais: les édits de *mîšarum* des rois de Babylone et leurs traces dans les archives privées," dans *Interdependency of Institutions and Private Entrepreneurs (MOS Studies 2)* (Proceedings of the Second MOS Symposium, Leiden, 1998), édité par A. C. V. M. Bongenaar, Publications de l'Institut historique et archéologique néerlandais de Stamboul 87 (Leyde: Nederlands Instituut voor het Nabije Oosten, 2000), pp. 185–211; "Les dieux prêteurs dans le Proche-Orient amorrite (ca. 2000–1600 av. J.-C.)," dans *Les dieux manieurs d'argent: l'activité bancaire des sanctuaires dans l'antiquité*, édité par V. Chankowski, Topoi 12/13 (Lyon: Maison de l'Orient méditerranéen, 2005), pp. 13–34; "Données nouvelles sur la vie économique et sociale de l'époque paléo-babylonienne," *Orientalia* NS 74 (2005): 409–21; "Économie et société à Sippar et en Babylonie du nord à l'époque paléo-babylonienne," *Revue d'Assyriologie* 99 (2000): 133–76; "L'endettement et ses conséquences dans le Proche-Orient ancien," à paraître dans la *Revue d'Assyriologie*.

¹ Voir Michaël Guichard, *La Vaisselle de luxe des rois de Mari*, Matériaux pour le Dictionnaire de Babylonien de Paris II, Archives Royales de Mari 31 (Paris: Éditions Recherche sur les Civilisations, 2005).

² Frans van Koppen, "Seized by Royal Order: The Households of Sammêtar and other Magnates at Mari," dans *Recueil d'études à la mémoire d'André Parrot*, Florilegium marianum 6, édité par D. Charpin et J.-M. Durand, Mémoires de NABU 7 (Paris: SEPOA, 2002), pp. 289–372.

³ Cf. Florilegium marianum 6 39 (van Koppen, "Seized by Royal Order," p. 343). Corriger le résumé: il ne s'agit pas d'un "account of barely," mais d'un inventaire de créances de même type que ARM 23 70 (voir ci-dessous).

⁴ Voir Nele Ziegler, *Le Harem de Zimrî-Lîm*, Florilegium marianum 4, Mémoires de NABU 5 (Paris: SEPOA, 1999), p. 48 et n. 292; ajouter depuis Florilegium marianum 6 47 et 48 et voir le commentaire d'ensemble de van Koppen, "Seized by Royal Order," pp. 326–27.

⁵ Pour le système chronologique ici utilisé, voir Dominique Charpin et Nele Ziegler, *Mari et le Proche-Orient à l'époque amorrite: essai d'histoire politique*, Florilegium marianum 5, Mémoires de NABU 6 (Paris: SEPOA, 2003), pp. 257–58.

1. LE TEXTE⁶

M.15119+M.15287

Liste de créances non remboursées, confiées à Šūbnaġu pour recouvrement. Le 27/i/ZL 8 (= ZL 7').

- 1 a-gàr še ur₅-ra máš 1 gur 0,0.4 àm *ú-ša-ab*
 2 ki ^fdIM-du-ri
be-lí-qar-ra-ad ù^dsu⁷en-mu-ša-lim il-qú-ú
 4 mu zi-im-ri-li-im *áš-la-ka-a-a^{ki}/iṣ-ba-tu*
- 1 a-gàr še ur₅-ra máš 1 gur 0,0.4 àm
 6 ^fan-nu-ši-im-hi
 mu zi-im-ri-li-im
 8 ^{giš}gu-za g[al] a-na ^dutu *ú-še-lu-ú*
- [2 a-gàr š]e u[r]₅-[ra máš] 1 gur [0,0.4] ¹àm¹ a-hu-ši-na
 10 5 gur [...] *eš₄-tár*
 1 a-gàr *qí-iš-ti-^dma-ma*
 12 2 gur *ú-ba-bu*
ša pí-i ka-ni-ka-tim
- 14 3 gur kù-babbar-^dutu *ša la ka-ni-ki-im*
 4 a-gàr še *ša ša-at-tum*
 16 *la ša-aṭ-ru*
-
- šū-nigin₂ 6 a-gàr še ur₅-ra
 18 *ša^fdIM-du-ri*
- 1 a-gàr še ur₅-ra máš 1 gur 0,0.4 àm
 20 ki ^fi-ni-ib-ši-na
id-di-nu il-qé
- T.²² 3 a-gàr *a-bi-ra-bi*
 1 a-gàr *ha-¹a-yu¹-um-ra-bi*
 24 1 a-gàr z[i-ⁱ]k-ra-an
 2 a-gàr *ri-im-ši-dingir*
 26 [...] 5 gur *qí-iš-ti-^dta-bu-bu*
- R. [...] *a-na-iš*
 28 [x ...] *a-na-^dda-gan-ták-la-ku dam-gàr*
 1 a-[gàr ...] ^dIM-ra-bi *ka-ni-ka/-tum*
 30 3 gur [mu-ut]-*ha-bu-úr la ka-an-ku*
 3 gur *h[i-it]-la-nu*
 32 3 gur ^feš₄-*tár-um-mi*
 2 gur *ri-im-ši-dingir*
 34 1 gur ^dnin-giš-zi-da-a-bi
ša la ka-ni-ka-tim
-

⁶ Je remercie Jean-Marie Durand pour m'avoir confié la publication de ce texte (cliché Archives Royales de Mari).

- 36 15 a-gàr 7 gur še ur₅-ra
mu zi-im-ri-li-im ma-sú ú-bi/-bu
- 38 2 a-gàr zi-im-ri-eš₄-tár
lú za-ar-ri^{ki}
- 40 1 a-g[àr šíl-l]í-ku-bi tibira
1 a-gàr [ás^l-di-[^dn]u-nu
- 42 5 gur hi-il-[la-l]um
5 gur ì-lí-i-dí-nam
- 44 ka-ni-ka-tum
5 a-gàr še ur₅-ra ša la ša-at-tim
-
- 46 2 a-gàr šíl-lí-ku-bi
2 a-gàr ì-lí-i-dí-nam kù-dím
- 48 2 a-gàr ì-lí-iš-ti-kal kù-dím
2 a-gàr me-ki-nu
- 50 2 a-gàr ha-a-yu-um-ra-bi
16 a-gàr šu-ub-na-lu-ú
- T.⁵² šu-nigin₂ 25 a-gàr še ur₅-ra
mu zi-im-ri-li-im
- 54 bād^{ki} ia-ah-du-li-im / i-pu-šu
- T.L.i šu-nigin₂ 51 a-gàr 7 gur še ur₅-r[a]
56 máš 1 gur 0,0.4 àm ú-ša-a[b]
me-he-er tup-pí an-ni-i-im
- ii⁵⁸ [2 ka^l-ni-ka-tum
a-na šu-ud-du-nim
- 60 [šu-ub-na-lu-ú ma-hi-ir
igi lugal
- iii⁶² iti ú-ra-[hi-im u₄] 27-[kam]
mu zi-i[m-ri-li-im]
- 64 alam-šu a-na ^{dh}[a-aṭ-ṭ]á
[ú^l-[še-lu-ú]
- ¹⁻⁴ 1 ugâr de grain, dette (à laquelle) un intérêt de 40 qa par kur s’ajoutera; Bêlî-qarrâd et Sîn-mušallim ont reçu d’Addu-dûrî; année ZL 4 (=ZL 3’);
- ⁵⁻⁸ 1 ugâr de grain, dette (à laquelle) un intérêt de 40 qa par kur s’ajoutera; Annu-šimhi; année ZL 5 (= ZL 4’);
- ⁹ [2 ugâr de gr]ain, det[te (à laquelle) un intérêt de 40 qa par kur s’ajoutera]; Ahušina;
- ¹⁰ 5 kur: [...]–Eštar;
- ¹¹ 1 ugâr: Qišti-Mamma;
- ¹² 2 kur: Ubabu;
- ¹³ Selon la teneur des tablettes scellées.
- ¹⁴ 3 kur Kasap-Šamaš, sans tablette scellée;
¹⁵ 4 ugâr de grain, dont l’année ¹⁶ n’a pas été écrite.
¹⁷ Total: 6 ugâr de grain, dette(s) ¹⁸ au crédit d’Addu-dûrî.
- ¹⁹ 1 ugâr de grain, dette (à laquelle) un intérêt de 40 qa par kur (s’ajoutera); ²¹ Iddinu a reçu ²⁰ d’Inibšina;
- ²² 3 ugâr: Abî-rabi;
- ²³ 1 ugâr: Hayûm-rabi;

- 24 1 *ugâr*: Zikrân;
 – 25 2 *ugâr*: Rimši-Ilum;
 – 26 [...] 5 *kur*: Qišti-Tabubu;
 – 27 [...]: Anaiš;
 – 28 [...]: Ana-Dagan-taklâku, marchand;
 – 29 1 *ug[ar ...]*: Addu-rabi; tablettes scellées.
 – 30 3 *kur*: [Mut]-Habur; (tablette) non scellée;
 – 31 3 *kur*: Hitlânu;
 – 32 3 *kur*: Eštar-ummî;
 – 33 2 *kur*: Rimši-Ilum;
 – 34 1 *kur*: Ningišzida-abî;
³⁵ sans tablettes scellées.
³⁶ (Sous-total:) 15 *ugâr* 7 *kur* de grain, dette(s), année ZL 6 (= ZL 5').
 – 38 2 *ugâr* de grain: Zimri-Eštar, ³⁹ de Zarri;
 – 40 1 *ugâr*: Šilli-Kubi, forgeron;
 – 41 1 *ugâr*: Asdi-Nunu;
 – 42 5 *kur*: Hillâlum;
 – 43 5 *kur*: Ilî-iddinam;
⁴⁴ tablettes scellées;
⁴⁵ 5 *ugâr* de grain, dette(s) sans année;
 – 46 2 *ugâr*: Šilli-Kubi;
 – 47 2 *ugâr*: Ilî-iddinam, l'orfèvre;
 – 48 2 *ugâr*: Iliš-tikal, l'orfèvre;
 – 49 2 *ugâr*: Mêkinum;
 – 50 2 *ugâr*: Hayûm-rabi;
 – 51 16 *ugâr*: Šûbnaîû;
⁵² Total: 25 *ugâr* de grain, dette(s) ^{53–54} de ZL 7 (= ZL 6').
⁵⁵ Total général: 51 *ugâr* 7 *kur* de grain, dette(s) ⁵⁶ (à laquelle) un intérêt de 40 *qa* par *kur* (s'ajoutera).
⁶⁰ Šûbnaîû a reçu ⁵⁸ 2 tablettes scellées(!), ⁵⁷ copie de la présente tablette ⁵⁹ pour recouvrer (ces créances).
⁶¹ (Fait) en présence du roi.
^{62–65} Le 27/i/ZL 8 (= ZL 7').

58) On attendrait plutôt 2 *ka-ni-ka-tim*, mais le signe *-tum* est clair.

2. COMMENTAIRE

A l'époque paléo-babylonienne, les créanciers devaient en principe conserver les reconnaissances de dettes scellées par leurs débiteurs jusqu'au moment où ils étaient remboursés; c'est lorsque le débiteur versait ce qu'il devait que la tablette était détruite.⁷ Les créances retrouvées lors de l'inventaire des biens d'Inibšina restaient donc à recouvrer. On verra la façon dont le scribe en résuma le contenu et comment il organisa le récapitulatif qu'il en dressa, avant d'analyser la situation économique révélée par cette procédure.

⁷ Pour des exceptions, voir Dominique Charpin, "Lettres et procès paléo-babyloniens," dans *Rendre la justice en Mésopotamie*, édité par F. Joannès (Paris: Presses Universitaires de Vincennes, 2000), pp. 69–111 et Charpin, "Les prêteurs et le palais." Pour les pratiques des marchands paléo-assyriens, voir en dernier lieu Klaas R.

Veenhof, "Archives of Old Assyrian Traders," dans *Ancient Archives and Archival Traditions: Concepts of Record Keeping in the Ancient World*, édité par M. Brosius (Oxford: Oxford University Press, 2003), pp. 78–123 (pp. 112–15).

2.1. LE RÉSUMÉ DES TEXTES

Manifestement, ce récapitulatif a été établi par le scribe à partir des créances qu'il avait sous les yeux. On observera la façon dont il abrège de plus en plus à l'intérieur de chacune des deux sections. Au premier paragraphe (l. 1–4), tout est repris: formule de l'intérêt complète, nom du créancier, nom des débiteurs, verbe, le scribe reproduisant manifestement le formulaire exact de la tablette originelle (comparer avec ARM 8 56⁸). Dès le deuxième paragraphe (l. 5–8), le verbe dans la formule de l'intérêt est omis et on ne trouve plus que le nom du débiteur. A partir du troisième paragraphe (l. 9), on ne trouve même plus de mention de l'intérêt, mais seulement le montant de l'emprunt et le nom du débiteur. Dans la deuxième section, on constate le même processus, de manière encore plus radicale: au § 8 (l. 19–21), on a la copie complète du début de la créance; dès le paragraphe suivant (l. 22), le texte est abrégé au maximum avec seulement le montant de l'emprunt et le nom du débiteur. Mais le total général est clair (l. 55–56): tous les prêts récapitulés dans cette tablette sont des prêts à intérêt. Par ailleurs, même si le nom d'Inibšina comme créancière n'apparaît que l. 20, il est sûr que les dettes énumérées en dessous sont toutes à son crédit.⁹

2.2. LA STRUCTURE DU RÉCAPITULATIF

La structure du texte, qui n'est pas claire à première lecture malgré les efforts de "mise en page" du scribe, peut être établie de la manière suivante:

- A. Créances d'Addu-dûrî (l. 18)
 - A.1. Créances datées:
 - ZL 4 (= ZL 3'): 1 a-gâr (l. 1–4)
 - ZL 5 (= ZL 4'): 1 a-gâr (l. 5–8)
 - (sous-total [non donné par la tablette]: 2 a-gâr)
 - A.2. Créances sans nom d'année (l. 15–16):
 - d'après tablettes scellées (l. 13): [2 a-gâr] (l. 9); 5 gur (l. 10); 1 a-gâr (l. 11); 2 gur (l. 12)
 - sans tablettes (l. 14): 3 gur (l. 14)
 - sous-total: 4 a-gâr (l. 15–16)
- Total: **6 a-gâr** (l. 17–18)

- B. Créances d'Inibšina (l. 20)
 - B.1. Créances datées de ZL 6 (= ZL 5'): **15 a-gâr 7 gur** (l. 36–37; détail l. 19 à 35, dont 9 tablettes scellées (l. 19–29; 1 tablette non scellée l. 30; 4 créances sans tablette l. 31–35)
 - B.2. Créances sans nom d'année: **5 a-gâr** (l. 45; détail l. 38–43, précisant l. 44 qu'il y a des tablettes scellées pour ces 4 créances)
 - B.3. Créances datées de ZL 7 (= ZL 6'): **25 a-gâr** (l. 52–54; détail l. 46–51)
- C. Total général: 51 a-gâr 7 gur (l. 55), qui correspond aux quatre chiffres ci-dessus marqués en gras.

⁸ Voir la réédition de ce texte en annexe.

⁹ Sur l'absence de total des créances d'Inibšina comparable au total des créances d'Addu-dûrî l. 17–18, voir ci-dessous § 2.4.

Tableau récapitulatif.

N°	Lignes	Tablette	Date	Quantité	Débiteur	Créancier
1	1–4	<i>kanikum</i> (cf. l. 13: <i>ša pî kanîkâtîm</i>)	ZL 4 (= ZL 3')	1 a-gàr	Bêli-qarrâd et Sîn-mušallim	Addu-dûrî (l. 2)
2	5–8	<i>kanikum</i> (l. 13)	ZL 5 (= ZL 4')	1 a-gàr	^f Annu-šimhi	Addu-dûrî (l. 18)
3	9	<i>kanikum</i> (l. 13)	<i>ša šattum lâ šaṭru</i> (l. 15–16)	[2 a-gàr]	Ahušina	Addu-dûrî (l. 18)
4	10	<i>kanikum</i> (l. 13)	<i>ša šattum lâ šaṭru</i> (l. 15–16)	5 gur	[...]-Eštar	Addu-dûrî (l. 18)
5	11	<i>kanikum</i> (l. 13)	<i>ša šattum lâ šaṭru</i> (l. 15–16)	1 a-gàr	Qišti-Mamma	Addu-dûrî (l. 18)
6	12	<i>kanikum</i> (l. 13)	<i>ša šattum lâ šaṭru</i> (l. 15–16)	2 gur	Ubabu	Addu-dûrî (l. 18)
7	14	<i>ša lâ kanîkim</i> (l. 14)	<i>ša šattum lâ šaṭru</i> (l. 15–16)	4 gur	Kasap-Šamaš	Addu-dûrî (l. 18)
8	19–21	<i>kanikum</i> (cf. l. 29 <i>kanîkâtum</i>)	ZL 6 (= ZL 5') (l. 37)	1 a-gàr	Iddinu	Inibšina (l. 20)
9	22	<i>kanikum</i> (cf. l. 29 <i>kanîkâtum</i>)	ZL 6 (= ZL 5') (l. 37)	3 a-gàr	Abi-rabi	—
10	23	<i>kanikum</i> (cf. l. 29 <i>kanîkâtum</i>)	ZL 6 (= ZL 5') (l. 37)	1 a-gàr	Hayûm-rabi	—
11	24	<i>kanikum</i> (cf. l. 29 <i>kanîkâtum</i>)	ZL 6 (= ZL 5') (l. 37)	1 a-gàr	Zikrân	—
12	25	<i>kanikum</i> (cf. l. 29 <i>kanîkâtum</i>)	ZL 6 (= ZL 5') (l. 37)	2 a-gàr	Rimši-Ilum	—
13	26	<i>kanikum</i> (cf. l. 29 <i>kanîkâtum</i>)	ZL 6 (= ZL 5') (l. 37)	[...] 5 gur	Qišti-Tabubu	—
14	27	<i>kanikum</i> (cf. l. 29 <i>kanîkâtum</i>)	ZL 6 (= ZL 5') (l. 37)	[...]	Ana'îš	—
15	28	<i>kanikum</i> (cf. l. 29 <i>kanîkâtum</i>)	ZL 6 (= ZL 5') (l. 37)	[...]	Ana-Dagan-taklâku dam-gàr	—
16	29	<i>kanikum</i> (cf. l. 29 <i>kanîkâtum</i>)	ZL 6 (= ZL 5') (l. 37)	1 a-gàr	Addu-rabi	—
17	30	<i>la kanku</i>	ZL 6 (= ZL 5') (l. 37)	3 gur	Mut-Habur	—
18	31	<i>ša lâ kanîkatîm</i> (l. 35)	ZL 6 (= ZL 5') (l. 37)	3 gur	Hitlanu	—
19	32	<i>ša lâ kanîkatîm</i> (l. 35)	ZL 6 (= ZL 5') (l. 37)	3 gur	Eštar-ummî	—
20	33	<i>ša lâ kanîkatîm</i> (l. 35)	ZL 6 (= ZL 5') (l. 37)	2 gur	Rimši-Ilum	—
21	34	<i>ša lâ kanîkatîm</i> (l. 35)	ZL 6 (= ZL 5') (l. 37)	1 gur	Ningizzida-abî	—
22	38	<i>kanikum</i> (<i>kanîkâtum</i> l. 44)	<i>ša lâ šattîm</i> (l. 45)	2 a-gàr	Zimrî-Eštar de Zarri	—
23	40–41	<i>kanikum</i> (<i>kanîkâtum</i> l. 44)	<i>ša lâ šattîm</i> (l. 45)	1 a-gàr	Šilli-Kubi tibira	—

N°	Lignes	Tablette	Date	Quantité	Débiteur	Créancier
24	41	<i>kanikum</i> (<i>kanikatum</i> l. 44)	<i>ša lâ šattim</i> (l. 45)	1 a-gàr	Asdi-Nunnu	—
25	42	<i>kanikum</i> (<i>kanikatum</i> l. 44)	<i>ša lâ šattim</i> (l. 45)	5 gur	Hillalum	—
26	43	<i>kanikum</i> (<i>kanikatum</i> l. 44)	<i>ša lâ šattim</i> (l. 45)	5 gur	Ilî-iddinam	—
27	46	—	ZL 7 (= ZL 6') (l. 53–54)	2 a-gàr	Šilli-Kubi	—
28	47	—	ZL 7 (= ZL 6') (l. 53–54)	2 a-gàr	Ilî-iddinam kù-dím	—
29	48	—	ZL 7 (= ZL 6') (l. 53–54)	2 a-gàr	Ilîš-tikal kù-dím	—
30	49	—	ZL 7 (= ZL 6') (l. 53–54)	2 a-gàr	Mêkinum	—
31	50	—	ZL 7 (= ZL 6') (l. 53–54)	2 a-gàr	Hayûm-rabi	—
32	51	—	ZL 7 (= ZL 6') (l. 53–54)	16 a-gàr	Šûbnaîû	—

2.3. TYPOLOGIE DES CRÉANCES

Nous pouvons reconstruire la typologie des créances utilisée par le scribe. Elle est basée sur une série d'oppositions:

- 1) selon la présence ou l'absence d'une tablette scellée: *ša pî kanikatum* l. 13 ≠ *ša lâ kanikum* (l. 14);
- 2) selon le fait que la tablette est scellée ou non: *kanikatum* l. 29 ≠ *lâ kanku* l. 30;¹⁰
- 3) selon la présence ou l'absence d'une date: on a un nom d'année (l. 4, 7–8, 37, 53–54), ou bien l'indication "dont l'année n'a pas été écrite" (*ša šattum lâ šaṣru*, l. 15–16) // "dépourvu d'année" (*ša lâ šattim*, l. 45).

La combinaison de ces trois critères débouche sur six possibilités différentes (les n^{os} renvoient au tableau ci-dessus):

- tablette datée scellée (11 cas): n^{os} 1, 2, et 8 à 16;
- tablette datée non scellée (1 cas): n^o 17;
- tablette scellée non datée (9 cas): n^{os} 3 à 6 et 22 à 26;
- ce qui est curieux, c'est l'existence d'une quatrième catégorie, "non-tablette datée" (4 cas): n^{os} 18 à 21. Il y a manifestement des cas où le prêt ne donna pas lieu à la rédaction d'une tablette. Néanmoins, le créancier était capable de connaître la date du prêt, ce qui suppose un texte (sorte de memorandum).¹¹ On notera que cela concerne des prêts de faible montant: de 1 à 3 *kur* seulement;
- la cinquième catégorie est représentée par les n^{os} 27 à 32 (6 cas): le scribe n'a pas indiqué s'il existait des tablettes ou non, mais ces six prêts sont datés. Les montants sont nettement plus élevés que dans la catégorie précédente (2 à 16 *ugâr*);
- logiquement, on trouve une sixième catégorie: prêt sans date et sans tablette, qui n'est représentée que par le n^o 7.

¹⁰ L. 30, il doit s'agir d'une tablette non scellée, vu la formulation et le contraste avec les l. 29 et 35.

¹¹ Ces textes étaient désignés comme *liginnu*: voir à ce sujet van Koppen, "Seized by Royal Order," p. 327 et n. 191.

2.4. LE PRINCIPE DE CLASSEMENT DES CRÉANCES

Quels principes de classement le scribe a-t-il adopté dans son récapitulatif? Un classement en fonction de la nature des objets prêtés était en l'espèce impossible, puisqu'il ne s'agit que de créances en grain. Mais différentes solutions étaient *a priori* envisageables:

- on aurait pu avoir un classement en fonction de la nature des prêts. Un exemple de récapitulatif de créances selon ce principe est donné par BM 97188,¹² qui reprend 14 prêts, dont la nature est soigneusement enregistrée: on y différencie notamment les prêts-*tadmiqtum* des prêts à intérêt (*māš^dutu*).¹³ Mais ici, tous les prêts sont du même type (*ur₃-ra*);
- on aurait pu avoir un classement par débiteurs: mais en l'occurrence, un tel critère était assez peu pertinent, car il n'y a que deux ou trois cas où l'on ait deux créances pour une même personne: Hayûm-rabi (l. 23 et 49); Rimši-Illum (l. 25 et 33); Şilli-Kubi (l. 40 et 46¹⁴);
- on aurait pu avoir les créances classées d'après les quantités prêtées, en ordre croissant: les créances les plus importantes auraient été les premières à recouvrer. Ce critère n'a manifestement pas intéressé notre scribe, alors que c'est le principe retenu par les marchands paléo-assyriens;¹⁵
- on aurait pu avoir un classement chronologique; le problème est qu'une partie importante des créances n'est pas datée (21 sur 32).

Finalement, le scribe opéra un tri multicritère, comme nous dirions aujourd'hui:

1/ Par créancier: Addu-dûrî d'abord, Inibšina ensuite.

2/ A l'intérieur de chacune des deux sections, par date:

- tablettes datées en ordre chronologique croissant;¹⁶
- tablettes non datées;

3/ Selon la présence ou l'absence de tablette.

Etant donné qu'Addu-dûrî est morte au début de l'année 6 (ZL 5'),¹⁷ il n'y a pas de chevauchement chronologique entre les deux groupes. A l'intérieur de chaque section, on trouve donc d'abord les tablettes datées et scellées, puis les tablettes datées non scellées, puis les prêts datés sans tablettes et finalement les tablettes non datées. On observe un seul écart par rapport à ce principe: les § 27 à 32, où l'ensemble des créances est daté mais où le scribe ne mentionne pas s'il existe ou non des tablettes. Il pourrait s'agir d'un ajout du scribe, qui se rendit compte qu'il avait oublié ces prêts plus haut (après la l. 37).

On peut observer la façon dont le scribe a procédé à des totaux partiels. Le total général figure l. 54. Mais à l'intérieur de chacune des deux sections, le scribe n'a pas été systématique:

- il a fait le total des 7 créances d'Addu-dûrî l. 17–18; ce total reprend le sous-total (l. 15–16) des 5 créances non datées. Mais les 2 créances datées n'ont pas fait l'objet d'un sous-total (qui aurait dû suivre la l. 8);
- il n'y a pas de total des créances d'Inibšina comparable aux l. 17–18 pour Addu-dûrî: on a trois sous-totaux:
 - l. 36, pour 14 créances de ZL 6 (= ZL 5');
 - l. 45, pour 5 créances sans nom d'année;
 - l. 52, pour 6 créances de ZL 7 (= ZL 6').

¹² Cf. Christopher Walker, "Some Assyrians at Sippar in the Old Babylonian Period," *Anatolian Studies* 30 (1980): 15–22.

¹³ La raison de cette distinction est sans doute le fait que les prêts-*tadmiqtum* n'étaient pas annulés par une *mīšarum*, au contraire des prêts à intérêt; voir Charpin, "Les prêteurs et le palais," p. 190 n. 22.

¹⁴ Il pourrait s'agir d'homonymes: le premier a son nom suivi d'un nom de métier, le nom du second n'est suivi d'aucune précision.

¹⁵ Lors de la discussion qui a suivi ma communication, K. R. Veenhof a rappelé que dans les archives des marchands paléo-assyriens le classement des créances impayées ne se faisait jamais en ordre chronologique, mais par montants. Pour un exemple récemment publié, voir

Karl Hecker, "*kaspum mādum ša tuppē mādūtīm*," dans *Von Sumer nach Ebla und zurück* (Festschrift Giovanni Pettinato zum 27. September 1999 gewidmet von Freunden, Kollegen und Schülern), édité par H. Waetzoldt, *Heidelberger Studien zum alten Orient* 9 (Heidelberg: Heidelberger Orientverlag, 2004), pp. 63–72 (avec p. 64 la référence à d'autres cas).

¹⁶ Observons au passage que le joint des deux fragments n'avait pas encore été effectué lorsque Maurice Birot publia ses "Données nouvelles sur la chronologie du règne de Zimri-Lim," *Syria* 55 (1978): 333–43; la séquence ZL 3' à 7' s'y trouve confirmée.

¹⁷ Ziegler, *Le Harem de Zimri-Lim*, pp. 50–51.

La “mise en page” a permis au scribe d’éviter des erreurs: chaque total partiel est en effet marqué par une ligne suivie d’un blanc (avant les l. 17 et 36; après la l. 45; la l. 52 débutant sur la tranche, le marquage n’est pas aussi net).

2.5. DES CRÉANCES DISPARUES

Aucune des créances énumérées dans ce récapitulatif ne nous est parvenue, mais tel n’est pas toujours le cas; on verra qu’il existe par ailleurs deux autres récapitulatifs analogues à M.15119+.

2.5.1. Un récapitulatif et ses originaux

Certaines archives d’époque paléo-babylonienne nous ont conservé à la fois les originaux de créances impayées et leur récapitulatif. L’exemple plus récemment publié est AUCT 5 99.¹⁸ Ce texte récapitule des créances non encore recouvrées, le créancier étant presque toujours Ibni-Amurru. Or nous possédons encore 5 des créances reprises dans ce texte:

- (1–2) “ $\frac{1}{6}$ (sicle) d’argent: Ibni-Marduk, homme de Kibalmašda”: la créance est AUCT 5 43;
- (3) “ $1\frac{1}{2}$ (sicle): Ninnû”: la créance est BBVOT 1 48;¹⁹
- (4) “ $3\frac{1}{4}$ sicles d’argent: Bûr-Adad”: la créance est BBVOT 1 38 (prêt d’argent à rendre sous forme de 26 mines de laine; le créancier est Apil-Amurru, non Ibni-Amurru, mais ces deux hommes travaillaient en étroite association);
- (6) “1 sicle d’argent: Mâr-Sippar”: la créance est BBVOT 1 40;
- (7) “ $1\frac{1}{3}$ sicle 12 grains d’argent: Tarîbum de Uselli”: la créance est AUCT 5 41.

Il convient de souligner qu’aucune des 13 créances en nature (sésame et huile de sésame) énumérées dans la deuxième partie de AUCT 5 99 n’a été retrouvée; vu la modestie des montants en jeu (aux alentours de 1 *qa*), elles n’ont sans doute pas fait l’objet d’un contrat écrit. La conclusion est très importante: tant ce texte de AUCT 5 que le texte de Mari montrent que les prêts pouvaient très bien ne pas faire l’objet de la rédaction d’une créance. Cela limite encore plus les conclusions quantitatives qu’on peut tirer d’un point de vue économique des créances qui ont été retrouvées: on voit une fois de plus à quel point elles ne sont pas représentatives de ce qui a existé.²⁰

2.5.2. D’autres créances impayées

Apparemment, la tablette M.15119+ ne récapitulait pas la totalité des créances dues à Inibšina. On possède en effet deux autres documents du même type.²¹ ARM 23 70 concerne des prêts de grain, dont le recouvrement est également confié à Šûbnaîû. Ce texte est antérieur à M.15119+, puisqu’il date du mois 8/xii/ZL 7 au lieu du 27/i/ZL 8. Dans ce récapitulatif, la date des prêts n’est indiquée nulle part; en outre, les débiteurs ne sont pas des individus, mais des localités. Le principe de classement semble cette fois géographique: on a d’abord les localités du district de Mari (l. 1–16), suivies par la mention de Qaṭṭunân sur le Habur. On notera l’importance du capital prêté: près de 300 *ugâr* de grain au total, à comparer avec les 51 *ugâr* de M.15119+.

Par ailleurs, le texte ARM 8 56 est une créance d’Inibšina de 37 *ugâr* de grain au débit des habitants de Šehrum, dont le recouvrement semble également confié à Šûbnaîû; le texte date du 21/i/ZL 8, soit six jours avant M.15119+.

¹⁸ M. Sigrist, *Old Babylonian Account Texts in the Horn Archaeological Museum*, Andrews University Cuneiform Texts, Assyriological Studies 5 (Berrien Springs: Andrews University Press, 2003) (ici AUCT 5). Voir à ce sujet mon étude “Données nouvelles sur la vie économique.”

¹⁹ D. Arnaud, *Altbabylonische Rechts- und Verwaltungsurkunden*, Berliner Beiträge zum Vorderen Orient 1 (Berlin: Dietrich Reimer, 1990) (ici BBVOT 1).

²⁰ Ce point est développé dans mon étude sur “L’endettement et ses conséquences”; voir déjà “Les prêteurs et le palais.” Je citerai simple-

ment ici l’avis de Boyer, qui raisonnait à partir de la quarantaine de contrats publiés par lui en 1958: “Au contraire des contrats d’Ashjaly et de Tutub où les prêts de grain sont en grande majorité, ils sont rares à Mari où prédominent les prêts d’argent” (Georges Boyer, *Textes juridiques*, Archives Royales de Mari 8 [Paris: Imprimerie Nationale, 1958], p. 199). Les textes publiés depuis montrent qu’il s’agit d’une illusion documentaire.

²¹ Voir leur réédition ci-dessous dans l’annexe.

2.6. UN APERÇU SUR L'ÉCONOMIE

Pour terminer, on voudrait formuler quelques remarques sur la vie économique dans le royaume de Mari à partir du cas ici étudié.²²

La première observation concerne les intérêts: étaient-ils annuels? Pendant longtemps, la réponse ne semblait pas faire de doute: les prêts étaient consentis avec un intérêt annuel de 20% sur l'argent et 33% sur le grain.²³ Deux auteurs ont repris l'examen du problème il y a une dizaine d'années et remis en cause le consensus. M. Van De Mierop a conclu que le chiffre indiqué sur les contrats ne correspondait pas à un intérêt annuel, mais à l'intérêt à verser au moment du remboursement, quelle que soit l'échéance;²⁴ il a souligné qu'un intérêt de 33% sur quelques mois, bien que considéré aujourd'hui comme usuraire, n'avait rien d'in vraisemblable à l'époque, s'agissant de prêts de nécessité. Au même moment, A. Skaist, à partir d'arguments différents, est parvenu à une conclusion semblable;²⁵ il a mis l'accent sur le fait que dans beaucoup de contrats, la date était incomplète: on a souvent l'année, mais rarement le mois et encore plus rarement le jour. Il lui paraît impossible dans ces conditions de calculer l'intérêt s'il est annuel. Plus récemment, P. Vargyas est revenu sur la question et, à partir de la documentation du premier millénaire, a conclu au contraire fermement en faveur d'un taux annuel.²⁶ On doit ici rappeler que la plupart des prêts d'argent de Mari mentionnent un intérêt de $\frac{1}{4}$ de sicle pour 10 sicles, soit 2 $\frac{1}{2}$ %, ce qui manifestement correspond à un intérêt mensuel, équivalant à un intérêt annuel de 30%;²⁷ dès lors, il paraît difficile d'admettre que les intérêts n'aient pas été au *pro rata temporis*.²⁸ Sinon, dans la mesure où la plupart des contrats ne stipulent pas d'intérêt moratoire ou de gage, les débiteurs n'auraient guère été enclins à rembourser à échéance.

Nos récapitulatifs ne peuvent malheureusement pas trancher le débat définitivement, dans la mesure où ils ne reproduisent que le montant du capital.²⁹ Néanmoins, ils ont une importance considérable, dans la mesure où ils permettent de constater l'existence de nombreux impayés. Dans la plupart des contrats rédigés à Mari, l'échéance est stipulée et elle se situe le plus souvent quelques mois après la conclusion du prêt. Cependant, on constate ici qu'au début de ZL 8, des créances remontant à l'année ZL 4 n'avaient toujours pas été remboursées, soit plus de trois ans plus tard. En ce qui concerne les particuliers, il s'agit de montants de grain relativement faibles: c'est sans doute le signe d'une situation économique précaire. On ajoutera qu'au début de son règne, Zimrî-Lîm proclama une *mîšarum*, qui comprenait l'annulation des dettes.³⁰ On ne sait si cette mesure fut réitérée plus tard dans son règne. En ce qui concerne les collectivités, il s'agit de montants beaucoup plus importants: le prêt de montants considérables de grain à des localités par des personnalités telles que Sammêtar et Inibšîna est un phénomène sur lequel il faudra revenir.

Notons enfin la façon dont le *šandabakkum* Yasîm-sûmû³¹ confia le recouvrement des créances à Šûbnaîû.³² Il lui remit une copie de la tablette M.15119+, qui semble avoir été faite sur deux tablettes scellées (l. 57): sans doute

²² Une étude plus complète figurera dans mon ouvrage *Nouveaux textes juridiques de Mari*, en préparation.

²³ L'étude classique est celle de W. F. Leemans, "The Rate of Interest in Old-Babylonian Times," *Revue internationale du droit de l'antiquité* 5 (1950): 7–34. Noter que le taux d'intérêt mentionné dans tous les textes ici étudiés, soit 40 *qa* par *kur*, est bien de 33 $\frac{1}{3}$ %, puisque le *kur* de Mari compte seulement 120 *qa* (au lieu de 300 en Babylonie), comme l'avait déjà indiqué Boyer, *Textes juridiques*, p. 205.

²⁴ Marc Van De Mierop, "Old Babylonian Interest Rates: Were They Annual?" dans *Immigration and Emigration within the Ancient Near East* (Festschrift E. Lipiński), édité par K. Van Lerberghe et A. Schoors, *Orientalia Lovaniensia Analecta* 65 (Leuven: Peeters, 1995), pp. 357–64.

²⁵ Aaron Skaist, *The Old Babylonian Loan Contract: Its History and Geography*, *Bar-Ilan Studies in Near Eastern Languages and Culture* (Ramat Gan: Bar-Ilan University Press, 1994), pp. 133–41 ("annual or per loan rate").

²⁶ Peter Vargyas, "Babylonian Interest Rates: Weren't They Annual?" dans *Studi sul Vicino Oriente dedicati alla memoria di Luigi Cagni*, édité par S. Graziani, *Istituto Universitario Orientale, Dipartimento di Studi Asiatici, Series Minor* 61 (Naples: Istituto Universitario Orientale, 2000), pp. 1095–1107.

²⁷ Boyer, *Textes juridiques*, p. 204.

²⁸ Skaist a tenu compte de ces contrats, mais il a conclu qu'il y avait à Mari deux types de prêts: ceux où l'intérêt est au *pro rata temporis*

et les autres, où l'intérêt est au prêt (*Old Babylonian Loan Contract*, pp. 136–37). Une telle dualité me paraît difficile à imaginer dans la pratique.

²⁹ Cf. l'explicite sag dans ARM 23 70:1 et ARM 8 56:1. Lorsqu'on a récapitulatif et créances originelles, comme pour AUCT 5 99, on peut le vérifier (cf. *supra* § 2.5.1).

³⁰ Charpin et Ziegler, *Mari et le Proche-Orient à l'époque amorrite*, p. 184 et n. 108. Pour l'annulation de prêts de grain à l'époque de Yasmah-Addu, voir ARM 4 16 (= LAPO 18 1049). Le contexte est une famine dans le Suhûm: Yasmah-Addu informe Samsî-Addu qu'il a décidé de prendre un décret (*šiptum*) par lequel il remet les prêts de grain, intérêt compris.

³¹ Pour les activités de ce personnage clé dans la gestion économique du royaume de Mari, voir Stefan Maul, "Zwischen Sparmaßnahme und Revolte ... Die Aktivitäten des Iasîm-Sîmû, des *šandabakkum* von Mari," *MARI* 8 (1997): 755–74 (et *NABU* 1997/77).

³² Pour le personnage de Šûbnaîû, intendant (*abu bitim*), voir en dernier lieu Brigitte Lion, "Les gouverneurs provinciaux du royaume de Mari à l'époque de Zimrî-Lîm," dans *Mari, Ébla et les Hourrites: dix ans de travaux. Actes du colloque international (Paris, mai 1993). Deuxième partie*, édité par D. Charpin et J.-M. Durand, *Amurru* 2 (Paris: Éditions Recherche sur les Civilisations, 2001), pp. 141–210 (pp. 187–88).

chaque tablette correspondait-elle à chacune des créancières. Il n'est pas sans intérêt de noter que ce sont les copies qui sont scellées; le sceau déroulé était vraisemblablement celui de Yasîm-sûmû,³³ qui investissait ainsi son subordonné de l'autorité nécessaire à sa mission de *mušaddinum*.³⁴ Le plus étonnant est de voir le recouvrement confié à un individu qui était lui-même débiteur de près d'un tiers du montant total des créances (cf. l. 51).

3. CONCLUSIONS

On peut donc désormais reconstituer le déroulement des opérations: l'inventaire du domaine d'Inibšina eut lieu le 8/xii/ZL 8 (ZL 7'). Dans ses archives, on retrouva des créances impayées. Certaines étaient au nom d'Addu-dûrî: Inibšina avait dû s'en retrouver propriétaire d'une façon ou d'une autre.³⁵ Dans la majorité, Inibšina figurait comme créancière. Certaines créances furent aussitôt confiées à Šûbnalû pour qu'il procède à leur recouvrement: ce sont celles qui ont des villes comme débiteur (ARM 23 70). Sans qu'on sache pourquoi, d'autres créances ne furent traitées que quelques semaines plus tard: celle de la ville de Šehrum (ARM 8 56) et celles de nombreux particuliers (M.15119+). La tablette récapitulative des 32 prêts consentis à des particuliers montre la façon dont le scribe procéda au classement des créances et nous révèle un aspect de l'activité intellectuelle sous-jacente à la tâche pratique qu'il devait accomplir.

4. ANNEXES

On trouvera ici la réédition de deux textes étroitement apparentés à celui qui a été édité ci-dessus et dont le commentaire figure notamment au § 2.5.2.

ARM 23 70

Récapitulatif de créances d'Inibšina. 8/xii/ZL 7 (= ZL 6'). Copie dans MARI 5, p. 511.

	22 a-gâr 9 gur 0,0.4 še ur ₅ -ra sag
2	máš ^{sis} 1 gur 0,0.4 àm ú-ša-ab še-eh-rum ^{ki}
4	29 a-gâr 2½ gur 0,0.2 še pa-al-la-an ^{ki}
6	6 a-gâr ti-iz-ra-ah ^{ki} 3 a-gâr di-im-ta-an ^{ki}
8	1 a-gâr na-še ₂₀ -er ^{ki} 3 a-gâr ap-pa-an ^{ki}
10	15 a-gâr 1 gur mi-iš-la-an ^{ki} 10 a-gâr 2½ gur ša-hu-šú-ra-tim ^{ki}
12	x+23 a-gâr ú-ra-ah ^{ki} [x] a-gâr gu-ru- ^d IM ^{ki[i]}
14	[x a-g]âr 5 gur 2 ^{sic} hi-da-a[n ^{ki}]
T.	(lacune de 2 [?] lignes)

³³ Dominique Charpin et Dominique Beyer, "Les sceaux de Yasîm-sûmû," MARI 6 (1990): 619–24.

³⁴ Voir les considérations de Fritz Rudolph Kraus sur l'expression *ana šuddunim nadânum* dans *Königliche Verfügungen in altbabylonischer Zeit*, *Studia et Documenta ad iura Orientis antiqui pertinentia* 11 (Leyde: Brill, 1984), pp. 197–98.

³⁵ Rappelons qu'Inibšina était une fille de Yahdun-Lîm, donc une cousine (ou une sœur?) de Zimrî-Lîm, alors qu'Addu-dûrî était la mère de ce dernier. N. Ziegler avait déjà émis l'hypothèse qu'Inibšina ait hérité d'une servante ayant précédemment appartenu à Addu-dûrî (*Le Harem de Zimrî-Lîm*, p. 48 n. 286 et p. 228 n° 51). Pour le lien étroit entre ces deux femmes, voir aussi p. 48 n. 289.

R.	[ša ha-la-aš]
16	ma-ri ^[ki]
	x+37 a-gàr še [...]
18	qa-aṭ-ṭù-na-an ^{ki}
<hr/>	
	ʿšū-nigin ₂ ¹ ʿ2 ⁷ me 94 a-gàr 4 ₂ ¹ [gur še]
20	[ur ₅]-ra sa[g]
	[má]š ^{giš} 1 gur 0,0.4 àm ú-[ša-ab]
22	[a-n]a pi-i ka-ni-ka-tim
	[...] še
24	[...] še-ì-giš
	[...] 2 a-gàr bu-rum
26	[ka-ni-ka]-tum
	[ša ^f]i-ni-ib-ši-na
28	[s]i-lá šu-ub-na-lu-ú
	gìr ia-si-im-su-mu-ú
T. ³⁰	iti e-bu-ri-im u ₄ 8-kam
	mu zi-im-ri-li-im
32	bàd ^{ki} -ia-ah-du-li-im
	i-pu-šu

26–27) F. van Koppen avait à juste titre remis en cause la restitution de l’*editio princeps*, mais sans pouvoir en proposer une plus convaincante (van Koppen, “Seized by Royal Order,” p. 326). Celle que j’ai retenue s’appuie sur le parallèle de M.15119+.

ARM 8 56

Créance de grain appartenant à Inibšina. 21/i/ZL 8 (= ZL 7’). Collations J.-M. Durand, MARI 1, p. 113 (copies p. 133).

	37 a-gàr še ur ₅ -ra sag
2	máš 1 gur 0,0.4 àm
	ú-ša-ab
4	[x lú]-meš še ₂₀ -eh-ra-yu ^{ki}
	[ki ^f]i-ni-ib-ši-na
6	[il-qú-ú]
T.	[a-na šu-ud-du]-nim
R. ⁸	[šu-ub-na-lu-ú] ma ¹ -hi-ʿir ¹
	gìr ia-si-im-su-mu-ú
10	iti ú-ra-hi-im
	u ₄ 21-kam
12	mu zi-im-ri-li-im
T.	alam-šu a-na ^d ha-aṭ-ṭá
14	ú-še-lu-ú

6) L’existence de cette ligne a été signalée par Jean-Marie Durand, “Relectures d’ARM VIII, I. Collations,” MARI 1, p. 113.

7–8) J’ai restitué ces deux lignes sur le modèle de M.15119+: 59–60 (la photo de la tranche latérale explique très bien l’éventuelle erreur de lecture de Boyer), mais une nouvelle collation de l’original serait nécessaire. J.-M. Durand avait indiqué pour la l. 8: “le dernier signe est IM non AH”; on pourrait éventuellement restituer la l. 8 [si-lá la]-e-em, mais on ne voit pas ailleurs Lâ’ûm mêlé aux inventaires réalisés sous la responsabilité de Yasîm-Sûmû.



Tablette M.15119+M.15287.

IDENTIFYING SUMERIAN COMPOUND NOUNS

Graham Cunningham, Oriental Institute, Oxford University

An ongoing problem in linguistics is specifying what might be a word, that innocuous-seeming unit in language. As one celebrated book on morphology puts it: “There have been many definitions of the word, and if any had been successful I would have given it long ago, instead of dodging the issue until now.”¹ A recent attempt to confront the issue proposes three criteria: that the elements in a word are inseparable, occur in a fixed order, and have a conventionalized meaning.² This specification solves many of the problems in identifying words that contain only a single base. However, it leaves some questions unanswered in relation to the identification of compounds, that is, instances in which two or more elements that can occur independently combine as a new word, and it is the problem of identifying such compound nouns in Sumerian that is the focus of this paper.³

WORDS

First, however, some background terminology needs a brief introduction. As is well known, the term “word” is ambiguous in at least two ways, sometimes being used to refer to an abstract unit and sometimes to a form in which this unit is realized. When it is necessary to avoid this ambiguity the term “lexeme” is used for the abstract unit and “word form” for its various realizations. In these terms the lexeme *go*, for example, has word forms such as “goes” and “went.” As this example indicates, because a lexeme is an abstract unit it has to be represented by a particular word form. Conventions vary across languages in terms of which representational word form is used: in relation to verbs, in English and Akkadian it is the infinitive, in Latin it is the present tense’s first-person singular, and in Sumerian it is the base. This representational word form is also referred to as a “citation form” and typically it is also the headword (or lemma) that is used in a dictionary entry.

A further term relevant to the identification of words is “clitic.” Definitions of what constitutes a clitic vary, although all agree that it is a type of bound morpheme. In the volume of articles from which the opening specification of a word comes, a clitic is sometimes referred to as a phonologically weak word⁴ and sometimes as intermediate between a word and an affix,⁵ the concluding article in the volume commenting: “Of the terms used in the preceding chapters, ‘clitic’ is the one that leaves me most confused.”⁶ Unsurprisingly, the identification of clitics is complex, the same volume devoting more than ten pages to the subject,⁷ in some cases relying on phonological criteria which

¹ P. H. Matthews, *Morphology*, 2nd edition (Cambridge: Cambridge University Press, 1991), p. 208.

² R. M. W. Dixon and Alexandra Y. Aikhenvald, “Word: A Typological Framework,” in *Word: A Cross-linguistic Typology*, edited by R. M. W. Dixon and Alexandra Y. Aikhenvald (Cambridge: Cambridge University Press, 2002), p. 19. These criteria are modified by various caveats. A qualification advanced in relation to the second criterion is particularly relevant to the analysis of the Sumerian imperative in which the same morphemes follow the base which otherwise precede it: that affixes can occur in an alternative order within a word provided that this results in a consistent change of meaning (Dixon and Aikhenvald, “Word,” p. 20).

³ Recent analyses of Sumerian compound nouns include Jeremy Black, “Sumerian Lexical Categories,” *Zeitschrift für Assyriologie* 92 (2002): 70; and Manfred Schretter, “Zu den Nominalkomposita des Sumerischen,” in *Studi sul Vicino Oriente antico dedicati alla*

memoria di Luigi Cagni, edited by Simonetta Graziani (Naples: Istituto Universitario Orientale, 2000), pp. 933–52. The paper given at the conference partly discussed how to use the Electronic Text Corpus of Sumerian Literature (ETCSL; Web site: <http://etcsl.orinst.ox.ac.uk/>) and partly the problem of identifying compound nouns; the first part is reduced in this written version and the second expanded. The discussion is not intended to be exhaustive but only indicative, both of Sumerian compound-noun types and of the problems in identifying compounds.

⁴ Dixon and Aikhenvald, “Word,” p. 25.

⁵ Alexandra Y. Aikhenvald, “Typological Parameters for the Study of Clitics, with Special Reference to Tariana,” in Dixon and Aikhenvald, *Word*, p. 43.

⁶ P. H. Matthews, “What Can We Conclude?” in Dixon and Aikhenvald, *Word*, p. 275.

⁷ Aikhenvald, “Typological Parameters,” pp. 43–57.

are unavailable for the analysis of Sumerian. A particular terminological disagreement relates to bound morphemes which occur at the end of a head-initial noun phrase, as is the case in Sumerian. While some linguists refer to these morphemes as clitics, the convention followed in this paper, others call them instead “phrasal affixes.”

To return more specifically to the subject of the word, three different types can be identified: grammatical, phonological, and orthographic words. A grammatical word matches the definition proposed at the beginning of this article and is the realization of a lexeme. In languages with complex morphology in a range of word classes, such words are inflected; in Sumerian, however, inflectional affixes are restricted to verbs.

In many cases a grammatical word corresponds to a phonological word. However, a phonological word can consist of more than a grammatical word, with such instances typically involving a clitic, an example being “I’m” in which “’m” is a clitic. An earlier convention in transliterating Sumerian was to hyphenate throughout the noun phrase. However, a more recent convention is to link with hyphens only signs regarded as constituting a grammatical word, or in the case of sequences including clitics, a phonological word. Those morphemes generally regarded as clitics are the phrasal demonstratives, possessives, plural marker, and case markers, as well as the phonologically dependent forms of the copular verb.⁸

Finally, there is the orthographic word. These are words which are separated from each other with a space when they are written. In many cases an orthographic word again corresponds to a grammatical word. However, some constitute part of a grammatical word, English providing many examples of compound nouns—single grammatical words—that are written as more than one orthographic word, such as “living room.” Different languages have different conventions for writing compound nouns: English is notoriously flexible (“flowerpot,” “flower-pot,” and “flower pot” all being acceptable); German much more consistently favors a single orthographic word; and Sumerian has no orthographic words at all, the space between two signs being no different than the space between two words.

This lack of distinct spaces between words in the writing of Sumerian raises a problem for distinguishing compound nouns from phrasal sequences of independent words. It also raises the question of whether such compounds should be linked by a hyphen in transliteration. Throughout this paper, what are regarded as compound nouns are hyphenated. However, given the problems in identifying such compounds securely, it could be argued that more minimal hyphenation would be preferable.

COMPOUND-NOUN TYPES

The three most common types of compound noun attested cross-linguistically can be referred to as endocentric, exocentric, and coordinate compounds.⁹ In the endocentric type (such as “living room”), the head of the compound (“room”), its semantic center, occurs inside (“endo-”) the compound, either before or after a dependent which restricts the meaning of the head (before in the case of “living room,” which is a type of room in some way associated with being lived in). In the exocentric type, the head is only implicit and can thus be regarded as outside (“exo-”) the compound (such as “killjoy,” indicating someone—the implicit head—who kills joy). In the coordinate type, each element is a noun of equal semantic status, as in “washer-dryer,” a unit that includes both a washer and a dryer, or in instances in other languages in which, for example, father + mother expresses “parents.” Compounds such as “washer-dryer” are sometimes termed appositional, indicating that they denote entities which consist of two equal parts. Instances of the “parents” type are termed aggregative, denoting an entity which is the sum of its parts. The

⁸ In most instances this hyphenation convention has been followed in the ETCSL. However, as the following discussion indicates, many of the sequences currently linked by hyphens within the corpus may be better regarded as lexicalized phrases than as compounds. In addition, a few instances of what can be regarded as clitics, given that they are monosyllabic function morphemes and thus prototypical candidates for cliticization, have not been preceded by a hyphen within the corpus and can consequently be searched for as lemmata: some demonstratives (**ne**, **re**, and **še**) and **nu**, arguably the negative cliticized form of the third person copular verb; see Pascal Attinger, *Éléments de linguistique sumérienne: La construction de du₁₁/e/di “dire,” Orbis*

Biblicus et Orientalis Sonderband (Freibourg: Éditions Universitaires; Göttingen: Vandenhoeck & Ruprecht, 1993), p. 312. The demonstrative **ne** occurs both as an independent pronoun at the head of the noun phrase and as a dependent clitic. In the analysis of other languages the term “determiner” is used for the dependent occurrences of such morphemes as demonstratives. This convention has been followed in the ETCSL.

⁹ Nigel Fabb, “Compounding,” in *The Handbook of Morphology*, edited by Andrew Spencer and Arnold M. Zwicky (Oxford: Blackwell Publishers, 1998), pp. 66–68.

distinction between the two can, however, be difficult to make.¹⁰ Endocentric compounds are very common in English, exocentric and coordinate compounds occurring much less frequently.

COORDINATE COMPOUNDS

Identifying coordinate compounds in Sumerian is particularly difficult because the language so rarely makes use of an explicit coordinator which would distinguish a phrasal sequence from such a compound. However, candidates of the aggregative type can be proposed partly on the basis of their translations, into Akkadian as well as English, and partly because similar compounds occur in other languages; examples are **maš₂-anše** “animals” (“goat” + “donkey”; Akkadian *būlu*) and **a₂-šu-ġiri₃** “limbs” (“arm” + “hand” + “foot”; Akkadian *mešrêtu*).

ENDOCENTRIC COMPOUNDS

Endocentric compounds appear to be common in Sumerian. These can be subcategorized in terms of the dependent’s word class and its position in relation to the head, a head-initial compound being called left-headed and a head-final compound right-headed. The structure of the Sumerian noun phrase provides the strongest evidence for one type of endocentric compound, those in which the dependent belongs to the word class of nouns. If it is accepted that within the phrase a Sumerian noun can be modified only by such independent constituents as an adjective, participle, or possessor noun phrase, and not by an independent noun, then a sequence of noun followed by noun must constitute an endocentric compound, unless the two form a coordinate compound or their relationship is one of coordination (as in **an ki** “heaven and earth”) or of apposition (such instances often involving a proper noun, as in **šul-gi lugal** “Šulgi, the king” or **en nin-ġir₂-su** “Lord Nin-Ġirsu”).¹¹

Endocentric compounds in English are right-headed and it is apparently rare for a language to have both left-headed and right-headed types.¹² Sumerian, however, has both types, although right-headed instances occur much less frequently; examples include **an-edin** “high plains” and **kur-šag₄** “mountain center.” Other Sumerian endocentric compounds match the structure of the language’s noun phrase and are consequently left-headed, the dependent following the head and being either a common noun, as in **dumu-saġ** “first-born child” and **e₂-muġaldim** “cookhouse,” or a verbal noun, formed from an intransitive verb as in **ki-tuš** “dwelling place” or a transitive verb as in **anaġ** “drinking water.”¹³ As is indicated by phonographic writings such as **ku-tu-uš** for logographic **ki-tuš**,¹⁴ at least

¹⁰ Laurie Bauer, “Compounding,” in *Language Typology and Language Universals: An International Handbook*, edited by Martin Haspelmath et al., Handbücher zur Sprach- und Kommunikationswissenschaft 20 (Berlin: Walter de Gruyter, 2001), vol. 1, pp. 699–700. For a more detailed discussion of coordinate compounds, see Susan Olsen, “Copulative Compounds: A Closer Look at the Interface between Syntax and Morphology,” in *Yearbook of Morphology 2000*, edited by Geert Booij and Jaap van Marle (Dordrecht: Kluwer Academic Publishers, 2001), pp. 279–320.

¹¹ This description may, however, require further research. Some linguists argue that in English, for example, a noun can modify a noun without necessarily forming a compound; see, for example, Rodney Huddleston and Geoffrey K. Pullum, *The Cambridge Grammar of the English Language* (Cambridge: Cambridge University Press, 2002), pp. 448–51; for an overview of the debate, see Laurie Bauer, “When is a Sequence of Two Nouns a Compound in English?” *English Language and Linguistics* 2 (1998): 65–86. In support of this analysis it is argued that instances such as “cooking apple” are not compounds because the first element can occur in coordination with another, as in “cooking and eating apples.” However, alternative analyses are available: that this is an instance of coordination ellipsis (indicated in German with a hyphen, as in “Koch- und Essäpfel”) or that the depen-

dent element in a compound (“cooking and eating”) can be phrasal in origin.

¹² Fabb, “Compounding,” p. 67.

¹³ Because the term “verbal noun” is rarely used in the analysis of Sumerian it may merit a brief discussion. Different languages have different, often morphologically matching, types of non-finite verb. English can be analyzed as having three types: participle (or verbal adjective), gerund (or verbal noun), and infinitive. Sumerian can be analyzed as having one type which can function either as a participle or as a gerund, with the latter incorporating the functions of the infinitive. Participles and gerunds are intermediate between adjectives and nouns on the one hand and finite verbs on the other, behaving in some ways like an adjective or noun but retaining such characteristics of the finite verb as, for example, being able to take an object and inflecting for tense and/or aspect. For a more detailed discussion, see Gábor Zólyomi, “Sumerisch,” in *Sprachen des alten Orients*, edited by Michael P. Streck (Darmstadt: Wissenschaftliche Buchgesellschaft, 2005), pp. 36–38.

¹⁴ A letter from Šulgi to Puzur-Šulgi, edited as line 9 (ms. C) in the print edition (Piotr Michalowski, “The Royal Correspondence of Ur” [Ph.D. diss., Yale University, 1976], p. 191) and as line 7 (Version B) in the electronic edition (ETCSL 3.1.08).

some Sumerian compounds underwent phonological changes, in this instance vowel assimilation, which are obscured in logographic writings (and thus in transliteration). A few compounds in which the dependent is a common noun, such as **amaš** “pen” (< **e**₂ “house” + **maš**₂ “goat”), are written with a single sign, reinforcing their analysis as a single word.

As the preceding examples indicate, the exact semantic relation between the elements in a compound has no formal expression, that is, the grammatical relation between the elements is dissolved and the meaning is consequently a matter of interpretation, **e**₂-**muḥaldim** then being an area used by a cook while **ki-tuš** is something like “place (for) living in” in the same way as “living room” is “room (for) living in.”

While endocentric compounds in which the dependent is a noun can thus be identified with some degree of confidence in Sumerian, uncertainties arise when a possible dependent cannot be classified securely as a noun. For example, the sequence **a-a ugu** “begetting father” can be analyzed as phrasal on the basis of the occasional Akkadian translations of **ugu** with the participle *wālidu* “begetter.” However, given the absence of instances of **ugu** with this meaning outside such contexts, and the frequency of the noun **ugu** “skull,” it might be analyzed instead as a compound with the literal meaning “skull-father.”

Before discussing other types of endocentric compound in which the dependent belongs to a different word class than the noun, a further term needs to be introduced: lexicalized phrases. These are multiword expressions, lexicalized in so far as they have a specialized meaning but phrasal in so far as no formal grounds can be advanced for analyzing them as compounds. One consequence of the existence of such phrases is that semantic specialization cannot be regarded as a sufficient criterion for identifying a compound. English, for example, has many lexicalized phrases consisting of an adjective and a noun, such as “gold medal” which, at least on phonological and syntactic grounds, cannot be classified as a compound: “medal” has main stress (in contrast with the compound “goldfish” in which it occurs on “gold”); and “medal” can be substituted in clauses such as “She has two silver medals and two gold ones” (contrast the unacceptable clause “Her house has two dining rooms and two living ones”). Lexicographers, however, tend to be more generous than linguists, entering phrases like “gold medal” in dictionaries as nouns (although in contrast, semantically transparent endocentric compounds in which the dependent is a noun, such as “bottle factory,” rarely have a separate entry).

As the example of “goldfish” indicates, phonology and orthography provide guides to identifying endocentric compounds in English in which the dependent is an adjective, the same being the case in such contrasts as “greenhouse” versus “green house.” This information is, however, unavailable for Sumerian. In other languages morphology contributes to the distinction between compounds and lexicalized phrases. In Dutch, for example, “zuurkool” “sauerkraut” is a compound while “rode kool” “red cabbage” is a lexicalized phrase in which the adjective is inflected in agreement with the noun. However, as such inflectional agreement does not occur in Sumerian, morphology is again a diagnostic criterion which cannot be applied to that language.

A further method of identifying compounds relates to loanwords. As it is typically words which one language borrows from another, compound loans can be used to identify compounds in the source language.¹⁵ There are, however, two important limitations to this method. The first is that it only identifies instances rather than principles which can be applied more generally. The second is that as well as borrowing words, languages also borrow lexicalized phrases (such as “chargé d’affaires,” a loan in English from French).¹⁶ A further reservation relates more specifically to Sumerian loans in Akkadian: identifying their status in Akkadian is itself not always straightforward and the textual evidence can be difficult to interpret, in particular if an expression has only a lexical and not a discourse context.

With such reservations kept in mind, Sumerian can be argued to have left-headed endocentric compounds in which the dependent is an adjective, as in **bur-zid** “offering bowl” (Akkadian *pursītu*) and **šum**₂-**sikil** “white onion” (Akkadian *šamaškillu*). Instances also occur in which a contrast can be proposed between such a compound and a phrasal sequence, as in **ki-sikil** “young woman” versus **ki sikil** “pure place.” Further support for the existence of such compounds comes from the writing of **lugal** “king” (< **lu**₂ “person” + **gal** “big”) with a single sign, or more accurately a ligature (GAL+LU₂). By extension, other early-attested professional designations in which **gal** is written before the noun may also be compounds, such as **gal-nar** “chief musician”; assuming that, at least in some stage of the language, the spoken sequence matched the written sequence, these would be compounds of the right-headed type otherwise rare in Sumerian.

¹⁵ Brian D. Joseph, “The Word in Modern Greek,” in Dixon and Aikhenvald, *Word*, p. 261.

¹⁶ For a defense of this analysis, see the later discussion of possessive constructions.

On the basis of loanwords in Akkadian, Sumerian can also be argued to have left-headed endocentric compounds in which the dependent is a participle, as in **gala-us₂-sa** “junior lamentation priest” (Akkadian *galaussû*) and **di-til-la** “final judgment” (Akkadian *ditillû*).¹⁷ In the first example the participle is formed from an intransitive stative verb and the crude English equivalent would be a participle in progressive aspect (“a being-adjacent lamentation priest”). More often, however, as in the second example, the participle is formed from a transitive dynamic verb and is used in this context to express a state which is the result of a completed action, a concept expressed in English instead with a perfect participle (“a finished judgment”). Again instances occur in which a contrast can be proposed between such a compound and a phrasal sequence, as in **ki-gul-la** “destitute woman” (Akkadian *kigullatu*) versus **ki gul-la** “destroyed place.”

Up to this point only endocentric compounds in which the head is a common noun have been considered; in these, the relationship between the head and its dependent can be described as being between modifiee and modifier. However, loanwords in Akkadian provide occasional support for the existence of a different type of endocentric compound, ones in which the head is a verbal noun, as in **šul-luḥ** “hand-washing (ritual)” (Akkadian *šuluhḥu*). Having a verbal noun as head has two consequences: reflecting the verb-final nature of Sumerian, such compounds are again right-headed (**šul-luḥ** being a particular type of washing) and, reflecting the verbal nature of the head, its relationship with its dependent can be described as being between complement and predicate, indicating that the dependent can be analyzed as the notional object (complement) of the verb (predicate).

EXOCENTRIC COMPOUNDS

Exocentric compound nouns, that is, compounds with only an implicit head, are the third principal type of compound. Partly because they are common in other languages (albeit not in English), it can be argued that they also occur in Sumerian. They can be subcategorized into two types: on the one hand, agent and instrument nouns (such as “pickpocket,” someone who picks pockets, and French “grille-pain” “toaster,” something that toasts bread); on the other hand, nouns denoting a kind of possession (such as “redhead,” someone who has red hair). The latter are also referred to as bahuvrihi compounds, a term taken from Sanskrit grammar. The relationship between the elements in the two types is different. The elements in agent and instrument nouns can be analyzed as verbs and notional objects, the relationship again therefore being between predicate and complement. However, possessive compounds consist of an adjective and a noun, thus being further examples of a relationship between modifier and modifiee.

In Sumerian the elements occur in the reverse order: **dub-sar** “scribe” (“(someone habitually) writing tablets,” Akkadian *tupšarru*) being an agent noun, **gana₂-ur₃** “harrow” (“(something habitually) dragging fields”) an instrument noun, and **saḡ-gig₂** “blackhead, i.e., black-haired person” (“(someone having a) black head”) a possessive noun. Instances of agent nouns written with a single sign are also attested, such as **zadim** “lapidary” (< **za** “stone” + **dim₂** “to fashion”). Loanwords in Akkadian suggest that more complex agent nouns could be formed by adding an adjective to an exocentric compound, as in **dub-sar-maḥ** “chief scribe” (Akkadian *dubsarmahḥu*).

In these agent and instrument nouns, the verbal element can be analyzed as a participle with a zero suffix, although whether this suffix marks a distinction of tense and/or aspect remains uncertain; it primarily appears to have present-tense reference, but possibly the frequency with which it occurs in such compounds indicates that it also has habitual, and thus aspectual, connotations. It contrasts on the one hand with the suffix {a}, encoding past tense and/or completive aspect, and on the other with the suffix {ed}, encoding non-past (present and future) tense and/or incompletive aspect.

In other terms for professions the verbal element is one of the two most frequent verbs in Sumerian: **ak** “to do” or the irregular verb **dug₄** “to say, do.” In these instances the verbal form is instead non-past/incompletive, examples being **kar-ke₄** “prostitute” (“(someone) doing quays”; analyzing **ke₄** as **ak** + {ed}) and **u₆-di** “a type of priest”

¹⁷ In this context it should be admitted that the distinction conventionally made between Sumerian adjectives and participles remains somewhat fragile, in particular after the third millennium. Both specify the properties of a noun, adjectives being necessarily stative and intransitive while participles can be either stative or dynamic and either in-

transitive or transitive. The distinction made in this paper between the two relies partly on the morphological contrast between an adjective such as **gal** “big” and a participle formed from an intransitive stative verb, such as **sag₉-ga** “beautiful” (Attinger, *Éléments*, pp. 167–68). For an alternative analysis, see Zólyomi, “Sumerisch,” pp. 22–23.

(“(someone) saying ah,” Akkadian *uṭṭû*; **di** being the non-past/incompletive base of **dug₄** in non-finite forms). Again, an adjective can be added to create a new compound, as in **u₆-di-gal** “a senior type of priest” (Akkadian *udigallu*).

OTHER COMPLEX NOUNS

So far only complex nouns consisting of content morphemes have been discussed, that is, complex nouns formed from words with a highly identifiable meaning (nouns, adjectives, and verbs) as distinct from ones which include a function morpheme (a term which includes both clitics and the remaining word classes). Sumerian can also be argued to have complex nouns which include function morphemes, although such nouns may be better regarded as individual instances of univerbation (becoming-one-word) rather than as products of the more structural process of compounding.¹⁸

For example, on the basis that the Sumerian noun phrase is restricted to only one demonstrative or possessive clitic, instances such as **bal-a-re-ni-še₃** “towards her far side”¹⁹ suggest that the demonstrative **re** has been reanalyzed as part of a complex noun **bal-a-re** “opposite side.” Similarly, given that the genitive cannot be preceded by another case marker, instances such as **munus ud-bi-ta-ke₄-ne** “women of the past”²⁰ (“women of from-those-days”) indicate that **ud-bi-ta** also constitutes a complex noun.

Further complex nouns in other languages consist of two content morphemes as well as at least one function morpheme. In English, for example, “jack-in-the-box” can be analyzed as a noun on the basis that its plural is “jack-in-the-boxes,” taking word-final plural marking as a sufficient identifier of word status in that language. In contrast, and ignoring the hyphenation convention, “mother-in-law,” for example, can be analyzed as a lexicalized phrase because its plural is “mothers-in-law.” The restricted use of the Sumerian plural marker excludes it from being diagnostic, although other—but limited and tentative—criteria for identifying similarly complex nouns in Sumerian can be proposed. An internal criterion is provided by phonographic writings such as **ma-ar-gi₈** for logographic **ama-ar-gi₄** “freedom” (“returning-to-mother”) which may indicate a change in stress consequent upon a change from phrasal to word status.²¹ And external support for the existence of such complex nouns comes from occasional loanwords in Akkadian, such as **šag₄-ga-du₃** “a type of garment” (“binding-on-belly,” Akkadian *šakattû*).

POSSESSIVE CONSTRUCTIONS

More frequently, however, a morpheme such as a preposition or case marker indicates phrasal rather than compound status because it formally specifies the relationship between the words it accompanies.²² Consequently, instances like “chargé d’affaires” can be analyzed as lexicalized phrases, although lexicographers are again more generous than linguists, tending to list such phrases as nouns in dictionaries. Because possessive constructions like English “women’s liberation” and Sumerian **lu₂ inim-ma** “witness” (“man of words”) also include a morpheme specifying the relationship between the words they accompany, they too can be analyzed as phrases. However, there are idiomatic instances in English in which a phonological change suggests that some possessive constructions have a status closer to that of a compound noun (for example, “cat’s-paw” with the meaning “dupe” has main stress on

¹⁸ See Geert Booij, *The Grammar of Words* (Oxford: Oxford University Press, 2005), pp. 19–20, for a more detailed discussion of univerbation; for compound nouns, see *ibid.*, pp. 75–95 and 185–190.

¹⁹ Samsu-iluna A, edited as line 29 (ms. B) in the print edition in J. J. A. van Dijk, “Inanna, le bon augure de Samsu’iluna,” in *Wisdom, Gods and Literature: Studies in Assyriology in Honour of W. G. Lambert*, edited by A. R. George and I. L. Finkel (Winona Lake: Eisenbrauns, 2000), p. 122, and as line 5 in the electronic edition in ETCSL 2.8.3.1; the print edition currently supersedes the electronic edition.

²⁰ Iri-inim-gena 6 iii 20’, edited by Horst Steible, *Die Altsumerischen Bau- und Weihinschriften*, Freiburger altorientalische Studien 5 (Wiesbaden: Franz Steiner, 1982), part 1, p. 318.

²¹ I owe this suggestion to an unpublished grammar of Sumerian by Bram Jagersma. For the phonographic writing **ma-ar-gi₈**, see PSD s.v. **ama-ar-gi₄**.

²² Bauer, “Compounding,” pp. 704–05.

its first element in the same way as “gold” has in “goldfish”). Similar borderline cases may also have occurred in Sumerian, and loans are attested in Akkadian such as *zgmukku* “new year” (from **zag-mu**, locative **zag-mu-ka** “at the boundary of the year”). However, identifying such cases remains problematic in view of our uncertainties about Sumerian phonology and the difficulties in establishing the lexical status of some loans in Akkadian.

CONCLUSION

The preceding discussion (summarized in table 1, below) may be regarded as unduly tentative. However, a recent comparative study of the differences between compound nouns and lexicalized phrases concludes by conceding that “we will probably have to live with some indeterminacy.”²³ Such indeterminacy is likely to be much greater in the case of Sumerian given the problems in analyzing a language whose spoken stress-patterns are uncertain and whose writing uses no distinct spaces between words.

²³ Martin Haspelmath, *Understanding Morphology* (Leiden: Arnold, 2002), p. 161, and see pp. 85–93 and 154–61 for a more general discussion of compound nouns.

Table 1. Principal Types of Sumerian Compound Noun

<i>Type</i>	<i>Elements</i>	<i>Relationship</i>	<i>Example</i>
<i>Endocentric</i>			
Left-headed	Common noun + common noun	Modifiee-modifier	dumu-saĝ “first-born child” (“child” + “head”)
Left-headed	Common noun + verbal noun	Modifiee-modifier	ki-tuš “dwelling place” (“place” + “dwell”)
Left-headed	Common noun + adjective	Modifiee-modifier	šum₂-siki “white onion” (“onion” + “pure”)
Left-headed	Common noun + participle	Modifiee-modifier	di-til-la “final judgment” (“case” + “complete”)
Right-headed	Common noun + common noun	Modifier-modifiee	an-edin “high plains” (“heaven” + “open country”)
Right-headed	Adjective + common noun	Modifier-modifiee	gal-nar “chief musician” (“big” + “musician”)
Right-headed	Common noun + verbal noun	Complement-predicate	šu-luĥ “hand-washing (ritual)” (“hand” + “wash”)
<i>Exocentric</i>			
Agent noun	Common noun + participle	Complement-predicate	dub-sar “scribe” ((someone who) “tablet” + “write”)
Agent noun	Common noun + participle + adjective	Complement-predicate-modifier	dub-sar-maĥ “chief scribe” ((someone who) “tablet” + “write” + “great”)
Instrument noun	Common noun + participle	Complement-predicate	^{ĝi} š-gana₂-ur₃ “harrow” ((something which) “field” + “drag”)
Possessive noun	Common noun + adjective	Modifiee-modifier	saĝ-gig₂ “blackhead, i.e., black-haired person” ((someone who has) “head” + “black”)
<i>Coordinate</i>			
Aggregative	Common noun + common noun(s)	Equal	maš₂-anše “animals” (“goat” + “donkey”)

BABYLON AS A NAME FOR OTHER CITIES INCLUDING NINEVEH

Stephanie Dalley, University of Oxford

The use of stereotypical imagery drawn from the genre of lamentation makes it impossible to distinguish the capture of one great city from the capture of another, apart from the name of the city itself. Huddlestun has shown this to be the case for Egyptian Thebes, likewise for the fall of Nineveh in ca. 612 B.C. and the capture of Babylon by Sennacherib in 689 B.C.¹ The lack of distinction in describing such events led to confusion in Hebrew and Greek sources. This confusion is only a contributory factor. There is quite a range of different types of evidence indicating that “Babylon” was the name given deliberately to other cities in Babylonia by the end of the second millennium B.C. This paper describes the evidence and then shows reasons for extending the model to Assyrian royal cities.²

We begin with the lexical text Antagal, which gives the information that **Borsippa** was “Babylon the Second,” “another Babylon.”³ Copies of this text were found in the library of Assurbanipal at Nineveh, and so the information it contains is no later than the seventh century B.C. Various other pieces of information, some of them datable, support that evidence. A hymn to Marduk, datable to some time before 1068 B.C., calls him “Lord of Esagila, the hope of Babylon, the lover of Ezida, preserver of living things, leader of Emahtila, renewer of life.”⁴ In these lines, as in similar poems, the two great temples of Borsippa, namely Ezida and Emahtila, are treated as if they were a part of Babylon alongside Esagila, as the editor of that hymn, Tzvi Abusch, has shown in some detail.⁵ The fact that Hammurabi consecrated Ezida to the god of Babylon suggests that the equation of Borsippa with Babylon was made as early as the nineteenth/eighteenth century B.C.⁶

Another city whose name became interchangeable with Babylon was **Eridu**. The lexical list Erimhuš V 26 and the topographical list TIN.TIR^{ki} I 21 and V 90–91 show that Eridu was a name for Babylon proper. A version of the Sumerian King List gives Eridu as the first city ever to receive kingship from heaven, where the first king was Alulim. This man was called Aloros in the text attributed to Berossus, who wrote in the fourth century B.C., but Berossus named the city ruled by Aloros as Babylon, not Eridu. Eridu is the city in which Hammurabi king of Babylon was crowned, and this may be a reason to date the phenomenon early in the Old Babylonian period.⁷ These items may be related to the myth known as the Eridu Genesis, in which Eridu and Babylon refer to the same primeval city;⁸ it is not likely, therefore, to be an invention by Berossus or his transmitters. According to TIN.TIR^{ki}, Eridu was the name for the religious quarter of Babylon; the text dates from perhaps the time of Nebuchadnezzar I and may have earlier antecedents. The text gives an equation of the kind characteristic of lexical texts: “Eridu = Babylon the pleasant city,” in I 21.⁹ Other texts, in which Eridu is written but the city Babylon is often supposed to

¹ J. R. Huddlestun, “Nahum, Nineveh, and the Nile: The Description of Thebes in Nahum 3:8–9,” *Journal of Near Eastern Studies* 62 (2003): 97–110.

² A first version of this paper was delivered in Sheffield, and a third in Leiden. The writer would like to thank D. Edelman in Sheffield, the organizers of the RAI in Chicago, M. de Jong, and A. van der Kooij in Leiden, for warm encouragement and hospitality.

³ CT 19 25:25; see E. Unger, *Reallexikon der Assyriologie* 1 (Berlin and Leipzig: Walter de Gruyter, 1932), s.v. Barsipa; A. Cavigneaux in M. Civil, *Materials for the Sumerian Lexicon Supplementary Series* 1 (Rome: Pontificium Institutum Biblicum, 1985), p. 240, N 25 bād. si.a.ab.ba^{ki} = tin.tir min.kám^{ki}.

⁴ T. Abusch, “The Form and Meaning of a Babylonian Prayer to Marduk,” *Journal of the American Oriental Society* 103 (1983): 3–15.

He puts the date of composition “sometime before the reign of Adad-apla-iddina,” i.e., before 1068 B.C.

⁵ Abusch, “The Form and Meaning,” n. 16.

⁶ D. Frayne, *Royal Inscriptions of Mesopotamia, Early Periods* 4, *Old Babylonian Period* (Toronto: University of Toronto Press, 1990), p. 355, ll. 27–33, in which Hammurabi built Ezida in Borsippa for Marduk. A. R. George, *Babylonian Topographical Texts* (Leuven: Peeters, 1992), No. 14, gives the measurements of Esagila and Ezida on the same tablet, which may represent the same phenomenon.

⁷ J. van Dijk, “L’Hymne à Marduk avec intercession pour le roi Abī-ešuh,” *Mitteilungen des Instituts für Orientforschung* 12 (1966): 57–74 (TCL 16 61).

⁸ George, *Topographical Texts*, p. 252, quoting CT 13 35:12–14.

⁹ See also TIN.TIR^{ki} V 90–91, and discussion George, *Topographical Texts*, pp. 251–52.

be meant,¹⁰ date to the mid-second millennium B.C. — the reigns of Gulkišar¹¹ and Nebuchadnezzar I (and perhaps others). In the Neo-Babylonian period the king of Babylon occasionally called himself LUGAL NUN^{ki}, meaning king of Eridu (in Babylon).¹² An Achaemenid reference to a governor of Babylon as LÚ *paha(t)* NUN^{ki}, literally “governor of Eridu,” in the reign of Darius shows that the tradition survived beyond lexical texts and scholarly circles into an administrative term current in the Persian period.¹³

Another version of the Sumerian King List gives **Ku’ara** as the name of the first city.¹⁴ Ku’ara, known later as Kumar, is also the name for a quarter of Babylon, known from the topographical list TIN.TIR^{ki}. A gloss *tu-ba* for the city name Ku’ara, written logographically as A.HA^{ki},¹⁵ suggests that Tuba is a name for Ku’ara (note that the districts Tuba and Ku’ara are marked as adjacent on sketch maps showing the area names within Babylon). Ku’ara’s city-god, Asarluhi, is well known as a name taken by Marduk in Babylon; and at least one shrine of Asarluhi was located within Esagila. This is Ku’ara-in-Babylon.

If the naming of a city as the first recipient of kingship is enough to qualify it as a “Babylon,” we may include **Kish** alongside Eridu and Ku’ara, from the recently published version of the Sumerian King List which differs from other versions of that list in giving the first dynasty as based in Kish.¹⁶ This reminds us of the Epic of Etana, which opens with the building of the city Kish by the gods and their search for a king to rule over its people.

It is possible that the emphatic expression of Nebuchadnezzar saying that he built his palace “in the land of Babylon which is within Babylon” *ina eršet KÁ.DINGIR.RA ša qereb Babili*, implies that he was distinguishing the original Babylon from its metonyms, e.g., Borsippa and Eridu, by comparison with the expression “the land of Kumar which is within Babylon” *eršet kumari ša qereb Babilum*.¹⁷

Eridu and Ku’ara/Kumar, then, are names both for individual early cities and names for parts of Babylon. In the case of Eridu it is known for certain that Babylon was meant when Eridu was named in a particular context, both in the mid-second millennium and in the Neo-Babylonian period.

Similar to Eridu and Ku’ara is **Kullab** as the name for a quarter of Babylon. Kullab is the name for a part of Uruk, city of Gilgamesh in southern Mesopotamia. The cult of the gods of Uruk was carried out in Babylon proper; this is known from a ritual text.¹⁸

The early city Tentir near Umma may have given rise to the writing TIN.TIR for Babylon. If so, the tradition of old cities giving their name to Babylon goes back to the Old Babylonian period, when that logogram was occasionally used.

With these four cities, Borsippa, Eridu, Ku’ara (Tuba), and Kullab, all incorporated as parts of Babylon, and one of them explicitly called “Babylon the Second,” the most ancient and prestigious cities of lower Mesopotamia became “Babylons.” Kish and Tentir may also belong in this category. The tradition began before the late second millennium, when individual, dated contracts refer to those quarters of the city by name, and very likely existed in the reign of Hammurabi, the intervening Kassite period providing evidence from intermittent titles and epithets.

We can identify from these various examples the possible hallmarks for recognizing whether or not a city has been assimilated as a Babylon: the original city itself may be known as a Babylon (Eridu); it may give its name to a quarter of Babylon proper (Eridu, Kullab, Ku’ara); and Babylon proper may contain a temple of the incorporated city’s patron god where rites specific to the original city are performed (Kullab and Borsippa); and the city may be a place where kingship was first received from heaven (Eridu, Ku’ara, Kish) according to different versions of the Sumerian King List.

These namings may be reflected in the declaration made by Marduk in the Babylonian Epic of Creation VI. When Babylon had been built by the gods as the first city, Bel invited the gods to a banquet there and proclaimed: “Indeed, Babylon is your home too!” Then the decrees, designs, and destinies were fixed for the world.

¹⁰ References given by R. Zadok, *Répertoire géographique des textes cunéiformes* 8 (Wiesbaden: Ludwig Reichert, 1985), p. 52.

¹¹ C. J. Gadd, “A Middle-Babylonian Chemical Text,” *Iraq* 3 (1936): 87 ff.; see A. Leo Oppenheim et al., *Glass and Glassmaking in Ancient Mesopotamia* (Corning: Corning Museum of Glass, 1970), p. 63:41; and see George, *Topographical Texts*, p. 251.

¹² Zadok, *Répertoire* 8, p. 56.

¹³ H. G. Stigers, “Neo-and Late Babylonian Documents from the John Frederick Lewis Collection,” *Journal of Cuneiform Studies* 28 (1976): 36, 22:7, with Zadok, *Répertoire* 8, p. 58 for restoration.

¹⁴ See A. K. Grayson, *Reallexikon der Assyriologie* 6 (Berlin: Walter de Gruyter, 1980–83), s.v. Königlisten, text WB62.

¹⁵ CT 25 14:30.

¹⁶ P. Steinkeller, “An Ur III Manuscript of the Sumerian King List,” in *Literatur, Politik und Recht in Mesopotamien, Festschrift für Claus Wilcke*, edited by W. Sallaberger et al. (Wiesbaden: Harrassowitz, 2003), pp. 267–92.

¹⁷ Further references in Zadok, *Répertoire* 8, pp. 40–43, include references to unidentified names for Babylon: TE.E^{ki}, EK^{ki}, ŠU.AN.NA^{ki}.

¹⁸ A. R. George, “Four Temple Rituals from Babylon,” in *Wisdom, Gods and Literature: Studies in Assyriology in Honour of W. G. Lambert*, edited by A. R. George and I. L. Finkel (Winona Lake: Eisenbrauns, 2000), pp. 259–99 BM 78076:18.

None of this information is new, although it has not previously been gathered together for this context. The phenomenon is based on an earlier one: compare the details that establish Babylon's use of traditions from Nippur, and how they were taken up in Assur. In Babylon the modeling of Marduk's temple as a replica of Enlil's temple at Nippur is well attested and probably goes back to the time of Hammurabi.¹⁹ At Assur city the remodeling of the god Aššur's temple as a replica of the temple of Enlil in Nippur from the time of Tukulti-Ninurta I (1243–1207 B.C.) has been noted,²⁰ and the substitution of Assur city for Babylon in the Assyrian reworking of the Epic of Creation is also attested.²¹ This information establishes a precedent: that an ambitious and successful king could draw on a prestigious tradition to use the names of Nippur's temples Ešarra and Ekur. Emulation to acquire prestige by association was the motive.

Another precedent is specifically linked to Kish. During the early second millennium B.C. (and perhaps also earlier)²² the title "king of Kish" became used to mean, more or less, "king of the world," a phenomenon linked to the similarity of the city-name Kish with the Akkadian word *kiššatu* "totality," used in royal titles.

We now turn to Assyria in the late eighth century, first to Calah. Versions and fragments of a bilingual Šu'ila-prayer to Marduk were found at Nimrud (Calah), Nineveh, Assur, and in Babylonia. In the Nimrud version, the name Calah had been inserted alongside that of Babylon and Borsippa, and the prayer was addressed not to Marduk but to Nabu.²³ The Šu'ila was recited during the New Year Festival at Babylon, and perhaps, but not certainly, also at Calah. The relevant lines are:

- line 35 Behold Babylon and Esagila, may they say to you, "Lord, calm down"
 Behold Borsippa and Ezida, may they say to you, "Lord, calm down"
 Behold Calah, O Nabu, may it say to you, "Lord, calm down"
 line 36 Restore the lock of Babylon, the bolt of Esagila, the bricks of Ezida, and of Calah.

As is well known, there was a large temple and temple library dedicated to Nabu in his Ezida temple in Calah; and a variant gives an alternative dedicatee for this hymn, Ninurta, the patron god of Calah.

It has long been recognized that the name of the primeval god Anšar, who has a small but fundamental part in the Babylonian Epic of Creation, was manipulated for the Assyrian version, so that Anšar took the part of Marduk and was equated with Aššur as a near-homonym. The god Anšar is also a key to two syncretisms in Assyria, and one in Babylonia, at Uruk.

There is evidence that Sargon II initiated at least some part of the relevant changes many years before his son sacked Babylon. Sargon is the earliest Late Assyrian king to use the spelling An-šár for Aššur in his inscriptions, as Tadmor pointed out in 1958.²⁴ He does not do so everywhere: the new spelling occurs in his Nimrud (Calah) inscriptions, but not in those from Khorsabad. This suggests a link between the Šu'ila from Nimrud addressed to Nabu in one version and Ninurta in another. Is there evidence from other texts in support of the suggestion that a reform took place during the reign of Sargon II, in which Calah was incorporated into the tradition of cities that became Babylons?

Van De Mieroop has suggested that two chronicles, the Weidner Chronicle and the Chronicle of Early Kings, which tell that Sargon (of Akkad) built a new Babylon, in fact refer to Sargon II of Assyria because the mention of Babylon and of Marduk is anachronistic.²⁵

¹⁹ S. Maul "Die altorientalische Hauptstadt – Abbild und Nabel der Welt," in *Der orientalische Stadt: Kontinuität, Wandel, Bruch*, edited by G. Wilhelm (Berlin: Deutsche Orient-Gesellschaft, 1997), p. 120 with references; and S. Maul, "Marduk, Nabû und der assyrische Enlil: Die Geschichte eines sumerischen Šu'ilas," in *tikip santakki mala bašmu: Festschrift für Rykle Borger*, edited by S. Maul (Groningen: Styx Publication, 1998), pp. 159–97, especially ll. 31–33, calling Nippur and Babylon both Marduk's city. See also George, *Topographical Texts*, p. 325.

²⁰ Maul, "Die altorientalische Hauptstadt," p. 122 with references.

²¹ W. G. Lambert, "The Assyrian Recension of Enūma Eliš," in *Assyrien im Wandel der Zeiten: 39^e Rencontre assyriologique internationale*, Heidelberg, 6.–10. Juli 1992 (Heidelberg: Heidelberger Orientverlag, 1997), pp. 77–79.

²² See D. O. Edzard, *Reallexikon der Assyriologie* 5 (Berlin: Walter de Gruyter, 1976–80), p. 610 s.v. Kish, for a summary of the evidence and arguments for its interpretation.

²³ Maul, "Marduk, Nabû und der assyrische Enlil," extending the study of J. S. Cooper, "A Sumerian ŠU.ÍL.LA from Nimrud, with a Prayer for Sin-šar-iškun," *Iraq* 32 (1970): 51–67, with collations of R. Borger, *Zeitschrift für Assyriologie* 66 (1976): 278–79.

²⁴ H. Tadmor, "The Campaigns of Sargon II of Assur: A Chronological-historical Study, Part 3," *Journal of Cuneiform Studies* 12 (1958): 77–100, esp. p. 82 n. 231. See also E. Frahm, *Einleitung in die Sanherib-Inschriften*, Archiv für Orientforschung, Beiheft 26 (Vienna: Institut für Orientalistik, 1997), p. 283. One occurrence in the reign of Tukulti-Ninurta, noted by K. Deller, *Nouvelles assyriologiques brèves et utilitaires* 1987/101, and another in a literary text from Aššur city of the Middle Assyrian period, to be published by Frahm, suggests that Sargon may have revived a previous reform. I thank Dr. Frahm for this information.

²⁵ Marc Van De Mieroop, *Cuneiform Texts and the Writing of History* (Oxford: Routledge, 1999), p. 73.

Marduk ... looked with joy upon him and gave to him sovereignty over the Four Quarters. The provisioning of Esagila, ... Babylon his tribute ... he extracted soil from its excavated earth and ... in front of(?) Akkad he built a(nother) city and he called its name Babylon.²⁶ For the abomination which he had done he (Marduk) became hostile to him and people from East to West became hostile to him, and sleeplessness was imposed upon him (Weidner Chronicle).²⁷

“Sargon ... dug up soil from a clay-pit of Babylon and built a replica of Babylon next to Akkad. For the abomination which he had done the great lord Marduk became angry and destroyed his people by famine; from East to West they became hostile to him, and he, Marduk, inflicted sleeplessness upon him (Chronicle of Early Kings).²⁸

Sleeplessness here does not refer to simple insomnia, but to the condition of an unburied corpse whose ghost does not receive appropriate offerings.²⁹ It fits the case of Sargon II of Assyria who died in battle, and whose body was never recovered for proper burial. If the identification with Sargon II of Assyria is correct,³⁰ these two chronicles can be understood as a veiled attempt to explain why the gods allowed Sargon II to die in this way, and perhaps also giving an anti-Assyrian point of view. The episode in which Sennacherib, having sacked Babylon, put earth from there into the temple in Assur after capturing it, could then be understood as a repetition of his father's action.

These two chronicles are not true chronicles. They are explanatory texts which ostensibly try to explain the good fortune and misfortune of long-past kings in terms of actions that pleased or displeased Marduk, the god of Babylon, and the period in which those kings lived is long before Babylon and Marduk rose to prominence. Grayson reckoned that the Chronicle of Early Kings used two identifiable sources: omens concerning early kings, including omens copied in the Neo-Assyrian period, and the Weidner Chronicle. Two of the known pieces of the Weidner Chronicle come from Assur, the Assyrian capital. The two tablets of the Chronicle of Early Kings are of uncertain provenance.³¹ The accusation leveled at the king in these two texts indicates that to call an Assyrian city a “Babylon” by the late eighth century B.C. could be regarded as an impious act. A later, sixth-century example of the phenomenon may account for the charge leveled against Nabonidus in the Verse Account of Nabonidus, that he imitated Esagila in Harran and built a palace of Babylon in Tayma.³²

Sargon II of Assyria is generally thought to have modeled himself upon his famous predecessor in Akkad when he took Šarru-kīnu as his throne-name, and various connections between him and his illustrious namesake have been noted, not least in the text that accompanies the World Map and the Legend of Sargon's Birth, of which a copy was found at Nineveh. Possible evidence that Sargon II equated at least a part of Assyria with Babylon comes from the World Map.³³ This tablet comes with a text which relates some of the deeds of Sargon of Akkad (reminiscent of the link made by those two so-called chronicles) and is generally agreed to come from the reign of Sargon II. The curious thing about it is that it does not name a single Assyrian city: Assur, Calah, Nineveh, and Sargon's new city Dur-Šarrukin are all absent. Instead, Babylon is more or less central and is the only named city of Babylonia.³⁴

²⁶ Note that the Sippar version reverses the order, to give Akkad built as a new city opposite Babylon. The new text also shows that the text takes the form of an Old Babylonian royal letter. See J.-J. Glassner, *Mesopotamian Chronicles* (Atlanta: Society of Biblical Literature, 2004), pp. 263–68.

²⁷ The mention of Babylon and Marduk before the building of a Babylon opposite Akkad may not be a mistake as Van De Mieroop, *Cuneiform Texts*, pp. 72–74, supposed, if a second Babylon is correct.

²⁸ This theme is picked up in omens; see L. W. King, *Chronicles Concerning Early Babylonian Kings* (London: Luzac & Co., 1907), pp. 27–28, 34–35; and A. K. Grayson, *Assyrian and Babylonian Chronicles* (Locust Valley, New York: J. J. Augustin, 1970), pp. 45–47. Omens naming Sargon (but not Babylon), in the omen series *Multābiltu*, are now edited by U. S. Koch, *Secrets of Extispicy* (Münster: Ugarit-Verlag, 2005).

²⁹ See, for example, C. Wilcke, “Der Tod im Leben der Babylonier,” in *Tod, Jenseits und Identität: Perspektiven einer kulturwissenschaftlichen Thanatologie*, edited by J. Assmann and R. Trauzettel (Freiburg and Munich: K. Alber, 2002), pp. 252–66, especially p. 256.

³⁰ J. S. Cooper, review of *Cuneiform Texts and the Writing of History*, by Marc Van De Mieroop, in *Bulletin of the American Schools of Oriental Research* 327 (2002): 79.

³¹ Grayson, *Assyrian and Babylonian Chronicles*, pp. 152–53, commentary.

³² H. Schaudig, *Die Inschriften Nabonids von Babylon und Kyros' des Grossen*, *Alter Orient und Altes Testament* 256 (Münster: Ugarit-Verlag, 2001), p. 568.

³³ W. Horowitz, *Mesopotamian Cosmic Geography* (Winona Lake: Eisenbrauns, 1998), chapter 2. For the newly joined fragment, see S. Dalley, ed., *The Legacy of Mesopotamia* (Oxford and New York: Oxford University Press, 1998), p. 177.

³⁴ This corresponds to a letter written to a late Assyrian king, perhaps Sargon, from Babylonia, in which it is said: “When he has entered Babylon, he will have set foot on the centre of the lands”; see M. Dietrich, *The Babylonian Correspondence of Sargon and Sennacherib*, *State Archives of Assyria* 17 (Helsinki: University of Helsinki Press, 2003), No. 84:12'.

If these deductions are correct, some part of Assyria, probably Calah, was already considered to be a Babylon when Sennacherib became king.³⁵

Sargon II may have taken a precedent from Uruk, where Anšar was equated with the city's patron god Anu, perhaps as early as the mid- or late second millennium, when the god list AN = Anum was composed. Anšar seems to have been equated not only with Anu but also with Aššur at Uruk during the late Babylonian period, and perhaps also earlier.³⁶ It is probably significant that the so-called Divine Heptad text found at Assur, KAR 142, lists a statue of Marduk in the temple of Anšar.³⁷

When Sennacherib rebuilt the temple of the New Year Festival just outside the city of Assur, he described the cosmic battle from the Epic of Creation which was represented on its doors, but the god Anšar as Aššur had taken the place of Marduk. This change is known also from small pieces of text giving a reworking of the Babylonian Epic of Creation, in which the genealogy of the great gods had been altered to allow the primeval god Anšar to be reinterpreted as a form of the name Aššur, and for Anšar-Aššur to take the part of the victorious hero Marduk. Babylon's name is replaced by Bal.til^{ki}, a name of Aššur, as already mentioned. It has long been reckoned that Sennacherib's sack of Babylon was the crisis that inspired this rewriting of the great epic as an act of revenge, and that the rewriting was part of a religious reform to allow Aššur to take over the power and functions of Marduk. Symbolizing the event, soil from Babylon was put into the temple of the national god Aššur in his city Assur. As far as I know, the dating to the reign of Sennacherib of the equation of Aššur with Anšar for the revision of the epic has not been questioned. But there are certain difficulties in this, not least Sennacherib's own inconsistency in using the spelling in records written after the capture of Babylon, when one would expect the innovation to be enforced most rigorously. The evidence from Sargon's reign suggests that a reform had already taken place in the time of Sennacherib's grandfather and was not carried out as an act of vengeance. In any case, the change of spelling from Aššur to Anšar in Nimrud inscriptions of Sargon has nothing at all to do with the later sack of Babylon. Rather than being an act of retribution, it must bear the opposite interpretation: an act of association to gain prestige. It belongs with the phenomenon we have described for southern Mesopotamia, from the evidence of lexical texts, the topographical list TIN.TIR^{ki} with the names of quarters of Babylon, and variant names for the first city to receive kingship in the Sumerian King List.

Now we turn to Nineveh. It has long been recognized that Sennacherib's Bavian Inscription, in relating the sack of Babylon, presents the rebuilding of Nineveh as an antithesis to the destruction of Babylon.³⁸ Just as Babylon was leveled and abandoned, in the hyperbole of lamentation, so Nineveh rose up and was populated. If the worship of another city's gods in Babylon is an indication that that city had been accorded the status of a Babylon, an extension to Nineveh can be deduced from the fact that Ištar-of-Nineveh had a temple in Babylon.³⁹ Exactly when this cult began is not known; it is found in TIN.TIR^{ki} IV 32 and so arrived there long before the time of Sargon and Sennacherib. Once again, we cannot attribute reform to Sennacherib, whose son Aššur-nadin-šumi renovated the shrine of the goddess in Babylon.⁴⁰

Just as the introduction of the spelling *an-šár* is significant for the new role of the god Aššur, so is the writing of the name Nineveh. From the time of Aššur-rēš-iši (contemporary with Nebuchadnezzar I) onward, the logographic writing UNUG×HA begins to replace syllabic spellings.⁴¹ The change links Nineveh to ancient Nina, a religious center in Girsu-Lagash in southern Iraq, where the city and its goddess Nanše are both written with the same

³⁵ The connection between Babylon and Assyria may have been strengthened by the use, in the early part of the Assyrian King List, of two royal names, Hanû and Didanu, that are also found in the genealogy of Hammurabi. See J. J. Finkelstein, "Genealogy of the Hammurabi Dynasty," *Journal of Cuneiform Studies* 20 (1966): 95–118.

³⁶ P.-A. Beaulieu, "The Cult of Aššur/Anšar in Babylonia after the Fall of the Assyrian Empire," *State Archives of Assyria Bulletin* 11 (1997): 55–74.

³⁷ B. Pongratz-Leisten, ed., *Ina šulmi irub: Die Kulttopographische und ideologische Programmatik der akitu-Procession in Babylonien und Assyrien im 1. Jahrtausend v. Chr.*, Baghdader Forschungen 16 (Mainz am Rhein: Philipp von Zabern, 1994), pp. 221–27.

³⁸ H. Galter, "Die Zerstörung Babylons durch Sanherib," *Studia Orientalia* 55 (1984): 159–73; followed by Van De Mieroop, "Revenge, Assyrian Style," *Past and Present* 179 (2003): 3–23; "Reading Baby-

lon," *American Journal of Archaeology* 107 (2003): 257–75; "A Tale of Two Cities: Nineveh and Babylon," *Iraq* 66 (2004): 1–5.

³⁹ R. Da Riva and E. Frahm, "Šamaš-šum-ukīn, die Herrin von Niniwe und das babylonische Königssiegel," *Archiv für Orientforschung* 46–47 (1999–2000): 156–82; A. R. George, "Marduk and the Cult of the Gods of Nippur at Babylon," *Orientalia* NS 66 (1997): 65–70; and George, "Four Temple Rituals," pp. 259–99 (BM 78076:18).

⁴⁰ See Da Riva and Frahm, "Šamaš-šum-ukīn."

⁴¹ See R. Kutscher, "Excursus: The Orthography of Nineveh," *Bibliotheca Orientalis* 33 (1976): 197–98; and see D. O. Edzard, *Reallexikon der Assyriologie* 9 (Berlin: Walter de Gruyter, 1998–2001), s.v. NINA, where the attribution to Kutscher of Sollberger's understanding of AS 7, and the king in whose reign the first attestation of the logographic writing for Nineveh occurs, should both be corrected.

sign, UNUG×HA. Nanše, “mistress of the precious ordinances,” nun garza kal.la.ke₄ in TIN.TIR^{ki} II 43, had a shrine in Babylon at the main gate to Esagila on the eastern side. Ištar-of-Nineveh, “who controls the most precious ordinances of Anu” *hāmimat* garza.meš ^dAnu *šūqurūti*, in the Ishtar Temple Inscription of Assurbanipal,⁴² also had a temple in Babylon at the time when TIN.TIR^{ki} was compiled, the compilation taking place apparently at roughly the time when the logographic writing of the name Nineveh was introduced, in the twelfth century B.C.⁴³

In a Hymn of Assurbanipal to Ištar-of-Nineveh, the goddess is described as “just like Anšar, she has a beard” *akī Anšar ziqni zaqnat*.⁴⁴ This statement equates the goddess of Nineveh with Anšar and gives her the visible attribute of a male god. The choice of Anšar is significant because the syncretisms of gods that we have described were made via Anšar. Ištar-of-Nineveh was equated with the Bowstar, and the Bowstar has an exceptional role in the Epic of Creation, although it is rather briefly mentioned: in tablet VI, after Babylon was built and destinies decreed, the (female) Bowstar was set in heaven and placed on a throne, whereupon Marduk declared “You are the highest of the gods.” This statement appears to give the goddess a higher rank than that of Bel-Marduk.

In the Ištar Temple Inscription of Assurbanipal (lines 30–40), an account of the restoration of the temple of Anšar is followed by that of Emašmaš, Ištar’s temple in Nineveh, and her ziggurat there. Again we see a very close connection between Anšar and Ištar-of-Nineveh.⁴⁵ The title of Ištar-of-Nineveh in that inscription as “king of heaven and earth” LUGAL AN-*e* u KI-*tim*, elsewhere a title of Marduk proclaimed during the New Year Festival when the deity took his place on the *parak šīmāti* “dais of fates,” suggests that the goddess played a similar role at Nineveh in the time of Assurbanipal. If the text goes back to earlier versions, her role too would have an earlier date. The terms in which Sennacherib described Nineveh as a city from time immemorial, corresponding to the writing of the firmament, has been linked to the concept of a metropolis as the reflection of heaven and the navel of the world⁴⁶ and is one of the characteristics of cities equated with Babylon.

How could the great female goddess of love and fertility be represented as a masculine god? Quite simply, it seems: in the mystical text KAR 307: 19–21 we read: “Ištar of Durna (a name for Nineveh) is Tiamat, she is the wet-nurse of Bel. She has four eyes and four ears” (a description that matches that of Bel-Marduk in the Epic of Creation). “Her upper parts are Bel. Her lower parts are Mullissu.”⁴⁷

This explains why several late Assyrian texts refer to Ištar-of-Nineveh or her other manifestation, Ištar-of-Arbela, as “king” or as “the Lord” Bel. The Assyrian prophecy text K.883 begins: “The word of king Mullissu” *abat* LUGAL ^dNIN.LÍL;⁴⁸ the Ishtar Temple Inscription refers to the goddess as “king (LUGAL) of heaven and earth,” and the Assyrian prophecy text K.4310 refers apparently to Ištar-of-Arbela when stating: “I am Bel” *anāku* ^dEN.⁴⁹ These are not mistakes in the text. They show that Ištar-of-Nineveh and Arbela had become Bel.⁵⁰

An extension of this tradition is found in connection with Arbela, the city where Ištar was worshipped in very close association with Ištar-of-Nineveh. The city is described in a late Assyrian hymn as “the likeness (*tamšil*) of Babylon,” the “bond of the lands” *rikis mātāti*, and the city which fixes the far-off destinies *mukīn paršī rūqūti*, all hallmarks elsewhere of Babylon’s role as the leading city.⁵¹ As we have mentioned already, Ištar-of-Arbela introduced herself in an Assyrian prophecy by declaring “I am Bel.” She was still known as Sharbel in the fourth century A.D.

⁴² A. Fuchs in R. Borger, *Beiträge zur Inschriftenwerk Assurbanipals* (Wiesbaden: Harrassowitz, 1996), pp. 258–96:6.

⁴³ Da Riva and Frahm, “Šamaš-šum-ukin,” p. 173, quote an unpublished commentary on the Epic of Creation which refers to the cult of Ištar-of-Nineveh in Babylon. The reference to Bēlet Nina in the Religious Chronicle (Grayson, *Assyrian and Babylonian Chronicles*, 133 i 6–7) could refer either to Nina in the south or to Nineveh in the north.

⁴⁴ A. Livingstone, *Court Poetry and Literary Miscellanea*, State Archives of Assyria 3 (Helsinki: University of Helsinki Press, 1989), No. 7:6.

⁴⁵ Compare the combined account of construction in Babylon and in Aššur by Esarhaddon, R. Borger, *Die Inschriften Asarhaddons, Königs von Assyrien*, Archiv für Orientforschung, Beiheft 9 (Graz, 1956) AsBbE; and discussion by B. N. Porter, *Images, Power, Politics* (Philadelphia: American Philosophical Society, 1993), p. 67.

⁴⁶ Maul, “Die altorientalische Hauptstadt,” especially p. 124. See also V. Hurowitz, *I Have Built You an Exalted House: Temple Building in the Bible in the Light of Mesopotamian and North-West Semitic*

Writings, Journal of the Society for Old Testament Study, Supplement 115 (Sheffield: Sheffield Academic Press, 1992), p. 74 n. 4, for Sennacherib’s association of Nineveh with Apsu-lalgar.

⁴⁷ Livingstone, *Court Poetry*, No. 39.

⁴⁸ S. Parpola, *Assyrian Prophecies*, State Archives of Assyria 9 (Helsinki, University of Helsinki Press, 1997), No. 7. Attempts to explain away this explicit wording are noted in *Prophets and Prophecy in the Ancient Near East*, edited by M. Nissinen et al. (Atlanta: Society of Biblical Literature, 2003), p. 128 note a.

⁴⁹ Parpola, *Assyrian Prophecies*, No. 1:4. Nabu is named at the end of the text, probably as Ištar’s closest associate, a relationship evident from K.1285 (Livingstone, *Court Poetry*, No. 13) and the proximity of the temple of Nabu to Ištar’s temple at Nineveh. Ištar-of-Nineveh and Ištar-of-Arbela were regarded as virtually the same goddess.

⁵⁰ See also Da Riva and Frahm, “Šamaš-šum-ukin,” pp. 156–81.

⁵¹ Livingstone, *Court Poetry*, No. 8.

Tarsus in Cilicia is another possibility, since we know that the name of the local god Sanda was written in the Late Bronze Age with the logogram normally reserved for Marduk, and Berossus says that Tarsus was rebuilt by Sennacherib in the likeness of Babylon.⁵² As with the use of Anšar as a writing for the god Aššur and the logogram Nina for Nineveh, the use of a particular logogram is significant far beyond mere variation in writing.

Long after the fall of Assyria as an imperial power, the title Bel persisted, attached to the great Assyrian goddess. Cuneiform texts confirm that Ištar-of-Nineveh was still worshipped in Assyria in the time of Darius.⁵³ In the Parthian period, Aramaic inscriptions from Assur and Hatra show that the title had become part of her name: Issarbel.⁵⁴ Issar is the Assyrian dialect form of the Babylonian form Ištar. And according to a Syriac text, a priest of the pagan goddess Sharbel at Arbela, who had converted to Christianity, was martyred by the Zoroastrian king Shapur II in A.D. 355.⁵⁵

From a political and theological point of view, it cannot be considered a sign of hatred or enmity that Babylon lent its name to northern Assyrian cities and incorporated their cults into its own establishment, as it had done with southern cities.⁵⁶ Rather, it is a sign of the enormous prestige of Babylon, and a sign of admiration and emulation that inspired late Assyrian kings to use the name of Babylon for cities in Assyria, blending all of ancient Mesopotamia into a unitary whole.

There are certain terms which seem to mark cities that belong in the category we are trying to define. Their foundation must be put back into primeval times, as Babylon proper is in the Epic of Creation, as Kish is in the Epic of Etana, and as Nineveh is in the Prism Inscription of Sennacherib: “Nineveh whose plan was designed in the beginning with the writing of the firmament” *Ninua ša ultu ullâ itti šitir burummê ešrassu ešret*.⁵⁷ The temple of the city god must be the navel of the earth where a cord connects heaven to the earth. This idea is first found at Nippur and was taken over for Babylon.⁵⁸ In this connection Ištar-of-Nineveh is “she who holds the cord of the holy firmament, which is founded in the wide heavens” [*šābitat/mukillat*] *markas burummê KÙ.MEŠ ša ina šamê rapšūti šuršudu*, and “the ruler of heaven and earth who decrees fates, who controls the most precious rites of Anu, who grasps the responsibilities of Enlil” *šar šamê u eršeti mušim šimāti ... hāminat paršē ša Anu šūqurūti tāmihat piqitti Enlilūti*.⁵⁹ The cord that joins heaven to earth can refer to Arbela.⁶⁰ The so-called dais of destinies⁶¹ is the place where a ritual took place that was crucial to the future of the world; it is found not only in this text from Nineveh, but also in Nippur, Babylon, Duru, Uruk, Akkad, Kish, Arbela, and Assur.⁶²

This model of southern cities known to be “Babylons,” which was extended to some cities that may have included Calah, Assur, Arbela, and Nineveh, helps to explain why Nineveh was known to later, biblical and classical, traditions as Babylon.

The royal inscriptions of late Assyrian kings do not use the name Babylon for Nineveh or Calah, which suggests that the use of the metonym was restricted. We have looked at two pseudo-chronicles and the World Map in which the phenomenon may occur. In what other types of text can the metonym be found?

One possibility is astronomical texts. The evidence for this is not direct and is in some ways very unsatisfactory because it comes from a medieval source in which there was an “Old Babylon” on the latitude of Assyrian cities, a “Second Babylon” in central Mesopotamia, and a “New Babylon” in southern Mesopotamia. As long ago as 1934, Schott pointed out that the latitude from which the standard figure for the longest day was taken and used in suppos-

⁵² See S. Dalley, “Sennacherib and Tarsus,” *Anatolian Studies* 49 (1999): 73–80.

⁵³ Zadok, *Répertoire* 8, pp. 238–29. For the worship of Ištar-of-Arbela in the reign of Cyrus, see J. McGinnis, “Temple Ventures across the River,” *Transeuphratène* 27 (2004): 32–33, BM 62805.

⁵⁴ K. Beyer, *Die aramäischen Inschriften aus Assur, Hatra und dem übrigen Ostmesopotamien* (Göttingen: Vandenhoeck & Ruprecht, 1998). The identification of the deity as a goddess was made by J. T. Milik, *Dédicaces faites par les dieux (Palmyre, Hatra, Tyr) et des thiasés sémitiques à l'époque romaine*, *Recherches d'épigraphie proche-orientale* 1 (Paris: P. Geuthner, 1972).

⁵⁵ P. Peeters, “Le Passionnaire d'Adiabène,” *Analecta Bollandiana* 43 (1925): 261–304.

⁵⁶ See, for example, W. G. Lambert, “The God Aššur,” *Iraq* 45 (1983): 86, who claims that Sennacherib hated Marduk and attempted to put

an end to his cult; a similar view is expressed by Van De Mieroop, “Revenge, Assyrian Style,” “Reading Babylon,” and “A Tale of Two Cities.”

⁵⁷ D. D. Luckenbill, *The Annals of Sennacherib*, Oriental Institute Publications 2 (Chicago: University of Chicago Press, 1924), p. 94:64 and p. 103:28.

⁵⁸ George, *Topographical Texts*, p. 244.

⁵⁹ Fuchs apud Borger, *Beiträge*, pp. 264–65; and see George, *Topographical Texts*, pp. 262 and 266–67, for the other cities.

⁶⁰ Livingstone, *Court Poetry*, No. 8.

⁶¹ Miguel Civil suggests (personal communication) that BARAG *parakku* is a tent curtain that screened off a private and sacred space, rather than a dais or platform, and cognate with Hebrew *pāroketh*.

⁶² George, *Topographical Texts*, pp. 287–91; and see also Livingstone, *Court Poetry*, No. 8:18, for Arbela as *parakki šimāti*.

edly Babylonian astronomical texts was the latitude, approximately, of Nimrud, Assyrian Calah.⁶³ His conclusion is confirmed in the full edition of MUL.APIN, a compilation which is based on observations taken in the latitude of 76 degrees. Medieval translations into Latin of the Toledo astronomical tables used in western Europe said that the standard figure was that of “Old Babylon.” This may be taken as an indication that an Assyrian city, probably Calah, had become known as a Babylon when MUL.APIN was compiled, probably in the late eighth or early seventh century B.C.⁶⁴

A second possibility is that the name of Babylon was used with deliberate ambiguity in a pseudo-prophecy. The Marduk Prophecy was found at Nineveh in the house of a Sargonid exorcist, and presumably the text, or copies of it, date to the late eighth or the seventh century B.C. In the Marduk Prophecy, in the second part of the text where verbs change from past tenses to present / future ones, the Babylonian king who brings / will bring Marduk back to Babylon may be understood as referring either to Nebuchadnezzar I or to Esarhaddon and Assurbanipal. The destruction of Elam by a king fits both periods equally well. The blessing which Marduk accords to Assyria, closely followed by his command to bring tribute to Babylon, also fits both periods. The later date would allow the “king of Babylon” to be an Assyrian king ruling in Nineveh, even when the Assyrian king was not performing the duties of a Babylonian king in Babylon. But another possibility is the reign of Sargon II, who ruled from Calah during almost all of his reign.

We have seen that the Chronicle of Early Kings has passages in common with omens and is thought to have used omens as a source. During the Neo-Assyrian period a category of texts became explicitly differentiated from others as secret literature.⁶⁵ The information comes from colophons which are seldom preserved. The category links certain texts to divine origin, authorship that came from heaven, sometimes through the mediation of the sages. Borger has suggested that secret literature may be ancestral to the term *Mysterium* from later antiquity. As we have seen, the reference to Mullissu as a goddess whose upper half was Bel in KAR 307 gives only the rare esoteric name, Durna, for Nineveh. Omens and astronomical literature both belong to this category. Therefore we may suggest that the reason Nineveh is not called Babylon in so many historical texts comes from the restricted usage of the metonym, confined to a secret category of literature. Omens and astronomical literature were widely diffused throughout the Assyrian empire and later. The concept of “secret” meant that the information in the text had a divine origin, not necessarily that its dissemination was restricted.

For biblical and classical scholars, there are some applications of these discoveries. First, in the passage in Isaiah 14:4–23 describing the death in battle of the Son of the Dawn, the mention of Babylon may be contemporary with the events to which it alludes; Assyria is named in verse 25. Likewise the oracles in Isaiah 13 and 14, also in 21:9, the fall of “Babylon,” described with the stereotypes of lamentation, may equally refer to Nineveh, since it was the fall of Assyria, not of Babylon, that required a prediction at that time. The ambiguity of the name would have been a boon to later interpreters.

Second, when Manasseh went to “Babylon,” 2 Chronicles 33:11, it is likely that Assyria, probably specifically Nineveh, is meant.⁶⁶

In both cases commentators have suggested that the text contains either an emendation by a later redactor or has been inserted spuriously. The new understanding of the name of Babylon used as a metonym, certainly by the end of the eighth century B.C., shows that the suggestion is unnecessary.

Third, the Book of Revelation and some apocryphal writings⁶⁷ refer to “Babylon the mother of harlots” as a metonym for Rome. The tradition of naming by metonym other great cities, in this instance Rome, persisted and expanded beyond Mesopotamia in the Roman period. This is clearly understood in all the commentaries on the Book of Revelation, but unfortunately not by several Assyriologists, who have wrongly applied the expression “mother of harlots” to Babylon instead of Rome, forgetting that the “virgin daughter of Babylon” is the expression used in

⁶³ A. Becker and U. Becker, “‘Altes’ und ‘Neues’ Babylon?” *Baghdader Mitteilungen* 22 (1991): 501–11.

⁶⁴ H. Hunger and D. Pingree, MUL.APIN: *An Astronomical Compendium in Cuneiform*, *Archiv für Orientforschung*, Beiheft 24 (Vienna: Institut für Orientalistik, 1989), pp. 9–10.

⁶⁵ See R. Borger, *Reallexikon der Assyriologie* 3 (Berlin: Walter de Gruyter, 1957–71), s.v. Geheimwissen.

⁶⁶ See H. M. G. Williamson, *1 and 2 Chronicles*, *New Century Bible Commentary* (Grand Rapids: Eerdmans and Marshall; London: Morgan and Scott, 1982), with reference to Babylon as the place visited by Manasseh: “superficially curious as a seat of Assyrian power, must have been consciously included as a pointer to the national exile later on.”

⁶⁷ For example, F. J. Murphy, *Fallen is Babylon: The Revelation to John* (Harrisburg, Pennsylvania: Trinity Press International, 1998), pp. 43–44.

Isaiah 47:1.⁶⁸ The image of whoring is not found with reference to Babylon elsewhere in the Old Testament, but it is used of Nineveh in Nahum 3:4: “Whore of Nineveh, cunning witch who enslaved nations by her debauchery and tribes by her spells.”

Diodorus Siculus, describing a scene in the palace at “Babylon” of “Semiramis” hunting lions, is referring to beardless men in the famous lion-hunt sculptures of Assurbanipal at Nineveh, not necessarily as a confusion; the static, heraldic style of Nebuchadnezzar’s palace decoration in Babylon proper is very different. A confusion is evident in the Book of Judith, in which Nebuchadnezzar is called king of the Assyrians, ruling in Nineveh.⁶⁹ As for the Book of Jonah, the reverse suggestion, that the name of Nineveh stands for Babylon,⁷⁰ is unnecessary now that the importance of Nineveh proper has been established for the Seleucid period and presumed for the Persian period.⁷¹ The statement of Pseudo-Eupolemos, that Babylon was a city of Assyria,⁷² may refer to the tradition outlined here, although other explanations are possible.

We may take into account the possibility that Bel in biblical and apocryphal texts could refer to Assyrian Ištar.

Victor Hurowitz has recently argued that the story of Jacob’s dream in Genesis 28:10–22, because it includes motifs drawn from the Babylonian Epic of Creation that associate Bethel with Babylon, alludes to a specific link between the two cities as a theological and political act.⁷³

In conclusion, there was an indigenous tradition in which great cities of southern Mesopotamia became known by metonymy as Babylon, at least from the Late Bronze Age, and perhaps earlier. This tradition grew out of two older traditions. In the case of Nippur, the main god and temple of Nippur were applied to the main god and temple of another great city. In the case of Kish the city name became used for the whole world, in part as a play upon the syllable *kiš*. In the case of Babylon, the application of its name to northern cities in Assyria and Cilicia, probably including Assur, Nineveh, Arbela, and Tarsus, may go back to the Late Bronze Age but was perhaps extended by Sargon II in the late eighth century to include Calah. This phenomenon can sometimes be traced from a shift in the writing of a god name or place name, and in several instances the god Anšar plays an intermediate role. The metonymic usage was confined to a restricted category of texts. Scholars in neighboring countries knew about that use of the name Babylon at least by the seventh century B.C. Several biblical and Greek sources name Nineveh as a Babylon, not by confusion but from a knowledge of that Mesopotamian tradition. Their knowledge of it may well go back to the late eighth century, if not earlier.

⁶⁸ Van De Mieroop, “Reading Babylon,” p. 257; J. Assante, “From Whores to Hierodules,” in *Ancient Art and its Historiography*, edited by A. A. Donohue and M. D. Fullerton (Cambridge: Cambridge University Press, 2003); G. Leick, *Sex and Eroticism in Mesopotamian Literature* (London: Routledge, 1994), p. 1.

⁶⁹ For the same confusion in an Arabic source, see G. Komoróczy, “Ein assyrischer König in der arabischen Überlieferung,” *Altorientalische Forschungen* 1 (1974): 153–64.

⁷⁰ See M. C. A. Korpel, “Disillusion among Jews in the Postexilic Period,” in *The Old Testament in Its World* (Papers read at the Winter Meeting, January 2003, The Society for Old Testament Study and at the Joint Meeting, July 2003, The Society for Old Testament Study and het Oudtestamentisch Werkgezelschap in Nederland en België),

edited by R. P. Gordon and J. C. de Moor (Leiden: Brill, 2005), p. 141. I thank Prof. de Moor for this reference.

⁷¹ In a forthcoming book on the Hanging Gardens of Babylon, the writer will propose an explanation for Xenophon’s description of deserted Assyrian cities in the *Anabasis*.

⁷² F. Jacoby, *Die Fragmente der griechischen Historiker* 3 C/2 (Leiden: Brill, 1958), p. 678. I am grateful to Prof. de Moor for this reference.

⁷³ V. A. Hurowitz, “Babylon in Bethel – New Light on Jacob’s Dream,” *Teshurot LaAvishur: Studies in the Bible and the Ancient Near East*, edited by M. Helzer and M. Malul, Archaeological Center Publications, Tel Aviv-Jaffa, 2004. I thank Prof. Hurowitz for showing me a draft of his paper in advance of its publication.

REFLECTIONS ON THE PAST AND THE FUTURE OF THE REALLEXIKON DER ASSYRIOLOGIE UND VORDERASIATISCHEN ARCHÄOLOGIE (RLA)

Gabriella Frantz-Szabó, University of Munich

THE BEGINNINGS AND EARLY HISTORY OF THE RLA

In the twenties of the last century, scholarly research on the ancient Near East had reached a remarkably high level, considering that this scholarly discipline was only about seventy years old. Akkadian inscriptions of all kinds could be read and interpreted without great effort, the understanding of Sumerian had been growing rapidly since François Thureau-Dangin's pioneering work on the Sumerian royal inscriptions (1907), and, finally, the third great "cuneiform language," Hittite, was revealing its secrets.

In 1922, Bruno Meissner, whose two volumes, *Assyrien und Babylonien* (Heidelberg: C. Winter, 1920 and 1925), summarized what was then known about ancient Mesopotamia, conceived the idea of creating a multi-authored encyclopedia dealing with Assyriology, a *Reallexikon der Assyriologie* (RIA). Meissner had in mind a work comparable to Pauly-Wissowa's *Realencyclopädie der classischen Altertumswissenschaften* or Ebert's *Reallexikon der Vorgeschichte*.

Meissner found an inspired co-worker for the new project in his Berlin colleague, Erich Ebeling. The renowned Berlin publisher, Walter de Gruyter, who since 1886 had published the *Zeitschrift für Assyriologie*, was ready to produce it. The plan evoked the "broadest concurrence" among colleagues in the field, but the difficulties were enormous and six years slipped by before the first fascicle of the RIA appeared in 1928, as one can read in Meissner's foreword.¹ It is interesting to read that already eighty years ago, the editors had to struggle with the same kinds of problems we encounter today.

The two editors originally planned the finished publication to consist of two volumes of some 1,600 pages altogether, covering all entries from A to Z. Rapidly it became clear, however, that this plan was not realistic; by the time that the second volume was published in 1938, the 974 pages in these two volumes had reached only the letter E.²

The mother-tongue of the thirty-five contributors (from Austria, Germany, Switzerland) to these first two volumes was German, except for the Slovenian Viktor Korošec, the author of the article "Ehe in Hatti" ("Marriage in Hatti"), but he both spoke and wrote German fluently. The RIA was not yet an international project.

While Meissner almost totally abstained from authorship, Ebeling contributed about one-fifth of the contents of the first two volumes. One of the most important of the other contributors was Arthur Ungnad, who wrote the comprehensive entries "Datenlisten" and "Eponymen" which remained the most authoritative accounts of these topics for many decades.

After the outbreak of the Second World War in 1939, work on the RIA was halted and was not resumed in the first post-war years.

¹ E. Ebeling and B. Meissner (eds.), *Reallexikon der Assyriologie* 1 (Berlin: Walter de Gruyter, 1928), pp. 3–4.

² *Reallexikon der Assyriologie* 1 and 2 (Berlin: Walter de Gruyter, 1928 and 1938).

THE REVIVAL OF THE RLA AFTER WORLD WAR II

Of crucial importance for the RIA was the foundation of the *Rencontre Assyriologique Internationale*. At its first meeting in Paris in 1950, the future of the RIA was discussed and Adam Falkenstein stressed that the RIA could only be continued if it were based on international cooperation.³ A year later, at the second Rencontre, Father Alfred Pohl of the Pontifical Biblical Institute in Rome discussed how the RIA might be revived.⁴ I see him as the spiritual father of the RIA as we know it today. Almost all the suggestions that he made at that time have now been adopted for the Reallexikon. He proposed that either the RIA should be continued with the headwords remaining in German but with the articles written in one of three languages: English, French, or German; or alternatively, since many of the pre-war entries in the RIA were badly outdated and de Gruyter held the rights to the old title, *Reallexikon der Assyriologie*, a completely new *Encyclopaedia of Cuneiform Studies* should be started with the headwords in English. He also advised that the RIA should comprise the entire field of “cuneiform culture,” with different aspects of complex topics handled by individual specialists. Pohl reckoned that, with 150 authors, the project could be completed in eight to ten volumes in some ten years. In order to finance the project, Pohl suggested that a proposal be submitted to UNESCO.

In the discussions that followed Pohl’s suggestions many scholars spoke up. Among them, Adam Falkenstein and Jean Nougayrol pessimistically considered the time not yet ripe for a new encyclopedia in view of the small number of scholars working in the various fields of the ancient Near East, the great variety of new text archives which were not yet completely published (for example, Mari), and the countless other duties of most researchers. Pohl countered that it would take half a century to study all the new finds and this would mean that in consequence one would have to wait that long before the RIA project could again be taken up. In the end, a committee was formed to consider preparations necessary for a new encyclopedia. The committee members were Paul Édouard Dhorme, Erich Ebeling, Henri Frankfort, Albrecht Goetze, Franz Marius Theodor de Liagre-Böhl, and Alfred Pohl.

One year later, in 1952, at the third Rencontre in Leiden, the subject was again on the agenda.⁵ De Liagre-Böhl returned to Pohl’s ideas and proposed that the RIA should be resumed. Once again, opinions were divided. Some supported this plan but others wanted to create a completely new encyclopedia exclusively in English, or in English and French. Wolfram von Soden warned against an undertaking that was too big and thus unrealizable. Twenty-seven participants cast their votes in favor of the continuation of the RIA, whereas twenty-two voted for a completely new *Encyclopaedia of Cuneiform Studies*.

The new editor was Ernst Weidner of the University of Graz, assisted by Margarethe Falkner; in 1957 the first fascicle of volume 3 beginning with the letter F was published. Weidner used some of the old (and often outdated) pre-war manuscripts, among them many by Erich Ebeling and Eckhart Unger, but he also substantially expanded the pool of contributors, both in number and nationality. With the article “Fehlgeburt” (“Miscarriage”), the first French contributor, René Labat, entered the circle of RIA authors; others from the USA and Italy followed. Their contributions were translated into German, because Weidner held fast to the principle that the RIA should be a German project. At the same time, in order to accommodate the establishment of Near Eastern archaeology as a separate discipline, the title of the RIA was expanded to *Reallexikon der Assyriologie und Vorderasiatischen Archäologie*.

In 1966, Wolfram von Soden in Münster became editor, assisted by Ruth Opificius. Von Soden strengthened the RIA in many ways and gave to it the character that it still has today. Instead of a single editor, an editorial board consisting of the editor-in-chief and co-editors responsible for different areas of scholarship was created. Von Soden took up the recommendation of Pohl and included articles written in English, French, and German with the headwords remaining in German. The first of the non-German articles was the entry “Gesetze in Assyrien (Laws in Assyria)” by Guillaume Cardascia published in French in volume 3 (pp. 279–87). The number of contributors to volume 3 (the last fascicle of which was published in 1971) was more than double the number of contributors to volumes 1 and 2 and these seventy-three authors came from fourteen different countries.⁶

³ *Compte rendu de la 1^{ère} Rencontre Assyriologique Internationale, Paris 26–28 Juin 1950* (1951), p. 24.

⁴ *Compte rendu de la 2^{ème} Rencontre Assyriologique Internationale, Paris 2–6 Juillet 1951* (1952), pp. 73–75.

⁵ *Compte rendu de la 3^{ème} Rencontre Assyriologique Internationale, Leiden 28 Juin–4 Juillet 1952* (1954), pp. 144–46.

⁶ Austria, Canada, Czechoslovakia, Germany, England, Finland, France, Holland, Iraq, Italy, Sweden, Switzerland, the United States, and Yugoslavia.

THE RLA UNDER THE EDITORSHIP OF DIETZ OTTO EDZARD

In 1972 von Soden handed over the editorship to Dietz Otto Edzard, who had been a co-editor for Sumerian since 1966. The editorial office moved from Münster to Munich. After six months of being the sole editor, during which time he managed only to deal with the entries from H to “Handel (Trade)” — embarrassingly leaving out Hammurapi of Babylon — Edzard realized that progress was too slow and he invited me in the summer of 1972 to become his co-worker. As a Hittitologist, and inexperienced in the details of editorial work, I undertook this assignment with great hesitation. Edzard, who was also a relatively inexperienced editor at that time, had two requests of me: my handwriting should be small and I should work quite independently. He also urged me to avoid all mechanical and senseless tasks, to be creative, and to write many articles for the RIA by myself. He did not realize then how time consuming the editing would prove to be.

Sometimes I took my independence too seriously and as a result, we had, in the beginning, some disagreements and even quarreled at times. But, thank heaven, even though it was not always easy, we managed to solve such problems. Standing between Edzard, the co-editors, and the authors, I was often in despair. Edzard did not always see eye-to-eye with the special demands of archaeology and — perhaps more especially — with those of the archaeologists, and naturally, vice-versa. Many disputes with, for example, the co-editor for archaeology, Peter Calmeyer, were finally resolved over conciliatory dinners and interesting conversations about Thomas Mann whom they both fervently admired. But often problems were left unsolved by the editor-in-chief and the co-editors and in such cases I had to trust my own psychological and professional instincts.

Under Dietz Otto Edzard’s editorship, between 1972 and his unexpected death in June 2004, seven volumes with more than 4,000 pages appeared, covering the letters H to P. The circle of authors had grown to include scholars from some twenty-one different countries.⁷ For example, eighty-six authors from fifteen countries contributed 420 articles to the letter L. Edzard himself wrote some 550 articles during his editorship.

Dietz Otto Edzard had very much wished to be here today in his much-loved city of Chicago where he had enjoyed living and working. He loved and highly valued his colleagues here. He was ever obliged to Erica Reiner who even managed to get the truly water-timid Dietz to swim in the great Lake Michigan. And it was with Erica’s encouragement that, here in Chicago, he got his coveted driver’s license, having passed the exam on the second attempt.

Dietz Otto Edzard was the soul and spirit of the *Reallexikon der Assyriologie* during the thirty-three years of his editorship and he has set the standard and has provided the inspiration for our future work. We remember his tireless dedication, his continual concern for the form and content of the contributions, his personal engagement with the authors, his sense of humor, and the many other qualities that made him a wonderful editor and colleague. For his contribution to the RIA (not to mention his many other scholarly achievements) he deserves the enduring gratitude of all those interested in the study of the ancient Near East and he has the undying affection of those of us who knew him personally and had the privilege of working with him.

THE FUTURE OF THE RLA

Here at the end I must ask the question: Why has the RIA not yet reached its last entry “Zypresse”? If there are, worldwide, so many co-researchers, why has only one fascicle of 160 pages appeared each year?

Until 1985, the RIA project was financed by the Deutsche Forschungsgemeinschaft for consecutive periods of one or two years, each renewal depending on the votes of the referees. In 1986, the Bayerische Akademie der Wissenschaften (Bavarian Academy of Sciences) took over the financial responsibility for the project. We are extremely grateful for this support of our work. But the Academy, like the Forschungsgemeinschaft, can provide the funds for only one single full-time editorial position and for some part-time student assistance, as well as the costs of stationery and postage.

⁷ Austria, Belgium, Canada, Czechoslovakia, Denmark, England, Finland, France, Georgia, Germany, Holland, Hungary, Iraq, Israel, Italy, Japan, Poland, Sweden, Switzerland, Turkey, and the United States.

For our last evaluation by Professors Alfonso Archi and Stefan Maul in December of 2000, I had to write up a list of all the tasks necessary in the preparation of an RIA fascicle. During the thirty-three years of my labors on the RIA, the highest praise I received was in the form of Stefan Maul's subsequent question: "And you do all of this by yourself?" My answer was: "Yes, and it is just one part of the work." The rest is accomplished with the energetic and friendly collaboration of the editors and the authors whose patience and good will has often been requested and always freely and generously given. For this I thank all the authors, both those present in Chicago and those who are not here.

After Edzard's death in 2004, his chosen candidate as successor, Michael Streck, became editor. Professor Streck, while still a student in Munich, had actively helped in the numerous tasks that have to be undertaken in the preparation of the fascicles as well as having written many articles for the RIA on diverse subjects over the years since then. It is his fervent hope and firm intention that the RIA will be completed during his editorship.

The RIA can now look back at more than half the alphabet. Ahead loom the letters R to Z. To complete the project an estimated eleven or twelve fascicles consisting in total of about 1,800 pages are still to be written. According to our present plans, we hope to complete this work in six years (by the end of 2011), for which period the Bayerische Akademie der Wissenschaften has promised financial support. Each year we will have to publish two fascicles, each about 160 pages long. Experience tells us that a publication schedule such as this will be extremely difficult to accomplish in view of the prevailing work habits of both authors and editors, particularly with only one full-time staff member to handle the editing.

We, including the co-editors, are therefore determined to operate according to a well-defined and strict structure-plan for the conclusion of the project. The essential elements of this plan are:

- 1) the revision of the list of headwords and the completion of all entries to the end of the alphabet,
- 2) fixed deadlines distinctly earlier than before,
- 3) strict observance of length limitations for the articles, and
- 4) an even wider circle of authors than previously.

Dietz Otto Edzard often stressed that "the lists of entries are the soul of the RIA." We have, therefore, already revised the list of headwords for the remaining letters; it is over 200 pages long. The topics have been subdivided into different categories according to subject matter and an assessment of the importance and an estimate for the length of each article have been made. We have also formed an enlarged pool of possible authors for the different specialties. Good progress is being made toward the completion of the RIA.

THE FINAL GOAL OF THE RIA

Academic research, if you will allow me an over-simplification, may be divided into areas of "calm" ("ruhig") and of "turbulent" ("unruhig") scholarship. "Calm" research is like a broad and peaceful river growing larger and more reliable as it progresses. "Turbulent" research, on the other hand, is subject to rapid changes of course, when new discoveries cast doubt on long-accepted beliefs and force the researcher radically to revise traditional views of the course of history.

I shall mention only one well-known example. Until about twenty years ago, communis opinio held that the cuneiform writing system made its way from Mesopotamia to Syria during the Ur III period, around the turn from the third to the second millennium B.C. Then came a bolt out of the blue: in the north Syrian site of Ebla, huge numbers of cuneiform tablets dating from the twenty-fourth century B.C. were uncovered. Similar finds from other north Syrian sites followed. Now we know for certain that cuneiform culture had spread out from Mesopotamia proper much earlier than we had assumed.

Much of the subject matter of the RIA may be classified as "turbulent" as new discoveries and analyses can make obsolete or invalidate earlier ideas. We take this danger as a challenge and have always tried to include new entries on topics which had not been foreseen when the fascicles were being planned, and to incorporate the most recent information in the articles; as a result the publication schedule has often been delayed while the necessary changes were being made. Nevertheless, the truth is that in the eighty years since the work on the RIA began there

have been many subsequent discoveries that have not been taken into account in the previously published entries in the RIA; indeed, many of the earlier articles in the RIA can no longer be relied on.

Our final goal—once we have arrived at the end of the alphabet—is to start a revision from the beginning. If the RIA—despite the inherent difficulties, some of which have been mentioned here—actually reaches the final entry “Zypresse” (“Cypress”) by the end of 2011, then, and only then, is there a slim chance that we may be able to get funding to produce the necessary supplements and indexes and possibly even to prepare a new edition of the first two volumes.

Thus some taxing years still lie ahead for the editorial team of the RIA and, ladies and gentlemen, for you, the authors!

RECONSIDERING ŠU.IL₂.LA₍₂₎ AS A CLASSIFIER OF THE ĀŠĪPU IN LIGHT OF THE ICONOGRAPHY OF RECIPROCAL HAND-LIFTING GESTURES

Christopher Frechette, S.J.

INTRODUCTION

Among the texts preserved from ancient Mesopotamia, many record knowledge concerning the gods and how humans were to interact with them, knowledge which was ultimately attributed to Enki/Ea, the god of wisdom. In attempting to grasp just how such knowledge was classified, however, modern scholarship continues to wrestle with terms, some of fundamental cultural significance, that resist clear explanation.¹ In the case of incantations, the ancient librarians and archivists of scribal schools often assigned individual texts to larger groups or series by means of a rubric.² While the rationale behind a given rubric is in some cases apparent,³ in other cases such rationale may be more opaque. One such rubric, ŠU.IL₂.LA₍₂₎, literally “lifted hand(s),” is particularly well attested. Texts bearing this rubric demonstrate significant variety in form, language, and ritual setting,⁴ and the ritual expert associated with them may be the *āšīpu* or the *kalû*.⁵ Given such variety, ŠU.IL₂.LA₍₂₎ as a rubric should not be presumed to have shared an identical meaning in all cases. Acknowledging that the arguments offered in the present paper might have relevance for interpreting ŠU.IL₂.LA₍₂₎ as a rubric in any text, I offer them as relevant primarily for its interpretation when applied to the

¹ Many colleagues have generously discussed aspects of this paper with me and offered beneficial comments and questions. I would like to acknowledge my debt of gratitude to them, and to name three, in particular: Paul-Alain Beaulieu, Eugene McGarry, and Irene J. Winter. Other papers presented at this Rencontre discussed difficulties in interpreting some fundamental terms related to such knowledge. W. G. Lambert, for example, articulated a complex of problems pertaining to assessment of the relationship between incantation texts and logograms frequently used to classify them: EN₂, KA.INIM.MA, and formulas such as TU₆.EN₂.E₂.NU.RI. For M. Geller, see n. 5, below.

² M. J. Geller, “Incipits and Rubrics,” in *Wisdom, Gods and Literature: Studies in Assyriology in Honour of W. G. Lambert*, edited by A. R. George and I. L. Finkel (Winona Lake: Eisenbrauns, 2000), p. 225.

³ For example, the rubric NAM.BUR₂.BI “its dissolution” refers to the evil portended by an omen which could be averted by performance of the designated ritual. Stefan M. Maul, *Zukunftsbewältigung: Eine Untersuchung altorientalischen Denkens anhand der babylonisch-assyrischen Löserituale (Namburbi)*, *Baghdader Forschungen* 18 (Mainz am Rhein: Philipp von Zabern, 1994), p. 11.

⁴ With the majority of the preserved texts being in monolingual Akkadian and a few in bilingual Akkadian-Sumerian, they also occur in Emesal (a “dialect” of Sumerian). For a discussion of the monolingual Akkadian rituals which also treats their inclusion within or alongside other rituals, see Christopher G. Frechette, “The Name of the Ritual: Investigating Ancient Mesopotamian ‘Hand-Lifting’ Rituals with Implications for the Interpretation of Genre in the Psalms” (Th.D. diss., Harvard University, 2005), revised version forthcoming in AOAT. For a study of the structure of the monolingual Akkadian rituals, see Annette Zgoll, “Audienz—Ein Modell zum Verständnis mesopotamischer Handerhebungsrituale: Mit einer Deutung der Novelle vom Armen Mann von Nippur,” *Baghdader Mitteilungen* 34 (2003): 181–203. For some discussion of those in bilingual Sumerian-

Akkadian associated with the *mīs pī* “mouth opening” rituals for the consecration of a statue as a deity, see Angelika Berlejung, *Die Theologie der Bilder: Herstellung und Einweihung von Kultbildern in Mesopotamien und die alttestamentliche Bildpolemik*, *Orbis Biblicus et Orientalis* 162 (Freiburg, Switzerland: Universitätsverlag, 1998), esp. pp. 200 and 231; and Christopher Walker and Michael Dick, *The Induction of the Cult Image in Ancient Mesopotamia: The Mesopotamian Mīs Pī Ritual*, *State Archives of Assyria Literary Texts* 1 (Helsinki: The Neo-Assyrian Text Corpus Project, 2001), p. 64 n. 111. For studies of those in Emesal, see Daisuke Shibata, “Die Šuilla-Gebete im Emesal” (Ph.D. diss., Ruprecht-Karls-Universität Heidelberg, 2005); and Andrea Bonhagen, “Die ‘sumerischen’ Šuilas: Untersuchungen zu Ausdruck, Inhalt und Kultzusammenhang eines Gebetstyps” (M.A. thesis, Ruprecht-Karls-Universität Heidelberg, 1997).

⁵ Most rituals with this rubric, including bilingual texts included in *mīs pī* rituals and the monolingual Akkadian texts, are associated with the *āšīpu*, “exorcist” or “incantation priest.” Those in Emesal are associated with the *kalû* “lamentation-priest.” According to Jean Bottéro, while the *kalû* functioned within the theocentric cult, the *āšīpu* had expertise in what he has called the “sacramental” cult, which he differentiates from the “theocentric cult” by its primary concern for the benefit of humans rather than the gods; see J. Bottéro, *Religion in Ancient Mesopotamia*, translated by Teresa L. Fagan (Chicago: University of Chicago Press, 2001), pp. 120–21, 170–202. Many of the vast number of first-millennium texts associated with the *āšīpu* prescribed ritual practices addressing deities on behalf of individuals. While the terms MAŠ.MAŠ / *mašmašu* have been taken as synonymous with *āšīpu*, in a paper presented at the present Rencontre, Mark Geller argued that ambiguities in the evidence make it difficult to judge whether such was the case or whether the *mašmašu* represented a distinct category of expert.

best attested corpus of rituals bearing it, those of the *āšipu* in monolingual Akkadian.⁶ While this rubric derives from a gesture used in prayer or greeting,⁷ its meaning is not immediately transparent. D. Shibata underscores the importance of the plain-sense meaning “hand-lifting” by pointing out that in the Emesal texts the one reciting the prayer actually raised his hand during the recitation.⁸ It is possible that a gesture of hand-lifting ordinarily accompanied the recitation of the monolingual Akkadian texts despite the fact that an explicit instruction to do so is rarely attested. Beyond the plain-sense meaning, however, many have proposed idiomatic translations of “prayer” and “petition-prayer.”⁹

Before asking how ŠU.IL₂.LA₍₂₎ might relate to the rituals it classifies, I want to ask whether it does in fact mean “prayer” of some sort, or something else. And if it means something else, does that give us a clue as to why this rubric was chosen to designate a class of ritual? Relevant to both questions, I will propose an interpretation of iconography in conjunction with textual evidence in order to argue for the existence of a convention of reciprocity in the exchange of hand-lifting gestures between client and patron.

Over a hundred years ago, in the introduction to his edition of Akkadian rituals bearing the rubric ŠU.IL₂.LA₍₂₎, Leonard King explained in a few sentences that this logogram and corresponding Akkadian expressions combining *qātu* (“hand”) and *našû* (“to lift”) had come to be synonymous with other Akkadian terms for “to pray” or “to utter a prayer.”¹⁰ For convenience, I refer to these Akkadian terms collectively as the “*qāta našû* cluster (of terms)” or, individually, as “*qāta našû* terms.” With some modification, King’s conclusion has enjoyed broad acceptance. Thus, whether occurring as a ritual rubric or in the context of a narrative representing a communicative act directed toward a deity, terms belonging to this cluster are generally glossed either as “prayer” or “petitionary prayer,” or “to pray,” and so forth.¹¹ I argue, however, that a combination of textual and iconographic evidence leads in a promising new direction of inquiry for specifying the semantic range of the *qāta našû* cluster of terms.

King supported his explanation with two claims: (1) that “the act of raising the hand is universally symbolical of invocation of a deity”; and (2) that the phrase *nīš qāti* “is often found in apposition to, or balancing, *ikribu*, *supû*, etc., and in many instances it can merely retain the general meaning of ‘prayer,’ or ‘supplication.’”¹² Indeed, aside from the *qāta našû* cluster, the Akkadian lexicon contains an array of terms corresponding to the English terms “prayer” or “petitionary prayer” taken broadly to refer to words addressed to a deity. For convenience, I refer to these as “undisputed prayer terms.”¹³

⁶ I have recently attempted to account for a significant aspect of the rationale by which this rubric was employed as a classifier in monolingual Akkadian rituals associated with the *āšipu*; see Frechette, “The Name of the Ritual.” The present paper in part further refines arguments made there with respect to iconography (ibid., pp. 63–88), and provides a significant basis for reconsidering prior interpretations of ŠU.IL₂.LA₍₂₎ as a classifier in monolingual Akkadian rituals. For an interpretation of these rituals convergent with the present paper, see “The Name of the Ritual,” pp. 113–90.

⁷ D. Shibata assembles and discusses occurrences of Sumerian ŠU “hand” combined with IL₂ “to lift” attested from the third and early second millennium B.C. (“Die Šuilla-Gebete,” pp. 12–17). He points out that such combinations had several different meanings and that the clear meaning of a greeting gesture is attested first in the Isin-Larsa period (ibid., p. 14). He also notes that the substantivized form ŠU.IL₂.LA₍₂₎ is attested frequently after the Old Babylonian period (ibid., p. 15).

⁸ “Die Šuilla-Gebete,” p. 12.

⁹ For interpretations of ŠU.IL₂.LA₍₂₎ and related terms, see n. 11 below.

¹⁰ L. King, *Babylonian Magic and Sorcery Being “The Prayers of the Lifting of the Hand”: The Cuneiform Texts of a Group of Babylonian and Assyrian Incantations and Magical Formulae Edited with Transliterations, Translations and Full Vocabulary from Tablets of the Kuyunjik Collections Preserved in the British Museum* (London: Luzac & Co., 1896), pp. xix–xx.

¹¹ The CAD glosses the relevant terms thus: *šullakku* as “a prayer: lit. ‘of raised hands’” (s.v. *šullakku*); *nīš qāti* as “lifting of the hands, prayer” (s.v. *nīšu* s. mng. 2); *qāta našû* as “to recite a prayer with hands uplifted” (s.v. *našû* A s. mng. 6 *qātu*). Annette Zgoll interprets the rubric ŠU.IL₂.LA₍₂₎ as “prayer”; see *Die Kunst des Betens: Form und Funktion, Theologie und Psychagogik in babylonisch-assyrischen Handerhebungsgebeten zu Ištar*, *Alter Orient und Altes Testament*

308 (Münster: Ugarit-Verlag, 2003), pp. 21–23. F. R. Kraus renders *nīš qāti* / *šullakku*, as “Bittgebet” based on an interpretation of the hand-lifting gesture as one of prayer; see Kraus, review of *Die akkadische Gebetsserie ‘Handerhebung,’* by Erich Ebeling in *Deutsche Literaturzeitung* 76 (1955): 504. W. R. Mayer cites Kraus’s interpretation and also offers ‘Gebet’ and ‘Bitte’ as possible translations; *Untersuchungen zur Formensprache der babylonischen Gebetsbeschwörungen*, *Studia Pohl, Series Maior* 5 (Rome: Pontificio Istituto Biblico, 1976), p. 7. As a rubric in *šuilla* rituals, Mayer’s translations consistently render the term as “Bittgebet.” See, for example, *Untersuchungen*, p. 447, line 23; p. 464, line 27; p. 472, line 20; p. 502, line 70. In his translation of *šuilla* incantations, however, Mayer does not assume that these terms mean “petition-prayer” but rather retains plain-sense translations in several cases. He translates “Handerhebung” twice: “Das Ritual BMS 12 mit dem Gebet ‘Marduk 5,’” *Orientalia* NS 62 (1993): 325, line 48; “Sechs Šu-ila-Gebete,” *Orientalia* NS 59 (1990): 464, line 22 (of “Nabû 6”). (While Mayer and others refer to the recited portion of Akkadian *šuilla* rituals as “incantation prayers,” the present paper refers to them simply as “incantations”; see n. 19 below.) He translates “erhebe ich die Hand” once: “Sechs Šu-ila-Gebete,” p. 457, line 5 (of “Marduk 16 [?]”). The individual incantations are identified in the present paper as in Mayer, *Untersuchungen*, pp. 376–435.

¹² King, *Babylonian Magic*, pp. xix–xx.

¹³ The following is a list of common “undisputed prayer terms” with which *qāta našû* terms occur in parallel: *teslītu* “appeal, prayer”; *supû* “prayer, supplication”; *sulû* “prayer”; *šulû* “supplication, prayer”; *ikribu* “prayer, dedication, blessing”; *unnīnu* “supplication, petition.” These spellings and definitions are taken from Jeremy Black, Andrew George, and Nicholas Postgate, *A Concise Dictionary of Akkadian*, 2nd (corrected) ed., *Santag Arbeiten und Untersuchungen zur Keilschriftkunde* 5 (Wiesbaden: Harrassowitz, 2000).

King's first claim, that a particular gesture in a context so vaguely defined enjoys a universal significance, would likely find little acceptance today, given the strong methodological current in cultural anthropology toward particularity.¹⁴ On the other hand, his interpretation of the usage of *qāta našû* terms in parallel with undisputed prayer terms has not been challenged and would seem to remain the key textual evidence behind the continued acceptance of his interpretation of the *qāta našû* cluster. In the only detailed study of such parallels of which I am aware, Mayer I. Gruber discusses numerous such parallels, and, like King, he interprets them as synonymous.¹⁵ However, even while accepting the translation of ŠU.IL₂.LA // *nīš qāti* as "petition-prayer," W. R. Mayer observes: "Die Gleichung ŠU.IL₂.LA // *nīš qāti* ist, soweit ich sehe, in Listen nur selten bezeugt (MSL 8/1, 19, 144; 13, 120, 194); die spezielle Bedeutung 'Gebet' liegt dort wohl nicht vor."¹⁶

While I acknowledge the importance of such parallels for assessing the semantic range of these terms, appealing to both textual and figural evidence I question the adequacy of interpreting them to be synonymous in the majority of cases. While *qāta našû* terms, in some cases, may have meant something more general like "to pray," I argue that the evidence leads to a more particular description of their semantic range. That is, I conclude that these terms indicate an action distinct from prayer. I make this argument based, in part, upon three tendencies I have discovered in a survey of occurrences of *qāta našû* terms as listed in the CAD and as edited in a number of recent publications. Furthermore, unlike King, who treated the gesture as that of the supplicant alone, I draw upon depictions of exchanges of auspicious hand-lifting gestures between a client and a patron (frequently a deity) in Mesopotamian figural art representing a variety of types of composition and media ranging from the Akkadian to the Neo-Assyrian periods. In light of the rationale of reciprocity which often underlies interaction between client and patron in the ancient Near East, I suggest that these exchanges would have been understood in the context of a convention by which the client's gesture was linked with the auspicious reciprocal gesture of the patron. "Lifting the hand," then, evokes not simply the behavior of the client, but also that of the patron.

From this evidence, I suggest that the *qāta našû* cluster would have referred to a formal salutation which served: (1) to establish the person's proximity to the deity being addressed; (2) to affirm the loyal servitude of the client; and (3) to prompt favorable recognition from the patron. I believe that the evidence presented here is adequate to warrant serious consideration of these more specific aspects of meaning for the *qāta našû* cluster. Still, given the limited scope of my investigation of the iconographic evidence, I offer this argument also as an invitation for more comprehensive inquiry, particularly in that regard.

I present the argument in three parts. First, I summarize the textual evidence for treating *qāta našû* terms as naming an activity discrete from "prayer." I then turn to the iconographic evidence in support of interpreting the *qāta našû* cluster as referring not to the client's gesture in isolation, but rather as linked to a convention by which a client's hand-lifting gesture toward a patron is reciprocated by the patron. I conclude with a suggestion as to how this argument may account, at least in part, for the rationale by which the *āšīpu* came to employ ŠU.IL₂.LA₍₂₎ as a rubric in the system of classifying the special knowledge, ultimately attributed to Ea/Enki, for dealing with what Bottéro calls the "sacramental" cult.

TEXTUAL EVIDENCE

In interpreting the textual evidence, I have inquired into the usage of the *qāta našû* cluster both broadly in various types of literature, as well as specifically in Akkadian rituals bearing the rubric ŠU.IL₂.LA₍₂₎. Drawing upon texts which included hemerologies, letters, royal inscriptions, and various rituals, I identified twenty-nine constructions, i.e., particular combinations of words, in which *qāta našû* terms occur in parallel with undisputed prayer terms. I

¹⁴ Anthropologists continue to discuss the notion of cultural universals, but King's assertion hardly fits this category. One important study proposes such universals to include such things as having religious or supernatural beliefs, rites of passage, and mourning rituals; see Donald E. Brown, *Human Universals* (Philadelphia: Temple University Press, 1991), p. 139. The lifting of the hand as signifying invocation of a deity represents a far more particular phenomenon than the universals proposed by Brown.

¹⁵ Mayer I. Gruber, *Aspects of Nonverbal Communication in the Ancient Near East*, 2 vols., Studia Pohl, Series Maior 12 (Rome: Pontificio Istituto Biblico, 1980), pp. 50–89.

¹⁶ Mayer, *Untersuchungen*, p. 7, "The equation of ŠU.IL₂.LA // *nīš qāti*, as far as I can see, is only seldom attested in lists; the precise meaning 'prayer' probably does not occur there" (English translation by the author).

sought to identify what, if any, patterns of usage might be observed and found three tendencies that suggest that *qāta našû* terms do not mean “prayer” or “to pray”:¹⁷

- (1) When occurring in parallel with undisputed prayer terms, in twenty-six of these twenty-nine constructions the *qāta našû* term occurs first in the sequence. This striking consistency suggests that the ancient usage treated *qāta našû* terms not as synonyms of the parallel terms, but rather as *logically prior* to them according to the native rationale.
- (2) In some cases, the parallel between a *qāta našû* term and a term for verbal speech clearly implies contrast rather than similarity. Such is the case in a well-attested phrase of the *bārû*: “whether by means of my speech (*qibītu*), the lifting of my hand(s) (*nīš qātīya*), (or) anything whatever I do (*mimma mala epēšu*), let there be a true verdict in the query I perform.”¹⁸
- (3) Verbs of speaking and hearing rarely occur with terms from the *qāta našû* cluster: whatever such a “hand-lifting” signified, one did not, with rare exception, “recite” it or “hear” it. Undisputed prayer terms, on the other hand, regularly occur with verbs of speaking and hearing, and this pattern provides further evidence of a native distinction between these terms and those of the *qāta našû* cluster.

These tendencies support the conclusion that *qāta našû* terms referred to an action considered logically prior to prayer, and that they designated something *offered, not spoken, and received, not heard*. Such an action is consistent with a means of establishing the proximity necessary for communication.

Among incantations to be recited within Akkadian rituals bearing the rubric ŠU.IL₂.LA₍₂₎,¹⁹ I compared the frequency of usage of the *qāta našû* cluster with that of undisputed prayer terms. A survey of these roughly seventy different incantations, some attested in multiple versions, shows a marked difference in frequency of usage between the two: while undisputed prayer terms occur quite regularly, *qāta našû* terms occur only six times.²⁰ Even W. R. Mayer, who consistently renders ŠU.IL₂.LA₍₂₎, when occurring as a rubric, as “petition-prayer,” does not use terms for “prayer” or “petition-prayer” in translating half of these six occurrences; he rather offers the plain-sense “hand-lifting” or “to lift the hand.”²¹ Thus, in these texts, which frequently employ a variety of terms for prayer, the *qāta našû* cluster was not employed with anything approaching the same frequency as were undisputed prayer terms. In half of the few cases in which *qāta našû* terms do occur, Mayer recognizes that they do not warrant a translation in terms of “prayer.”

THE EXCHANGE OF RECIPROCAL HAND-LIFTING GESTURES IN ICONOGRAPHY

Discussions of *šuilla* rituals often mention the depiction of hand-lifting in Mesopotamian iconography as a conventional gesture for prayer, focusing on the human who carries out this gesture. I would like to draw attention to the frequency, across periods and in various types of composition, with which auspicious hand-lifting gestures are depicted as exchanged between client and patron. In light of the rationale of reciprocity fundamental to the interaction between clients and patrons in ancient Mesopotamia, I propose that such frequency provides sufficient basis to warrant the provisional conclusion that such an exchange served as a convention which had a significant effect on the meaning of the *qāta našû* cluster of terms.

¹⁷ This section represents a summary of my more detailed analysis in “The Name of the Ritual,” pp. 88–100.

¹⁸ See, for example, Heinrich Zimmern, *Beiträge zur Kenntnis der babylonischen Religion: Die Beschwörungstafeln Šurpu, Rituultafeln für den Wahrsager, Beschwörer und Sänger*, Assyriologische Bibliothek 12 (Leipzig: J. C. Hinrichs, 1901), Nos. 75–78, lines 3', 10', rev. 61', 66', 74'.

¹⁹ Scholars have applied the term Gebetsbeschwörungen “incantation-prayers” to the recitations included in these and other rituals because such recitations typically appeal directly to the deity addressed but are generally introduced by the logogram EN₂ // *šiptu* “incantation.” For discussion of these texts, see I. Tzvi Abusch, “Mesopotamia,” in *Religions of the Ancient World: A Guide*, edited by Sarah Iles Johnston, Harvard University Press Reference Library (Cambridge: Belknap

Press, 2004); Mayer, *Untersuchungen*, pp. 1–37; Walter G. Kunstmann, *Die babylonische Gebetsbeschwörung*, Leipziger semitische Studien, n.F., 2 (Leipzig: J. C. Hinrichs, 1930), pp. 1–6. In a paper published in the present volume, W. G. Lambert addresses the difficulty of interpreting this logogram in connection with these recitations.

²⁰ Erich Ebeling, *Die akkadische Gebetsserie “Handerhebung” von neuem gesammelt und herausgegeben* (Berlin: Akademie Verlag, 1953), p. 148, line 21 (of “Sipazianna 1”); Mayer, *Untersuchungen*, p. 456, line 21 (of “Gula 1b”); twice in Mayer, “Das Ritual BMS 12,” pp. 318–20, lines 48, 79 (of “Marduk 5”); and Mayer, “Sechs Šu-ila-Gebete,” p. 456, line 5 (of “Marduk 16 [?]”), and p. 462, line 22 (of “Nabû 6”).

²¹ See n. 11, above, for citations.

Conceptually, the *qāta našû* cluster functioned within the context of an audience between client and patron, an interaction which was based upon the rationale of reciprocity. Moreover, within this context the lifting of the hand functioned as a convention of reciprocal greeting and related concepts. Annette Zgoll, in a recent article, and Friedhelm Hartenstein, in his forthcoming *Habilitation*, independently argue for the importance of the concept of the audience in understanding ancient Near Eastern relations between patrons (whether human rulers or deities) and clients.²² Zgoll points out that the principle of reciprocity governs the formal actions of the client and patron when the patron grants an audience to the client.²³ In making this observation, she echoes the lucid analysis made seventy-five years ago by Benno Landsberger concerning the close relationship among concepts of greeting, prayer, blessing, and reciprocity as he explained the semantic range of the verb *karābu*:

Die zahlreichen Adorationsszenen zeigen die Gegenseitigkeit des Gestus zwischen Mensch und Gott, Omina nach Art der ... *egerrû*-Orakel lehren, dass der fromme Beter den Gegengruss der Gottheit erwartet; dem *k.* des Menschen folgt als Lohn das *k.* Gottes.... Durch die Verpflichtung zum Gegengruss reiht sich vielleicht *karābu* den zwingenden Gesten und Formeln an.²⁴

Thus drawing attention to the reciprocal exchange of hand-lifting gestures in presentation scenes between human and deity, Landsberger went on to point out that the verb *karābu* explicitly describes the hand-lifting gestures of both human and divine agents.²⁵

Thus, a combination of lexical and iconographic evidence suggests the existence of a convention in which hand-lifting gestures by clients expressing greeting or accompanying prayer were imagined as reciprocated by patrons expressing greeting or blessing. Among figural representations spanning from the Akkadian to the Neo-Assyrian period we find an abundance of hand-lifting gestures which may be interpreted from context as auspicious communicative acts exchanged between patron and client (and/or the client's intermediary).²⁶ Such gestures encompass a broad range of position of hand and arm, and in many cases they may be specific to a particular situation. Still, depictions of the exchange of such gestures likely reflect this convention. Moreover, the frequency with which juxtaposition occurs would have both reflected and continued to shape a perception that such gestures on the part of humans toward deities were effective for prompting a favorable response from the deity. This is not to suggest that such a favorable response would have been considered automatic or predictable with certainty. Rather, depictions of such an exchange would have functioned as auspicious objects themselves serving, in part, to cultivate an anticipation of the best-case result from such gestures when carried out by clients.

I suggest that by the Old Babylonian period this convention had become established in iconography by means of a more visually apparent reciprocity and that thereafter it continued to function with an elasticity which allowed for less homology and perhaps considerable variety of arm position and accompanying elements. In iconography depicting exchanges of hand-lifting between client and patron, we find an abundance of instances in which the gestures exchanged tend to be rather visually homologous in the posture of hand and arm. Such homology would have affirmed visually the reliability of reciprocity in the client-patron relationship. Such exchanges of homologous gestures are attested frequently among presentation scenes, and among these, most widely among cylinder seals from between the Akkadian and Old Babylonian periods.²⁷ Moreover, I suggest that this convention would have acquired a place

²² Friedhelm Hartenstein, *Das Angesicht JHWHs: Studien zu seinem königlichen und kultischen Bedeutungshintergrund in den Psalmen und in Ex 32–34* (forthcoming); Zgoll, "Audienz."

²³ Zgoll, "Audienz," pp. 197–99.

²⁴ Benno Landsberger, "Das 'gute Wort'," *Mitteilungen der altorientalischen Gesellschaft* 4 (1930): 295. "The numerous presentation scenes show the reciprocity of gesture between human and god; omens of the type *egerrû*-oracles instruct that the pious worshiper await the reciprocal greeting of the deity; the *karābu* of a god follows the *karābu* of humans as a reward... By means of the obligation for reciprocal greeting perhaps *karābu* should be considered in the category of gestures and formulas which compel" (English translation by the author).

²⁵ Landsberger, "Das 'gute Wort'," p. 296.

²⁶ In her study of depictions of women from the Uruk/Jemdet Nasr and Early Dynastic periods, Julia M. Asher-Greve discusses hand-lifting gestures as expressing attitudes of prayer and greeting; *Frauen in altsumerischer Zeit*, *Bibliotheca Mesopotamica* 18 (Malibu: Undena, 1985). However, during these periods depictions of exchanges of such gestures

between anthropomorphic figures are rare and do not figure prominently in her study. For a list of the discrete body positions she describes, including the one she associates with ŠU.IL₂.LA₍₂₎, see *Frauen*, pp. 2–3. While she follows the line of scholarship which considers ŠU.IL₂.LA₂ an expression of prayer, she immediately notes the close relationship among concepts of prayer, blessing, greeting, praise, adoration in word and gesture as evidenced by the semantic range of the terms ŠU.MU₂.MU₂ // *karābu* (*Frauen*, p. 3). Moreover, she interprets some hand-lifting gestures as expressing greeting (*Frauen*, pp. 8 and 69).

²⁷ For examples of seals, see Dominique Collon, *Catalogue of the Western Asiatic Seals in the British Museum*, vol. 2, *Akkadian, Post Akkadian, Ur III Periods*, edited by Dominique Collon, D. J. Wiseman, and A. D. H. Bivar (London: Trustees of The British Museum, 1982), figs. 287, 288, 369–78, 438, and 469; Dominique Collon, *Catalogue of the Western Asiatic Seals in the British Museum*, vol. 3, *Isin-Larsa and Old Babylonian Periods*, edited by Dominique Collon, D. J. Wiseman, and A. D. H. Bivar (London: Trustees of The British Museum, 1986), figs. 2, 10, and 12; Martha Haussperger, *Die Einführungsszene: Entwicklung eines mesopotamischen Motivs von der*

in the way in which relations with the divine were imagined by the Old Babylonian period. Representations with relatively more homology in hand-lifting gestures between client and patron are also attested into the Neo-Assyrian period, including presentation scenes on *narûs* as well as other types of compositions and media.²⁸ Among depictions of the king receiving subordinates in Neo-Assyrian palace decoration, we find such homology between the king (seated or standing) and approaching officials.²⁹ Among such decorative compositions which include exchanges of hand-lifting between king and approaching figure, arm and hand position may be more or less homologous, and one or more objects may be depicted in the hand of the ruler.³⁰

Sketching this proposal in rather broad strokes, I hasten to point out that more research is needed. I have not attempted to specify either how such a convention in iconography might have been affected by combination with other schemes or how particular ways of depicting it may have developed diachronically. While art historians do refer to conventions of hand-lifting as salutation, prayer, petition, or intercession, they tend not to provide a rationale for applying one rather than another of these descriptors in a given case.³¹ What differentiates a gesture of salutation from one of prayer or petition? With the exception of the outdated study by S. Langdon,³² I have not found a detailed discussion of how particular elements in compositions allow for differentiation among these related concepts.³³ Benno Landsberger has articulated the close relationship among concepts of greeting, blessing, praying, and reciprocity in Mesopotamian culture as expressed by the semantic range of *karābu*.³⁴ If certain compositions might have emphasized greeting, one might look for elements which indicate forward motion in the client figure as signifying an initiation of communication. Yet, is it accurate to say, as does Haussperger,³⁵ that the feet of the client in many presentation scenes are striding? Moreover, are the so-called “introduction scenes” intended to depict the initiation of an encounter, and, if so, how might this be demonstrated?

Among the terms which would have entailed hand-lifting as a communicative act, I am suggesting that the *qāta našû* cluster and possibly other terms as well would have been understood in the context of this convention.³⁶

altakkadischen bis zum Ende der altbabylonischen Zeit, Münchener Universitäts-Schriften, Philosophische Fakultät 12; Münchener Vorderasiatische Studien 11 (Munich: Profil, 1991), figs. 25, 26, 49, 55, and 71.

²⁸ For examples of such presentation scenes found on *narû* (*kudurru*) monuments, see Kathryn E. Slanski, *The Babylonian Entitlement narûs (kudurru): A Study in Their Form and Function*, American Schools of Oriental Research Books 9 (Boston: American Schools of Oriental Research, 2003), pp. 47 and 218. Other types of composition and media include a commemorative stele dated to the ninth century (*BBS*, No. 34), and a (Neo-Assyrian or Neo-Babylonian) cylinder seal; Dominique Collon, *Catalogue of the Western Asiatic Seals in the British Museum, Cylinder Seals*, vol. 5, *Neo-Assyrian and Neo-Babylonian Periods*, with contributions by M. Sax and C. B. F. Walker (London: British Museum Press, 2001), fig. 229.

²⁹ For example, see Richard D. Barnett, Erika Bleibtreu, and Geoffrey Turner, *Sculptures from the Southwest Palace of Sennacherib at Nineveh* (London: British Museum, 1998), No. 26a (Throne Room I [B], slab 9).

³⁰ Barnett et al., *Sculptures from the Southwest Palace*, No. 435a (“Lachish” Room 36, slab 12); M. E. L. Mallowan, *Nimrud and Its Remains*, 2 vols. (London: Collins, 1966), fig. 209 (Ezida throne dais), pp. 446–49, figs. a, g (Fort Shalmaneser throne dais).

³¹ In discussing presentation scenes, Rudolf Mayr explains: “The gesture of *salutation* consists of holding one hand before the mouth. This was apparently the ancient Mesopotamian gesture of greeting and respect, analogous in some ways to a modern military salute. It is also the gesture of prayer”; “The Seal Impressions of Ur III Umma” (Ph.D. diss., Rijksuniversiteit te Leiden, 1997), p. 49. He does not discuss what might differentiate salutation from prayer, if indeed they might be distinguished. In the same work, while referring to the attendant figure standing behind the worshiper as “suppliant,” he calls the same figure’s raising of two hands a salutation gesture (“Seal Impressions,” p. 76). Irene Winter describes the raising of a hand to the mouth by a seated king in a presentation scene as seeming to

be a gesture of greeting; “The King and the Cup: Iconography of the Royal Presentation Scene on Ur III Seals,” in *Insight through Images: Studies in Honor of Edith Porada*, edited by Marilyn Kelly-Buccellati, Bibliotheca Mesopotamica 21 (Malibu: Undena, 1986), pp. 253–68, at 254. J. Börker-Klähn interprets the raising of two hands in several ways. In discussing the Ur-Nammu Stela, she considers the two lifted hands of a figure to constitute a greeting gesture; *Alt Vorderasiatische Bildstelen und vergleichbare Felsreliefs*, 2 vols., Baghdader Forschungen 4 (Mainz am Rhein: Philipp von Zabern, 1982), p. 43. However, in discussing the Gudea wall relief, she describes the raised hands of the figure behind Gudea as interceding (p. 26). Moreover, she allows that the raised hands of a figure in a particular Middle Babylonian stela might express either greeting or petition (p. 171).

³² Stephen Langdon, “Gesture in Sumerian and Babylonian Prayer: A Study in Babylonian and Assyrian Archaeology,” *Journal of the Royal Asiatic Society* (October, 1919): 531–56.

³³ Citing personal communication with J. Baer, D. Shibata offers a brief discussion of figural art to support a general distinction between the raising of one hand as a gesture of greeting and the raising of both hands as a gesture of prayer (“Die Šuilla-Gebete,” p. 12, n. 29).

³⁴ Landsberger, “Das ‘gute Wort,’” pp. 294–95.

³⁵ Haussperger, *Die Einführungsszene*, pp. 107 and 111.

³⁶ Expressions involving lifting of the hand in a communicative gesture include: *qāta ullû* “raise a hand” serves as a greeting in the Poor Man of Nippur (line 74); *labān appi* “stroke the nose” is interpreted as a gesture with the meaning “of praising and lauding of the gods” (see Ursula Magen, *Assyrische Königsdarstellungen, Aspekte der Herrschaft: Eine Typologie*, Baghdader Forschungen 9 [Mainz am Rhein: Philipp von Zabern, 1986], p. 61); *ubāna tarāšu* “stretch the finger” is interpreted as a “speech gesture” (Magen, *Assyrische Königsdarstellungen*, p. 53); *upnī petû* “open the fists, supplicate” (Gruber, *Nonverbal Communication*, pp. 50–59); *idī petû* “open the hands, pray” (Gruber, *Nonverbal Communication*, pp. 59–60); *qāta dekû* “lift the hand, entreat” (Gruber, *Nonverbal Communication*, pp. 84–89).

However, my argument here does not rely on an identification of certain verbal expressions with details of figural depictions as does, for example, the study of Ursula Magen.³⁷

CONCLUSIONS

I offer the following three points by way of summarizing the contribution of the present interpretation of the iconographic evidence toward an understanding of the semantic range of the *qāta našû* cluster.

- (1) This interpretation of the iconographic evidence affirms the fundamental importance of reciprocity in client-patron relations as expressed by an exchange of auspicious hand-lifting gestures and so places such expressions of hand-lifting on the part of the human in a cultural context that anticipates a reciprocal favorable action on the part of the deity. In this light, such hand-lifting can be seen as a specific strategy for prompting a favorable response from a deity.
- (2) The textual evidence demonstrates that *qāta našû* terms were not, in significant measure, synonyms for prayer but rather expressed something nonverbal which was regarded as logically prior to prayer, likely as an element for establishing proximity and presence to the deity. Interpreted in this way, such an exchange of hand-lifting can be likened to reciprocal visual contact between human and deity in Mesopotamia, the importance of which has been demonstrated.³⁸ The exchange of hand-lifting gestures, like visual contact, would have been imagined to establish presence-recognition between human and deity in Mesopotamian religion.
- (3) Putting these two points together, one may regard the *qāta našû* cluster as a set of terms that frequently describe a manner of salutation that was regarded as effective both for affirming loyalty to the deity addressed and for prompting a favorable reciprocal recognition and response from that deity.

If this is the case, then we can propose the following as an aspect of the rationale by which the *āšīpu* would have selected such a general term as “hand-lifting” to designate members of a class of rituals: If the “hand-lifting” of the human is to be viewed in a cultural context in which it was associated with the reciprocal favorable recognition of the deity and even regarded as auspicious and effective for prompting such a response, this perceived association provides a strategic reason for applying this term as a rubric to a class of ritual. Metaphorically, such a rubric would have associated the ritual so named with the effectiveness attributed to the term, thus anticipating a best-case reception by the deity. Whatever petition or inquiry may have been associated with such a “hand-lifting” ritual, either within it or within other rituals practiced in conjunction with it, would have benefited from such effectiveness.

³⁷ Magen, *Assyrische Königsdarstellungen*.

³⁸ Irene J. Winter, “The Eyes Have It: Votive Statuary, Gilgamesh’s Axe, and Catheted Viewing in the Ancient Near East,” in *Visuality*

before and beyond the Renaissance: Seeing as Others Saw, edited by Robert S. Nelson, Cambridge Studies in New Art History and Criticism (New York: Cambridge University Press, 2000), pp. 22–44.

THE AKKADIAN WORD FOR “THIRD GENDER”: THE *kalû* (gala) ONCE AGAIN

Uri Gabbay, Hebrew University, Jerusalem

1. EVIDENCE FOR GENDER AMBIGUITY OF THE *gala/kalû*

One of the most central figures in the Mesopotamian temple cult known from texts stemming from the Early Dynastic period up to the end of cuneiform literature in the last centuries B.C. is the *gala*, Akkadian: *kalû*, “lamentation singer.”¹ His physical features and gender identity have been widely discussed in Assyriological literature.² Textual and iconographical evidence have led many scholars to assume that the *gala* was of unique gender identity. The evidence may be briefly summarized as follows:

- (1) The *gala* was the performer of cult songs and prayers in Emesal, the “Women’s Dialect” of Sumerian.
- (2) As recognized by Steinkeller, the signs with which the word *gala* is written, UŠ, or better GĪŠ = penis and DÚR = anus,³ may indicate homosexuality.⁴
- (3) There are iconographical representations of beardless musicians who should probably be identified as *galas/kalûs*.⁵
- (4) As noted by Gelb, some Pre-Sargonic documents seem to allude to the fact that the term *gala* in these sources refers to a physical characteristic and not to a profession.⁶
- (5) “Gala” appears as a personal name in Pre-Sargonic and Sargonic documents, which I believe points to unique physical features (see below).⁷

¹ I thank Stefan Maul, Nathan Wasserman, Wayne Horowitz, and Hartmut Waetzoldt for their comments and suggestions. The responsibility for the views expressed in this article and any errors is of course entirely my own. In this article I will not discuss questions concerning eunuchs who were not *galas*; castrated *gerseqû* singers in Mari will be treated by N. Ziegler, *Les Musiciens et la musique d’après les archives de Mari*, *Florilegium marianum* 10 (forthcoming). In addition, I will not discuss the relation between the *gala/kalû* and Inanna/Ištar (see B. Groneberg, “Die sumerisch-akkadische Inanna/Ištar: Hermaphroditos?” *Welt des Orient* 17 [1986]: 25–46); this issue will be treated in the introduction to my forthcoming dissertation on the Eršemma prayers.

² The possibility of women serving as *galas* will not be discussed in this article; see G. Selz, *Untersuchungen zur Götterwelt des altsumerischen Stadtstaates von Lagaš*, Occasional Publications of the Samuel Noah Kramer Fund 13 (Philadelphia: University Museum, 1995), p. 109, and F. N. H. Al-Rawi, “Two Old Akkadian Letters Concerning the Offices of *kala’um* and *nārum*,” *Zeitschrift für Assyriologie* 82 (1992): 182–84.

³ For the second sign being DÚR (TUŠ) rather than KU, see R. D. Biggs, “The Abū Šalābīkh Tablets: A Preliminary Survey,” *Journal of Cuneiform Studies* 20 (1966): 77–78 n. 37.

⁴ P. Steinkeller (with hand copies by J. N. Postgate), *Third-Millennium Legal and Administrative Texts in the Iraq Museum, Baghdad*, Mesopotamian Civilizations 4 (Winona Lake: Eisenbrauns, 1992), p. 37. See similarly E. I. Gordon, *Sumerian Proverbs* (Philadelphia: University Museum, 1959), p. 248. The suggestion raised by J. Krecher, *Sumerische Kultlyrik* (Wiesbaden: Harrassowitz, 1966), p. 37, that the signs UŠ.KU could be read differently than /*gala*/, perhaps /*lagar*/,

based on a text which reads UŠ.KU-re is probably due to a wrong interpretation of the signs; see M. E. Cohen, “The Incantation-Hymn: Incantation or Hymn?,” *Journal of the American Oriental Society* 95 (1975): 610:17’ and n. on p. 611.

⁵ Admittedly, one cannot be sure that *all* beardless men in Mesopotamian art (especially in the third and second millennia) are to be regarded as eunuchs or hermaphrodites; cf. H. Scheyhing, “Das Haar in Ritualen des alten Mesopotamien,” *Welt des Orients* 29 (1998): 58–79.

⁶ I. J. Gelb, “Homo Ludens in Early Mesopotamia,” *Studia Orientalia* 46 (1975): 69–70.

⁷ See attestations mentioned by Gelb, “Homo Ludens,” pp. 66–67; and the references in the index of personal names in D. O. Edzard, *Sumerische Rechtsurkunden des III. Jahrtausends aus der Zeit vor der III. Dynastie von Ur*, Bayerische Akademie der Wissenschaften: Philosophisch-Historische Klasse, Abhandlungen, n.F., 67 (Munich: Verlag der Bayerischen Akademie der Wissenschaften, 1968), p. 203; see also K. Volk, “Eine bemerkungswerte nach-Fāra-zeitliche Urkunde,” *Orientalia* NS 57 (1988): 208 n. 17. Note especially ^mGala nar in Edzard, *Sumerische Rechtsurkunden*, p. 143, No. 87:17; if, as I assume, the personal name *Gala* relates to the physical appearance of its bearer as a hermaphrodite (see below), this would be similar to the case of a hermaphrodite serving as a *nar* singer as in the much debated Ur-Nanše statues, the *nar-maḥ* found in Pre-Sargonic Mari; see (with references) K. McCaffrey, “Reconsidering Gender Ambiguity in Mesopotamia: Is a Beard Just a Beard?,” in *Sex and Gender in the Ancient Near East*, Proceedings of the 47th Rencontre Assyriologique Internationale, Helsinki, July 2–6, 2001, part 2, edited by S. Parpola and R. M. Whiting (Helsinki: University of Helsinki Press, 2002), pp. 380–81.

- (6) Some galas/*kalûs* are mentioned in Pre-Sargonic and Old Babylonian texts in connection with classes of women, maids, and *harimtu*-women.⁸
- (7) The gala is sometimes mentioned in the same context with other functionaries of unique gender identity, such as kur-*ġar-ra*, sa \tilde{g} -ur-sa \tilde{g} , and pi-il-pi-li.⁹
- (8) In the myth Inanna's Descent to the Netherworld, Enki creates the kur-*ġar-ra* and the gala-tur-ra, creatures that, unlike regular human beings, can sneak into the Netherworld and free Inanna.¹⁰ Textual evidence suggests that the kur-*ġar-ra* was a figure of unique gender identity, and it is assumed that the myth refers to two creatures of unique gender that do not belong to the regular classes of mankind and can therefore cross the boundary into the Netherworld.¹¹
- (9) A group of Sumerian proverbs makes fun of the image of the gala, which would be in keeping with the treatment of a figure of irregular gender in society.¹²
- (10) Since one of the main roles of the gala/*kalû* was singing, a comparison with the *castrati* serving as cantors in liturgical contexts seems plausible.¹³

These points have led many scholars to suggest that the gala/*kalû* was a eunuch, an impotent man, a homosexual, or a cross dresser.¹⁴

2. THE ETYMOLOGY OF *kalû*

In his article "Homo Ludens in Early Mesopotamia," Gelb noted as follows:

... the past proposals to translate gala as 'eunuch,' while based on intuitive feelings, rather than clear-cut evidence, contain a certain amount of truth. The problem before us is not only to describe the functions of the gala, but also to find the underlying meaning of the word, if at all possible. The case may be paralleled by the term *igi-nu-du₈* of the Pre-Sargonic texts from Lagaš. The function of the *igi-nu-du₈* working in orchards is that of a gardener; the real meaning of the word is 'blind.'¹⁵ Similarly, the function of the gala is that of a cantor, wailer, lamenter, liturgist, psalmist, or whatever else we wish to call him; the underlying meaning of the gala is yet to be found.¹⁶

⁸ See Gelb, "Homo Ludens," pp. 70–73; R. Harris, *Ancient Sippar: A Demographic Study of an Old-Babylonian City (1894–1595 B.C.)*, Publications de l'Institut historique et archéologique néerlandais de Stambul 36 (Leiden: Nederlands Historisch-Archaeologisch Instituut te Istanbul, 1975), pp. 173, 332; Al-Rawi, "Two Old Akkadian Letters," p. 183 n. 22 (with references).

⁹ See, for example, K. Volk, *Die Balaġ-Komposition úru àm-ma-ir-ra-bi: Rekonstruktion und Bearbeitung*, Freiburger altorientalische Studien (Stuttgart: Franz Steiner, 1989), pp. 78–79:15–19, 83–84:47–59; P. Attinger, "Inana et Ebiġ," *Zeitschrift für Assyriologie* 88 (1998): 178–80:173–75; S. N. Kramer, *Sumerian Literary Texts from Nippur in the Museum of the Ancient Orient at Istanbul*, Annual of the American Schools of Oriental Research 23 (New Haven: American Schools of Oriental Research, 1944), pp. 45:5–9 (cited by J. Renger, "Untersuchungen zum Priestertum der altbabylonischen Zeit. 2. Teil," *Zeitschrift für Assyriologie* 59 [1969]: 192 n. 885); W. R. Sladek, "Inanna's Descent to the Netherworld" (Ph.D. diss., Johns Hopkins University, 1974), p. 131:222–26; cf. also M. Civil et al., *The Series lu-ša and Related Texts*, Materials for the Sumerian Lexicon 12 (Rome: Pontificum Institutum Biblicum, 1969), pp. 134–35:169 ff.

¹⁰ Sladek, "Inanna's Descent," pp. 131 f.:222 ff.

¹¹ See A. L. Oppenheim, "Mesopotamian Mythology III," *Orientalia* NS 19 (1950): 134–36; Sladek, "Inanna's Descent," pp. 87–99; S. M. Maul, "kurgarrû und assinnu und ihr Stand in der babylonischen Gesellschaft," in *Aussenseiter und Randgruppen: Beiträge zu einer*

Sozialgeschichte des alten Orients, edited by V. Haas, Xenia 32 (Constance: Universitätsverlag Konstanz, 1992), pp. 160–63.

¹² B. Alster, *Proverbs of Ancient Sumer*, vol. 1 (Bethesda: CDL Press, 1997), pp. 65–67:2.97–106, 259–60:21.D.2–4.

¹³ Al-Rawi, "Two Old Akkadian Letters," p. 183.

¹⁴ For example, Colonel Allotte de la Fuÿe, "Les UŠ KU dans les textes archaïques de Lagaš," *Revue d'Assyriologie* 18 (1921): 121; Oppenheim, "Mesopotamian Mythology III," pp. 135 f.; Gordon, *Sumerian Proverbs*, pp. 248–49; Gelb, "Homo Ludens," pp. 68–74; I. M. Diakonoff, "Ancient Writing and Ancient Written Language: Pitfalls and Peculiarities in the Study of Sumerian," in *Sumerological Studies in Honor of Thorkild Jacobsen on His Seventieth Birthday June 7, 1974*, edited by S. J. Lieberman, Assyriological Studies 20 (Chicago and London: University of Chicago Press, 1975), p. 115; W. G. Lambert, "Prostitution," in *Aussenseiter und Randgruppen*, p. 151; Steinkeller, *Third-Millennium Legal and Administrative Texts*, p. 37; Al-Rawi, "Two Old Akkadian Letters," p. 183 with n. 22; S. Parpola, *Assyrian Prophecies*, State Archives of Assyria 9 (Helsinki: University of Helsinki Press, 1997), p. 96 n. 138.

¹⁵ For blind people as workers, in gardens and elsewhere, in later periods as well, see W. Farber, "Akkadisch 'blind'," *Zeitschrift für Assyriologie* 75 (1985): 217–18, 221–23.

¹⁶ Gelb, "Homo Ludens," pp. 68 f.

I suggest that the meaning of the word *gala* could be found through etymological investigation, and, as supposed by Gelb, that the meaning is not directly associated with the function of the *gala*. Rather it is associated with his appearance or identity.

It is usually assumed that the Akkadian noun *kalû* is a loanword from Sumerian *gala*. However, Al-Rawi proposed the opposite: that the origin of the word is Akkadian, i.e., that Sumerian *gala* is a loanword from Akkadian *kalû*.¹⁷

There was another image in ancient Mesopotamia that clearly had a unique gender identity as well—the *kulu ʾu*. I do not suppose that it is a mere coincidence that the words *kalû* (earlier: **kala ʾu*¹⁸) and *kulu ʾu* refer to two individuals of unique gender identity and that they both share the same three radicals. I believe that both words share the same Semitic etymology.

I am not the first to assume a Semitic connection between these two nouns. Al-Rawi connected the words *kalû* and *kulu ʾu* and derived them both from the verb *kalû* “to hold back, to detain,” described by Al-Rawi as “the one turned into a ‘cantor’, designating a male prostitute.”¹⁹ Although I agree with Al-Rawi that Sumerian *gala* is a loanword from Akkadian and that the words *kalû* and *kulu ʾu* are to be etymologically connected, I do not find the derivation from the verb *kalû* “to hold back” convincing.

I suggest that the two nouns *kalû* and *kulu ʾu* are to be derived from a different Semitic root, which refers to the physical appearance of these two figures: *kl ʾ*, meaning “both.” This root is attested in Arabic *kilā*, Geʿez *kel ʾē*, and Ugaritic *kl ʾat*, all meaning “both.”²⁰ The same root also appears in the irregular Akkadian pronoun *kilallān*, “both,”²¹ as noted in von Soden’s *AHw*.²² The Hebrew word *kil ʾayîm*, derived from the same root, reveals a more specific meaning of this root. The word *kil ʾayîm* appears in the Hebrew Bible in the context of “two kinds,” or more specifically, “two species hybridized together.”²³ I propose that *kalû* and *kulu ʾu* should be derived from this root, *kl ʾ*, meaning “the one who is both,” i.e., “the one who is both sexes, male and female”—hermaphrodite.²⁴

Before turning to deal with *gala/kalû*, the main object of this investigation, I will briefly discuss the *kulu ʾu*.²⁵ Henshaw already proposed that the *kulu ʾu* should be seen as a hermaphrodite,²⁶ especially in regard to the following

¹⁷ Al-Rawi, “Two Old Akkadian Letters,” p. 183 n. 22.

¹⁸ Al-Rawi, “Two Old Akkadian Letters,” p. 184:10: *kā-la-ū-tām*, and syllabic spellings of *kalamāhu*; see Renger, “Untersuchungen,” p. 195 n. 907.

¹⁹ A similar etymology of the word *kulu ʾu* was already proposed by W. F. Albright, “Some Cruces in the Langdon Epic,” *Journal of the American Oriental Society* 39 (1919): 83, who understood the noun from the verb *kalû* “to prevent”: “perhaps as one excluded from sexual intercourse.”

²⁰ See, conveniently, the etymological sections in L. Koehler and W. Baumgartner (subsequently revised by W. Baumgartner and J. J. Stamm), *The Hebrew and Aramaic Lexicon of the Old Testament*, vol. 2 (Leiden: Brill, 1995), p. 475; and G. del Olmo Lete and J. Sanmartín (translated by W. G. E. Watson), *A Dictionary of the Ugaritic Language in the Alphabetic Tradition* (Leiden and Boston: Brill, 2003), p. 438.

²¹ See B. Landsberger quoted by H. Holma, *Die Namen der Körperteile in Assyrisch-Babylonischen* (Leipzig: A. Pries, 1911), p. 121 n. 2, who explains the basic form as the frozen dual **kilān*, to which a new dual marker was added, that is, **kilān-ān*, with a shift /n/>/l/ and the long vowel realized as a double consonant (cf. W. von Soden *Akkadisches Handwörterbuch* [Wiesbaden: Harrassowitz, 1959–81] [henceforth *AHw*.] s.v. *kilallān* 1b, where Old Babylonian spellings with an extra A-sign after the first two syllables are attested).

²² *AHw*. s.v. *kilallān*, etymological section. Is the same root attested also in C. J. Gadd, *Cuneiform Texts from Babylonian Tablets in the British Museum* 39 (London: British Museum, 1926), pl. 44:14: *ki-li* (Šumma Ālu tablet 104, cf. Lambert, “Prostitution,” p. 151)?

²³ See Koehler, Baumgartner, and Stamm, *Hebrew and Aramaic Lexicon*, vol. 2, p. 475.

²⁴ For the nature of hermaphroditism ascribed to the *gala/kalû* and the *kulu ʾu*, which I understand as a third gender and not necessarily as a physical feature, see below.

²⁵ As for morphology, I am not sure how to transliterate the word. Both dictionaries transliterate *kulu ʾu*, but a nominal **purus* pattern is not listed in W. von Soden, *Grundriss der Akkadischen Grammatik*³, *Analecta Orientalia* 33 (Rome: Pontificum Institutum Biblicum, 1995), § 55; the few words of this pattern found in the dictionaries are either by-forms of the *purus* pattern (e.g., *ṭuḫudu < ṭuḫdu, ḫubušu < ḫubšu, qudumu < qudmu, ṣupuru < ṣupru, šulutu < šultu*), forms very poorly attested (e.g., *luburu, mudulu, kuṣu ʾu*), or forms found only in peripheral Akkadian (e.g., *šububu, šubulu, šuḫuru, šukunu*). The word may be transliterated as *kulū ʾu* from the nominal *purūs* pattern, which denotes a noun derived from a verb or adjective; see von Soden, *Grundriss*, § 55,1, although, as pointed out to me by S. Maul, this pattern is not otherwise attested with reference to human beings. On nominal forms with the vowel *u* in the first syllable, cf. B. Kienast, *Historische semitische Sprachwissenschaft* (Wiesbaden: Harrassowitz, 2001), pp. 75 f.

A transliteration **kullu ʾu* from the nominal *purrusu* pattern is tempting, since this pattern refers to abnormal physical characteristics (H. Holma, *Die Assyrisch-Babylonischen Personennamen der Form quttulu mit besonderer Berücksichtigung der Wörter für Körperfehler*, *Annales Academiae Scientiarum Fennicae* B 13/2–4 [Helsinki: Suomalaisen Tiedeakatemia Kustantama, 1914]; see von Soden, *Grundriss*, § 55,n), but the word *kulu ʾu* is never attested with a reduplicated /l/.

²⁶ R. A. Henshaw, *Female and Male: The Cultic Personnel: The Bible and the Rest of the Ancient Near East*, Princeton Theological Monograph Series 31 (Allison Park: Pickwick, 1994), p. 300. See now A. George, “Babylonian Texts from the Folios of Sidney Smith, Part Three: A Commentary on a Ritual of the Month Nisan,” in *If a Man Builds a Joyful House: Assyriological Studies in Honor of Erle Verdun Leichty*, edited by A. K. Guinan et al., *Cuneiform Monographs* 31 (Leiden and Boston: Brill, 2006), pp. 175–77.

sentence from a late copy of a Middle Babylonian letter: *kulu ʾu lā zikaru šū*, “He is a *kulu ʾu*, not a male.”²⁷ This reference, in which the Assyrian king Ninurta-tukulti-Aššur is mocked by a Babylonian,²⁸ clearly shows that we are dealing with an individual portrayed as being of irregular gender identity who could have been understood as a male, but is explicitly said not to be one.²⁹

There is another source that indicates that the *kulu ʾu* was of unique gender identity: according to the Nineveh version of the Akkadian myth Ištar’s Descent to the Netherworld, Ea created an *assinnu*, and according to the Assur version a *kulu ʾu*, in order to release Ištar from the Netherworld.³⁰ The *assinnu* and *kulu ʾu*, together with the *kur-ġar-ra* and *gala-tur-ra* in the Sumerian myth Inanna’s Descent to the Netherworld, are all irregular beings who can enter the Netherworld and return due to their unique gender identity.³¹

Like *kulu ʾu*, the word *kalû*, from the same three radicals *kl ʾ* meaning “both,” is a substantivized adjective meaning “the one who is both,” i.e., “hermaphrodite.” The word *kalû* was loaned into Sumerian as *gala*,³² although there are syllabic indications that the word could be read as /gal/.³³ This seems to point to the Akkadian form **kal ʾum*, a *pars* nominal form or a *paras* substantivized adjective realized as *parsum* with case endings,³⁴ loaned into Sumerian without the *-um* nominative case as occurs frequently in the oldest loans from Akkadian into Sumerian.³⁵ The aleph at the end of the consonant cluster *kal ʾ* was either realized as /a/ in the form /gala/³⁶ or dropped in the form /gal/.³⁷ The form *gala* was re-loaned into Akkadian, and consequently we find syllabic forms reflecting **kala ʾum*³⁸ and not **kal ʾum*.³⁹ The word *gala/kalû* therefore primarily refers to the physical sexual features of the person or to his gender identity and not to his cultic function. Since the *gala* person had a cultic function in the temple, the word has come to designate that function, while the word of the same root *kulu ʾu* remained the term for the gender identity—“hermaphrodite” or “third gender.” However, it seems that the loanword *gala* still preserved its first meaning, since up to the Sargonic period we find individuals who bear the personal name *Gala*, which presumably refers to their external appearance or to their identity, a phenomenon well attested in Mesopotamian name-giving.⁴⁰

²⁷ J. Llop and A. R. George, “Die babylonisch-assyrischen Beziehungen und die innere Lage Assyriens in der Zeit der Auseinandersetzung zwischen Ninurta-tukulti-Aššur und Mutakkil-Nusku nach neuen keilschriftlichen Quellen,” *Archiv für Orientforschung* 48–49 (2001–02): 5:63’.

²⁸ Was this mockery, or could Ninurta-tukulti-Aššur actually have been a eunuch? (See n. 56 below; for eunuch kings, see Watanabe, “Seals of Neo-Assyrian Officials,” p. 320.)

²⁹ Note also Old Akkadian *kulu ʾus* who bore feminine names; see D. O. Edzard, review of *The Assyrian Dictionary of the University of Chicago*, vol. 8, ‘K’ and vol. 9, ‘L,’ *Zeitschrift für Assyriologie* 64 (1974): 125. That the term *kulu ʾu* could designate the physical features of a person and not merely his function may be seen from an Akkadian synonym list where five different functionaries of unique gender identity, *assinnu*, *pilpilû*, *kurgarû*, *ararû*, and *šudararû*, are all paired with *kulu ʾu*, probably indicating that *kulu ʾu* is a general concept referring to the physical features which were shared by these five functionaries; see CAD K s.v. *kulu ʾu* lex. section. See also the equation of *kulu ʾu(?)* and *assinnu* with *lú-ur-SAL* in a lexical list (Igituh; see CAD K s.v. *kulu ʾu* lex. section), which shows the same cultural concept of the third gender being “both sexes” (ur+SAL).

³⁰ R. Borger, *Babylonisch-Assyrische Lesestücke*², *Analecta Orientalia* 54 (Rome: Pontificum Institutum Biblicum, 1979), p. 100:92.

³¹ Maul, “*kurgarrû* und *assinnu*,” p. 163.

³² The syllabic reading **gu-la* in B. Landsberger et al., *Materialien zum sumerischen Lexikon 3* (Rome: Pontificum Institutum Biblicum, 1955), p. 175:518c (cf. CAD K s.v. *kalû* A discussion) should actually be read [g]a-la; see M. Civil et al., *The Series Ea = naqû*, *Materials for the Sumerian Lexicon 14* (Rome: Pontificum Institutum Biblicum, 1979), p. 52 (the reading was confirmed by collation, courtesy of J. Klein and Y. Sefati).

³³ See M. Civil et al., *The Series DIRI = (w)atru*, *Materials for the Sumerian Lexicon 15* (Rome: Pontificum Institutum Biblicum, 2004), p. 156:154: *ga-al UŠ.KU = kalû* and the use of the signs GAL. MAĜ for *kalamāhu* in late texts; see S. Langdon, *Babylonian Penitential Psalms*, Oxford Editions of Cuneiform Texts 6 (Paris: P.

Geuthner, 1927), pl. 16, K. 3228 rev. 6–7; and A. J. Sachs and H. Hunger, *Astronomical Diaries from 261 B.C. to 165 B.C.*, vol. 2 (Vienna: Verlag der Österreichischen Akademie der Wissenschaft, 1989), p. 126:8’ and p. 136:2’. For Akkadian /k/ loaned into Sumerian as /g/, see G. Steiner, “Akkadische Lexeme im Sumerischen,” in *Semitic and Assyriological Studies Presented to Pelio Fronzaroli by Pupils and Colleagues*, edited by P. Marrassini et al. (Wiesbaden: Harrassowitz, 2003), p. 636.

³⁴ von Soden, *Grundriss*, § 55,b, e.

³⁵ See Steiner, “Akkadische Lexeme im Sumerischen,” p. 631.

³⁶ For *parsu* and *pursu* forms loaned into Sumerian with an extra vowel between the second and third radicals, see Steiner, “Akkadische Lexeme im Sumerischen,” pp. 633 f., No. 21: *karmu* > *ga-ra-an*, No. 42: *puzru* > *buzru*, No. 43: *rakbu* > *ra(2)-gab*. For the disappearance of aleph in a Sumerian loanword, cf. No. 30: *manā ʾu* > *ma-na*.

³⁷ The plural form *gala-e-ne* (rather than **gala-ne*) indicates that the aleph could have remained in the Sumerian word; cf. D. O. Edzard, *Sumerian Grammar*, *Handbuch der Orientalistik 1/71* (Leiden and Boston: Brill, 2003), pp. 19–20.

³⁸ See n. 18 above.

³⁹ For loans from Akkadian to Sumerian and back to Akkadian in the semantic field of functionaries, cf. *wāšipu* > *išib* > *išippu*, and *šāpiru* > *šabra* > *šabrû*.

⁴⁰ For Akkadian names referring to external physical features, see J. J. Stamm, *Die Akkadische Namengebung*, *Mitteilungen der Vorderasiatisch-Aegyptischen Gesellschaft* 44 (Leipzig: J. C. Hinrichs, 1939), pp. 12–13, 264–67. For such names in Sumerian in the third millennium, see H. Waetzoldt, “Der Umgang mit Behinderten in Mesopotamien,” in *Behinderung als Pädagogische und Politische Herausforderung: Historische und systematische Aspekte*, *Schriftenreihe zum Bayerischen Schulmuseum Ichenhausen 14*, edited by M. Liedtke (Bad Heilbrunn: Verlag Julius Klinkhardt, 1996), pp. 77–91. Note, however, that Sumerian personal names may also simply be professional titles; see H. Limet, *L’anthroponymie sumérienne dans les documents de la 3^e dynastie d’Ur* (Paris: Société d’Édition “Les Belles Lettres,” 1968), p. 49.

3. CROSSING BOUNDARIES BETWEEN HUMAN AND DIVINE

The role of the *gala-tur-ra* in the Sumerian myth Inanna’s Descent to the Netherworld, in which he manages safely to enter the Netherworld owing to his unique gender identity, was mentioned above. On the mythological level, this gender identity is linked to the *gala*’s ability to cross the regular boundaries between human and divine. That the *gala*, or *gala-tur-ra*, was a creature created by Enki himself according to two different myths (Inanna’s Descent and an Old Babylonian *Balaḡ* section)⁴¹ is another indication of his unique character, again crossing the human frontiers toward the divine. The same theological idea is also applied in the realm of cult: the *gala/kalû*, being a hermaphrodite, that is, not belonging to the two common genders of mankind, is not limited by the regular barriers of mankind.⁴² Therefore he can act as mediator between human and god in cult, lamenting and praying over individuals and communities who do not themselves have the ability to cross the boundaries between human and divine as he does. Accordingly, he acts as their messenger and assuages the angry hearts of the gods for them.

4. NINŠUBUR

This theological perception, manifest in the realms of cult and mythology, is found in another instance: The *gala/kalû*, as messenger of the people to calm the hearts of the gods, crossing the boundary between human and divine but still in the realm of humanity, is reflected in another figure acting as a messenger who calms the hearts of the gods: Ninšubur. But unlike the human *gala/kalû*, Ninšubur stands in the realm of the gods and is a deity. Ninšubur is attested in an Old Babylonian Sumerian hymn as soothing the hearts of the gods in the Emesal dialect, using the same phrases uttered by the *gala* in Emesal cult songs and prayers:⁴³ “Let me soothe the heart! Let me soothe the spirit!” (*ša dè-em-ḥuḡ-e bar dè-em-ḥuḡ-e*). The same imagery is also found in a mythical section of an Old Babylonian *Balaḡ*, where, after Enki creates the *gala*, “the one of the heart-calming laments” (*mu-lu ér-ša-ḥuḡ-e*), Nunšubur is mentioned as the divine figure calming the heart of the goddess (*ša-zu ḥé-em-ḥuḡ-e*).⁴⁴

A clear connection between Ninšubur and the *gala* is also found in the beginning of the Sumerian myth Inanna’s Descent to the Netherworld. Before going down to the Netherworld, Inanna orders Ninšubur:

When I have arrived in the Netherworld, make a lament for me on the ruin mounds (*ér du₆-du₆-dam mar-mar-ma-ni-ib*). Beat the drum (*šëm*) for me in the sanctuary. Make the rounds of the houses of the gods for me (*é diḡir-re-e-ne niḡin-na-ma-ni-ib*).⁴⁵

But the cultic figure usually found in connection with these actions is the *gala*. The *gala* is known to make laments (*ér-ḡar/mar*) and to play the ŠĒM-drum.⁴⁶ He also circles (*niḡin*) the sanctuaries with the *balaḡ* instrument, as already seen in Ur III documents⁴⁷ and from the Eršemma and *Balaḡ*s, the *gala*’s repertoire, which mention the circling (*niḡin*)⁴⁸ of cities and sanctuaries.⁴⁹

⁴¹ Sladek, “Inanna’s Descent,” p. 131:223; and S. N. Kramer, “BM 29616: The Fashioning of the *gala*,” *Acta Sumerologica (Japan)* 3 (1981): 2f.:20ff.

⁴² The same idea also exists regarding the *kurgarrû* and *assinnu* as demonstrated by Maul, “*kurgarrû* und *assinnu*,” pp. 159–71.

⁴³ G. Zólyomi, “A Hymn to Ninšubur,” in “*An Experienced Scribe Who Neglects Nothing*”: *Ancient Near Eastern Studies in Honor of Jacob Klein*, edited by Y. Sefati et al. (Bethesda: CDL Press, 2005), p. 398 rev. 1’–7’.

⁴⁴ Kramer, “BM 29616,” p. 3:21, 30. Zólyomi, “A Hymn to Ninšubur,” p. 406, referring also to An-Anum I 39–40, where Ninšubur is listed with the epithet ^den-ḥuḡ and ^den-ḥuḡ-ḡá-dab₅.

⁴⁵ Sladek, “Inanna’s Descent,” p. 107:32–36.

⁴⁶ *šëm* or *ùb*, and Akkadian *ḥalḥallatu*.

⁴⁷ See W. Heimpel, “A Circumambulation Rite,” *Acta Sumerologica (Japan)* 20 (1998): 13–16. Cf. also the Neo-Assyrian mention of a kettledrum circling the sanctuaries in S. W. Cole and P. Machinist,

Letters from Priests to the Kings Esarhaddon and Assurbanipal, State Archives of Assyria 13 (Helsinki: University of Helsinki Press, 1998), No. 12 rev. 13–14.

⁴⁸ Cf. the Eršemma *dilmunki niḡin-na* known from Old Babylonian and first-millennium copies. See U. Gabbay, “Three Emesal Compositions Mentioned in Rituals,” *Nouvelles assyriologiques brèves et utilitaires* 2005/65, p. 71 n. 11. As noted by Heimpel, “A Circumambulation Rite,” p. 15, wandering about (*niḡin*) also occurs in other *Balaḡ*s; see, for example, the *Balaḡ* section *ki-ir-ra àm-niḡin-e-en àm-niḡin-e-en* (Cohen, *Canonical Lamentations*, vol. 1, pp. 55–57). Note also Cohen, *Canonical Lamentations*, vol. 1, p. 302:c+115 (cf. 280:e+163, 355:a+179): *balaḡ é niḡin-na*.

⁴⁹ In the next lines of Inanna’s Descent, Inanna orders Ninšubur to lacerate (*ḥur*) her eyes (*i-bí*), her nose (*kir₄*), and her buttocks (*ḥaš₄-gal*). Cultic laceration of the buttocks is an act done by the *gala* according to a Sumerian proverb (although using different terminology: *bīd—zé-er*; see Alster, *Proverbs*, vol. 1, p. 65:2.100).

The connection between Ninšubur and the gala/*kalû* is also found on the lexical level—in their titles. Ninšubur is given the title lagar, Emesal la-bar.⁵⁰ Likewise, *kalû* is equated with the nouns lagar and la-bar.⁵¹

It is therefore not surprising that the gender of Ninšubur is ambiguous, sometimes portrayed as male and sometimes as female.⁵² Heimpel argued that Ninšubur does not appear in the same context as both male and female, but rather that the name Ninšubur may represent several gods, some of which are male and others female.⁵³ Nevertheless, the sentence: “she? [wear]s male clothes on her [right side] ... she? wears female clothes on her [left side],”⁵⁴ found in a Sumerian composition concerned with Ninšubur, seems to point to a unique gender identity of this deity in one single context. If Ninšubur is the divine mirror-image of the human gala, whose gender identity is ambiguous, Ninšubur’s identity should be ambiguous as well.

5. THIRD GENDER

I have suggested that gala should be lexically understood as “hermaphrodite” according to the etymology of the Semitic root *kl*ʔ. I have also argued that on the mythological level this understanding corresponds to the image of the deity Ninšubur. But there are still a few problems: first, there are many galas and *kalûs* known throughout Mesopotamian history; however, physiologically, hermaphroditism is not at all a common phenomenon.⁵⁵

The term gala/*kalû* should be understood as a general concept, relating to a third gender which shares features of both female and male, but which is an independent gender category.⁵⁶ This class contains both physiologically born hermaphrodites as well as castrated persons, or even people whose mental identity is androgynous, such as transvestites, cross dressers, and effeminate individuals, some of whom may also serve as prostitutes playing the passive role.⁵⁷ This phenomenon is paralleled by the role of the *Hijras* in India, who are individuals of a third or alternative gender, consisting of born hermaphrodites, emasculated males, and effeminate persons, engaged at times in prostitution, who remain a feature of modern Indian cult and society.⁵⁸

⁵⁰ F. A. M. Wiggermann, “Nin-šubur,” *Reallexikon der Assyriologie* 9, edited by D. O. Edzard et al. (Berlin: Walter de Gruyter, 2001), p. 497.

⁵¹ See M. K. Schretter, *Emesal-Studien: Sprach- und literaturgeschichtliche Untersuchungen zur sogenannten Frauensprache des Sumerischen*, Innsbrucker Beiträge zur Kulturwissenschaft Sonderheft 69 (Innsbruck: Institut für Sprachwissenschaft der Universität Innsbruck, 1990), p. 201, Nos. 206, 208; and Krecher, *Sumerische Kultlyrik*, p. 37 with n. 103. For the reference to a possible reading of UŠ.KU as /lagar/, see n. 4 above and J. Renger, “Untersuchungen,” p. 122 n. 614d.

⁵² See Wiggermann, “Nin-šubur,” p. 491.

⁵³ W. Heimpel, “The Lady of Girsu,” in *Riches Hidden in Secret Places: Ancient Near Eastern Studies in Memory of Thorkild Jacobsen*, edited by T. Abusch (Winona Lake: Eisenbrauns, 2002), p. 156.

⁵⁴ [á-zi-da]-na túg-nita bí-in-[mu₄ x x x x á-gùb]-bu-na túg-munusa bí-in-mu₄ [x x x x]; see Å. W. Sjöberg, “Miscellaneous Sumerian Texts, III,” *Journal of Cuneiform Studies* 34 (1982): 72:3’–4’ (see Wiggermann, “Nin-šubur,” p. 491).

⁵⁵ Although not very rare either, especially since hermaphroditism is a genetic disorder, and since in ancient societies surgery or hormone treatment were not performed on such individuals, as is done today; see G. Leick, *Sex and Eroticism in Mesopotamian Literature* (London: Routledge, 1994), p. 158. Physiological hermaphroditism is a general name for several phenomena and disorders, some noticed at birth and others at puberty; see H. W. Jones, Jr., and W. W. Scott, *Hermaphroditism: Genital Anomalies and Related Endocrine Disorders* (Baltimore: Williams & Wilkins, 1958).

⁵⁶ For third (and fourth) gender in Mesopotamia, see J. M. Asher-Greve, “The Essential Body: Mesopotamian Conceptions of the Gendered Body,” *Gender and History* 9 (1997): 438 and 453.

⁵⁷ The logogram UŠ.DÚR may refer to this (see above). Note that the *assinnu* was also engaged in prostitution; see Lambert, “Prostitution,” pp. 151 f.; and Maul, “*kurgarrû* und *assinnu*,” pp. 162 f.

The term *kulu’u*, discussed above, included castrated persons, as indicated by the phrase *kî ana kulu’i itûru*, “when he turned into a *kulu’u*”; see Llop and George, “Die Babylonisch-assyrisch Beziehungen,” p. 5:64’ (see *ana ša rēšēn utâr/utarrûš* in the Middle Assyrian Laws §§ 15, 20).

For eunuchs and hermaphrodites as a general category in different cultures, not restricted only to the physical sphere of the primary meanings of the words, see M. Horstmanshoff, “Who is a True Eunuch? Medical and Religious Ideas about Eunuchs and Castration in the Works of Clement of Alexandria,” in *From Athens to Jerusalem: Medicine in Hellenized Jewish Lore and in Early Christian Literature*, edited by S. Kottek et al., *Pantaleon reeks* 33 (Rotterdam: Erasmus, 2000), pp. 101–14; and J. Levinson, “Cultural Androgyny in Rabbinic Literature,” in *From Athens to Jerusalem*, pp. 119–40 (esp. pp. 127 f.). For a general discussion on third genders, see G. Herdt, “Introduction: Third Sexes and Third Genders,” in *Third Sex, Third Gender: Beyond Sexual Dimorphism in Culture and History*, edited by G. Herdt (New York: Zone Books, 1996), pp. 21–81.

⁵⁸ S. Nanda, *Neither Man nor Woman: The Hijras of India* (Belmont: Wadsworth, 1990); and S. Nanda, “Hijras: An Alternative Sex and Gender Role in India,” in *Third Sex, Third Gender*, pp. 373–417 and 579–82. The categorization of hermaphroditism as a third gender is also found in early Rabbinic literature (first centuries A.D.); see *Mishnah Bikkurim* 4:5, concerning instances when the law is different between men and women: “Rabbi Meir says: The *Androgynus* is a being of its own, and the scholars could not decide regarding him whether he is man or woman. But the *tumtum* [= a person whose genitals are hidden] is not so: sometimes he is man and sometimes he is woman.”

The second problem is the main argument raised by scholars against the identification of *galas* as hermaphrodites or eunuchs: the economic and administrative texts tend to contradict the idea of a special gender class, since in these texts we often find *galas* having children.⁵⁹

6. ADOPTION AMONG *kalûs*?

It may be that the *galas* were originally hermaphrodites and that later the term *gala*, although etymologically denoting hermaphroditism, was used only for the religious functionary in the temple who may have not always been a hermaphrodite, or that not all *galas* were hermaphrodites.⁶⁰ In addition, if we understand the *galas* to be androgynous in terms of gender identity and not only in physiological features, they could have married and had children for inheritance purposes and in order to have someone perform their *kispu* funerary rites after their death. If, as proposed above, some of the *galas* were not born hermaphrodites but were castrated persons, they may have had children before their castration.⁶¹ It is also reasonable, as proposed by some scholars, that the “children” of *galas* mentioned in documents and colophons were not biological children,⁶² but rather adopted children or trainees of a guild of *galas*.⁶³ Two Old Babylonian documents may demonstrate adoption among *kalûs*.

First is an unpublished Old Babylonian Isin letter, cited by Wilcke,⁶⁴ probably written by the *kalamāḥum* Ur-Nin-isina, which contains the following passage: “Concerning what you [wrote to me] on a tablet, thus you: ‘I beg[ot you], raised you, and [supported] your father!’ You write to me that I [do not acknowledge] that you begot me and [raised me] and supported my father! (Indeed) it was you who begot me ... you instructed [me] in the art of the cantor (*kalûtam*) ... from the time I was young until ...” Even though these are not the regular adoption formulae known to us from legal contexts, this text seems to refer to an adoption of a *kalû* by another *kalû*, or to a very close apprenticeship which uses formulas of begetting and raising (*walādum* and *rabûm*).

In the second text, adoption may also be involved, regarding the genealogy of the family of Inanna-mansum, *kalamāḥum* of Annunītum at Sippar-Amnānum in the Old Babylonian period. This text, published by Janssen, deals with the inheritance of Inanna-mansum to his four children: “To whom should I divide the inheritance? This Kubburum is the son of Warad-Mamu, the servant of Esagil-[mansum], the ...; Ilī-iqīšam is the son of the sister of the daughter-in-law of Ku...ia; and Ḫuzālum is the son of a female resident of the dwelling-place of the maid of a sanga-priest of Šarpanītum. I will not divide the inheritance among them! Ur-Utu my son is the one who received my scepter from me! It is he who will *acquire* everything!”⁶⁵ Janssen concludes that this “genealogy” was uttered by Inanna-mansum as an insult, and although these figures, said to be the parents of the three brothers, may exist, they were not actually their real parents.⁶⁶ I suggest that this text may imply that the sons were actually adopted and that Inanna-mansum uses their true genealogy as an insult.⁶⁷

⁵⁹ See, for example, T. Jacobsen apud Gordon, *Sumerian Proverbs*, p. 483; Krecher, *Sumerische Kultlyrik*, p. 36 with n. 99; Renger, “Untersuchungen,” pp. 192–93.

⁶⁰ See Diakonoff, “Ancient Writing,” p. 115 n. 31; Al-Rawi, “Two Old Akkadian Letters,” p. 183.

⁶¹ See Gelb, “Homo Ludens,” p. 69.

⁶² As shown by Pomponio, *dumu* in Ur III texts does not always mean biological son and can also refer to a subordinate rank of a functionary; see F. Pomponio, “Lukalla of Umma,” *Zeitschrift für Assyriologie* 82 (1992): 169 n. 1 (reference courtesy of L. Verderame). Compare also *dumu-dumu gala* in Fāra texts; see F. Pomponio and G. Visicato, *Early Dynastic Administrative Tablets of Šuruppak* (Naples: Istituto Universitario Orientale di Napoli, 1994), p. 63.

⁶³ Gelb, “Homo Ludens,” p. 69; Gordon, *Sumerian Proverbs*, p. 248; Lambert, “Prostitution,” p. 151.

For married eunuchs and eunuchs adopting children in other periods and civilizations, see H. Tadmor, “Was the Biblical *sārfs* a Eunuch?” in *Solving Riddles and Untying Knots: Biblical, Epigraphical, and Semitic Studies in Honor of Jonas C. Greenfield*, edited by Z. Zevit et al. (Winona Lake: Eisenbrauns, 1995), p. 321 n. 17. Note also *Mishnah Yebamot* 8:6 where instances of born-eunuch and hermaphrodite priests marrying women who are not from the priestly tribe are dis-

cussed. Unlike eunuchs of the royal court who could not marry and have children for political reasons (loyalty to the king; see K. Deller, “The Assyrian Eunuchs and Their Predecessors,” in *Priests and Temples in the Ancient Near East*, p. 307), the reason for the emasculation of *galas* was religious and so there was no reason for them not to marry and adopt children.

⁶⁴ C. Wilcke, “Liebesbeschwörungen aus Isin,” *Zeitschrift für Assyriologie* 75 (1985): 189f.

⁶⁵ C. Janssen, “Inanna-mansum et ses fils: Relation d’une succession turbulente dans les archives d’Ur-Utu,” *Revue d’Assyriologie* 86 (1992): 22:12–17 (see translation on pp. 24f. and note on p. 27).

⁶⁶ Janssen, “Inanna-mansum et ses fils,” pp. 34 with n. 38.

⁶⁷ Could Inanna-mansum’s words imply that Kubburum, Ilī-iqīšam, and Ḫuzālum were adopted children and that Ur-Utu was his biological son, born before Inanna-mansum’s castration? For another case of adoption within the same family, see K. van Lerberghe and G. Voet, “A Poor Man of Sippar,” *Altorientalische Forschungen* 24 (1997): 148–57. For a different understanding, see now L. Barberon, “Quand la mère est une religieuse: Le cas d’Ilša-hegalli d’après les archives d’Ur-Utu,” *Nouvelles assyriologiques brèves et utilitaires* 2005/89, pp. 94–95.

7. CONCLUSION

Many questions concerning the *gala/kalû* still remain open. One must keep in mind that different aspects of this figure surely changed during a period of over two thousand years. In addition, while much can be said about the gender identity of the *gala/kalû* by examining literary and religious texts, the administrative and daily data are laconic, offering hardly any clues regarding this issue. Still, the Semitic etymology of *gala/kalû* and *kulu ʾu*—“the one who is both (sexes),” that is, “third gender”—is supported by other textual evidence presented in this article.

ON THE ALPHABETIC SCRIBAL CURRICULUM AT UGARIT*

Robert Hawley, University of Michigan

INTRODUCTION

This paper attempts to formulate a viable theoretical approach to the interpretation of the corpus of Ugaritic texts which reflect scribal education. It is ultimately intended as a contribution to the ongoing project of the Franco-Syrian Mission de Ras Shamra to republish the Ugaritic texts by literary genre and on the basis of renewed systematic collation, and, in this case, to the preparation of a volume devoted to the school texts.¹ The epigraphic portion of the project is nearing completion: over twenty of the Ugaritic school texts conserved in the museums of Syria and France have been copied and collated over the course of four summer-long study seasons, from 2001 to 2005. In moving beyond epigraphy, however, and in the direction of a synthetic overview of the local school curriculum, it quickly became clear that Ugaritologists have little choice but to begin by following in the footsteps of Assyriologists who have already done a good deal of work on this subject.²

1. A MESOPOTAMIAN ANALOGY?

In the 1991 publication of his doctoral dissertation, Wilfred van Soldt included a seven-page appendix on the lexical texts from Ugarit,³ in which he discussed among other things, “the curriculum which the scribes had to follow in studying Sumerian and Akkadian.”⁴ His two methodological points of departure are stated explicitly: “[The] order [of texts studied] can be determined from catchlines at the end of texts or from tablets which contain more than one text.”⁵ He then offers the following reconstruction:⁶

[alph.?] [→?] tu-ta-ti → Sal/(Svo) → Sa/(SaV) + appendix →? G [→?] Ḫḫ → Lu [→] Izi → Diri

* Dennis Pardee’s careful reading of an earlier draft of this paper allowed me to correct several errors. In the discussion following the delivery of the paper, Peter T. Daniels, Dominique Charpin, Wilfred van Soldt, Baruch Levine, and Ignacio Márquez Rowe offered clarifications and helpful comments on several matters. Needless to say, remaining errors are solely my own responsibility.

¹ On this project, see Pierre Bordreuil and Dennis Pardee, “L’*épigraphie ougaritique: 1973–1993*,” in *Le pays d’Ougarit autour de 1200 av. J.-C., Histoire et Archéologie: Actes du Colloque International à Paris, 28 juin–1^{er} juillet 1993*, Ras Shamra-Ougarit 11, edited by Marguerite Yon et al. (Paris: Éditions Recherche sur les Civilisations, 1995), p. 28; and Dennis Pardee, “La réédition des textes ougaritiques,” in *Actes de la table ronde internationale “Ras Shamra-Ougarit: du Bronze moyen au Bronze récent: nouvelles perspectives de recherche,” à Lyon, 30 novembre–1^{er} décembre 2001*, Travaux de la Maison de l’Orient, edited by Yves Calvet (Lyon and Paris: Maison de l’Orient Méditerranéen and de Boccard, forthcoming).

² For useful surveys of previous scholarship on the broader subject of Mesopotamian school curricula, see Niek Veldhuis, “Elementary Education at Nippur: The Lists of Trees and Wooden Objects” (Ph.D. diss., Groningen University, 1997), pp. 5–6 (and *passim*); and Petra Gesche, *Schulunterricht in Babylonien im ersten Jahrtausend vor Christus*, *Alter Orient und Altes Testament* 275 (Münster: Ugarit-Verlag, 2000), pp. 9–27, both with bibliography.

³ Wilfred van Soldt, *Studies in the Akkadian of Ugarit: Dating and Grammar*, *Alter Orient und Altes Testament* 40 (Kevelaer and Neukirchen-Vluyn: Butzon & Bercker and Neukirchener Verlag, 1991), pp. 747–53.

⁴ Van Soldt, *Akkadian of Ugarit*, p. 750. On the subject of Mesopotamian scribal traditions at Ugarit, note also Jean Nougayrol, “L’influence babylonienne à Ugarit, d’après les textes en cunéiformes classiques,” *Syria* 39 (1962): 28–35; Anson Rainey, “The Scribe at Ugarit: His Position and Influence,” *Proceedings of the Israel Academy of Sciences and Humanities* 3/4 (1968): 126–47; J. Krecher, “Schreiberschulung in Ugarit: Die Tradition von Listen und sumerischen Texten,” *Ugarit Forschungen* 1 (1969): 131–58; and Manfred Dietrich, “Die Sprachforschung in Ugarit,” in *History of the Language Sciences*, *Handbücher zur Sprach- und Kommunikationswissenschaft* 18/1, edited by Sylvain Auroux et al. (Berlin and New York: Walter de Gruyter, 2000), pp. 15–16, with some recent bibliography.

⁵ Van Soldt, *Akkadian of Ugarit*, p. 750.

⁶ Van Soldt, *Akkadian of Ugarit*, p. 751, using the following abbreviations: Sal = Silbenalphabet A (or Syllable Alphabet A); Svo = Silbenvokabular A (or Syllable Vocabulary A); Sa = Syllabary A; SaV = Syllabary A Vocabulary; G = Weidner God List (or “liste AN”); Ḫḫ = Ḫar.ra = ḫubullu (or Ur₅-ra ḫubullu). On these lists in general, see Antoine Cavigneaux, “Lexikalische Listen,” *Reallexikon der Assyriologie* 6 (Berlin and New York: Walter de Gruyter, 1983), pp. 609–41.

The first element in this chain illustrates the suggestion that the traditional Mesopotamian cursus as practiced at Ugarit was preceded by training in alphabetic writing. Such a view is supported by at least two considerations: (1) it agrees with the principle of an increasing level of difficulty,⁷ and (2) it seems confirmed by RS 22.225 (KTU² 1.96),⁸ a tablet which contains two texts: an incantation in Ugaritic on one side,⁹ which ought to belong to an advanced stage of the alphabetic curriculum, and the syllabary Tu-ta-ti on the other,¹⁰ which ought to belong to an elementary stage of the Mesopotamian curriculum.

Van Soldt was well aware of other tablets which combined Mesopotamian and local alphabetic school texts, however. RS 20.148+ (KTU² 5.16),¹¹ for example, also contains multiple texts: an excerpt of the Ras Shamra Grammatical Text copied three times,¹² with interspersed Ugaritic abecedaries. This situation is thus quite different from that of RS 22.225: in RS 20.148+ we find an exercise in Mesopotamian cuneiform of an intermediate to fairly advanced level combined with Ugaritic exercises of an introductory, elementary level. It was perhaps counter-examples such as this which led van Soldt to revise his proposal for the Ras Shamra curriculum in his 1995 article on scribal education at Ugarit, in which the alphabetic curriculum is no longer postulated as preceding the Mesopotamian curriculum in the local schools.¹³

Another important contribution of van Soldt's 1995 article is the explicit inclusion of omen compendia and literary compositions within the scholastic curriculum.¹⁴ Van Soldt pointed out that the presence of parallel texts from other sites shows that these works were part of a wider "canon" of traditional texts, and not original local compositions. Furthermore, their archival distribution indicates a consistent link with lexical tablets. Finally, the level of proficiency in these texts is characterized as generally low.¹⁵ Taken together, these factors suggest that the copying and recopying of Mesopotamian omen compendia, incantations, and literary works at Ugarit as elsewhere was part of a more advanced level of scribal training, beyond the learning of syllabaries, logogram lists, and text structure. In more general terms, such a broader view of the curriculum fits well with Oppenheim's memorable dichotomy, which distinguished texts representing the stream of scribal tradition on the one hand, from those reflecting mundane day-to-day activities on the other.¹⁶ If "it was considered an essential part of the training of each scribe to copy faithfully

⁷ See Wilfred van Soldt, "Babylonian Lexical, Religious and Literary Texts and Scribal Education at Ugarit and Its Implications for the Alphabetic Literary Texts," in *Ugarit: Ein ostmediterranes Kulturzentrum im Alten Orient: Ergebnisse und Perspektiven der Forschung, I. Ugarit und seinem altorientalische Umwelt*, Abhandlungen zur Literatur Alt-Syrien-Palästinas 7, edited by Manfred Dietrich and Oswald Loretz (Münster: Ugarit-Verlag, 1995), p. 172: "The lexical texts are not all of the same level of difficulty. As one would expect, their arrangement is didactic, that is, they tended to be studied in an order which ensured a progressive level of difficulty."

⁸ For the material details of RS 22.225, see Pierre Bordreuil and Dennis Pardee, *La trouvaille épigraphique de l'Ougarit*, Ras Shamra-Ougarit 5, vol. 1: *Concordance* (Paris: Éditions Recherche sur les Civilisations, 1989), p. 284 and fig. 36 (hereafter *TEO* 1); Manfred Dietrich et al., *The Cuneiform Alphabetic Texts from Ugarit, Ras Ibn Hani and Other Places (KTU: second, enlarged edition)*, Abhandlungen zur Literatur Alt-Syrien-Palästinas und Mesopotamiens 8 (Münster: Ugarit-Verlag, 1995) (hereafter *KTU*²).

⁹ The Ugaritic text was published by Charles Virolleaud, "Un nouvel épisode du mythe ugaritique de Baal," *Comptes Rendus de l'Académie des Inscriptions et Belles-Lettres* (1960): 180–86. That the text is essentially concerned with "the (Evil) Eye" and that its literary genre is incantatory was demonstrated by Gregorio del Olmo Lete, "Un conjuro ugarítico contra el 'mal ojo' (KTU 1.96)," *Anuario de Filología* 15 (1992): 7–16; abundant comparative parallels were provided by J. N. Ford, "'Ninety-nine by the Evil Eye and One from Natural Causes': KTU² 1.96 in its Near Eastern Context," *Ugarit Forschungen* 30 (1998): 201–78.

¹⁰ For the syllabic text, see Jean Nougayrol, "'Vocalises' et 'syllabes en liberté' à Ugarit," in *Studies in Honor of Benno Landsberger on His Seventy-fifth Birthday, April 21, 1965*, Assyriological Studies 16,

edited by Hans G. Güterbock and Thorkild Jacobsen (Chicago: University of Chicago Press, 1965), pp. 29–31.

¹¹ *TEO* 1, p. 236.

¹² See Miguel Civil and Douglas A. Kennedy, "Middle Babylonian Grammatical Texts," in *The Sag-Tablet, Lexical Texts in the Ashmolean Museum, Middle Babylonian Grammatical Texts, Miscellaneous Texts, Materials for the Sumerian Lexicon, Supplementary Series 1* (Rome: Pontificium Institutum Biblicum, 1986), pp. 75–89.

¹³ Van Soldt, "Babylonian Lexical, Religious and Literary Texts," p. 174.

¹⁴ For the southern Levant, see also Aaron Demsky, "The Education of Canaanite Scribes in the Mesopotamian Cuneiform Tradition," in *Bar-Ilan Studies in Assyriology Dedicated to Pinhas Artzi*, edited by Jacob Klein and Aaron Skaist (Ramat-Gan: Bar-Ilan University Press, 1990), pp. 163–64.

¹⁵ Van Soldt, "Babylonian Lexical, Religious and Literary Texts," pp. 176–77.

¹⁶ A. Leo Oppenheim, *Ancient Mesopotamia: Portrait of a Dead Civilization* (Chicago and London: University of Chicago Press, 1964), p. 13: "For the purpose of understanding what these tablets meant to those who wrote them, it is essential to realize that all written documents ... reflect two distinct backgrounds. ... First, there is the large number of tablets that belong to what I will call the stream of tradition—that is, what can loosely be termed the corpus of literary texts maintained, controlled, and carefully kept alive by a tradition served by successive generations of learned and well-trained scribes. Second, there is the mass of texts of all descriptions, united by the fact that they were used to record the day-to-day activities of the Babylonians and Assyrians (the ancient peoples themselves). ... the second level could never have been written without that cultural continuum maintained so effectively by the scribal tradition."

the texts that made up the stream of tradition,”¹⁷ then certainly also and especially in the west, far from Babylon, only the constant maintenance of this “stream of tradition” in the school setting could have made the continuity of such local manifestations of the Mesopotamian literary tradition possible.

On the basis of these specific and general considerations, then, we can propose a hypothetical and admittedly over-simplified¹⁸ typology of text types within the scribal curriculum as practiced at Ugarit by students learning Mesopotamian cuneiform:

1. lists of syllabic signs (tu-ta-ti, etc.)
2. thematic lists of word signs (various sections of Hh , etc.)
3. model documents (model contracts, model accounts, etc.)
4. thematic lists of “knowledge” (omen compendia: *Šumma Izbu*, *Enūma Anu Enlil*, etc.)
5. “poetry/literature” (*Ludingira*, *Gilgameš*, incantations, etc.)

The preserved school texts thus reflect at least five different educational functions: (1) the learning of the graphic inventory necessary to read and write syllabic cuneiform effectively; (2) the learning of thematic inventories of words, necessary for understanding logograms and their meanings;¹⁹ (3) the learning of appropriate formats and structures according to text genre; (4) the learning of traditional lore, be it divinatory, legal, sapiential, or medical, in the form of lists of protasis-apodosis units;²⁰ and finally, (5) the learning of traditional literary works in poetic form, some of these being narratives about the gods.

This five-part typological schema also applies, *mutatis mutandis*, to the corpus of alphabetic school texts.²¹ If we may understand the five-part generic schema for the Mesopotamian curriculum as a kind of pedagogical template for keeping alive the stream of tradition in its western peripheral manifestation then by extension a corresponding Ugaritic schema would represent a local calque of the Mesopotamian system, intended for a similar purpose: an attempt to affirm an independent and distinctive local identity through the establishment and maintenance of a written tradition.

Before fleshing out this typology with examples from the alphabetic corpus, however, it is appropriate to address the potential methodological problem of comparing apples to oranges: Is it legitimate to explain the alphabetic curriculum on the analogy of a model intended for the learning of logo-syllabic writing and of Mesopotamian languages?

Against the use of such an analogy, two considerations come to mind: (1) the two graphic systems are based on radically different principles, and (2) the contents of the two “streams of tradition” are different. Despite these reservations, however, the answer to the question posed above is an unequivocal “yes.” The reasons for this are briefly reviewed here.²²

¹⁷ Oppenheim, *Ancient Mesopotamia*, p. 14.

¹⁸ The five-part schema which follows is not intended to be exhaustive; indeed, many text genres known to have been part of contemporary school curricula were very likely also part of the local Ugaritian school traditions, though they are still not yet directly attested, or only very poorly attested. Rather, the five generic categories presented here are intended merely to reflect those categories which are well documented on the local level, and (since in what follows, an attempt will be made to apply this typology to the alphabetic Ugaritic curriculum) which have clear and well-documented parallels in the alphabetic tradition. Nor is the order of these text types irrefutable: for some transitions, no evidence is available; and for others, the available evidence is occasionally contradictory. The order presented here reflects essentially the principle of a progressive level of difficulty, but this is an admittedly subjective criterion.

¹⁹ For many “bilingual” Mesopotamian lists, this category unites the learning of a graphic inventory (logograms) with that of a lexical inventory (Akkadian translations in syllabic spellings).

²⁰ These units of “knowledge” are empirical in nature: the protasis generally posits an observable phenomenon and the apodosis draws a conclusion on the basis of that observation.

²¹ Expressed somewhat differently by van Soldt, “Babylonian Lexical, Religious and Literary Texts,” p. 183: “the scribes who were trained to write texts in alphabetic script had to write two types of exercises: the alphabet and practice texts.”

²² Most of these have already been evoked by van Soldt, “Babylonian Lexical, Religious and Literary Texts,” pp. 183–86.

A. GENERAL HISTORICAL AND CULTURAL CONTEXT

Mesopotamian scribal traditions have a long history of transmission in the west. In the case of Ugarit, it is reasonable to imagine a continuous scribal tradition from at least the eighteenth century²³ down through the end of the Late Bronze Age.²⁴ On the other hand, the institutionalized use of the alphabetic script for the administration of the kingdom's affairs appears to be relatively late.²⁵ This situation thus provides a general cultural context which lends itself well to the application of the long-established Mesopotamian scribal tradition as a model for the teaching and learning of a more recently developed local alphabetic script.

B. LOCAL SCRIBES WERE FUNCTIONAL IN BOTH SYSTEMS

The bi-graphic nature of the Ras Shamra epigraphic corpus as a whole shows that the indigenous scribes learned and worked in both systems, the Mesopotamian logo-syllabic script and the local alphabetic script. Even on the level of individual archives there are no examples of a clear separation of the two systems.²⁶

Documents composed by certain individual scribes are occasionally attested in both scripts. Van Soldt had identified Burqānu and suggested ʾIli-Milku as documented examples of such “bi-scriptal” scribes.²⁷ At a recent conference, Florence Malbran-Labat and Carole Roche proposed adding the scribe Ur(i)-Tešab to this group, whose “bi-scriptal” activity is best documented in the so-called House of Urtenu.²⁸

Finally, a considerable number of texts employ both writing systems. Roche recently emphasized the high percentage of such “mixed” tablets from the House of Urtenu.²⁹ One particularly striking example is RS 94.2411, a census of “households” per village.³⁰ Seemingly inexplicably, part of the list is written alphabetically and another part logo-syllabically. The presence of both scripts in specifically scholastic texts, such as RS 19.159 (KTU² 5.14),³¹ is another indication of the general appropriateness of applying a Mesopotamian model to the elaboration

²³ Different conclusions on this point were reached by Manfred Dietrich, “Aspects of the Babylonian Impact on Ugaritic Literature and Religion,” in *Ugarit, Religion and Culture: Proceedings of the International Colloquium, Edinburgh, July 1994: Essays Presented in Honour of Professor John C. L. Gibson*, Ugaritisch-Biblische Literatur 12, edited by Nicolas Wyatt et al. (Münster: Ugarit-Verlag, 1996), pp. 33–47.

²⁴ Very little epigraphic material from the period prior to ca. 1350 B.C. has been recovered from Ras Shamra itself; see Daniel Arnaud, “Prolégomènes à la rédaction d’une histoire d’Ougarit I: Ougarit avant Suppiluliuma I^{er},” *Studi Micenei ed Egeo-Anatolici* 39 (1997): 151–61. Still, the implications of the “Ugarit” dossier from the Mari archives (see Pierre Villard, “Un roi de Mari à Ugarit,” *Ugarit Forschungen* 18 [1987]: 387–412), and the general cultural background of northern Syria during “the Amorite Age” (see Dominique Charpin, “Histoire politique du Proche-Orient Amorrite (2002–1595),” in *Mesopotamien: Die altbabylonische Zeit*, Orbis Biblicus et Orientalis 160/4, edited by D. Charpin, D. O. Edzard, and M. Stol [Fribourg and Göttingen: Academic Press and Vandenhoeck & Ruprecht, 2004], pp. 29–38), strongly suggest the existence of a local (Mesopotamian style) chancery at Ugarit already in the eighteenth century B.C. That there was a high degree of continuity in the local scribal tradition from the eighteenth through the mid-fourteenth century B.C. seems likely, given the general historical and archeological picture of the Middle Bronze–Late Bronze transition, and, more particularly, given the distinctive formal aspects of the Late Bronze Akkadian texts from Ras Shamra, which for the most part cannot be explained on the basis of contemporary Kassite or Middle Assyrian models, but seem rather to be local descendants of Old Babylonian traditions.

²⁵ Alphabetic writing existed prior to its Ugaritic cuneiform manifestation; see Benjamin Sass, *The Genesis of the Alphabet and Its Development in the Second Millennium B.C.*, Ägypten und Altes Testament 13 (Wiesbaden: Harrassowitz, 1988). The significant question here is not the date when alphabetic writing was invented, but rather the date when this technology was adopted and adapted to local use on the

institutional level. For the latter, several students of Ugaritic writing are now seriously considering a date as late as the thirteenth century B.C.; see Anne-Sophie Dalix, “Ougarit au XIII^e siècle av. J.-C.: nouvelles perspectives historiques,” *Comptes Rendus de l’Académie des Inscriptions et Belles-Lettres* (1997): 819–24; and Pierre Bordreuil and Dennis Pardee, *Manuel d’Ougaritique* (Paris: Guethner, 2004), vol. 1, pp. 31–32, with bibliography.

²⁶ Van Soldt, “Babylonian Lexical, Religious and Literary Texts,” p. 184.

²⁷ Van Soldt, “Babylonian Lexical, Religious and Literary Texts,” p. 185; see already van Soldt, *Akkadian of Ugarit*, pp. 26–29.

²⁸ Florence Malbran-Labat and Carole Roche, “Ourtenou, Ourteshab,” paper presented at the Congrès International Sherbrooke: “Le royaume d’Ougarit de la Crète à l’Euphrate. Nouveaux axes de recherche,” July 5–8, 2005, at the Université de Sherbrooke, Québec.

²⁹ See the contribution of Carole Roche in this volume.

³⁰ For some preliminary information, see Dennis Pardee, “Épigraphie et structure dans les textes administratifs en langue ougaritique: les exemples de RS 6.216 et RS 19.017,” *Orientalia* NS 70 (2001): 272–76; for a brief description of the text and a very legible photo of the recto, see Pierre Bordreuil and Dennis Pardee, “Recension de villes et de villages du royaume (RS 94.2411),” in *Le royaume d’Ougarit: Aux origines de l’alphabet*, Exhibition Catalogue, Musée des Beaux-Arts de Lyon, October 21, 2004, through January 17, 2005, edited by Geneviève Galliano and Yves Calvet (Lyon and Paris: Musée des Beaux-Arts de Lyon and Somogy Éditions d’Art, 2004), p. 35. The *editio princeps* will be published by Bordreuil and Pardee, “Les textes ougaritiques des campagnes 1994–2002,” in *Études ougaritiques*, vol. 2, Ras Shamra-Ougarit series, edited by Marguerite Yon (Paris: Éditions Recherche sur les Civilisations, forthcoming).

³¹ *TEO* 1, p. 211; Charles Virolleaud, *Le palais royal d’Ugarit*, vol. 2: *Textes en cunéiformes alphabétiques des archives est, ouest et centrales*, Mission de Ras Shamra 7 (Paris: Imprimerie Nationale & Klincksieck, 1957), No. 189.

of the Ugaritic scribal curriculum. This sign list, an abecedary, is not organized horizontally, the format customary for alphabetic sign lists, but rather vertically, in the manner of Mesopotamian sign and word lists. Thus, not only are both writing systems present, but the text also adopts an organizational principle of Mesopotamian lexical lists: a multi-column format,³² with “signs” in the left column, and probably the “name” of the sign, at least as it had been memorized by the Ugaritian students of the thirteenth century, in the right column.³³

C. FORMULAIC STYLE IS IDENTICAL, REGARDLESS OF SCRIPT

The formulaic protocol in epistolary texts and in contracts from the Ras Shamra and Ras Ibn Hani archives, to cite two genres as examples, is not script specific. More importantly, this local formulary is distinct from those used in roughly contemporary Mesopotamian sites such as Nippur or even Assur.

D. PRAGMATIC FUNCTION

Finally, on a purely practical level, a typology drawn from a Mesopotamian model works. There are no significant lacunae in the Ugaritic inventory, and no major categories missing from the Mesopotamian model necessary to explain the Ugaritic curriculum.

2. REMARKS ON THE STRUCTURE OF THE ALPHABETIC SCHOOL CURRICULUM

Considering the full range of those Ugaritic texts susceptible to interpretation as school exercises, and in light of the general appropriateness of a Mesopotamian analogy in attempting to understand this corpus, it seems reasonable to propose that: (1) the *structure* of the alphabetic scribal curriculum was calqued from the model of the traditional Mesopotamian curriculum, at least as it had been taught and learned at Ugarit itself, but (2) the *content* of the alphabetic curriculum was distinctively local:

- | | | |
|----|-------------------------------|---|
| 1. | lists of signs | (abecedaries, etc.) |
| 2. | thematic lists of words | (gods, kings, towns, professions, personal names, etc.) |
| 3. | model documents | (model letters, model accounts, etc.) |
| 4. | thematic lists of “knowledge” | (omen compendia, medical compendia) |
| 5. | “poetry/literature” | (Ba‘lu Cycle, Kirta, ‘Aqhatu, incantations, etc.) |

The first three categories were no doubt learned by all alphabetic scribes. Such exercises do, after all, inculcate the knowledge necessary to compose the mundane documents of daily life: administrative accounts, letters, legal texts, and the like. It is conceivable that the last two categories belong within the general scribal curriculum as well, though at a more advanced level, since the archival distribution of texts reflecting these latter two categories does suggest grouping them with the former three, and since such a presentation would better encapsulate the Ugaritic “stream of tradition” as a whole. It is also possible, however, that only a certain specialized sub-class of scribes went on to the more advanced specialties of divination, medicine, and poetry.

³² Miguel Civil, “Lexicography,” in *Sumerological Studies in Honor of Thorkild Jacobsen on His Seventieth Birthday, June 7, 1974*, Assyriological Studies 20, edited by Stephen J. Lieberman (Chicago and London: University of Chicago Press, 1975), pp. 124–25. The two columns of RS 19.159 correspond, *mutatis mutandis*, to elements 2 and 3 of Civil’s typology. Element 1 is absent, probably owing to the fact that polyvalency was not a serious problem for those learning the alphabetic system; elements 4 and beyond are also absent, of course, since the local sign inventory is not logographic.

³³ William W. Hallo, “Isaiah 28:9–13 and the Ugaritic Abecedaries,” *Journal of Biblical Literature* 77 (1958): 336. Since the Mesopotamian syllabary is extremely ill-suited to express the consonantal distinctions important in Ugaritic, it seems very unlikely that the right column had any phonological importance (that is, it did not allude to “the pronunciation” of the corresponding alphabetic consonantal signs in anything more than a vague and imprecise way).

For each of these five major categories representing the stream of Ugaritic scribal tradition, we can imagine, and in many cases we have actual examples of, school exercises designed to teach and reinforce a corresponding pedagogical content. The Ugaritic scribal curriculum is thus documented both by direct evidence in the form of actual scribal exercises, and by indirect evidence in the form of texts whose form and content can be explained only by positing the existence of an underlying pedagogical exercise. Unfortunately, there are no known Ugaritic literary sources comparable to the Sumerian school dialogues³⁴ which could present a native portrait of scribal education from the perspective of the local literary imagination.

For reasons of space, a typology of Ugaritic tablet types among the school texts is not developed here. In any case, despite a certain degree of regularity of tablet form according to each category, and even occasional sub-sets,³⁵ the Ugaritic data are unfortunately too insufficient to generate anything comparable to what Miguel Civil has developed for Old Babylonian school texts.³⁶ For the same reasons, neither is a detailed reconstruction of the sequence in which the specific alphabetic exercises were studied attempted here. There are few, if any, clear examples of catch lines among the elementary Ugaritic exercises, and those tablets which contain more than one exercise present a fairly wide variety of sequences. Observations on tablet type and on the order of the curriculum in the following pages are therefore ad hoc rather than systematic.

3. REMARKS ON THE CONTENT OF THE ALPHABETIC SCHOOL CURRICULUM³⁷

The paragraphs which follow attempt to flesh out in greater detail each of the five categories suggested above, and especially to provide clear and unambiguous Ugaritic examples which represent them. The categories are not discussed in the order originally presented, but rather according to a criterion of certainty as to whether the genre in question was a generalized part of local scribal education: the genres which almost certainly belong within the broader school curriculum are treated first, followed by those whose status within the curriculum is less well documented.

A. SIGN LISTS

Of the individual Ugaritic elements within the broader five-part typology suggested here, few would argue about the legitimacy of the initial category, “lists of signs.” The best-attested example, of course, is the standard or “canonical” abecedary. Nor would many dispute the local character of this particular sign list, which reflects a Levantine predilection for noting essentially consonantal phonemes.

The number of signs of the standard abecedary and their order are fixed, and it is these thirty signs, more or less in the forms attested by the abecedaries, which provide the graphic inventory of virtually all the documents in Ugaritic cuneiform.³⁸

Numerous manuscripts of this elementary sign list are available for study,³⁹ more in fact than is generally recognized,⁴⁰ and one may isolate several distinct sub-genres among them. In addition to the “canonical” list, a single

³⁴ Åke W. Sjöberg, “The Old Babylonian Eduba,” in *Sumerological Studies in Honor of Thorkild Jacobsen*, pp. 159–79; Herman Vanstiphout, “School Dialogues,” in *The Context of Scripture*, vol. 1: *Canonical Compositions from the Biblical World*, edited by W. W. Hallo and K. Lawson Younger, Jr. (Leiden: Brill, 1997), pp. 588–93.

³⁵ For the Ugaritic mythological texts, for example, one can identify local equivalents both of OB Type I tablets (large tablets divided into multiple columns) and of OB Type II extract tablets (single column, writing parallel to narrow side). See Miguel Civil, *The Series lú = ša and Related Texts*, Materials for the Sumerian Lexicon 12 (Rome: Pontificium Institutum Biblicum, 1969), pp. 27 f.

³⁶ Civil, MSL 12, pp. 27 f.

³⁷ See Manfred Dietrich and Oswald Loretz, *Die Keilalphabet, Die phönizisch-kanaanäischen und altarabischen Alphabete in Ugarit,*

Abhandlungen zur Literatur Alt-Syrien-Palästinas 1 (Münster: Ugarit-Verlag, 1988), pp. 179–99; van Soldt, “Babylonian Lexical, Religious and Literary Texts,” pp. 183–89; Ignacio Márquez Rowe, “Syllabic and Alphabetic Texts—A Further Note of Scribal Education at Ugarit,” *Ugarit Forschungen* 28 (1996): 457–62; and KTU², pp. 489–97.

³⁸ On the texts (very few in number) in the “short alphabet,” see Dietrich and Loretz, *Keilalphabet*, pp. 145–79.

³⁹ For a list, see Dietrich and Loretz, *Keilalphabet*, pp. 180–81; KTU², pp. 489–97; van Soldt, “Babylonian Lexical, Religious and Literary Texts,” p. 195.

⁴⁰ RS 5.274 (KTU² 7.54; *TEO* 1, p. 38) and RS 19.174 [4] (*TEO* 1, p. 221), for example, are fragmentary “canonical” abecedaries (both collated).

exemplar of a distinctly different, “non-canonical” alphabetic sign inventory was discovered in 1988.⁴¹ The origins of this second alphabetic sign inventory are unknown,⁴² but in any case this was not the sign inventory in productive use at thirteenth-century Ugarit.

As an inventory of signs learned in a fixed order, the standard abecedy finds an obvious Mesopotamian parallel in the elementary syllabary Tu-ta-ti, itself attested in at least five examples from Ras Shamra,⁴³ indicating that it was part of the local Mesopotamian cursus.⁴⁴ The organizational format of the alphabetic sign list is horizontal, however, in contrast to the essentially vertical organization of Mesopotamian sign lists.

B. MODEL DOCUMENTS

Another virtually certain category within the local alphabetic curriculum is that of “model documents.” The clearest examples of this genre in the alphabetic corpus are the model letters RS 16.265 (KTU² 5.9)⁴⁵ and RS 94.2273.⁴⁶ That these two texts were both scribal exercises seems clear not only from their content,⁴⁷ but also and especially from the presence of other scribal exercise texts on the same tablet.⁴⁸

Another plausible Ugaritic example of this category, this time representing a model administrative account, is RS 94.2519, soon to be published.⁴⁹ It is a bi-graphic⁵⁰ account presenting an identical sequence of professions with associated numbers: in alphabetic script on one side, and in Mesopotamian logo-syllabic script on the other. Its shape and format are also appropriate for a scribal exercise: the tablet is rectangular,⁵¹ with one side inscribed in “portrait” format, the other in “landscape.”⁵²

As for the formulaic models themselves, it is clear that the alphabetic model letters reflect the local epistolary protocol, and not the style of contemporary Kassite and Middle Assyrian letters.⁵³ There are not yet any known examples of Ugaritic “model contracts,” but it would not be surprising if such documents eventually turn up, reflecting the formulaic protocol of the local juridical texts.

⁴¹ RS 88.2215; see Pierre Bordreuil and Dennis Pardee, “Abécédaire (no. 32),” in *Études ougaritiques*, vol. 1: *Travaux 1985–1995*, Ras Shamra-Ougarit 14, edited by Marguerite Yon and Daniel Arnaud (Paris: Éditions Recherche sur les Civilisations, 2001), pp. 341–48, with bibliography.

⁴² Since elements of cultural heritage are especially susceptible to borrowing, it seems incautious to assume mechanically that the Late Bronze attestations of the “hl̥m” order, both of which are Levantine (Ras Shamra and Beth Shemesh), are to be explained as originating in Arabia, when it is only several centuries later that the “hl̥m” order is attested in Arabia. For a clear presentation of the problem of origin, see Benjamin Sass, *The Alphabet at the Turn of the Millennium: The West Semitic Alphabet ca. 1150–850 BCE, The Antiquity of the Arabian, Greek and Phrygian Alphabets*, Institute of Archaeology of Tel Aviv University Occasional Publications 4 (Tel Aviv: Emery and Claire Yass Publications in Archaeology, 2005), pp. 96–132, and esp. pp. 122–23.

⁴³ Nougayrol, “‘Vocalises’ et ‘syllabes en liberté’ à Ugarit,” pp. 29–31, and 39 (RS 20.125+; RS 20.155; RS 22.225; RS 25.446+); van Soldt, “Babylonian Lexical, Religious and Literary Texts,” p. 196, adds an additional manuscript (RS 25.450) to the four identified by Nougayrol.

⁴⁴ The order of Tu-ta-ti in the local manuscripts copied at Ugarit was fixed, but this order is not identical with the order of Tu-ta-ti in manuscripts known from other sites and periods; see Nougayrol, “‘Vocalises’ et ‘syllabes en liberté’ à Ugarit,” p. 30 (my thanks to Peter Daniels and Wilfred van Soldt for clarification on this point).

⁴⁵ TEO 1, p. 112; Virolleaud, *Palais royal d’Ugarit* 2, text 19. See also Dennis Pardee, “Scribal Exercises,” in *The Context of Scripture*, vol. 3: *Archival Documents from the Biblical World*, edited by W. W. Hallo and K. Lawson Younger, Jr. (Leiden: Brill, 2002), p. 115.

⁴⁶ See the preliminary English translation of Dennis Pardee, “Scribal Exercises,” p. 115. The Mesopotamian text on the verso of RS 94.2273

is also a school text: an extract from the Silbenalphabet A (Syllable Alphabet A).

⁴⁷ Note the unusually elaborate benediction, the frivolity of the “message,” and the grammatical practice (various volitional forms of YTN “to give”) in RS 16.265. RS 94.2273 contains only introductory formulas.

⁴⁸ In addition to a model letter, RS 16.265 also contains two sequences of the standard abecedy and a word list in alphabetic script; RS 94.2273 has a model letter (in alphabetic script) on one side and, on the other, two parallel extracts (probably master and student) from the Mesopotamian exercise Silbenalphabet A.

⁴⁹ Bordreuil and Pardee, “Les textes ougaritiques des campagnes 1994–2002,” text 18. Provisionally, see P. Bordreuil and D. Pardee, “Catalogue raisonné des textes ougaritiques de la Maison d’Ourtenou,” *Aula Orientalis* 17–18 (1999–2000): 27.

⁵⁰ “Bi-graphic” is preferable to “bi-lingual”; see Florence Malbran-Labat, “Langues et écritures à Ougarit,” *Semitica* 49 (1999): 87–101.

⁵¹ The longer side is ca. 82 mm, and the shorter side, at ca. 61+ mm, presents a width to height ratio of slightly over 74%. Cf. RS 94.2273 (77 mm, and 75%); and RS 16.265 (76 mm, and 62%).

⁵² In RS 94.2519, the alphabetic text is in “landscape” format, the Mesopotamian text, “portrait.” The same disposition is found in RS 94.2273. In RS 16.265 (entirely alphabetic), the word list is in “landscape” format, the epistolary text in “portrait.” Juan-Pablo Vita discussed this feature of certain scribal exercises with me (personal communication).

⁵³ The contemporary Hittite and southern Levantine (attested in the Amarna corpus) epistolary styles are more closely related, though still not identical with the local Ugaritic protocol. On these matters, see Robert Hawley, “Studies in Ugaritic Epistolography” (Ph.D. diss., University of Chicago, 2003), with bibliography.

In regard to the curricular order, it is not inappropriate to imagine, at least in some cases, a sequential connection between category 1 (lists of signs) and category 3 (model documents), since both of these are present on RS 16.265. Furthermore, the combination of exercises on the other clear model letter, RS 94.2273, suggests that training in the alphabetic and Mesopotamian traditions was parallel, not successive.

A final type of exercise should also be mentioned here: lists of personal names arranged acrographically. This type of text, attested from Ras Shamra in both script systems,⁵⁴ bridges the gap between the categories of “model documents” and “thematic lists of words.” Like the latter, the elements of these lists all belong to the same semantic category: in this case, personal names. Unlike the other members of that category, however, there is little or no evidence that these lists were learned in a particular fixed order; the single observable organizational principle is their acrographic arrangement. Rather, in terms of pedagogical function, they seem more closely related to “model documents.” The clearest alphabetic examples are RS 1.016 (KTU² 5.1),⁵⁵ RS 19.003 (KTU² 4.607),⁵⁶ and RS 22.001 (KTU² 5.18).⁵⁷

C. THEMATIC WORD LISTS

Since Ugaritic writing was neither logographic nor syllabic, and since the Ugaritian scribes had no need to learn their own language, one could easily conclude that there was little need for local Ugaritic equivalents of the well-known Mesopotamian thematic word lists. Yet many aspects of such lexical lists find striking parallels in the alphabetic tradition. Here one is reminded of another of the functions of such lists: not only do thematic lexical lists teach logograms and Akkadian translations (something unnecessary in the alphabetic curriculum), but they were also designed for administrative use, to serve a practical administrative need.

The learning of thematic word lists, probably in a more or less fixed order, would have prepared students of alphabetic cuneiform for their duties in the cultic or economic administration of the kingdom. While it is true that very few, if any, actual scribal exercises of this type have been preserved, we must nevertheless assume their existence on the basis of patterned orderings of words within the administrative and sacrificial accounts. It is thus above all indirect evidence which allows the elaboration of this category. Four distinct types of thematic word lists can be reconstructed within the alphabetic curriculum: villages, professions, dead kings, and gods.

1. Toponym Lists

Michael Astour, Pierre Bordreuil, and Wilfred van Soldt, among others, have drawn attention to the fact that the local toponyms within administrative accounts often appear in ordered patterns.⁵⁸ One cannot reconstruct a single fixed canonical order, but it is possible to recognize lower-level patterns of ordering and grouping. The main criterion governing the order was geography. Such patterns must have been taught and learned during scribal training. One fairly good illustration of such a school setting comes from an actual exercise, RS 94.2440.⁵⁹ In terms of tablet type, this text represents essentially a local equivalent of an Old Babylonian Type II tablet,⁶⁰ with a space after the teacher’s version for the student to practice, although here the presentation is oriented horizontally instead of vertically. In addition to practicing the alphabet, however, the student also practiced writing some local toponyms. More importantly, he wrote them in ordered patterns: Mulukku, ³Aru, and ²Atallig are all coastal “Group 8” towns according to van Soldt’s classification; the other two place names represent “Group 5” towns. These groupings reappear elsewhere in administrative documents.⁶¹

⁵⁴ For examples in Mesopotamian script, see RS 15.054 (*TEO* 1, p. 85); RS 20.007 (*TEO* 1, p. 229); and the sequences appended to the local version of Tu-ta-ti, published by Nougayrol in “‘Vocalises’ et ‘syllabes en liberté’ à Ugarit,” p. 30.

⁵⁵ *TEO* 1, p. 17.

⁵⁶ *TEO* 1, p. 196.

⁵⁷ *TEO* 1, p. 283.

⁵⁸ For a comprehensive treatment, see now Wilfred H. van Soldt, *The Topography of the City-State of Ugarit*, *Alter Orient und Altes Tes-*

tament 324 (Münster: Ugarit-Verlag, 2005), pp. 1–3, 72–110, with bibliography.

⁵⁹ Pierre Bordreuil and Dennis Pardee, *Manuel d’Ougaritique* (Paris: Guethner, 2004), vol. 2, pp. 131–32.

⁶⁰ Civil, *MSL* 12, pp. 27–28.

⁶¹ Similar groupings and sequences of these toponyms can be conveniently consulted in van Soldt, *Topography of the City-State of Ugarit*, pp. 88–89 and 95–96.

2. Professions Lists

The same kinds of patterned orderings can also be noticed within lists of professions.⁶² As with toponym lists, these patterned orders probably go back to the curriculum. Again, we have no certain examples of the actual exercises used to teach scribes the inventory of the local professions. One possible exception, however, is RS 14.084 (KTU² 4.126).⁶³ Although the particular order attested there is not always followed in the administrative texts, it does show up on occasion,⁶⁴ as in RS 18.252 (KTU² 4.416).⁶⁵

3. King Lists

The names of deceased kings were also learned in a certain order, the organizational principle here being chronological.⁶⁶ The best-preserved example of this “Ugaritic King List,” tracing the royal succession back to an eponymous ancestor named ʾUgarānu, is RS 94.2518, one of four known manuscripts in Mesopotamian cuneiform script.⁶⁷ That a very similar, perhaps identical list was also part of the alphabetic curriculum is suggested by the single manuscript of the text in alphabetic script.⁶⁸ Though fragmentary, the legible portions of the Ugaritic version correspond to Kings 8–20⁶⁹ of the more complete syllabic version.

⁶² See P. Vargyas, “Stratification sociale à Ugarit,” in *Society and Economy in the Eastern Mediterranean (c. 1500–1000 B.C.)*, *Proceedings of the International Symposium Held at the University of Haifa from the 28th of April to the 2nd of May, 1985*, *Orientalia Lovaniensia Analecta* 23, edited by Michael Heltzer and Edward Lipiński (Louvain: Peeters, 1988), pp. 117–18.

⁶³ *TEO* 1, p. 80; Charles Vroilleaud, “Six textes de Ras Shamra provenant de la 14^e campagne,” *Syria* 28 (1951): 165–66; Vroilleaud, *Palais Royal d’Ugarit* 2, texte 26. The tablet was re-edited by Dennis Pardee, “Les hommes du roi propriétaires de champs: les textes ougaritiques RS 15.116 et RS 19.016,” *Semitica* 49 (1999): 59–64. In the latter the order of recto and verso was reversed from the *editio princeps* (this conclusion was also reached independently by P. Bordreuil; see Pardee, “Les hommes du roi,” p. 61 n. 117), on the grounds that one of the surfaces of the tablet was significantly flatter than the other. Typically it is the recto that is flat; the scribes apparently usually left any given tablet verso upward upon finishing it; gravity then caused the recto surface to flatten considerably before the drying process had been completed. Pardee chose to favor this physical criterion over formal evidence from several professions lists beginning with the order *mrynm*, *mr’um*, *šrm*, etc., arguing (p. 61 n. 116) that since “l’ordre n’est fixe ni à l’intérieur des groupements ni entre eux ... il ne faut pas prêter à ce critère [i.e., the fact that *mrynm*, etc., often begins professions lists] trop de poids en essayant de déterminer l’orientation *recto/verso* de telle tablette fragmentaire.” The example he cited is the list of professions in RS 11.716 (KTU² 4.68), where the sequence *šrm*, *mr’um* (not *mr’um*, *šrm*) is found mid-way through the list (not at the beginning) and *mrynm* is absent altogether. There is no clear solution in cases such as these, where conclusions reached on physical criteria contradict those reached on formal grounds. One possible scenario, however, which would salvage both lines of evidence, might explain the fact that it is the recto that is usually flat as circumstantial and related to the genre and function of the tablet in question. If, for example, RS 14.084 were an exercise, instead of leaving the tablet lying on a flat surface verso upward (the usual situation, resulting in a flat recto), the student scribe might have turned it over upon its completion, perhaps in a gesture of consideration toward his teacher who would have checked it, leaving the recto side upward (which would have caused the verso to flatten before the tablet hardened).

⁶⁴ Note, however, the reservations of Pardee, “Les hommes du roi,” p. 61: “On peut dire que certaines professions sont souvent groupées ... mais l’ordre n’est fixe ni à l’intérieur des groupements ni entre eux ...” The absence of a single fixed order which governs all lists of professions, however, does not negate the significance of lower-level patterns of ordering within the groups, as van Soldt has convincingly shown with respect to toponym lists; see now his *Topography of the City-State of Ugarit*, pp. 72–110.

⁶⁵ *TEO* 1, p. 166.

⁶⁶ The Mesopotamian parallels are obvious; for a survey, see Dietz Otto Edzard, “Königslisten und Chroniken (Sumerisch)”; and A. Kirk Grayson, “Königslisten und Chroniken (Akkadisch),” in *Reallexikon der Assyriologie* 6 (Berlin and New York: Walter de Gruyter, 1980), pp. 77–135.

⁶⁷ Daniel Arnaud, “Prolégomènes à la rédaction d’une histoire d’Ougarit II: Les bordereaux de rois divinisés,” *Studi Micenei ed Egeo-Anatolici* 41 (1999): 153–73. Note that Arnaud himself (p. 168) did not understand these texts as school exercises, but rather as “bordereaux” owing to the “checkmarks” or “coches” which follow each entry; so also Dennis Pardee, *Ritual and Cult at Ugarit*, *SBL Writings from the Ancient World* 10 (Leiden and Boston: Brill, 2002), p. 200. The presence of these checkmarks in and of themselves is not inconsistent with the hypothesis that these are exercises (the checkmarks could reflect that the teacher checked the student’s copy), but the point is immaterial. The fact that this particular fixed order is attested in multiple examples indicates that it was part of the scribal curriculum on some level; if these particular texts were school exercises, then they constitute direct evidence of that curriculum; if they are cultic “bordereaux” they constitute indirect evidence.

⁶⁸ RS 24.257 (*TEO* 1, p. 300). For discussion and bibliography, see Pardee, *Ritual and Cult at Ugarit*, pp. 195–210. The hypothesis that RS 24.257 is a scribal exercise, which, I might add, is unproven, also provides a plausible explanation for the presence of a poetic text (fragmentary) on the other side of the tablet: like RS 16.265, RS 22.225, RS 94.2273, and several others, this tablet would have contained more than one discrete exercise.

⁶⁹ This portion of the sequence ought to correspond to the seventeenth through the fifteenth centuries B.C., an otherwise virtually undocumented period at Ugarit.

4. God Lists

Finally, sequences of gods' names can be found in the sacrificial lists, such as RS 24.643 (KTU² 1.148).⁷⁰ These same sequences show up occasionally in list form. The sequence in RS 24.643:1–9, for example, is also found in at least two lists: RS 1.017 (KTU² 1.47)⁷¹ and RS 24.264 (KTU² 1.118).⁷² One of the copies even has the native title of the list: *ʾil špn* “the Gods of Šapunu.” These are not always recognized as school texts,⁷³ but that possibility is not to be dismissed lightly. Even the “checkmarks” which precede the individual entries in one of the manuscripts find a striking parallel in the initial DIŠ sign which introduces individual lexical entries in the Mesopotamian list traditions.⁷⁴

D. POETRY AND LITERATURE

That local poetic compositions in alphabetic script could be part of the scribal curriculum at Ugarit is shown by RS 22.225 (KTU² 1.96).⁷⁵ That example contains an incantation, but student exercises also very likely included the copying of extracts from longer, specifically narrative, mythological poems.⁷⁶ At least four reasonably clear examples of this practice are known,⁷⁷ all of which appear to contain extracts from the Baʿlu Cycle: RS 1.006 (KTU² 1.13),⁷⁸ RS 24.245 (KTU² 1.101),⁷⁹ RS 24.263 (KTU² 1.117),⁸⁰ and RS 24.293 (KTU² 1.133).⁸¹

E. THEMATIC LISTS OF “KNOWLEDGE”

The final category, here labeled “thematic lists of knowledge,” is the least certain of the categories surveyed thus far as an element of the general alphabetic curriculum. Its inclusion here is based on two premises: (1) the “knowledge” conveyed in these texts was part of the local “stream of tradition,” and (2) the maintenance of that tradition required at least some level of training.

These texts are not always recognized as being “local” in terms of content.⁸² Whether or not these compendia are ultimately of local origin, however, several factors make it likely that they had a longer history of transmission in the west than is generally recognized, as Dennis Pardee has cautiously suggested in a series of recent publications.⁸³ The corpus of Ugaritic “scientific” texts⁸⁴ includes fragmentary manuals of birth omens⁸⁵ and astrological

⁷⁰ TEO 1, p. 306; for a re-edition, with comprehensive discussion of prior literature, see Dennis Pardee, *Les textes rituels*, Ras Shamra-Ugarit 12 (Paris: Éditions Recherche sur les Civilisations, 2000), pp. 779–806.

⁷¹ TEO 1, p. 17; and Pardee, *Les textes rituels*, pp. 291–319.

⁷² TEO 1, p. 301; and Pardee, *Les textes rituels*, pp. 659–60.

⁷³ Exceptions include Wilfred H. van Soldt, “Private Archives at Ugarit,” in *Interdependency of Institutions and Private Entrepreneurs*, edited by A. C. V. M. Bongenaar, Proceedings of the Second MOS Symposium (Leiden 1998), MOS Studies 2 (Istanbul and Leiden: Nederlands Historisch-Archaeologisch Instituut, 2000), p. 243 n. 145; and Ignacio Márquez Rowe, review of Marguerite Yon and Daniel Arnaud, eds., *Études ougaritiques*, I. *Travaux 1985–1995* in *Orientalia* NS 74 (2005): 143 (my thanks to I. Márquez Rowe for these references).

⁷⁴ That is, it is tentatively suggested here that these “checkmarks” or “coches” represent local equivalents of “Element 0” in Civil’s typology of the structuring principles of Mesopotamian lexical lists (“Lexicography,” pp. 124–25); see also Márquez Rowe, *Orientalia* NS 74 (2005), p. 143. For other interpretations of the “checkmarks,” many of which are not necessarily mutually exclusive, see Pardee, *Les textes rituels*, p. 660.

⁷⁵ See above, note 8.

⁷⁶ Dennis Pardee, *Les textes para-mythologiques de la 24^e campagne* (1961), Ras Shamra-Ugarit 4 (Paris: Éditions Recherche sur les Civilisations, 1988), p. 265; Manfred Dietrich and Oswald Loretz, “Mythen als Schultexte: KTU 1.133; 1.152 und die Vorlagen KTU 1.5 I 11–22; 1.15 IV 6–8,” *Ugarit Forschungen* 23 (1992): 91–102.

⁷⁷ The group is internally homogenous in many respects: tablet form and size, text format, even script, which is “grande et grossière,” to

adopt the characterization of Andrée Herdner, *Corpus des tablettes en cunéiformes alphabétiques découvertes à Ras Shamra-Ugarit de 1929 à 1939*, Mission de Ras Shamra 10, Bibliothèque Archéologique et Historique 79 (Paris: Imprimerie Nationale and P. Geuthner, 1963), p. 56.

⁷⁸ TEO 1, p. 16; Herdner, *Corpus des tablettes en cunéiformes alphabétiques*, pp. 56–58.

⁷⁹ TEO 1, p. 299; Pardee, *Les textes para-mythologiques*, ch. 3.

⁸⁰ TEO 1, p. 301; Pardee, *Les textes para-mythologiques*, ch. 9.

⁸¹ TEO 1, p. 303; Pardee, *Les textes para-mythologiques*, ch. 4.

⁸² See van Soldt, “Babylonian Lexical, Religious and Literary Texts,” p. 186, who expresses the widely held view that “religious texts such as omen compendia ... probably go back to Babylonian originals.”

⁸³ Dennis Pardee, “Ugaritic Omens, Ugaritic Extispicy,” in *The Context of Scripture*, vol. 1: *Canonical Compositions from the Biblical World*, edited by W. W. Hallo and K. Lawson Younger, Jr. (Leiden: Brill, 1997), pp. 287–94; Pardee, “Ugaritic Science,” in *World of the Aramaeans: Studies in Language and Literature in Honour of Paul Eugène Dion*, edited by P. M. Michèle Daviau et al. (Sheffield: Sheffield Academic Press, 2001), vol. 3, pp. 223–54; and Pardee, *Ritual and Cult*, pp. 127–48, with bibliography.

⁸⁴ If Ugaritic versions of law collections and proverb collections are discovered one day, they too ought to belong in this category.

⁸⁵ Two different compositions, RS 24.247+ (KTU² 1.103; TEO 1, p. 300) and RS 24.302 (KTU² 1.140; TEO 1, p. 304); Pardee, *Les textes rituels*, pp. 532–64, 763–65. See Manfred Dietrich and Oswald Loretz, *Mantik in Ugarit: Keilalphabetische Texte der Opferschau, Omensammlungen, Nekromantie*, Abhandlungen zur Literatur Alt-Syrien-Palästinas 3 (Münster: Ugarit-Verlag, 1990), pp. 89–165.

omens,⁸⁶ probably a manual of dream omens,⁸⁷ and a number of copies of a single manual of veterinary medicine.⁸⁸ In terms of form and function, the latter has no known parallel in other ancient Near Eastern cuneiform traditions.⁸⁹ The other three types of compendia do, of course, have well-known parallels, especially from Mesopotamia, but none of the known Mesopotamian versions of Šumma izbu, Enūma Anu Enlil, or the Dream Book represent possible *Vorlagen* of the Ugaritic versions. Even on the level of individual protasis-apodosis pairs there are no known parallels. Granted, the Ugaritic versions are generally quite fragmentary; and it is certainly possible that they do, in fact, represent translations of known or unknown Akkadian originals. But given the clearly local content of the other elements of the curriculum, it seems more plausible that these Ugaritic compendia reflect the setting down in writing of local divinatory and medical oral lore. The date of this was probably more or less contemporary with the institutionalization of the alphabetic script as the major graphic vehicle of Ugaritic palace administration, that is, with the creation of a local written “stream of tradition,” whenever that happened.⁹⁰

CONCLUSION

The Ugaritian attempt to affirm an independent and distinctive local identity through the establishment and maintenance of a written alphabetic tradition can be characterized as structurally calqued from the Mesopotamian tradition, but genuinely local in terms of content. Judging from the very different alphabetic material known from the Iron Age Levant, this attempt at establishing a local written tradition ultimately failed, at least in this particular form. But the fact that such an attempt was even made, and the great originality with which the endeavor was pursued, ensures a privileged place for the scribes of Ugarit in the history of writing.

⁸⁶ RIH 78/14 (KTU² 1.163; *TEO* 1, p. 366); Pardee, *Les textes rituels*, pp. 859–71; Dietrich and Loretz, *Mantik in Ugarit*, pp. 165–95.

⁸⁷ RS 18.041 (KTU² 1.86; *TEO* 1, p. 158); Pardee, *Les textes rituels*, pp. 457–68.

⁸⁸ RS 17.120 (KTU² 1.85; *TEO* 1, p. 130) is virtually complete. There are also three fragmentary manuscripts: RS 5.285+ (KTU² 1.72; *TEO* 1, p. 39); RS 5.300 (KTU² 1.71; *TEO* 1, p. 39); RS 23.484 (KTU² 1.97; *TEO* 1, p. 295). See Dennis Pardee, *Les textes hippiatrices*, Ras Shamra-Ougarit 2 (Paris: Éditions Recherche sur les Civilisations, 1985); Chaim Cohen and Daniel Sivan, *The Ugaritic Hippiatric Texts: A Critical Edition*, American Oriental Society 9 (New

Haven: American Oriental Society, 1983); and Chaim Cohen, “The Ugaritic Hippiatric Texts: Revised Composite Text, Translation and Commentary,” *Ugarit Forschungen* 28 (1996): 105–53.

⁸⁹ In other words, there are no other known examples of manuals devoted exclusively to symptoms and remedies for equine ailments, although specific symptom-remedy pairs for sick horses do crop up here and there in Neo-Assyrian copies of medical manuals devoted to human ailments; see Chaim Cohen, “The Ugaritic Hippiatric Texts and BAM 159,” *Journal of the Ancient Near Eastern Society* 15 (1983): 1–12.

⁹⁰ See above, p. 58

CORPUS-DRIVEN MODELS OF LEXICOGRAPHY AND MESOPOTAMIAN CULTURAL HERITAGE PRESERVATION AT THE CDLI

J. Cale Johnson, Cuneiform Digital Library Initiative / University of California, Los Angeles

INTRODUCTION

Since its inception in 2000, the *Cuneiform Digital Library Initiative* (CDLI) has worked for the documentation and dissemination of the primary data for the huge number of cuneiform tablets that are today scattered around the globe. The project has consistently emphasized the non-proprietary, public character of primary data and one of its primary methods of encouraging the public availability of data has been to encourage collective authorship and/or partially anonymous dissemination of primary data. Therefore I would like to emphasize that all the efforts that I describe herein were collective in nature and I report them here primarily in order to inform the larger Assyriological community about some of the underlying premises and goals of ongoing work at CDLI and other similar projects such as the *Pennsylvania Sumerian Dictionary* (PSD) and the *Digital Corpus of Cuneiform Lexical Texts* (DCCLT). Although my presentation at the Rencontre dealt with a broader range of topics,¹ in the following I limit myself to three areas where the efforts of CDLI are of particular interest: (i) the development of transliterational corpora for the periods *between* the Late Uruk and Ur III periods, (ii) first-order markup in which relatively simple ASCII transliterations are transformed into XML format, and (iii) the lemmatization of the XML transliterations, the first substantial example of second-order markup to be applied to CDLI corpora, yielding a primary resource for both the preservation of Mesopotamian cultural heritage and the emergent lexicography of the PSD.

FILLING IN THE GAPS: THE NEW EARLY DYNASTIC IIIB AND EBLA CORPORA

Under the leadership of Bob Englund, the earliest phases of CDLI necessarily focused on bringing the corpora that he had developed in cooperation with a number of investigators over the preceding decade into a useful format on which further efforts could be based. At the beginning of the project, therefore, two major corpora were already in place, the Late Uruk corpus, which also included all known Early Dynastic I materials, and the Ur III corpus. The proto-Elamite corpus was put together a few years ago by Jacob Dahl while he was a graduate student at UCLA, and he is currently re-editing these texts in cooperation with Béatrice André of the Louvre and with curatorial staff of the National Museum in Tehran. Of these corpora, the one that has garnered the most attention from project staff is the Ur III corpus, now numbering over 44,000 tablets in transliteration out of the approximately 62,000 tablets that we have in catalogue: this amounts to roughly 70% coverage with over 600,000 lines of transliteration, and fewer than 2,000,000 words. This is roughly twice as large as the first corpora of Modern English such as the BROWN corpus compiled in the 1960s and 1970s, but significantly smaller than present-day English corpora such as the British National Corpus with over 100,000,000 words. As of 2002, the materials made available through CDLI consisted almost entirely of images and transliterations of cuneiform tablets from the beginning and the end of the third millennium B.C.; materials from the middle of the third millennium, including primarily the Early Dynastic and Akkadian periods as well as the Ebla materials, were neither catalogued nor documented in the form of archival images or standardized transliterations.

¹ The title of the talk given at the RAI was “New Digital Tools for Mesopotamian Cultural Heritage Preservation at CDLI,” but I have

changed the title of this paper so as to reflect the somewhat narrower focus of this report.

In fall of 2001, Englund set in motion a large-scale collaborative effort to catalogue the Early Dynastic IIIb and Akkadian period text-artifactual remains as well as the materials from Ebla, to collect whatever images of these tablets might exist in public and private collections, and to assemble transliterational corpora for each period. I was assigned to the new project and began forming cooperative arrangements and planning for summer 2002 meetings with several collaborators. Work on both the Early Dynastic IIIb and Akkadian catalogues began in the summer of 2002 and extended over a series of meetings in 2002 and 2003 between Aage Westenholz, Walter Sommerfeld, and me in Copenhagen and Marburg. These catalogues were subsequently entered into the CDLI main catalogue in December 2003 and have formed the basis for the collection and dissemination of images as well as the formation of the transliterational corpora. At roughly the same time, we began the reconfiguration of the transliterations of over 1,800 Old Sumerian tablets provided by Gebhard Selz, Bram Jagersma, and Remco de Maaijer. These formed our first subset of Early Dynastic IIIb transliterations, to which a number of major additions provided by Douglas Frayne, among others, have been appended. At present (late September 2005) the Early Dynastic IIIb corpus consists of 2,582 tablets in transliteration, amounting to approximately 77,000 lines of transliteration. Daniel Foxvog, who is in the process of completing a full prosopography and description the Early Dynastic IIIb administrative documents, has been kind enough to provide us with a large number of corrections and additions to the corpus (fig. 1).

Work on Ebla began with a week-long cataloguing session in Rome, in which Alfonso Archi, other members of the Missione Archeologica Italiana in Siria team, and I put together a digital catalogue on the basis of a variety of sources; this catalogue formed the basis for further work and was incorporated into the CDLI database just last summer (June 2004). Recently, we have also reformatted approximately 1,400 transliterations derived from the Archivi Reali di Ebla Testi (ARET) volumes and maintained by Lucio Milano. These now form the core of our Ebla corpus, which we will be returning to the Italian mission in a few months for correction and expansion. We hope in the com-

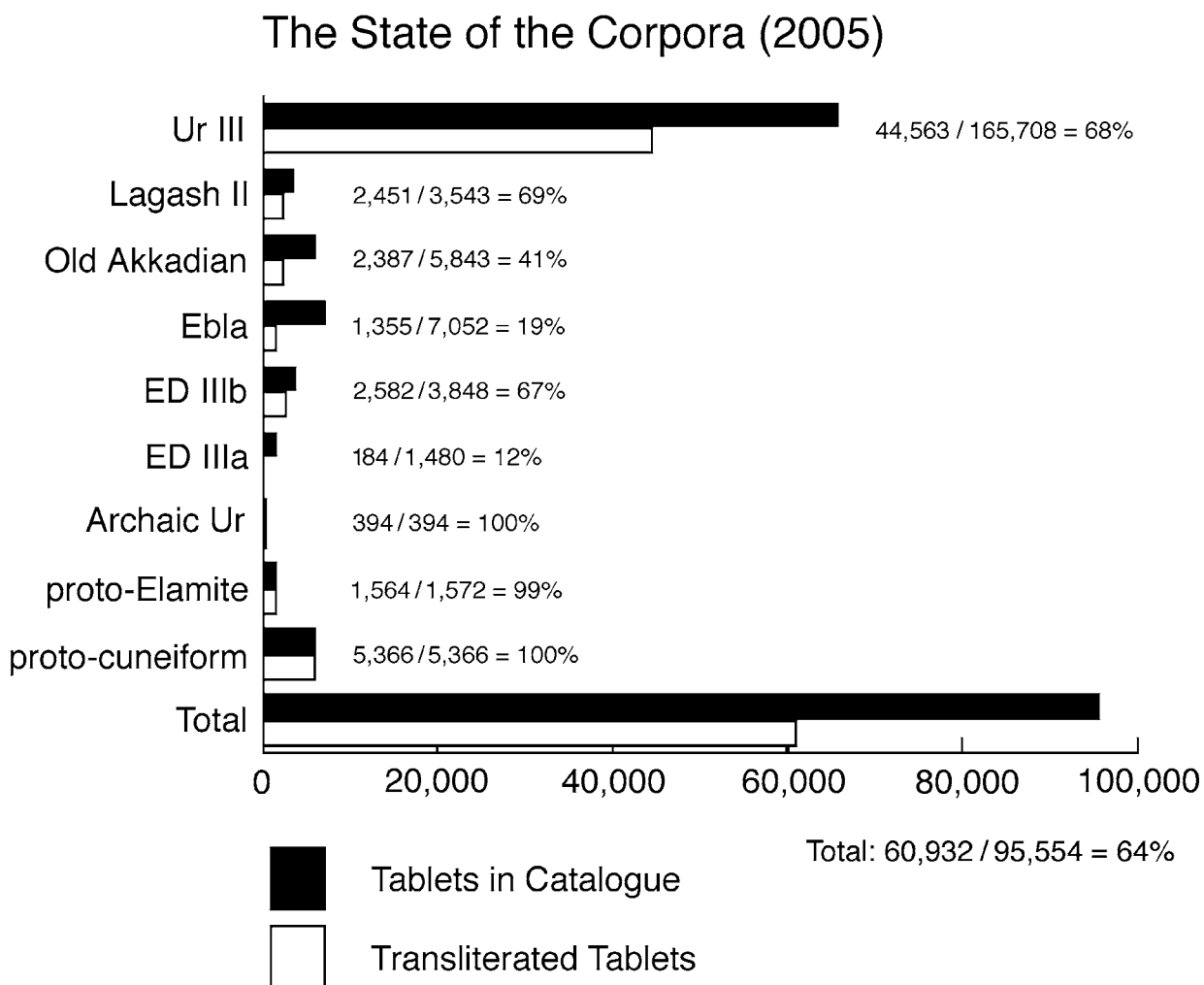

Figure 1. CDLI transliterations as of July 2005.

ing years to expand the amount and quality of syllabically written Semitic language material in the CDLI corpora.² These obviously pose a set of challenges not found in the Sumerian materials, such as the treatment of heterogeneous orthographies, written partially in Sumerian logograms and partially in syllabically written Akkadian or Eblaite. The preliminary work that we are now carrying out on the Ebla corpus has provided a great deal of insight into how such issues may be dealt with in future work.

FIRST-ORDER MARKUP (ATF > XML)

In order to ease the transition to XML, CDLI in cooperation with PSD and other projects has developed a set of transitional transliteration conventions known as ASCII Text Format (ATF). The intention is that ATF would mimic the traditional methods of Assyriological transliteration as much as possible, while at the same time simplify the process of transforming human readable transliterations into XML format (fig. 2). The transliterations that are contributed to the project are transformed into ATF through a variety of Perl scripts, GREP search-and-replace, as well as manual inspection and correction. Once in ATF, the transliterational corpora are fed through an ATF to XML transformation script or parser written and maintained by Steve Tinney at the PSD Web site. This process is represented, moving left to right, in figure 2.

ATF exists solely as a mechanism to transition a wide variety of transliterational formats into a single, uniform XML format. The use of XML may seem gratuitous to some, but lemmatization and other kinds of second-order markup quickly grow far too complex for the relatively simple syntax of ATF. So, if nothing else, the conversion into XML lays the groundwork for other kinds of markup that link particular texts to corpora, dictionaries such as

First-order markup (ATF > XML)

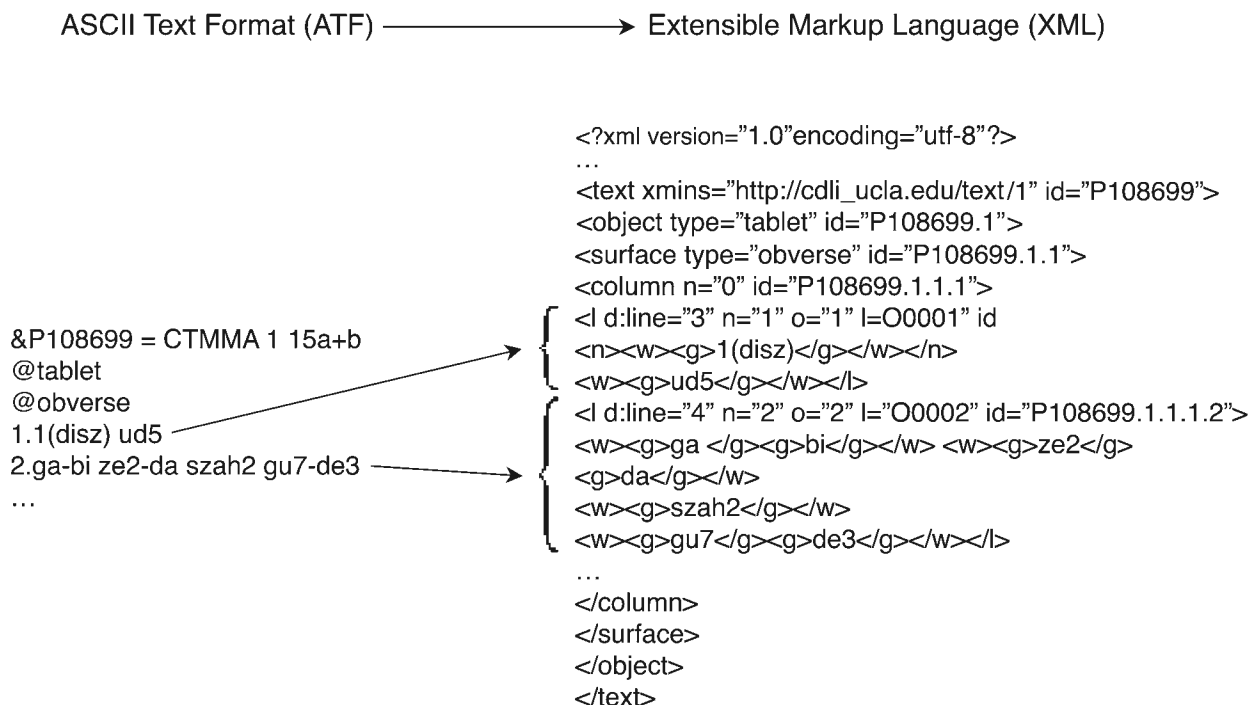

Figure 2. ATF > XML.

² CDLI associates Alfonso Archi and Bertrand Lafont of the Institut français du Proche-Orient are currently engaged in plans with the Syrian Department of Antiquities that, we hope, will result in the co-

operative digital capture of Syrian corpora, beginning with the Ur III collection of the Aleppo Museum.

the PSD, and ultimately to prosopographical study and the localization of materials in terms of both time and place. The model at work here is build-as-you-go, structuring the data within a corpus according to certain basic criteria using public conventions, while allowing other users to link into the dataset and contribute various second-order qualifications of particular subsections of the corpus as defined within XML. The first significant and one of the most important examples of such second-order markup that we have attempted is the lemmatization of the Ur III corpus in cooperation with Steve Tinney (fig. 3).

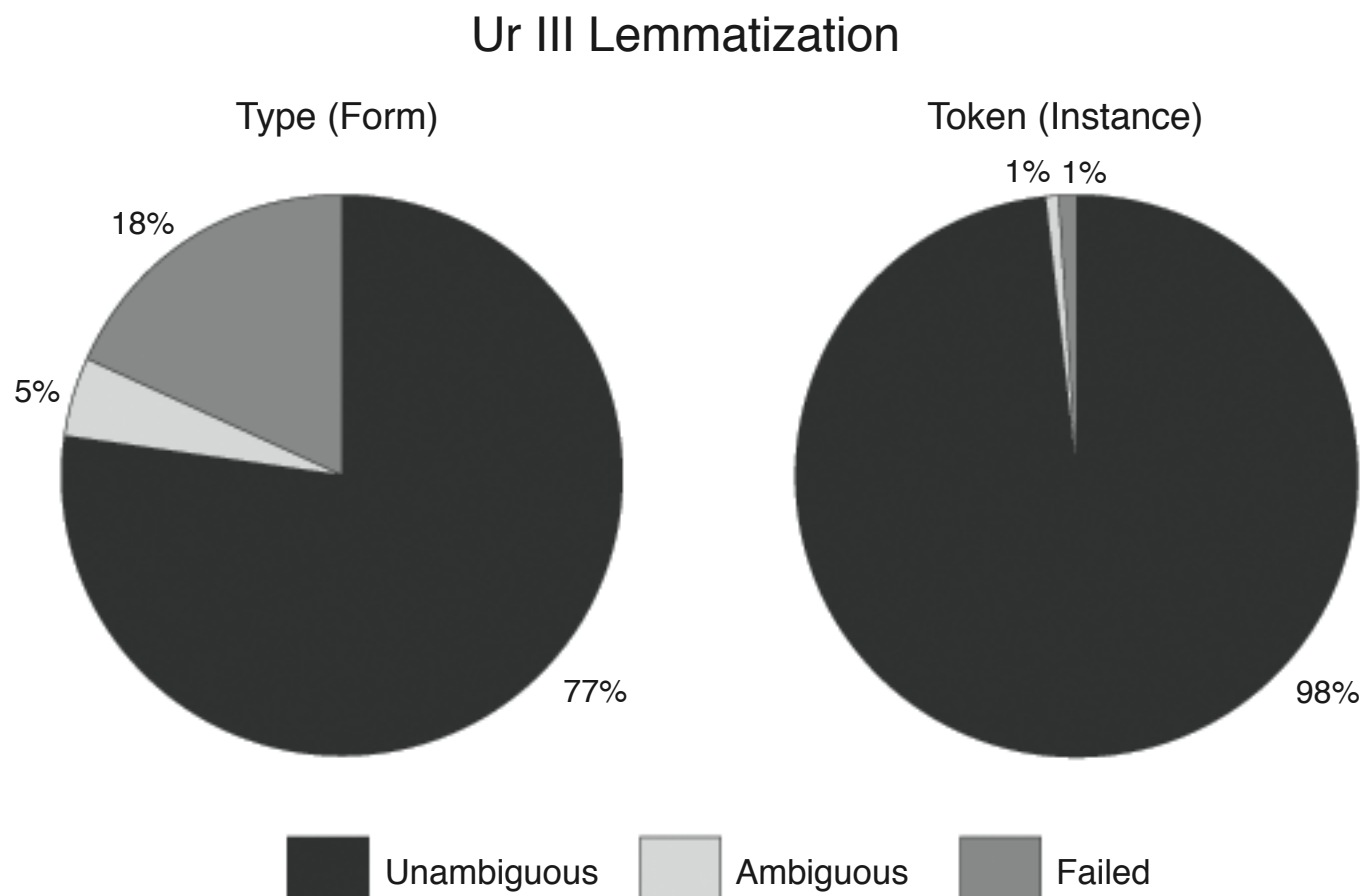

Figure 3. Ur III lemmatization.

As the two pie charts show, in terms of attested forms—for each of which one or more tokens (individual words on particular tablets) exist—we have achieved 77% lemmatization, which roughly corresponds to the rate of successful lemmatization at the *Electronic Text Corpus of Sumerian Literature* (ETCSL). In terms of attested tokens, we have successfully lemmatized approximately 98% of the Ur III corpus. The next corpus of lemmatized material that CDLI will produce will be the Early Dynastic IIIb corpus, on which I have already begun working, again in cooperation with Tinney. The first batch of lemmatized Early Dynastic IIIb files is currently being processed, a second batch which is in the process of being standardized into ATF will be lemmatized in the coming months, and a third and final subset including the rest of the as yet untransliterated Early Dynastic IIIb materials should be complete by early in 2006. With the completion of the Early Dynastic IIIb corpus, most of the major corpora that provide the basis for lexicographical work in Sumerian, namely the Early Dynastic IIIb and Ur III materials made available through CDLI, and the Old Babylonian corpora produced by ETCSL and DCCLT (Niek Veldhuis's lexical list project at the University of California, Berkeley) will be essentially complete.

In essence we are involved in some of the same tasks that were undertaken by the CAD, but the crucial difference is that in an age of dynamic corpora, we also need a new kind of lexicography in which sources are updated at the same time as the dictionaries and prosopographies that are based on them. The modular character of this new

lexicography allows work to progress on all fronts at the same time. The fundamental difference is that projects that focus on particular bodies of material such as CDLI, DCCLT, and ETCSL can produce corpora that feed any given electronic dictionary, in the first instance the PSD, while receiving in turn a degree of unification and ease of access that might not otherwise be available.

SECOND-ORDER MARKUP AND ITS IMPLICATIONS

While several different kinds of second-order markup can be imagined and several of these are currently being investigated by CDLI staff members in Los Angeles, the lemmatization of the Ur III corpus provides an excellent real-world model for evaluating second-order markup and its implications (fig. 4).

Second-order markup (XML > Lemmatized XML)

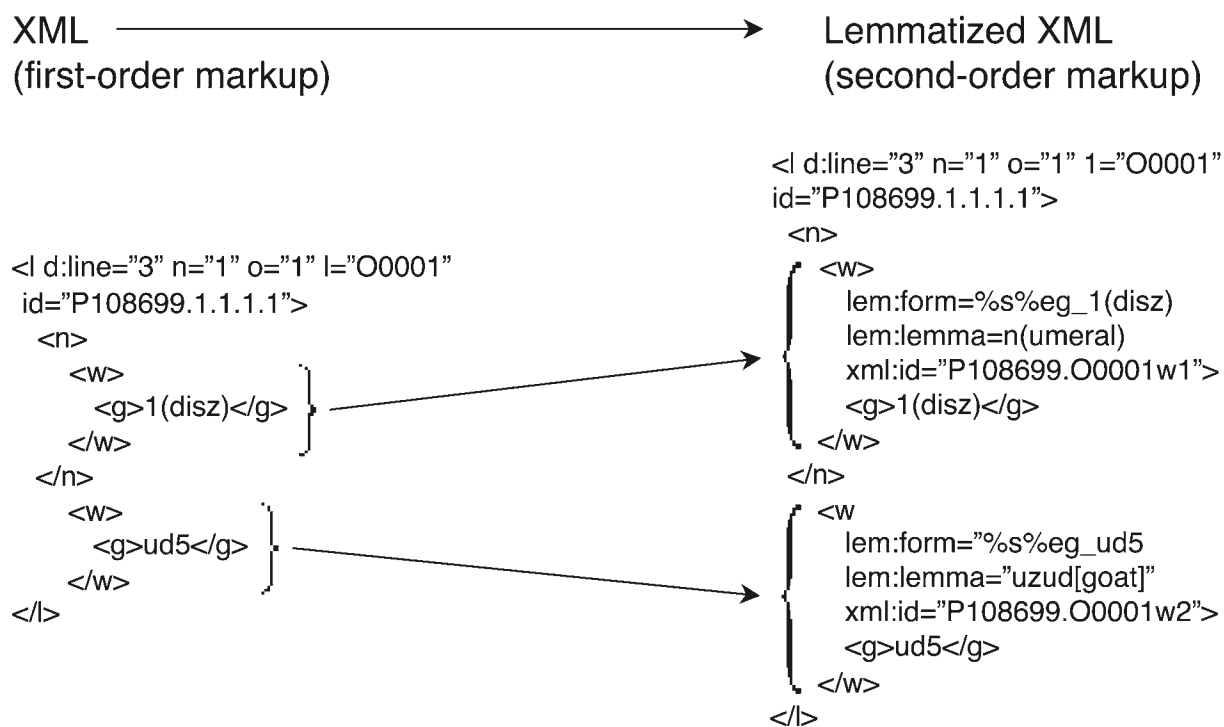

Figure 4. The lemmatization of XML.

On the left-hand side of figure 4, I have taken one line from the XML file in figure 3 and rearranged it into a hierarchical representation of its structure. On the right-hand side, we see that three lines have been added that qualify each “<w>” or “word” level unit: these are lemmatization entries and in recent months, in cooperation with the PSD, we have lemmatized nearly all the materials in the Ur III corpus (see above). It is important to recognize that each second-order markup unit includes a reference to its location within the primary or first-order XML corpus: in the example in figure 4, for instance, “xml:id=“P108699.O0001w1” refers to the particular cuneiform tablet (P108699) and locates the lemmatized word in question on the surface of the document using an enumeration of column, line, and word (O0001w1). The sequence “O0001w1” consists of four discrete entities in hierarchical sequence from left to right “O 00 01 w1”: “O” stands for “obverse”; the two zeros that follow refer to column number, which for a tablet without columns is conventionally represented as “column zero”; the next two numbers indicate the line number; and lastly the “w” followed by a number signifies the word on that line that the lemma qualifies, counting from

the left. In other words, “O0001w1” can be read as “obverse (O), column zero (00), line 1 (01), first word (w1).” This allows the XML unit that includes the lemmatization information (each segment demarcated by <w> and </w> in figure 4) to function in truly modular fashion: the <w> level units in a lemmatized corpus can be broken up into individual units and fed into a dictionary, or alternatively, the lemmatization entry can reside within a dictionary entry and point to the location in the first-order XML corpus using the `xml:id` information. Perhaps more importantly, the first-order XML file and the lemmatization information can just as easily exist in two separate files maintained by different research projects in different cities, as is the case with CDLI and PSD. Since the `xml:id` element points to a structural position within the primary XML corpus, both the primary XML and the lemmatization information can be updated and/or corrected independently of one another without destroying the connection between data in first- and second-order markup. Even a structure-changing revision of, say, word division within a line or renumbering of lines within a document only breaks the links within the smallest structural unit that contains such a change. Since structure-changing corrections should be relatively rare, these small sections can be tracked and relemmatized as needed. Such modularity has important implications not only for the details of the lemmatization of Sumerian, but also for the long-term maintenance of cultural heritage resources in digital format and even, as it were, the political economy of the academic research projects that develop and disseminate such resources.³

As long as the first-order corpora and other second-order markups are standardized and public, the long-term maintenance of these resources—some of the most important examples of Mesopotamian cultural heritage available—can be guaranteed by both systematic mirroring of the primary data on the servers of all major projects concerned with Mesopotamian cultural heritage (all CDLI data, for example, are regularly backed up on servers of the Max Planck Institute for the History of Science in Berlin) and by the archiving of the primary data, corpora, and markup by organizations which have the institutional presence to maintain such resources in the long term. But perhaps more importantly, the modular character of individual first-order corpora and the particular second-order markup projects that are linked to them allow research projects that are limited in their temporal span or funding to achieve a finite and practical goal, contribute the results to a central repository, and move on to another project with a different source of funding. Although CDLI is already at work on an Ur III prosopography, if a researcher at another institution were to receive sufficient support so as to develop a prosopography of Umma in the Ur III period, a list of personal names and the `xml:id` codes associated with them could be generated in short order, and the researcher could then build the prosopography as a form of second-order markup along the lines of the lemmatization of the Ur III materials being carried out by CDLI in cooperation with PSD.

The finished prosopography could then be hosted by one of the larger projects, or alternatively, by the researcher himself or herself with `xml:id` links tying the prosopographical analysis to primary data residing on CDLI servers in Los Angeles. Furthermore, if for whatever reason the hypothetical, independent research project should fold entirely, as long as its results are public and archived with the major projects, all is not lost. An Umma prosopography constructed along these lines could quite easily be hosted by one of the major projects, incorporated into other prosopographical work, and even cited as a publication and/or stable research tool available to other researchers in future. While abbreviated methods of citation can quite reasonably be used for the well-known projects such as the “p-numbers” used at CDLI (CDLI P108699), the catalogue plus line number system for ETCSL references (ETCSL 1.8.2.4, line 20), and the citation-form and guide-word system in use at PSD (ePSD ab[*cow*]), the smaller and/or short-term projects in question should presumably be cited as ordinary publications. This is in accord with, for example, a recent resolution of the Linguistic Society of American (LSA) that it “supports the recognition of electronic databases of language material as academic publications” and “as publications for consideration in tenure and promotion cases” (*LSA Bulletin* 187, March 2005, p. 6). Such an approach would also, one hopes, enliven work on the sometimes neglected administrative corpora, renew interest in the study of primary data among the younger scholars in the field, and eventually make all primary data available for free and in a standard format on the Internet.

³ While various people have contributed to the lemmatization effort, the structure of the second-order markup used in our lemmatization

was formulated by Steve Tinney and ongoing discussions with him have informed the model presented here to a great degree.

STORAGE AND ORGANIZATION OF HITTITE GRAMMATICAL KNOWLEDGE*

Carol F. Justus†, University of Texas at Austin

1. GRAMMATICAL KNOWLEDGE

Linguistic traditions have organized grammatical knowledge in different ways. Sumerian lexical and school texts are well known, and Hittite scribes followed cuneiform traditions in creating bilingual and trilingual Sumerian, Akkadian, and Hittite lexical texts.

Structurally, Hittite, spoken at multi-lingual Hattusa where tablets record seven different languages (non-Indo-European Sumerian, Akkadian, Hattic, and Hurrian, beside Indo-European Palaic, Hittite, and Luvian), was more like Greek, Latin, and Sanskrit than it was like its non-Indo-European contact languages. Some of them typically placed the verb at the end of a clause or sentence (Sumerian, Hurrian, Hittite), one seems to have placed it at the beginning (Hattic), and some had postpositions (Sumerian, Hurrian, Hittite), others prepositions (Akkadian and Hattic). Sumerian and Hurrian aligned case roles such as agent and patient on an ergative model, while Hittite and Akkadian alignment patterns were more nominative-accusative than ergative.

How conscious were Hittite scribes of the grammatical differences between Hittite and the other languages of Hattusa? This study examines some of the strikingly paradigmatic structures of the text we know as Mursili's Aphasia to see to what extent its structures might reflect a deliberate repository of Hittite grammatical knowledge.

Post-cuneiform Greek and Latin grammatical traditions categorized words in terms of parts of speech (noun, verb, participle, particle) based on their inflectional categories, while twentieth-century theories of formal grammar beginning with Noam Chomsky's *Syntactic Structures* have tried to define universal grammatical properties based on syntactically related structures such as active and passive:

- 1) active "A murderer killed the man." 2) passive "The man was killed (by a murderer)."

Theories of grammar, trying to formulate the abstractions that explain what speakers intuitively know about relations between such sentences, analyze "kill" as a transitive active verb whose subject is the semantic agent of the action, its object the patient. The passive version makes the patient subject and renders the agent as a "by" phrase or omits it. Such theories assume that active and passive are universal grammatical relations in languages generally, but Hittite does not predictably oppose active and passive. Verb class distinctions seem rather to be based on transitive and intransitive types.

2. MURSILI'S APHASIA

The text of Mursili's Aphasia (CTH 486) has captured the imagination of Hittitologists from Goetze's and Pedersen's philological edition, my own suggestion that its structure was instructional, and Lebrun's updated edition

* The initial version of this paper was presented at the 51^e Rencontre Assyriologique Internationale / Congress of Assyriology and Near Eastern Archaeology held at the University of Chicago's Oriental Institute, July 18–22, 2005. Many points have been sharpened by com-

ments and questions from the audience, including those by Theo van den Hout, Gary Beckman, Baruch Ottervanger, and Ann Guinan. All problems are my responsibility.

that incorporated new fragments, to van den Hout's recent questions concerning its structure and content.¹ This study returns to the purpose of the text. Was it to narrate a historical event, the loss of Mursili's speech, as the beginning of the text leads us to believe? Was it to give instructions on performing a purification ritual, as the rest of the text would indicate?² Was this text a conglomeration of text types with passages lifted from the archives to fit the story?³ Or did the text record grammatical knowledge? The paradigmatic nature of grammatical constructions — primarily the first ten lines of the text — suggests that the structure stores grammatical information.⁴

Examples here are based on the C version with restorations from A and B. As is usual, [] indicate restorations, [()] restoration based on another version, but variants are noted only as they have grammatical relevance. Syllable divisions, which earlier text editions record, are omitted, and where examples are discussed, Hittite phonetic words may replace logograms in order to focus on grammatical structures rather than script details.

This text shows a systematic use of particles which bear relations to topic organization and text cohesion, unlike many rituals with loosely coordinated clause sequences. The text format here highlights the discourse flow as its structures punctuate the paradigms of verbal transitivity. Mursili, his speech, and his chariot are topics, the known background given for the context, but the smallness of Mursili's speech is introduced as a new focal point of the narrative. Verbal structures further the discourse progress in terms of ACTS of Mursili, then of the storm god, and EVENTS to which Mursili is subject.

Text: C KBo 4 2 iii 40 ff. [(A & B)]; *form underlying a logogram, plene written word*.

MAIN TOPIC (known or deictic info) FOCUS (newly relevant info) ANAPHORIC REFERENCE

(III 40) UMMA dUTU-ŠI mMursili LUGAL.GAL “Thus the Sun, Mursili, the Great King”:

<i>I-NA URUTil-Ku[(nmu)]</i> (41) <i>nannahhun</i> “I drove into ...”	ACT 1
<i>nu harsi-harsi udas namma</i> dU(-as) <i>hatug[a]</i> (42) <i>tethiskit</i>	EVENT 1
<i>nu nahun</i> “(with the result that) I feared”	ACT 2
<i>nu=mu=kan memias</i> KA×U-i (*issi) <i>an[(da)]</i> (43) <i>tepawesta*</i>	EVENT 2
<i>nu=mu=kan memias tepu kuit(ki) sara*</i> (44) <i>iyattat</i>	
<i>nu=kan aši meṣiṣar arha=pat paskuwanu[(n)]*</i>	ACT 3
“I forgot / neglected the small(ness) of speech that went up for me”	
(45) <i>mahhan=ma ueir</i> MU ^{HLA} -us (*wittus) EGIR- <i>anda</i> (*appanda) <i>pair*</i>	
<i>nu=mu ui[(t)]</i> (46) <i>aši meṣiṣar teshaniskiuwan tiyat</i>	EVENT 3
<i>nu=mu=kan zazhi*</i> (47) <i>anda ŠU (kessar(as))</i> DINGIR-LIM <i>aras</i>	EVENT 4
KA×U- <i>iss</i> (*aiss)= <i>a=mu=kan tapusa*</i> <i>pait</i>	EVENT 5
(48) <i>nu ariyanun</i> “I made oracular consultation”	ACT 4
<i>nu</i> dU URUManuzziya SIXSÁ-at (*handaittat)	EVENT 6 h. FINDING 1

¹ See Albrecht Goetze and Holger Pedersen, *Murshilis Sprachlähmung*, Det Kgl. Danske Videnskabernes Selskab, Historisk-filologiske Meddelelser 21, 1 (Copenhagen: Levin and Munksgaard, 1934); C. F. Justus, “Visible Sentences in Cuneiform Hittite,” in *Aspects of Cuneiform Writing*, edited by Marvin A. Powell, Jr., *Visible Language* 15 (Cleveland: Museum of Art, 1981), pp. 373–408; René Lebrun, “L’aphasie de Mursili II = CTH 486,” *Hethitica* 6 (1985): 103–37; Theo van den Hout, “Some Thoughts on the Composition Known as Mursili’s Aphasia (CTH 486),” in *Antiquus Oriens, Mélanges offerts au Professeur Lebrun*, vol. 1, edited by Michel Mazoyer and Olivier Casabonne, Collection KUBABA, Série Antiquité 5 (Paris: Association KUBABA, 2004), pp. 359–80. Gary Beckman, “Review of

Hethitica 6,” *Journal of Near Eastern Studies* 47 (1988): 141–43 corrects some of Lebrun’s readings.

² Lebrun, “L’aphasie,” pp. 134 f., in fact suggested changing the title of the text to reflect its ritual content.

³ Van den Hout, based on questions about anomalies in narrative and grammatical flow, suggested that passages were copied from different texts, rejecting Justus’s 1981 suggestion that the text was instructional.

⁴ C. F. Justus, “Syntactic Structures in Mursili’s Aphasia,” To appear in the Proceedings of the Sixth International Congress of Hittitology, Rome, 5–9 September 2005, analyses structures in the rest of the text.

The speaker ACTS (drove, feared, forgot, made oracular consultation), while EVENTS happen to him:

- “a storm broke, the Storm god thundered terribly” (Event 1)
 “the speech in my mouth became small” (Event 2)
 “What(ever) smallness of speech went forth, I forgot/neglected that entirely.
 when the years went and later passed by,
 it happened that that (small) speech began appearing in my dreams” (Event 3)
 “the hand of the god reached me in a dream” (Event 4)
 “and my mouth went to the side (ceased to function⁵)” (Event 5)

This last EVENT unleashed Mursili’s oracular consultation, which shifted focus to the Storm god.

Examples A and B contain paradigmatically variant subjects of *handaittat*:

- A: (49) ^{dU URU}Manuzziya=**ma** katta ariyanun ACT 4 reprised
 nu=ssi^{GUD}puhugaris* piyawanzi IZI-it wahnumanzi
 (51) [(MUŠEN^{HL})^A] wahnumanzi **handaittat** h. FINDING 2
^{GUD}puhugarin*=**ma** (52) [ariy]anun ACT 4 reprised
 n=ašpidi=**ssi** I-NA KUR^{URU}Kummanni
 (53) [I-NA (É)] DINGIR-LIM piyawanzi **handaittat** h. FINDING 3 (see below)
 B: (C IV 26 ff.)... ^{GIS}GIGIR=**ya=kan** turiyan* (27)... (28) **n=at** pennir (TOPIC)
 IŠ-TU ^{GIS}BANŠUR=**ma=za=kan** kuezza* (29) azzikkinun ... (32) (FOCUS)
 kuitta=ya imma UNUTUM anda (33) weriyan esta **nu** Ú-UL **kuitki** dattat
 (34) IŠ-TU DINGIR-LIM QA-TAM-MA **handaittat** h. FINDING 4

“And the yoked chariot ..., they drove it off. But the table from which I ate, ..., and whatever utensil besides that is named, none of that was taken, by the god so it was determined.”

The chariot, topical by association with Mursili, contrasts with new subordinate focus with “relative” *kuezza*, ... , *kuitta*, and *kuitki*.⁶

3. PARADIGMATIC VERB CLASSES

In the first part of the text, the one in which Mursili acts on his own, most verbs are intransitive, and they exemplify a paradigmatic range of intransitive Hittite verb types. The last part of the text, that dealing with the fulfillment of the oracular findings, has many more transitive verbs. This difference between proliferation of intransitive and transitive verbs undoubtedly characterizes the difference between Mursili’s acts and the later ritual acts that are *handaittat* prescribed, but this difference is beyond the scope of this study.

This study stops with the middle verb *handaittat* “be determined, prove to be, turn out to be,” which introduces the storm god of Manuzziya and marks the point where Mursili ceases to act freely and becomes subject to the transitive ritual actions unleashed by his own acts of oracular consultation. The pivotal verb *handaittat* is also the one for which the scribe gives four paradigmatic syntactic uses.

⁵ Van den Hout, “Some Thoughts,” p. 366, idiomatic translation for *tapusa pait*.

⁶ On “relative focus” as new information, see C. F. Justus, “Relativization and Topicalization in Hittite,” in *Subject and Topic*, edited by Charles Li (New York: Academic Press, 1976), pp. 215–45.

The text under discussion has fifteen verbs, thirteen intransitive (with no direct object) and two transitive (with a direct object). It must be remembered that intransitive verbs may be *semantically* both active (“fly,” “sit,” “lie”) and inactive (“happen,” “fall”), even though their lack of a direct object makes them all *syntactically* inactive. In addition to syntactic and semantic verb classes, Hittite verbs also fall into inflectional classes.

3.1. INFLECTIONAL VERB CLASSES

The inflectional verb classes of Hittite, active *-mi*, *-hi*, and middle *-ha(ri)* conjugations, are well known. Less consciously remembered is the fact that, although some middle forms have passive uses, Hittite makes no pervasive active-passive distinction,⁷ despite the instinct of English speakers and speakers of similar western European languages to expect such a distinction. Many Hittite verbs have only middle forms (*kis-* “happen, come about,” *ki-* “lie in place, be placed”), and many only active forms (*kuen-* “strike,” *sak(k)-/sek(k)-* “know,” *ak(k)-ek(k)-* “die”). Active verbs may be semantically agentive or not and are just as often intransitive as are middle verbs.

Inflectional verb class is preserved in English mainly in the semantically insignificant distinction between verbs that take *-ed* in the past tense and those that preserve inherited patterns of vowel alternation such as “sing, sang, sung.” French and Spanish verbs with different infinitives preserve older inflectional verb classes, too (French *parl-er* “to speak” but *mour-ir* “to die,” Spanish *habl-ar* “to speak” but *mor-ir* “to die”), also with little semantic significance. With Hittite inflectional classes, there is still some semantic correlation between the class of active *-mi* and *-hi* verbs as opposed to the class of medio-passive *-ha(ri)* verbs. Middles tend not to be transitive active or have agent subjects,⁸ but Hittite active classes still defy syntactic or semantic generalizations.

Hittite morphological classes, *-mi*, *-hi*, and middle *-ha(ri)* types, all include intransitive verbs, both active verbs such as “strike,” “make,” “place” (*kuen-mi* “strike,” *iya-mi* “make, do,” and *dai-hi* “put, place”) and semantically inactive intransitive (*ak(k)-hi* “die,” *hark(iya)-milhi* “perish”; *kis-* “come about, become,” and *ki-* “lie in place, be placed”). Even active verbs such as “strike,” “make,” “place” are often used intransitively in Hittite (e.g., “I struck, and the enemy fled”). Does Hittite have significant classes of intransitive verbs?

In the Aphasia lines under consideration, there are ten uses of active *-mi* verbs (*tethiskit* “thundered,” *nahun* “I feared,” *tepawesta* “became small,” *paskuwanun* “I forgot / neglected,” *ueir* and *uit* “went (plural),” *pair* and *pait* “went” (singular), *tiyat* “began,” and *ariyanun* “I made oracular inquiry”), three of active *-hi* verbs (*nannahhun* “I drove,” *udas* “broke out,” and *aras* “reached”), and two of middle verbs (*iyattat* “went,” *handaittat*). Only two are transitive (*paskuwanun* and *aras*):

10 Active <i>-mi</i> Verbs	3 Active <i>-hi</i> Verbs	2 Middle <i>-ha(ri)</i> Verbs
<i>tethi-ski-t</i> “thundered”	<i>uda-s</i> “broke out”	—
<i>nah-un</i> “I feared”	<i>nanna-hhun</i> “I drove (into)”	—
<i>tepawes-ta</i> “became small”	—	<i>iya-ttat</i> “went”
<i>paskuwa-nun</i> “I forgot”	—	—
<i>uei-r, pai-r, ui-t, pai-t</i>	—	—
<i>tiya-t</i> “entered”	<i>ara-s</i> “reached” (trs.)	—
<i>ariya-nun</i> “I asked by oracle”	—	<i>handai-ttat</i> “it was determined, proved to be”

The Aphasia text begins with verbs that appear to be morphologically similar. Verbs *nannahhun* and *nahun* at first glance both look like *-hi* verbs. It is tempting to parse them *nanna-hhun* and **na-hun*. In fact only *nanna-hhun* is a *-hi* verb as the *-h-* belongs to the root of *-mi* verb *nah-un*. Is the contiguous placement of these verbs a coincidence?

⁷ See already Johannes Friedrich, *Hethitisches Elementarbuch, Teil 1, Kurzgefasste Grammatik*, 2nd ed. (Heidelberg: C. Winter, 1960), p. 136, § 256.

⁸ Erich Neu, *Interpretation der hethitischen mediopassiven Verbalformen*, StBoT 5, and *Das hethitischen Mediopassiv und seine indoger-*

manischen Grundlagen, StBoT 6 (Wiesbaden: Harrassowitz, 1968), found that Hittite middle verbs include a wide range of grammatical meanings, including many associated with cognate middle forms in Greek and Sanskrit. See also J. Friedrich, pp. 135 f., § 254.

Verbs *ariya-mi* “make oracular consultation” and *ar-hi* “reach” occur later in proximity. Is the transitive root (*ar-hi*) of *ar-as* “reached” thereby contrasted with intransitive *ar-ia-mi* “make oracular consultation”? Is the scribe pointing out that the more numerous *-mi* verbs such as *ariya-* can be intransitive, that *-hi* verbs may range from transitive *aras* to absolute intransitive *udas*?

Morphologically *tiya-mi* “step, go” and *ariya-mi* “make oracular consultation” both end in *-iya-*. The first, *tiya-mi* “step, go,” is often used synonymously with *dai-* “set, place” as auxiliary with the dependent supine (see here *teshaniskiuwan tiyat* “began appearing in [my] dreams”) in the meaning “begin (to do).” Are both intransitive derivatives in *-iya-*?

Lexical forms here also seem to be semantically synonymous. Three intransitive verbs in these first ten lines mean “go”: active *-mi* verbs *uwa-* and *pai-* (see below) and middle verb *iya-ha(ri)* of *=mu ... sara* iyattat* “(small speech) went up for me.”

3.2. SYNTACTIC VERB CLASS

Verb classes in English and most western European languages are subdivided according to transitivity. Syntactically transitive active verbs like “kill” take direct objects and have passive counterparts like “be killed” by contrast with intransitive verbs such as “fly,” “happen,” “sit,” “die.”⁹

3.2.1. Transitive Verbs and Passives

The temptation is to expect Hittite actives such as “strike,” “make,” “place” to have passive counterparts, “be killed (by),” “be made (by),” “be placed (by).” Well-known Hittite suppletive pairs frustrate this expectation. Instead of related passive forms for Hittite active *kuen-mi* “strike,” *iya-mi* “make, do,” and *dai-hi* “put, place,” unrelated roots express counterpart intransitive meanings with *ak(k)-hi* “die,” *kis-ha(ri)* “happen, come about, become,” and *ki-ha(ri)* “lie in place, be placed.”¹⁰ Neu’s exhaustive study of Hittite middle verbs in fact found that middle forms, far from having predictable passive meanings, might have transitive¹¹ as well as intransitive syntax.

Of the inflectionally diverse verbs at the beginning of Mursili’s Aphasia, only two are transitive (*-mi* verb *paskuwa-nun* “I forgot,” *-hi* verb *ara-s* “reached” with direct objects). They have as subjects Mursili (*asi memian paskuwanun* “I forgot / neglected that speech”) and “the hand of the god” (Sumerogram ŠU may stand for common gender Hittite *kessarar* or neuter *kessar* as subject of *nu=mu ... aras* “reached me”). Objects are Mursili’s (maimed) speech and Mursili. Even if we had more data, one doubts that they would attest such passive counterparts as “the speech was forgotten (by Mursili)” or “Mursili was reached in a dream (by the hand of the god).” The verb *ar-* has only active *-hi* forms, and middle forms of *paskuwai-* are transitive (see Neu’s examples).

3.2.2. Intransitive Absolute Syntax

Many intransitive verbs are used absolutely, with only a subject and no object or further argument or modification. Absolute intransitive subjects here are common gender animate (Mursili with *nahun*, *ariyanun*, the Storm god with *handaittat*) or inanimate (*harsi-harsi udas*, *ueir *wittus* “years went”). In the sentence *harsi-harsi udas* literally, “(there) brought a storm” (“a storm broke out”), “storm” is the logical object of *uda-* “bring,” although the English translation with the neuter as subject is more idiomatic. With impersonal subjectless constructions such as *nu=mu uit* “to me went, it happened to me” the oblique argument is semantically closer to the role of *harsi-harsi* than to an agent or actor. A minimal difference, however, separates syntactically parallel constructions and *nu=mu uit harsi-harsi udas*. Although both have absolute syntax, the first has a neuter patient noun, the second the personal oblique pronoun “me.”

⁹ David J. Allerton, *Valency and the English Verb* (New York: Academic Press, 1982), gives a much more detailed account of English syntactic verb classes.

¹⁰ See Friedrich, *Hethitisches Elementarbuch*, p. 136, § 256.

¹¹ Neu, *StBoT* 6, pp. 54–83. See, for example, transitive *paskuwai-* “forget, neglect” (middle *paskuitta*), *parsiya-* “break (bread),” *ibid.*, pp. 55 f.

3.2.3. Intransitive Verbs with Other Modification¹²

At least as many intransitive verbs here have only adverbial or preverbal modification (*hatuga tethiskit* “thundered terribly,” *appanda pair* “(years) afterwards went/passing”) or add the indirect object enclitic =*mu* with an adverb or preverb (*aiss=a=mu tapusa pait* “and my mouth went to the side,” =*mu* ... *sara* iyattat* “(small speech) went forth for me”). Adverbial and preverbal modification then contrasts with postpositional noun phrase modification: See **issi anda* “mouth in,” and *zazhi* anda* “dream in” (= *mu* ... *issi anda tepawesta* “(speech) in my mouth became small,” with transitive verb *aras* “reached”: = *mu zazhi anda* ... *aras* “in a dream ... reached me”). Beneath the Akkadographic preposition *I-NA* (*I-NA* ^{URU}*Til-Kunnu nannahhun* “into Til-Kunnu I drove”) undoubtedly lies a Hittite grammatical form. One expects a Hittite dative-locative case here, but this proper noun may well be invariant.

3.3. INTRANSITIVE SEMANTIC VERB CLASSES

Semantically intransitive verbs differ with regard to the type of subject, whether personal (animate or common gender) actor or a neuter more likely to be thematic or semantically objective. Subjectless absolute constructions *harsi-harsi udas* “there came a storm” and *nu=mu uit* “it happened to me” differ with regard to the semantics of the accompanying noun (see above). Personal verbs *nahun*, *ariyanun*, and *ueir *wittus* “years went” further differ with regard to whether the subject is an animate actor or simply a common gender subject. Verbs with personal animate subjects are semantically active as opposed to semantically inactive impersonals.

In the text, semantically absolute impersonal *harsi-harsi udas* “storm broke” is paired with personal ^d*U hatuga tethiskit* demonstrating that Hittite has both constructions for saying virtually the same thing. These two constructions contrast grammatically with regard to the semantic class of the subject. The verb of the impersonal construction here is *-hi* verb *uda-hi*, the personal *-mi* counterpart *tethiski-mi*, is derived from *tetha-hi*, which has impersonal uses. We cannot, however, conclude that impersonal verbs are *-hi* verbs, but the possible class of Hittite impersonal verbs deserves further study.

Two uses of *uwa-mi* “go” are juxtaposed, the personal *ueir *wittus* “the years went” and the impersonal *nu=mu uit* “it happened (went) to me (that) ...,” and personal uses of *pai-mi* “go” contrast now an adverb of time (**wittus appanda pair* “years afterward passed/went by”) with an adverb of space meaning “move in a direction” (*aiss=a=mu=kan tapusa pait* “my mouth went to the side”).

In summary, Hittite intransitive verbs may belong to any one of three inflectional classes, and pairs *nannahhun* and *nahun* belong to minimally different *-hi* and *-mi* classes. Lexical forms *uwa-mi*, *pai-mi*, and *iya-ha(ri)* all refer to some variation on “go.” Syntactically, intransitives are absolute or augmented by adverbial or oblique modification. Intransitives are personal or impersonal, as demonstrated by pairs, impersonal *harsi-harsi udas* “a storm broke” and personal ^d*U hatuga tethiskit* “the storm god thundered terribly” or *ueir *wittus* “the years went” and *nu=mu uit* “it happened to me (that ...)” These and other pairs are unlikely to be coincidence. Such minimal lexical, inflectional, syntactic, and semantic shades of intransitivity would seem to reflect a deliberate exemplification of transitivity types.

3.4. *handaittat*

This verb, pivotal to the development the textual narrative, focuses on two further aspects of Hittite verbal transitivity. On the one hand, *handaittat* is ambiguously intransitive impersonal or passive with an omitted agent. On the other hand, it differs syntactically from impersonal *udas* and *uit* in that it takes a personal subject. At the same time, the subject need not be a simple (personal) noun phrase, but may be expanded in at least two different kinds of (impersonal) verbal constructions embedded as subordinate clauses.

¹² Uses of connective and aspectual particles such as *nu*, *namma*, and =*kan* are beyond the scope of the transitivity issues discussed here.

3.4.1. Intransitive or Passive *handaittat*?

Study of *handai*-¹³ identified active meanings “prepare, (make) ready, fix,” middle meanings “be ready, be certain” (“feststehen”), and Late Hittite passive meanings “be determined, confirmed” (“feststellen”). While active forms of *-mi* verb *handai*- mean “prepare, fix, make ready,” its passive counterpart does not mean “be prepared (by)” but “be determined.” Nor is “determine” the active counterpart of passive “be determined (by).” From what base meaning might these meanings of *handai*- be derived? What sort of derivational pattern might underlie these meanings?

In the Aphasia text, the first use of *handaittat* is in line iii 48, *nu* ^{dU URU}*Manuzziya handaittat* where it expresses the finding that results from Mursili’s oracular inquiry, *nu ariyanun*, “I made oracular inquiry (and) the storm god of Manuzziya was determined” or “Upon oracular inquiry, the storm god ... proved to be (the one), turned out to be (the one).” Middle *handaittat* typically expresses the result of an oracular inquiry.

Grammatically, the resulting storm god of Manuzziya is the subject of either passive “is determined” (with implied agent) or of intransitive impersonal “proved to be, turned out to be.” Given the problems with analyzing *handaittat* as a grammatical passive of active “prepare,” it may be reasonable to analyze *handaittat* as an intransitive (non-agentive) middle. If so, in the context of *ariya*- “make oracular consultation” with a non-agentive resultant *handaittat*, the intransitive translation “prove to be, turn out to be” may be preferred to the passive (implied agentive) “be determined, be confirmed.” Would an active meaning then be closer to “prove the correctness of a preparation, fix as correct”?¹⁴

On the other hand, a passage (iv 33–34) adds the ablative or instrumental argument *IŠ-TU DINGIR-LIM* (**siuniyaz* or **siunit*) to *handaittat*:

[*nu natta kuitki dattat*]_{Subject} “that not anything (more) was taken”

**siuniyaz* or **siunit* *apenissan handaittat*

“by the god was so determined” or “proved so through /according to the god”

Is this an ablative of agent “determined by the god” or an impersonal instrumental complement “through/according to the god” without any necessarily presumed agency? An ablative agent fits the passive translation “is determined by the god” and presupposes an active agency, while the instrumental complement fits the intransitive translation “it proves to be so according to the god.”

If *handaittat* is impersonal with no deity’s will implied in the resultant finding, then the middle meaning “be ready, be certain” may be more basic than active “prepare” and lend itself to an active extension “ascertain” and equally impersonal middle “prove to be, turn out to be.” Alternatively, a Late Hittite passive (Old Hittite has middle only meanings) would represent a new passive *handai-ha(ri)* beside older middle “be ready, prepared” corresponding to active *handai-mi*. Only the intransitive analysis, however, would resolve the problem that “be determined” is not the passive of an active “prepare.”

3.4.2. Subjects of *handaittat*

Assuming that *handaittat* is an intransitive middle similar to *iyattat* “went,” its syntax differs from that of (*memias*) *iyattat*. Although both take personal (or common gender) subjects, middle *handaittat* allows four different kinds of syntactic subject structures. The first (1) is the simple noun phrase “Storm god of Manuzziya”:

(1) iii 48 *nu* { ^{dU URU}*Manuzziya* }_{SUBJECT} **handaittat*

“the storm god of Manuzziya proved to be (the one)/was determined”

handaittat also takes infinitive clauses (2 and 3), or a clause with a finite verb as subject (4).

¹³ Paola Cotticelli-Kurras, *handai-*, *Materialien zu den hethitischen Thesaurus 11* (Heidelberg: C. Winter, 1989), has organized the data for this verb and found that passive uses do not occur in Old Hittite, only in Late Hittite.

¹⁴ Study of lexical texts such as Sumerian *gi-na*: *gi-na* = [k]i-na = *ku-un-nu-u* = *ha-an-da-a-u-wa-ar* KBo 1 35 + KBo 26 25 iv 12’ in MSL 17 117 and comparison with CAD definitions of Akkadian may further delineate the semantics of this word (Akkadian *kunnu* is not the only lexical equivalent).

- (2) iii 49–51 ^{dU URU}Manuzziya=**ma** katta ariyanun Oracular Consultation
 { **nu=ssi** ^{GUD}puhugaris* piyawanzi INFINITIVE SUBJECT 1
 IZI-it wahnumanzi INFINITIVE SUBJECT 2
 (51) [(MUŠEN^{HL})^A] wahnumanzi INFINITIVE SUBJECT 3 }_{SUBJECTS}
handaittat h. FINDING 2

“I made the Storm god the subject of oracular consultation:

(as a result) him a substitute ox to give, with fire to burn, birds to burn (INF’s)

proved to be (the answer).”

In (2) the subject of *handaittat* consists of three coordinated subordinate noun clauses, all governed by infinitive verb forms (*piyawanzi*, *wahnumanzi*, *wahnumanzi*). With the first “to give” nominative *puhugaris*¹⁵ is both syntactically subject of *handaittat* but semantically logical object of “give,” which takes the dative object (=ssi). With the second infinitive (*wahnumanzi*) the logical object is understood to be that of *piyawanzi* plus an additional instrumental argument (IZI-it “with fire”). A third infinitive subject clause (with a second *wahnumanzi*) replaces *puhugaris* with “birds” (MUŠEN^{HL.A}) as logical object.

- (3) iii 52–53 ^{GUD}puhugarin=**ma** [ariy]anun Oracular Consultation
 { **n=as** pidi=ssi I-NA KUR ^{URU}Kummanni (53) [I-NA (É)] DINGIR-LIM piyawanzi }_{SUBJECT}
handaittat h. FINDING 2

“Then I made the substitute ox the subject of oracular consultation. For him to be given instead of him (Mursili) in Kummanni in the temple **proved (to be the answer).**”

In (3) there is only one infinitive (*piyawanzi*), but it takes a string of oblique noun arguments. The ox (nominative =as “he”) is again syntactic subject of *handaittat* and logical object of the infinitive (“give”) which here also has three oblique objects, first the dative (of purpose?) *pidi=ssi* “in his place, for him,” then the locative I-NA KUR ^{URU}Kummanni “in Kummanni,” and a final, more specific locative [I-NA (É)] DINGIR-LIM “in the temple” precede the infinitive. The scribe seems to be showing us here that the infinitive may take a large number of case role relations, but if it has a subject, the subject is still in the nominative case as subject of *handaittat*.

In (4: iv 32–34) the noun clause subject of *handaittat* ends in the finite verb *dattat*.

- (4) { **kuitta=ya** imma UNUTUM anda (33) *weriyān esta* (“RELATIVE” FOCUS)¹⁶
nu Ú-UL kuitki *dattat* (FINITE SUBORDINATE VERB) }_{SUBJECT}
 (34) IŠ-TU DINGIR-LIM QA-TAM-MA (**apenissan*) *handaittat h. FINDING 4*

“{(And for whatever utensil is named) nothing was taken,
 so it proved (to be) according to the deity.”

In (4), not only is the subject noun clause formed with a finite verb, but the subject of the noun clause is modified by focused “relative” subordinations. One subordinate clause is piled on another. An idiomatic English counterpart orders clauses 1, 3, 2:

“It turned out according to the deity_{MAIN CLAUSE(1)}
 {that nothing {that is named}_{FOCUSED RELATIVE(3)} was taken}_{SUBJECT CLAUSE(2)}”

¹⁵ See Friedrich, *Hethitisches Elementarbuch*, pp. 143 f., §§ 275, 276, concerning the nominative case as subject of an infinitive. Gary Holland, “An Indo-European Raising Construction,” Paper presented at the Seventeenth International Congress of Historical Linguistics (August 3, 2005) suggested that arguments of Hittite subordinate infinitive clauses, as infinitives do not make active-passive voice distinctions, take their case from the verb of the main clause by the process of “raising.” This is compatible with J. Friedrich’s analysis in *Hethitisches Elementarbuch*, pp. 143 f., §§ 275, 276. So the ox is syntacti-

cally nominative as subject of *handaittat*, regardless of its logical semantic relation to “give.” The Aphasia text shows that the infinitive has its own dependent oblique arguments.

¹⁶ In the fuller context, a series of “relative” focus clauses name particular items (Mursili’s table, cup, bed, and wash basin), all parallel (coordinate) with the *kuitta* clause. Since they are not syntactically different in relation to *dattat* and *handaittat*, they can be omitted for simplicity’s sake. The analysis is the same.

Because Hittite puts the main verb at the end, *handaittat* ends the Hittite sequence, whereas English tends to begin with the main verb (“it turned out”), reversing the order of main (1) and subordinate subject noun clause (2). But English linearly embeds relative clauses (3) between the head noun (antecedent: “nothing”) and the rest of the clause to which it is subordinate (“[nothing] was taken”), so the relative clause “that is named” (3) precedes “was taken” (2) but follows “nothing” (subject of 2). In Hittite, however, all subordinate verbs precede the clause to which they are subordinate, the most subordinate first. So the Hittite order is “that/whatever is named (3), nothing was taken (2), turned out (1).” This results in a multiple layering of recursively subordinate structures to the left.

These four examples illustrate the range of subjects that *handaittat* can take: a simple noun phrase (1), a series of coordinate infinitive noun clauses (2), a single infinitive noun clause with a string of arguments dependent on the infinitive (3), and a complex noun clause with a finite verb and its own dependent relative modification (4). This in itself is worth noting for two reasons. Studies of the infinitive¹⁷ have mainly listed verbs that take an infinitive construction and how they are related semantically to the voice of the main verb, not the range of constructions that a single verb takes. The verb *handaittat* here shows that one verb can be construed with a range of subject noun constructions. These examples also demonstrate a sophisticated layering of recursive (subordinate) and coordinate structures. For a language that is generally thought to be paratactic (coordinating, lacking real subordination), the Hittite scribe has taught us with his *handaittat* paradigm that Hittite has a number of subordinate structures that contrast with coordinate uses.

4. CONCLUSIONS

We lack Hittite terms for abstract distinctions between categories that Aristotle called *onoma* “name” and *rhema* “verb,” but Hittite scribes at Hattusa assigned terms, *arkuwar*, *mugawar*, and *malduwar*, to distinguish abstract prayer types.¹⁸ In lieu of similar grammatical terms, did Hittite scribes compose entire texts to exemplify abstract grammatical categories and constructions? Such texts might have aided a multilingual staff of scribes or clarified the changing usage of a chronologically changing language.

However that may be, the colophon of Mursili’s Aphasia identifies it as “When in Til-Kunnu the Sun Mursili heard the thunder.” This does not identify the content with any text category, be it ritual (as suggested by Lebrun, pp. 134–36), historical narrative (the beginning purports to be the words of Mursili, the king), or grammatical model, but it does suggest a view of it as cohesive, not a random compilation. The advent of the king’s aphasia must have been a well-known event that would have allowed for the illustration of compositions in different styles (e.g., historical narrative, ritual instruction). The inherent interest of this event may have made it easier for scribes to access knowledge about grammatical structure and genre by recalling famous compositions based on it.

The facts that the narrative sequence, as van den Hout pointed out, is problematic and that, as Lebrun pointed out, the text genre is ambiguous, raise legitimate questions about the purpose of the text. Yet Lebrun’s commentary to his edition of the text (pp. 122–31) pointed out that different ways of writing the same word and the paleography of sign shapes argued for different versions by different scribes, all versions that post-dated the events described. Yet the text ends as if the final sacrifice had not yet been made (“if the ox dies on the way, take another and proceed according to old tablet instructions”). If the extant versions of this text were all written well after the events, why was there no mention of how it all ended? For example, did Mursili recover? But if versions of the text were intended to encode abstract principles of Hittite grammar for ongoing consultation, information about the result would be of less interest than the grammatical forms of a well-known essay.

¹⁷ See Fritz Ose, *Supinum und Infinitiv im Hethitischen*, Mitteilungen der Vorderasiatisch-Aegyptischen Gesellschaft 47, 1 (Leipzig: J. C. Hinrichs, 1944). Ose did show that one verb might have either a simple noun or an infinitive noun clause as object (e.g., *memai*- p. 41). Variant morphological forms of nonfinite verbals, however, not their syntactic distribution, has attracted more attention.

¹⁸ Emmanuel Laroche, “La Prière hittite: vocabulaire et typologie,” in *Annuaire, École Pratique des Hautes Études, Cinquième Section des Sciences Religieuses* 72 (Paris, 1964–65), defined a Hittite sys-

tem of prayer terminology. Since then others have built on it. C. F. Justus, “What is Indo-European about Hittite Prayer?” in *Offizielle Religion, lokale Kulte und individuelle Religiosität, Akten des religionsgeschichtlichen Symposiums “Kleinasien und angrenzende Gebiete vom Beginn des 2. bis zur Mitte des 1. Jahrtausends v. Chr.”* (Bonn, 22.–22. Februar 2003), edited by Manfred Hutter and Sylvia Hutter-Braunsar (Münster: Ugarit-Verlag, 2004), pp. 269–83, takes the terminology seriously as an Indo-European Hittite attempt to deal abstractly with prayer structures.

The best argument for viewing this text as a paradigmatic grammatical model, however, is the fact that morphological, syntactic, and semantic types of intransitives are economically laid out side by side. Most striking of all are the four paradigmatic forms for subjects of *handaittat*.

Post-cuneiform grammatical traditions have identified lexical categories based on morphological word classes (conjugation and declension classes in Greek and Latin). Recent theories of formal grammar distinguish hierarchical and recursive relations in syntactic arrangement and continue to refine lexical subcategories more precise than noun, verb, adjective, and particle. Hittite scribes' paradigmatic variations on intransitive verb types and syntactic subject structures suggest that Hittite scribes understood lexical subcategorization, distinguished hierarchical (subordinate) structures from coordinate ones, and could embed layers of subordination.

While Sanskrit grammarians were refining their descriptions of Sanskrit morphology that culminated in Panini's *Eight Books*, Hittite scribes may well have developed a school for working out patterns of verbal syntax and semantics. Given the peculiar multilingual environment of Hattusa, issues of transitivity must have posed problems. Speakers of the ergative Hurrian language would have dealt with transitivity differently than speakers of a language like Hittite that had predominantly nominative-accusative case alignment. The facts that, well after the events of the Aphasia narrative, Hittite scribes had three or four separate copies and that it illustrated minimally different uses of a number of intransitive constructions argue for its status as a repository of grammatical knowledge. We can only imagine how much has been lost or not yet recognized.

SUMERIAN ENCLITIC -ÀM AND AKKADIAN ENCLITIC -MA: FROM COPULA TO FOCUS MARKER*

Fumi Karahashi, Chuo University, Tokyo

Past research has established that phrases containing the enclitics -àm (Sumerian) and -ma (Akkadian) are focus-marking constructions. Sumerian -àm is the third person singular enclitic form of the verb me “to be.” The Akkadian -ma of interest here has the so-called non-coordinating function. These particles may attach to any part of speech.¹ The translation equivalence between the two constructions with -àm and -ma was already noted in the Old Babylonian Grammatical Texts (OBGT), and the functional identity of these constructions with English cleft sentences has been pointed out.

A topic that remains to be addressed explicitly, however, is the morphosyntactic form of these focus-marking constructions. In this paper, I would like to suggest that the status of -àm and -ma as focus particles developed from a prior stage in which each was originally the copula in a cleft construction.

Before discussing the details of this hypothesis, I review the terminology and theoretical background of focus-marking constructions.

1. THEORETICAL BACKGROUND

In analyzing focus-marking constructions, it is convenient to introduce the notion of “open proposition.”² Open propositions are derived from ordinary sentences by replacing one of the sentence’s constituents with an indefinite expression, or variable, as illustrated in examples (1) and (2).

(1) Sentence:

John was driving a new car yesterday

(2) Associated open propositions:

- a. x was driving a new car yesterday
- b. John was driving x yesterday
- c. John was driving a new car at x time

* I am grateful to my colleagues and the graduate students in the Tablet Room in the University Museum for their criticism and comments. My special thanks are due to Beatrice Santorini, who provided me with the current linguistic theory and literature of focus-marking constructions and helped me to develop this paper through many discussions. Needless to say, all flaws and errors are of course mine alone. I also thank the University of Pennsylvania Museum of Archaeology and Anthropology for having granted me the Robert H. Dyson Fellowship for the academic year 2004/2005, during which this paper was written. Abbreviations used here are as follows: ACC = Accusative, CP = Conjugation prefix, COP = Copula, DAT = Dative, DEM = Demonstrative, ENC = Enclitic, F = Focused Constituent, GEN = Genitive, M = Masculine, NOM = Nominative, NML = Nominalizer, NP = Noun Phrase, OP = Open Preposition, Pl = Plural, RC = Relative Clause, REL = Relative, St = Stative, SUB = Subjunctive, 1 = first person, 3 = third person.

¹ For Sumerian, see Marie-Louise Thomsen, *The Sumerian Language: An Introduction to Its History and Grammatical Structure*, Mesopotamia 10 (Copenhagen: Academic Press, 1984), §§ 541–46; for Akkadian, see André Finet, *L'accadien des lettres de Mari* (Brussels: Palais des académies, 1956), § 100.

² Ellen Prince, “On the Syntactic Marking of Presupposed Open Propositions,” in *Papers from the Parasession on Pragmatics and Grammatical Theory* (22nd Regional Meeting), edited by A. Farley et al. (Chicago: Chicago Linguistic Society, 1986), pp. 208–22; for a critical review of several information-packaging theories and advantages of Focus/Open-proposition, see Enric Vallduví, “The Informational Component” (Ph.D. diss., University of Pennsylvania, 1990), pp. 35–53.

Focus-marking constructions are constructions whose discourse function consists in explicitly identifying the variable in an open proposition. The function of focus-marking can be expressed by a variety of different forms, both across and within languages. Presently, we are going to see three such forms: intonation, particles, and cleft.³ First, however, we note that focus-marking need not be expressed by a particular morphosyntactic form at all, but may be indicated solely by intonation. An English example is given in (3), where F marks the focused constituent, OP the open proposition, and the capital letters indicate intonational prominence.

(3) Focus marking by intonation:

- a. [_FJOHN] was driving a new car yesterday
 Interpretation: [_{OP}x was driving a new car yesterday] and x = John
- b. John was driving [_Fa new CAR] yesterday
 Interpretation: [_{OP}John was driving x yesterday] and x = a new car
- c. John was driving a new car [_FYESTERDAY]
 Interpretation: [_{OP}John was driving a new car x] and x = yesterday

A second form of focus-marking relies on specific particles or postpositions, such as Japanese **-wa**, illustrated in example (4).⁴

(4) Focus marking by particle:

- a. John-**wa** kinou atarasii kuruma-o untensiteita
 John-F yesterday new car-ACC was driving
 Interpretation: [_{OP}x was driving a new car yesterday] and x = John
- b. atarasii kuruma-**wa** John-ga kinou untensiteita
 new car-F John-NOM yesterday was driving
 Interpretation: [_{OP}John was driving x yesterday] and x = a new car
- c. kinou-**wa** John-ga atarasii kuruma-o untensiteita
 yesterday-F John-NOM new car-ACC was driving
 Interpretation: [_{OP}John was driving a new car x] and x = yesterday

Such focus particles regularly supersede ordinary case marking as in example (5). This phenomenon is observed in many languages.

- (5) a. *John-ga-**wa** kinou atarasii kuruma-o untensiteita
 John-NOM-F yesterday new car-ACC was driving
- b. *John-**wa**-ga kinou atarasii kuruma-o untensiteita
 John-F-NOM yesterday new car-ACC was driving
- c. *atarasii kuruma-o-**wa** John-ga kinou untensiteita
 new car-ACC-F John-NOM yesterday was driving

³ For a cross-linguistic description of focus-marking, see Talmy Givón, *Syntax: A Functional-Typological Introduction*, vol. 2 (Amsterdam and Philadelphia: John Benjamins, 1990), pp. 699–737.

⁴ Note that the word order varies in (4a) and (4b). In this paper, however, I will not deal with any word-order variation that might be involved in focus-marking constructions, a topic for a future study.

- d. *atarasii kuruma-wa-o John-ga kinou untensiteita
 new car-F-ACC John-NOM yesterday was driving

Finally, focus-marking can be expressed by means of so-called cleft sentences. In such sentences, the functional division into focus and open proposition is reflected in the syntactic form of the sentence. Specifically, the focused constituent is expressed as the predicate of a copular clause, and the open proposition is expressed as a subordinate of some sort. Example (6) illustrates *it* cleft sentences in English.⁵

- (6) Focus marking by cleft syntax:
- a. It is [_FJohn] that [_{OP}was driving a new car yesterday]
 - b. It is [_Fa new car] that [_{OP}John was driving yesterday]
 - c. It is [_Fyesterday] that [_{OP}John was driving a new car]

Now, with this theoretical framework in mind, let us go back to the Sumerian and Akkadian focus-marking constructions. Typical sentence types that this paper covers are those of examples (7a) (Sumerian) and (7b) (Akkadian).

- (7)
- a. ur-sağ-ğá-àm á mu-gur
 hero-ENC arm CP-bent (Gudea Cyl. A v 2–3)⁶
 - b. šū-**ma** ilik-šu illak
 he-ENC service obligation-his he.fulfills (Laws of Hammurabi § 31)⁷

Are the particles—Sumerian -àm and Akkadian -*ma*—true focus particles, corresponding to Japanese -*wa*? Or are these particles copulas in a cleft sentence, corresponding to the English *it* cleft? Under the first analysis, the enclitic has a focus-marking force of its own. Under the second, focus-marking force is inherent in the syntactic form of the entire sentence, but not in the enclitic itself.

In what follows, we take a look at OBG T I, and then discuss Sumerian -àm and Akkadian -*ma* in turn.

2. OBG T I

OBGT I (text A: CBS 19791) was published in 1956⁸ and partly discussed by Thorkild Jacobsen in 1974.⁹ The text dealt with what Jeremy Black termed “grammatical vocabulary,” listing personal and demonstrative pronouns, adverbs, and adverbial expressions of place, time, and manner.¹⁰ One of the notable features throughout OBG T I is

⁵ English has a variety of other cleft sentences, but only *it* clefts are relevant for the present discussion.

⁶ Dietz Otto Edzard, *Gudea and His Dynasty*, Royal Inscriptions of Mesopotamia, Early Dynasties 3/1 (Toronto: University of Toronto Press, 1997), p. 72; ETCSL 2.1.7 (Jeremy Black et al., Electronic Text Corpus of Sumerian Literature, <http://www-etcsl.orient.ox.ac.uk>).

⁷ Martha T. Roth, *Law Collections from Mesopotamia and Asia Minor*, Writings from the Ancient World 6 (Atlanta: Scholars Press, 1995), p. 87.

⁸ B. Landsberger et al., *Materialien zum sumerischen Lexikon* (Rome: Pontificium Institutum Biblicum, 1956), pp. 47 ff. The text is re-designated as OBG T I/1 by Niek Veldhuis, “Grammatical Texts in

Their Intellectual Contexts,” *Acta Sumerologica (Japan)* 22 (2000; published in 2005): 242. It is assumed to be a large 16-column tablet, originally containing some 1,200 lines, of which about half is preserved. The scanned photos of the tablet by Kevin Danti and the text collated by me will be made available on the Internet in the near future.

⁹ Thorkild Jacobsen, “Very Ancient Texts: Babylonian Grammatical Texts,” in *Studies in the History of Linguistics: Traditions and Paradigms*, edited by D. Hymes (Bloomington and London: Indiana University Press, 1974), pp. 41–62.

¹⁰ Jeremy Black, *Sumerian Grammar in Babylonian Theory*, *Studia Pohl*, Series Maior 12 (Rome: Biblical Institute Press, 1984), pp. 4, 55f.

that entries containing the enclitic -àm in the Sumerian column correspond to entries containing the enclitic -*ma* in the Akkadian column, as shown in example (8).

(8) OBG I 301 ff.

a.	301	[lú-e-b]i-da man-this-its-with	<i>qadum</i> together with	<i>annîm</i> this.GEN
b.	303	[lú]-e-bi-da-àm man-this-its-with-ENC	<i>qadum</i> together with	<i>annîm-ma</i> this.GEN-ENC
c.	307	lú-ne-da man-that-with	<i>itti</i> with	<i>annîm</i> this.GEN
d.	311	lú-ne-da-kam man-that-with-GEN+ENC	<i>itti</i> with	<i>annîm-ma</i> this.GEN-ENC

The entries in (8b), which contain -àm in Sumerian and -*ma* in Akkadian, are in contrast with the entries in (8a), which do not contain these particles. Similarly, the marked expressions of (8d) contrasted with the unmarked expressions of (8c).¹¹ This paradigmatic list shows that Old Babylonian scribes understood that the Sumerian enclitic -àm and the Akkadian enclitic -*ma* were functionally equivalent.¹²

3. SUMERIAN ENCLITIC -ÀM

According to Adam Falkenstein's grammar of Gudea,¹³ (1) the enclitic copula developed into an emphasis marker; (2) it is often hard to distinguish whether the enclitic functions as copula or emphasis marker; and (3) the case-marking postposition is sometimes replaced by the enclitic copula. About twenty years after Falkenstein's study, in 1968, Gene Gragg elegantly explained Falkenstein's observations, applying generative/transformational grammar to Sumerian.¹⁴ Gragg's pioneering study has been the only one dealing with the Sumerian copula from a modern syntactic perspective.¹⁵ Among Gragg's sentence types with the enclitic copula, his example 16 iv on p. 94 is of interest here (reproduced here as Example 9).

- (9) šulgi + àm uru + šè ì-du
 šulgi COP city to CP-goes
 “(He, who is) Šulgi goes to the city”

Gragg views the clause with the enclitic -àm as a RC, with the non-overt head noun “he.” Although this is certainly possible, another plausible interpretation is to take this sentence as a cleft construction: “(it is) Šulgi (who) goes to the city.”

¹¹ For the Sumerian demonstratives *e* and *ne*, see Christopher Woods, “Deixis, Person, and Case in Sumerian,” *Acta Sumerologica (Japan)* 22 (2000; published in 2005): 303–09.

¹² Jacobsen interpreted these particles specifically as having “delimiting force” and translated them as “only” (“Very Ancient Texts,” p. 48).

¹³ A. Falkenstein, *Grammatik der Sprache Gudeas von Lagaš, II: Syntax, Analecta Orientalia* 29 (Rome: Pontifical Biblical Institute, 1950), pp. 32–35.

¹⁴ G. Gragg, “The Syntax of the Copula in Sumerian,” in *The Verb ‘Be’ and Its Synonyms*, edited by J. W. M. Verhaar, Foundations of

Language Supplementary Series 8 (Dordrecht: D. Reidel, 1968), pp. 86–109.

¹⁵ Cf. W. Heimpel, “Observations on Rhythmical Structure in Sumerian Literary Texts,” *Orientalia* NS 39 (1970): 492–95; H. L. J. Vanstiphout, “Some Notes on ‘Enlil and Namzitara,’” *Revue d’Assyriologie* 74 (1980): 68–70; Pascal Attinger, *Éléments de linguistique sumérienne: La construction de du₁₁/e/di “dire,” Orbis Biblicus et Orientalis Sonderband* (Freibourg: Éditions Universitaires; Göttingen: Vandenhoeck & Ruprecht, 1993), § 206 b 4°.

Now consider example (10a) (= 7a), attested in the Gudea corpus. I argue that sentences like this must be derived historically from originally cleft constructions.¹⁶ Example (10b) is a reconstructed cleft formation, where -àm is the copula and the open proposition is the subordinate clause.

- (10) a. ur-sağ-ğá-àm á mu-gur
 warrior-ENC arm CP-bent
 “The warrior bent his arm” (Gudea Cyl. A v 2–3)
- b. *ur-sağ-ğá-àm á mu-gur-ra
 warrior-COP arm CP-bent-NML
 “It is the warrior who bent his arm”

I conclude that the enclitic -àm, based on its use in cleft sentences, was reanalyzed in the history of Sumerian as a true focus particle. In other words, speakers of Sumerian transferred the focus-marking force of the entire cleft sentence to the enclitic, a development that is observed cross-linguistically. Example (11) is one such example, found in Kihungan (a Bantu language).¹⁷

- (11) a. Cleft: Kwe Kipes wu a-swiim-in kit
 be K. DEM he-buy-PAST chair
 “It’s Kipes who bought the chair”
- b. Focus-particle: kwe Kipes a-swiim-in kit
 be K. he-buy-PAST chair
 “(It’s) Kipes (who) bought the chair”

Example (11a) is a cleft construction with the subordinate open proposition, while in (11b), the copula is reanalyzed as a focus particle and the open proposition is not parsed as a subordinate clause. The two constructions are synchronically attested in Kihungan, but (b) is thought to be derived from (a). (a) is a construction analogous to the English cleft sentence and (b) is a construction analogous to that of the Japanese focus-particle *-wa*.

When the Sumerian particle -àm is attached to a constituent, it supersedes ordinary case-marking, a phenomenon that we have already seen in connection with the Japanese focus-particle *-wa* (Example 5). In Example (10b), -àm replaces the ergative postposition on the noun ur-sağ “warrior.” In other words, attachment of this particle causes neutralization of the case particles, as Falkenstein observed.

4. AKKADIAN ENCLITIC -MA

In his 1976 article, “Enclitic *-ma* and the Logical Predicate in Old Babylonian,”¹⁸ Anson Rainey analyzes the enclitic *-ma* in sentences such as shown in Example (12a) (= 7b) as marking what he calls the logical predicate¹⁹ or focus in more conventional terms. He translates such sentences using English cleft sentences,²⁰ and his proposal is generally followed by other scholars.²¹

¹⁶ Christian Huber, “Some Remarks on Focus and Relative Clauses in Sumerian,” *Acta Sumerologica (Japan)* 22 (2000; published in 2005): 98, refers to the possibility of focus in “cleft-like constructions” of the enclitic copula, but stops short of further exploring the issue.

¹⁷ Givón, *Syntax*, p. 719.

¹⁸ *Israel Oriental Studies* 6 (1976): 51–58.

¹⁹ Rainey maintained this view in his later articles, “Topic and Comment in Byblos Akkadian,” *Bibliotheca Orientalis* 49 (1992): 333, and “Topic and Comment in the Amarna Texts from Canaan,” in

Ki Baruch Hu: Ancient Near Eastern, Biblical, and Judaic Studies in Honor of Baruch A. Levine, edited by R. Chazan et al. (Winona Lake: Eisenbrauns, 1999), p. 69.

²⁰ His translation of Example 12a is: “It is he who will fulfill the *ilku*” (Rainey, “Enclitic *-ma*,” p. 50).

²¹ J. Huehnergard, *A Grammar of Akkadian*, Harvard Semitic Studies 45 (Atlanta: Scholars Press, 1997), § 29.2; Eran Cohen, “Akkadian *-ma* in Diachronic Perspective,” *Zeitschrift für Assyriologie* 90 (2000): 207–26.

- (12) a. *šū-ma ilik-šu illak*
 he-ENC service obligation-his he.fulfills
 “He will fulfill his service obligation” (Laws of Hammurabi § 31)
- b. **šū-ma ša ilik-šu illak-u*
 he-COP REL service obligation-his he.fulfills-SUB
 “It is he who will fulfill his service obligation”

I agree with the pragmatic interpretation of such sentences. Yet one question is left unaddressed: the proper analysis of the morphosyntactic form. As I mentioned before, in cleft constructions the focused constituent is expressed as the predicate of a copular clause and the open proposition as a subordinate clause. Therefore, for our example to be a cleft, I would expect sentences like (12b), although such a construction is, to my knowledge, not attested.²² However, given the formal identity of the Akkadian focus particle with the copula and given the frequency with which focus particles develop out of copulas, I speculate that the Akkadian focus particle *-ma*, too, represents an instance of reanalysis of the copula, along the lines of Sumerian *-àm*. I recognize that there are difficult problems and questions concerning whether the Akkadian *-ma* has a function analogous to the copula or not, but to my mind, the copular interpretation seems to make sense.²³ In this connection, let me mention one bilingual example, the Old Babylonian literary composition Inana C (in-nin šag₄-gur₄-ra).²⁴

- (13) NP *ḏinana za-a-kam*
 inana you-GEN+COP
 NP *ku-(um)-ma eštar*
 yours-COP eštar
 “NP (triumph, quarrel, etc.) is yours, Inana / Eštar”

I would say that the Akkadian *-ma* here marks the grammatical predicate of the otherwise verbless clause and that it is thus a good functional parallel to the Sumerian copula.

Now, note example (14), which is an interrogative sentence with the interrogative pronoun *mannum* “who?”

- (14) *mannum-ma ša ibnû tuquntu*
 who.NOM-COP REL he.created.SUB rebellion.NOM
 “Who was it that created the rebellion?” (En. el. VI 23)

It is a cleft construction, with a relativized open proposition. A declarative counterpart of the construction in (14) is the one that I reconstructed in (12b) as an original cleft sentence.²⁵

²² Cf. another solution proposed by Cohen, “Akkadian *-ma* in Diachronic Perspective,” p. 214, who sees “the former syntactic role of *-ma* as a substantivizing converter whose function was to convert the following clause into a primary.”

²³ For the interpretation of the predicate function of *-ma*, see W. von Soden, *Grundriss der akkadischen Grammatik*, 3rd ed., Analecta Orientalia 33 (Rome: Pontificium Institutum Biblicum, 1995), § 126 c; J. Huehnergard, “On Verbless Clauses in Akkadian,” *Zeitschrift für Assyriologie* 76 (1986): 238 n. 74; N. J. C. Kouwenberg, “Nouns as Verbs: The Verbal Nature of the Akkadian Stative,” *Orientalia* NS 69 (2000): 34; Guy Deutscher, *Syntactic Change in Akkadian: The*

Evolution of Sentential Complementation (Oxford: Oxford University Press, 2000), pp. 33 f. For different interpretations, see F. R. Kraus, *Nominalsätze in altbabylonischen Briefen und der Stativ* (Amsterdam: North-Holland Publishing Company, 1984), pp. 45 f.

²⁴ Åke W. Sjöberg, “in-nin ša-gur₄-ra: A Hymn to Goddess Inanna by the en-Priestess Enheduanna,” *Zeitschrift für Assyriologie* 65 (1975): 161–253; ETCSL 4.07.4.

²⁵ I have no explanation for the discrepancy/asymmetry between questions and declaratives. However, the question why there is no (or, supposed to be no) corresponding declarative sentences with an explicit *ša* and an explicit subjunctive-marker should be addressed.

Let me end the discussion of Akkadian *-ma* with some passages from the Old Babylonian Gilgameš. A constituent in each sentence contains *-ma*, showing either copular function (*šārum-ma*) or focusing function. Several categories of notional typology of emphasis are discussed by Buccellati in his 1996 grammar,²⁶ which I have used in my translation, given below. The translation of *-ma* is indicated by underlining.

- (15) *ilū-ma* *itti* *dšamšim* *dāriš* *u[šbū]*
 gods.NOM-ENC with sun.GEN forever they.dwelted
- awīlūtum-ma* *manû* *ūmū-ša*
 mankind.NOM-ENC numbered(St.3MPI) days.NOM-her
- mimma* *ša* *ītenepuš-u* *šārum-ma*
 everything REL he.does-SUB wind.NOM-COP
- atta* *annānum-ma* *taddar* *mūtam*
 you.NOM here-ENC you.are.afraid death.ACC

“Only the gods have d[welled] forever under the sun

As for a man, his days are numbered

Whatever he does is wind

Hence you will be afraid of death!” (Gilg. Y [= OB III] iv 141–44)²⁷

5. CONCLUSION

I have suggested that the status of *-àm* and *-ma* as true focus particles developed from a prior stage in which each was the copula in cleft constructions. In each case, this phenomenon conforms to cross-linguistic data.

²⁶ Giorgio Buccellati, *A Structural Grammar of Babylonian* (Wiesbaden: Harrassowitz, 1996), § 66.9: Verification, Limitation, Contrast, Excellence, and Addition.

²⁷ Akkadian text after Andrew George, *The Babylonian Gilgamesh Epic*, vol. 1 (Oxford: Oxford University Press, 2003), p. 200.

THE CLASSIFICATION OF INCANTATIONS

W. G. Lambert, University of Birmingham

At a first glance it appears that Sumerian and Babylonian incantations are excellently classified by the ancients. There is a “classical” formula prefixed to incantations and thus specifying their library category: *én-é-nu-ru*. In the Early Dynastic incantations from Fara and Ebla it occurs with many orthographic variations, and occasionally with a prefixed *tu₆* (also with orthographic variations).¹ This “classical” form carried over into the Akkadian and Ur III periods, where it is normal, though occasionally it is lacking and rarely it is put at the end of a piece. In copies of incantations from the second and first millennia it is not so frequent, but can also occur at the end as well as at the beginning. More commonly, indeed very regularly, *én* alone is written at the beginnings of incantations in copies of these two millennia. The sign means of course “incantation,” but so far we do not know the meaning of *é-nu-ru*, and it may be suspected that at least after Early Dynastic times the ancients did not know either. Hence the frequent use of *én* alone.

The incantations from Fara and Ebla also have a stock closing formula: *KA+UD-dug₄-ga* at Fara, *UD-dug₄-ga* at Ebla, always immediately followed by the name of the goddess *Nin-girimma* in various orthographies.² The phrase either means “incantation” or refers to such. This stock ending gradually died out during the Akkadian and Ur III periods, no doubt because *Enki/Ea* was then commonly acknowledged, also in the second and first millennia, as the god responsible for incantations.³ However, there was a development from this old Sumerian stock ending in Akkadian incantations, typically:

	<i>šiptu ul iuttun šipat</i> (one or more gods)
	The incantation is not mine, it is the incantation of (one or more gods).
(if one god)	<i>iddīma anāku ašši</i>
	He “cast” it, I “lifted” it.
(if more gods)	<i>šunu iqbūnimma anāku ušanni</i>
	They told it to me, I repeated it. ⁴

There is a real difference between these opening and closing formulae. The closing words are part of the incantation, specifying the divine origin to guarantee its effectiveness. Though it incidentally marks the end of the incantation, that was not its actual purpose. In contrast, though it is possible that *én-é-nu-ru* had a meaning in the Early Dynastic period and formed the opening sentence of the incantation, it is clear that over time any such meaning was forgotten so that it was commonly replaced by *én* alone. While this means “incantation,” it was almost certainly like a cuneiform determinative: a marker in the script to communicate something to the reader, but not to be pronounced. It was then a real classifier.

Other, more specific classifiers appear at the end of Ur III copies of incantations (there are too few Akkadian period copies surviving to offer evidence):

- i) The left edge of N. 2187, both sides of which are covered with a Sumerian incantation, offers: *nam-šub eridu(NUN)^{k(i)}(?)* “Incantation of Eridu,” i.e., “of Enki.”⁵

¹ Manfred Krebernik, *Die Beschwörungen aus Fara und Ebla: Untersuchungen zur ältesten keilschriftlichen Beschwörungsliteratur*, Texte und Studien zur Orientalistik 2 (Hildesheim: Georg Olms, 1984), pp. 197–207.

² Krebernik, *Beschwörungen*, pp. 208–10.

³ W. G. Lambert, “A Catalogue of Texts and Authors,” *Journal of Cuneiform Studies* 16 (1962): 69.

⁴ Lambert, “Catalogue,” pp. 72–73.

⁵ E. Huber, “Die altbabylonischen Darlehnstexte aus der Nippur Sammlung im K. O. Museum in Konstantinopel,” in V. M. de Calry et al., *Hilprecht Anniversary Volume* (Leipzig: J. C. Hinrichs, 1909), pp. 219–22. This placing of this rubric is misconstrued in Johannes J. A. van Dijk and Markham J. Geller, *Ur III Incantations from the Frau Professor Hilprecht-Collection, Jena* (Wiesbaden: Harrassowitz, 2003), p. 12 line 23B. Read line 21B end: [h₃-ma]-ta-ga[z-e].

- ii) The reverse of a small incantation tablet offers two classifiers on the reverse, separated by a blank line:
- igi-gig ša₆-da-kam To cure a sick eye.
zú muš? Snakebite.⁶
- iii) An incantation in four columns of narrow lines ends:
- én-é-nu-ru munus-a-kam It concerns a woman.⁷
- iv) A duplicate of i) above has both the classifying ending and a fuller rubric:
- tu₆-dug₄-ga ^dnin-girimma
Spell of Nin-girimma.
nam-šub eridu(NUN)^{ki} èš-^den-ki-kam
Incantation of Eridu, of the house of Enki.⁸
- v) A tablet with a single incantation adds at the bottom of the reverse, after a blank space, a-gúb-kam: “It concerns a holy water vessel.”⁹
- vi) This tablet also offers a single incantation and gives its rubric at the bottom of the reverse, after a blank space:
- lú muš zú ba-dù a-bi lú-kúr-ra na₈-na₈-da-kam
A snake bit a man. Concerning giving the appropriate water to the bitten man to drink.¹⁰
- vii) Still another tablet with a single incantation and rubric at the bottom of the reverse after a blank:
- dug sag-gá nigin-da-kam
Concerning twirling a vessel on the head.¹¹
- viii) Yet another small tablet with a single incantation offers both a “classical” ending followed by an apparent rubric, then after a gap a more conventional rubric:
- tu₆-én-é-nu-ru gír kun SIG₇
Smashing a scorpion’s tail.
ka-inim gír šu-a DU-da-kam
Conjuration about putting(?) a scorpion in the hand.¹²

What stands out in this Ur III material is the lack of uniformity. Each scribe seems to have felt free to make his own choice, though the ending -kam, literally “it is of,” is relatively frequent. The last example is an early occurrence of what became virtually universal later: incantation rubric, usually marked out by rulings before and after, beginning ka-inim-ma, literally “mouth of the word,” but in practice a term for “incantation.” One thing is clear from it: incantations were recited aloud. The lack of the final -ma in the example just cited is of course a matter of early orthography alone.

The material from the second and first millennia is vast in comparison with what survives from the third millennium, and it has not been subjected to systematic study so far. The ancients indeed did better than moderns in this matter. A catalogue of text types of religious and magic content was formed, excluding literature in the strict sense. This survives in a Neo-Assyrian copy, KAR 44, and in three less well-preserved Late Babylonian duplicates, all edited, the Babylonian tablets for the first time, by M. J. Geller, “Incipits and Rubrics,” in *Wisdom, Gods and Literature* (Winona Lake: Eisenbrauns, 2000), edited by A. R. George and I. L. Finkel, pp. 242–54. The first twenty-six lines

⁶ Van Dijk and Geller, *Ur III Incantations*, p. 26, No. 5, lines 5–6.

⁷ David I. Owen, *Neo-Sumerian Archival Texts Primarily from Nippur in the University Museum, the Oriental Institute, and the Iraq Museum (NATN)* (Winona Lake: Eisenbrauns, 1982), No. 8.

⁸ Van Dijk and Geller, *Ur III Incantations*, p. 12, No. 1, lines 22–23.

⁹ Heinrich Zimmern, *Sumerische Kultlieder aus altbabylonischer Zeit*, vol. 2, Vorderasiatische Schriftdenkmäler der Königlichen Museen zu

Berlin, vol. 10 (Leipzig: J. C. Hinrichs, 1913), No. 190. See also van Dijk and Geller, *Ur III Incantations*, pp. 76–77, No. 5.

¹⁰ Zimmern, *Sumerische Kultlieder*, No. 193. See also van Dijk and Geller, *Ur III Incantations*, p. 21, No. 4, line 28.

¹¹ Van Dijk and Geller, *Ur III Incantations*, p. 41, No. 10.

¹² J. J. A. van Dijk, M. I. Hussey, and Albrecht Götze, *Early Mesopotamian Incantations and Rituals*, Yale Oriental Series, Babylonian Texts 11 (New Haven: Yale University Press, 1985), No. 37.

are fully preserved and are ascribed to a scholar named Esaggil-kīn-apli. Two Babylonian tablets which contain these lines add that this scholar was “son of Asalluḫi-mansum (or, Marduk-iddinam?), sage of Hammurabi, king of Babylon.” This extra item is also found in a colophon attached to the series Sag-gig (“Headache”), which adds the further detail that Esaggil-kīn-apli worked in the time of Adad-apla-iddina, who was king of Babylon ca. 1069–1047 B.C.¹³ There is no reason to doubt the dating to Adad-apla-iddina, though the involvement of Hammurabi is questionable.¹⁴ Following on Esaggil-kīn-apli’s collection, all the copies, save one inadequately preserved Babylonian tablet, add a supplement, with a difficult ending, but not naming any compiler of this supplement. Geller extracted no fewer than ninety-two series titles from these two sections. Not all are incantations, but many are, and though the majority of titles have known representation among tablets published in the modern world, very few indeed have modern editions of all known pieces. Since one title can cover a series of tablets and a large number of incantations, the grand total must be huge.

Before proceeding further a basic question must be put: What is an incantation? To us an answer comes readily: an incantation is a text to be recited which brings magic power to bear, usually when recited with observation of some rite or rites. It unlocks a certain power in the universe which the person reciting either wants or needs. Many of the Sumerian and Akkadian texts identified by the introductory or concluding words described above are of this kind. “Magic spells” would be an equally proper designation of them. However, many Sumerian and Akkadian texts prefixed with *én* and written down during the second and first millennia are not of this kind but are properly called prayers. They address gods in a rational fashion and by a mixture of flattery, polite requests, and other techniques of persuasion try to push the god in question to grant what is wanted using his divine power to that end. The prefixing of *én* to such texts has led to the coinage of the German term *Gebetsbeschwörung* in the works of W. G. Kunstmann¹⁵ and W. Mayer.¹⁶ The latter author showed his awareness of the problem by use of quotation marks and discusses the issue on pp. 22–23. He concludes that *šiptu* came to be used of prayers because they were, like incantations, recited in the course of rituals. The various words themselves in part confirm this conclusion, namely *ka-inim-ma* and *nam-šub*, while *én* and *tu₆* offer no light whatsoever. The Akkadian *šiptu* is a noun from the root *wšp*, of which the verb occurs only in the II stem, meaning “to effect results by use of incantations.” However, the I stem participle (*w*)*āšip(t)u(m)* occurs, for the person expert in the use of incantations. Thus it is worth considering the possibility that the verb (*w*)*uššupu(m)* is a denominative. No cognates have been noted in the other Semitic languages.

Other problems beset the meaning of *én* and *nam-šub*. In the Sumerian epic Enmerkar and the Lord of Aratta, the former sends a messenger to the latter with demands and instructs him to recite to the latter “the spell of Nudimmud” (*nam-šub* *ḏnu-dīm-mud-da-kam*: line 135). This spell (lines 135–55) is a story variously interpreted today.¹⁷ It describes a time when the human race lived in peace and security when Enki changed (in time past) the one original human language into the many languages used in the author’s time, or when Enki will in the future change the current multiplicity of languages into one. The passage is not only grammatically open to such different interpretations, but its function in the story is totally obscure. We are not told that the messenger did in fact recite the spell to the Lord of Aratta, and its purpose is very obscure. Other incantations of more usual type contain short myths, but they are clearly related to the purpose of the text.¹⁸ Ancient magic may hold meanings that we do not perceive.

While the benefits to us of the ancient classification are clear, their limitations also need consideration. A suitable example is provided by the *ša-zi-ga* incantations, conveniently assembled by R. D. Biggs in *Šà-zi-ga*,¹⁹ to which the following page references and text numbers refer. *Šà-zi-ga* occurs among the ninety-two titles listed by M. J. Geller, and there is a catalogue of *ša-zi-ga* incantations from Assur, with a few ritual tablets and tablets of magic

¹³ Irving L. Finkel, “Adad-apla-iddina, Esaggil-kīn-apli and the Series SA.GIG,” in *A Scientific Humanist: Studies in Memory of Abraham Sachs*, edited by Erle Leichty and Maria deJ. Ellis, Occasional Publications of the Samuel Noah Kramer Fund 9 (Philadelphia: University Museum, 1988), p. 148, lines A54–55.

¹⁴ See Lambert in Ira Spar and W. G. Lambert, *Literary and Scholarly Texts of the First Millennium B.C.*, Cuneiform Texts in the Metropolitan Museum of Art 2 (New York: Metropolitan Museum of Art, 2005), p. xviii.

¹⁵ *Die babylonische Gebetsbeschwörung*, Leipziger semitistische Studien, n.F., 2 (Leipzig: J. C. Hinrichs, 1932).

¹⁶ *Untersuchungen zur Formensprache der babylonischen “Gebetsbeschwörungen,”* Studia Pohl, Series Maior 5 (Rome: Biblical Institute Press, 1976).

¹⁷ For the two views, see most recently Thorkild Jacobsen in *Canonical Compositions from the Biblical World*, The Context of Scripture 1, edited by W. W. Hallo (Leiden: Brill, 1997), pp. 547–48; and H. L. J. Vanstiphout, *Epics of Sumerian Kings: The Matter of Aratta*, Writings from the Ancient World 20 (Atlanta: Society of Biblical Literature, 2003), pp. 62–65 and 93–94.

¹⁸ For example, a myth about the founding of the major Sumerian shrines occurs in an incantation for use in repairing or rebuilding these shrines. See most recently Claus Ambos, *Mesopotamische Baurituale aus dem 1. Jahrtausend v. Chr.* (Dresden: ISLET, 2004), pp. 199–207.

¹⁹ *Ancient Mesopotamian Potency Incantations*, Texts from Cuneiform Sources 2 (Locust Valley, New York: J. J. Augustin, 1967).

stones included (pp. 11–16). The catalogue is divided into two parts by a double ruling, like the big Assur listing of a series: apparently a main collection and supplement. But a glance through the surviving šà-zi-ga incantations reveals a great lack of consistency. From time to time a rubric ka-inim-ma šà-zi-ga appears within rulings at the end of the individual incantation, while the incantations themselves often end tu₆-én. But No. 2, an incantation which from content and inclusion of its incipit in the šà-zi-ga catalogue is certainly of this category, offers tu₆-en at the end of its text, but after a ruling there is a ritual section and no rubric. No. 9 is clearly šà-zi-ga from the content, but the following rubric between rulings is:

ka-inim-ma DIŠ NA *ana* MUNUS GIN^{ka} LÁ
 “Mouth of the word”: if a man cannot have intercourse with a woman.

No. 10 offers a line of ritual instruction without any ruling:

én *an-ni-ti* 3-šú ŠI[D-nu] x x
 You recite this incantation three times ...

Then, within rulings four more lines of ritual instructions follow. No. 11 also offers a ritual section after the incantation, but no rubric. No. 12 offers nothing after the incantation. Nos. 13, 15, 19, and 21 (the last part restored) all end the incantation with tu₆-én, have a following ritual, but no rubric. No. 27 has the rubric:

ka-inim-ma *maš-taq-ti* [š]à-zi-ga
 “Mouth of the word”: for loss(?) of šà-zi-ga.

The situation with šà-zi-ga could easily be paralleled in other types of incantation. While there was a classification, one cannot rely on its being marked. The use of rubrics is haphazard.

Šà-zi-ga is, however, a specific category for a very special need. More incantations and prayers are more general in their petitions and in consequence the same texts could be used in different contexts. I. L. Finkel incidentally contributed much to this topic.²⁰

Thus the same incantations can appear in different contexts with differing rubrics. The rubric alludes to the use to which the incantation or prayer was put, not necessarily to the purpose intended by the original compiler. Of course, so long as the discernible purpose of the text is not compromised by its use, this is in no sense a critical comment. However, there are cases where the use to which an incantation or prayer was put is not altogether appropriate.

A clear example is offered by one of the Dingir-šà-dib-ba-gur-ru-da-kam prayers,²¹ which may bear the rubric:

ka-inim-ma dingir-šà-dib-ba-gur-ru-da-kam
 “Mouth of the word” for appeasing an angry god.

One such prayer (p. 276, ll. 55–63) has nine lines and is closely related to another of eight lines (p. 295). This is known from four copies, of which one has no rubric. Another has the rubric for appeasing an angry god, the other two have different rubrics:

ka-inim-ma šu-íl-la ^dEN.ZU-[kam]
 “Mouth of the word”: a hand-raising prayer to Šin.
 ka-inim-ma šá igi-du₈-a ^dsin ħul sig₆-ga-[kam]
 “Mouth of the word” for the appearance of Šin, to alleviate evil.

Both forms of this prayer have the same general content: the supplicant wants his “fear” (*adirtu*) to be taken away to the Apsû. The longer form begins:

én *ili-i*₁₄ *el-lu ba-an kul-lat niš*^{meš} *at-tú*
ana-ku a-ku-ú a-dir-ti ma-³-da-at
er-še-tum ma-ħi-rat a-na apsû a-dir-ti liš-du-ud
 p. 276, lines 55–57, with variants

²⁰ “Muššu’u, Qutāru, and the Scribe Tanittu-Bēl,” *Aula Orientalis* 9 (1991): 91–104, note p. 102: “The Muššu’u [“Rubbings”] incantations are as just demonstrated drawn from a variety of sources, chiefly *Di’u* (SAG.GIG) and *Utukki Lemnūti*”

²¹ Lambert, “Dingir.šà.dib.ba Incantations,” *Journal of Near Eastern Studies* 33 (1974): 267–322.

My god, holy one, creator of all the peoples are you.
 I am feeble, my fear is much.
 May the earth, which received it, draw my fear to the Apsû.

The shorter version begins:

én bēlu UD.SAR kul-la-ti bi-ni-ti
a-šar it-ti šammī^{hi.a} eršetim^{tim} a-dir-ti ul-du
[k]i-ma hi-ri-ti ana apsû a-dir-ti liš-du-ud
 p. 295, lines 1–3, with variants

Lord, crescent/light of all creation,
 Where the earth bore my fear along with the plants,
 Let (the earth) draw my fear as in a ditch to the Apsû.

The first observation to be made is that the shorter form is more original. It is addressed to Sîn, whether one interprets UD.SAR as *askār* with the variant *a[s-*, or *nannar* with the other variant *na-an-na-ru*, and it adds the mythologem that (in the beginning) earth bore plants, known also in Hebrew from Genesis 1:11–12, then asks for earth to take the petitioner’s fear to the Apsû, along a water course. The concept of sins being expunged by being taken down to the Apsû, normally by a river, is well known. Other malign cosmic forces could also be so treated. But when this piece was being taken over into a series for “appeasing an angry god,” i.e., any angry god, the specific mention and allusion to Sîn had to be changed. Then *ki-ma hi-ri-ti* was changed, whether deliberately or in error, to KI (= *eršetum*) *māḥirat*, which is hardly good Akkadian syntax, and so the allusion to the myth about the origin of plants was excised. It was not relevant to the angry god. The next three lines in both texts repeat at length the idea of cosmic water coming to the rescue of the petitioner and continue to concur in the line:

lišdud arni lā pāliḫi maḥarka lilqe
 May it draw the guilt of the irreverent and take it before you.

Then the two versions conclude their piece with protestations of piety in the hope of salvation.

A careful reading of both versions fails to bring out any hint of the petitioner’s having offended a god so that he was consumed with “fear.” The mention of the “irreverent” in the third person clearly refers to someone other than the petitioner. The god is being asked to help dispose of the petitioner’s “fear.” Its cause is not considered. Thus as read the text is not about appeasing an angry god. This idea has to be read into it in view of the rubrics.

More examples could be given, but the conclusion is clear. The rubrics of the ancient scholars do not necessarily refer to the purpose of the texts as written, but sometimes refer rather to the purpose for which they are being used, to the context of their use.

TEXTS AND LABELS: A CASE STUDY FROM NEO-SUMERIAN UMMA*

Romina Laurito, Alessandra Mezzasalma, Lorenzo Verderame
Università di Roma “La Sapienza”

1. INTRODUCTION

The Ur III texts constitute the largest corpus of economic and administrative documents in the entire Mesopotamian civilization and, more generally, in all antiquity.¹ Clay tablets were the principal medium of registration, but other media were adopted. Labels of different shapes were used for archival and for administrative purposes. The authors of this paper are interested in the relation between tablets and labels in the Ur III period and have combined archaeological and epigraphic data in this study. In this paper we focus on a distinctive peculiar typology of labels, both inscribed and sealed, that come from Umma and that register monthly accounts of regular deliveries (Sumerian sa₂-du₁₁). The reasons underlying this choice include:

1. the standardized shape of the objects;
2. the high number of examples;
3. the relationship between labels and a well-known typology of administrative documents written on tablets, i.e., the sa₂-du₁₁² and “messenger” texts;³
4. the recurrence of the same officials.

* The present work is a collaboration of the authors. It is not possible to distinguish each person’s contribution; for academic purposes we assign the research on the epigraphic sources to Lorenzo Verderame, the archaeological analysis of the “messenger” texts labels (§2) to Romina Laurito, and those of the annual and sa₂-du₁₁ diġir-re-ne labels to Alessandra Mezzasalma (§§3–4). Table 1 summarizes all the data related to the texts analyzed in this paper. The quotations of the texts follow Marcel Sigrist and Tohru Gomi, *The Comprehensive Catalogue of Ur III Tablets* (Bethesda: CDL Press, 1991); Walther Sallaberger, “Ur III-Zeit,” in *Mesopotamien: Akkade-Zeit und Ur III*, edited by Pascal Attinger and Markus Wäfler, *Orbis Biblicus et Orientalis* 160/3 (Göttingen: Vandenhoeck & Ruprecht, 1999), pp. 121–414; a complete and updated list is available from the CDLI (<http://cdli.ucla.edu/Tools/abbrev.html>). According to the practice in Neo-Sumerian studies, dates are expressed by an abbreviation of the king’s name (Š = Šulgi, AS = Amar-Su’en, ŠS = Šu-Su’en, IS = Ibbi-Su’en), followed by the year, the month (in roman numerals), and the day.

¹ For a recent overview of all the Ur III tablets, see Manuel Molina, “The Corpus of Neo-Sumerian Tablets: An Overview,” in *Studies on the Administration of the Ur III State*, edited by Steven Garfinkle and Cale Johnson (forthcoming).

² Walther Sallaberger, *Der kultische Kalender der Ur III-Zeit*, *Untersuchungen zur Assyriologie und Vorderasiatischen Archäologie* 7/1–2 (Berlin: Walter de Gruyter, 1993), pp. 81 ff.

³ For an overview of these documents from Umma and Ġirsu, recording daily standard rations to traveling officials, generally known as “messengers” (§2), see Francesco Pomponio and Palmiro Notizia, “I ‘messenger texts’: la più numerosa categoria di testi nella documentazione neo-sumerica,” in *L’ufficio e il documento: I luoghi, i modi, gli strumenti dell’amministrazione in Egitto e nel Vicino Oriente Antico*, Quaderni di Acme 83, edited by Clelia Mora and Patrizia Piacentini, (Milan: Cisalpino, 2006), pp. 175–90; and for an analysis of the Umma texts, see Robert C. McNeil, “The ‘Messenger Texts’ of the Third Dynasty of Ur” (Ph.D. diss., University of Michigan, 1971); Franco D’Agostino and Francesco Pomponio, *Umma Messenger Texts in the British Museum, Part One (UMTBM I)*, NISABA 1 (Messina: Di.Sc.A.M., 2002), pp. 11–18. See also Maria Elena Milone and Gabriella Spada, *Umma Messenger Texts in the British Museum, Part Two (UMTBM II)*, NISABA 3 (Messina: Di.Sc.A.M., 2003); Franco D’Agostino and Lorenzo Verderame, *Umma Messenger Texts in the British Museum, Part Three (UMTBM III)*, *Rivista degli Studi Orientali* 76, supplement 2 (Pisa and Rome: Istituti Editoriali e Poligrafici Internazionali, 2003). A comprehensive study of the “messenger” texts from Umma and Ġirsu is being carried out by Francesco Pomponio, Palmiro Notizia, and Lorenzo Verderame.



a



b



c

Figure 1. (a) An example of a sa_2 - du_{11} label, BM 115846 (Courtesy of the Trustees of the British Museum), (b) detail of oxidized manganese on the surface, OrSp 47–49 405 (from CDLI), and (c) detail of the pre-sealing procedure, Nik 2 248 (from CDLI).

1.1. ARCHAEOLOGICAL FEATURES

To date we have identified sixty-nine pyramidal-shaped labels from Umma dated from AS 5 to IS 1 (table 1). They are highly standardized in shape with regular features. Made from clay, they are pyramid shaped and were most probably hung from a container, as is indicated from the imprint of a cord that emerged through the apex (fig. 1a).

The objects are small, ranging 46–60 mm × 43–50 mm × 35–39 mm. A hole, through which a cord would have emerged, measures ca. 13–15 mm, the diameter of each single thread ranging from between 3 and 5 mm.⁴ The labels were formed directly around a knot, or more precisely, around a tangle of two or three twisted threads. Further evidence of the uniformity in manufacture is indicated by the position of the knot; completely enclosed by the object, it is found at an average depth of 40–42 mm.

The technique for firing these clay labels in antiquity was uniform and resulted from a purposeful action rather than, for example, an accidental fire.⁵ In the administrative sphere such practices may indicate that the objects needed to be archived and were therefore fired after having served their original purpose as labels. Although their context is unknown, the presence of oxidized manganese⁶ on the surfaces indicates that they were all lying in a homogenous archaeological deposit (fig. 1b). It has not yet been possible to define exactly what sort of deposit this was, whether a dumping area or a true archive. Nor has the hypothesis that they come from the same context, which is the most likely, been verified.

Before being inscribed, the labels were repeatedly sealed, often on the same side. When more space was needed, scribes also used the base. The seal impression can be found on any of the four faces of the object including the base, and it is here that they are most visible. The cylinder seals were rolled in the same direction on each side of the label, although not always in the direction of the cuneiform script. Great care was taken to ensure that the impression of the legend was clear and priority was given to this rather than to the seal's iconographical motif. Contemporary sealed tablets⁷ provide further evidence of this practice: the scribe avoided the space occupied by the legend—a truly distinctive element of Neo-Sumerian glyptics.

The practice of sealing the document prior to writing on it (pre-sealing) may indicate an administrative procedure that is separate and entirely different from the act of writing and sealing the text (fig. 1c).⁸ Whereas the final sealing procedure served as a signature corroborating the contents, the act of pre-sealing probably points to the existence of an administrative sector where activities were recorded, i.e., using a modern analogy, similar to the use of letterheads where the value is in the indication of authority, the official or the office responsible for writing up the document following the “in-house” style.

The collection revealed that five officials used their seals to pre-seal the labels, and on a few occasions certain labels show the impressions of seals of two officials, Ur-^dNun-gal and Lu₂-kal-la. It is very rare to find two individuals' seal impressions on a single document; indeed, it has been previously noted only in specific legal texts and other very exceptional cases.⁹

⁴ All dimensions refer to labels kept in the British Museum and a careful analysis of the available photos of labels confirms their standardized size.

⁵ Christopher Walker, Deputy Keeper, Western Asiatic Department of the British Museum, personal communication. Regarding the collection preserved in the Library of J. Pierpont Morgan, see Clarence E. Keiser, *Cuneiform Bullae of the Third Millennium B.C.*, Babylonian Records in the Library of J. Pierpont Morgan, vol. 3 (New York: Yale University Press, 1914), p. 17.

⁶ These oxides, recognizable by black or brown ramifying aggregates on the surfaces of clay objects, are very common in archaeological deposits where the soil contains manganese; see Giovanna Bandini, Silvio Diana, and Giolj Guidi, “Studi preliminari per la rimozione di macchie nere da reperti ceramici, vetri e ossei. I) diagnosi; II) terapia; III) indagini di laboratorio,” in *2° Conferenza internazionale sulle prove non distruttive, metodi microanalitici e indagini ambientali per lo studio e la conservazione delle opere d'arte*, Perugia, 17–20 aprile 1988 (Rome: Istituto Centrale per il Restauro, 1988), vol. 2, session 3 n. 2, pp. 1–18. These black pigments could be easily identified in the photos available in the CDLI, such as Nik 3 512, 514; OrSp 47–49 341, 373, 405, 407, 457.

⁷ Francesco Pomponio, Franco D'Agostino, and Romina Laurito, *Neo-Sumerian Texts from Ur in the British Museum*, NISABA 5 (Messina: Di.Sc.A.M., 2005), pp. 105 ff.

⁸ The pre-sealing procedure is well attested on tablets of Uruk IVa and Uruk III–Jemdet Nasr periods and reappears during the Ur III and subsequent periods; see Roger J. Matthews, *Cities, Seals and Writing: Archaic Seal Impressions from Jemdet Nasr and Ur*, *Materialien zu den frühen Schriftzeugnissen des Vorderen Orients 2* (Berlin: Gebrüder Mann, 1993), pp. 24–28; Giovanni Bergamini, “Le impronte di sigillo,” in *Testi cuneiformi neo-sumerici da Umma, nn. 0413–0723*, edited by Alfonso Archi, Francesco Pomponio, and Giovanni Bergamini, *Catalogo del Museo Egizio di Torino, Serie Seconda-Collezioni*, vol. 8 (Turin: Ministero per i Beni Culturali e Ambientali – Soprintendenza al Museo delle Antichità Egizie, 1995), pp. 349–420; *All'origine dell'amministrazione e della burocrazia*, Tavola Rettangolare n. 1 (Rome: CIRAAS, 2004), edited by Romina Laurito and Alessandra Mezzasalma; see also Giovanni Bergamini, “Gli scribi di Umma: prassi di validazione del documento e di certificazione, di autorità in età neosumerica,” in Mora and Piacentini, eds., *L'ufficio e il documento*.

⁹ Francesco Pomponio, “Lukalla of Umma,” *Zeitschrift für Assyriologie* 82 (1992): 172–73 n. 9.

Table 1. Labels $sa_2-du_{11}^*$.

Text	Seal	kišib	Date	ġiri ₃	gi	e ₂ kas ₄
ARRIM 4 28	a	a	ŠS 4/VI/–	Ku ₃ -ga-ni	—	—
ARRIM 7 13	b+c	b	ŠS 4/III/30	?	Lu ₂ -ur ₄ -ša ₃ -ga, Ur-e ₂ -mah	[...]
ASJ 3 181	b+c	b+c	ŠS 6/III/29	ᵈŠara ₂ -za-me	Lu ₂ -ᵈŠul-gi-ra, Ur-e ₂ -mah	[...]
BM 108545	b+c?	b+c	ŠS 6/x/29	Gur ₈ -za-an	Lu ₂ - ^r ur ₄ -ša ₃ ^l -ga, Lu ₂ -du ₁₀ -ga	U
BM 115846	b+c	b+c	ŠS 3/–/–	[x]-da-MU	[Ša ₃]-nin-ġa ₂ , Lu ₂ -du ₁₀ -ga	—
BM 123104	a	a	AS 5/V/–	—	—	—
BRM 3 1	b	ensi ₂	AS 8/X/30	A-du	Lu ₂ -ᵈNam ₂ -an-ka	G
BRM 3 2	a	a	AS 8/III/–	—	—	—
BRM 3 3	b+c	b+c	AS 8/VII/30	A-du	Ša ₃ -nin-ġa ₂ , Lu ₂ -ur ₄ -ša ₃ -ga	G
BRM 3 4	a	a	ŠS 4/–/–	—	—	—
BRM 3 5	b+c	b	ŠS 3/XII/30	Gur ₈ -za-an	Lu ₂ -ur ₄ -ša ₃ -ga, Ur-e ₂ -mah	U
BRM 3 6	a	[...]	[AS] 1/[–/–]	—	—	—
BRM 3 7	b+c	b	ŠS 4/III/29	Lu ₂ -du ₁₀ -ga	Hu-PI-PI, Lu ₂ -eb-gal-la	G
BRM 3 10	b+c	b	ŠS 3/VII/–	[Uš]-ġu ₁₀	Hu-PI-PI, Lu ₂ -eb-gal-la	U
BRM 3 12	b+c	b+c	ŠS 4/X/30	ᵈŠara ₂ -za-me	Ur-ġi ₆ -par ₄ , Lu ₂ -sukkal	U
BRM 3 15	A-a-kal-la	ensi ₂	ŠS 3/XIII/–	—	—	—
BRM 3 23	b+c	b	AS 8/VII/–	Du-u ₂ -du ₁₁	Ur-ġi ₆ -par ₄ , Lu ₂ -ᵈNam ₂ -nun	—
BRM 3 25	b+c	b	ŠS 6/III/29	Lu ₂ -du ₁₀ -ga	Lu ₂ -du ₁₀ -ga, Ur-e ₂ -mah	G
BRM 3 30	b	ensi ₂	AS 7/XI/ 14	A-du	—	G
BRM 3 32	Gu-du-du	Gu-du-du	IS 1/XI/–	Du-u ₂ -du ₁₁	—	—
BRM 3 44	Ur-ᵈLi ₉ -si ₄	ensi ₂	AS 8/IV/–	Du-u ₂ -du ₁₁	—	—
BRM 3 45	b	ensi ₂	AS 6/VIII/–	Du-u ₂ -du ₁₁ , Lugal-nam ₂ -mah	Lu ₂ -ᵈ[Nam ₂]-an-ka, Ur-ᵈNun-gal	—
BRM 3 47	A-a-kal-la	ensi ₂	AS 8/–/–	—	—	—
BRM 3 49	Lu ₂ -ᵈHa-ia ₃	Lu ₂ -ᵈHa-ia ₃	ŠS 3/–/–	Ku ₃ -ga-ni	—	—
BRM 3 51	a	a	ŠS 2/–/–	—	—	—
BRM 3 77	a	a	ŠS 4/–/–	Lu ₂ -du ₁₀ -ga	—	—
CHEU 99	b+c	b+c	ŠS 6/VII/29	Lu ₂ -du ₁₀ -ga	Lu ₂ -du ₁₀ -ga, Ur-e ₂ -mah	G
Contenau Umma 26	a	a	AS 8/III/–	—	—	—
CST 782	b+c	b+c	ŠS 2/IX/–	Du-u ₂ -du ₁₁	Ša ₃ -nin-ġa ₂ , Lu ₂ -ur ₄ -ša ₃ -ga	—
CST 871	b	b	ŠS 2/VI/30	Lu ₂ -du ₁₀ -ga	Ša ₃ -nin-ġa ₂ , Lu ₂ -ur ₄ -ša ₃ -ga	G

* a = Ur-e₁₁-e; b = Lu₂-kal-la; c = Ur-ᵈNun-gal; G = an-za-gar₃ Ġirsu, U = Umma

Table 1. Labels sa₂-du₁₁ (cont.).

Text	Seal	kišib	Date	ġiri ₃	gi	e ₂ kas ₄
CST 872	c	b	ŠS 2/VI/30	Gur ₈ -za-an	—	U
MVN 4 173	b+c	b	ŠS 2/IV/30	Gur ₈ -za-an	Ur-ġi ₆ -par ₄ , Lu ₂ -dŠul-gi	U
MVN 4 176	b+c	b	ŠS 2/IX/29	Gur ₈ -za-an	Lu ₂ -ur ₄ -ša ₃ -ga, Ur-e ₂ -mah	
MVN 4 177	b+c	b	ŠS 2/VIII/30	Gur ₈ -za-an	Lu ₂ -ur ₄ -ša ₃ -ga, Ur-e ₂ -mah	
MVN 15 96	a	a	ŠS 5/VIII/—	Ku ₃ -ga-ni	—	—
MVN 15 256	b+c	b	ŠS 3/IV/30	Lu ₂ -du ₁₀ -ga	Ša ₃ -nin-ġa ₂ , Lu ₂ -ur ₄ -ša ₃ -ga	G
NABU 1989	b+c	b	ŠS 4/XI/29	Lu ₂ -du ₁₀ -ga	Ur-ġi ₆ -par ₄ , Hu-PI-PI	G
Nebraska 2	a	a	AS 8/VII/—	—	—	—
Nebraska 43	a	—	AS 5/IX/—	—	—	—
Nik 2 246	Ur-dLi ₉ -si ₄	ensi ₂	AS 7/XII/—	An-na-hi-li-bi	—	—
Nik 2 248	b	b	AS 6/—/—	Gu-du-du	—	—
Nik 2 281	c	b	ŠS 2/IV/30	Aš-[...]	Lu ₂ -ur ₄ -ša ₃ -ga, Ur-e ₂ -mah	
Nik 3 512	b	b	AS 7/I/—	IGI.RI	Lu ₂ -d[...]	G
Nik 3 514	Ur-dLi ₉ -si ₄	ensi ₂	AS 7/IV/29	Gur ₈ -za-an	Ur-ġi ₆ -par ₄	U
Nik 3 515	b+c	ensi ₂	AS 8/III/—	—	—	—
OrSp 47–49 341	a	a	AS 5/VII/—	—	—	—
OrSp 47–49 344	b	ensi ₂	AS 5/XII/—	A-bu-ni, Du-u ₂ -du ₁₁	Lu ₂ -dNam ₂ -nun	—
OrSp 47–49 360	Ur-dLi ₉ -si ₄	ensi ₂	AS 6/XIII/—	Gur ₈ -za-an	—	U
OrSp 47–49 373	Ur-dLi ₉ -si ₄	ensi ₂	AS 7/IX/29	Gur ₈ -za-an	Ur-ġi ₆ -par ₄	U
OrSp 47–49 405	a	a	ŠS 2/VI/—	Ku ₃ -ga-ni	—	—
OrSp 47–49 407	a	a	ŠS 9/X/—	Ku ₃ -ga-ni	—	—
OrSp 47–49 457	Lu ₂ -dHa-ia ₃	Lu ₂ -dHa-ia ₃	ŠS 9/VIII/—	Ku ₃ -ga-ni	—	—
Rosen Christies	b	ensi ₂	AS 5/IX/—	Du-u ₂ -du ₁₁	Lu ₂ -dNam ₂ -nun	—
SANTAG 7 186	a	—	[x/x/x]	?	—	—
SANTAG 7 187	b	—	[x]/III/28	A-du	—	G
SET 185 UM 19	b+c	b+c	ŠS 8/V/30	Lu ₂ -du ₁₀ -ga	Lu ₂ -du ₁₀ -ga, Ur-e ₂ -mah	
TJA IES 318	Ur-dLi ₉ -si ₄	ensi ₂	AS 7/IX/29	Gur ₈ -za-an	Ur-ġi ₆ -par ₄	U
TJA IES 319	b	ensi ₂	AS 5/10	Du-u ₂ -du ₁₁	Lu ₂ -dNam ₂ -nun	—
Torino 2 439	b	[...]	[x/x/x]	[...]	[...]	G
UTI 6 3777	b+c	b+c	ŠS 5/V/30	dŠara ₂ -za-me	Ur-ġi ₆ -par ₄ , Hu-PI-PI	U
YOS 18 58	a	a	ŠS 2/XII/—	Ku ₃ -ga-ni	—	—

1.2. EPIGRAPHICAL FEATURES

The labels bear the expression sa_2-du_{11} “regular delivery,” and the date shows that they are monthly accounts. Starting from the term sa_2-du_{11} , we are able to identify two groups:

- sa_2-du_{11} kas_4 “regular delivery for the messenger(s)”
- sa_2-du_{11} $di\tilde{g}ir-re-ne$ “regular delivery for the gods”

The officials involved are always the same, demonstrating a close relationship of these people with the administrative branch that created this kind of document.

The content of the texts allow us to relate the labels to other typologies of administrative documents written on tablets: the daily rations to traveling people known as “messenger” texts and the sa_2-du_{11} deliveries to the Umma gods. A third group of labels without the sa_2-du_{11} term registers annual accounts of different goods and is related to deliveries to the messengers and the gods.

2. THE LABELS OF THE “MESSENGER” TEXTS¹⁰

A total of forty-one labels that are connected to the “messenger” texts have been identified to date. The labels’ contents describe the distribution of foodstuffs and messenger rations. The texts’ structure can be split into two sections: a list of goods, defined as sa_2-du_{11} ; and an administrative section bearing the names of the officials, always in the same sequence, that dealt with the transaction, and the date. The sequence of the administrative section is:

- a **giri**₃, probably the individual in charge of escorting the goods in transport;¹¹
- followed by a **kišib**, the person who is responsible for the sealing;¹²
- the **date** with the year, month, and day;
- one or two officials who witness or confirm (**gi**) the procedure.

The list of goods is given in the same sequence in all the labels and mirrors that of the daily records usually referred to as the “messenger” texts, providing us with further evidence to corroborate the theory that there is a close link between the two textual types. The “messenger” texts record standard rations of beer ($kaš$), bread ($ninda$), onions (sum), oil ($i_3-giš$), and naga-herb. The quantities distributed vary, and certain groups have extra rations, i.e., fish (ku_6) and $dida$. The following messenger text¹³ (ŠS 3/VI/16), for example, records three types of rations: the first, for three persons (ll. 1–7) differs from the second, for four individuals (ll. 8–r. 1), only in the quality of the beer, while in the third type of ration, for five persons (ll. r. 2–12), there is a reduction from five silas to three in the quantity of beer and bread; the total and the date, on the left edge, close the document:

1. 5 sila₃ $kaš$ sig₅ 5 sila₃ $ninda$ 5 gin₂ sum 3 gin₂ i_3 2 gin₂ $naga$ I-ti-a
3. 5 sila₃ $kaš$ sig₅ 5 sila₃ $ninda$ 5 gin₂ sum 3 gin₂ i_3 2 gin₂ $naga$ Šu-Da-da
6. 5 sila₃ $kaš$ sig₅ 5 sila₃ $ninda$ 5 gin₂ sum 3 gin₂ i_3 2 gin₂ $naga$ I-šu₂-dan

¹⁰ Romina Laurito, Alessandra Mezzasalma, and Lorenzo Verderame, “Oltre la tavoletta: Documenti archivistici dall’amministrazione mesopotamica del III millennio,” in Mora and Piacentini, eds., *L’ufficio e il documento*.

¹¹ Currently the $giri_3$ is considered to be the person responsible for the goods delivered, nevertheless further research would be necessary to understand fully the role of this official; cf. Niek Veldhuis, “A Multiple Month Account from the Gu’abba Rest House,” *Zeitschrift für Assyriologie* 91 (2001): 85–109.

¹² It is generally accepted that the term $kišib$ indicates the official in charge of sealing the tablet. Indeed the term generically refers to the action of sealing; see Enrica Fiandra, “The Connection between Clay Sealings and Tablets in Administration,” in *South Asian Archaeology* 1979 (1981): 29–43.

¹³ D’Agostino and Verderame, *Umma Messenger Texts, Part 3*, No. 21.

8.	5 sila ₃ kaš 5 sila ₃ ninda 5 gin ₂ sum 3 gin ₂ i ₃ 2 gin ₂ naga E ₂ -a-dan
10.	5 sila ₃ kaš 5 sila ₃ ninda 5 gin ₂ sum 3 gin ₂ i ₃ 2 gin ₂ naga A-kal-la
12.	5 sila ₃ kaš 5 sila ₃ ninda 5 gin ₂ sum 3 gin ₂ i ₃ 2 gin ₂ naga ^d Šara ₂ -kam
lower edge	5 sila ₃ kaš 5 sila ₃ ninda 5 gin ₂ sum 3 gin ₂ i ₃ 2 gin ₂ naga Ĝiri ₃ -ne ₂ -i ₃ -sa ₆
2.	3 sila ₃ kaš 2 sila ₃ ninda 5 gin ₂ sum 3 gin ₂ i ₃ 2 gin ₂ naga Ur-ni ₉ -ĝar
4.	3 sila ₃ kaš 2 sila ₃ ninda 5 gin ₂ sum 3 gin ₂ i ₃ 2 gin ₂ naga Šu- ^d Šamaš
6.	3 sila ₃ kaš 2 sila ₃ ninda 5 gin ₂ sum 3 gin ₂ i ₃ 2 gin ₂ naga Gu ₃ -de ₂ -a
8.	3 sila ₃ kaš 2 sila ₃ ninda 5 gin ₂ sum 3 gin ₂ i ₃ 2 gin ₂ naga A-la-a
10.	3 sila ₃ kaš 2 sila ₃ ninda 5 gin ₂ sum 3 gin ₂ i ₃ 2 gin ₂ naga Hu-hu-ni
13.	šu-niĝin ₂ 0.0.1 5 sila ₃ kaš sig ₅ šu-niĝin ₂ 0.0.3 5 sila ₃ kaš
upper edge	šu-niĝin ₂ 0.0.4 5 sila ₃ ninda šu-niĝin ₂ 1 sila ₃ sum / šu-niĝin ₂ $\frac{1}{2}$ sila ₃ 6 gin ₂ i ₃
left edge	šu-niĝin ₂ $\frac{1}{3}$ sila ₃ 4 gin ₂ naga iti šu-numun u ₄ 16-kam mu us ₂ -sa ma ₂ ^d En-ki

“5 silas of good quality beer, 5 silas of bread, 5 shekels of onions, 3 shekels of oil, 2 shekels of naga-herb to Iti’a, ... to Šu-Dada, ... to Išu-dan; 5 silas of beer, 5 silas of bread, 5 shekels of onions, 3 shekels of oil, 2 shekels of naga-herb to Ea-dan, ... to Akalla, ... to Šara-kam, ... to Ĝiri-ne’isa; 3 silas of beer, 2 silas of bread, 5 shekels of onions, 3 shekels of oil, 2 shekels of naga-herb to Urniĝar, ... to Šu-Šamaš, ... to Gudea, ... to Ala’a, ... to Huhuni. Total: 15 silas of good quality beer, total: 35 silas of beer, total: 45 silas of bread, total: 1 sila of onions, total: 36 shekels of oil, total: 24 shekels of naga-herb. Month šu-numun (VI), day 16, year following (the year) “the boat of Enki” (ŠS 3).”

There is a slight variation in the typology of goods recorded in the “messenger” texts.¹⁴ One example of this is seen in the comparison of two groups of labels sealed by Ur-e₁₁-e, Ur-^dNun-gal, and Lu₂-kal-la.

We would argue that the labels represent a monthly account of the daily deliveries described in the “messenger” texts, as the date recorded is either the 29th or the 30th of the month. A precise comparison between the monthly distributions obtained from the “messenger” texts and the assumed monthly account registered in the sa₂-du₁₁ kas₄ labels is not possible at present due to a paucity of published material.¹⁵ Nevertheless, our research has shown that the quantity of goods registered in the “messenger” texts in a specific month never exceeds the amount recorded in the labels.¹⁶

The use of these labels is limited, in terms of both time and space. They are documented over a brief period of fifteen years, from AS 5 to IS 1, with an interruption between AS 9 and ŠS 1¹⁷ during which there was a documentary hiatus in the messenger text group also.¹⁸ The labels are geographically limited to the province of Umma and are sealed by a very restricted group of people, namely three officials: Ur-e₁₁-e, Lu₂-kal-la, and Ur-^dNun-gal.¹⁹

¹⁴ See above, n. 3.

¹⁵ We assume that the activities and journeys of the messengers were not seasonal, since all months are mentioned in both labels and “messenger” texts.

¹⁶ As known from “messenger” texts, the same amount of naga is always assigned: 2 shekels. Comparing texts and labels, it is possible to total the number of rations delivered in a month through the quantity of the naga.

¹⁷ Label MLC 2329 seems to be the only exception.

¹⁸ See above, n. 3.

¹⁹ The relations between these persons are not yet clear. Jacob Dahl, “The Ruling Family of Ur III Umma” (Ph.D. diss., University of California, Los Angeles, 2003), assumed that Ur-e₁₁-e was Lu₂-kal-la’s father, because the latter in his own seal claims to be “son” (dumu) of Ur-e₁₁-e. For another interpretation based on the hypothesis that dumu refers to a relationship of dependence, see Pomponio, “Lukalla of Umma,” pp. 169–79.

2.1. UR-E₁₁-E'S LABELS

The oldest labels, dating from AS 5, are sealed by Ur-e₁₁-e, an important official from the city of Apišal. His chief responsibility was managing livestock in Umma.²⁰ The following text (BRM 3 2), dated to the 2nd month, 8th year of the reign of Amar-Su'en, is sealed by Ur-e₁₁-e:

Side 1

- | | | |
|----|--|---|
| 1. | 0.2.2 5 sila ₃ kaš sig ₅ | 145 silas of good quality beer |
| 2. | 0.3.1 2 sila ₃ kaš gin | 192 silas of normal quality beer |
| 3. | 3 dug dida gin 0.0.2-ta | 3 jars of 20 silas of dida of normal quality |
| 4. | 17 dug dida gin 0.0.1-ta | 17 jars of 10 silas of dida of normal quality |

Side 2

- | | | |
|----|--|------------------------------|
| 1. | 1.3.1 7 sila ₃ ninda gur | 497 silas of bread |
| 2. | 2 ½ sila ₃ 6 gin ₂ i ₃ -gīš | 156 silas of oil |
| 3. | 1 ½ sila ₃ 6 gin ₂ naga | 96 silas of naga-herb |
| 4. | 82 ku ₆ kun-zi | 82 kunzi-fish |
| 5. | 82 sa sum GAZ | 82 strings of onions, minced |

Side 3

- | | | |
|----|--|---|
| 1. | 1 maš ₂ | 1 goat |
| 2. | sa ₂ -du ₁₁ kas ₄ | regular delivery for messenger(s) |
| 3. | kišib Ur-e ₁₁ -e | seal of Ur-e ₁₁ -e |
| 4. | iti sig ₄ gīš ₃ -šub ba-gar | second month |
| 5. | mu en Eridu ^{ki} ba-huḡ | year (in which) "The en priestess (of Enki) of Eridu took her seat" |

Only twelve labels bear Ur-e₁₁-e's seal impression and he is referred to in the document as the kišib, the official in charge of sealing the document. In the reign of Amar-Su'en, no mention of any other official is ever made, signifying the importance of the role of Ur-e₁₁-e. In the following reign, that of Šu-Su'en, an official by the name of Ku₃-ga-ni is always indicated alongside the term gīri₃.

No reference to a specific day was made on these labels. Unlike the labels sealed by the other officials, there are no other details recorded. Only Ur-e₁₁-e alone, out of a total of five officials, sealed the sa₂-du₁₁ kas₄ labels and it appears he was employed to distribute dried fish. Fish (ku₆) are always mentioned together with the strings of onions (sa sum), a relationship also found in the "messenger" texts.²¹

2.2. LU₂-KAL-LA AND UR-^dNUN-GAL'S LABELS

Although the Ur-e₁₁-e labels may be the oldest, those sealed by Lu₂-kal-la and Ur-^dNun-gal are by far the most numerous (24). Both officials²² use different seals (A and B)²³ indiscriminately on their texts, whereas mainly seal B is used to seal the labels. In some cases the labels were pre-sealed by both officials. In addition, unlike the Ur-e₁₁-e examples, responsibility for sealing the text (kišib) and for sealing the label²⁴ falls to more than one official.

The labels pre-sealed by Lu₂-kal-la and Ur-^dNun-gal become more standardized both in their structure and contents. They show similarities both stylistically and in the sequence of the information: a list of the goods distributed, defined as "regular distribution for the messengers," followed by the locality of the provenance of the assigned goods, Umma or an-za-gar₃, a fortified structure on the Girsu canal (i₇).

²⁰ Dahl, "The Ruling Family," pp. 195 ff.

²¹ The so-called "Group G" in McNeil's classification; see above, n. 3.

²² Dahl, "The Ruling Family," pp. 234 ff. and n. 511; Pomponio, "Lukalla of Umma," pp. 169–79.

²³ Bergamini, "Le impronte di sigillo," pp. 349–420.

²⁴ See table 1.

The following text (BRM 3 12) is sealed by both officials and is dated the 30th day of the 10th month, the 4th year of the reign of Šu-Su'en; only two surfaces are written on:

Side 1

1.	0.4.5 5 sila ₃ kaš sig ₅	295 silas of good quality beer
2.	1.4.5 kaš gin gur	590 silas of normal quality beer
3.	1.4.1 ninda gin gur	550 silas of normal quality bread
4.	0.0.1 7 ½ sila ₃ igi-saḡ sum GAZ	1,050 silas of onions, minced, <i>of various qualities</i>
5.	0.0.1 ½ sila ₃ i ₃ -ḡiš	630 silas of oil
6.	7 sila ₃ 4 gin ₂ naga 𒀭KUM ¹	460 silas of the naga-herb, cooked
7.	sa ₂ -du ₁₁ kas ₄ ša ₃ Umma ^{ki}	regular delivery for the messengers of Umma
8.	𒀭ḡiri ₃ ¹ dŠara ₂ -za-me	under the orders of dŠara ₂ -za-me

Side 2

1.	𒀭kišib ¹ Lu ₂ -kal-la u ₃	seal of Lu ₂ -kal-la and
2.	Ur- ^d Nun-gal-ka	Ur- ^d Nun-gal
3.	iti ezem dŠul-gi u ₄ 30-kam	10th month, 30th day
4.	mu dŠu- ^d EN.ZU lugal Uri ₅ ^{ki} -ma-ke ₄ bad ₃ mar-tu <i>mu-ri-iq ti-id-ni-im</i> mu-du ₃	year (in which) “Šu-Su'en, king of Ur, built the Amorite wall (whose name is) <i>muriq tidnim</i> ”
5.	Ur-ḡi ₆ -par ₄ [u ₃] Lu ₂ -sukkal? ib ₂ -gi-[ne ₂]	Ur-ḡi ₆ -par ₄ and Lu ₂ -sukkal have <i>confirmed</i> .

All the labels sealed by Lu₂-kal-la and Ur-^dNun-gal are dated to either the 29th or the 30th of the month. There is one exception, dated to the 14th, although this label mentions specific goods such as licorice, vases, and sheepskins, items that are undocumented in any of the other examples.²⁵

The order of the items listed corresponds to that of the “messenger” texts in these labels, too. The sequence runs: beer, bread, onions, oil, and the herb naga. The more unusual goods mentioned above, i.e., the animals, dates, and wood, are found listed between the bread and the onions.

The transported goods vary according to their destinations. The majority, that is, the “good oil” or “high quality oil,” dates, animals, types of flour, and reed baskets, are only destined for an-za-gar₃. The names of the officials who seal the labels as well as the names of others involved in the process change according to the location given in the text. The majority of the labels are sealed by both Lu₂-kal-la and Ur-^dNun-gal. However, in a few examples, only one name appears: Lu₂-kal-la in an-za-gar₃ and Ur-^dNun-gal in Umma.²⁶ This could point to a difference in responsibilities in the two different areas, Umma and the Ḡirsu border.

A further link can be made between the other individuals named, the ḡiri₃, and the two sites:²⁷ the officials Gur₈-za-an and dŠara₂-za-me are mentioned exclusively in reference to Umma, with Gur₈-za-an sealing in the earlier years and dŠara₂-za-me in the last two. In contrast, in the group relating to the territory of an-za-gar₃, in the earlier years A-du seals the label and in the later years it is Lu₂-du₁₀-ga. Finally, there appears to be no distinctions made between the individuals referred to as gi (see table 1).

²⁵ This particular label (BRM 3 30) could be related to the management of the *sikkum* and the e₂ kas₄, as hides and woods suggest; see Wolfgang Heimpel, “Towards an Understanding of the Term *sikkum*,” *Revue d'Assyriologie* 88 (1994): 5–31. Its date could also be due to an early closing of the monthly account.

²⁶ See table 1.

²⁷ For the relationship between the ḡiri₃ and the e₂ kas₄, and in general for this institution in the Ḡirsu texts, see Heimpel, “Towards an Understanding of the Term *sikkum*,” p. 16 and passim; Sallaberger, “Ur III-Zeit,” pp. 307–15; Veldhuis, “A Multiple Month Account,” pp. 85–109.

2.3. UR-^dLI₉-SI₄'S LABELS

In the sixth and seventh years of the reign of Amar-Su'en, four labels provide us with details of deliveries made for the messengers in the territory of Umma, sealed by Ur-^dLI₉-SI₄ the governor (ensi₂) of Umma.²⁸ In these texts that needed to be sealed (kišib), he is always referred to as governor (ensi₂), while the official who witnessed the transaction (gi) is named Ur-^gi₆-par₄. The ^gi₃'s name is Gur₈-za-an, an official who is mentioned elsewhere in labels referring to the territory of Umma.

There are other discrepancies in the monthly account labels, for example, two or more labels with identical dates. These stand out for two reasons: firstly, they document the names of different officials; secondly, they mention different place names. Exceptions are two labels with the same date, both sealed by Ur-^dLI₉-SI₄, with identical lists of foods and goods. However, one of the labels (TJA IES 318) has a postscript, quite possibly written because of something unusual in the delivery that meant an extra label needed to be produced; it is a reference to the fact that "Dān-ilī swore that ... good quality beer" (kaš sig₅ Dan-i₃-li₂ BA BI DU KA ba-ab-du₁₁).

3. SA₂-DU₁₁ DIĜIR-RE-NE LABELS²⁹

There are ten labels that form a distinct group sharing many similarities to the aforementioned sa₂-du₁₁ kas₄ labels. These ten use the term sa₂-du₁₁ diĝir-re-ne, meaning regular deliveries for the deities. They are identical in shape to the messenger labels and likewise were sealed prior to use, fired after use, and include traces of manganese oxide.

The seal impressions of the seal owners already encountered in the sa₂-du₁₁ kas₄ group are found on these labels, too: Lu₂-kal-la, Ur-^dNun-gal, and the ensi₂ Ur-^dLI₉-SI₄ and later A-a-kal-la of Umma. The kišib was not always the same person as the official who sealed the document, as was the case with the messenger labels. In fact, the task of the kišib is most frequently completed by the ensi₂, although the majority of the labels were sealed by Lu₂-kal-la whose seal impression is periodically found together with that of Ur-^dNun-gal.

These labels were used to document the regular expenditure of monthly—as is confirmed by the lack of a specific date—sa₂-du₁₁ whose purpose was to record the deliveries offered to the city deities. These donations consisted exclusively of animals, specifically sheep and goats.

There are further similarities in regards to the textual structure, showing a high degree of standardization: a list of animals is followed by the name of the deity to whom the gifts were being offered. The order of the deities mentioned is uniform: Šara of Umma, Šara of Ki'an, the deified kings Šulgi and Amar-Su'en, Girgiš, Enlil and the "balaĝ-drum of the day the moon disappears," and Gula of Umma. Other deities as well as references to related cults follow these entries. The order is maintained, even when specific deities are omitted.³⁰

The next section contains the names of officials present during the procedure, filling the roles of the ^gi₃ and gi in the messenger labels. The ^gi₃ does not relate to the transaction in its entirety, a fact that is attested to by the mention of ^gi₃ after a single expense. The name of one ^gi₃, Du-u₂-du₁₁, is always present, and in a few cases Du-u₂-du₁₁ is named together with another ^gi₃.

Meanwhile, various gi are mentioned only once. Therefore, the role of both ^gi₃ and gi is the same as that perceived in the messenger labels.

However, in this second group, a third and new element, the ki PN-ta, is introduced before the reference to the gi. The phrase means "on behalf of the named person" who withdraws the goods. Only one official is named: A-lu₅-lu₅, also recorded in the Umma texts, is referred to as ki PN-ta and in other tablets is called kurušda "the fattener of livestock."

As a final note, the individuals involved in these transactions—the ^gi₃, the gi, and the ki PN-ta—are different from those recorded in the sa₂-du₁₁ kas₄ labels with one exception; Ur-^gi₆-par₄ is named as a gi in both groups of labels.

²⁸ Dahl, "The Ruling Family," pp. 156 ff.

³⁰ See above, n. 29.

²⁹ Sallaberger, *Der kultische Kalender*, pp. 81 f., pls. 25, 80, and 82.

4. ANNUAL LABELS

Another group, again made up of ten labels, identical in shape to those described above, makes no mention of *sa₂-du₁₁* “regular delivery.” Although this group is clearly separate—the officials involved and the products listed are completely different—it would appear that they refer to the two administrative cycles discussed above (i.e., the management of messengers and the animals being sent to temples in the Umma region).

The textual structure is analogous to that of the other labels, consisting of a list of donated goods, the names of the officials who undertake and certify the transaction, and the year.

The same terms as those seen in the other label groups are used to describe the roles and responsibilities of the officials involved. The name or task of the person who seals the article is indicated by the term *kišib*, the official in charge of the transaction as *giri₃*, and the term *ki PN-ta* for the person donating the goods. In contrast to the other label groups, the term *gi* is used to indicate a witness to the transaction only once.

There are two types of products recorded: livestock, as with the *sa₂-du₁₁ diğir-re-ne* labels; and workmen and equipment related to the *sikkum* “stable,” probably connected to a structure that was used as a shelter or inn for the messengers, the *e₂ kas₄*.³¹

The individuals mentioned in the texts are different from those recorded in the transactions in both the messenger and temple animal-donation label groups. Only *Ur-e₁₁-e* has a role in the activities documented in the *sa₂-du₁₁ kas₄* labels and only the official *Lu₂-du₁₀-ga*, referred to as *gi*, in the *sa₂-du₁₁ diğir-re-ne* labels.

Unlike the other two groups, these labels are sealed by both *Ur-^dNun-gal* and *Lu₂-kal-la* only once, and it is significant that this label records a transaction where a witness (using the term *gi*) is requested. In all the other examples, the labels were sealed by different officials: *Ur-e₁₁-e*, *Lu₂-^dHa-ia₃*, and the *ensi₂ A-a-kal-la*. As mentioned above, these individuals evidently did not need another official witness for the transaction (possibly because they were higher-ranked and the presence of a further witness was unnecessary). The role played by the *ensi₂*, that is, that of sealing the label, is mirrored in the other two groups.

In contrast to the other labels, the date given is the year in which the transaction took place, indicating that these are not monthly accounts. These labels were used for recording irregular deliveries, as is clearly demonstrated by the use of the term *sa₂-du₁₁*. In this label group, documents compiled in the same year can also be found: in BRM 3 4 and BRM 3 77, labels sealed by *Ur-e₁₁-e* in the year ŠS 4 register the consignment of animal fodder, but in one case there is a record of an animal (*amar*) rarely mentioned in other documents. The other case of two similar documents produced in the same year has no obvious explanation. In the year ŠS 3, two labels, one sealed by both *Ur-^dNun-gal* and *Lu₂-kal-la* and the other sealed by the *ensi₂ A-a-kal-la*, document the same subject and are dated in the 13th month.³²

The hypothesis that this final group has a direct relationship to the other labels is not only suggested by their similarities in shape and manufacture, but also by the fact that the goods distributed fit the previously listed categories and the destinations are the same in both label groups (the management of the messengers and the delivery of livestock to temples in the territory of Umma). In addition, the presence of the seal impressions of some of the same officials to seal the other labels probably indicates the involvement of an office or administrative area related to all the labels described in this research. It would appear that the main individual involved in the production of these labels was *Ur-e₁₁-e*.

5. CONCLUSIONS

As shown above, the shared features that have led us to identify this group of documents in a typology are their shape, the content, the connection to regular deliveries to messengers and gods, and the small group of officials involved. The labels were probably tied to containers used to transport a whole month’s or year’s worth of tablets that were consigned. Once the containers reached their final destination, the archive or “central” office, the labels were

³¹ See references above, n. 27.

³² BM 115846 and BRM 3 15, respectively.

separated, fired, and included in an archive of the management of messenger rations and delivery of livestock for the activities carried out in the territory of Umma.

The relationship of Ur-e₁₁-e to all these documents and the small group of recurring officials lead us to the conclusion that these documents are the product of one specific office or, rather, a specific branch of the Umma administration where Ur-e₁₁-e was the head/chief or the senior official.

It is our opinion that the standardized shape of the labels and the short duration of their use indicates the wish and the need for a different administrative process to be created. Two stages of their deployment may be distinguished: first, they were hung from a tablet container; second, they were cut off, fired, and preserved. It could be that these actions occurred in different places and have more than one administrative meaning. Three basic administrative and juridical functions can be recognized for these artifacts: the validation, indicated by the pre-sealing procedure; the accounting, shown by their inscriptions; and finally the filing, suggested by their firing in antiquity.

In an archive, the different shapes of the documents present a *forma mentis* to be used to classify and organize them in a straightforward method. It is our opinion that the tablets and labels were classified according to their formal characteristics and branches of the administration, with a correspondence between shapes and content, allowing for immediate filing and subsequent consultation (reference). Regarding the cuneiform tablets, their format—shape, dimensions, and layout—identifies them as belonging to a specific corpus or archive. Well known, for example, is the formal regularity of the Drehem texts: not only their shape, but also other details, such as the use of the left edge, allow us to assign the document to a specific context and, in some cases, period. The same criterion has been adopted for other inscribed objects where a relationship between shape and content is found. This is clearly seen in the sa₂-du₁₁ labels from Umma and, limiting the analysis to the Neo-Sumerian period, in other typologies of administrative and archival objects, such as the pisaḡ-dub-ba, the triangular labels from Drehem related to dead animals, or the “squashed bell” shaped labels from Umma related to textiles.³³

The multidisciplinary methods adopted in the present work have led to the emergence of various new questions and observations requiring further research that considers both the inscribed and sealed objects. This work is necessary for a fuller understanding of the Ur III administrative system.

³³ The authors have undertaken a separate study on this group of administrative objects.

THE CAD AND BIBLICAL HEBREW LEXICOGRAPHY: THE ROLE OF AKKADIAN COGNATES

Baruch A. Levine, New York University

At the Berlin Rencontre of 1978 I presented a paper bearing the somewhat pretentious title: “Assyriology and Hebrew Lexicography: A Methodological Re-examination.”¹ Implicitly, I was inverting the title of Benno Landsberger’s 1967 study “Akkadisch-hebräische Wortgleichungen,” as if to read: “Hebräisch-akkadische Wortgleichungen.”² I discussed three examples cited to illustrate how information available from the much more plentiful cuneiform sources had helped to establish the precise meanings of several elusive biblical Hebrew lexemes. The most important of these involved forms of the biblical Hebrew verb *kāpar*, especially Pi^cel *kippēr* “to purify, expiate,” which is cognate with Akkadian *kapāru* A “to wipe off,” D-stem *kuppuru* “to burnish, clean.”³ This verb was central to my investigation of the phenomenology of biblical ritual. Taken alone, the evidence from biblical Hebrew was inconclusive in defining the principal concept underlying biblical atonement (Hebrew *kippûrîm*). It was the Akkadian evidence that clearly identified that concept as erasing, removing, wiping off impurity.⁴ Clarification of the basic sense of the verbal and derived forms in biblical Hebrew had further applications for biblical Hebrew lexicography, as was shown in a preliminary way by G. R. Driver many years earlier.⁵

On this occasion, when we honor the Assyrian Dictionary of the Oriental Institute of the University of Chicago, I wish to pursue the same subject further, focusing on the value of Akkadian cognates, as well as West Semitic cognates known from Akkadian documents, for the elucidation of biblical Hebrew. In this pursuit, both CAD and *AHw*. have made vast lexicographical treasures accessible to students of biblical Hebrew.

It needs to be acknowledged that there are those who doubt the value of cognate evidence for biblical Hebrew exegesis. In the first place, so it is argued, such comparisons can be misleading, because each language exhibits its own distinctive connotations, its *Eigenbegrifflichkeit*. Then, too, the meaning of a given biblical Hebrew lexeme can normally be established, or at least divined, without recourse to cognates. This can be accomplished in several ways: from context and usage on an inner-biblical basis, from ancient versions such as the Aramaic Targums, and from the extensive exegetical tradition. Indeed, we encounter few instances where dependence on comparative lexicography is indispensable, where we simply would not know the correct meaning of a biblical Hebrew lexeme without recourse to evidence from a cognate language. Finally, there are etymological and semantic complications that impede the reliable identification of cognates, especially in dealing with biblical Hebrew, a language transcribed by means of a reduced, West Semitic alphabet, a condition that triggers both homonymy and polysemy. Add to this the fact that the biblical text has been transmitted in later “Masoretic” vocalization systems that may mask the true derivation of a given lexeme. This subject was explored in a preliminary fashion by H. L. Ginsberg.⁶

And yet, our understanding of biblical Hebrew can be greatly enhanced through the careful investigation of properly identified Semitic cognates so long as we are clear as to what we seek to learn from them. For the most part, cognates enhance meaning by identifying register, or context. We learn more about what kind of a word it is that we are explaining from the more expansive usage of the cognate. I illustrate the importance of cognates by cit-

¹ Baruch A. Levine, “Assyriology and Hebrew Philology: A Methodological Re-Examination,” in *Mesopotamien und seine Nachbarn*; 25^e Rencontre Assyriologique Internationale Berlin, 3. bis 7. Juli 1978, Teil 2, edited by H.-J. Nissen and J. Renger (Berlin: Dietrich Reimer, 1982), pp. 521–30.

² Benno Landsberger, “Akkadisch-hebräische Wortgleichungen,” in *Vetus Testamentum*, Supplement 14 (1967): 176–204.

³ See CAD s.v. *kapāru* A mngs. 1 and 3.

⁴ B. A. Levine, *In the Presence of the Lord* (Leiden: Brill, 1974), pp. 56–63, 123–27.

⁵ G. R. Driver, “Studies in the Vocabulary of the Old Testament,” *Journal of Theological Studies* 34 (1933): 22–44.

⁶ H. L. Ginsberg, “Behind the Masoret” [in Hebrew], *Tarbiz* 5 (1933/34): 208–23, and “Addenda to ‘Behind the Masoret’” [in Hebrew], *Tarbiz* 6 (1934/35): 543.

ing three examples taken from the books of Leviticus and Numbers, on which I have written commentaries.⁷ All three cognates had been noted before, and my role has been merely to examine them further and to apply them methodically in biblical exegesis. I am now able to refine my earlier findings, although it is necessary to review the relevant evidence in the process.

AN EXAMPLE OF AN AKKADIAN COGNATE OF A BIBLICAL HEBREW LEXEME

Biblical Hebrew *mūrbeket* (Lev. 6:14, 7:12, 1 Chron. 23:29) means “soaked, mixed,” usually in a boiling liquid, such as oil. In all three attestations here cited, which constitute the sum-total of the biblical evidence, this term occurs in prescriptions for processing grain offerings made of semolina flour. Rabbinic sources correctly define *mūrbeket* as “soaked in boiling liquid.”⁸ Akkadian attests the verb *rabāku* “to decoct, make an infusion,” as in preparing a poultice for healing illness, “to soak in boiling beer or water,” yielding nominal *rabīku* and *ribku* “decoction.”⁹ Distribution (Old Babylonian, Middle Babylonian, Boghazkoi, Emar, Middle Assyrian, Standard Babylonian) suggests that these forms are part of the so-called “peripheral” or “provincial” vocabulary. Arabic attests the verb *rabaka* “to mix,” said of mixing dates in melted butter.¹⁰

Biblical Hebrew conjugates this verb in the Hoph^ʿal stem, passive of the causative, whereas Akkadian attests only G-stem forms, indicating that it was adapted to biblical Hebrew morphology. It is used infrequently in Rabbinic and later Hebrew, in various forms, which may suggest a derivation from earlier Hebrew.¹¹ The Akkadian cognate establishes the register as medicinal, or as having to do with the processing of food. Typically, the post-biblical exegetical tradition had the meaning right, as one would expect in a case involving ritual praxis. The Akkadian cognates thus serve to add realism to the biblical priestly texts in which Hebrew *mūrbeket* occurs. Biblical Hebrew usage turns out to be practically appropriate and hardly accidental, and the commentator is prompted, therefore, to investigate further Akkadian cognates of biblical Hebrew lexemes that exhibit the same register, for instance, *bālal* (Lev. 2:5, 7:10, 14:21), cognate with Akkadian *balālu* “to mix, brew.”¹²

AN EXAMPLE OF A WEST SEMITIC COGNATE OF A BIBLICAL HEBREW LEXEME KNOWN FROM AKKADIAN SOURCES

Biblical Hebrew *lišmitūt* (Lev. 25:23, 30) means “as permanent transfer.” This adverbial usage recurs twice, once in a prohibition against the alienation of family-held arable land by Israelites, and then, by contrast, in a statement allowing precisely such alienation—but only exceptionally in the case of urban dwellings. Thus, we read: “But the land must not be sold as permanent transfer (*lišmiūt*), for the land is mine” (Lev. 25:23). The Aramaic Targum Onkelos translates: *laḥalūṭîn* “irretrievably,” which is functionally correct.¹³ According to the land-tenure system projected in Leviticus 25 and 27, sales of ancestral land were effectively long-term leases and were usually prompted by unmanageable indebtedness in a system that allowed owners to use land as security for debt. Provision was made for the redemption of land and dwellings lost pursuant to default. It has been my view that these biblical provisions reflect conditions in Judea under the Achaemenid imperial system. As early as 1958, J. J. Rabinowitz recognized that biblical Hebrew *šemitūt* was an abstract form, cognate with such passive forms as *šamit*, or *šamat*, at-

⁷ B. A. Levine, *Leviticus*, JPS Torah Commentary (Philadelphia: Jewish Publication Society, 1989); Levine, *Numbers*, Anchor Bible, 2 vols. (New York: Doubleday, 1993 and 2000).

⁸ *Šifra*^ʿ, *the Tannaitic Midrash on Leviticus*, edited by Isaac Hirsch Weiss (Vienna: Schlossberg, 1856; reprint: New York: Om Publishers, 1946), p. 31b s.v. *Pār. Saw*, 7:6.

⁹ See CAD s.vv. *rabāku*, *rabīku*, and *ribku*.

¹⁰ See Edward William Lane, *An Arabic-English Lexicon* (Edinburgh: Williams and Norgate, 1867; reprint: Beirut: Librairie du Liban, 1980), Book 1, Part 3, pp. 1021–1923.

¹¹ See Jacob Levy, *Wörterbuch über die Talmudim und Midraschim* (Darmstadt: Wissenschaftliche Buchgesellschaft, 1963), vol. 4, p. 416 s.v. *rebikāh*. Also see Eliezer Ben Yehudah, *A Complete Dictionary of Ancient and Modern Hebrew* (New York: Thomas Yoseloff, 1960), vol. 7, pp. 6387–88 s.v. *rābak*.

¹² See CAD s.v. *balālu*.

¹³ See Alexander Sperber, *The Bible in Aramaic*, vol. 1: *The Pentateuch According to Targum Onkelos* (Leiden: Brill, 1959), p. 210 s.v. Lev. 25:23, 30.

tested thus far only in Akkadian documents from Ugarit.¹⁴ CAD s.v. *ṣamātu* explains that this verb, at times written out syllabically and in other instances logographically as ŠÀM.TIL.LA.(BI.ŠÈ) (which is also rendered *ina šīmi gamri* “at full value”), is probably West Semitic, not Akkadian, and CAD provides an informative discussion of the legal situation described by it.

Leviticus 25:23 first expresses the prohibition of the permanent transfer of arable land, as we have seen, but then, in Leviticus 25:30, parallels the provision of the Akkadian documents from Ugarit with respect to urban dwellings specifically. So it is that Leviticus allows the seller one full year to redeem his urban dwelling, but after that period “the dwelling that is within the walled town shall legally become the property of its purchaser, as permanent transfer (*lišmitūt*).” In Leviticus 25:30 there is the additional specification: *ledōrōtāw* “unto his generations,” to which compare *ana / adi dārīti* (also *addārīti*) “for all generations” at Ugarit. Huehnergard provides a detailed analysis, further clarifying the register of the syllabic Ugaritic forms, and duly noting the biblical Hebrew relationship.¹⁵

Purely in phonetic terms, there is no problem in regarding forms of *ṣ-m-t* as variants of *ṣ-m-d* “to tie, grasp, hold,” variously in Ugaritic and in biblical Hebrew, and this would apply to Ugaritic *mṣmt* “treaty,” which calques Akkadian *rikiltu* in expressing the sense of “tying, binding.”¹⁶ But the discrete legal usage of stative *ṣamit / ṣamat* in the Akkadian documents from Ugarit argues against its association with *ṣ-m-d* “to tie, bind,” a point emphasized by Huehnergard. I cannot, therefore, agree with Muffs, who associates the two and understands the transferred field to be “yoked” to the purchaser.¹⁷ A problem remains with respect to biblical Hebrew and Ugaritic *ṣ-m-t* “to ruin, destroy,” and it is likely that we have homonyms.¹⁸ If this analysis is correct, there would be no alphabetic attestation of *ṣamātu* “to transfer” at Ugarit.

The distance in time between the Akkadian documents from Ugarit and Leviticus 25 and 27 (by my calculations about seven hundred years) should not cast doubt on the validity of the cognate relationship. Usage in the Akkadian documents from Ugarit defines the register of the biblical Hebrew forms precisely, and as the early West Semitic vocabulary in syllabic transcription expands, we will note more and more survivals of this sort in biblical Hebrew.

A NUANCE OF BIBLICAL HEBREW *ṣĀBĀ* CLARIFIED BY THE AKKADIAN COGNATE *ṢĀBU*

It is not uncommon to find in any number of languages that military, administrative, and social terms overlap, so that we encounter ambiguity in usage and cannot be certain except from immediate context whether reference is to an army or to some other group of personnel. A salient case in point is biblical Hebrew *ṣābā*, which has cognates in Ugaritic, rarely in Punic, and profusely in Akkadian as *ṣābu*, often written logographically as ERIN₂, and functioning at certain periods as a collective of *amēlu*.¹⁹

Numbers 1–4 depict the Israelites encamped in the wilderness after the Exodus from Egypt as a military force on the march to the Land of Canaan, organized by units called *ṣābā*, plural *ṣebā’ôt*, a term best rendered as “corps, division(s).” In certain passages, however, similar terminology is applied to temple personnel, as in Numbers 4:3, 21–49, 8:25: for instance, where Levites are ordered to report for duty, *lišbō’ ṣābā’* “to do service,” and where we read about *kol habbā’ laṣṣābā’* “everyone who reports for service.” Such non-military meanings in biblical Hebrew seem all to be clustered in relatively few priestly passages apart from those in Numbers, as for example in Exodus 38:8 (cf. 1 Sam. 2:22) where we find reference to women working in the temple complex who are called *haṣṣōbe’ôt* “the conscripted women,” perhaps performing a service similar to the *kisalluhḥātu* “courtyard sweepers” of the Akkadian sources.²⁰ Biblical Hebrew also attests a derived meaning for *ṣābā*, namely, “term of service” (Isa. 40:2, Job 7:1).

¹⁴ J. J. Rabinowitz, “A Biblical Parallel to a Legal Formula from Ugarit,” *Vetus Testamentum* 8 (1958): 95.

¹⁵ John Huehnergard, *Ugaritic Vocabulary in Syllabic Transcription* (Atlanta: Scholars Press, 1987), pp. 171–72 s.v. ŠMT, and literature cited.

¹⁶ G. Del Olmo Lete and J. Sanmartín, *A Dictionary of the Ugaritic Language in the Alphabetic Tradition* (Leiden: Brill, 2003), p. 587 s.v. *mṣmt*.

¹⁷ Yochanan Muffs, *Studies in the Aramaic Legal Papyri from Elephantine*, with Prolegomenon by B. A. Levine (Leiden: Brill, 2003), pp. 20–22.

¹⁸ See Del Olmo Lete and Sanmartín, *Dictionary*, pp. 786–87 s.vv. *ṣ-m-t* and *ṣmt*.

¹⁹ See CAD s.v. *ṣābu*, especially usage o.

²⁰ See CAD s.v. *kisalluhḥātu*.

As is to be expected in the West Semitic sphere, based on the distribution of Akkadian *šābu*, the Ugaritic cognates exhibit a predominantly military context; but note the rare Ugaritic *šbu anyt* “ship’s crew,” paralleling ERIN₂. MEŠ *ma-la-ḥe-e* “crew of sailors” in the Akkadian documents from Ugarit.²¹ Some Ugaritic forms are admittedly difficult to parse. I maintain that Ugaritic developed a denominative *šaba’u* “to march forth, arise,” just as did biblical Hebrew.²² Compare the rare *šabā’u* / *šabāḥu* in Old Babylonian and at Mari, occurring in military contexts.²³

In this case, what we learn from the abundant Akkadian sources where the term *šābu* occurs is that the basic sense of this term is “group of people, contingent of workers, population” and that “army, troop of soldiers” is merely one of such groupings. If we were dependent on biblical Hebrew alone, or even on biblical Hebrew with the addition of Ugaritic, we would have a lopsided view. Most biblical Hebrew occurrences occur in the divine epithet *YHWH šebā’ôt* “Yahweh of the (heavenly) hosts,” and *šebā’ haššāmayim* “the host of the heavens,” reflecting the theme that the stars and planets are God’s army, in what I have called a “military-celestial transaction.”²⁴ The *locus classicus* of this semantic progression is Isaiah 40:26, where it is said of Yahweh, creator of the heavens, that “he deploys their corps (*šebā’ām*) by number, calling them all by name.”

Next in frequency are the biblical military references, and only in a relatively few texts, such as those of Numbers discussed above, do we find the more general sense of “group of conscripts, personnel.” A close review of the sources cited in CAD shows fluctuation in usage. I note that the meaning “team of workmen” is frequent in Neo-Babylonian, including in references to temple workers.²⁵ The Neo-Babylonian texts are contemporary with the priestly texts of Numbers, by my calculations, so that usage in Numbers would reflect contemporary terminology.

BEYOND REGISTER: UNMASKING UNRECOGNIZED BIBLICAL HEBREW ROOTS VIA THEIR COGNATES

Another benefit accruing to the lexicographer of biblical Hebrew who chooses to search for Semitic cognates is the possibility of identifying previously unrecognized Hebrew roots, thereby enlarging the biblical Hebrew vocabulary itself. As noted above, it is important to bear in mind that the Hebrew Bible was written in a shortened alphabetic-Canaanite script, which fact makes it probable that separate and distinct Hebrew roots have coalesced or have been obscured, with one or the other being lost to us in the course of time. The first question before the exegete is whether the ancient biblical writers were aware of this graphic process, so that in their usage of the coalesced forms they could have conveyed meanings associated with the previously distinct graphemes. For example: Can we assume that a biblical author, in using the verb *ḥālaq*, would have at times intended the sense of “to pass away, die” rather than the usual sense of “to divide”? It is my view that biblical writers had such awareness. The later Masoretes lacked this same awareness and struggled with the alphabetic script before them to make sense out of difficult lexemes by vocalizing them in special ways.

In a recent study dedicated to the late Jonas Greenfield, I examined two cases in which unrecognized biblical Hebrew roots have been retrieved by adducing evidence from Akkadian and other cognate languages.²⁶ In another study dedicated to Yochanan Muffs, I examined a third case illustrating the same process.²⁷ Here I mention all three, but reserve discussion for the one I consider to be the most consequential for biblical interpretation.

The first case, in the study dedicated to Greenfield, is that of Akkadian *ḥalāqu* “to disappear, vanish, to be missing or lost, to die, perish, to escape, or flee.” It was Mitchell Dahood who made the connection with Ugaritic *ḥlq*, whereas Albright took note of West Semitic verbal conjugations of *ḥalāqu* in the El-Amarna documents, a matter

²¹ See Del Olmo Lete and Sanmartín, *Dictionary*, p. 777 s.v. *šbu* (1).

²² See B. A. Levine, review of *Le Culte à Ugarit*, by J.-M. de Tarragon in *Revue Biblique* 88 (1981): 245–50.

²³ See CAD s.v. *šabā’u*.

²⁴ B. A. Levine, “From the Aramaic Enoch Fragments: The Semantics of Cosmography,” in “Essays in Honor of Yigael Yadin,” special issue, *Journal of Jewish Studies* 33 (1982): pp. 311–26.

²⁵ See CAD s.v. *šābu* usage o, “in NB.”

²⁶ B. A. Levine, “The Semantics of Loss: Two Exercises in Biblical Hebrew Lexicography,” in *Solving Riddles and Untying Knots: Bib-*

lical, Epigraphic, and Semitic Studies in Honor of Jonas C. Greenfield, edited by Z. Zevit et al. (Winona Lake: Eisenbrauns, 1995), pp. 137–58.

²⁷ B. A. Levine, “Silence, Sound, and the Phenomenology of Mourning in Biblical Israel,” in “Comparative Studies in Honor of Yochanan Muffs,” special issue, *The Journal of the Ancient Near Eastern Society* 22 (1993): 89–106.

further clarified by Anson Rainey.²⁸ Once again, triangulation with Ugaritic and other western sources has reinforced conclusions that had been arrived at by a direct comparison with Akkadian concerning a biblical Hebrew homograph that had not been recognized prior to modern research. As a result, it is no longer necessary to associate all biblical Hebrew attestations with “dividing, splitting,” or alternatively with “smoothness,” which often yielded forced translations and resulted in unusual Masoretic vocalizations. I proposed no fewer than eight realizations of this homographic root in the Hebrew Bible. To cite just one example, consider Jeremiah 37:12: “Then, Jeremiah departed from Jerusalem to travel to the territory of Benjamin, so as to flee (Masoretic *lahaliq*, better vocalized *lahalōq*) from there in the midst of the people.” The Masoretes vocalized the consonants as *lahaliq*, syncopated for *lehaḥalîq*, the stative Hiph‘il, meaning “to slip,” therefore reflecting the sense of smoothness. I suppose we can still say “to slip away” in idiomatic English, but the verse in Jeremiah is better understood as expressing flight, or escape, rather than slippery smoothness! So, we would have three homographs in biblical Hebrew: (1) *ḥ-l-q* I “to split, divide,” (2) “*ḥ-l-q* II “to be smooth,” and (3) *ḥ-l-q* III “to disappear, vanish.” Biblical Hebrew had conflated the two separate *ḥēt*-consonants evident in the unreduced Ugaritic alphabet. In Ugaritic, the sense “to split, divide” was expressed by dotted *ḥēt*, as in the noun *ḥlq* “part, limb,” whereas “to vanish, die, be destroyed” was expressed by looped *ḥēt*.²⁹

The second case, in the study dedicated to Muffs, is that of Akkadian *damāmu* “to mourn, wail,” a meaning which makes better sense for forms of biblical Hebrew *d-m-m* in a number of biblical passages than does “to be still, silent.” Here, too, there was evidence from Ugaritic, and also from Eblaite. In a bilingual lexical series edited by Pettinato, logographic SI.DU₃ is rendered *t/di-mu-mu* “lament.”³⁰ Similarly, in an administrative text edited by Archi, we find the noun *da-ma-tu* “lament.”³¹ What had been known previously by Paul Haupt solely from Akkadian was now attested in early West Semitic.³² To cite just one biblical Hebrew example, in Isaiah 23:1–2, *hêlîlû ʾoniyôt Taršîš* “Wail, you ships of Tarshish,” is paralleled in the next verse by: *dōmmû yōšebêiʾi* “Moan, you island dwellers.”

The third case, once again in the study dedicated to Greenfield, is perhaps the most interesting because it would lend a very different meaning to certain biblical texts that speak of war and conquest, of migration and deportation. There is also the fact that this case reveals a background of homonyms in Akkadian itself. I refer to the biblical Hebrew verb *ʾabad*, which in the simple stem has stative force and is normally taken to mean “to perish, cease to exist,” and in the Pi‘‘el and Hiph‘il as “to destroy, ruin.” Closer examination of both the simple and derived stems reveals that in quite a few instances biblical Hebrew *ʾabad* functions as a verb of motion and does not connote complete or irreversible loss and destruction, but rather disappearance, absence, or distance. A semantic range that reaches from irreversible loss—death, destruction—to absence, disappearance, and distance, is possible, but in certain contexts requires a semantic “stretch” and creates ambiguity.

CAD registers two Akkadian lexemes: (1) *abātu* A, normally an active transitive verb meaning “to destroy, ruin,” less frequently stative in the sense of “to collapse, fall down,”³³ and (2) *abātu* B, a stative verb attested only in the G-stem and N-stem meaning “to run away, flee.”³⁴ Not only are the Sumerian lexical equivalents entirely separate, but usage indicates clearly separate meanings. In the lexical series, the synonyms of *abātu* B include *narqû* “remote,” *naparkû* “to abscond, escape,” and interestingly *ḥalāqu* “to disappear, vanish.” Why not consider the possibility that biblical Hebrew *ʾabad* conflates meanings associated with both *abātu* A and *abātu* B in Akkadian? In biblical Hebrew the simple stem of *ʾabad* is stative, so that the active-transitive sense “to destroy” requires either the Pi‘‘el or Hiph‘il.

Let’s try it out. I begin with Deuteronomy 26:5: *ʾArāmmî ʾōbēd ʾābî* translated by Albright as: “a fugitive Aramean was my father.”³⁵ This translation fits, but Albright did not inform us how he arrived at this meaning for the simple stem in biblical Hebrew. Compare the Akkadian N-stem participle *munnabtu* “deportee, fugitive” from

²⁸ Mitchell Dahood, “Hebrew-Ugaritic Lexicography II,” *Biblica* 45 (1964): 408; M. Dahood, “Hebrew-Ugaritic Lexicography IV,” *Biblica* 47 (1966): 406; W. F. Albright, “Two Little-Understood Amarna Letters from the Middle Jordan Valley,” *Bulletin of the American Schools of Oriental Research* 89 (1943): 17 n. 60; Anson F. Rainey, “The Barth-Ginsberg Law in the Amarna Tablets,” *Eretz-Israel* 14, *Ginsberg Volume* (1978): 11.

²⁹ Del Olmo Lete and Sanmartín, *Dictionary*, p. 361 s.v. *hlq*, n.m.

³⁰ See Giovanni Pettinato, *Culto ufficiale ad Ebla durante il regno di Ibbi-Šipiš* (Rome: Missione Archeologica Italiana in Siria, 1979), p. 47, text 1, rev. ii 25–iii 12, and text 3, rev. xii 21–26; Pettinato, *Testi lexicali bilingui della Biblioteca*: 2769 (Naples: Istituto Universitario Orientale, 1982), p. 320, No. 1116.

³¹ See Alfonso Archi, *Asseganzioni di tessuti (Archivo L2769)*, *Archivi reali di Ebla, Testi 1* (Rome: Missione Archeologica Italiana in Siria, 1985), p. 126, text 13, rev. iv 5–7.

³² See Paul Haupt, “Some Assyrian Etymologies,” *American Journal of Semitic Languages* 26 (1909): 1–26; M. Dahood, “Textual Problems in Isaiah,” *Catholic Biblical Quarterly* 22 (1960): 400–09. Also see CAD s.vv. *damāmu* and *dimmatu*.

³³ See CAD s.v. *abātu* A.

³⁴ See CAD s.v. *abātu* B.

³⁵ W. F. Albright, *From the Stone Age to Christianity: Monotheism and the Historical Process* (Garden City, NY: Doubleday, 1940), p. 181.

abātu B, a term discussed by Buccellati in its socio-political context.³⁶ Or compare the reference in an annal of Sennacherib to LU₂ *Aramē halqū* “Aramean fugitives,” noted by B. Mazar.³⁷ By the way, Akkadian *abātu* B may also account for the syllabic Ugaritic form *na-ba-di-šu-nu* “their flight,” glossed in an Akkadian text from Ugarit and cited by Huehnergard, who does not, however, take cognizance of the existence of both *abātu* A and *abātu* B in Akkadian.³⁸ He notes that in the same text we also find the comparable Akkadian verbal form *innabbitū* “they fled.” In my view, we have two N-stem realizations of *abātu* B at Ugarit, one in Akkadian and the other in syllabic Ugaritic. What has been missed is the attestation of the meaning “to remove, disperse” for the D-stem of Ugaritic *abd* in a magical composition dealing with snake bites, KTU 1.100+1.107. Inevitably, that meaning expresses the connotations associated with Akkadian *abātu* B.³⁹

This leads directly to another facet of the biblical Hebrew evidence: the application of Akkadian *abātu* B to explain the Pi‘‘el and Hiph‘il realizations of the biblical Hebrew root *ʾabad*. In the Pi‘‘el, biblical Hebrew *ʾabbēd* often means “to destroy,” but in certain passages it means “to disperse, drive away,” as applied, for example, to dispersing the flocks (Jer. 23:1). Turning to what may be regarded as Hiph‘il reflexes of Akkadian *abātu* B, we may cite the usage in Numbers 24:19 within an oracle on the Israelite conquest of Moab. There we read that the land will be depopulated and subjugated, and that Jacob “will deport (*weheʾebīd*) survivors from the town (or: ‘from Ar’).” Similarly, in Zephaniah 2:5 we read that the Philistines will be exiled: “Canaan, land of the Philistines, I shall depopulate you (*wehaʾabadtk*), leaving no inhabitants.” Finally, in Leviticus 23:30 the penalty of banishment, usually expressed by Hebrew *wehikrattī* “I will cut off, banish,” is instead expressed by the Hiph‘il of *ʾabad*: “I will banish (*wehaʾabadtī*) that person from among his kinfolk.” Most interesting of all is the sequence of Leviticus 26:38–39: In verse 38, as these verses are usually rendered, we read: “You will perish (*waʾabadtem*) among the nations, and the land of your enemies will devour you.” Verse 39 continues: “Those of you who survive(!) will be heartsick over your iniquities in the land of your enemies.” Correct the translation of verse 38 to: “You will *disappear* among the nations; the land of your enemies will consume you,” and there is no contradiction between one verse and the next. It turns out that biblical Hebrew *ʾabad*, if understood to reflect Akkadian *abātu* B, is central to understanding responses in biblical literature to the policy of deportation so widely practiced in the ancient Near East.

AN INTERESTING CALQUE

In Zechariah 4:7 we encounter the construction הר הגדול “the great mountain.” In the biblical lexicon this construction is unique. Those familiar with Akkadian epithets will recognize the Hebrew as a calque of Akkadian *šadū rabū* “great mountain,” an epithet of gods, notably of Enlil and Aššur, and of temples, such as the Ekur temple.⁴⁰

The passage in Zechariah is cryptic, to be sure, but its immediate context indicates that of temple building. We are told (in verse 9) that the Judean prince, Zerubbabel, laid the foundation of the restored Jerusalem temple during the second year of Darius I and are assured that he would complete the project. Thus, we read:

What are you, O Great Mountain (*har haggādōl*)?

Before Zerubbabel you are no more than a plain.

He shall bring out the first stone to shouts of:

“It is beautiful, beautiful!”

When we look more closely, we observe that the Hebrew construction *ʾeben hārō ʾšāh* “the first stone,” which is also unique in biblical Hebrew, suggests Akkadian *libittu maḥrītu* “the first brick,” used in foundation rituals, as

³⁶ Giorgio Buccellati, “Apīrū and Munnabtūtu: The Stateless of the First Cosmopolitan Age,” *Journal of Near Eastern Studies* 36 (1977): 146–47.

³⁷ Benjamin Mazar, “The Aramean Empire and Its Relations with Israel,” *Biblical Archaeologist* 25 (1962): 98–120. The citation is from the annals of the eighth campaign; see D. David Luckenbill, *The Annals of Sennacherib*, Oriental Institute Publications 2 (Chicago: University of Chicago Press, 1924), p. 42, col. v 22–23.

³⁸ Huehnergard, *Ugaritic Vocabulary*, p. 104 s.v. ʾBD.

³⁹ B. A. Levine and J.-M. de Tarragon, “Shapshu Cries Out in Heaven: Dealing with Snake Bites at Ugarit,” *Revue Biblique* 95 (1988): 481–518.

⁴⁰ See CAD s.v. *šadū* A mng. 1n.

in the fairly contemporary rituals from Uruk.⁴¹ The point is that what appear to be, on an inner-biblical basis alone, highly unusual constructions become more meaningful when comparative lexicographic evidence from Akkadian is introduced. It is possible to identify the “register” of the biblical vocabulary more knowledgeably.

CONCLUSION

If I were to ask myself what has changed most since the Berlin Rencontre of 1978 with respect to Semitic lexicography, I would have to say that it is the expansion of the early West Semitic vocabulary in syllabic transcription. This phenomenon is in evidence in many archives, including those from Ebla, Mari, Emar, and Ugarit, and in the Amarna correspondence. Although lateral east–west cognates, as between biblical Hebrew and Akkadian, will become less crucial, there will always be instances where such is the only evidence available. More and more, however, we will encounter triangulation and other more complex relationships involving early West Semitic cognates of biblical Hebrew lexemes in syllabic transcription, as has been illustrated here. In any event, this is surely not the time to abandon the search for cognates of biblical Hebrew, eastern or western.

⁴¹ See Carol L. Meyers and Eric M. Meyers, *Haggai, Zechariah 1–8*, *Anchor Bible* (New York: Doubleday, 1987), pp. 227–77, for an ex-

tensive discussion of Zechariah 4:1–14. On *libittu mahritu*, see CAD s.v. *libittu*, especially mng. 1c–2’.

THE SCRIBES OF NUZI: DATE FORMULAE AND THEIR USE IN THE NUZI CORPUS

Paola Negri Scafa, Rome

In the Kingdom of Arrapha no traces of any consistent and organic dating system are detectable and this lack is an obstacle to the reconstruction of the chronology of that region. Nevertheless, in a few texts some formulae that have been defined as date formulae occur. They exhibit similarities to and differences from the dating systems in use in other regions of the Near East.

In the ancient Near East several different dating systems have been used in various geographic areas in different periods. Some systems (for example, year-name formulae) are based on the record of particularly relevant events that happened in a year, while the names of some high officials are used (eponyms and bala system) in other systems to date a year. There are also systems in which each year is given a number (e.g., the regnal year number and the mu-iti system).¹

These systems were employed by the ancient scribes mainly to date documents concerning administrative or legal or commercial activities; only rarely are other types of documents, such as extispicy or literary and mythological texts, dated.

These dating elements are often written at the end of the document; sometimes date formulae or other indications of date occur in the body of a text to indicate when an event referred to in the document itself happened.

Among the dating systems, the year-name system requires some explanation: there, a year can be identified by a sentence describing one or more particularly relevant events. Sometimes this sentence is very long and complex so that abbreviated forms of the year names were also in use; the longest year formula recorded on a text occupies seventeen lines.²

The most significant element in this system is the definition of “relevant events”: it is evident that it is connected to ideological purposes according to the interest of the king. Two Mari letters in which two officials discuss the name of the coming year demonstrate the method by which a year name was chosen, but it is always the king who has the last word.³

Returning to Nuzi, the texts involving the so-called date formulae are very few since these formulae are in use in only about 0.18% of the texts, actually quite limited data. Nonetheless, many scholars base an attempt to reconstruct some sequence of events of the history of the Kingdom of Arrapha on these formulae. Moreover, other elements can be taken into consideration: for example, do these formulae share any characteristics with other documents in the ancient Near East, and in particular with Old Babylonian dating systems? Every answer to this question could offer some further information on the cultural background of the Nuzi scribes.

¹ The bibliography on date formulae, date systems, eponyms, etc. is very extensive and it is impossible to quote it exhaustively here. Among these we cite M. J. A. Horsnell, “The Grammar and Syntax of the Year-Names of the First Dynasty of Babylon,” *Journal of Near Eastern Studies* 36 (1977): 277–85; Horsnell, “Why Year-Names? An Exploration into the Reasons for Their Use,” *Orientalia* NS 72 (2003): 196–203; P. Garelli, “Notes sur les éponymes de l’empire assyrien,” in *Veenhof Anniversary Volume, Studies Presented to Klaas R. Veenhof on the Occasion of his Sixty-fifth Birthday*, edited by W. van Soldt

(Leiden: Nederlands Instituut voor het Nabije Oosten, 2001); T. Boiy, “The ‘Accession Year’ in the Late Achaemenid and Early Hellenistic Period,” in *Mining the Archives: Festschrift for Christopher Walker on the Occasion of His 60th Birthday*, edited by C. Wunsch (Dresden: ISLET, 2002), pp. 25 ff.; M. J. A. Horsnell, *The Year Names of the First Dynasty of Babylon* (Hamilton, Ontario: McMaster University Press, 1999).

² Horsnell, *Year Names*, pp. 200 f.

³ ARMT 13 27 and 47.

It is possible to identify three different kinds of formula:

- A) The largest group, equivalent to 65% of the data, consists of formulae, sometimes called *šundu* formulae or *šundu*-Datierung Formulae,⁴ in which some particular events are related; they typically occur in administrative texts where they are usually written at the end of the document; they can occur also within the body of the text.
- B) In a small group, about 25% of the texts, the name of a *hazannu* occurs in a sentence, often connected to a *šaṭir* formula.
- C) The smallest group, equivalent only to 10%, collects together the few formulae beginning with MU (*šattu*).

The meagerness of the data is emphasized by the percentage figures.

A) THE SO-CALLED *ŠUNDU* FORMULAE

Not all scholars agree on defining the formulae belonging to the first group as date formulae.⁵ In any case, it is evident that the scribe assigns a particular meaning to the events described in them.

In short it can be observed that:

1. These formulae express the result of an activity or activities already concluded.
2. These formulae, the typical verbal forms of which are G-stem preterite, perfect, or stative, are introduced by a particle or conjunction. Mostly they are introduced by the conjunction *šundu*, the other conjunctions used are *šumma*, *undu*, *kīma*, and *ina* U₄.
3. In particular:
 - a. *šundu*: this particle is borrowed from Hurrian and has the meaning “when”; it occurs not only in this kind of formula, but also in some contracts, in particular in *tidennūtus* and loans to indicate the duration clause.
 - b. *šumma*: as an adverb that indicates “when,” “now,” “see,” “truly,” it occurs in Old and Late Babylonian and Neo-Assyrian texts, in the letters of el-Amarna and in Akkadian of Boghazköy,⁶ and, obviously, Nuzi; in our texts it occurs in particular in the formulae of group A but also in those of the groups B and C.
 - c. *undu*: this particle is also borrowed from Hurrian; it occurs in the Akkadian of Boghazköy and also in Amurru Akkadian, in particular in the Pendišenni letter,⁷ where it appears in a fragmentary context. In the Nuzi context it is employed with verbs in the perfect.
 - d. *kīma*: this subordinating conjunction has a general meaning of comparison and temporality; both of these notions are expressed in Nuzi texts where both the meaning “like” and the meaning “when” occur. As far as the topic of the present paper, the meaning of “when” is to be stressed. The verb of the sentence is in the stative.

⁴ A. Fadhil, *Studien zur Topographie und Prosopographie der Provinzstädte des Königreichs Arrapḫe*, Baghdader Forschungen 6 (Mainz am Rhein: Philipp von Zabern, 1983).

⁵ For example, Fadhil, *Studien zur Topographie*, pp. 97–98, speaks of the so-called *šundu* formulae that are similar to date formulae; H. Lewy, “A Contribution to the Historical Geography of the Nuzi Texts,” *Journal of the American Oriental Society* 88 (1968): 150–62, does not define these formulae, but she uses them in attempting a reconstruction of the history of Nuzi; CAD s.v. *šundu* distinguishes general citations and date formulae; G. G. Müller, *Studien zur Siedlungsgeographie und Bevölkerung des mittleren Osttigrisgebietes*, Heidelberger Studien zum alten Orient 7 (Heidelberg: Heidelberg Orientverlag, 1994), s.v. *Šillija*, connects them to a dating system;

also he considers them like Aktennotizen. W. Mayer, *Nuzi-Studien* 1, *Alter Orient und Altes Testament* 205 (Neukirchen-Vluyn: Verlag Butzon & Bercker Kevelaer, 1978), p. 148; and J. Fincke, *Die Orts- und Gewässernamen der Nuzi-Texte*, Répertoire géographique des textes cunéiformes 10 (Wiesbaden: Ludwig Reichert, 1993), speak of Datierung-Formulae.

⁶ R. Labat, *L'akkadien de Boghaz-köy* (Bordeaux: Librairie Delmas, 1932).

⁷ According to S. Izre'el (*Amurru Akkadian: A Linguistic Study* [Atlanta: Scholars Press, 1991], p. 320) it corresponds in meaning to the Akkadian particle *kī*; see also Izre'el, *Amurru Akkadian*, concerning the Pendišenni letter.

- e. *ina* U₄-*mi*: this expression is in use also in contracts and in other kinds of texts; here it is connected with the activities of the king.

It is evident from an analysis of their structure and from a comparison with other more ancient or contemporary dating systems that these clauses do not belong to an actual dating system. Nevertheless some special events are recorded in them: are they chosen on the grounds of ideological purpose, or do the scribes refer to events strictly connected to the administration and the management of the budget?

The fact that in some texts (such as HSS 13 63, or HSS 14 248 and 249) more than one formula is present demonstrates that they were actually functioning as vouchers on the occasion of expenses which could have weighed heavily on the budget.

What kinds of events are recorded as a voucher? Activities in which the king is concerned in order to record his presence or his arrival (or departure) in a certain town. Some examples are: *šum-ma* LUGAL *iš-tu* URU *Zi-iz-za i+na* URU *Nu-zi il-li-ka₄* (HSS 14 42:8–11); *i-na* U₄-*mi* LUGAL *ir-ru-bu* (HSS 14 43:3); [*šu-u*]n-*du* LUGAL *iš-tu* URU *Ha¹-pa¹-te⁸ il-li-ku-ni* (HSS 14 46:30–31); *šu-un-du* LUGAL *i+na* ITU-*hi* *Še-ḥa-li ša* dISKUR *iš-tu* URU *Zi-iz-za it-tal-ku-ni* (HSS 14 53:22–25); other texts of this kind are HSS 14 41, 42, 56, 78; HSS 15 240, 75.

1. Presence of strangers in the kingdom (e.g., *ina* ITU *Hi-zu-ri-we ki-ma* DUMU *Aš-šur-mu-tàk-ki-il il-li-ka₄* HSS 14 118:6–8; *un-du₄ LÚ ú-bá-ru ša* URU^{ki} *it-ti* m^ḥ*Hut-teššup* DUMU LUGAL *it-tal-ku-ni* HSS 14 136:21–23).
2. Military activities, including struggles against enemies, or simple troop transfers; e.g., *šum-ma* LÚ.MEŠ *ša* KUR *Ak-ka₄-di i-na* ITI-*hi* *Im-pur-ta-an-nu i-na* KUR *Na-áš-bat i-du-uk-ku-uš-šu-nu-ti* HSS 13 63:5–8; *šu-un-du* KÚR.MEŠ *i-na* URU *Zi-iz-za aš-bu* HSS 14 131; *šu-un-du₄ GIŠ.GIGIR.MEŠ* *Ḥa-lim-gal-bat [i]na* URU *Ar-na-a-pu-we ù i+na* URU *Ar-wa ú-ši-bu* HSS 14 171; other examples are HSS 14 174, 238, 249; HSS 15 43.
3. Activities connected with the cult and the gods; e.g., *šu-un-du₄ DINGIR.MEŠ GIŠ.SAR i-ru-bu* HSS 14 218; *an-nu-tu₄ šu-un-du* DINGIR [...] *ú-še-eh-ḥú-ú* HSS 16 67 (and see also HSS 13 187; HSS 14 248).
4. Different activities, possibly recorded on the same text: for example, in HSS 14 248, activities connected with the gods and military activities are recorded: *šu-un-du* dU *Nu-zu-ḥe iz-qú-pu* (l. 5); *šu-un-du* KÚR.MEŠ *is-sí-ih-[...]-lu ù šu-ú a-na šu-ul-ma-ni il-li-ka₄*.
5. Situations sometimes difficult to identify,⁹ such as HSS 13 457,¹⁰ where the particular situation of some goats is quoted: *šu-un-du en-zu.MEŠ i-na* URU *Nu-zi ḥu-šu-um-ma ip-šu*. It is useful to make a short digression about this text. The difficulty in explaining this text arises from the fact that the verbal expression *ḥušumma epēšu* has until now not been translated. Nevertheless, two points can be taken into consideration: 1) the events recorded in this kind of formula are always of some relevance, and therefore the matter related to goats must be important, i.e., not a routine breeding activity; 2) the root *ḥuš* is certainly connected with the semantic area of the word “to tie”; for example, Wilhelm¹¹ suggested a meaning “binden” for *ḥuš* and Fincke proposed the meaning “belt” for the word *ḥušuhhe*, derived from the same root. Therefore an interpretation for the formula could be suggested: the goats in question could be bound or ribboned perhaps in view of a sacrifice to the gods. If this interpretation is accepted, then the event recorded in this formula must be included among the records of activities connected with the cult and the gods.

⁸ For the reading of the toponym see Fincke, *Répertoire* 10, p. 92.

⁹ BM 26286, where the presence of a woman in the city of Akmašar is recorded, is a problematic text that could belong to this group. In this text the sentence: *šundu* dWištanu *ina* URU *Akmašar ašib* occurs: as for its typology, it is similar to the sentences introduced by *šundu*, but it is difficult to give it a certain interpretation. Wištanu seems to be a private person: as wife of Zike, son of Šurki-tilla, she, like her husband, belongs to one of the prominent families in Nuzi; she can act alone, without the help of her husband, even when he was still alive. A possible suggestion to explain this text can be offered from

the context: in the text Zike distributes honey: this fact added to the autonomous activity of Wištanu suggests an activity connected with a religious event.

¹⁰ HSS 13 457 will be published with the number 429.

¹¹ G. Wilhelm, “Gedanken zur Frühgeschichte der Hurriter und zum hurritisch-urartäischen Sprachvergleich,” in *Hurriter und Hurritisch* (Xenia 21), edited by V. Haas (Constance: Universitätsverlag Konstanz, 1988), p. 60; M. L. Khačikiyan, “The Hurrian Verb Revisited,” SSCNH 10 (1999), pp. 257–66; I. Röseler, “Hurritologische Miscellen,” SSCNH 10 (1999), pp. 393–400.

Coming back to our discussion, for a better evaluation of the documents it would be useful to reconstruct the archival groups. As seen above, these texts are administrative documents, mainly belonging to the palace administration. Unfortunately, the findspots are not known for all the texts that report these formulae of group A; when it is known, it is interesting to observe that the texts coming from the palace originate from the complex of Rooms M 79, R 76, and R 96, and not from other areas of the palace from which many other texts come. This group of texts coming from a well-identified section of the palace is certainly late and is related to two well-known individuals: ̒ttipapu and the *mār šarri* ̒ut-teššup.

Also the other texts originated in buildings outside the palace but closely connected with the palace: this is particularly true for the texts found in Rooms D 3–D 6, from which most of references to the presence of the king come.

Furthermore, the texts coming from Rooms C 19 and C 28 have a relationship with the palace archives, even when they come from a private house where the important family of Zike, son Ar-tirwi, and his descendants lived and acted: in particular his grandson Šar-teššup carried out important activities in the administration and in the army. The presence of this kind of text in a private house can be explained easily by the interest of the members of this family to preserve a memory of their public activities. Thus, the father of Šar-teššup, who was a judge, kept tablets of particularly important trials, and Šar-teššup, who worked for the palace, kept a large number of tablets as a record of his activities.¹²

Unfortunately, in none of these texts is the name of the scribe of the tablets recorded, although the scribe Ur̒itilla appears in one text (HSS 14 249) together with the *mār šarri* ̒ut-teššup.

As the archaeological context or other archival data can offer only minimal additional information, before discussing the formulae of groups B and C, it is useful to take into consideration the different kinds of events recorded as dating elements:

- 1) For example, what does the mention of the king in these contexts mean? Usually these attestations have been connected by scholars with the data offered by other texts, and the movements of the king through his kingdom have been explained by the difficulties that Arraphēans had in the last years of their history. This is certainly true, but nevertheless it is not surprising that a king moved about through his kingdom. We know that in the kingdom of Arrapha there were several palaces, in different towns, and certainly the kings of Arrapha, like other kings in the Near East, traveled also during the more prosperous periods of their reigns; we can observe only that perhaps movement in these final phases was more frenetic and that more traces of such movement have been found.
- 2) We have seen that the formulae of group A are not unquestionably date formulae: their use is very infrequent and there is no trace of systematic organization. Nevertheless, is there any relationship between the Nuzi formulae and the dating system of the year names? There is no indication that in Nuzi official practices were followed to choose this kind of formula, but like year names, they offer indications of events that happened and were considered of relevance. In fact, they contain not only historical events, like battles or movements of armies and chariots, but also some “ideological” elements, like the movements of the king or events connected with the gods and the cult.

Turning to the other two groups of “date formulae,” connected respectively with the *hazannu* names and the presence of the word *šattu*, it is worth noting that all the texts come from private archives, unlike the texts of the previous group.

¹² Cf. P. Negri Scafa, “Gli archivi amministrativi di Nuzi e la loro dislocazione: sedi pubbliche e sedi private,” in *L'ufficio e il documento: I luoghi, i modi, gli strumenti dell'amministrazione in Egitto e nel Vicino Oriente antico*, Giornate di studio degli Egittologi e degli

Orientalisti italiani, Università di Milano – Università di Pavia, 17–19 febbraio 2005, edited by C. Mora and P. Piacentini (Milan: Cisalpino Istituto Editoriale Universitario, 2006).

B) NAME OF A *HAZANNU*

The formulae that are part of this second group, occurring in sentences often connected to a *šaṭir* formula, belong to a true dating system: they record that the tablet was written when a specific person was *ḥazannu*.

It is a rather complex system. From a formal point of view, it consists of a short sentence that reminds one of the date formulae, but it is centered on a man and on the rank he rises to. In this way, this system is closer to the Assyrian *līmu* system than to the Babylonian year-name system.

Another interesting aspect of this system is the fact that it is employed for only two persons, both *ḥazannus*: one is the famous, or better the notorious, Kušši-ḥarpe, who reveals his Kassite origin by his personal name. Kušši-ḥarpe¹³ is by far the most frequently cited in these formulae.¹⁴ The other *ḥazannu* whose name occurs in a date formula is Pai-tilla, son of Kuari.

The existence of so many date formulae with Kušši-ḥarpe has been explained as the influence of a more cultivated person on a less cultured sphere, but this explanation is not completely satisfactory. Many scribes used these formulae; among them are Belam-mušallim, Ina-umi-lublūṭ, Iškur-andul, Taya son of Apil-Sin, and his son It-ḥapiḥe. They were very active scribes who worked in the archive of Teḥip-tilla; nonetheless, they made only a very limited use of this kind of formula.

Other than Kušši-ḥarpe, the only other *ḥazannu* quoted with an eponym function is Pai-tilla, son of Kuari, in a contract of *tidennūtu* belonging to the archive of Ḥut-Arrapḥe, son of Tišam-mušni, written by Tarmi-teššup, son of Itti-šarri. In the date formula that concerns this *ḥazannu* a very interesting word, *kaḥaššinna*, occurs: *ṭup-pí an-ni-i i+na EGIR šu-du-ti šum-ma Pa-i-til-la DUMU Ku-a-ri i+na [URU] Nu-zi ka-ḥa-aš-ši-in-na a-na ḥa-[za-an-ni] ša i-pu-uš-šu-nu-ti i+na [KÁ.GAL ša] URU Nu-zi šá-ṭi-ir (JEN 290).*

The meaning of *kaḥaššinna* is unknown, and many interpretations have been suggested such as “illegally,” “for the second time,” or “against the people’s will,” and so on. E. Cassin, moreover, observed that the pronominal suffix *-šunūti* that follows *ipušū* could suggest that the *ḥazannu* was appointed not by only one individual (for example, the king) but by a community.

The *ḥazannus* played an important role in the life of the Kingdom of Arrapḥa: they had many responsibilities in public security and in the legal system as well. In fact, names of *ḥazannus* are quoted often in the witness lists in many contracts, the legality of which seems to be thus reinforced. In Nuzi texts no fewer than forty-six *ḥazannus* are cited.

Therefore, it is possible to conclude that the *ḥazannus* are the foundation of town life and that perhaps their presence in the witness lists could also have the function of a (“chronological”) reference point, something like “this contract was written when PN was *ḥazannu* / under the *ḥazannūtu* of PN.” This interpretation is suggested by the Kušši-ḥarpe date formula of JEN 46: *ù šu-un-du₄ ¹Gu-ši-ḥar-be [i]na URU Nu-zi ḥa-za-an-nu-ta i-pu-uš ù [ina] U₄-šu ¹Te-[ḥi-ip-t]il-la qa-aq-qa-ru an-nu-ú il-qè.*

But this does not answer the question of why the use of the formulae was limited to only two individuals. A possible answer to this question is suggested by the text of Pai-tilla: whatever meaning the obscure word *kaḥaššinna* may have, it seems certain to be connected with the particular circumstances under which Pai-tilla was raised to the office of *ḥazannu*. Therefore, it can be hypothesized that also in the case of Kušši-ḥarpe some peculiarity in his rise to his position could explain the use of date formulae.

In any case, we can observe that, even if these formulae are true date formulae, they are limited substantially to only two individuals, even if the role of the *ḥazannus* was important in the public life of the kingdom. There is no trace of an eponym-based date system, nor of a systematic organization of an eponym order, as in the Assyrian world where eponyms performed their office according a well-defined sequence from the king to the governors.

As for syntactical aspects in these formulae, it is interesting to observe that they are introduced by the same conjunctions as the formulae of group A: *ina ūmi, kīma, šundu, šumma, and undu*.

¹³ Kušši-ḥarpe underwent several trials in which his misuse of power was highlighted.

¹⁴ Texts with the formulae of Kušši-ḥarpe are: JEN 13, 31, 46, 23, 252, 257, 455, 587, 591, 693, 806, 916.

C) THE FORMULAE BEGINNING WITH MU (*ŠATTU*)

The smallest group, equivalent to only 10% of the dating formulae, collects together some clauses introduced by the very classic MU, like the year names. They differ from the sentences of group A mainly by the fact that they are employed in contracts and not only with the introductory term MU. Moreover, in the case of these formulae, the fact has been stressed that they are connected to the most ancient scribes, suggesting that they belong to the first phases of Nuzi documentation and therefore are most influenced by Babylonian culture. But, actually, a fragmentary formula occurring in EN 9/2 187, *tup-pu* [xxxxx] *i+na* MU [xxxxx] *i+na* KUR [xxxxx] *ina* URU *Nu-[zi xxx]*, written by Arip-šarri, a scribe associated with the third generation, a *warad ekalli*, and perhaps active also in the palace administration, demonstrates that formulae such as these could be written in any generation.

This kind of formula is most similar to the year names: nevertheless, the syntax is more irregular, and beside the initial MU the conjunctions *šundu* and *kīma* are also employed.

The topics of these formulae are of differing kinds, for example, the arrival of a particular kind of wood, even if attention is mainly focused on the king and his activities.

The most intriguing and perplexing is the formula of JEN 289, MU *It-ḫi-ja* LUGAL *ki-ma a-na* LUGAL-*ti iš-ša-ak-nu* MU *ša in-né-er-šu-ma ù la-a i-ḫí-dú-uš*, written when the king (Iḫija) ascended the throne. But the scribe (unfortunately unknown) did not stop there; he completed the formula by writing that it was the year “it was sown, but it was not reaped.”

It is evident that in this formula the ascension of the king to the throne is connected to a particularly difficult situation for the country. An examination of the year names and the date formulae from other countries shows that such a negative formula was not used elsewhere. Therefore, why did the scribe write this text? How can we explain this unusual formula?

It is difficult to contemplate a form of “private” political opposition by the scribe; this formula occurs at the end of a contract that could be exhibited at any moment if necessary, for example, to a judge.

It also seems difficult to connect this negative formula to an official promulgation: we have seen that the choice of a year name is a complex process full of ideological involvement, and moreover there are no traces of a similar procedure in Nuzi.

We do not know how the Nuzi scribes and officials chose the very few dates they used in their texts. Moreover, the fact is that in those regions and contexts in which year names are employed, they are never negative; even when the general political situation is difficult, positive elements are emphasized. The few “year names” in the Nuzi texts seem to follow in general this rule, so we must expect that positive, or at least neutral, events are recorded in the year formulae.

Therefore a possibility to justify such a contradictory formula is to divide it into two parts: one records the king’s ascent to the throne, the other records the dramatic situation of the country. The positive fact (the ascension of the king) becomes the dominant element, overcoming the dramatic situation.

There is another possible explanation. The second part of the formula refers to a particularly hard year and justifies in some way the contract of *tidennūtu*; the first part, which refers to the ascension of the king to the throne, could be an indication of some form of release (of debts and *similia*) that in Nuzi texts find expression in the *šūdūtu* clause.

Therefore, as far as the date formulae in which the term *šattu* occurs, they can generally be assimilated to the formulae of group A, even if those in which the king is referred to suggest a kind of *šūdūtu*.

CONCLUSION

In conclusion we can observe:

1. As for group A, even if the administrative texts coming from the palace and the connected areas are late and can record frenetic activities bound to a critical phase of the kingdom, nevertheless activities like travels of the king or worship of the gods are quite common in the life of a Near Eastern society. Therefore, these formulae seem to attest the common practice of recording the extra expenses connected with special events.

2. As for group B, we know that *ḥazannus* often occur in witness lists. The meager presence of date formulae with *ḥazannu* names can be interpreted as an occasional, expanded way of recording their presence—connected to the situation of rising to the rank—during the drawing up of a contract, possibly, rather than a dating system.
3. The particles *kīma* and *šumma* are used in the same way as in other forms of peripheral Akkadian, such as Amurru Akkadian and in particular Boghazköy Akkadian. This is consistent with other elements (in particular phonological) present in Nuzi texts and contributes to better defining the position of Nuzi Akkadian.

In conclusion, even if these formulae echo dating systems in use in other countries, they are scarcely influenced by those external systems and scarcely influence the internal Nuzi system, appearing to be one of the experimental attempts by which Nuzi scribes elaborate their special style.

CLASSIFYING ASSURBANIPAL'S INSCRIPTIONS: PRISMS C, KH (= CND), AND G*

Jamie Novotny, Chicago, Illinois

In 1996, Rykle Borger did the Assyriological community a great service by publishing concise, conflated “editions” of Assurbanipal’s *res gestae* and handwritten transliterations of several hundred clay prism and tablet fragments. There is little doubt that *Beiträge zum Inschriftenwerk Assurbanipals* is an extremely useful research tool for scholars and students of Near Eastern history and languages, and that it has begun filling the astonishingly large gap in our knowledge of late Neo-Assyrian inscriptions (721–612 B.C.).¹ Borger’s contribution has made it possible for other Assyriologists to examine the various prism editions, as well as numerous previously unpublished tablet fragments. This paper presents information on Prisms C, Kh (= CKalach), and G that has come to light since Borger’s publication, specifically on their classification and dates of composition (647 and 646 B.C.).

PRISM C²

This edition from Nineveh is the earliest known inscription to report on the death of Šamaš-šumu-ukīn and the fall of Babylon in the second half of 648.³ Prism C is known from four poorly preserved, decagonal clay prisms; there could be as many as twenty-four additional exemplars, but their attribution is not entirely certain (see the Appendix below). Although the text is still fragmentarily preserved, it is known that (1) the prologue of Prism I (formerly TVar) and the military narration of Prisms B and D were used as a template;⁴ (2) numerous editorial changes and additions were made to existing reports; (3) the death of Šamaš-šumu-ukīn and the fall of Babylon are described for the first time; (4) the inscription does not contain an account of the fourth Elamite campaign (see below); and (5) the building report described the rebuilding of a section of a palace in Nineveh, possibly the armory (*ekal māšarti*) in the outer town (Nebi Yunus).

* I would like to thank Grant Frame, Ronald Sweet, and Irene Winter for offering their critical remarks on a draft of this manuscript. Their time and care is greatly appreciated. Moreover, I am grateful to John Curtis and Christopher Walker for permitting me to collate Assurbanipal inscriptions in the British Museum; to Walter Farber for allowing me access to the Assurbanipal material in the Oriental Institute; and to the staff of the Department of the Ancient Near East (British Museum) and to Jonathan Tenney (University of Chicago) for the efficient and speedy supply of prisms. The passages from Prism G cited here were collated from the originals and those from Prism Kh are based on the published copies.

¹ R. Borger, *Beiträge zum Inschriftenwerk Assurbanipals: Die Prismenklassen A, B, C = K, D, E, F, G, H, J und T sowie andere Inschriften* (Wiesbaden: Harrassowitz, 1996).

² Borger, *Beiträge*, pp. 16–26, 28–37, 41–42, 92–101, 103–117, 122–127, 130–131, 137–155, 158–164, 205–208, 212–218, 220–232, 236–237, 243–245, and 253–254. All but one of the fragments originate from nineteenth-century British Museum excavations at Kuyunjik; VA 2972 most likely originates from clandestine digging at Nineveh. Borger rightly pointed out that Arthur Carl Piepkorn’s “Prism K” (= Theo Bauer’s “Prism G,” K. 1703) is identical to Prism C; for details, see Borger, *Beiträge*, p. 126. There are twenty-four prism fragments that may contain copies of this prism inscription, but the pieces do

not preserve enough for one to be certain to which inscription they belong. See the Appendix for the relevant pieces.

³ The Assyrians may have been in control of the city as early as the middle of the eponymy of Bēlšunu (648) or as late as the month of Tebet (X). Grant Frame, *Babylonia 689–627 B.C.: A Political History*, Publications de l’Institut historique et archéologique néerlandais de Stamboul 69 (Leiden: Nederlands Instituut voor het Nabije Oosten, 1992), pp. 155–57 and nn. 106–07, suggests that Babylon may have fallen by 1 Shebat (XI).

⁴ The prologue describes eight building projects: (1) the completion and decoration of Eḫursaggalkurkura; (2) the completion of Esagila and the return of the statues of Marduk and his entourage; (3) the refurbishing and fashioning of cult objects for Marduk and Zarpanitu; (4) the setting up of wild bulls in gateways of Ezida; (5) the decoration of Emašmaš and Egašankalama; (6) the refurbishing of Šarrat-Kidmuri’s divine image and the renewal of her cultic rites; (7) the setting up of lion-headed eagles and divine emblems in Egalmeslam; and (8) the rebuilding of Eḫulḫul and the construction of its twin Emelamana. The military narration recounts the king’s achievements on the battlefield: campaigns I (and II) report on events in Egypt; [III] in Anatolia and along the Syrian coast; IV in Qirbit; [V] in Mannea and Media; VI–[VII] in Elam; and [VIII] in Gambulu, Elam, Babylonia, and Arabia.

Although no exemplar of this text of approximately thirteen hundred lines preserves a date, scholars usually date Prism C to the post-canonical eponymy of Nabû-nâdin-aḫi (governor of Kār-Shalmaneser; modern Tell Ahmar), the same year that Prisms CKalach and G were issued; however, there has been no consensus as to the year he held this post, 647 or 646.⁵ It is now fairly certain (see below) that this edition was composed in 647 and that this governor of Kār-Shalmaneser was eponym in 646. A physical examination of the inscription's principal exemplar (K. 1741+) reveals that its *terminus ante quem* is the first war against the Elamite king Ummanaldasu (Huban-haltaš III); there is no space for such a report between the accounts of the overthrow of Indabibi in Elam and the wars against the Arabs.⁶ There is a lacuna of approximately twenty-three lines at the end of col. ix and a gap of about eighteen lines at the beginning of col. x, and it is very certain that these missing forty-one lines contained the first half of the description of the Arabian wars.⁷

A fragment in the Oriental Institute of the University of Chicago (A 8128) may support this observation. Assuming the piece is a duplicate of K. 1794+ and not an exemplar of Prism G, then col. ii' 8'–12' confirms that accounts of the Arabian campaigns immediately follow the statement about the accession of Ummanaldasu. After collation, the pertinent lines read:

- 8' m[um]l-[man-al-da-si DUMU m[at-ta-me-tu]
 9' ʾú]l-[še-ši-bu ina GIŠ.GU.ZA-šú]
 10' m[ia-u-ta-ʾ DUMU m[ha-za-a-DINGIR]
 11' L[UGAL KUR.qa-ad-ri e-piš ARAD-ti-ia]
 12' á[š-šú DINGIR.MEŠ-šú im-ḥur-an-ni-ma]⁸

Th[ey placed] Um[manaldasu, son of Atta-metu, on his (Indabibi's) throne. Iauta', son of Ḥazā-il],
 k[ing of Qedar, who does obeisance to me, approached me] a[bout his gods and ...]

With this new information, we now know that (1) the *terminus ante quem* for Prism C is the first war against Ummanaldasu; (2) that reports of the fourth Elamite campaign were recorded for the first time in inscriptions composed in the eponymy of Nabû-nâdin-aḫi (Prisms CKalach and G); and (3) that K. 13778 is an exemplar of Prism G (assuming the fragment comes from Nineveh). Since it is very likely that Prism C was composed one year earlier than Prisms CKalach and G, then the eponymy of Nabû-nâdin-aḫi cannot immediately follow that of Bēlšunu (648) but is separated from it by one year. Therefore, this governor of Kār-Shalmaneser had to have been eponym in 646. It is still uncertain which official was eponym in 647. Following Margarete Falkner, Nabû-da'ʾinanni of Que is tentatively assigned to this year.⁹ Given the new evidence for the dating of K. 1794+, the post-canonical eponyms for 648–645 should be:

- 648 Bēlšunu of Ḥindanu
 647 Nabû-da'ʾinanni of Que (attribution uncertain)
 646 Nabû-nâdin-aḫi of Kār-Shalmaneser
 645 Nabû-šar-aḫḫēšu of Samaria

⁵ For the opinion that Nabû-nâdin-aḫi's tenure was in 646 B.C., see A. Kirk Grayson, "The Chronology of the Reign of Ashurbanipal," *Zeitschrift für Assyriologie* 70 (1980): 245; and Mordecai Cogan and Hayim Tadmor, "Ashurbanipal's Conquest of Babylon: The First Official Report – Prism K," *Orientalia* NS 50 (1981): 239 and n. 24. For the suggestion that his eponymy was in 647 B.C., see most recently Robert Whiting, "The Post-Canonical and Extra-Canonical Eponyms," in Alan R. Millard, *The Eponyms of the Assyrian Empire 910–612 BC*, State Archives of Assyria Studies 2 (Helsinki: Neo-Assyrian Text Corpus Project, 1992), p. 74; Borger, *Beiträge*, pp. 130–31 and 257; and Julian E. Reade, "Assyrian Eponyms, Kings, and Pretenders, 648–605 BC," *Orientalia* NS 67 (1998): 256–57.

⁶ The earliest account of the fourth Elamite campaign is preserved on K. 13778, ND 4309, ND 4378B+, ND 5409, ND 5527, A 8149, and A 8150+, but not on Prism C's principal exemplar; see Borger, *Beiträge*, pp. 158–63 ix 87'–89'.

⁷ For the relevant fragments, see Theo Bauer, *Das Inschriftenwerk Assurbanipals*, Assyriologische Bibliothek, n.F., 1 (Leipzig: J. C. Hinrichs, 1933), pls. 5–6 and 12–13. Fragment 2 (pls. 5 and 12) contains Borger's C i 17–34 and x 39–55; i 17 is beside x 39. Fragments 9 and 37 (pls. 6 and 12–13) preserve Borger's C i 91–103, xi 70–86, and x 108–122; i 91 is next to x 111 and ix 73 is beside x 108. Lastly, fragment 36 (pls. 12–13) contains Borger's C ix 55–70 and x 100–107; ix 65 is next to x 101. The gap in the Arabian campaigns corresponds to Prism B vii 93–viii 30 (Borger, *Beiträge*, pp. 113–14).

⁸ Restored from Borger, *Beiträge*, p. 113 B vii 93–95 and p. 155 C ix 85–86.

⁹ For the proposed date of Nabû-da'ʾinanni's tenure, see Margarete Falkner, "Die Eponymen der spätassyrischen Zeit," *Archiv für Orientalforschung* 17 (1954–56): 118; and Jamie R. Novotny, "Zaḥalû-Metal for Marduk's *Paramāḫu* and the Date of Assurbanipal's E-Prisms," *Orientalia* NS 72 (2003): 215.

PRISM KH (= BORGER'S CKALACH AND CND)¹⁰

This edition is the second of Assurbanipal's *res gestae* composed after the conclusion of the Šamaš-šumu-ukīn rebellion, the only positively identified inscription of this king to have come from Calah (modern Nimrud), and the first of two prism inscriptions issued in the eponymy of Nabû-nādin-aḫi (646).¹¹ The fragments belong to a single prism class, one (according to Borger) most closely resembling Prism C. Since the military narration of this edition and Prism C were considered to be identical, Borger classified the inscription as CKalach (or CND), suggesting not only the version of the *res gestae* to which these fragments belong, but also the place where they were discovered.¹² However, a recent examination of K. 1794+ (see above) reveals that the Calah fragments are not exemplars of Prism C but are pieces of a different inscription, one that included a description of the fourth Elamite campaign. Since the present classification of Nimrud material is no longer valid, it is recommended that the designations CKalach and CND be discontinued. Prism Kh (= Kalach) is suggested as a suitable replacement.¹³

It is unclear how many exemplars there are, but there could be as many as fifteen copies or as few as two or three different prisms (see the Appendix below for the relevant fragments).¹⁴ Although there are large gaps in the text, it is certain that (1) Prism C's prologue and military narration were used as a template; (2) one new report was added to the military narration, a description of the fourth Elamite campaign; and (3) its building report described work on a section of Ezida.

Prism Kh is the first of two known prism inscriptions to have been issued in 646; the other is Prism G. Although the months in which the two editions were composed are not preserved, the evidence for the Calah inscription being the earlier of the two is three-fold:¹⁵ (1) the military narration of Prism G contains several editorial changes and additions; (2) the order of the first war with Ummanaldasu and the Arabian campaigns in Prism G was changed; and (3) the scribes responsible for the Nimrud prisms appear to have allocated more space for the description of war with Ummanaldasu than those who wrote out the copies of Prism G. Since the first two pieces of evidence will be presented in full with Prism G, only the third point is addressed here.

The Nimrud fragments (ND 4306+, ND 5406, and ND 5527) give the impression that the scribe(s) compressed the prologue and most of the military narration into eight columns so that they could describe *in extenso* the most recent campaign, the first war against Ummanaldasu with the conquest of Bīt-Imbī.¹⁶ The fragments from Nineveh (A 8150+, K. 13778, and BM 134436), on the other hand, give the impression that the scribes copied the same passage into a more confined space, between the description of the Arabian wars at the end of col. ix and the building account in the second half of col. x. A comparison of the script and line density of the fragments containing this report supports this theory; on average one line in Prism G corresponds to approximately two lines in Prism Kh.¹⁷

Given the evidence presented above, it is very likely that Prism Kh was the first prism inscription to report on the first war against Ummanaldasu. If this proves true, then this edition may have been issued sometime during the first two or three months (Nisan, Iyyar, or Sivan) of the eponymy of Nabû-nādin-aḫi and copies of Prism G may

¹⁰ Borger, *Beiträge*, pp. 16–26, 28–37, 41–42, 92–101, 103–117, 127–132, 137–155, 158–165, 205–208, 212–218, 220–232, 236–237, 243–245, 253–254, 257, and 381–383. Clay cylinder ND 6209, which is said to be a fragment of an Assurbanipal inscription, actually contains part of a copy of Šin-šarru-iškun B.

¹¹ A date is partially preserved on ND 5518+ vi' 5'–6' (Ebbe E. Knudsen, "Fragments of Historical Texts from Nimrud-II," *Iraq* 29 [1967], pl. 23): [... U]D.25.KÁM *lim-mu* ^{md}AG–A[Š–PAP] / [L]Ú.[GA]R?–[KUR?] URU.kar–^{md}šül-ma-nu-[-MAŠ], "[d]ay 25 of [the month ...], eponymy of Nabû-nā[adin-aḫi, go]v[ern]or of Kār-Shalmaneser."

¹² Most of the fragments were discovered in the Nabû temple (Ezida) by the British School of Archaeology and the Iraqi State Organization for Antiquities and Heritage; ND 814 was discovered in Assurnasirpal's palace (Room OO). For the provenances, see Knudsen, "Fragments of Historical Texts," pp. 65–69; and Muzahim Mahmud and Jeremy Black, "Recent Work in the Nabu Temple, Nimrud," *Sumer* 44 (1985–86): 136.

¹³ The redesignation of the inscription as Prism K is avoided so that the edition is not confused with Piepkorn's "Prism K."

¹⁴ It is certain that the following fragments do not come from the same object: ND 814 and ND 5406+; ND 814 and ND 5538+; ND 4306+ and ND 5406+; ND 4306+ and ND 5527; ND 4306+ and ND 5411A+; ND 4306+ and ND 5541; ND 4306+ and *Sumer* 44 (1985–86) No. 2+; ND 4378+ and ND 5408; ND 4378+ and ND 5410; ND 4378+ and ND 5538+; ND 5405 and ND 5410; ND 5405 and ND 5541; and ND 5411A–E+ and ND 6206.

¹⁵ For the dates, see notes 11 and 20.

¹⁶ On exemplar CND2, the report begins on col. ix, line 9; see Knudsen, "Fragments of Historical Texts," pl. 14 ND 4306.

¹⁷ For example, compare ND 4306 i' 10–13 with BM 134436 ii' 29'–30' and ND 5407 i' with K. 13778. See Bauer, *Das Inschriftenwerk Assurbanipals*, pl. 47; R. Campbell Thompson, "A Selection from the Cuneiform Historical Texts from Nineveh (1927–32)," *Iraq* 7 (1940), fig. 19 No. 34; and Knudsen, "Fragments of Historical Texts," pls. 14 and 20.

have been written a few months later, but probably before or during the sixth month of the year (Elul).¹⁸ Until fully preserved dates for both 646-editions come to light, this suggestion must remain hypothetical.

PRISM G¹⁹

This edition from Nineveh is the second and only other known prism inscription composed in the eponymy of Nabû-nādin-aḫi (646).²⁰ As suggested by several editorial changes and additions made to its military narration (see below), Prism G was probably issued not more than a few months after Prism Kh. Borger identified the inscription from fragments of Prism C and the now obsolete Prism “K.” The inscription is known from five poorly preserved, decagonal clay prisms, most of which were purchased from a dealer in Mosul; there could be as many as twenty-five additional exemplars, but their attribution is not entirely certain.²¹ Although there are large gaps in the text, it is fairly certain that (1) Prism Kh’s prologue and military narration were used as a template; (2) editorial changes were made to existing reports; (3) a new report was added to the description of the Arabian wars; (4) the order of the first war with Ummanaldasu and the campaigns against the Arabs was reversed; and (5) its building report described work on a section of Nineveh’s citadel wall.²² As far as the edition is preserved, the military narration differs from that of the earlier 646-edition as follows:

1. After the description of the surrender of Ba’alu of Tyre, the king states that he returned home. Prism G has [šal-meš a]-tu-ra a-na KUR-aš-šur.K[I] (“[I] returned [safely] to Assyria”) in place of [šal-meš a-tu-ra a-na NINA.KI URU be-l]u-ti-ia (“[I returned safely to Nineveh, the city of] my [lords]hip”).²³ Prism Kh follows Prisms B, D, and C in this regard (the same is true for Nos. 2, 3, and 4).

2. In the account of the “eighth” campaign, Assurbanipal boasts that he humiliated and executed Dunānu of Gambulu and some of his family and supporters. The scholar(s) responsible for this edition added one line to the description of the torture of Mannu-kî-aḫḫē and Nabû-ušalli in Arbela and altered and expanded the report of Dunānu’s execution in Nineveh. The pertinent passages read:

PRISM KH

(vii 21) ša mman-nu-ki-PAP.MEŠ LÚ.[2-u (ša) mdu-na-nu] (vii 22) ḫù mdAG1-ú-šal-li LÚ.[šá-UGU-URU KUR.gam-bu-li] (vii 23) ša UGU DINGIR.MEŠ-ḫa¹ iq-b[u-u šil-la-tú GAL-tú] (vii 24) qé-reb URU.LÍMMU-DINGIR EME-šú-[un¹ á[š-lu-up áš-ḫu-ṭa KUS-šú-un] (vii 25) mdu-na-nu q[é-reb NINA.KI] (vii 26) e-li GIŠ.ma-ka-ši [id-du-šú-ma] (vii 27) iṭ-bu-ḫu-uš [as-liš]

As for Mannu-kî-aḫḫē, the [deputy of Dunānu], and Nabû-ušalli, the [city overseer of Gambulu], who had utte[red grievous blasphemies] against my gods, I [tore out] their tongue(s) (and) [flayed them] inside Arbela. (As for) Dunānu, [they laid him] on a slaughtering-bench in[side Nineveh and] butchered him [like a sheep].²⁴

¹⁸ Compare the relationship between Prisms F and T; the earliest known F-exemplar was inscribed on 24 Ayyaru (II) 645 and the earliest copy of T preserving a date was written out on 6 Abu (V) 645; see Borger, *Beiträge*, p. 76 Assur 825 vii 5–6 and p. 172 K. 1729 iii’ 7’–9’. The “Thompson Prism” (BM 121006+) is the latest known prism inscribed within the lunar year: 24 Elul (VI) 645.

¹⁹ Borger, *Beiträge*, pp. 16–17, 21–22, 29–30, 35–37, 41–42, 93, 98, 104–106, 108–112, 115–117, 119–120, 127, 130–132, 143–146, 150–154, 159–160, 165–167, 205, 207, 213, 216–217, 221, 224–226, 229–232, 237, 244–245, 257, 338, 370–373, and 378. There are twenty-five prism fragments that may contain copies of this prism inscription, but the pieces do not preserve enough for one to be certain to which inscription they belong. See the Appendix for the relevant pieces.

²⁰ A date is partially preserved on A 8104 i’ 7’–9’ (Borger, *Beiträge*, p. 167): [...] ḫUD.10? KÁM¹ / [lim-mu md(+)AG]–AŠ–PAP / [LÚ. GAR?–KUR? URU.kar–m] ḫšul-ma-nu–MAŠ, “day 10 of [the month ... , eponymy of Nabû]-nādin-aḫi, [governor of Kār]-Shalmaneser.”

²¹ In addition to the three exemplars identified by Borger, K. 13778 (Bauer, *Das Inschriftenwerk Assurbanipals*, pl. 47) and A 8149 (Borger, *Beiträge*, 4^o Heft 122) are now regarded as copies of Prism G since they both preserve part of the report of the fourth Elamite campaign.

²² Although the building report is not preserved, the association with the citadel wall is known from the concluding formula in ix 8’’: BĀD šu-a-tu (“that wall”). See Borger, *Beiträge*, p. 119 (A 8111 ii’ 8’).

²³ Compare A 8003 i’ 14’ (Jamie R. Novotny, “A 8003: A Fragment of Assurbanipal Prism G,” *Journal of Cuneiform Studies* 56 [2004]: 20, fig. 1) with ND 4378D i’ 4’ (Knudsen, “Fragments of Historical Texts,” pl. 17). The passage is restored from Borger, *Beiträge*, 4^o Heft 73 A 8005 iii’ 28’.

²⁴ Borger, *Beiträge*, 4^o Heft 267 ND 5411A–E iv’ 43’–49’. The lines correspond to Borger’s C vii 84–107 (Borger, *Beiträge*, p. 108).

PRISM G

(vii 1'') [... ša UGU DINGIR.MEŠ-ia i]q-bu-[u] (vii 2'') [šil-la-tú GAL-tú ... la?] [ṭa]l-a-bu (vii 3'') [qé-reb URU. LÍMMU-DINGIR EME-šú-un] áš-lu-up (vii 4'') [áš-ḥu-ṭa KUS]-šú-un (vii 5'') [mdu-na-nu (u) msa-am-gu-nu? ḥi-ri]-[i]š GAL₅.LÁ.MEŠ (vii 6'') [... l]a? e-piš ARAD-ti-ia (vii 7'') [qé-reb NINA.KI meš-re-ti-šú-un?] ú-par-ri-is (vii 8'') [...] LUGAL.MEŠ a-šib pa-rak-ki (vii 9'') [...] [ú]l-še-bil

[As for Mannu-kî-aḥḥē, the deputy of Dunānu, and Nabû-ušalli, the city overseer of Gambulu, who] had utter[ed grievous blasphemies against my gods, ... un]favorable [...], I tore out [their tongue(s) (and) flayed th]em [inside Arbela. (As for) Dunānu (and) Samgunu, exact cop]ies of gallû-demons, [...] who did [no]t do obeisance to me, I had [their limbs] cut off [inside Nineveh. ...] the kings who sit upon throne-daises, I had [...] brought [...]²⁵

3. Prism G provides some additional information on why Tammaritu was deposed by his servant Indabibi, namely what the Elamite said to offend Assurbanipal's tutelary deities (Aššur and Mullissu). Tammaritu's "insolent words" (*mēreḥtu*) concerning the beheading of his predecessor Teumman and the submission of Ummanigaš (Huban-nikaš II) are recorded in this inscription for the first time. There are a few additional changes to the report. Compare the two accounts:

PRISM KH

(vii 34') [m]tam-ma-ri-tu MAN KUR.ELAM.M]A.K[1] (vii 35') [ša me-ri-iḥ-tu iq-bu-ú] (vii 36') [e]l-[li ni-kis SAG.DU mte-um-man] (vii 37') [š]a ik-k[i-su a-ḥu-ru-ú ERIM.ḪI.A-ia] (vii 38') [ù]l ŠEŠ.IMEŠ[1-šú qin-nu-šú NUMUN É AD-šú] (vii 39') it-ti 8[5 NUN.MEŠ šá KUR.ELAM.MA.KI] (vii 40') a-li-kut [Á^{II}-šú]

[Tammaritu, king of Ela]m, [who spoke insolent words] on ac[ount of the decapitation of Teumman, w]hom [a low-ranking soldier from my army] had beh[eaded], and [his] brothers, [his family, (and) the seed of his father's house], with 8[5 Elamite nobles] who march at [his side] ...²⁶

PRISM G

(viii 38b') m]tam-ma-ri-tu [MAN KUR].[ELAM.MA]l.KI (viii 39') [š]a UGU ni-ki[s SAG.DU mte-um-man] me-ri-[iḥ-tú]l (viii 40') [iq-bu]l-u šá ik-ki-su a-ḥu-ru-[ú ER]IM.ḪI.A-ia (viii 41') um-ma i-nak-ki-su-u S[AG.DU MAN KUR. ELAM.M]A.KI (viii 42') ina qé-reb KUR-šú ina [UKKIN] [ERIM.ḪI.A-šú šá-ni-ia-a-nu iq-bi] [ù]l m[um]l-man-i-gaš (viii 43') ke-e [ú-na]l-[áš-šiq qaq-qa-ru ina pa-an LÚ.A-K]IN.MEŠ (viii 44') [ša maš-šur]l-DÛ-A MAN [KUR.AN.ŠÁR. KI bi-nu-ut AN.ŠÁR u? d]NIN¹.LÍL (viii 45') [UGU]l [a-ma-a-ti an-na-a-ti šá il-zi-nu AN.ŠÁR u dNIN.LÍL? e-ri-ḥ]u-šú-ma (viii 46') [m]tam-ma]l-[ri-tú ŠEŠ.MEŠ-šú qin-nu-šú NUMUN É] [AD]l-šú (viii 47') [i]t-[ti]l [85 NUN.MEŠ šá KUR. ELAM.MA.KI a-li-kut i]-[di]l-šú (viii 48') [...] x x

Tammaritu, [king of] Elam, [wh]o spoke insolent words on account of the decap[itation of Teumman], whom a low-ranking soldi[er from] my [ar]my had beheaded, saying: "Does one cut off the h[ead of the king of Ela]m in his own land, in the assembly of [his troops?]" He spoke a second time]: "Moreover, how could Ummanigaš ki[ss the ground before the messe]ngers of Assurbanipal, king of [Assyria, the creation of Aššur and] Mullissu?" On account of [these words that he had slanderously uttered, Aššur and Mullissu attac]ked him. Tamma[ritu, his brothers, his family, (and) the seed of] his father's [house, w]ith [85 Elamite nobles who march at] his [s]ide [...]²⁷

²⁵ Borger, *Beiträge*, 4° Heft 109–110 A 8109 i' 1'–9'.

²⁶ Donald J. Wiseman, "Two Historical Inscriptions from Nimrud," *Iraq* 13 (1951): pl. 12 ND 814 i' 20'; and Knudsen, "Fragments of Historical Texts," pl. 17 ND 4378C ii' 1'–5'. The lines correspond to Borger's C viii 48–53 (Borger, *Beiträge*, pp.110–11).

²⁷ Borger, *Beiträge*, 4° Heft 71 A 8004 ii' 11'–14', 83 A 8012 i' 16'–26', 103 A 8094, and 108 A 8107 ii' 5'–13'. The passage is a conflated text (exs. G1B and G2).

4. In the description of the Arabian wars, a brief report of the defeat and capture of queen ADīia (exact reading uncertain) was added before the episode describing the submission of the Nabatean king Natnu. The event probably took place very early in the eponymy of Nabû-nādin-aḫi (646) and appears to be the latest event narrated in Prism G. The new report reads:

(ix 1'') [f]a-[Di-ia-a šar-rat KUR.a-ri-bi] (ix 2'') di-ik-ṽaṽ-[šá ma-ṽ-as-su a-duk] (ix 3'') kul-ta-re-e-ṽšáṽ [ina dGIŠ. BAR aq-mu] (ix 4'') šá-a-šá bal-tu-us-[sa ina šU^{II} aš-bat] (ix 5'') it-ti ḫu-bu-ut [KUR-šá?] (ix 6'') al-qa-áš-ši [a-na KUR-aš-šur.KI]

[I inflicted a heavy] defeat [on] A[Dīia, a queen of Arabia, (and) I burned] her tents [with fire. I captured] her alive (and) brought her [to Assyria] with plunder from [her land].²⁸

5. The last known difference in the military narration of the two 646-editions is that the order of the first war with Ummanaldasu and the Arabian campaigns was altered. The report of the fourth Elamite campaign (including the conquest of Bīt-Imbî) is placed after the description of the submission of the Nabatean king Natnu; in Prism Kh the Elamite campaign appears before the account of the wars in Arabia.

With regard to the first war with Ummanaldasu, an examination of the opening lines of the reports of the “eleventh” campaign reveals that both 646-editions began in the same way. Compare the poorly preserved passages:

PRISM KH

(ix 10) [i-na 11-e? gir-r]i-ia (ix 11) [a-na KUR.ELAM.MA.KI?] al-lik (ix 12) [ina? me-ti-iq? gir?-r]i-ia (ix 13) [URU. É-mim-bi-i? URU tukul-ti? KUR.ELAM.MA.KI? ak?-š]u?-ud

[On] my [eleventh campai]gn, I marched [against *Elam (and) during the course of*] my [campai]gn [I conqu]ered [Bīt-Imbî, a city upon which *Elam relies*].²⁹

PRISM G

(ix 29'') i-na 11-e gir-ri-ia ṽaṽ-[na KUR.ELAM.MA.KI? al-lik? ina? me-ti-iq? gir-ri-ia?] (ix 30'') URU.É-mim-bi-i URU tukul-t[i KUR.ELAM.MA.KI ak-š]u-ud

On my eleventh campaign, [I marched] ag[ainst *Elam (and) during the course of my campaign*] I conqu]ered Bīt-Imbî, a city upon which [Elam] reli[es].³⁰

SUMMARY

To summarize, Borger’s new volume has laid a solid foundation for the future publication of Assurbanipal’s vast text corpus and made it possible for Assyriologists to readily examine the various prism editions. Recent work on the numerous prism and tablet fragments in the British Museum and the Oriental Institute (University of Chicago) has brought to light new information on the more fragmentary texts of Assyria’s last great king, in particular on Prisms C, Kh (formerly CKalach), and G. From these, five advances in our knowledge of these three inscriptions have come to light:

1. Prism C does not contain a report of the first war against Ummanaldasu and this inscription was likely written in the year before the eponymy of Nabû-nādin-aḫi, i.e., 647.

²⁸ Thompson, “Selection from the Cuneiform Historical Texts,” fig. 19 no. 34 BM 133436 ii’ 1’–6’.

²⁹ Knudsen, “Fragments of Historical Texts,” pl. 14 4306 i’. The lines correspond to Borger’s C ix 87–91 (*Beiträge*, p. 158).

³⁰ Thompson, “Selection from the Cuneiform Historical Texts,” fig. 19 no. 34 BM 133436 ii’ 29’–30’; and Borger, *Beiträge*, 4° Heft 111 A 8111 i’ 1’.

2. Reports of the fourth Elamite campaign were recorded for the first time in inscriptions composed in the eponymy of Nabû-nādin-aḫi (646).

3. Prism Kh (= Kalach) is suggested as a replacement for the Assurbanipal material from Calah. (CKalach is no longer valid since an examination of Prism C's principal exemplar reveals that the Nimrud fragments belong to a different inscription, one containing an account of the first war against Ummanaldasu.)

4. The military narration of Prism G differs from that of Prism Kh in at least three passages, adds a new passage to the description of the Arabian campaigns, and places the fourth Elamite campaign after the report of the wars in Arabia.

5. Prism Kh can now be argued to have been written earlier in the eponymy of Nabû-nādin-aḫi than Prism G. The former may have been issued sometime during the first two or three months (Nisan, Iyyar, or Sivan) of the year, while copies of the latter may have been written a few months later, but probably before or during the sixth month of the year (Elul).

A better understanding of Prisms C, Kh, and G now makes it possible to reconstruct with more certainty the dates of Nabû-nādin-aḫi's (646) and Nabû-šar-aḫḫēšu's (645) tenures as eponym-officials, and the dates of the two wars with the Elamite king Ummanaldasu (647 and 646) and the capture of the Arabian queen ADīia (early 646). These advances in knowledge also provide new information on how Assurbanipal's literary craftsmen codified and modified the king's accomplishments with each new edition, in particular his victories in Arabia, Babylonia, and Elam.

APPENDIX: CATALOGUE OF PRISM C, KH, AND G EXEMPLARS

PRISM C

1. K. 1703 (**C11B**) (+) K. 1704 (**C11A**)
2. K. 1705 (+) VAT 2972 (**C2B**) (+) K. 1707 (**C2C**) (+) Rm 3 (**C2A**)
3. K. 1794 (BM 93007) + Sm 2101 + Sm 2103 + Sm 2109 + 81-2-4,172 + 81-7-27,16 + 82-5-22,15 (+)? K. 13730 (**C1**)
4. Rm 27 (**C15**)

PRISM KH

1. ND 814 (IM 56875) (**CND1**)
2. ND 4306 (**CND2A**) (+) ND 4378B + ND 4378C + ND 5407 + ND 5413E + ND 5522 (BM) + ND 5518 + ND 5519 + ND 5524 + ND 5525 + ND 5520 + ND 5521 + ND 5523 + ND 5532 (IM 67611) + ND 5529 + ND 5531 (BM) + ND 5533 (BM) + ND 5537 + ND 5548 (**CND2B**) (+) *Sumer* 44 (1985–86) No. 4 (**CND2C**)
3. ND 4378 + ND 4378A + ND 4378D + ND 5409 + ND 5528 (BM) + ND 5530 + ND 5549 + ND 5536 (BM) + ND 6205A (BM) (**CND3**)
4. ND 5405 (BM) (**CND4**)
5. ND 5406 (+)? ND 5517 (IM 67608) (**CND5**)
6. ND 5408 (BM) (**CND6**)
7. ND 5410 (BM) (**CND7**)
8. ND 5411A–E (BM) + ND 5413A–D (BM) + ND 6205B–D (BM) (+)? ND 5412 (+) ND 6205E (BM) (**CND8**)
9. ND 5527 (**CND9**)
10. ND 5534 (BM) (**CND10**)
11. ND 5538 (BM) + ND 5546 + ND 5547 (**CND11**)

12. ND 5541 (IM 67613) (**CND12**)
13. ND 5543 (BM) (**CND13**)
14. ND 6206 (**CND14**)
15. *Sumer* 44 (1985–86) No. 2 +? No. 3 (**CND15**)

PRISM G

1. K. 13778 (**C16**)
2. A 7960 + A 8003 + A 11867 (**G1A**) (+) A 7982 + A 7985 + A 8012 + A 8107 + A 8117 + A 8151 + A 8162 (**G1B**) (+) A 8011 + A 8104 (+) A 8137 (**G1C**) (+) A 8106 (**G1D**) (+) A 8111 (+)? BM 134436 (1932-12-12,431; TM 1931–2,26) (**G1E**) (+) A 8150 + A 8159 (**G1F**) (+) A 11870A (**G1G**)
3. A 7988 + A 8004 + A 8094 (**G2**)
4. A 8109 (**G3**)
5. A 8149

UNCERTAIN ATTRIBUTION

C or G

1. K. 1709 (**C10**)
2. K. 1848 (**C5**)
3. K. 1854 (**C8**)
4. Sm 1882 (**C14**)
5. Rm 2,387 (**C6**)
6. Rm 2,546 (**C3**)
7. BM 127918 (**C12**)
8. BM 127941 (**C7**)
9. BM 127958 (**C4**)
10. BM 128130 (1929-10-12,786) + BM 128133 (1929-10-12,789) + BM 128136 (1929-10-12,792) (+) A 7942 (**C9**)
11. A 8001 (+)? BM 128307 (1932-12-10,564) (**C13**)
12. A 8128

C, G, B, D, F, or A

13. K. 17588
14. BM 121118

C, G, B, D, or A

15. K. 16033
16. K. 16775
17. K. 21420
18. K. 21651
19. A 7941

C, G, or A

20. K. 1801
21. K. 13751
22. Sm 2026
23. A 8089
24. A 8090

G or D

25. 1905-4-9,135 (BM 98629)

LES LISTES ET LES TABLES MÉTROLOGIQUES, ENTRE MATHÉMATIQUES ET LEXICOGRAPHIE*

Christine Proust, Paris, France

Les tablettes scolaires métrologiques sont à la fois abondantes et mal connues. Pour la très grande majorité d'entre elles, elles appartiennent au vaste ensemble des listes enseignées dans les écoles de scribes mésopotamiennes à l'époque paléo-babylonienne, tout comme les listes lexicales et les tables numériques. Elles peuvent se présenter sous deux formes différentes: les **listes** métrologiques sont des énumérations de mesures de capacité, de poids, de surface, et de longueur; les **tables** métrologiques sont des énumérations des mêmes items que les listes, mais accompagnés de leur conversion en nombre sexagésimal positionnel.

Comme les autres tablettes scolaires, les listes et les tables métrologiques sont très nombreuses dans les collections de tablettes des musées, notamment de Philadelphie, d'Istanbul, et de Jena. Pourtant, elles ont très peu été publiées jusqu'à une date récente, et leur importance dans la formation des scribes de Mésopotamie est largement sous-estimée. Cette constatation n'est pas nouvelle:

Il s'agit de tablettes métrologiques qui donnent la séquence des mesures C'est un type de tablettes assez fréquent dans les musées, mais qui n'a pas attiré suffisamment l'attention. Les historiens des mathématiques les trouvant apparemment trop simples, une étude d'ensemble manque encore (M. Civil, "Sur les 'livres d'écoliers' à l'époque paléo-babylonienne," dans *Miscellanea Babylonica: Mélanges offerts à Maurice Birot*, édité par J.-M. Durand, et J.-R. Kupper [Paris: Éditions Recherche sur les Civilisations, 1985], p. 77).

Relativement fréquentes dans les musées, ces tablettes n'ont que peu intéressé les épigraphistes et les historiens des sciences (C. Michel, "Les marchands et les nombres: l'exemple des Assyriens à Kanis," dans *Intellectual Life of the Ancient Near East* [43^{ième} RAI], édité par J. Posecky [Prague: Oriental Institute, 1998], p. 253).

"While the metrological systems themselves are very well known, the elementary school tablets onto which students copied them have barely been published or studied at all" (E. Robson, "Mathematical Cuneiform Tablets in the Ashmolean Museum, Oxford," *SCIAMVS: Commentaries Sciences* 5 [2004]: 3–66, p. 12).

Les listes et les tables métrologiques connues proviennent principalement de Nippur. Elles représentent presque la moitié des tablettes mathématiques trouvées sur ce site: 365 parmi les 828 tablettes et fragments de Nippur qui ont un contenu mathématique identifiable.¹ La métrologie représente donc une part très importante de la formation mathématique des scribes. Quelle est précisément la fonction respective des listes et des tables métrologiques dans cette formation? La différence entre les listes et les tables est-elle de pure forme ou bien a-t-elle un sens plus profond? Pourquoi, à Nippur, les deux types de textes coexistent-ils, en quantité à peu près égale? Ces questions soulèvent des problèmes qui touchent à l'organisation de l'enseignement dans les écoles de scribes, et notamment à l'articulation entre l'apprentissage de l'écriture et l'apprentissage du calcul. Le but de cet article est d'aborder ces questions par le biais de l'analyse comparée des listes et des tables métrologiques de Nippur. Cette analyse portera plus précisément sur les liens qui rattachent ces deux types de textes au reste du corpus scolaire, sur leur distribution statistique, et sur leur utilisation dans les opérations mathématiques.

* Cette communication a été remaniée en profondeur à la suite des questions qui ont suivi sa présentation à Chicago. Je remercie vivement les participants pour leurs remarques stimulantes, qui m'ont permis d'approfondir des problèmes importants, et en premier lieu Niek Veldhuis. Je remercie également Théodora Seal, dont la relecture attentive et critique a grandement amélioré le texte.

¹ Voir les données statistiques au § 3. Je me limite ici et dans tout ce qui suit au lot de tablettes exhumées par la Babylonian Expedition à la fin du XIX^e siècle. Ce choix est justifié au § 3.

Mais tout d'abord, il convient de donner une description plus détaillée des listes et tables métrologiques. Le contenu textuel tout autant que les aspects matériels des tablettes doivent être pris en considération. En particulier, la typologie des tablettes joue un rôle important dans l'analyse qui suit. Rappelons donc les définitions des types de tablettes, telles qu'elles ont été proposées par M. Civil.²

- Type I** Grande tablette écrite sur plusieurs colonnes; le texte du revers est la suite du texte de la face. Contient le texte “maître,” dont sont extraites les courtes séquences écrites sur les tablettes de type II, III, ou IV.
- Type II** (II/1 = type II, face; II/2 = type II, revers) Tablette de taille moyenne, écrite sur plusieurs colonnes. Les textes de la face et du revers sont indépendants. La face contient un modèle du maître et une ou plusieurs copies d'élèves. Sur le revers, on trouve un texte plus long, assimilé dans les jours ou mois précédents (voir figure 1: Ist Ni 3913).
- Type III** Petite tablette, de présentation en général soignée, écrite sur une seule colonne; contient un court extrait de liste ou une section (par exemple, une table de multiplication). Le texte du revers est la suite du texte de la face.
- Type IV** Petite tablette d'exercice carrée ou ronde, de profil plan-convexe; à Nippur, généralement carrée et anépigraphe sur le revers.

1. LES LISTES ET TABLES MÉTROLOGIQUES À NIPPUR

Dans leur grande majorité, les tablettes scolaires de Nippur sont des exercices d'apprentissage de l'écriture et du calcul appartenant aux premières années de la formation scribale.³ Le “niveau élémentaire” présente deux caractéristiques majeures: les textes sont écrits sous forme de listes; la mémorisation est une dimension importante de l'enseignement.⁴ Dans le domaine de l'écriture et du sumérien, les textes de niveau élémentaire regroupent les syllabaires, les listes lexicales, les listes de modèles de contrat, et les listes de proverbes.⁵ Dans le domaine des mathématiques, ils regroupent les listes métrologiques, les tables métrologiques, et les tables numériques (inverses, multiplications, carrés, racines carrées, racines cubiques).⁶

On peut trouver l'ensemble complet de toutes les listes métrologiques, rassemblant les quatre sections (capacités, poids, surfaces, et longueurs), dans quelques exemplaires de tablettes type I, provenant de Nippur.⁷ Ces tablettes récapitulatives constituent un exposé structuré des systèmes numériques et métrologiques normalisés, tels qu'ils sont utilisés en Mésopotamie à l'époque paléo-babylonienne, aussi bien dans le cadre scolaire que dans les pratiques administratives et commerciales. Les listes métrologiques constituent une sorte de description “en extension”⁸ de la

² Miguel Civil et al., *The Series lú = ša and Related Texts*, Materials for the Sumerian Lexicon 12 (Rome: Pontificium Institutum Biblicum, 1969), p. 5.

³ Pour ce qui concerne l'apprentissage de l'écriture dans les écoles de scribes, la typologie des textes scolaires, la structuration de l'enseignement en plusieurs niveaux, voir notamment: M. Civil et al., *Ea A = nâqu, Aa A = nâqu, with their Forerunners and Related Texts*, Materials for the Sumerian Lexicon 14 (Rome: Pontificium Institutum Biblicum, 1979); Antoine Cavigneaux, “Lexikalische Listen,” *Reallexikon der Assyriologie* 6 (Berlin: Walter de Gruyter, 1983), pp. 609–41; Niek Veldhuis, “Elementary Education at Nippur: The Lists of Trees and Wooden Objects” (Ph.D. diss., University of Groningen, 1997); Eleanor Robson, “The Tablet House: A Scribal School in Old Babylonian Nippur,” *Revue d'Assyriologie* 95 (2001): 39–66.

⁴ “...the main mode of existence of the Old Babylonian ur₅-ra was in the mind, not in writing” (Veldhuis, “Elementary Education,” p. 132).

⁵ Veldhuis, “Elementary Education.”

⁶ Pour une description détaillée des tablettes mathématiques de niveau élémentaire à Nippur, voir Robson, “The Tablet House”; Robson,

“More than Metrology: Mathematics Education in an Old Babylonian Scribal School,” in *Under One Sky: Astronomy and Mathematics in the Ancient Near East*, édité par John M. Steele et Annette Imhausen, *Alter Orient und Altes Testament* 297 (Münster: Ugarit-Verlag, 2002); Christine Proust, *Tablettes mathématiques de Nippur*, *Varia Anatolica* 18 (Istanbul: IFEA, diffusion De Boccard, 2007).

⁷ Voir par exemple les tablettes CBS 10990+ dans Hermann V. Hilprecht, *Mathematical, Metrological and Chronological Tablets from the Temple Library of Nippur*, *Babylonian Expedition* 20/1 (Philadelphie: 1906), No. 29; HS 249, dans Manfred Krebernik et Christine Proust, *Tablettes mathématiques de la collection Hilprecht*, *Texte und Materialien der Frau Professor Hilprecht Collection* 8 (Leipzig: à paraître). Pour ce qui concerne les types de tablettes, voir Civil, *MSL* 12, p. 5. Ces définitions sont rappelées plus loin dans le présent texte (voir § 3).

⁸ L'expression est prise dans le sens que lui donnent les mathématiciens: on peut dans certains cas définir un ensemble “en extension,” c'est-à-dire en énumérant ses premiers éléments (exemple: {0, 2, 4, 6, ...} définit l'ensemble des nombres pairs).

métrologie normalisée: écriture des unités de mesures et des nombres qui leur sont associés, rapports entre les différentes unités.⁹ Cette longue énumération de plusieurs centaines d'items peut être réduite à une présentation synthétique sous la forme de "diagrammes fléchés,"¹⁰ où apparaissent les facteurs multiplicatifs qui définissent chaque unité par rapport aux autres.

Tableau 1. Représentation synthétique des listes métrologiques.

Capacités (1 sila ₃ ≈ 1 litre)
gur ←5– barig ←6– ban ₂ ←10– sila ₃ ←60– gin ₂
Poids (1 gu ₂ ≈ 30 kg)
gu ₂ ←60– ma-na ←60– gin ₂ ←180– še
Surfaces (1 sar ≈ 36 m ²) ¹¹
GAN ₂ ←100– sar [←60– gin ₂ ←180– še]
Longueurs (1 ninda ≈ 6 m)
danna ←30– UŠ ←60– ninda ←12– kuš ₃ ←30– šu-si

Les systèmes numériques utilisés ne sont pas les mêmes pour toutes les unités. Par exemple, les unités de capacité "gur" et de poids "gu₂" sont associées à une numération sexagésimale de principe additif dite "système S," cependant que l'unité de surface "GAN₂" est associée à une numération non sexagésimale dite "système G."¹²

Pour donner un exemple de liste métrologique, considérons une tablette de Nippur conservée au Musée Archéologique d'Istanbul, Ist Ni 3913, typique par son contenu et par son aspect. Sur la face de la tablette, on trouve un court extrait de liste lexicale Proto-Izi (voir la translittération § 5), et sur le revers on trouve la liste métrologique des mesures de capacités presque complète (translittération ci-dessous). Il s'agit d'une tablette de type II. Les colonnes du revers se succèdent de droite à gauche, comme il est d'usage. L'association des listes métrologiques de capacités avec des listes lexicales est courante à Nippur, et c'est précisément l'analyse de ce phénomène qui sera au cœur de la partie statistique de cet article (§ 3).

⁹ Voir le "texte composite" des listes et tables métrologiques de Nippur dans Proust, "Tablettes mathématiques de Nippur."

¹⁰ Cette présentation très claire des chaînes d'unités métrologiques a été introduite par Jöran Friberg, *The Early Roots of Babylonian Mathematics 2, Metrological Relations in a Group of Semi-pictographic Tablets of the Jemdet Nasr Type, Probably from Uruk-Warka* (Chalmers University of Technology, University of Göteborg, 1979).

¹¹ On trouve dans les exercices scolaires de Nippur des sous-multiples du sar identiques à ceux de la mine (gin₂ et še). Ces unités ne sont toutefois pas présentes dans les listes et tables métrologiques, c'est pourquoi je les ai placées entre crochets dans le diagramme fléché.

¹² Sur les systèmes numériques utilisés en métrologie, voir Robert Englund, "Administrative Timekeeping in Ancient Mesopotamia," *Journal of the Economic and Social History of the Orient* 31 (1988): 121–85; Marvin A. Powell, "Masse und Gewichte," *Reallexikon der Assyriologie* 7 (Berlin: Walter de Gruyter, 1990), pp. 457–530; Hans Nissen, Peter Damerow, et Robert Englund, *Archaic Bookkeeping: Writing and Techniques of Economic Administration in the Ancient Near East* (Chicago: University of Chicago Press, 1993); Jöran Friberg, "On the Alleged Counting with Sexagesimal Place Value Numbers in Mathematical Cuneiform Texts from the Third Millennium BC," *Cuneiform Digital Library Journal* 2005:2 (2005).

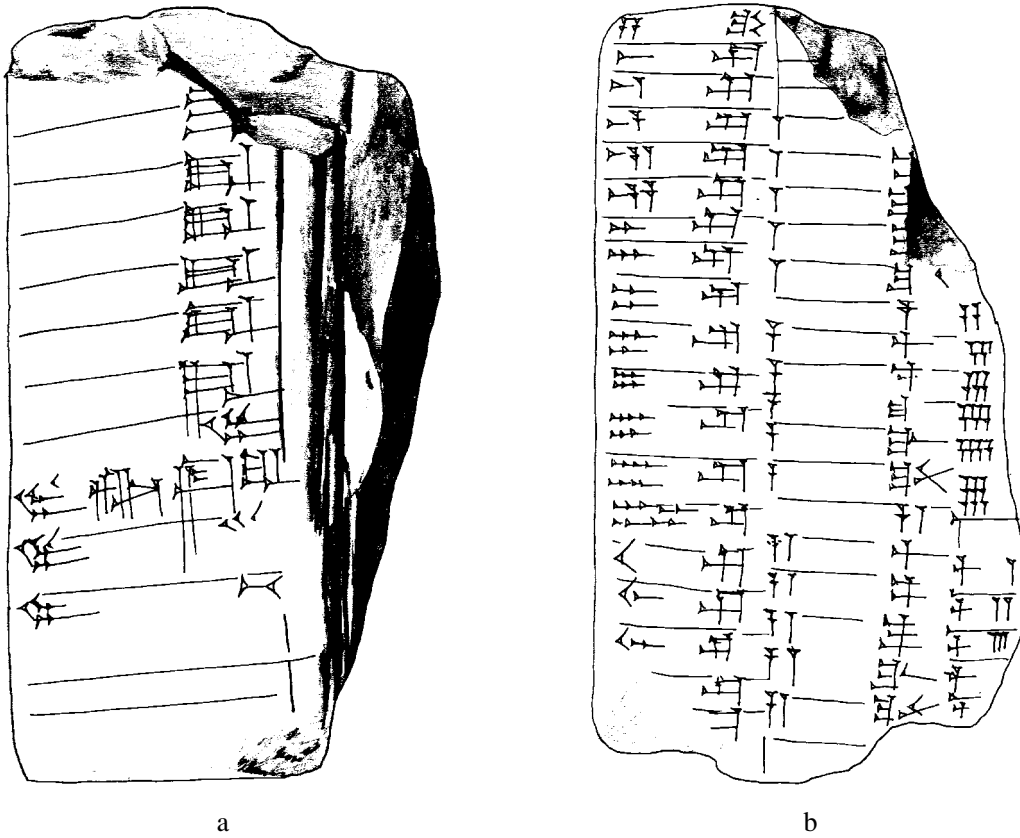

Figure 1. Ist Ni 3913 (*a*) face: liste lexicale Proto-Izi, (*b*) revers: liste métrologique C.

Ist Ni 3913, revers

col. i'	col. ii'	col. iii'
[1 $\frac{1}{3}$ sila ₃]	[5 (ban ₂)]	4 (bariga) 5 (ban ₂)
[1 $\frac{1}{2}$ sila ₃]	[5 (ban ₂) 5 sila ₃]	1 gur
[1 $\frac{2}{3}$ sila ₃]	[1 (barig)]	1 (gur) 1 (bariga) gur
[1 $\frac{5}{6}$ sila ₃]	1 (barig) [1 (ban ₂)]	1 (gur) 2 (bariga) gur
[2 sila ₃]	1 (barig) [2 (ban ₂)]	1 (gur) 3 (bariga) gur
[3 sila ₃]	1 (barig) [3 (ban ₂)]	1 (gur) 4 (bariga) gur
4 [sila ₃]	1 (barig) [4 (ban ₂)]	2 gur
5 [sila ₃]	1 (barig) [5 (ban ₂)]	3 gur
6 [sila ₃]	2 (barig)	4 gur
7 [sila ₃]	2 (barig) 1 (ban ₂)	5 gur
8 [sila ₃]	2 (barig) 2 (ban ₂)	6 gur
9 [sila ₃]	2 (barig) 3 (ban ₂)	7 gur
1 (ban ₂) [še]	2 (barig) 4 (ban ₂)	8 gur
1 (ban ₂) 1 [sila ₃]	2 (barig) 5 (ban ₂)	9 gur
1 (ban ₂) 2 [sila ₃]	3 (barig)	10 gur
1 (ban ₂) 3 [sila ₃]	3 (barig) 1 (ban ₂)	11 gur
1 (ban ₂) 4 [sila ₃]	3 (barig) 2 (ban ₂)	12 gur
1 (ban ₂) 5 [sila ₃]	3 (barig) 3 (ban ₂) 0	[13 gur]
[1 (ban ₂) 6 sila ₃]	3 (barig) 4 (ban ₂)	[14 gur]
[1 (ban ₂) 7 sila ₃]	3 (barig) 5 (ban ₂)	[15 gur]
[1 (ban ₂) 8 sila ₃]	[4 (barig)]	[16 gur]
[1 (ban ₂) 9 sila ₃]	[4 (barig) 1 (ban ₂)]	[17 gur]
[2 (ban ₂)]	[4 (barig) 2 (ban ₂)]	[18 gur]
[3 (ban ₂)]	[4 (barig) 3 (ban ₂)]	[19 gur]
[4 (ban ₂)]	[4 (barig) 4 (ban ₂)]	[20 gur]

Les entrées des **tables métrologiques** sont exactement les mêmes que celles des listes, dans le même ordre. Mais, pour chaque mesure, un nombre sexagésimal positionnel est écrit en vis-à-vis. On y trouve donc, comme dans les listes, un exposé complet des systèmes métrologiques et numériques, mais aussi, ce qui est nouveau par rapport aux listes, un exposé de la numération sexagésimale positionnelle caractéristique des textes mathématiques. Je donne ci-dessous, à titre d'exemple, la translittération d'une petite tablette rectangulaire (de type III), publiée par H. Hilprecht¹³ et conservée à l'Université de Jena, contenant un extrait de la table métrologique des longueurs.

¹³ Hilprecht, *Mathematical, Metrological and Chronological Tablets*, No. 42 (HS 241).

HS 241

face	revers
1 šu-[si 10]	1 $\frac{1}{3}$ kuš ₃ 6.40
2 šu-si 20	1 $\frac{1}{2}$ kuš ₃ 7.30
3 šu-si 30	1 $\frac{2}{3}$ kuš ₃ 8.20
4 šu-si 40	2 kuš ₃ 10
5 šu-si 50	
6 šu-si 1	
7 šu-si 1.10	
8 šu-si 1.20	
9 šu-si 1.30	
$\frac{1}{3}$ kuš ₃ 1.40	
$[\frac{1}{2}]$ kuš ₃ 2.30	
$[\frac{2}{3}]$ kuš ₃ 3.20	
[1] kuš ₃ 5	

Les tables métrologiques sont donc des tables de conversion des mesures de capacité, poids, etc., en nombres sexagésimaux positionnels. À quelle règle obéit cette correspondance? Considérons par exemple la longueur de 1 ninda (6 m environ), une grandeur d'usage courant chez les scribes (la "canne" d'arpenteur standard mesure $\frac{1}{2}$ ninda). Dans les tables, cette mesure correspond au nombre 1:

1 ninda 1

Les autres valeurs numériques pour les longueurs s'en déduisent:

2 ninda 2

3 ninda 3

etc.

L'unité UŠ est égale à 60 ninda, donc la valeur numérique correspondante est soixante fois celle du ninda. On lit dans les tables:

1 UŠ 1

2 UŠ 2

etc.

Il apparaît ici une propriété fondamentale de la numération positionnelle mésopotamienne: l'écriture ne distingue pas 1 de 60, qui s'écrivent l'un et l'autre avec un clou vertical. De même, l'écriture ne distingue pas 2 et 2×60 , $2 \times \frac{1}{60}$, etc. Autrement dit, les nombres écrits sont définis à un facteur 60^n près (n entier positif ou négatif). Ces nombres sexagésimaux positionnels sans ordre de grandeur spécifié ont été qualifiés par F. Thureau-Dangin de "nombres abstraits."¹⁴ L'expression de Thureau-Dangin, qui sera retenue ici, rend bien compte de la nature particulière de ces

¹⁴ François Thureau-Dangin, "Nombres concrets et nombres abstraits dans la numération babylonienne," *Review d'Assyriologie* 29 (1932): 116–19.

nombre qui ne sont jamais suivis d'une unité de mesure et ne sont utilisés que pour les calculs.¹⁵ Les nombres abstraits énumérés dans les tables, dans la mesure où ils ne se distinguent pas à un facteur 60 près, forment des séquences cycliques (voir, par exemple, le nombre 10 qui apparaît au début et à la fin de la tablette HS 241). Il est donc nécessaire, pour utiliser ces tables en lecture inverse, d'être conscient de l'ordre de grandeur des quantités concernées.

La table des surfaces se déduit de celle des longueurs. En effet, le sar, unité de surface, est un carré de côté 1 ninda. Le ninda correspond au nombre 1, donc le sar correspond à 1×1 , c'est-à-dire à 1. Et le reste de la table des surfaces s'en déduit. Il en est de même pour les autres tables: l'ensemble forme un système cohérent.

On a vu que les tables métrologiques, tout comme les listes, étaient composées de quatre sections: capacités, poids, surfaces, longueurs. Une grandeur est absente de cette liste, alors qu'elle joue un rôle important dans les textes mathématiques: les volumes. Pourquoi n'existe-t-il pas de table des volumes? Pour répondre à cette question, un détour vers une curieuse variante dans les tables de longueur est nécessaire. La tablette HS 243, comme la précédente publiée par Hilprecht et conservée à Jena, est une autre table de longueur d'aspect tout à fait similaire.

HS 243

face		revers	
1 šu-si	2	2 kuš ₃	2
2 šu-si	4	3 kuš ₃	3
3 šu-si	[6]	4 kuš ₃	4
4 šu-si	[8]	5 kuš ₃	5
5 šu-si	[10]	$[\frac{1}{2}]$ [ninda]	6
6 šu-si	[12]	$[\frac{1}{2}]$ [ninda 1 kuš ₃]	7
7 šu-si	[14]	$\frac{1}{2}$ [ninda 2 kuš ₃	8]
8 šu-si	16	$\frac{1}{2}$ [ninda 3 kuš ₃	9]
9 šu-si	18	$[\frac{1}{2}]$ ninda 4 kuš ₃	10]
$\frac{1}{3}$ kuš ₃	20	$[\frac{1}{2}]$ ninda 5 kuš ₃	11]
$\frac{1}{2}$ kuš ₃	30	[1 ninda	12]
$\frac{2}{3}$ kuš ₃	40		
$\frac{5}{6}$ kuš ₃	50		
1 kuš ₃	1		

Mais on constate une différence de contenu entre la tablette HS 243 et la précédente. HS 243 débute avec la correspondance

$$1 \text{ šu-si} \rightarrow 2 \text{ (par suite } 1 \text{ kuš}_3 \rightarrow 1, 1 \text{ ninda} \rightarrow 12, \text{ etc.)},$$

tandis que les autres tables de longueurs, comme celle de HS 241 citée précédemment, débutent avec la correspondance standard

$$1 \text{ šu-si} \rightarrow 10 \text{ (par suite } 1 \text{ kuš}_3 \rightarrow 5, 1 \text{ ninda} \rightarrow 1, \text{ etc.)}.$$

¹⁵ Par opposition, les nombres suivis d'unités de mesure, tels qu'ils figurent dans les listes métrologiques, sont qualifiés de "nombres concrets" par F. Thureau-Dangin. Il m'a semblé préférable d'utiliser pour ces derniers l'expression "nombres mesurés," plus courante dans les

articles concernant les mathématiques anciennes. Ces questions de terminologie renvoient à des problèmes plus profonds concernant la conception des nombres dans les mathématiques cunéiformes. Voir à ce sujet Proust, "Tablettes mathématiques de Nippur."

Pourquoi trouve-t-on à Nippur, mais aussi ailleurs, deux tables différentes pour les longueurs? Comme l'a montré J. Friberg,¹⁶ la réponse est donnée explicitement par les scribes eux-mêmes dans deux textes scolaires d'Ur, UET 7 114 et UET 7 115, qui contiennent des tables métrologiques. À la suite de la table des longueurs standard (identique à HS 241), on lit la précision suivante: "pour les longueurs et largeurs"; à la suite de la table des longueurs basée sur l'autre correspondance (identique à HS 243), on lit: "pour les hauteurs et profondeurs."¹⁷ Les dimensions horizontales et verticales sont donc traitées différemment. Ce phénomène est à mettre en relation avec la définition des unités de volume dans les mathématiques cunéiformes: une unité de volume est une unité de surface affectée d'une épaisseur constante, 1 kuš₃ (50 cm).¹⁸ En conséquence, les rapports entre les unités de volume sont identiques à ceux qui existent entre les unités de surface, et chaque unité de volume porte le même nom que l'unité de surface qui lui sert de base: le "diagramme fléché" des volumes est le même que celui des surfaces:

Volumes (1 sar ≈ 18 m³)

$$\text{GAN}_2 \leftarrow 100- \text{ sar} \leftarrow 60- \text{ gin}_2 \leftarrow 180- \text{ še}$$

Cette définition explique l'absence de table métrologique pour les volumes: si, dans le calcul des volumes, les dimensions verticales (hauteurs, épaisseurs, profondeurs) sont converties au moyen de tables spéciales, où 1 kuš₃ correspond à 1 (comme dans HS 243), alors **les tables de surfaces sont aussi des tables de volumes**.¹⁹

Tout comme dans le cas des listes (tableau 1), un ensemble de "diagrammes fléchés" peut représenter de façon plus synthétique le système décrit en extension par les tables métrologiques (tableau 2 ci-dessous).

Tableau 2. Représentation synthétique des tables métrologiques.

Capacités									
gur	←5-	barig	←6-	ban ₂	←10-	sila ₃	←60-	gin ₂	
5		1		10		1		1	
Poids									
gu ₂	←60-	ma-na	←60-	gin ₂	←180-	še			
1		1		1		20			
Surfaces et volumes ²⁰									
GAN ₂	←100-	sar	[←60-	gin ₂	←180-	še]			
1.40		1		1		20			
Longueurs									
danna	←30-	UŠ	←60-	ninda	←12-	kuš ₃	←30-	šu-si	
30		1		1		5		10	
Hauteurs									
danna	←30-	UŠ	←60-	ninda	←12-	kuš ₃	←30-	šu-si	
6		12		12		1		2	

¹⁶ Jöran Friberg, "Mathematics at Ur in the Old Babylonian Period," *Revue d'Assyriologie* 94 (2000): 98–188, pp. 154–56.

¹⁷ Sur le revers de UET 7 114, la table métrologique des longueurs se termine par: [nam-uš] dagal-la-še₃; sur le revers de UET 7 115, la table métrologique des longueurs se termine par: nam-[uš] [dagal-la-še₃] et la table métrologique des hauteurs se termine par: nam-sukud-bur₃-še₃ (Friberg, "Mathematics at Ur").

¹⁸ François Thureau-Dangin a identifié cette conception des volumes dès 1900 dans "GAN, SAR et TU mesures de volume," *Zeitschrift für Assyriologie* 15 (1900): 112–14, puis il l'a développée dans *Textes*

mathématiques babyloniens, Ex Oriente Lux (Leyde: Brill, 1938): "Les mesures de surface servaient de mesures de volume, grâce à l'adjonction tacite d'une troisième dimension constante, égale à la coudée: le sar, par exemple, équivaut, comme mesure de volume, à $\frac{1}{12}$ de NINDA cube" (p. xiv).

¹⁹ Cette idée a été émise pour la première fois par J. Friberg, "Mathematik," *Reallexikon der Assyriologie* 7 (Berlin: Walter de Gruyter, 1987–90), pp. 531–85, p. 543, et je l'ai longuement développée dans "Tablettes mathématiques de Nippur," où elle est élargie au cas des volumes exprimés en nombre de briques.

En résumé, les tables métrologiques apportent bien plus qu'un simple exposé des systèmes métrologiques et numériques; ce sont des textes structurés dont l'architecture reflète une véritable théorie savante des surfaces et des volumes. "Elémentaires" du point de vue du niveau scolaire où elles sont enseignées, les tables métrologiques ne le sont pas du point de vue conceptuel.

2. DIFFÉRENCE DE FORME OU DE FOND?

Les données des tables métrologiques incluent celles des listes métrologiques. Comment dès lors comprendre la présence, en quantité à peu près équivalente, des listes et des tables métrologiques dans le corpus de Nippur? Il n'a pas été apporté à cette question de réponse assurée, mais quelques hypothèses ont été émises.

On peut se demander s'il y a eu une évolution entre le début et la fin de l'époque paléo-babylonienne dans les conceptions de la métrologie ou dans les méthodes d'enseignement, se traduisant par un passage des listes aux tables. Les tablettes scolaires de Nippur forment des lots d'époques différentes, couvrant une période allant des dynasties d'Isin-Larsa jusqu'au règne de Samsu-Iluna. Il n'est malheureusement pas possible de déterminer la datation exacte de l'immense majorité des tablettes scolaires de Nippur: elles ont été exhumées à la fin du XIX^e siècle par la Babylonian Expedition,²¹ qui n'accordait que peu d'attention au contexte archéologique. Cependant, le lot des tablettes de la "Maison F" de Nippur, exhumé plus tard par la *Joint Expedition*, est bien renseigné sur le plan archéologique: il est chronologiquement homogène (début du règne de Samsu-Iluna).²² Or, ce petit lot contient autant de listes que de tables.²³ Cet échantillon montre qu'une évolution chronologique n'est pas une explication satisfaisante.

On peut évoquer, comme le fait E. Robson, des variantes de style:

Extracts from the series could be written in the form of lists — with each entry containing the standard notation for the measure only — or as tables — where the standard writings were supplemented with their sexagesimal equivalents; but it is not yet clear whether these two formats were the didactic equivalent of the "terse" and "verbose" multiplication format (E. Robson, "Mathematical Cuneiform Tablets," p. 12).

Une autre hypothèse, qui, comme les précédentes, réduirait l'opposition entre listes et tables à une différence de forme, a été proposée par N. Veldhuis dans la discussion qui a suivi la présente communication. Les listes lexicales paléo-babyloniennes de Nippur sont presque toutes monolingues, c'est-à-dire que les lemmes sumériens ne sont généralement pas accompagnés des traductions akkadiennes, comme ils le seront par la suite dans les listes apparentées du premier millénaire. Il est probable que si ces listes sont monolingues à l'écrit, elles devaient être bilingues dans leur forme orale.

One cannot, however, conclude that there were two successive steps in the learning process, one devoted to learning the signs and their Sumerian pronunciation, and the second to learning the Akkadian meanings. It is likely, although it cannot be proven by textual evidence, that the Akkadian meanings were learned from the very beginning, but since they did not offer any difficulty to the apprentice scribes, whose native language in the XVIIIth century B.C. ... was certainly Akkadian, they were not usually written down (Civil, MSL 14, p. 85).

Dans le cas de certaines listes de signes, la version sans traduction akkadienne et la version bilingue co-existent à Nippur à l'époque paléo-babylonienne, les premières étant beaucoup plus courantes que les secondes. C'est le cas notamment des listes Proto-Ea et Proto-Aa; voir aussi l'exemple de la séquence de liste Proto-Izi dans la tablette Ist Ni 3913 (copie § 1 et translittération § 5).

²⁰ La séquence des gin₂ et des še de la table des poids peut également servir pour les surfaces (et les volumes), puisque les conversions en nombre abstrait sont les mêmes. Voir la mise en œuvre de ce procédé plus loin, dans l'analyse des exercices de calcul de surface (Ni 18 et CBS 11318).

²¹ Campagnes de fouilles à Nippur dirigées par l'Université de Pennsylvania (1888–1900).

²² Robson, "The Tablet House," p. 40.

²³ Robson, "More than Metrology," p. 336: sur les 6 textes métrologiques identifiants, 3 sont des listes et 3 sont des tables.

Il existe ... à Nippur une version de Proto-Ea où chaque lemme est enrichi d'une ou plusieurs traductions akkadiennes ... (à la fois syllabaire et vocabulaire). ... comme Civil le suggère [Civil, MSL 14, p. 85], il est raisonnable de penser que l'enseignement des traductions akkadiennes allait de pair, dès les premiers stades de la formation, avec celui de la lecture des logogrammes; la traduction devait surtout se faire oralement (Cavigneaux, "Lexikalische Listen," p. 620).

Par analogie, on peut se demander si les tables métrologiques ne sont pas l'équivalent de ce que sont les "versions bilingues" pour les listes lexicales. Les listes métrologiques ne seraient que la trace écrite incomplète des tables métrologiques, les correspondances numériques étant restituées à l'oral. Dans cette dernière hypothèse, les apprentis scribes pouvaient étudier indifféremment les listes ou les tables, les connaissances transmises par ces deux catégories de textes étant au fond les mêmes, comme dans le cas peut-être des listes lexicales Proto-Ea et Proto-Aa. Les listes et les tables représenteraient le même texte, qui aurait fait l'objet d'exercices scolaires de genres différents: la table serait un simple exercice de mémoire, et la liste serait une sorte "d'exercice à trou."

Envisageons une autre hypothèse: les listes et les tables ne seraient-elles pas fondamentalement différentes, destinées à des publics d'étudiants spécifiques, et ne répondraient-elles pas à des objectifs de formation distincts? Une réponse affirmative à cette question suggérerait l'existence d'une spécialisation de l'enseignement à Nippur.

3. ANALYSE STATISTIQUE

L'abondante documentation de Nippur permet une approche statistique du problème. Cette méthode a déjà donné d'importants résultats concernant l'ordre d'enseignement des différentes listes de niveau élémentaire.²⁴ Je me limiterai ici à l'ensemble des tablettes mathématiques scolaires qui ont été exhumées à Nippur par la Babylonian Expedition lors de ses quatre campagnes de fouilles, qui se sont déroulées de 1888 à 1900. D'abord parce que ces tablettes sont toutes accessibles, et qu'une base de donnée homogène et systématique a pu être constituée.²⁵ Ensuite parce que les sélections opérées sur cette collection sont principalement dues au hasard (maisons fouillées, accidents de voyage, de restauration, et de conservation). A peu près tout ce qui a été trouvé dans le quartier des scribes de Nippur à la fin du XIX^e siècle se trouve aujourd'hui réparti entre les musées de Philadelphie, Istanbul, et Jena. Il n'y a pas eu de choix opéré dans un but commercial, comme par exemple dans les collections privées. Cependant H. Hilprecht, le directeur scientifique de la Babylonian Expedition, avait ses préférences: cela se ressent dans la façon dont il a influencé le partage des tablettes entre la Turquie et les Etats-Unis, et surtout dans la constitution de sa collection personnelle, conservée aujourd'hui à Jena. Ainsi, les lots de Philadelphie, Istanbul, et Jena, pris séparément, n'ont pas tout à fait la même composition. Mais ces trois lots réunis peuvent être considérés comme représentatifs de ce qui a été effectivement découvert par la Babylonian Expedition. Peut-on pour autant dire qu'il s'agit d'un échantillon significatif en regard de ce qui a été réellement produit dans les écoles de scribes de Nippur au début du deuxième millénaire? Il est difficile de répondre à ce type de question, et plus encore dans le cas qui nous intéresse ici, dans la mesure où on ne dispose que de très peu d'éléments d'information sur le contexte archéologique. On sait cependant que les tablettes scolaires ordinaires étaient destinées à la destruction ou au recyclage, et que la majorité d'entre elles ont été retrouvées incorporées à du matériau de construction. On peut penser que les scribes n'avaient pas de raison de les trier avant de les jeter, et qu'il nous est parvenu un échantillon de "brouillons d'argile" pris au hasard. Mais ces tablettes à jeter ne sont qu'une partie de ce que produisaient les écoles, et d'autres types de textes plus élaborés ont dû emprunter un autre chemin, plus difficile à suivre. En conclusion, on peut considérer que les statistiques ne sont pas dépourvues de signification, concernant tout au moins le lot de Nippur exhumé par la Babylonian Expedition, mais il est important d'en saisir les limites.

²⁴ Veldhuis, "Elementary Education"; Robson, "The Tablet House"; Proust, "Tablettes mathématiques de Nippur."

²⁵ Proust, "Tablettes mathématiques de Nippur." J'ai eu en main et étudié les tablettes d'Istanbul, avec l'aide bienveillante du conservateur V. Donbaz, ainsi que les tablettes de Jena, en collaboration avec M. Krebernik (Manfred Krebernik et Christine Proust, *Tablettes*

mathématiques de la collection Hilprecht, Texte und Materialien der Frau Professor Hilprecht Collection 8 (à paraître). Les données concernant les tablettes de Philadelphie m'ont été communiquées avec une grande générosité par E. Robson. Je remercie chaleureusement ces chercheurs dont l'aide m'a été si précieuse.

DONNÉES STATISTIQUES GÉNÉRALES

L'ensemble des tablettes scolaires exhumées à Nippur par la Babylonian Expedition contient 880 tablettes mathématiques. Donnons quelques précisions sur la répartition de ces tablettes selon le lieu de conservation, le contenu, le type de tablette.

Tableau 3: collections de tablettes mathématiques de Nippur exhumées par la Babylonian Expedition.

Lieu de conservation	
Philadelphie	486
Istanbul	315
Jena	79
Total	880

Tableau 4: contenu des tablettes mathématiques de Nippur exhumées par la Babylonian Expedition.

Contenu	
listes métrologiques	192
tables métrologiques	173 (dont 10 couplées avec des tables numériques)
tables numériques	425
exercices et problèmes	38
incertain	52 (dont 45 sont des tables ou listes métrologiques)
Total	880

Ce tableau montre la place occupée par les textes métrologiques, comme cela a été évoqué en introduction:

- Environ la moitié des textes mathématiques sont métrologiques.
- Les listes et les tables métrologiques sont en quantité à peu près équivalente dans l'ensemble des textes mathématiques.

Tableau 5: type des tablettes mathématiques exhumées par la Babylonian Expedition.

Type de tablettes	
I	63
II	382
III	143
IV	32
autre	9
indéterminé	251
Total	880

Les tablettes de type II représentent à elles seules plus de 60% des tablettes mathématiques élémentaires de type identifié (382 sur 620): elles sont très largement dominantes à Nippur. Elles ont une grande importance pour comprendre l'organisation du cursus, comme l'a montré N. Veldhuis.²⁶ Comme elles contiennent des associations de textes de catégories différentes, elles sont particulièrement intéressantes pour éclairer le problème de l'articulation entre l'écriture et le calcul dans l'enseignement. Examinons donc la répartition des tablettes de type II selon leur contenu.

TABLETTES DE TYPE II

Les listes et les tables métrologiques sont associées, dans les tablettes de type II, à presque toutes les catégories de textes lexicaux. Ainsi, dans le lot exhumé par la Babylonian Expedition, les textes métrologiques²⁷ sont couplés avec les textes suivants (effectif précisé entre parenthèses):

“Silbenalphabet B” (1)

Noms propres et noms de dieux (4)

Listes thématiques (9), dont²⁸: giš (1), gi (2), udu (1), na₄ (3), a-ša₃ (1), a/ninda (1)

Liste Ugumu (1)

Listes de signes (37), dont: Proto-Ea (10), Proto-Lu (6), Proto-Izi (10), Proto-Nigga (6), Proto-Kagal (5)

Modèles de contrats (12)

Proverbes (12)

Existe-t-il une différence entre les listes et les tables métrologiques dans leurs associations avec les textes lexicaux? Considérons la répartition des tablettes mathématiques de type II selon le contenu de la face et du revers. Cette distribution est donnée dans le tableau suivant (tableau 6): par exemple, il y a 7 tablettes contenant des listes métrologiques sur la face et des textes lexicaux sur le revers, et 49 tablettes contenant à l'inverse des textes lexicaux sur la face et des listes métrologiques sur le revers. Pour les tablettes contenant des textes lexicaux à la fois sur la face et sur le revers, se reporter à l'étude de N. Veldhuis.²⁹

Tableau 6: tablettes de type II de Nippur contenant des textes mathématiques.

face → revers ↓	lexical, contrats, proverbes	liste métrologique	table métrologique	table numérique
lexical, contrats, proverbes		7	4	7
liste métrologique	49	8	0	0
table métrologique	15	0	15	4
table numérique	29	0	2	62

²⁶ Veldhuis, “Elementary Education.”

²⁷ Je n'ai relevé ici que les associations impliquant des textes métrologiques. Si on prend également en considération les tables numériques, il faut ajouter les listes Diri (1 cas) et ki-ulutin (2 cas).

²⁸ Les six listes thématiques de Nippur, précurseurs paléo-babyloniens des listes Hh., sont ici désignées par leur *incipit*: 1) giš = Hh. III-

VII = objets en bois; 2) gi = Hh. VIII-XII = objets en roseau, cuir, etc.; 3) udu = Hh. XIII-XV = animaux; 4) na₄ = Hh. XVI-XIX = pierres, plantes, etc.; 5) a-ša₃ = Hh. XX-XXII = terre et ciel; 6) a/ninda = Hh. XXIII-XXIV = nourriture et boissons.

²⁹ Veldhuis, “Elementary Education.”

On remarque immédiatement que la répartition est très contrastée:

- les listes métrologiques ne sont **jamais** couplées avec des tables métrologiques ou numériques;
- les listes métrologiques sont le plus souvent couplées avec des listes lexicales (88%);
- les tables métrologiques sont minoritairement couplées avec des listes lexicales (48%);
- les tables numériques sont peu souvent couplées avec des listes lexicales (35%).

On a vu que l'activité scolaire la plus banale au sein des écoles de Nippur consiste à copier un modèle de texte sur une tablette, puis à réviser un texte déjà connu sur l'autre face de la même tablette. Dans cette activité, les listes métrologiques sont très souvent étudiées parallèlement à des listes lexicales. Mais il n'y a aucune trace de tablette où un étudiant aurait étudié une liste métrologique en parallèle avec une table métrologique ou numérique. Les listes métrologiques sont fortement intégrées au cursus lexical, tandis que les tables métrologiques sont fortement intégrées au cursus mathématique.

4. A QUOI SERVENT LES TABLES MÉTROLOGIQUES?

Une autre approche de l'analyse comparée des listes et des tables métrologiques consiste à essayer de cerner leur fonction pédagogique. On a vu que l'ensemble des listes constituait un exposé structuré de la métrologie normalisée, aussi bien de son écriture que de son fonctionnement. Les tables ont une autre dimension: elles contiennent les mêmes informations que les listes, mais intégrées dans une relation de correspondance entre mesures et nombres abstraits. Le mode d'emploi de ces tables peut être reconstitué par l'observation d'exercices mathématiques des écoles de Nippur.

Une série de six petits exercices trouvés à Nippur montre comment le calcul des surfaces est enseigné. Ces tablettes, dites de type IV, ont la forme carrée typique des exercices de niveau avancé de Nippur. Considérons par exemple la tablette CBS 11318, publiée par O. Neugebauer et A. Sachs.³⁰ Elle est divisée en deux zones séparées par un espace vide. En bas à droite, on trouve un petit exercice sur le calcul de la surface d'un carré. Les données (côté du carré, 1 kuš₃) ainsi que la réponse (surface du carré, $\frac{1}{3}$ gin₂ 15 še) sont exprimés au moyen des nombres mesurés, telles qu'ils apparaissent dans les listes métrologiques. Dans l'autre zone, en haut à gauche, on trouve les nombres abstraits correspondants.

CBS 11318 [Neugebauer & Sachs, MMT]

<p>1'5 1'5 25</p> <div style="border: 1px solid black; padding: 5px; margin-left: auto; margin-right: auto; width: 80%;"> <p>1 kuš₃ ib₂-si₈ ----- a-ša₃-bi en-nam ----- a-ša₃-bi $\frac{1}{3}$ gin₂ 15 še =====</p> </div>	<p>5 5 25</p> <div style="border: 1px solid black; padding: 5px; margin-left: auto; margin-right: auto; width: 80%;"> <p>1 kuš₃ le côté (du carré) ----- Quelle est sa surface? ----- Sa surface est $\frac{1}{3}$ gin₂ 15 še =====</p> </div>
---	---

³⁰ Otto Neugebauer et Abraham J. Sachs, "Mathematical and Metrological Texts," *Journal of Cuneiform Studies* 36 (1984): 243–51, copie p. 251; on trouve dans la même publication quatre autres tablettes de Nippur du même type: CBS 11318, UM 29-15-192, 2N-T

472 = UM 55-21-076, 2N-T 116 = IM 57846, 2N-T 30 = IM 57828. Un sixième exemplaire, Ni 18, est publié dans Proust, "Tablettes mathématiques de Nippur."

Le côté du carré est 1 kuš₃. Or, si on consulte la table métrologique des longueurs, on lit:

$$1 \text{ kuš}_3 \quad 5$$

Le petit calcul placé en haut à gauche donne précisément le carré de 5 (la présence des dizaines sur la copie est probablement une erreur³¹):

$$5 \times 5 = 25$$

Les dimensions du carré sont de l'ordre de grandeur de celles d'une brique, ce qui correspond à une surface de quelques še ou une fraction de gin₂. Or, dans cette zone de la table métrologique des surfaces, on lit:

$$\frac{1}{3} \text{ gin}_2 \quad 20$$

Et, un peu plus haut:

$$15 \text{ še} \quad 5$$

Donc, au nombre 25 et pour l'ordre de grandeur d'une brique, correspond la surface: $\frac{1}{3}$ gin₂ 15 še. C'est précisément cette réponse qui est donnée dans la dernière ligne du texte.

Cet exercice, et tous ceux de ce genre, montre bien comment les tables métrologiques assurent le va-et-vient entre les nombres mesurés (qui permettent d'exprimer les grandeurs métrologiques), et les nombres abstraits (qui permettent d'effectuer les calculs).

Les listes métrologiques donnent les connaissances nécessaires (et probablement suffisantes) aux scribes pour les préparer aux opérations ordinaires de la comptabilité et de la gestion. Les tables métrologiques sont des **outils de calcul** pour les surfaces et les volumes; leur mémorisation et l'apprentissage de leur utilisation préparent les scribes à résoudre des problèmes mathématiques.

5. TEXTES COMPLETS, TEXTES LACUNAIRES

Revenons à la question posée en introduction. Les listes métrologiques sont-elles une trace écrite lacunaire d'un texte plus complet, et qui aurait pu comporter dans sa forme orale les conversions des nombres mesurés en nombres abstraits? Examinons tout d'abord deux cas de textes lacunaires qui, bien qu'ils appartiennent au domaine lexical, concernent le vocabulaire mathématique et les nombres.

Un premier exemple, Ist Ni 3913, dont la face a été commentée au début de cet article, et un extrait de liste Proto-Izi. On y lit le signe ŠID répété plusieurs fois. Il s'agit du "squelette" monolingue d'un texte plus complet, lui aussi attesté à Nippur. Cet extrait montre que des lemmes identiques à l'écrit représentent des énoncés différents.

³¹ Parmi les six exemplaires connus de ce type d'exercices, j'ai choisi le plus simple, malgré la présence d'une erreur qui peut troubler le lecteur. Cependant, la confrontation des six exemplaires ne laisse

aucun doute sur la restitution du texte proposée par Neugebauer et reproduite ici.

Ist Ni 3913		liste Proto-Izi I ³²	
face			
1'	šID	254.	šID ^{ma-nu-u₂-um}
2'	šID	255.	šID ^{[m]a-ru um-mi-a-ni}
3'	šID	256.	šID ^{ra-ka-bu}
4'	šID	257.	šID ^{qa₂-ra-du}
5'	šID	258.	šID ^{li-i^{su}šum}
6'	šID	258a.	šID ^{d^{EN}.LIL₂}
7'	sig ₄	259.	še-egšeg ₁₂ (sig ₄)
8'	sig ₄ -al-ur ₃ -ra	260.	sig ₄ -al-ur ₃ -ra
9'	sig ₄ -sig ₄	264.	SIG ₄ .IDIM ^{te-rum}
10'	SIG ₄ .IDIM		

Un autre cas, d'une nature un peu différente, est particulièrement intéressant. Il s'agit de la version sumérienne et de la version akkadienne d'une même liste de nombres, qui apparaît dans la tablette CBS 11319+, une liste lexicale atypique publiée par Sjöberg.³³ La première section de cette liste contient l'exposé du "système S," la principale numération utilisée en métrologie et dans les dénombrements.³⁴ Je donne ici une translittération et une copie personnelles du début de la face, d'après la photo publiée par Sjöberg; elles diffèrent légèrement de celle de Sjöberg dans l'identification de la séquence 5 (geš'u) / 1(šar₂) / 1(šar₂) gal.

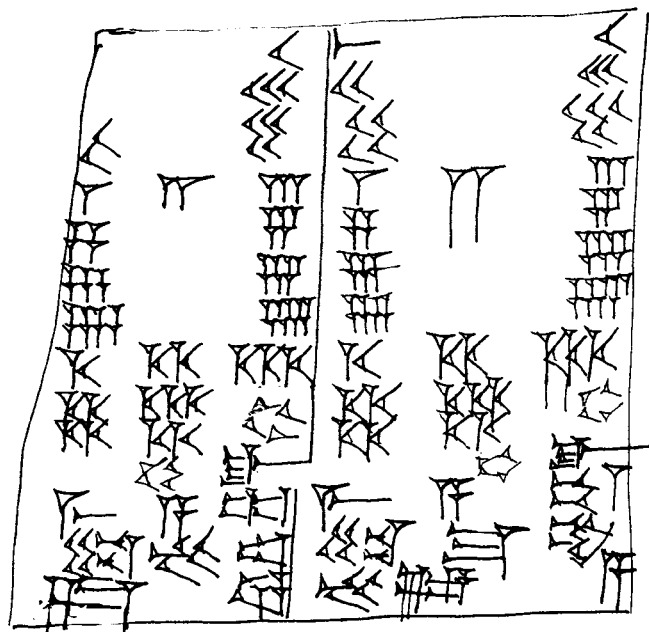

Figure 2. CBS 11319+, première section (copie).

³² Miguel Civil et Erica Reiner, *Izi = išātu, Ka₂-gal = abullu and Nig₂-ga = makkūru*, Materials for the Sumerian Lexicon 13 (Rome: Pontificium Institutum Biblicum, 1971), p. 25. Les versions bilingues de cette liste sont rare à Nippur (aucune tablette attestée pour Proto-Izi I et seulement deux fragments pour Proto-Izi II); les gloses akkadiennes de cette reconstitution proviennent de versions tardives.

³³ Åke W. Sjöberg, "CBS 11319+: An Old-Babylonian Schooltext from Nippur," *Zeitschrift für Assyriologie* 83 (1993): 1–21.

³⁴ Voir § 1 pour la mesure des poids en gu₂ et des capacités en gur. Dans les dénombrements, on trouve généralement une variante légèrement différente du système S, où les unités sont des clous verticaux et non horizontaux. Voir par exemple, dans la Liste Royale Sumérienne, l'expression des durées de règne.

CBS 11319+, première section						
[...]	[1(aš)]	10		1 (aš)		10
[...]	[20]	30		20		30
[...]	[4]0	50		40		50
[...]	1(geš ₂)	2(geš ₂)	3(geš ₂)	1(geš ₂)	2(geš ₂)	3(geš ₂)
[...]	4(geš ₂)		5(geš ₂)	4(geš ₂)		5(geš ₂)
[...]	6(geš ₂)		7(geš ₂)	6(geš ₂)		7(geš ₂)
[...]	8(geš ₂)		9(geš ₂)	8(geš ₂)		9(geš ₂)
[...]	1(geš'u)	2(geš'u)	3(geš'u)	1(geš'u)	2(geš'u)	3(geš'u)
[...]	4(geš'u)	5(geš'u)	1(geš ₂)	4(geš'u)	5(geš'u)	1(geš ₂)
[...]		1 (šar ₂) gal			1 (šar ₂) gal	
[...]	me-a-at			me-a-ta		
[...]	li-mu-um			li-ma-am		
[...]	LIL ₂ -e			mu-un-a		

La tablette se présente en trois colonnes: la première (malheureusement cassée pour cette section) donne la prononciation sumérienne, la deuxième donne le texte en sumérien, la troisième donne le texte en akkadien. On voit que pour ce qui concerne l'écriture des nombres, les textes sumérien et akkadien sont identiques.

Que se passerait-il si les listes métrologiques étaient des tables incomplètes? Pourrait-il arriver que, comme dans les cas précédents, des segments du texte plein aient été omis à l'écrit? On a vu que la série des tables métrologiques se terminait par deux tables pour les dimensions linéaires: une table des longueurs et une table des hauteurs. Les entrées sont les mêmes, mais les conversions en nombres abstraits sont différentes. Si les listes étaient des tables incomplètes, la série des listes devrait avoir la même structure: on devrait trouver systématiquement deux listes des longueurs à la fin de la série des listes métrologiques. Il y a cinq tables métrologiques, donc il devrait y avoir cinq listes métrologiques. Or les tablettes de Nippur de type I qui contiennent la série complète des listes métrologiques (CBS 10990+, N 3893, UM 29-15-048 par exemple)³⁵ ne comptent que quatre listes, et c'est le cas également dans les textes provenant d'autres sites. Cependant la collection de Jena contient une exception troublante: la tablette HS 249+³⁶ contient cinq listes métrologiques: capacités, poids, surfaces, longueurs répétées deux fois. S'agit-il dans ce cas de listes qui représentent en fait des tables? C'est possible, mais d'autres explications peuvent être envisagées: le scribe s'est peut-être livré à une banale entreprise de remplissage de sa tablette; ou bien ces répétitions d'écriture sont de nature didactique.

Résumons l'argument: les séries de tables métrologiques rassemblées dans les grandes tablettes récapitulatives contiennent deux tables des longueurs (horizontales et verticales), les séries de listes métrologiques ne contiennent qu'une liste des longueurs (exception faite de HS 249). Donc les listes et les tables ne représentent pas le même texte plein. Ajoutons que les textes métrologiques se distinguent des textes lexicaux sur un autre point: dans le cas des listes lexicales, les traductions en akkadien, c'est-à-dire dans la langue maternelle des scribes "ne présentaient pas de difficulté pour les apprentis" (Civil, MSL 14, p. 85); mais il n'en est pas de même pour les conversions en nombres abstraits, dont l'assimilation constitue une sérieuse difficulté.

³⁵ CBS 10990+: voir § 1, note 6. N 3893 et UM 29-15-048 seront publiées prochainement par E. Robson.

³⁶ Krebernik et Proust, *Tablettes mathématiques*, text No. 1. Cette liste présente d'autres singularités (répétitions d'items avec graphies

différentes) qui en font un témoin moins régulier que les autres tablettes de type I citées dans la note précédente.

6. CONCLUSION

Si on s'en tient à la forme du texte écrit, les listes et les tables métrologiques sont des objets textuels de nature différente: dans le premier cas, il s'agit d'une simple énumération linéaire, dans le deuxième cas, il s'agit d'une correspondance bidimensionnelle. Cependant, des énumérations écrites sous une forme linéaire peuvent n'être que la trace tronquée d'un texte plus informatif, comme cela semble se produire avec les listes lexicales: les listes monolingues sont probablement des squelettes de listes bilingues. Concernant les listes et les tables métrologiques, il semble se produire un phénomène d'une autre nature. On a vu que ces deux types de textes s'opposent de façon plus fondamentale:

- dans leur répartition statistique, notamment dans les tablettes de type II;
- dans leur organisation en séries (on trouve quatre listes et cinq tables dans les tablettes récapitulatives);
- probablement dans leur fonction pédagogique.

Les listes et les tables, qui coexistent à la même époque, en quantité comparable, ne semblent pas destinées aux mêmes étudiants. Le contenu des listes métrologiques est suffisant pour répondre à la plupart des besoins pratiques des scribes professionnels. Mais il y a plus: leur structure, leur contenu et leur répartition statistique les rapprochent des listes lexicales. Les listes métrologiques appartiendraient à un type de formation orienté vers la littérature. Les tables métrologiques sont des outils indispensables au calcul savant, on les trouve plus souvent couplées avec d'autres textes mathématiques qu'avec des textes lexicaux. Les tables métrologiques appartiendraient à un type de formation plus nettement orienté vers les mathématiques.

CLASSIFICATION DE L'UTILISATION DU CUNÉIFORME MÉSOPOTAMIEN DANS LES TEXTES OUGARITIQUES*

Carole Roche, CNRS, Lyon

Depuis le début des fouilles en 1929, le Tell de Ras Shamra (Ougarit) a livré plus de 4000 textes attestant de l'usage de huit langues et cinq systèmes d'écriture. C'est cet aspect de la documentation qui donne une particularité à ce corpus, mais en fait, toutes ces langues et écritures ne sont pas attestées dans les mêmes proportions. Les deux corpus principaux sont répartis à peu près à parts égales: les textes en cunéiforme mésopotamien d'une part et les textes en cunéiforme alphabétique de l'autre. À Ougarit, l'origine de l'écriture n'implique pas nécessairement quelle langue elle exprime. Ainsi, le cunéiforme mésopotamien était utilisé pour écrire des textes en langue akkadienne, sumérienne, hourrite, et très rarement hittite. Le cunéiforme ougaritique quant à lui servait à la notation de textes en ougaritique, hourrite, et, de façon exceptionnelle, akkadien. La présence de plusieurs systèmes d'écriture sur une même tablette est cependant inhabituelle. Certains textes économiques montrent de telles particularités et un "sabr graphique"¹: il s'agit essentiellement de textes ougaritiques alphabétiques présentant de brèves épigraphes en cunéiforme mésopotamien. Parmi près de 900 textes administratifs écrits en cunéiforme ougaritique, 117 contiennent du cunéiforme mésopotamien. Les signes mésopotamiens apparaissant dans ce contexte vont de quelques-uns épars jusqu'à la notation d'une phrase complète. Depuis 1986, la mission franco-syrienne de Ras Shamra a dégagé les ruines d'une maison au centre sud du tell, dite "Maison d'Urtēnu". Dans cette maison, les archéologues ont mis au jour davantage d'exemples d'écriture mixte que partout ailleurs sur le tell.

Répartition des épigraphes par lieu de trouvaille:

<i>Principaux lieux de trouvaille</i>	<i>Nombre de textes à épigraphe</i>	<i>Pourcentage sur total de textes</i>
Palais royal	53/546	9,7%
Palais sud	4 ² /19	21%
"Maison de Rap'ānu"	3/13	23%
"Maison d'Urtēnu"	29/80	36,2%

Ainsi le texte RS 94.2411 présente un recensement de foyers par ville. L'écriture est mélangée à un point tel que le scribe commence parfois une ligne en cunéiforme mésopotamien et l'achève en cunéiforme ougaritique.

La "Maison d'Urtēnu" a donc fourni proportionnellement deux fois plus d'épigraphes que partout ailleurs sur le tell. Une telle proportion force à s'interroger sur ces épigraphes. Laisant pour l'instant de côté la question de la raison même de la présence de ces épigraphes sur certains textes pour se concentrer sur l'écriture et la langue. Doit-on les considérer comme des "épigraphes akkadiennes"? Ou devrions-nous parfois, si ce n'est toujours, les considérer comme des exemples de phrases ou paragraphes en langue ougaritique écrits en cunéiforme mésopotamien au moyen de logogrammes et pourquoi pas d'akkadogrammes?

* Je remercie vivement Pierre Bordreuil et Dennis Pardee, ainsi que la mission de Ras Shamra pour m'avoir autorisée à utiliser et à citer les textes ougaritiques inédits. L'idée même de cet article est née d'une discussion avec Dennis Pardee. Toutes les nouvelles lectures des épigraphes des tablettes conservées aux musées de Damas et Alep ont été possibles grâce à une mission financée par le laboratoire

Archéorient (UMR 5133). Je tiens à remercier les conservateurs des musées de Damas, Muyassar Yabroudi, et d'Alep, Nasser Sharaf ainsi que Béatrice André-Salvini du Louvre et Norbeil Aouici.

¹ F. Malbran-Labat, "Langues et écritures à Ougarit," *Semitica* 49 (1999): 97.

Nous connaissons, bien entendu, des exemples de mots ougaritiques écrits en cunéiforme mésopotamien dans des textes akkadiens² comme par exemple dans le texte RS 19.024³ *qadarūma*, qui semble être un type de contenant, avec un forme plurielle en *-ūma*, indiquant une morphologie ougaritique.⁴

Il est cependant difficile de déterminer si un scribe lisait les logogrammes en langue ougaritique ou akkadienne, lorsqu'il n'y a aucune aide de lecture en syllabique. Il semble alors que le meilleur moyen d'évaluer de quelle façon les anciens ougaritains mélangeaient écritures ou langues à l'intérieur d'un même texte est de classifier les usages du cunéiforme mésopotamien dans les textes ougaritiques. Cette classification propose différents niveaux: des exemples où les logogrammes sont presque certainement à lire en ougaritique jusqu'aux exemples les plus incertains. J'ai déterminé deux critères essentiels pour ce classement: d'une part, la proportion dans l'utilisation des écritures dans un texte donné, et d'autre part la fonction, à l'intérieur du texte alphabétique, des mots ou phrases écrits en logogrammes.

CLASSIFICATION

Suivant ces deux critères, on peut répartir les "épigraphes suméro-akkadiennes" en sept groupes classés de A à G.

GROUPE A⁵

En ce qui concerne l'utilisation des logogrammes mésopotamiens de nombre. Est-il légitime de les considérer comme logogrammes? Les ougaritains les percevaient-ils vraiment comme appartenant au système d'écriture mésopotamien?

On trouve un élément de réponse dans la constance avec laquelle les scribes utilisent les akkadogrammes *me-at* et *li-im* pour exprimer les nombres 100 et 1000 dans le contexte d'un texte alphabétique où les chiffres sont écrits en logogrammes. Ces mots ne sont pas ougaritiques mais empruntés à l'akkadien. Il semble donc que les écritures DIŠ pour 1 et *me-at* pour 100, soient perçues comme faisant partie de la même tradition.

L'emploi des nombres et fractions mésopotamiens dans les textes alphabétiques constitue notre premier groupe, le groupe A, qui semble avoir été lu en ougaritique dans le cadre d'un texte en ougaritique. Le groupe se divise en trois sous-groupes: A1, les nombres (64 textes); A2, les fractions (six textes, dont quatre dans la maison d'Urtēnu) et A3, les chiffres des centaines et milliers écrits en syllabique, en akkadogrammes (trois textes).⁶ Pour les fractions, les scribes ougaritains utilisent habituellement les logogrammes mésopotamiens avec cohérence. Cependant, dans un texte comme RS 94.2472, le scribe écrit à plusieurs reprises la fraction $\frac{1}{2}$ avec le signe mésopotamien MAŠ mais il n'est apparemment pas assez à l'aise avec les fractions mésopotamiennes pour noter $\frac{1}{3}$ et écrit alors *mtlt* en alphabétique ougaritique. Il semble évident ici que le logogramme mésopotamien MAŠ à la ligne supérieure était lu en langue ougaritique dans ce contexte.

GROUPE B

Le groupe B est constitué de textes dans lesquels les deux écritures apparaissent dans une même ligne. La structure est la suivante: dans une liste de noms de professions, de lieux, ou de personnes, on trouve à la première ou à la dernière ligne la définition de l'objet comptabilisé, qu'il s'agisse de grain, d'homme, de farine, ou de moutons. Ce groupe se divise en trois sous-groupes: B1 avec une définition de l'objet comptabilisé en début de texte (trois textes); B2 en fin de texte (deux textes); et B3 en début avec un total à la fin du texte (un texte).

² John Huehnergard, *Ugaritic Vocabulary in Syllabic Transcription*, Harvard Semitic Studies (Atlanta: Scholars Press, 1987); Malbran-Labat, "Langues et écritures," pp. 65–101.

³ J. Nougayrol, *Le palais royal d'Ugarit 6: Textes en cunéiforme babylonien des archives du Grand Palais et du Palais Sud*, Mission de Ras Shamra 12 (Paris: Imprimerie Nationale & Klincksieck, 1970) (ici PRU 6), No. 158.

⁴ Huehnergard, *Ugaritic Vocabulary*, Malbran-Labat, "Langues et écritures," pp. 172–73.

⁵ Voir en annexe le tableau récapitulatif.

⁶ Ne sont mentionnés ici que les centaines et milliers mésopotamiens apparaissant hors des épigraphes, dans le corps de textes alphabétiques.

Dans le groupe B1, deux exemples doivent être corrigés après collation. RS 8.272 ne porte pas la mention à la première ligne de 3 KÙR ZÌ.KAL.KAL 6 GÍN KÙ.[BABBAR 6] UDU.ĤI.A, comme on peut le lire dans le *CAT*,⁷ mais 3 KÙR ZÌ.KAL.KAL 6 UDU.ĤI.A [...].⁸ Il s'agit en réalité d'un compte de farine, de moutons et d'une denrée qui a disparu de la tablette. Le texte logo-syllabique RS 10.044⁹ est très proche en contenu: une liste de noms de villes avec un montant de KÙR de farine, de bœufs, et de vin. L'association, farine, animal (bœuf ou mouton) et le vin constitue des éléments de base de l'alimentation et il semble raisonnable de restituer dans la cassure KÙR ZÌ.KAL.KAL 6 UDU.ĤI.A [DUG GEŠTIN] sans mention d'argent. Pour l'exemple RS 18.252, il s'agit en réalité d'un compte d'hommes (LÚ).¹⁰

Le groupe B2 constitue un lot homogène: on apprend en fin de texte que le chiffre figurant en face de chaque entrée fait référence à des mesures (KÙR et PA). Cela explique-t-il la différence entre B1 et B2: B1 présentant en début de liste les "biens" comptés, alors que B2 présente les mesures dans lesquelles sont mentionnées des denrées sans que celles-ci ne soient nommées explicitement?

Le groupe B3 quant à lui compte un seul texte, RS 94.2064. Il s'agit d'un compte d'hommes (LÚ.MEŠ) rappelant RS 18.252, mais cette fois avec un total de "gens" (ERIN₂.MEŠ). Cet exemple semble indiquer deux niveaux: des hommes-LÚ.MEŠ en groupe, constituent des troupes/gens-ERIN₂.MEŠ. La première ligne de ce texte est "bn.m'nt 2 LÚ.MEŠ".¹¹

Le groupe B réunit des textes où ce qui est exprimé sous la forme de logogramme fait référence à des biens élémentaires comme des moutons, de l'huile ou des hommes. Il semble raisonnable de considérer que les scribes ougaritains lisaient ces logogrammes en ougaritique: "binu-M 'NT X bunušūma" et non "binu-M 'NT X amīlū." Quoi de plus normal pour un scribe qui a appris, en copiant des vocabulaires S^a avec [LÚ = a-mi-lu = tar-š]u-wa-ni = bunu-šu,¹² que le logogramme LÚ n'avait pas seulement une lecture akkadienne mais aussi une "valeur" hourrite ou ougaritique?

GROUPE C

Le groupe C regroupe les textes où il n'y a pas de différence dans l'emploi de l'un ou l'autre système d'écriture dans un même texte. Ainsi, pour le sous-groupe C1 trouve-t-on un texte comme RS 94.2276 où après *it-ti* ^mhi-ia-ranu, vient *dblt*, "pâte de figues." Ces deux éléments sont mis sur le même plan, ils appartiennent au même registre, seule l'écriture diffère.

La différence entre les sous-groupes C1 et C2 est que, dans le premier, on trouve ce type de "mélange" dans une même ligne alors que le seul exemple de C2 montre le passage d'un cunéiforme à l'autre d'une phrase à l'autre. En effet, nous trouvons dans RS 19.136 à la suite d'une énumération du type "b + Nom de Lieu" une ligne avec "i-na ia-na." Si *ia-na* est bien à comprendre comme la ville de Yēna,¹³ malgré le manque très surprenant du déterminatif URU, on aurait là un parallèle parfait avec les lignes alphabétiques.

Dans ce groupe, on trouve un emploi du cunéiforme mésopotamien pour des noms propres mais aussi des mots akkadiens tels que *ina* ou *itti* qui pourraient tout à fait être utilisés ici comme akkadogrammes, comme c'est le cas dans les textes hittites par exemple.

⁷ Texte M. Dietrich et al., *The Cuneiform Alphabetic Texts from Ugarit, Ras Ibn Hani and Other Places (KTU, second enlarged edition)* (Münster: Ugarit-Verlag, 1995) (ici *CAT*), vol. 4 No. 38.

⁸ Voir en annexe 2, fig. 1.

⁹ J. Nougayrol, *Le palais royal d'Ugarit 3: Textes accadiens et hourrites des archives est, ouest, et centrales*, Mission de Ras Shamra 6 (Paris: Imprimerie Nationale & Klincksieck, 1955) (ici PRU 3), pp. 188 f.

¹⁰ En effet, il faut corriger le GÁN de C. Virolleaud, *Le palais royal d'Ugarit 5: Textes en cunéiformes alphabétiques des archives sud, sud-ouest et du petit palais*, Mission de Ras Shamra 11 (Paris: Imprimerie Nationale & Klincksieck, 1965) (ici PRU 5), p. 19 et du *CAT* en LÚ. I. Márquez Rowe avait proposé de lire un LÚ, mais se basant sur la copie de Virolleaud, il indique "the first sign shows clearly three small vertical wedges [... it] would then represent the sign LÚ, usually written with three small vertical wedges." Après col-

lation, il faut ajouter que le signe se présente très différemment sur la tablette de ce que l'on trouve sur la copie (cf. fig. 1). Cf. I. Márquez Rowe, "Mind the Edge!," *Nouvelles assyriologiques brèves et utilitaires* 1995/56. Voir photographie en annexe 2, fig. 2.

¹¹ LÚ étant donné comme équivalent logographique de *bnš* alphabétique, il semble que l'akkadien fasse une différence que ne montre pas l'ougaritique; *bnš* est à la fois singulier et collectif (dans des totaux ougaritiques par exemple). Voir G. del Olmo Lete et Joaquín Sanmartín, *A Dictionary of the Ugaritic Language in the Alphabetic Tradition*, vol. 1, [ʿ(a/i/u)-k], *Handbook of Oriental Studies* (Leiden et Boston: Brill, 2003), pp. 230–32.

¹² *Ugaritica* 5, 131.

¹³ Voir W. van Soldt, *The Topography of the City-State of Ugarit*, *Alter Orient und Altes Testament* 324 (Münster: Ugarit-Verlag, 2005), p. 25.

Étant donné le degré d'importance de ce "sabir graphique," est-il raisonnable de penser que les scribes lisaient une même phrase en changeant d'écriture et de langue? On pourrait considérer que l'on peut passer d'une langue à l'autre dans une même phrase pour exprimer des données se référant à une culture étrangère, du type "je lui ai envoyé un *e.mail*" ou encore "l'adresse du site internet est http deux points slash, etc." pour http://. Mais est-ce envisageable de la même façon lorsque ce qui y est mentionné relève du vocabulaire le plus usuel comme c'est le cas dans *it-ti* ^m*hi-ia-ra-nu* "avec *Ḫiyarānu*"? N'est-il pas plus raisonnable de considérer que le scribe a écrit *itti* et la notation d'un nom de personne en cunéiforme mésopotamien par "habitude" ou "facilité" mais s'est trouvé incapable d'écrire "gâteaux de figues" en logogrammes, ou a tout simplement repris son texte en alphabétique à cet endroit?

GROUPE D

Ce groupe est le plus important de la classification avec 29 textes: D1 où est noté le total ou les totaux (28 textes) et D2 avec un texte où l'on trouve des sous-totaux et un total général.

Il est vrai, comme l'a noté F. Malbran-Labat, que "lorsqu'il s'agit de totaux, l'emplacement est varié et il n'est pas possible d'expliquer uniformément ces mentions par un principe de classement qui aurait permis d'en apercevoir le résumé même lorsque la tablette était rangée (...)." ¹⁴ Cependant, un trait est commun à tous les textes du groupe D: le total est isolé du reste du texte. On trouve le total isolé: dans le texte par un trait de séparation (huit fois), ¹⁵ en marge du texte dans un sens différent ¹⁶ (une fois, RS 11.715+), seul au verso (huit fois ¹⁷), sur la tranche latérale gauche (huit fois ¹⁸) ou simplement à la fin du texte (deux fois ¹⁹).

Ce trait caractéristique du groupe D, isolement de l'épigraphe, semble indiquer que l'intérêt premier ici est de présenter le total de façon telle qu'il est possible de s'y référer aisément, en un seul "coup d'œil." Une différence d'écriture et d'emplacement permet de repérer les épigraphes très rapidement. Si l'aspect pratique d'un tel usage est évident, il ne nécessite pas une lecture akkadienne de l'épigraphe. Ces épigraphes sont écrites en logogrammes ou syllabes qui notent des noms de fonctions, d'objets ou des noms propres.

GROUPE E

Le groupe E comprend deux textes où l'épigraphe constitue le titre de la tablette: E1 seulement le titre et E2 le titre et le total. Dans les deux cas, l'épigraphe est isolée: sur la tranche latérale gauche ou au verso. Comme pour le groupe D, il semble que la différence d'écriture et l'emplacement particulier de l'épigraphe peut justifier leur emploi: ils permettent une identification rapide de la tablette.

Il est intéressant de noter qu'au contraire de cet usage, les titres écrits en alphabétique dans un texte alphabétique ne sont pas isolés du texte au verso ou sur la tranche.

GROUPE F

Les deux exemples qui illustrent ce groupe se définissent par l'ajout d'une donnée supplémentaire (non contenue dans le texte): un nom de personne, féminin ou masculin. Ces textes sont des bons de livraison: cuivre (RS 94.2409) ou chevaux, métal, bœufs, esclaves, ou vêtements (RS 94.2603).

Ces deux épigraphes se trouvent isolées du reste du texte, après un trait de séparation en fin de texte ou seule au verso. Comme pour les groupes D et E, il semble que la différence d'écriture pourrait être utilisée, combinée à l'isolement sur la tablette, pour faciliter l'accès à l'information. Il s'agirait dans ce cas, non pas du total ou du sujet, mais du nom de la personne liée à un mouvement de bien, même si ce lien nous échappe. Peut-être le nom désigne-t-il le "dossier" auquel appartient le bordereau: "concernant X."

¹⁴ Malbran-Labat, "Langues et écritures," p. 99.

¹⁵ RS 10.052, RS 11.721, RS 11.858, RS 15.103, RS 16.179, RS 16.193, RS 25.417, et RS 94.2943+. Auxquels il faut ajouter RS 19.017 où les totaux et sous-totaux sont séparés par des traits de séparation.

¹⁶ Rotation de 90° vers la gauche par rapport au sens du texte alphabétique.

¹⁷ RS 10.054, RS 11.797, RS 11.850, RS 15.076, RS 18.116, RS 21.002, RS 94.2401, et RS 94.2614. Le texte RS 94.2401 est très frag-

mentaire mais on ne peut distinguer de lignes d'écriture au-dessus de l'épigraphe; ce dernier apparaît donc seul au milieu du verso.

¹⁸ RS 11.776+, RS 11.857, RS 12.048, RS 16.355, RS 17.386, RS 86.2247, RS 94.2089, et RS 99.1072. Le texte RS 18.027 n'apparaît pas ici car l'épigraphe est reproduite en alphabétique également; il est classé en G1, mais il porte un total isolé sur la tranche latérale.

¹⁹ RS 11.722 et RS 18.[375].

Ces deux cas présentant des noms de personnes, on ne peut parler de langue des épigraphes excepté pour le mot DUMU (“fils”). Il semble très peu probable, à mon sens, qu’un scribe ougaritain ait lu X DUMU Y en akkadien “X *mâr* Y”, plutôt que dans sa langue “X *binu* Y.”

GROUPE G

Enfin, le groupe G contient lui aussi deux textes où l’épigraphie en écriture mésopotamienne est la transcription d’une ligne, G1, ou d’une liste en alphabétique ougaritique, G2.

L’épigraphie de RS 18.027 a été discutée à plusieurs reprises dans les études ougaritiques et une nouvelle collation en juin 2005 permet de proposer une nouvelle lecture. En effet, C. Virolleaud avait copié et lu les derniers signes comme 51, ce qui donnait un total de “sept cent soixante cinquante et un”, ‘cinquante et un’ paraissant corriger ou préciser ‘soixante’.²⁰ I. Márquez Rowe a proposé une interprétation différente de ces signes: il propose de lire 𐎶 MEŠ.²¹ Or, s’il est vrai que le dernier signe est bien MEŠ comme cela avait déjà été corrigé (KTU 4.340), après collation, il m’est impossible de confirmer sa lecture du signe précédent; on trouve bien cinq clous obliques comme indiqué sur la copie de Virolleaud. En outre, Márquez Rowe indique “No doubt the last sign of the Akkadian summary MEŠ would point to the obvious previous mention of the matter of the product dealt with in the text,” mais la liste fait référence à des salines et non à du sel. Enfin, il propose de voir dans 𐎶, avec une valeur DÛG *ṭābtu* “bonté,” une erreur du scribe pour noter *ṭābtu* “sel” normalement écrit avec le signe MUN. Mais la tablette porte bien cinq obliques et non pas quatre, le signe 𐎶 est donc impossible. Du point de vue de l’épigraphie, ce signe se présente comme un KÁM dans le corpus d’Ougarit.²² Je proposerais donc de lire la dernière ligne de cette tablette: “760 KÁM. MEŠ.” On trouve à Ras Shamra d’autres exemples de KÁM ou KAM suivis de MEŠ.²³ Cette lecture donne une bonne équivalence sémantique entre le total écrit en alphabétique et cette ligne en logogrammes. En effet, le dernier terme de la ligne ougaritique “šb‘ māt.tm kbd,” *kbd*, apparaît parfois à la suite de nombres complexes ce qui pourrait être l’équivalent de l’emploi de KÁM en tant que déterminatif suivant des nombres ordinaux.

Cette répétition du total dans les deux systèmes d’écritures pourrait s’interpréter ainsi: le scribe a spontanément écrit le total en alphabétique et a pris conscience du fait que s’il voulait rendre le total visible il devait non seulement l’écrire sur la tranche, mais également le différencier graphiquement par une écriture différente, en cunéiforme mésopotamien.

Enfin, l’exemple de G2 montre un texte où d’un côté figure une liste de noms de professions suivis de chiffres, tandis que sur l’autre face, on trouve la même liste suivie des mêmes chiffres mais cette fois le tout en écriture logogramme. Il semble que lorsqu’un scribe transcrit un texte de l’écriture mésopotamienne à l’alphabétique ougaritique, il conçoit de transcrire les chiffres également. Ce texte est très atypique; il est difficile d’imaginer que la double écriture réponde aux besoins de scribes différents qui pourraient lire un système d’écriture mais pas l’autre. À Ougarit, à part quelques rarissimes exemples de scribes venant peut-être de Mésopotamie,²⁴ les scribes sont ougaritains et ougaritophones. Il serait difficile d’imaginer un tel scribe formé dans l’écriture mésopotamienne et pas dans l’écriture alphabétique comptant seulement 30 signes. Le seul intérêt d’une double écriture dans un tel cas serait si le texte était destiné à être lu par un scribe extérieur au royaume ce qui est peu probable pour ce type de texte. Il me semble que la meilleure hypothèse reste celle d’un exercice scolaire où un même scribe apprendrait à écrire une même liste dans les deux systèmes d’écriture en usage en Ougarit, hypothèse qui est renforcée par la disposition même du texte: une face écrite dans le sens de la longueur, l’autre de la largeur.

²⁰ PRU 5, No. 96.

²¹ I. Márquez Rowe, “Summaries of Ugaritic Texts and Some New Reading Suggestions,” *Ugarit Forschungen* 24 (1992): 259–62.

²² Voir photographie en annexe. On trouve des exemples de KÁM où trois obliques sont inscrits au sommet de deux obliques, comme sur RS 15.137 PRU 3, pl. 30.

²³ Comme dans RS 15.122 (PRU 3, p. 131, pl. 26). L. 23: UD 1.KAM. MEŠ.

²⁴ W. van Soldt, “Babylonian Lexical, Religious and Literary Texts and Scribal Education at Ugarit and Its Implications for the Alphabetic Literary Texts,” dans *Ugarit: Ein Ostmediterranes Kulturzentrum*, ed. M. Dietrich et O. Loretz (Münster: Ugarit-Verlag, 1995), pp. 171–221.

CONCLUSION

Pour conclure, les signes utilisés pour ces épigraphes sont de deux genres. Tout d'abord, les logogrammes qui notent soit des nombres ou des fractions, soit de types divers: déterminatifs, mesures, biens et denrées ou expressions idiomatiques. Ensuite, on trouve des éléments écrits syllabiquement: des noms propres, des nombres, des biens ou des denrées et des expressions idiomatiques. On ne trouve jamais de verbe dans ces épigraphes, ce qui tient peut-être à leur nature même très synthétique. Les seuls éléments de vocabulaire évoquant explicitement la langue akkadienne sont les conjonctions ou prépositions que l'on retrouve par ailleurs en Périphérie attestées comme akkadogrammes.

Enfin, si l'on convient que les épigraphes des textes du groupe B étaient très probablement lues en ougaritique—s'agissant de biens communs comme des moutons ou de l'huile ou des mentions d'hommes—avec, par exemple, la première ligne du texte RS 8.272:

khnm 3 KÙR ZÌ.KAL.KAL 6 UDU.ĪI.A [...]

Lu en ougaritique?

kāhinūma talātu dūdu qamḥu tittu ṣa'nu²⁵ [...]

Plutôt qu'ougaritique et akkadien:²⁵

kāhinūma talātu *kur qalqālu* tittu *immerū* [...]

ou

kāhinūma *šalāšat kur qalqālu* *šalāšat immerū* [...]

Il semble peu probable qu'un scribe très probablement ougaritophone ait lu des mots comme mouton ou farine en akkadien dans un texte écrit en partie en ougaritique. Dans ce cas et si l'on doit effectivement lire ce texte complètement en langue ougaritique, que penser d'un texte comme RS 10.044, dont nous donnons ici un extrait?²⁶

^{URU}š_u-ra-ši 6 KÙR ZÌ.KAL.MEŠ 1 GU₄ 11 DUG G[EŠTIN]

Lu en ougaritique?

Šuraši tittu dūdu qamḥu ḥaḥadu ḥalpu ḥaštē ḥašrihu kaddūma yēnu

Il pourrait se révéler intéressant de faire une classification des textes logo-syllabiques administratifs sur la même base que cette classification-ci avec des groupes allant des textes en cunéiforme mésopotamien pouvant tout à fait être lus en langue ougaritique—comme RS 10.044—jusqu'à ceux où les éléments syllabiques indiquent très probablement une lecture akkadienne. Ce sera l'objet d'un prochain article.

²⁵ En italique souligné.

²⁶ Les lignes de ce texte sont parfois très fragmentaires. Elles se présentent toutes sous cette forme.

ANNEXE 1. LE VOCABULAIRE DES ÉPIGRAPHES

LOGOGRAMMES

SYLLABES

CHIFFRES:

- 1, 2, 3, etc.

FRACTIONS:

- 1/2
- 1/3
- 2/3
- 5/6

DÉTERMINATIFS:

- m, f
- GIŠ
- KAM.MEŠ
- KUŠ
- LÚ, LÚ.MEŠ
- TÚG.MEŠ
- URU

NOMS COMMUNS:

Unités de mesure

- DUG
- GÍN
- GUN
- KÙR
- PA

Biens et denrées

- ^{giš}BAN.MEŠ
- ERIN₂.MEŠ
- GEŠTIN, ^{giš}GEŠTIN
- GU₄.MEŠ
- Ì.MEŠ, Ì.GIŠ.MEŠ
- KÙ.BABBAR.MEŠ
- KUŠ.MEŠ
- LÚ.MEŠ
- LÚ.MEŠ ŠE.GUR₁₀.KUŠ
- TÚG.MEŠ GAL, TÚG.MEŠ SAL.MEŠ, TÚG.MEŠ TUR.MEŠ, TÚG.MEŠ GÚ.È.MEŠ
- UDU.ĦLA
- URUDU
- ZÌ.KAL.KAL

EXPRESSIONS IDIOMATIQUES:

- DUMU
- MIN
- ŠU (dans *ina ŠU*)
- ŠU.NIGIN₂
- UGU

NOMS PROPRES:

- noms de personne
- noms de lieu

NOMBRES:

- *me-at*
- *li-im*

BIENS ET DENRÉES:

- KUŠ *ga-ba-bu*
- LU.MEŠ *mar-ia-ni-^lma^l*
- TÚG.MEŠ *ku-ub-šu*
- KUŠ *ta-aš-šu?*
- *ta-pal*

EXPRESSIONS IDIOMATIQUES:

- *ša*
- *i-na*
- *it-ti*
- *ù*
- *ṭup-pu*

ANNEXE 2. LES TEXTES AVEC ÉPIGRAPHES CLASSÉS PAR GROUPE²⁷

GROUPE A: NOMBRES²⁸

A1: NOMBRES

RS 08.208 (CAT 4.36); RS 10.043 (CAT 4.47); RS 11.[900] (CAT 4.57); RS 11.[902] (CAT 4.58); RS 11.[920] [A]+[B] (CAT 4.64); RS 11.656 (CAT 4.66); RS 11.774 (CAT 4.77); RS 11.775 (CAT 4.78); RS 11.789 (CAT 4.87); RS 11.792 (CAT 4.104); RS 11.832 (CAT 4.94); RS 12.001 (CAT 4.106); RS 12.004 (CAT 4.109); RS 12.008 (CAT 4.111); RS 16.075 (CAT 4.210); RS 16.271 (CAT 4.227)²⁹; RS 17.[469] (CAT 4.250); RS 17.016 (CAT 4.260); RS 18.[385] (CAT 4.489); RS 18.[486] (CAT 4.559); RS 18.[495] (CAT 4.565); RS 18.[504] (CAT 4.571); RS 18.[525] (CAT 4.584); RS 18.[530] (CAT 4.588); RS 18.[542] (CAT 4.597); RS 18.[557] (CAT 4.606); RS 18.009 C (CAT 4.331); RS 18.025 (CAT 4.338)³⁰; RS 18.039 (CAT 4.350); RS 18.073 (CAT 4.365); RS 18.250 [A](+)[B] (CAT 4.410)³¹; RS 18.303 (CAT 4.432); RS 18.304 (CAT 4.433); RS 18.308 (CAT 4.437); RS 18.309 (CAT 4.438); RS 18.365 (CAT 4.472); RS 19.018 (CAT 4.611); RS 19.018 [B] (CAT 4.613); RS 19.037 (CAT 4.616)³²; RS 19.044 (CAT 4.617); RS 19.123 (CAT 4.646); RS 19.158 A (CAT 4.655); RS 19.169 (CAT 4.665); RS 19.171 (CAT 4.667); RS 19.174 (CAT 4.676); RS 19.180 (CAT 4.681); RS 20.157 (CAT 4.693); RS 21.063 B (CAT 4.706)³³; RS 22.004 (CAT 4.711); RS 22.046 (CAT 4.713); RS 22.231 (CAT 4.714); RS 34.162 (CAT 4.763); RS 94.2050+; RS 94.2460; RS 94.2470; RS 94.2945; RS 94.2961 A; RS 94.5002+; RS 94.5017; RS 96.2021; RS 96.2090; RS 99.1052; TS 4001 (CAT 4.766); RS [Varia 19] (CAT 4.785)

A2: FRACTIONS³⁴

RS 11.845 (CAT 4.99); RS 19.170 (CAT 4.666); RS 94.2078; RS 94.2093; RS 94.2192; RS 94.2472

A3: ME-AT ET LI-IM³⁵

RS 29.101 (CAT 4.753); RS 92.2001+ (RSO 14, 35); RS [Varia 38] (CAT 4.784)

²⁷ Dans les tableaux, les passages en ougaritiques sont signalés par (...).

²⁸ On trouve cependant des nombres dans des textes apparaissant dans d'autres groupes: avec des fractions [RS 11.845 (CAT 4.99); RS 94.2093; RS 94.2192; RS 94.2472], avec des centaines et des milliers mésopotamiens [RS 29.101 (CAT 4.753); RS 92.2001+ (14, 35); RS [Varia 38] (CAT 4.784)] et avec des épigraphes [RS 8.272 (CAT 4.38); RS 11.716 (CAT 4.68); RS 11.715+ (CAT 4.69) avec fractions; RS 11.721 (CAT 4.71); RS 11.722 (CAT 4.72) trop fragmentaire pour affirmer qu'il portait des chiffres mésopotamiens; RS 11.797 (CAT 4.90), RS 11.776+ (CAT 4.93); RS 11.850 (CAT 4.100); RS 12.048 (CAT 4.116); RS 14.001 (CAT 4.125); RS 16.355 (CAT 4.232); RS 17.386 (CAT 4.308); RS 18.252 (CAT 4.416); RS 18.306 (CAT 4.435); RS 18.306 (CAT 4.435); RS 18.[375] (CAT 4.481); RS 19.017 (CAT 4.610); RS 21.002 (CAT 4.704), RS 25.417 (CAT 4.745); RS 92.2013 (RSO 14, 41); RS 94.2614; RS 94.2064; RS 94.2089; RS 99.1072 avec fractions; RS 94.2078 avec fractions]. On peut trouver des textes où dans le corps du texte les nombres sont écrits en cunéiforme ougaritique, en toutes lettres mais en cunéiforme mésopotamien dans l'épigraphe: RS 10.052 (CAT 4.63); RS 10.045 (CAT 4.48); ?RS 11.857 (CAT 4.102); RS 11.858 (CAT 4.103); RS 15.076 (CAT 4.165); RS 15.103 (CAT 4.179) si le chiffre 56 est bien à considérer

comme un total; RS 16.179 (CAT 4.219) épigraphe avec fractions; RS 16.193 (CAT 4.222); RS 18.027 (CAT 4.340); RS 18.102 (CAT 4.381); RS 86.2247; RS 94.2943+; RS 94.2401.

²⁹ Il faut peut-être considérer le signe DIŠ comme marqueur d'entrée (sur le modèle des textes lexicaux) plutôt qu'ayant la valeur 1.

³⁰ Nombres notés tantôt en écriture alphabétique ougaritique tantôt en cunéiforme mésopotamien. Valeur particulière de l'un ou l'autre dans ce cas précis?

³¹ Sur les cinquante-quatre lignes conservées le scribe écrit à chaque ligne les nombres en alphabétique ougaritique sauf deux fois où il note 1, non pas *ahd* comme à la ligne supérieure du texte mais DIŠ.

³² Comme RS 18.025, ce texte présente tantôt des chiffres ougaritiques tantôt mésopotamiens.

³³ L'emplacement du signe DIŠ, au milieu de la phrase, est très atypique. Peut-être n'est-il pas à considérer comme un nombre mais simplement comme un clou de séparation.

³⁴ Ne seront mentionnées ici que les fractions apparaissant hors des épigraphes. Mais certaines apparaissent hors des épigraphes dans des textes comportant des épigraphes: RS 99.1072.

³⁵ Ne seront mentionnés ici que les centaines et milliers mésopotamiens apparaissant hors des épigraphes.

GROUPE B: DÉFINITION DE L'OBJET COMPTABILISÉ

B1: DÉFINITION DE L'OBJET COMPTABILISÉ EN DÉBUT DE TEXTE

- RS 8.272³⁶ *première ligne:*
khn^m 3 KÙR ZÌ.KAL.KAL 6 UDU.ĜI.A [...]
(...)
- RS 18.252 *première ligne:*
mrynm 5 LÚ.MEŠ
(...)
- RS 92.2013 *première ligne:*
riš. 60 KUŠ.MEŠ
(...)

B2: DÉFINITION DE L'OBJET COMPTABILISÉ EN FIN DE TEXTE

- RS 14.001 (...)
dernière ligne:
årmsg 1 KÙR
- RS 94.2078 (...)
avant-dernière ligne et dernière ligne:
[...] PA
[...] ½ PA

B3: DÉFINITION DE L'OBJET COMPTABILISÉ EN DÉBUT DE TEXTE ET TOTAL

- RS 94.2064 *première ligne:*
bn.m^cnt 2 LÚ.MEŠ
(...)
dernière ligne:
ŠU.NIGIN₂ ERIN₂.MEŠ 1 *me-at* 13

GROUPE C: UN MÊME TYPE DE PHRASE

C1: UN MÊME REGISTRE, DEUX ÉCRITURES DANS UNE MÊME PHRASE

- RS 94.2276 (...)
[x] KÙ.BABBAR.MEŠ m̀IR-DINGIR-ti 3 DU[G Ì.G]IŠ.MEŠ
it-ti m̀ĥi-ya-ra-na dblt
[5] *it-ti* DUMU fša-ri-na
[3(+ ?)] *it-ti* [DUMU m̀qà-na-zi
[2(+ ?)] TÚG.GAD
(...)
espace, puis:
[...] [Ì.GIŠ].MEŠ URU ša-ra-ri
- RS 94.2411 (...)
1 *me-at* 60+20+[5] ŠU.NIGIN₂
(...)
tš^c- . ũĥnp . [20] É URU IGI-qá-p-at

³⁶ Ce texte dénombre des KÙR mais à la ligne 5, on a un changement de mesure, il s'agit à présent de PA.

ḫmš . ḫrṣb^c 6 É URU *ya-ar-[tu₄]*

(...)

1 *me-at* 30

10 É URU *ya-pa-ru*

6 É URU *za_x-ri-nu*

33 É URU *a-ru-tu₄*

6 É URU *šal-lu-ur-bá*

4 É URU *šul-ḫa-na*

27 É URU *ma-qa-bu*

3 É URU *qamá-nu-zu*

┌-┐ É ┌URU┐ *šal┐-ma*

┌-┐ É ┌URU┐ *a-┌ra-┐a*

6 ┌É URU IGI┐-*ma-ka*

60+10+7 É ŠU.NIGIN₂

1 É URU *mu-lu-ki*

7 É URU *ḫu-be-lu*

22 É URU *ap-pí* 37 É URU *pí-dì*

C2: UN MÊME REGISTRE, DEUX ÉCRITURES DANS UN MÊME PARAGRAPHE

RS 19.136 (...)³⁷

i-na ia-na

GROUPE D: TOTAUX

D1: UN OU PLUSIEURS TOTAUX

RS 10.045 (...)

1 *me-at* 48 DUG GEŠTIN ŠU.NIGIN₂

RS 10.052 (...)

6 KUŠ *ga-ba-bu* 21 GIŠ BAN.MEŠ

(...)

ŠU.NIGIN₂ ┌6 KUŠ *ga┐-ba-bu* 26 GIŠ BAN.MEŠ

(...)

ŠU.NIGIN₂ 9 KUŠ *ga-ba-bu* 7 GIŠ BAN.MEŠ

(...)

³⁷ Phrase ougaritique sur le modèle *b* + Nom de lieu, ce qui équivaut à l'écriture akkadienne *ina* + Nom de lieu.

ŠU.NIGIN₂ 16 KUŠ¹ *ga-ba-bu* 7 GIŠ BAN.MEŠ

(...)

ŠU.NIGIN₂ 16 KUŠ¹ *ga-ba-bu* 17 GIŠ¹ [BAN.MEŠ]

(...)

ŠU.NIGIN₂ 3 BAN.MEŠ [...]

(...)

ŠU.NIGIN₂ 1 KUŠ *ga-ba-bu* 3 GIŠ BAN.MEŠ

(...)

10 KUŠ *ga-ba-bu* 7 GIŠ B[AN.MEŠ]

(...)

ŠU.NIGIN₂ 56 KUŠ¹ *ga-ba¹-bu*

79 GIŠ BAN.MEŠ

RS 11.715+

(...)

4 *me-at* 87 ŠU.NIGIN₂ KÙ.BABBAR.MEŠ *ša* LÚ.MEŠ *mar-ia-ni-¹ma₅*¹³⁸

(...)

ŠU.NIGIN₂ KÙ.BABBAR.MEŠ 1 *me-at* 30[+x[?]]

(...)

ŠU.NIGIN₂ KÙ.BABBAR.MEŠ 140[+x[?]]

(...)

ŠU.[NIGIN₂ KÙ.BABBAR.MEŠ]

(...)

ŠU.NIGIN₂ KÙ.BABBAR.MEŠ 32

(...)

ŠU.NIGIN₂ KÙ.BABBAR.MEŠ 9

(...)

ŠU.NIGIN₂ KÙ.BABBAR.MEŠ [...]

ŠU.NIGIN₂ KÙ.BABBAR.MEŠ 86

RS 11.721

(...)

[ŠU.NIGIN₂ KÙ.BABBAR.MEŠ x+[?]] 31

(...)

ŠU.NIGIN₂ KÙ.BABBAR.MEŠ 41

³⁸ Le CAT indique “4 *me-at* 87 ŠU.NIGIN₂ KÙ.BABBAR.MEŠ *ša* Š[U] un *ša* ŠU et on trouve encore des traces du MA final avec le vertical et l’horizontal supérieur.” Cependant, la place est insuffisante pour restituer

	(...)
	ŠU.NIGIN ₂ KÙ.BABBAR.MEŠ 12
	[...] ³⁹
RS 11.722	(...)
	[ŠU.NIGIN ₂ KÙ.B]ABBAR.MEŠ 12
RS 11.776+	(...)
	4 <i>me-at</i> DUG G[EŠTIN ŠU.NIGIN ₂]
RS 11.797	(...)
	30 GÍN KÙ.BABBAR.MEŠ ŠU.NI[GIN ₂]
RS 11.850	(...)
	ŠU.NIGIN ₂ ERIN ₂ .MEŠ
RS 11.857	(...)
	URU <i>a-la-ši-ia</i>
RS 11.858 ⁴⁰	(...) 5

	(...) 13

	(...) 10

	(...) 6

	(...) 1

	(...) 1

	(...) 2

	(...) 3

	(...) 5

	(...) 2

	(...) 11

	(...) 5
RS 12.048	(...)
	[...] ⁸²
RS 15.076	(...)
	3 TÚG.MEŠ GAL
	6 TÚG.MEŠ TUR.MEŠ
	2 TÚG.MEŠ SAL.MEŠ
	5 TÚG GÚ.È.MEŠ
	10 TÚG.MEŠ <i>ku-ub-šu</i>
RS 15.103 ⁴¹	(...) [[56]]

	(...)

³⁹ Le texte est fragmentaire. On peut supposer que figurait à la fin un total général, mais cela n'est pas assuré.

⁴⁰ Ce texte est très particulier. Il contient de petites listes où les nombres sont écrits en ougaritique alphabétique mais à la fin de chaque

paragraphe, on trouve un total en écriture mésopotamienne noté seulement par un chiffre.

⁴¹ Le chiffre 56 est soit à ignorer, soit à considérer comme un total.

RS 16.179	(...) 14 GÍN $\frac{5}{6}$ KÙ.BABBA[R]
RS 16.193 ⁴²	(...) 6 ----- (...) 5 (...) 3 -----
RS 16.355	(...) 1 <i>me-at</i> 55
RS 18.[306]	[...] [...] ŠU.NIGIN ₂ x [...] (...) [...] x [ŠU].NIGIN ₂ x x (...)
RS 17.386	(...) 6 <i>tap-pal</i> GU ₄ .MEŠ ŠU.NIGIN ₂
RS 18.[375]	(...) [...] 72 $\frac{1}{2}$
RS 18.116	(...) [...]+ ¹ 10 ¹ GU ₄ UGU m[...] - <i>na</i> LÚ URU <i>na-ni-i</i> [...]+41 GU ₄ UGU m <i>ta-mar-ti-nu</i> LÚ URU <i>sú-la-di</i> (ou - <i>ki</i>) [...]+27 GU ₄ UGU m <i>a-na-ni-ia-na</i> LÚ URU <i>ia-ku-SIG₅</i> [...]+20 GU ₄ UGU m <i>na-pa-ri</i> LÚ URU <i>ḫal-pí</i> [...]+GU ₄ UGU m <i>lu-lu-wa-na</i> LÚ URU <i>sa-ḫa-qi</i> [...]+GU ₄ UGU m <i>p]u-us-ḫa-na</i> LÚ URU <i>u-bur-a</i> [...]+GU ₄ UGU m <i>p]ur[?]-ra-na</i> DUMU m <i>gu-ub-ru-na</i> LÚ URU <i>na-ni-i</i>
RS 21.002	(...) ŠU.NIGIN ₂ ERIN ₂ .MEŠ 13
RS 25.417	(...) ----- 22
RS 86.2247	(...) [...]URU ¹ x ¹ [...] ⁴³
RS 94.2089	(...) [...]+ ¹ LÚ.MEŠ ¹ ŠE.GUR ₁₀ .KU ₅ 1 <i>me-at</i> ¹ 4 ¹
RS 94.2401	(...) [x+] ²⁸ ¹ GUN ¹ 6 <i>me-at</i> 30 ŠU.NIGIN ₂ ¹ URUDU ¹
RS 94.2614	(...) ŠU.NIGIN ₂ KUŠ.MEŠ <i>ta-aš-šu</i>
RS 94.2943+ ⁴⁴	(...) ŠU.NIGIN ₂ KÙ.BABBAR.MEŠ 49 $\frac{2}{3}$
RS 99.1072	(...) [...] 4 [?] KÙ.BABBAR.MEŠ

D2: SOUS-TOTAUX ET TOTAL

RS 19.017	(...) [...] <i>li-i</i>]m [x m] <i>e-at</i> 56 (...) -----
-----------	--

⁴² Même remarque que pour RS 11.858.⁴³ Total de villes?⁴⁴ Noter, dans le texte les chiffres sont en alphabétique.

[...]li-im 1 me-at 22+[...]
 †ŠU¹.NIGIN₂ KÙ.BABBAR.MEŠ 20 URU.[MEŠ]
 †li¹-im 6 me-at
 ŠU.NIGIN₂ KÙ.BABBAR.MEŠ URU.[MEŠ]

 3[?] li-im 49
 [ŠU.N]IGIN₂ KÙ.BABBAR.MEŠ

GROUPE E: TITRE

E1: TITRE

RS 11.716 (...)
 †tup¹-pu ERIN₂.MEŠ ša GIŠ BAN.MEŠ

E2: TITRE ET TOTAUX

RS 18.102 *tup-pu* Ì.MEŠ GIŠ[...]
 20 DUG Ì.MEŠ *mi*²-[...]
 79[?] †DUG Ì.MEŠ¹ MIN[?] 1[?][...]
 5 DUG Ì.MEŠ MIN[...]
 15 DUG Ì.MEŠ MIN [...]
 5 DUG Ì.MEŠ MIN [...]
 5 DUG Ì.MEŠ MIN [...]
 5 DUG Ì.MEŠ [...]
 60 †DUG Ì.MEŠ¹ [...]
 10[?] †DUG Ì¹[.MEŠ...]
 80[?] †DUG Ì¹[.MEŠ...]
 †ù¹ 5 x[...]
 [...]x x[...]
 (...)

GROUPE F: INFORMATION SUPPLÉMENTAIRE

F: INFORMATION SUPPLÉMENTAIRE

RS 94.2409 (...)
^mmu-wa-an-ḫu-di-ka DUMU ia-ra-LÚ LÚ URU an-da-rù/aš
 RS 94.2603 (...)
^fa-ni-in-zi

GROUPE G: DEUX ÉCRITURES POUR UN MÊME TEXTE

G1: UN TOTAL, DEUX SYSTÈMES D'ÉCRITURE

RS 18.027 (...) ⁴⁵
 7 *me-at* 60 KÁM.MEŠ

G2: UNE LISTE, DEUX SYSTÈMES D'ÉCRITURE

RS 94.2519	LÚ.MEŠ.NAGAR GIŠ.GIGIR	6
	LÚ.MEŠ.ZA.DIM	5
	LÚ.MEŠ.SIMUG.URUDU	9
	LÚ.MEŠ.KÙ.DÍM	7
	LÚ.MEŠ.NAR	5
	LÚ.MEŠ.NAGAR.SIG	10
	LÚ.MEŠ.TÚG.LÁ	9
	LÚ.MEŠ.DUB.SAR	[4]
	LÚ.MEŠ.AŠGAB	[1]
	LÚ.MEŠ.DIM.É1 [...]	
	LÚ.MEŠ.1-1 [...]	
	LÚ.ME[Š ...]	
	[...]	
	(...)	

⁴⁵ Le total en ougaritique se présente parallèlement: šb' māt. ttm kbd.

ANNEXE 3. FIGURES



Figure 1. Détail de l'épigraphe de RS 8.272 (recto et tranche).



Figure 2. Détail de l'épigraphe de RS 18.252.



Figure 3. Détail de l'épigraphe de RS 18.027.

ON SOME TERMS FOR LEATHERWORKING IN ANCIENT MESOPOTAMIA

JoAnn Scurlock, Elmhurst College

Among the crafts for which the Middle East has been renowned since the Middle Ages is the manufacture of leather goods. First, the skins are soaked in a depilatory such as quicklime and the hair removed with a specially designed knife. They are then cured in vats of barley meal mixed with water, which causes the hides to swell and allows any remaining flesh to be scraped away. The skins are then ready to be made into leather.¹

In all, three leather-making processes are used. The first is what is known as chamoising, which involves replacing the animal fat stripped from the hide with oil (Arabic: *šahm*).² The second process is what is known as tawing, which involves treating the skins, usually those of small animals such as sheep and goats, with a mixture of alum, salt, and flour. Yogurt may be added to this alum bath or the skins may be treated with oil after the alum has done its work. In Cordoba, tawed skins were dyed with the insect dye kermes to produce the beautiful red Cordoba leather.³ The third process is tanning, properly speaking, usually reserved for large hides such as those of cattle, ass, and horse. This involves soaking the hides in any of a variety of vegetable tannins found in nature. Some plants, however, produce what is known as a bloom or ugly yellow splotches on the finished product.⁴ The plants normally used for tanning, namely, gall nuts, sumac, or acacia bark, are preferred because they do not produce a bloom. After drying and grinding, the hide is ready for dyeing and burnishing.

It is the thesis of this paper that all three of these processes were already known in ancient Mesopotamia and derive ultimately from that source. This flies rather in the face of a recent article by van Driel-Murray, who argues that there is no Egyptian evidence for either tanning or tawing before the Roman period, that plants normally interpreted as tanning agents are merely vegetable dyes, that the alum mentioned in ancient Mesopotamian texts dealing with leatherworking was merely a mordant (fixative) for these dyes, and that therefore neither Egypt nor Mesopotamia had anything which might remotely be referred to as a leather industry.⁵ However, whatever the situation in ancient Egypt, if we muster our evidence we can show that hides were indeed treated and not just dyed in ancient Mesopotamia.

In the first place, there is direct evidence for the preliminary stages in leather manufacture.⁶ As argued by Deller,⁷ the term KUŠ.TAB.BA refers to hide treated with “*kurru* of the tanner” so that the hair becomes friable (TAB = *sepû*) and easily removed with a scraper. The exact contents of this depilatory paste are not specified but, in more modern tanning processes, a solution of quicklime is used for this purpose.⁸ Curse formulas in Neo-Assyrian contracts require that if you break the contract you have to drink a bowl of this depilatory paste (*kurru*) and eat a mina of the resulting “*kurru* hair” called *qerdu*. *Qerdu* is related to *qurrudu* “to fall out in tufts” (said of the hair on balding heads) and is related to the Aramaic and Hebrew *grd* “to scrape off.”⁹ (A note in passing: CAD’s *sadru* and *ša sadrišu* are to be removed from the lexicon.¹⁰ The correct reading for the former is *kurru* “depilatory paste” and the

¹ For details, see Hans E. Wulff, *The Traditional Crafts of Persia* (Cambridge: M.I.T. Press, 1966), pp. 230–32, and Ahmad Y. al-Hassan and Donald R. Hill, *Islamic Technology* (Cambridge: Cambridge University Press, 1986), pp. 197–99.

² Hassan and Hill, *Islamic Technology*, p. 198.

³ Hassan and Hill, *Islamic Technology*, p. 199.

⁴ See the chart in the *Encyclopedia Britannica* (Chicago: William Benton, 1961), vol. 13, p. 847.

⁵ Carol van Driel-Murray, “Leatherwork and Skin Products,” in *Ancient Egyptian Materials and Technology*, edited by Paul T. Nicholson and Ian Shaw (Cambridge: Cambridge University Press, 2000), pp. 304–05.

⁶ See Francis Joannès, “Produits pour le travail du bois, du cuir, et du tissu,” in *Archives administratives de Mari I*, Archives Royales de Mari 23, edited by Guillaume Bardet et al. (Paris: Éditions Recherche sur les Civilisations, 1984), p. 141.

⁷ Karlheinz Deller, “*kurru* ‘Mehlbrei,’” *Orientalia* NS 54 (1985): 327–30.

⁸ Wulff, *Traditional Crafts of Persia*, p. 231.

⁹ Karlheinz Deller, “*gurrudu* ‘kahlköpfig’ und *gerdu* ‘abgeschabte Wolle,’” *Notes assyriologiques brèves et utilitaires* 1992/79.

¹⁰ On this point, see also Stephanie Dalley, review of Theodore Kwasman, *Neo-Assyrian Legal Documents in the Kouyunjik Collection of the British Museum*, in *Orientalistische Literaturzeitung* 85 (1990): 666.

later *ša kurrišu* “seller of depilatory paste,” not a beverage peddler.) The next step, currently known as “swelling,” was referred to as KUŠ.A.GAR.KÚ.A¹¹ (*šukulūtu*, lit. “made to eat”).¹²

It seems highly unlikely that anyone would go to such trouble to dehair and swell hides if they had no intention of processing them any further. Oil treatment (chamoising) is such a simple next step that it would be hard to believe that this was not done even if we did not have evidence in administrative texts for oil treatments for hides. There is, in fact, an Akkadian word (*šipku*¹³ “heaped up/poured out”) which might refer to this type of leather. If there was a tanning industry, however, we really should have words in Akkadian for tanning agents such as gall nuts and sumac, and this is where the difficulty has lain. It would be rather shocking if we can find no Akkadian words for these two products,¹⁴ given the fact that sumac is common in northern Iraq today both as a wild and as a cultivated plant¹⁵ and that gall nuts suitable for tanning appear on the tamarisk¹⁶ as well as on the more familiar oak. And yet, this was apparently the case. R. Campbell Thompson’s suggestion for “gall nut” was GIŠ.ĤAB/*hurātu*. Unfortunately, the plant in question grew in gardens and had shoots and roots, neither of which would be expected of a gall. One solution to this problem, proposed by W. Farber, is to see *hurātu* as sumac.¹⁷ This is rejected by Stol who argues for an interpretation of *hurātu* as “madder,”¹⁸ a red dye, on the grounds that *hurātu* is expressly stated to dye leather red (*šarāpu*)¹⁹ whereas sumac is 1) primarily a tanning rather than a dyeing agent and 2) produces not a red color but a “beautiful rich yellow.”²⁰

Another candidate for “gall nut” was seen by CAD in *šulmu* which appears on several trees,²¹ not, however, on any of those which might be expected in such a context.²² Other suggestions which have been put forward include Ú.ĤÁB in the Umma texts which Sigrist identifies as “gall nut.”²³ Sigrist further argues that GIŠ.ĤAB, which he interprets as “sumac,” should be read GIŠ.RIN and equated with the expression Ì.RÌ.NA or E.RÌ.NA which appears frequently in Umma texts.²⁴ Stol accepts Sigrist’s interpretation of Ú.ĤÁB as “gall nut”²⁵ and he accepts the equation of Ì.RÌ.NA or E.RÌ.NA with what is conventionally read as GIŠ.ĤAB. However, Stol takes the latter to be “madder” rather than “sumac.”²⁶ Van De Mieroop, for his part, argues that Ú.ĤÁB is a dye, not a gall nut, and is, in fact, just another Sumerogram for what is later referred to as GIŠ.ĤAB = *hurātu* “madder.”²⁷ He further suggests for Sigrist’s Ì.RÌ.NA or E.RÌ.NA that it represents skins which have been first dyed with madder and then waterproofed with oil.

¹¹ Marcel Sigrist, “Le travail des cuirs et peaux à Umma sous la dynastie d’Ur III,” *Journal of Cuneiform Studies* 33 (1981): 166–67; cf. Marten Stol, “Leder(industrie),” in *Reallexikon der Assyriologie* 6 (Berlin: Walter de Gruyter, 1980–83), p. 531.

¹² For references, see CAD s.v. *šukulu* mng. 2.

¹³ CAD s.v. *šipku* A mng. 3; cf. Jean-Marie Durand, *Textes administratifs des Salles 134 et 160 du palais de Mari*, Archives Royales de Mari 21 (Paris: P. Geuthner, 1983), p. 368.

¹⁴ Note that there is an isolated reference to dues(?) assessed on sumac(?) and gall nuts(?) in a text from Carchemish where the context and the closeness of etymological parallels with Syriac suggest that we may be dealing with West Semitic loanwords. (J. Nicholas Postgate, *Taxation and Conscriptio in the Assyrian Empire* [Rome: Biblical Institute Press, 1974], p. 361:33–35; cf. Stol, “Leder(industrie),” p. 533).

¹⁵ C. C. Townsend and Evan Guest, *Flora of Iraq*, vol. 4: (Baghdad: Ministry of Agriculture, 1980), pp. 490–92; cf. Reginald Campbell Thompson, *A Dictionary of Assyrian Botany* (London: British Academy, 1949), pp. 163–64.

¹⁶ Jamal Bellakhdar, *Médecine traditionnelle et toxicologie ouest-sahariennes* (Rabat: Éditions Techniques Nord-Africaines, 1978), No. 349.

¹⁷ Walter Farber, *Beschwörungsrituale an Ištar und Dumuzi*, Veröffentlichungen der Orientalischen Kommission der Akademie der Wissenschaften und der Literatur 30 (Wiesbaden: Franz Steiner, 1977), pp. 88–91.

¹⁸ Stol, “Leder(industrie),” pp. 534–35. See also Wilfred van Soldt, “Fabrics and Dyes at Ugarit,” *Ugarit Forschungen* 22 (1990): 324. Note that Walter Farber in his review of *The Archive of Urad-Šerua and His Family: A Middle Assyrian Household in Government Service*, by J. N. Postgate, in *Journal of Near Eastern Studies* 52 (1993): 60, does not consider this “definitively proven.”

¹⁹ For references, see CAD s.v. *šarāpu* mng. 1c.

²⁰ Campbell Thompson, *Dictionary of Assyrian Botany*, p. 164.

²¹ CAD s.v. *šulmu* mng. 4.

²² See Fritz Rudolf Kraus, “Der Brief der Gilgameš,” *Anatolian Studies* 30 (1980): 111 n. 23.

²³ Sigrist, “Le travail des cuirs,” pp. 161–62.

²⁴ Sigrist, “Le travail des cuirs,” pp. 162–63.

²⁵ Stol, “Leder(industrie),” p. 532. See also G. Th. Ferwerda, *A Contribution to the Early Isin Craft Archive*, Studia ad tabulas cuneiformes a de Liagre Böhl collectas pertinentia 5 (Leiden: Nederlands Instituut voor het Nabije Oosten, 1985), p. 17.

²⁶ Stol, “Leder(industrie),” p. 535. See also van Soldt, “Fabrics and Dyes,” pp. 324, 347–48; Stephanie Dalley, “Ancient Assyrian Textiles and the Origins of Carpet Design,” *Journal of Persian Studies* 29 (1991): 124.

²⁷ Marc Van De Mieroop, *Crafts in the Early Isin Period*, Orientalia Lovaniensia Analecta 24 (Leuven: Departement Orientalistiek, 1987), pp. 31–32; cf. Piotr Steinkeller, “Mattresses and Felt in Early Mesopotamia,” *Oriens Antiquus* 19 (1980): 96. Van Soldt, “Fabrics and Dyes,” p. 324 n. 23, does not accept the equation of Ú.ĤÁB and GIŠ.ĤAB; see Farber, *Ištar und Dumuzi*, p. 89. To add to the confusion, there is the issue of the first-millennium Ú.ĤÁB which may be the same plant as Ú.ĤÁB. The equation of GIŠ.ĤAB with Ú.ĤÁB is accepted by Benno Landsberger, “Über Farben im Sumerisch-akkadischen,” *Journal of Cuneiform Studies* 21 (1967): 170. In late texts Ú.ĤÁB is definitely a separate plant from GIŠ.ĤAB, not, however, *bu’šānu* but “plant for *bu’šānu*,” in other words, a plant which actually had another name and was proverbial for its use in treating this syndrome. Ú.ĤÁB may also not be the same as Ú.ĤÁB, whose first-millennium equivalent may well be a plant usually interpreted as *tullal* but written Ú.TÚL(=ĤÁB).LÁ.

This difficulty in finding equivalents is serious, since without either sumac or gall nuts, one cannot speak of ancient Mesopotamia as having a tanning industry and that is indeed why many scholars continue to insist that *hurātu* must be some sort of tanning agent, if not sumac due to the problem with the color, then the original gall nut.²⁸ Leaving the tanning issue aside for the moment, there is an easy resolution for the *hurātu* controversy which will allow everybody to be at least partly right. It is noticeable that *hurātu* is usually, if not invariably, mentioned in the same breath with alum. As we saw earlier, alum features prominently in the process of tawing leather, after completion of which it was the custom, at least in Cordoba, to dye the resulting product a bright red, the precise color which would be achieved by using madder.

Apart from administrative texts which are notoriously long on the amounts of ingredients needed and short on what was actually done with them, we have a few precious passages which actually give instructions for the manufacture of leather goods. One of these (François Thureau-Dangin, *Rituels accadiens* [Paris: Ernst Leroux, 1921], pp. 14 f.:21–25) describes the swelling process in which the hide was soaked in a mixture of flour, water, beer, and wine.²⁹ Unfortunately, this text runs together the last two stages in the process. These appear in proper order in Farber, *Ištar und Dumuzi*, pp. 59 f.:52–54, which gives instructions for the manufacture of leather amulet bags. The text begins with the application of vegetable and animal fats,³⁰ followed by tawing with the “Hittite” alum of Thureau-Dangin, *Rituels accadiens*, pp. 14 f.:24, and ends with the dyeing of the leather.

KUŠ SAL.ĀŠ.GĀR ina GA ÛZ.SIG₇ u ZÌ.DA tu-šak-kal Ì.DÙG.GA Ì.ĀB.KÙ.GA ŠĒŠ NA₄ ga-bi-i ina GEŠTIN SUR.
RA ta-maḥ-ḥa-aḥ-ma IGI KUŠ ina GIŠ.ḪAB nu-ka-rip-pa-ti SA₅-ma

You swell the hide of the she-goat with milk from a yellow goat and flour and you rub it with sweet oil and pure fat from a cow. You soak it in alum (mixed) with drawn wine and then you redden the surface of the hide with *hurātu*.

Soaking in alum by definition produces tawed (not tanned) leather; the oil treatments alone, chamois.³¹ In short, what we have evidence for is an industry which produced both chamois and leather which was tawed with alum. The alum was actually from Egypt,³² amazing as it may seem when the Egyptians themselves (according to van Driel-Murray) never used their alum for this purpose.³³

In ancient Mesopotamia, the tawed leather was subsequently dyed red with *hurātu* or, at Mari, with *kalgukku*-clay.³⁴ Where waterproofing was desired, this tawing was followed by further application of oil or sheep fat.³⁵ The finished product was probably indeed the Ì.RÌ.NA or E.RÌ.NA of Sigris’ texts, as suggested by Van De Mieroop. Late Babylonian texts indicate that the tawing, dyeing with madder, and waterproofing of leather goods was called *rišittu* “soaking.”³⁶ The resulting product would appear to be the precursor of Cordoba leather. In ancient Mesopotamia, red was the color of divinity, and it is consequently hardly surprising to find vast quantities of this lovely luxury good being produced in temple workshops.

All very well and good, but if we are to surrender *hurātu* to the vegetable dye category, where are our words for “gall nut” and “sumac”? In my opinion, there is a promising candidate for *Rhus coriara* (sumac) in Akkadian *kamme aškappi* (literally “tanner’s *kammu*”) which CAD identifies as a “fungus,”³⁷ presumably because Uruanna II lines 363 ff. associates it with *kibiš dušû* (literally the “*dušû*-leather fungus”)³⁸ as well as with *šuḫtu* (verdigris or copper acetate).³⁹ Campbell Thompson was not open to the possibility that *kammu* might be “sumac” and suggested instead that it was “vitriol” (copper or iron sulfate).⁴⁰ Even he had some difficulty in getting all the references to fit this interpretation, quite apart from the obvious problem of having to insist that a substance of clear chemical origin is being designated as a plant; one of the varieties of *kammu* is described as “of the cultivated field” (*kamme eqli*).⁴¹

²⁸ Joannès, “Produits pour le travail,” pp. 143–44.

²⁹ See Joannès, “Produits pour le travail,” pp. 141–42.

³⁰ Also in Thureau-Dangin, *Rituels accadiens*, pp. 14 f.:21–25; see Joannès, “Produits pour le travail,” pp. 141–42.

³¹ Hassan and Hill, *Islamic Technology*, pp. 197–98.

³² Joannès, “Produits pour le travail,” pp. 142–43.

³³ Van Driel-Murray, “Leatherwork,” p. 304.

³⁴ Joannès, “Produits pour le travail,” p. 144.

³⁵ For summaries of texts recording the issue of the requisite material to the craftsmen, see P. Gentili, “Le retribuzioni all’aškāpum nei testi di Mari,” in *Donum Natalicium: Studi presentati a Claudio Saporetti*,

edited by P. Negri Scafa and P. Gentili (Rome: Borgia Editore, 2000), pp. 117–18.

³⁶ A. C. V. M. Bongenaar, *The Neo-Babylonian Ebabbar Temple at Sippar*, Publications de l’Institut historique et archéologique néerlandais de Stamboul 80 (Leiden: Nederlands historisch-archaeologisch Instituut, 1997), p. 398; cf. CAD s.v. *risittu* mngs. 1 and 3.

³⁷ CAD s.v. *kammu* A usage b (but not *AHw.* s.v. *kammu* II).

³⁸ CAD s.v. *kibšû* A mng. 1; *AHw.* s.v. *kib/pšu* II.

³⁹ CAD s.v. *šuḫtu*; *AHw.* s.v. *šuḫtu(m)*.

⁴⁰ Campbell Thompson, *Dictionary of Assyrian Botany*, pp. 168–71.

⁴¹ CAD s.v. *kammu* A usage c.

Stol⁴² follows a further suggestion of Campbell Thompson⁴³ in proposing that *kamme aškappi* is not actually vitriol but “gall black” or *qalqand*, a black dye produced by mixing gall nuts with blue vitriol (copper sulfate). This argument is based on a text describing an ox that is “black as *kammu* on copper.”⁴⁴ While Stol is probably correct that the text is referring to “gall black,” it should be noted that the black color in question was specifically produced by putting *kammu* onto copper which means that *kammu* cannot itself be “gall black” but rather the gall itself, or some equivalent source of tannin (such as sumac).

The *kamme agurri* (“baked-brick *kammu*”)⁴⁵ also presents no difficulty if *kammu* is interpreted as “sumac” (rather than “vitriol”) which even Campbell Thompson had to admit was “not, to say the least of it, plausible.”⁴⁶ When manufacturing tiles, one method of obtaining a brightly colored surface is to mix the mineral or vegetable dyes to be used into an enamel overglaze,⁴⁷ a technique which was known in Mesopotamia by the Neo-Assyrian period.⁴⁸ Surviving examples of Assyrian tile work indicate the use of white, blue, green, brown, and yellow pigments for this purpose.⁴⁹ This practice of glazing with vegetable dyes makes sense out of Uruanna’s otherwise mysterious equation of *kamme agurri* (“baked-brick *kammu*”) with *ú šišītu*.⁵⁰ *Šišītu* means “membrane, film, haze” and, in this context, “glaze.”

In view of the fact that Uruanna describes *kamme aškappi* (tanner’s *kammu*) both as a plant to be put on *dušû*-leather and as *ú šuhtu* “plant verdigris,” and that it associates *kamme gurguri* “gurgurru-craftsman’s *kammu*” with *kibiš dušī* “*dušû*-leather fungus,” it seems most reasonable to assume, as indeed one might have supposed already from the name, that “tanner’s *kammu*” is, in fact, “tanner’s sumac.” This is used in tanning, like verdigris,⁵¹ but also produces a useful black pigment when applied to copper, like gall nuts. Sumac is, of course, a field plant with many varieties of which “tanner’s sumac” is only one; moreover, it has medical uses. *Inter alia* it was recommended by Pliny for bruises, and ulcers of the rectum.⁵² For what it is worth, *kamme aškappi* was a treatment for DÚR.GIG, literally “sick peroneal region” (which includes hemorrhoids),⁵³ as well as figuring in eye⁵⁴ and ear preparations,⁵⁵ for which an astringent would be appropriate.⁵⁶

A gall is “a tumour on plant tissue caused by stimulation by fungi, insects, or bacteria”⁵⁷; gall nuts are a well-known tanning agent and thus are a very likely candidate for our mysterious “*dušû*-leather fungus.” Note also that gall nuts are, quite obviously, astringent,⁵⁸ and that verdigris has a medical use for treating external ulcers⁵⁹ which would give both of them something else in common with sumac (and a good reason for Uruanna to be putting them together in the first place).

If these attributions are correct, they suggest a meaning for the mysterious term *dušû*-leather which has so far defied attempts to define it.⁶⁰ If gall nuts and sumac are specifically associated with this type of leather and this type

⁴² Stol, “Leder(industrie),” p. 534.

⁴³ Campbell Thompson, *Dictionary of Assyrian Botany*, pp. 170–71.

⁴⁴ Reginald Campbell Thompson, *Assyrian Medical Texts* (Oxford: Oxford University Press, 1923), No. 12,4:6 = Franz Köcher, *Die babylonisch-assyrische Medizin in Texten und Untersuchungen* (henceforth *BAM*), vols. 1–6 (Berlin: Walter de Gruyter, 1963–80), No. 516 i 6.

⁴⁵ CAD s.v. *kammu* A usage g.

⁴⁶ Campbell Thompson, *Dictionary of Assyrian Botany*, p. 169.

⁴⁷ Hassan and Hill, *Islamic Technology*, pp. 170, 173–74; see Wulff, *Traditional Crafts of Persia*, pp. 160–65. Both alkaline and lead glazes are described in the Middle Assyrian glass texts and their use is confirmed by chemical analysis of tiles from Nimrud. This technique was unknown to the Greeks and was called Parthian glaze by the Romans.

⁴⁸ For references, see CAD s.v. *agurru* mng. 1e.

⁴⁹ For a discussion, see Wulff, *Traditional Crafts of Persia*, pp. 139–40.

⁵⁰ Uruanna, apud CAD s.v. *šišītu* mng. 3. This is not, as Campbell Thompson, *Dictionary of Assyrian Botany*, p. 170 thought, “grey hair” (*šipītu*).

⁵¹ Stol, “Leder(industrie),” p. 534; Van De Mierop, *Crafts*, p. 31; Wulff, *Traditional Crafts of Persia*, p. 193. Dalley, “Assyrian Textiles,” p. 124, insists that the reported use of verdigris (copper acetate) to dye early Islamic textiles is a “dubious claim” and that verdigris cannot be used as a dye on the grounds that “no method of making it soluble for dyeing is known.” Copper acetate is, however, used

in dyeing processes to this day; see Reginald Campbell Thompson, *A Dictionary of Assyrian Chemistry and Geology* (Oxford: Clarendon Press, 1936), p. 71.

⁵² Pliny, *Nat. Hist.* 24.54 apud Campbell Thompson, *Dictionary of Assyrian Botany*, p. 164.

⁵³ It is mixed with fat and used in an anal suppository for DÚR.GIG (Köcher, *BAM*, No. 1 iii 3 // CT 14 30:10’). Compare Krishnarao Mangeshrao Nadkarni, *Indian Materia Medica*, vol. 1 (Bombay: G. G. Pathare, 1957), p. 1061 (“*Rhus coriaria* ... Locally the paste mixed with charcoal powder is applied to unhealthy ulcers and suppurating piles”).

⁵⁴ It is boiled, mixed/ground with ghee, caul fat, and wax and used for sore eyes as a balm to be daubed on the eyes (Köcher, *BAM*, No. 510 i 27’–28’ // Köcher, *BAM*, No. 19:1’–6’ // Köcher, *BAM*, No. 20: 1’–6’ // Köcher, *BAM*, No. 516 iv 10–11 // Köcher, *BAM*, No. 165 iii! 9’–14’).

⁵⁵ It is blown into the ears for hearing problems; preceded by oiling the ear (Köcher, *BAM*, No. 503 iv 27–28).

⁵⁶ See Nadkarni, *Indian Materia Medica*, vol. 1, p. 1061 (“*Rhus coriaria* ... the fruit of which is a powerful astringent; also an acid and a styptic ... The drug is also used in conjunctivitis”).

⁵⁷ Wulff, *Traditional Crafts of Persia*, p. 231.

⁵⁸ See Campbell Thompson, *Dictionary of Assyrian Botany*, p. 256.

⁵⁹ Bellakhdar, *Médecine traditionnelle*, No. 35; see Nadkarni, *Indian Materia Medica*, vol. 2, pp. 52–54.

⁶⁰ Stol, “Leder(industrie),” p. 534.

alone, it follows that *dušû*, its Hebrew cognate *tahaš* and probably also Egyptian *ths*,⁶¹ were “tanned” leather. This would certainly explain why *dušû*-leather seems to have been preferred for leather boats and tent coverings where durability and resistance to water, dust, and sunshine would have been particularly important.⁶²

An interpretation of *dušû* as tanned leather would also account for the otherwise odd fact that the skin used for *dušû*-leather is never specified except in the rare cases when it happens to be from a goat.⁶³ The CAD was misled by this occasional attestation of goat leather into thinking that *dušû*-leather was only made from sheep and goats and never from bovines.⁶⁴ However, according to Wulff,⁶⁵ sheep and goat skins are, in fact, rarely tanned, a process which is usually reserved for the larger skins coming from cattle, asses, and horses and this pattern of distribution still holds today.

If, then, the same general pattern of differing treatment for large and small hides holds, it means that it would not have been necessary to specify the hide when speaking of tanned leather, since anyone in the know would have realized that when one referred to “tanned” hide, cow hide was meant unless otherwise specified (as, for example, when tanning goat skins to manufacture a *kelek*).⁶⁶ This would also allow us to understand the otherwise puzzling distinction between *dušû*-leather and *šallu*-leather.⁶⁷ *Šallu*-leather seems to include pigskin as well as sheep and goats,⁶⁸ that is, the smaller skins as opposed to the much larger cow or ass hides represented typically by *dušû*-leather.

This would also mean that a not insignificant proportion of the hides being processed in the ancient Mesopotamian leather industry would, in fact, have been tawed (or chamoised). The more utilitarian tanned leather will have been manufactured largely in the private sector, accounting for the comparative rarity of references to *dušû*-leather in temple archives and for our almost complete ignorance on the subject of its manufacture, as well as for the fact that Akkadian words for gall and sumac seem to be so elusive whereas the essentials of tawing and of producing “Cordoba” leather are omnipresent.

To imagine ancient Mesopotamian leatherwork in its original glory, a few words need to be added about the dyeing process. The undyed color of *dušû*-leather is indicated by the use of this term to describe a type of kidney stone. As it happens, uric acid crystals produce stones of a bright yellowish-orange color. Leather treated with alum and not subsequently dyed is “Hungarian” white. Madder (*hurātu*) produces “Turkey” red; *kalgukku*-clay, to judge from the name, will have produced a color on the order of carnelian (KAL.GUG). A variety of yellows were available for use, including turmeric (*kurkânû*), grape leaves, and pomegranate rinds.⁶⁹ Verdigris (copper acetate), either alone or in combination with the mysterious Ú.ĤÁB,⁷⁰ is the most likely source of the apple-green *hašmānu*-leather mentioned in the texts.⁷¹ As for black, the usual dye was IM.KÛ.SIG₁₇ (“golden earth”).⁷² This was presumably “vitriol,” specifically green vitriol or ferrous sulfate, a salt occurring naturally by the decomposition of iron pyrites (fool’s

⁶¹ See Manfred Görg, “Das Lexem *tahaš* — Herkunft und Bedeutung,” *Biblische Notizen* 109 (2001): 5–9. Stephanie Dalley, “Hebrew *tahaš*, Akkadian *dušû*, Faience and Beadwork,” *Journal of Semitic Studies* 45 (2000): 1–19, makes the interesting argument that *dušû* refers specifically to leather decorated with blue faience beads. The primary color of *dušû*-stone cannot, however, be blue since it is used to describe kidney stones. Moreover, boats for military use would hardly be made of elaborate beadwork and, as shown on Assyrian reliefs, had no awnings for which such beadwork might be appropriate (differently Dalley, “Faience and Beadwork,” pp. 14 and 16).

⁶² Stol, “Leder(industrie),” p. 534.

⁶³ Van De Mieroop, *Crafts*, p. 31, with n. 30.

⁶⁴ CAD s.v. *dušû* A.

⁶⁵ Wulff, *Traditional Crafts of Persia*, p. 231.

⁶⁶ See Marie-Christine de Graeve, *The Ships of the Ancient Near East*, *Orientalia Lovaniensia Analecta* 7 (Leuven: Departement Orientalistiek, 1981), pp. 79–80.

⁶⁷ For the latter, see CAD s.v. *šallu*.

⁶⁸ Bongenaar, *Ebabbar*, pp. 397–98.

⁶⁹ Wulff, *Traditional Crafts of Persia*, p. 191.

⁷⁰ Van De Mieroop, *Crafts*, pp. 31–32, would like to see the color produced by Ú.ĤÁB as red and interprets references to tawed leather dyed with it as “dry” (ĤÁD) and “moist?” (DURU₅). More plausibly, the dye made the leather shining (DADAG) or produced a light green

color (DURU₅); see Sigrist, “Le travail des cuirs,” p. 161. This range of colors would not be inappropriate for dyes such as *Delphinium zaili* which will produce a bright yellow if used alone with alum or light green if combined with verdigris and alum (Wulff, *Traditional Crafts of Persia*, pp. 191 and 193). Alternatively, there are two members of the buckthorn family whose berries, known in England as Persian berries, produce a brilliant green (Wulff, *Traditional Crafts of Persia*, p. 192).

⁷¹ For references, see CAD s.v. *mašku* mng. 2b-1'. Dalley, “Assyrian Textiles,” p. 124, suggests “woad” (*Isatis tinctoria*) for the coloring agent used to produce *hašmannu*-leather; this plant, however, produces an intense blue similar to that of indigo (Wulff, *Traditional Crafts of Persia*, p. 192). More plausibly, with Stol, “Leder(industrie),” p. 534, and van Soldt, “Fabrics and Dyes,” pp. 349–50, verdigris was among the dyes used to produce this apple-green color. The evidence from Isin would seem to indicate that “copper” (i.e., copper acetate or copper sulfate, both of which are quite simple to produce) was used to dye tanned (*dušû*) leather whereas tawed leather, processed with alum and alkali, was dyed yellow or green with Ú.ĤÁB (Van De Mieroop, *Crafts*, p. 31, but not his interpretation). The unusual prevalence of green at Isin by contrast with the more ubiquitous madder red may be accounted for by the fact that Gula, patroness of Isin, had netherworld connections.

⁷² Van De Mieroop, *Crafts*, pp. 30–32; cf. Steinkeller, “Mattresses,” p. 97 n. 39.

gold) by the action of atmospheric moisture, which can be yellow in its impure semi-oxidized state.⁷³ This mineral dye is used to this day to produce a black color in tanning.⁷⁴ Further discoveries and study will no doubt help to flesh out our knowledge of what already can be seen to be a multifaceted and colorful industry.

⁷³ Nadkarni, *Indian Materia Medica*, vol. 2, pp. 63–66.

⁷⁴ Bellakhdar, *Médecine traditionnelle*, no. 30.

COMPUTER ALGORITHM TO DETECT SIMILAR ADMINISTRATIVE DOCUMENTS FROM THE UR III ARCHIVES

*Marek Stepień and Jerzy Tyszkiewicz**
Institute of History, Institute of Informatics, Warsaw University

1. INTRODUCTION

Every researcher of Neo-Sumerian administrative texts faces the same fundamental difficulty: the enormous size of the corpus. This unprecedented wealth of sources concerning everyday life allows one to derive particularly precise and reliable conclusions concerning the economy, organization, and society of the Ur III state. Of course, the larger the source base of the work, the better and more significant are the results. In many cases it is really necessary to work with the entire corpus, that is, with all the documents from all the archives known to date: from Lagaš-Girsu, Nippur, Puzriš-Dagān, Umma, Ur, and others. However, this means dealing with about 60,000 published texts. It is therefore not a surprise that computers are gaining more and more importance as research tools, becoming often almost indispensable.

A significant condition which must be met to allow for a really effective application of computer methods is the standardization of all editorial practices, including transliteration standards, format of the comments, identification of the physical features of the texts, etc. Any deviations from these standards make the use of automatic search and selection tools less effective and reliable. In fact, such deviations may cause large fragments of the transliterations to appear to the computer tools almost like physically destroyed parts of the texts. A lot of effort has been invested to remedy those problems, as witnessed by the Cuneiform Digital Library Initiative (CDLI), the electronic Pennsylvania Sumerian Dictionary (ePSD), and the Electronic Text Corpus of Sumerian Literature (ETCSL) initiatives, whose important tasks are standardization and uniformization of various corpora.

The present paper has a different aim, however. Our goal is to demonstrate that computers, apart from searching and selecting the text data, can also compute results which can serve as a kind of inspiration for research. Furthermore, we base our method on a new kind of data which has been hitherto generally ignored: on the quantities (numbers and units of measure) found in the texts. Generally, the items one typically searches for are personal names, deity names, or toponyms. In most cases, these should be identified by the researcher in advance. Therefore, before starting the query, the researcher needs at least a rough idea of what the results might be and what topic the conclusion would concern. If the results suggest a new, previously unforeseen discovery, it is of course very welcome, but this would come only as a by-product of the classical, hypothesis-driven research procedure.

The method we present below is based on a massive search for documents containing identical or highly similar fragments, where similarity is understood in the sense of containing identical quantities in the same order. This approach makes the query results completely independent of any initial hypotheses or assumptions. To put it simply, the computer is not used to answer the prior questions in the scholar's mind, but to find questions which the scholar might want to answer.

We report in Section 4 the results of an initial experiment in which we ran a computer program implementing our method on the CDLI corpus, which at that time consisted of about 40,000 transliterated texts mainly from the Ur III period. Already at this early stage of the project, we can conclude that this procedure yields new results, very

* Research supported by the Polish State Committee for Scientific Research KBN grant 3 T11F 01428. Correspondence should be sent to jty@mimuw.edu.pl. We would like to acknowledge the cooperation of our students: Agata Pwałka, Wojciech Jaworski, Marek Werulik,

Dorota Litwiniuk, Patryk Rafalski, Roman Stempel, and Maciej Fijałkowski. Their work contributed to the research presented in this paper.

hard or even impossible to obtain by any classical approach. Below are summarized the main features of the method, from the perspective of the user.

1. It allows one to identify pairs of documents which concern the same, or very similar, repetitive transactions.
2. It allows one to make completely new findings, indicating possible directions of further queries to the source material, as well as to discover regular patterns in the so-far unexplored, numerical aspects of the documents.
3. In certain circumstances, due to its completely exhaustive nature, our method can yield negative conclusions, indicating lack of any evidence in the sources.
4. It is to some extent insensitive to the destroyed parts of the texts and completely insensitive to the distinctions in the transliterations, heavily affecting the usual analysis procedures.

2. THE COMPUTATIONAL APPROACH

In the area of computer science, data mining (also known as knowledge discovery in databases) has been defined as methods of extracting implicit, previously unknown, and potentially useful information from data, or as the science of extracting useful information from large data sets or databases. A subfield of data mining, called text mining (also known as intelligent text analysis, text data mining, or knowledge-discovery in text), refers generally to the process of extracting interesting and non-trivial information and knowledge from unstructured text. Our approach can be thus classified as “an application of a text-mining method to the analysis of ancient Near Eastern corpora, including Ur III texts.” The present paper presents a clustering algorithm for documents.

Again referring to the definitions from computer science, data clustering is a common technique for data analysis. It consists of partitioning a data set into subsets (clusters) so that the data in each subset share some common trait — often similarity or proximity for some defined distance measure. Simply expressed, our goal was to try to cluster together Ur III documents which relate to the same or very similar transactions.

QUANTITIES ON THE TABLETS

For the purpose of analysis, we decided to make a significant simplification of the texts. That is, we created a computer program to extract sequences of numbers and units of measure (referred to as sequences of quantities below) from the tablets. In the subsequent steps of the analysis, only these sequences were used. Below is an example of four sequences of quantities, extracted from real tablets. Each column is such a sequence. ‘X’ stands for “no unit of measure given on the tablet.”

-	40 X
-	1 X
-	60 X
-	3 X
-	40 X
3 X	3 X
30 X	30 X
1270 gur	1270 gur
84 X	84 X
40 X	40 X
10 X	10 X
1 X	1 X
20 X	20 X
10 X	10 X
1 X	1 X

10 X	10 X
4830 gur	-
20 X	-
2 X	-
40 X	-
6 X	-
20 X	-
3 X	3 X
30 X	30 X
3 X	3 X
30 X	30 X
2 X	2 X
50 X	50 X
1200 X	420 gur
100 gur	-

After extracting the sequences of quantities from the texts, we were looking for local alignments of these sequences; this is best explained by the above example. The alignment has been obtained by inserting blank spaces (indicated by minus signs), ignoring fragments at the beginning and end of the sequences, and shifting them to obtain as much agreement between the sequences as possible. We will discuss the precise method of calculating the degree of similarity below and mention here only that the following factors are taken into account: all the locations at which the quantities do agree increase the similarity (these places are set in bold), while all the locations at which the sequences do not agree or where blank spaces have been introduced decrease the similarity (normal font). Because of the latter, we chose a contiguous fragment from the aligned sequences (gray background on the illustration) to make the similarity within that fragment as high as possible. This is crucial to permit a short sequence to be highly similar to (a fragment of) a much longer one.

We see that the sequences are clearly different but demonstrate a high degree of similarity. It seems therefore reasonable to look at the full texts of the documents to see if this similarity is only a matter of accident or really indicates some relationships between the documents. An inspection immediately confirms that the texts are really related. The fragments of the texts set in bold and those with gray background correspond to the analogous fragments of the sequences. Blank lines have been removed or added in several places to indicate parallel fragments of the texts.

Example 1¹: MVN 06 359 and MVN 06 96

MVN 06 359 = ITT 4 7378 ²	MVN 06 096 = ITT 4 7097
[...]	4') 3 geme ₂ 0.0.4-ta
1') [...] KU [...]	5') uš-bar TUG ₂ -da-bur ₂ -me
2') 3 geme₂ 0.0.3-ta	6') 3 geme₂ 0.0.3-ta
3') a-ga-am-me	7') a-ga-am-me
4') še-bi 4.1.1 gur	8') še-bi 4.1.1 gur
5') ugula gal-zu-da-ri₂-si	9') ugula gal-zu-da-ri₂-si
6') 84 geme₂ 0.0.4-ta	10') 84 geme₂ 0.0.4-ta
7') 10 la₂ 1 dumu 0.0.2-ta	11') 10 la₂ 1 dumu 0.0.2-ta
8') 10 la₂ 1 dumu 0.0.1-ta	12') 10 la₂ 1 dumu 0.0.1-ta
9') še-bi 16.0.3 gur	13') š[e]-[bi ...] x
10') ugula šu- ^d nin-šubur	
11') e ₂ geme ₂ -ba	
12') 20 la ₂ 2 geme ₂ 0.0.4-ta	[...]
13') 6 dumu 0.0.2-ta	
14') uš-bar-me	1') a[d]? [...]
15') 3 geme₂-kikken 0.0.3-ta	2') 3 geme₂ kin₂ 0.0.3-ta
16') 3 a-ga-am 0.0.3-ta	3') 3 a-ga-am 0.0.3-ta
17') 2 guruš sig₇-a 0.0.5-ta	4') 2 guruš sig₇-a 0.0.5-ta
18') še-bi 4.0.0 la ₂ 0.1.4 gur	5') še-bi 4 la ₂ 1.2 gur a-ga-de ₃ ^{ki}
19') [...] e ₂ -[ga-[na-ki-na [...]	6') še-ba e ₂ -ga-na-ki-na
	7') iti ezem šu-numun
	8') [zi]-ga [...]

¹ G. Pettinato, H. Waetzoldt, F. Pomponio, *Testi economici di Lagaš del Museo di Istanbul, Parte I: La 7001–7600*, Materiali per il Vocabolario Neosumerico 6 (Rome: Bonsinori Editore, 1977), henceforth MVN.

² L. Delaporte, *Textes de l'époque d'Ur (Fouilles d'Ernest de Sarzec en 1898 et 1900)*, Inventaire des tablettes de Tello conservées au Musée Impérial Ottoman 4 (Paris, 1912), henceforth ITT.

Note the role of the blank symbols added to the sequences of quantities while creating the alignment: their positions in the sequences correspond to the destroyed sections of the tablets. They could also correspond to, say, a subtotal introduced on one of the tablets and missing on the other.

What remains is to make philological and historical analyses of both tablets, taking advantage of their discovered interrelationship. They come from Girsu-Lagaš and register the barley rations of female workers and their children. They are seriously damaged and the textual indications of their relation are only the name of Galzu-darisi (gal-zu-da-ri₂-si) and the quite common words *geme₂*, *geme₂ kikken*, *a-ga-am-me*. The sequences of quantities and their perfect agreement are the strongest evidence for the relation between the texts.

3. THE ALGORITHM

This section describes the technical aspects of the algorithm we used to cluster the documents. This algorithm, called the Smith-Waterman Algorithm, originates from the area of computational biology and is used there to cluster similar proteins or DNA sequences.³ It computes the so-called local alignment of two sequences, that is, it finds the most similar fragments of the sequences to be compared. Formally, assume that we are given the sequences of quantities extracted from two documents.

Next, we fix a similarity measure for single quantities (recall that they are of the form “a number and a unit of measure”). In our case, if no unit of measure is given in the text, an artificial unit X is used. It is important to note that each quantity could have been written in many different forms in the texts. For each such quantity q we define a number $score(q)$ describing, informally speaking, how much our subjective belief in the true relation between two documents increases when we see that two quantities q agree in the respective sequences. Of course, very frequent quantities, like “1 sila₃”, contribute much less to that belief than very infrequent ones, like “1270 gur”. It follows from theoretical considerations that a good choice is to set $score(q)$ equal to the minus logarithm of the frequency of q in the whole corpus (in our case, the CDLI corpus of Ur III administrative texts). This frequency is defined as the number of times q appears in all the texts in the corpus divided by the total number of quantities appearing there. The formula is therefore

$$score(q) = -\log(frequency(q))$$

As a matter of example, this formula gives $score(“1 sila_3”) = 4.4$ and $score(“1270 gur”) = 14$ (after suitable rounding). This scoring formula is known as inverse document frequency weight (IDF) and stems from the analysis of the process of searching large documents by keywords.⁴

Besides that, we assume two fixed values $score(mismatch)$ and $score(-)$, measuring how much our belief in the true relation between two documents decreases when we see that two quantities do not agree in the respective sequences and when one of them is a blank space. The value of the former is again suggested by the theory: it is chosen so that two randomly chosen quantities q_1 and q_2 (not necessarily different ones) on average contribute a small negative value (we used -2). Under this rule, two randomly chosen, unrelated texts from the corpus are very unlikely to contain fragments which get a high positive value, indicating their possible relationship. There is no mathematically derived formula for the value of $score(-)$ so far; we have used -5 in our computational experiments.

We proceed as follows:

1. We create their *alignment* by adding blank space symbols (-) to the sequences of quantities at certain positions, so that they become equally long. After doing that, we write them in parallel so that the elements and blanks of one sequence correspond row by row to the elements and blanks of the other sequence.

³ T. F. Smith and M. S. Waterman, “The Identification of Common Molecular Subsequences,” *Journal of Molecular Biology* 147 (1981): 195–97.

⁴ S. Robertson, “Understanding Inverse Document Frequency: On Theoretical Arguments for IDF,” *Journal of Documentation* 60 (2004): 503–20.

2. Next every row is given a *score*, which is equal to:
 - a. $score(q)$, if the quantities in that row do agree and are q ,
 - b. $score(mismatch)$, if they do not agree,
 - c. $score(-)$, if one of them is a blank.
3. Finally, we choose a contiguous section from the aligned sequences and sum the scores of the selected rows.
4. That sum is the final result.

In the above procedure several choices can be made:

1. We can add space symbols to the sequences in many ways, getting different alignments.
2. We can choose many possible contiguous fragments.

The final similarity measure is the maximal sum which can be achieved by varying the above choices. One typically augments that number by the contiguous fragments which yield that sum. Those fragments of course are the most similar ones in the considered sequences.

It is important to know one of the limitations of the algorithm: its running time is proportional to the product of the lengths of the sequences it is given to compare. This means that if the lengths of both sequences increase by a factor of 10, the time needed to complete the computation will grow roughly by a factor of 100. This is one of the reasons why we decided to work with the sequences of quantities and not the whole documents, which are likely to be ten times longer.

4. EXAMPLES OF RELATED TEXTS

The following examples have been chosen to illustrate the features of the method we used. They come from the experiment we made using about 40,000 texts from the CDLI corpus. The program implementing the algorithm whose outline has been presented above was written in the Maple programming language, and it took about seven days to complete its computation on a 2.6 GHz PC machine with 1 GB of RAM. During the computation every pair of documents which could possibly have been written in the same year was compared. There were about 100 million such pairs. The pairs presented here come from a sample of a few thousand pairs of texts for which the program reported a score of at least 50. The choice of the particular texts presented here has been made manually, with the aim of pointing out the main advantages of our algorithm. The historical and philological comments we make about the texts are quite preliminary and are not intended as in-depth analysis.

Example 2⁵: ASJ 3 (1981): 152 108 (AS.6.VIII–X) and SAT 1 276 (Š.42.XI)

ASJ 3 (1981): 152 108 (AS.6.VIII–X)	SAT 1 276 (Š.42.XI)
1) 18 $game_2$ 0.0.5 še lugal-ta	1) 18 $game_2$ 0.0.5 še lugal
2) 134 $game_2$ 0.0.3-ta	2) 134 $game_2$ 0.0.3-ta lugal
3) 5 $game_2$ $a_2 \frac{1}{2}$ 0.0.3-ta	3) 5 $game_2$ $a_2 \frac{1}{2}$ 0.0.3-ta
4) 4 $game_2$ šu-gi ₄ 0.0.2-ta	4) 4 $game_2$ šu-gi ₄ 0.0.2-ta
5) 20 la_2 1 dumu 0.0.2-ta	5) 19 dumu 0.0.2-ta
6) 25 dumu 0.0.1 5 sila ₃ -ta	6) 25 dumu 0.0.1 5 sila ₃ -ta

⁵ T. Gomi, "Neo-Sumerian Administrative Tablets in the British Museum, II," *Acta Sumerologica (Japan)* 3 (1981): 149–84; M. Sigris, *Texts from the British Museum, Sumerian Archival Texts*

1 (Bethesda: CDL Press, 1993). The year dates of both documents should be corrected.

ASJ 3 (1981): 152 108 (AS.6.VIII–X)	SAT 1 276 (Š.42.XI)
7) 41 dumu 0.0.1-ta	7) 43 dumu 0.0.1-ta
8) 1 guruš šu-gi ₄ 0.0.5	8) 1 guruš šu-gi ₄ i ₃ -du ₈ 0.0.5
9) še-bi 21.1.0 5 sila ₃ gur	9) še-bi 21.1.2 5 sila ₃ gur
10) iti 1-kam iti 3-še ₃	
11) šu+nigin ₂ 63.3.1 5 sila ₃ gur	
12) še-ba geme ₂ uš-bar	10) še-ba geme ₂ uš-bar
13) ugula ur- ^d da-mu	11) ugula ur- ^d da-mu
14) iti ezem ^d ba-u ₂ -ta	12) iti še-KIN-ku ₅
15) iti amar-a-a-si-še ₃	
16) mu ša-aš-ru-um ^{ki} ba-hul	13) mu ša-aš-ru-um ^{ki} ba-hul

The two texts from Girsu-Lagaš concern the payments of food supplies for the workers of a weaving workshop, whose foreman was Ur-Damu, during four consecutive months. The similarity of the numbers is striking, both in the numbers of workers in each of the salary groups as well as in their monthly salaries. The only difference is the number of the children in the group dumu 0.0.1-ta (i.e., 10 sila₃ each), from forty-one in ASJ 3 (1981): 152 108 to forty-three in SAT 1 276. Of course, the total in the latter document is therefore also larger. This provides an interesting case: without any doubt, the two texts together indicate the birth of two children to one or two of the female workers of that workshop. Apart from that, it is evident that the year dates of the documents need to be reconciled.

Example 3⁶: PDT 2 781 (Š.46.VI) and Lane Museum 11 (Š.46.VI)

PDT 2 781 (Š.46.VI)	Lane Museum 11 (Š.46.VI)
1) 727 u ₈	1) 727 u ₈
2) 131 kir ₁₁ gub	2) 131 kir ₁₁ ga
3) 141 udu	3) 141 udu
4) 198 sila ₄ gub	4) 198 sila ₄ ga
5) 530 ud ₅	5) 530 ud ₅
6) 37 ^{munus} aš ₂ -gar ₃ gub	6) 37 ^{munus} aš ₂ -gar ₃ ga
7) 114 maš ₂ -nita ₂	7) 114 maš ₂
8) 96 maš ₂ gub	8) 96 maš ₂ ga
1) šu-nigin ₂ 858 u ₈	9) 1974
2) šu-nigin ₂ 340 la ₂ 1 udu	10) šu-gid ₂
3) šu-nigin ₂ 567 ud ₅	11) urim ₅ ^{ki} -ta
4) šu-nigin ₂ 210 maš ₂	12) ki mi-it-ha-ar-iš-ta
5) šu-gid ₂ udu URU×A ^{ki}	13) mu-DU
6) ki mi-it-ha-ar-iš-ta	14) na-sa ₆ i ₃ -dab ₅
7) mu-DU	15) iti a ₂ -ki-ti

⁶ F. Yildiz and T. Gomi, *Die Puzriš-Dagan-Texte der Istanbul Archäologischen Museen 2: Nr. 726–1379*, Freiburger altorientalische Studien 16 (Stuttgart: Franz Steiner, 1988), henceforth PDT; for Lane Museum, see R. C. Nelson, “Pisan-dub-ba Texts from the Sumerian

Ur III Dynasty,” (Ph.D. diss., University of Minnesota, 1976), pl. 15. The year date “Š.47” for Lane Museum given in the CDLI base has been changed to agree with PDT 2 781 (Š.46).

PDT 2 781 (Š.46.VI)	Lane Museum 11 (Š.46.VI)
8) ur-ku ₃ -nun-na i ₃ -dab ₅	16) mu ki-maš ^{ki} u ₃ hu-ur/-ti ^{ki} ba-hul
9) iti aš-ki-ti	
10) mu ki-maš ^{ki} ba-hul	
lower edge) 1974	

Despite the absolutely obvious identity of the transferred animal herds, witnessed by their equal sizes in each of the species, the same purpose, and the date of the transfer, these two documents could not be related by classical, prosopographic methods. Indeed, the receivers in both documents are different (Ur-kununna and Naša), and the name of the supplier Mithariš is spelled in two different ways (mi-it-har-iš and mi-it-ha-ar-iš). The texts combined together indicate the need of correcting the date of the second document, as well as the need to reconcile the town name present on both texts. Needless to say, the documents provide the opportunity to identify certain formal relations between the acting officials.

Example 4⁷: CST 314 (AS.5.IV) and ASJ 12 (1990): 41 10 (AS.5.IV)

CST 314 (AS.5.IV)	ASJ 12 (1990): 41 10 (AS.5.IV)
	1) 1 sila ₄ a ₂ -da-a
	2) 1 sila ₄ SUHUŠ-ki-in
1) 1 *lulim munus niga	3) 1 sila ₄ ensi ₂ šurupak ^{ki}
2) 1 lulim *nita ₂	4) 1 šeg ₉ -bar-nita ₂
3) 2 lulim *nita ₂ mu 2	5) 2 šeg ₉ -bar-nita ₂ mu 2
4) 3 lulim *nita ₂ mu 1	6) 3 šeg ₉ -bar-nita ₂ mu 1
5) 12 lulim munus	7) 12 šeg ₉ -bar-munus
6) 2 lulim munus mu 1	8) 2 šeg ₉ -bar-munus mu 1
7) 2 sila ₄ a udu hur-sag niga	9) ab ₂ -ru-um-ma dab ₅ -ba
8) 2 maš ₂ -gal a *dara ₄ ! niga	10) giri ₃ hu-ba-a
9) u ₄ 30-kam	11) u ₄ 30-kam
10) ki ab-ba-sa ₆ -ga-ta *	12) mu-DU
11) lu ₂ -dingir-ra i ₃ -dab ₅	13) ab-ba-sa ₆ -ga i ₃ -dab ₅
12) iti ki-siki ^d nin-a-zu	14) iti ki-siki ^d nin-a-zu
13) mu en unu ₆ -gal ^d inanna unug ^{ki} ba-hug	15) mu en-unu ₆ -gal ^d inanna unug ^{ki} ba-hug
lower edge) 25	

The above pair of texts from Puzriš-Dagān clearly indicates the advantage of mechanical comparison of the quantities appearing on the tablets. The exact agreement of the dates of both documents and the long sequences of numbers indicating how many animals of various sex and age groups are being transferred point out that the herds transferred in the two recorded transactions are identical. However, the only prosopographic indication of this identity is the name Abbašaga, a very common one in Puzriš-Dagān, who moreover plays different roles in both documents. To make the situation even more difficult, the similarity of the sign LULIM to the compound sign ŠEG₉×BAR

⁷ T. Fish, *Catalogue of Sumerian Tablets in the John Rylands Library, Manchester* (Manchester: Manchester University Press, 1932),

henceforth CST. R. D. Biggs and R. L. Zettler, "Cuneiform Texts in Chicago Collections," *Acta Sumerologica (Japan)* 12 (1990): 15–49.

caused the transliterations to differ, hence creating an impression of two documents concerning completely unrelated topics.

Example 5⁸: MCS 2 (1952): 69 (AS.3) and STA 22 (AS.4.I)

MCS 2 (1952): 69 (AS.3)	STA 22 (AS.4.I)
	(i)
	1) $2 \frac{1}{3}$ ma-na $5 \frac{1}{3}$ gin ₂ 14 še ku ₃ -babbar
	2) si-i ₃ -tum
	3) 28.3.0 ku ₆ šeg ₆ gur
	4) ku ₃ -bi 14 gin ₂ igi-6-gal ₂ 25 še
	5) ku ₆ gana ₂ -mah
	6) ki ur-e ₁₁ -e-ta
	7) $3 \frac{1}{3}$ gin ₂ ku ₃ gig
	8) ki ka-tar u ₃ lu ₂ - ^d inanna-ta
	(blank space)
	9) šu-nigin ₂ $2 \frac{2}{3}$ ma-na 3 gin ₂ 8 še ku ₃ -babbar
	(blank line)
	10) sag nig ₂ -ga-ra-kam
	11) ša ₃ -bi-ta
	(ii)
1) 0.1.5 5 sila ₃ ^{giš} peš ₃ had ₂	1) 0.1.5 5 sila ₃ ^{giš} peš ₃ had ₂
2) ^{giš} peš ₃ še-er-gu-bi $38 \frac{1}{3}$	2) ^{giš} peš ₃ še-er-gu-bi $38 \frac{1}{3}$
3) 18 ^{giš} peš ₃ še-er-gu	3) 18 ^{giš} hašhur še-er-gu
4) ku ₃ -bi $4 \frac{1}{3}$ gin ₂	4) ku ₃ -bi $4 \frac{1}{3}$ gin ₂
5) 0.1.1 1 $*\frac{2}{3}$ sila ₃ *geštin had ₂	5) 0.1.1 1 $\frac{2}{3}$ sila ₃ geštin had ₂
6) ku ₃ -bi 2 gin ₂	6) ku ₃ -bi 2 gin ₂
7) $2 \frac{1}{2}$ sila ₃ la ₃	7) $2 \frac{1}{2}$ sila ₃ la ₃
8) ku ₃ -bi $1 \frac{1}{2}$ gin ₂	8) ku ₃ -bi $1 \frac{1}{2}$ gin ₂
9) 3 gu ₂ 45 ma-na im-bar ₆ -*bar ₆	9) 3 gu ₂ 45 ma-na im-bar ₆ -bar ₆
10) ku ₃ -bi *igi-4-gal ₂	10) ku ₃ -bi igi-4-gal ₂
11) nig ₂ -dab ₅ du ₆ ku ₃ -*ga	11) nig ₂ -dab ₅ du ₆ -ku ₃ -ga
12) ki ur- ^d dumu-zi-da-ta	12) $1 \frac{1}{2}$ gin ₂ ku ₃ -babbar
13) kišib lugal-nig ₂ -lagar-e	13) nig ₂ -sam ₂ -ma nidba / u ₃ nesag ₂ ^d en-lil ₂ -la ₂ /
14) ur- ^d šul-pa-e ₃ šu ba-ti	mu us ₂ -sa ku ₃ gu-za ^d en-lil ₂ -la ₂ ba-dim ₂
15) mu ku ₃ gu-za ^d en-lil ₂ -*la ₂ ba-dim ₂	16) kišib lugal-nig ₂ -lagar-e
	17) $\frac{1}{2}$ ma-na bappir ₂
	18) ku ₃ -bi 15 še

⁸ T. Fish, "Miscellany — Ur III," *Manchester Cuneiform Studies* 2 (1952): 69–76, henceforth MCS. E. Chiera, *Selected Temple Accounts from Telloh, Yokha and Drehem*, Cuneiform Tablets in the Library of

Princeton University (Princeton: Princeton University Press, 1922), henceforth STA.

MCS 2 (1952): 69 (AS.3)	STA 22 (AS.4.I)
	19) 10 gin ₂ gi
	20) ku ₃ -bi 1 ½ še
	21) 3 sila ₃ šim-gana ₂
	22) ku ₃ -bi igi-6-gal ₂ 6 še
	23) 5 sila ₃ šim-gam-gam-ma
	24) ku ₃ -bi 18 še
	25) 4 sila ₃ gu ₄ -KU-ru
	26) ku ₃ -bi 12 še
	(upper edge) 10 gin ₂ 7 ½ še
	(rev. iii)
	1) 2 ma-na šim-H[1]
	2) ku ₃ -bi 18 še
	3) 2 ma-na šim-IM
	4) ku ₃ -bi 18 še
	5) 0.1.5 esir ₂ e ₂ -a
	6) ku ₃ -bi 1 gin ₂ igi-6-gal ₂ 10 še
	7) 1.3.3 4 sila ₃ i ₃ -šah ₂ gur
	8) ku ₃ -bi ⅔ ma-na la ₂ 4 še
	9) kišib ur- ^d šul-pa-e ₃
	10) 2.0.3 esir ₂ e ₂ -a gur
	11) ku ₃ -bi 7 ⅔ gin ₂
	12) kišib nig ₂ -lagar-e
	13) 6 gu ₂ im-bar ₆ -bar ₆
	14) ku ₃ -bi ⅓ gin ₂
	15) kišib i ₃ -kal-la
	16) 7 ⅔ ma-na 5 gin ₂ [urud]u?
	17) ku ₃ -bi 4 ½ gin ₂ 26 še
	18) 2 ½ ma-na su-GAN
	19) ku ₃ -bi 1 gin ₂ igi-4-gal ₂
	20) kišib lu ₂ -den-lil ₂ -la ₂
	21) 20 ma-na im-bar ₆ -bar ₆
	22) ku ₃ -bi 1 še
	23) kišib i ₃ -kal-la
	24) ½ ma-na ku ₃ -babbar
	25) lu ₂ -kal-la šu ba-ti
	26) giri ₃ ur- ^d šul-pa-e ₃ ku ₃ -dim ₂
	27) kišib nu-ra-a
	28) ⅔ ma-na sam ₂ ^{am₃} ku ₃ -sig ₁₇ -še ₃

MCS 2 (1952): 69 (AS.3)	STA 22 (AS.4.I)
	(rev. iv)
	1) ur- ^d dumu-zi-da
	2) šu ba-ti
	(blank space)
	3) šu-nigin ₂ 2 $\frac{1}{3}$ ma-na 5 $\frac{1}{3}$ gin ₂ 2 $\frac{1}{2}$ še ku ₃ -babbar
	4) zi-ga-am ₃
	5) la ₂ -NI 17 $\frac{2}{3}$ gin ₂ 5 $\frac{1}{2}$ še ku ₃ -babbar
	(blank space)
	6) nig ₂ -kas ₇ ak ur- ^d dumu-zi-da dam-gar ₃
	7) iti še-KIN-ku ₅
	8) mu us ₂ -sa ku ₃ gu-za ^d en-lil ₂ -la ₂ ba-dim ₂

The two above texts from Umma are quite typical examples of pairs related by highly similar sequences of quantities, where one of the documents is parallel to a fragment of the other one. MCS 2 (1952): 69 (AS.3) is a list of transfers out of the account of Ur-Dumuzida and was sealed by Lugal-niglagare who received the listed goods. That very transfer was later on reported in the balanced account STA 22 of the latter merchant, written at the beginning of the next year. Most likely MCS 2 (1952): 69 itself or a copy of it was used as a source while creating that balanced account. The known relationship between the two texts can help in determining the official relations between Ur-Dumuzida, Lugal-niglagare, and Ur-Šulpae. Of course, the presence of those names allows for identifying the texts by prosopographic means in this case.

Example 6⁹: TCL 5 AO 5671 (Š.45.I–Š.46.IV) and TCL 5 AO 5667 (Š.45.I–Š.46.IV) and TJA IOS 46 (Š.46)

Because of the size of the texts, we decided to remove their unnecessary parts, indicating this by the formula (TEXT OMITTED). The identification of columns of TCL 5 AO 5671 (Š.45.I–Š.46.IV) is retained, so that the fragments presented can easily be located in the whole documents. Because only the parallel sections of the documents are presented, we do not indicate them by gray background.

ZT 2177 ¹⁰ = TJA IOS 46 (pl. 60) (Š.46/m00) (UMy2)~	TCL 5 AO 5671 (Š.45–Š.46) (UMy1)~
	(iii)
1) 2 gu ₄ niga	1) 2 gu ₄ ur-e ₁₁ -e
2) ur-e ₁₁ -e	
3) 1 gu ₄ niga ur- ^d šul-pa-e ₃	2) 1 gu ₄ ur- ^d šul-pa-e ₃
4) 1 gu ₄ niga da-a-ga	3) 1 gu ₄ da-a-ga
5) 1 gu ₄ niga inim- ^d inanna	4) 1 gu ₄ inim- ^d inanna
6) 1 gu ₄ niga lugal-e ₂ -mah-e	5) 1 gu ₄ e ₂ ^d nin-ur ₄ -ra
7) 1 gu ₄ niga lugal-bad ₃	6) 1 gu ₄ lugal-bad ₃
8) 1 gu ₄ niga lugal-ku ₃ -ga-ni	7) 1 gu ₄ lugal-ku ₃ -ga-ni

⁹ H. de Genouillac, *Textes économiques d'Oumma de l'époque d'Our*, Textes Cunéiformes – Musée du Louvre 5 (Paris: P. Geuthner, 1922), henceforth TCL. E. Szlechter, *Tablettes juridiques et administratives de la III^e dynastie d'Ur et de la I^{re} dynastie de Babylone* (Paris: Recueil Sirey, 1963), henceforth TJA.

¹⁰ M. Sigrist, *Ur III—Texte, verstreute Publikationen aus Zeitschriften*, vol. 3 (Berlin: 1986).

ZT 2177 = TJA IOS 46 (pl. 60) (Š.46/m00) (UMy2)~	TCL 5 AO 5671 (Š.45–Š.46) (UMy1)~
(blank line)	(blank line)
9) ki ur-e ₁₁ -e-t[a]	8) ša ₃ a-pi ₄ -sal ^{ki}
10) giri ₃ lu ₂ - ^{du} tu gu[du ₄]	
11) 1 gu ₄ u ₂ lu ₂ -du ₁₀ -[ga]	9) 1 gu ₄ lu ₂ -du ₁₀ -ga
12) 1 gu ₄ niga ur- ^d en-lil ₂ -[la ₂]	10) 1 gu ₄ ur- ^d en-lil ₂ -la ₂
13) 1 gu ₄ niga a-ab-ba	11) 1 gu ₄ a-ab-ba
14) 1 gu ₄ u ₂ ur- ^d šara ₂	12) 1 gu ₄ ur- ^d šara ₂ gudu ₄ anzu ₂ ^{mušen} bar ₆ -bar ₆
15) 1 gu ₄ niga lugal-ukkin-ne ₂	13) 1 gu ₄ lugal-unkin-ne ₂
16) gu ₂ -eden-na-ta	14) ša ₃ gu ₂ -de ₃ -na
(TEXT OMITTED)	(TEXT OMITTED)
TCL 5 AO 5667 (Š.45–Š.46) (UMy1)~	
	(rev. iv)
1) 77 gu ₄ niga 1 gu ₄ mu 2 niga	7) 77 gu ₄ niga
	8) 1 gu ₄ mu 2 niga
2) 2 gu ₄ mu 2 u ₂ 21 ab ₂ mu 2 niga	9) 2 gu ₄ mu 2 u ₂
	10) 21 ab ₂ mu 2 niga
3) 36 gu ₄ u ₂ 6 ab ₂ mu 2 u ₂	11) 36 gu ₄ u ₂
	12) 6 ab ₂ mu 2 u ₂
4) 4 gu ₄ amar ga	13) 4 gu ₄ amar ga
5) zi-ga bal-a	14) zi-ga bal-a
6) 12 gu ₄ sa ₂ -du ₁₁ ^d šara ₂	15) 12 gu ₄ sa ₂ -du ₁₁ ^d šara ₂
7) 6 gu ₄ nig ₂ -giš-tag-ga lugal	16) 6 gu ₄ nig ₂ -giš-tag-ga lugal
8) 2 gu ₄ ^d šul-gi e ₂ gibil-na ku ₄ -ra	17) 2 gu ₄ ^d šul-gi e ₂ gibil-na ku ₄ -ra
9) 1 gu ₄ niga 1 gu ₄ u ₂ ba-uš ₂	18) 1 gu ₄ niga
	19) 1 gu ₄ ba-uš ₂
10) gišbun _x (=KI.BI) ^d šul-gi-ra	20) gišbun _x (=KI.BI) ^d šul-gi-ra
11) 1 gu ₄ gišbun _x (=KI.BI) ^d šul-gi KI.AN ^{ki}	21) 1 gu ₄ gišbun _x (=KI.BI) ^d šul-gi KI.AN ^{ki}
12) 4 gu ₄ niga maš ₂ -da-ri ₆ -a lugal a-ra ₂ 2-kam	22) 4 gu ₄ maš ₂ -da-ri ₆ -a
	23) a-ra ₂ 2-kam
	(rev. v)
13) 5 šu gu ₄	1) 5 šu gu ₄
14) kaš-de ₂ -a lugal	2) kaš-de ₂ -a lugal
15) 6 gu ₄ ba-uš ₂	3) 6 gu ₄ ba-uš ₂
16) kišib ensi ₂ -ka	4) kišib ensi ₂ -ka
17) 4 gu ₄ ba-uš ₂	5) 4 gu ₄ ba-uš ₂
18) kišib da-da-ga	6) kišib da-da-ga
(blank line)	(blank space)

ZT 2177 = TJA IOS 46 (pl. 60) (Š.46/m00) (UMy2)~	TCL 5 AO 5671 (Š.45-Š.46) (UMy1)~
19) mu ur-bi ₂ -lum ^{ki} ba-hul (Š.45)	7) mu ur-bi ₂ -lum ^{ki} ba-hul (Š.45)
	(rev. v)
20) 90 la ₂ 1 gu ₄ niga	8) 90 la ₂ 1 gu ₄ niga
21) 27 ab ₂ mu 2 niga	9) 27 ab ₂ mu 2 niga
22) 7 gu ₄ mu 2 niga	10) 7 gu ₄ mu 2 niga
23) 26 gu ₄ u ₂	11) 26 gu ₄ u ₂
-	
1) 2 ab ₂ mu 2 u ₂	12) 2 ab ₂ mu 2 u ₂
2) 2 gu ₄ mu 2 u ₂	13) 2 gu ₄ mu 2 u ₂
3) 4 gu ₄ amar ga	14) 4 gu ₄ amar ga
4) zi-ga bal-a	15) zi-ga bal!
5) 1 gu ₄ sa ₂ -du ₁₁ dšara ₂	16) 1 gu ₄ sa ₂ -du ₁₁ dšara ₂
6) 1 gu ₄ nig ₂ -giš-tag-ga lugal	17) 1 gu ₄ nig ₂ -giš-tag-ga lugal
7) ezem še-KIN-ku ₅	18) ezem še ur ₄ -ra
8) 4 gu ₄ sa ₂ -du ₁₁ dšara ₂	19) 4 gu ₄ sa ₂ -du ₁₁ dšara ₂
9) 2 gu ₄ nig ₂ -giš-<tag>-ga lugal	20) 2 gu ₄ nig ₂ -giš-tag-ga lugal
10) ezem nesag ₂	21) ezem nesag ₂
11) 2 gu ₄ niga maš ₂ -da-ri ₆ -a lugal	22) 2 gu ₄ niga maš-da-ri ₆ -a lugal
12) ezem še-KIN-ku ₅	23) ezem še-KIN-ku ₅
	(rev. vi)
13) bar-ta gal ₂ -la	1) bar!-ta! gal ₂ -la
14) 5 gu ₄ kišib ab-ba-gi-na	2) 5 gu ₄ kišib ab-ba-gi-na
15) 1 gu ₄ gišbun _x (=KI.BI) dšul-gi KI.AN ^{ki}	3) 1 gu ₄ gišbun _x (=KI.BI) dšul-gi KI.AN ^{ki}
mu en d ⁿ nanna maš ₂ -e i ₃ -pa ₃ (Š.43)	4) mu en d ⁿ nanna (Š.43)
16) giri ₃ lu ₂ -d ^s uen	5) giri ₃ lu ₂ -d ^s uen-ka
(blank line)	(blank line)
17) mu us ₂ -sa ur-bi ₂ -lum ^{ki} ba-hul (Š.46)	6) mu us ₂ -sa ur-bi ₂ -lum ^{ki} ba-hul (Š.46)
	(blank line)
	7) šu-nigin ₂ 362 gu ₄ ab ₂ hi-a
18) zi-ga ša ₃ -bi <su>-ga nigin ₃ -gar-ki-du ₁₀	8) zi-ga-am ₃
sipa gu ₄ niga	9) la ₂ -NI 13 gu ₄ hi-a
	10) nig ₂ -kas ₇ ak gu ₄
	11) nigin ₃ -gar-ki-du ₁₀
	12) dumu lugal-sig ₅
19) iti 16-kam iti še-KIN-ku ₅	13) iti 16-kam
mu ur-<bi ₂ >-lum ^{ki} ba-hul-ta (Š.45)	14) iti še-KIN-ku ₅ mu ur-bi ₂ -lum ^{ki} ba-hul-ta (Š.45)
20) iti nesag ₂ mu us ₂ -sa ur-bi ₂ -lum ^{ki}	15) iti nesag ₂ mu us ₂ -sa ur-bi ₂ -lum ^{ki} ba-hul-še ₃ (Š.46)
ba-hul-še ₃ (Š.46)	

The above three texts from Umma consist of a balanced account TCL 5 AO 5671 of Nigingarkidu, son of Lugal-sig (nig₂-kas₇-ak gu₄ niga nigin₃-gar-ki-du₁₀ dumu lugal-sig₅), for sixteen consecutive months from Š.45.I to Š.46.IV. Its parts are parallel to the complete document TCL 5 AO 5667, which is his account of expenditures for the same period, and to a part of TJA IOS 46, which is his account of receipt for the year Š.46. Most likely, the latter two documents or copies of them were used as sources by the scribe who wrote the first one.

This example is a special one: indeed the correlations between these documents have been determined manually by one of us (Stępień).

The pair of TCL 5 AO 5671 and TCL 5 AO 5667 has been an inspiration for the method of comparing sequences of quantities to establish relations between documents. One can easily see that these sequences are identical, but the actual texts differ significantly, mainly in the way they are organized into lines. And, as expected, the algorithm indeed indicates a high degree of similarity between those two documents.

The pair of TCL 5 AO 5671 and TJA IOS 46 is one which cannot so far be found by our algorithm. The reason is that the sequences of quantities of both parallel fragments are multiple repetitions of “1 X,” a very common quantity. There are literally thousands of other documents whose sequences of quantities look exactly the same. In a sense, this pair is a needle in a haystack of other pairs, which all look exactly the same to the algorithm, even though they have nothing to do with each other. This indicates a limitation of the power of our method.

5. FURTHER PLANS

We plan to publish the pairs of documents which have been found in the course of our computational experiment. Our further research plans include:

1. Analysis and improvements to the score function.
 - a. The negative score in case of quantities which are distinct, but might be results of a misinterpretation, such as “1 X” vs. “60 X,” can be turned into a very small negative amount, thus allowing the algorithm to overcome some of the mistakes made by the transliterators.
 - b. We consider adding to the sequences of quantities wildcard symbols, each indicating that the number at this position was unreadable. Then the score of a mismatch between a quantity and a wildcard would be 0 rather than -5 , as it is now (because there are no wildcards in the sequences, they have to be substituted by space symbol each time). This should increase the computed degree of similarity between related but partially destroyed texts.
2. Analysis of the relation between the score of two fragments of texts and their lengths, which justifies manual analysis. There is a theory developed in computational biology for this, but it applies to sequences created by random processes found in the evolution of life. However, it is hard to imagine that it applies to documents created according to the rules of bookkeeping, too.
3. Improvements to the scripts which extract quantities from the texts. As we have noted, the scribes often assumed units of measure to be obvious and did not write them down. At present, this is a serious problem. For example, if one scribe did write them down, and another did not, the sequences of quantities resulting from two such documents seem completely unrelated to the algorithm. Our idea is to create scripts which would be able to deduce units of measure from the context. This seems difficult, however.

KADP 36: INVENTORY, PLANT LIST, OR LEXICAL EXERCISE*

Jan Tavernier, Leuven

1. INTRODUCTION

One of the most peculiar texts found in Mesopotamia is undoubtedly the so-called Neo-Assyrian Pharmaceutical Inventory (VAT 8903 = KADP 36),¹ also called “Apotheker-Inventar,”² “das Drogen-Inventar aus Assur,” and “Apothecary’s shelf-list.”³ The text originates from Assur.⁴ It may look like a simple list at first glance, but, as will become clear, a thorough study of this text is desired and needed, not least because of the simple facts that it is a text without parallel⁵ and that it touches upon the very definition of “inventory.”

A philological edition and study of this text is being prepared by Barbara Böck, who is revising Franz Köcher’s unpublished manuscript. The intention of this article is rather to present some notes on the character and function of this text.

2. DESCRIPTION OF THE VARIOUS SECTIONS

The tablet is quite well preserved and lists various medicinal plants. It is divided into six columns and contains thirteen sections, the ends of which do not necessarily coincide with the end of the columns.⁶

Most of the sections contain medicinal plants, most of which are unfortunately not (yet) identified while some others have been identified with modern plants. It should be noted, however, that some of these identifications are anything but certain and should therefore not be taken for granted.⁷ Examples are hound’s-tongue (*Cynoglossum officinale*, *lišān kalbi*; i 7),⁸ licorice (*Glycyrrhiza glabra*, *šūšu*; i 10),⁹ white hellebore (*Veratrum album*, *atā ’išu*; i 14), meadow saffron (*Colchicum autumnale*, *kamkadu*; i 19), tamarisk (*Tamarix orientalis*, *bīnu*; i 33),¹⁰ mandrake (*Mandragora officinalis*, *pillû*; i 37), boxthorn (*Lycium depressum*, *šimaḥu*; ii 39),¹¹ saffron crocus (*Crocus sativus*, *azupirānu*; iii 2), common juniper (*Juniperus communis*, *burāšu*; iii 7),¹² chufa (*Cyperus esculentus*, *suādu*, iv 31), caper (*Capparis spinosa*, *baltu*; iv 42), cedar (*Cedrus libani*, *erēnu*; iv 26),¹³ cypress (*Cupressus sempervirens* and

* I wish to offer my sincere thanks to Barbara Böck (Instituto de Filología, Consejo Superior de Investigaciones Científicas, Madrid) and to M. J. Geller (University College London) for their helpful comments on this paper.

¹ F. Köcher, *Keilschrifttexte zur assyrisch-babylonischen Drogen- und Pflanzenkunde: Texte der Serien uru.an.na: maltakal, ḤAR.ra: ḥubullu und Ú GAR-šú*, Deutsche Akademie der Wissenschaften zu Berlin, Institut für Orientforschung, Veröffentlichungen Nr. 28 (Berlin: Akademie-Verlag, 1955), No. 36, henceforth KADP 36.

² D. O. Edzard and K. Veenhof, “Inventare,” in *Reallexikon der Assyriologie* 5 (Berlin: Walter de Gruyter, 1976–80), p. 139.

³ J. Kinnier Wilson, “Notes on the Assyrian Pharmaceutical Series URU. AN.NA: *maštakal*,” *Journal of Near Eastern Studies* 64 (2005): 45.

⁴ D. Goltz, “Mitteilungen über ein assyrisches Apothekerinventar,” *Archives internationales d’histoire des sciences* 21 (1968): 97.

⁵ E. Reiner, review of F. Köcher, *Keilschrifttexte zur assyrisch-babylonischen Drogen- und Pflanzenkunde*, in *Bibliotheca Orientalis* 15 (1958): 102.

⁶ Goltz, “Apothekerinventar,” p. 97.

⁷ Sometimes identifications are accepted because of cognates in related languages. A good example is *suādu* “chufa” (CAD s.v. *suādu*). This meaning is based on Syriac *su ‘dā*, Arabic *su ‘d*, both meaning “chufa.” Nevertheless, it is possible that the Syriac and Arabic equivalents designate a plant other than does the Akkadian word, due to a shift of meaning.

⁸ *AHw.* s.v. *lišān kalbi*.

⁹ CAD s.v. *šūšu*.

¹⁰ CAD s.v. *bīnu A*.

¹¹ CAD s.v. *šimaḥu*.

¹² B. Landsberger apud W. von Soden, “Bemerkungen zu den von Ebeling in ‘Tod und Leben’ Band I bearbeiteten Texten,” *Zeitschrift für Assyriologie* 43 (1936): 260.

¹³ CAD s.v. *erēnu*.

Cupressus horizontalis, *šurmēnu*, iv 27),¹⁴ juniper (*Juniperus drupacea*, *duprānu*; iv 28), and cumin (*Cuminum cyminum*, *kamūnu*; v 28).

Besides medicinal plants and trees there are other materials mentioned. The sixth section has only one plant, along with minerals such as alum, sulphur, gypsum, some salts, and perhaps some mineral substances such as oven slag and soot from a cooking pot.¹⁵ The eleventh section is remarkable, since it lists carriers, that is, means by which the medication is administered to the patient, such as butter, honey, etc. Finally, the last section is a list of medicinal preparations: powders, suppositories, bandages, potions, etc.

3. SOME ASPECTS OF KADP 36

3.1. THE COMPLETENESS OF THE TEXT

One of the relatively conspicuous aspects of the text is the fact that some plants are included twice, while others, very frequently used in Babylonian medicine, are not included at all.¹⁶ The names of the plants included twice are either synonyms or the Sumerian and Akkadian writings for the plant name. Examples are ^Uazupiranu / ^UHUR.SAG (iii 2 and v 24), ^Ušašumtu / ^UPI.ZIR (i 6 and iv 21), ^Ukamkadu / *šurnû* (i 19 and ii 15), and ^Ukurkânû / ^UKUR.GI.RIN (iv 40 and v 25) which are most probably synonyms.¹⁷ Among plants that are surprisingly not included in this text are *ankinutu*, *nurmû*, and *tijatu*.¹⁸

Not only are the sections with only plant listing incomplete, but sections 6, 11, and 13 are also incomplete. In section 6 some very important minerals are not mentioned, for example, *mil'û* and the *mûšu*-stone. The section on the carriers lacks some of the most frequently used ones, such as oils, beer, and wine. Possible explanations for this lack may be that these products were available at all times in any house and/or that some of the unmentioned products could not be stored because of their short storage life.¹⁹ The last section of the text will be discussed below (part 4).

It can thus be asserted that we are dealing here with an embarrassingly incomplete inventory or list. Possible reasons for the incompleteness of this inventory are (1) a classification system we do not recognize which excludes certain plants or (2) inaccuracy of the scribe.

¹⁴ CAD s.v. *šurmēnu*.

¹⁵ Reiner, in her review of Köcher, *Keilschrifttexte zur assyrisch-babylonischen Drogen- und Pflanzenkunde*, describes *ḥahû ša utūni* ("oven slag," iii 37) and *ummanu ša diqāri* ("soot from the cooking pot," iii 38) as magic preparations because they are used against witches in incantations (e.g., Maqlu III 116). Yet they occur also in normal medical texts and probably represent minerals, not necessarily magical preparations.

¹⁶ Goltz, "Apothekerinventar," p. 104–05.

¹⁷ See R. Campbell Thompson, *A Dictionary of Assyrian Botany* (London: British Academy, 1949), p. 164. Goltz, "Apothekerinventar," p. 105 n. 34, adds some examples of plants occurring more than once in the text, but two of these should be discarded: First, the logogram ^UAŠ occurs twice in the text (iii 16 and v 23) but may refer to more than one plant: *ēdu* (B. Landsberger, "Zu den Übersetzungen Ebeling's ZDMG. 74, 175 ff.," *Zeitschrift der Deutschen Morgenländischen Gesellschaft* 74 [1920]: 443–44; Campbell Thompson, *Dictionary of Assyrian Botany*, p. 356; *AHW*. s.v. (w)ēdû(m); CAD s.v. *ēdu*) and *nukkatu* (as shown by Hh. XVII 148; see M. Civil and E. Reiner, *The Series HAR-ra = ḫubullu Tablets XVI, XVII, XIX, Materials for the Sumerian Lexicon 10* [Rome: Pontificium Institutum Biblicum, 1970], pp. 88). In all likelihood KADP 36 includes both plants and the fact that medical texts often mention the seed of the *ēdu*-plant, while *nukkatu* is mentioned in only one medical text (besides some attestations in lexical lists; cf. CAD s.v. *nukkatu*), suggests that the first passage refers to the *ēdu*-plant, while the second one refers to the *nukkatu*-plant. Second, Goltz confuses the two plants

named *kamūnu* in Akkadian (a kind of mushroom, iv 8–9, and cumin, v 28).

A special case is *elkulla*. If *elkulla* and *elikulla* denote the same plant, this would be another example of a plant mentioned more than once. Nevertheless, there is no unanimity among scholars on this issue. Both spellings, together with *irkulla*, are often mentioned together (R. Campbell Thompson, *Assyrian Medical Texts* [London: Oxford University Press, 1923], No. 88, 1:3 [henceforth AMT], ^Uelikul-la and ^Uir-kul-la; AMT 89,1:1, ^Uir-kul-la and ^Uel-kul-la; L. King, *Babylonian Magic and Sorcery Being "The Prayers of the Lifting of the Hand": The Cuneiform Texts of a Group of Babylonian and Assyrian Incantations and Magical Formulae Edited with Transliterations, Translations and Full Vocabulary from Tablets of the Kuyunjik Collections Preserved in the British Museum* (London: Luzac & Co., 1896), 12:101 [henceforth BMS], ^Uir-kul-la and ^Ueli-kul-la; F. Köcher, *Die babylonisch-assyrische Medizin in Texten und Untersuchungen*, vol. 3 [Berlin: Walter de Gruyter, 1963] 311 rev. 31 [henceforth Köcher, *BAM*], ^Uir-kul-la and ^Uel-kul-la), on the basis of which some authors believe that it is one plant, mentioned in two variant spellings, as if it were two different plants (*AHW*. s.v. *elkulla* and CAD s.v. *elkulla*). Others (Campbell Thompson, *Dictionary of Assyrian Botany*, pp. 237–38, B. Böck, personal communication 23/09/05) assume that *elkulla* and *elikulla* are different plants.

¹⁸ According to Goltz, "Apothekerinventar," p. 104, the *maštakal*-plant is not mentioned in the text. This is, however, wrong, since the plant is clearly attested in i 16 (^UINA.ŪŠ).

¹⁹ Goltz, "Apothekerinventar," p. 103.

3.2. INTERNAL CLASSIFICATION SYSTEM

Modern inventories are usually designed following some classification system, that is, an internal system according to which the articles and items are arranged in a specific order. Mesopotamian inventories are not an exception to this rule: for example, metals often are listed beginning with the most valuable and ending with the least valuable. Yet not all ancient inventories have a system that is recognizable for modern scholars. In such cases the researcher may assume the existence of such a system but is not capable of perceiving it.

The quest for such a system in this text is hampered by the uncertainty regarding the correct identification of many of the plants. For that reason it is difficult to look for classifications based on any physical aspect (color, size, height, etc.) of the plants. Nevertheless, the order of the identified plants does not tend to reveal such a classification system. Furthermore, the arrangement of KADP 36 does not correspond to any other known Mesopotamian plant list.²⁰

Other possible classification systems do not help either. The plants are certainly not arranged according to their medicinal purposes, that is, according to the diseases against which they were used or to the ways they were used (e.g., externally or internally, as a powder or in a bandage, etc.). The shape of the cuneiform wedges is no criterion either. Aromatic plants and non-aromatic plants appear next to each other, woods and seeds of plants are not separated.²¹ The fact that there are twelve sections containing plants and twelve categories of medication in section 13 is probably pure coincidence. The plants could be classified according to their importance in medicine, but that, too, is improbable, since some of the plants that appear only late in the text are among the most important ones in Mesopotamian medicine (e.g., cedar, cypress, myrrh, etc.).

Despite the fact that at first sight the text does not seem to be constructed according to some internal system,²² one should not simply conclude that KADP 36 is a master example of a chaotic list. For example, the scribe did know some usual groupings of plants and thereby proves his botanical or literary knowledge. Examples are:

- (1) *Sihu*, *arganu*, *barīrātu* (i 2–4) are listed in the same order in other texts (e.g., AMT 22,2:11; Köcher, *BAM* 168:7–8; Finkel, “Medical Training,” p. 186, No. 28 obv. i 16–18 [Late Babylonian];²³ KADP 11 i 16–25 [listed in one section]; O. R. Gurney and B. Landsberger, “Practical Vocabulary of Assur,” *Archiv für Orientforschung* 18 (1957–58): 328 ff.:105–07 [listed in adjacent lines]).²⁴ This combination is also attested in a Middle Assyrian text (W. G. Lambert, “A Middle Assyrian Medical Text,” *Iraq* 31 [1969]: 29:22).
- (2) The combination of *šašumtu*, *lišān kalbi*, *šadanu* (i 6–8), and *alamu* (i 12) occurs in AMT 22,2:14–15. It also has a parallel in C. H. W. Johns, *Assyrian Deeds and Documents* (London: Deighton and Bell, 1901–24), No. 1042, where the sequence is *šašumtu*, *šadanu*, *lišān kalbi*, and *alamu* close behind.
- (3) *Maštakal* and *sikillu* (i 16–17) are sometimes mentioned together, for example, CT 38 29:47.²⁵
- (4) *Kamkadu* and *kammantu* (i 19–20) frequently occur together:²⁶ Köcher, *BAM* 124 ii 16, 158 i 25, 173:21, 311:47’.
- (5) *Tarmuš*, *imhur-līme*, and *imhur-ešrā* (iii 3–5): also in AMT 42,5:6; Köcher, *BAM* 255:1–3; Finkel, “Medical Training,” p. 186 No. 28 obv. i 1–3; Köcher, *BAM* 311 rev. 31; F. Kuchler, *Beiträge zur Kenntnis der assyrisch-babylonischen Medizin*, *Assyriologische Bibliothek* 18 (Leipzig: J. C. Hinrichs, 1904), pl. 11 iii 52; Gurney and Landsberger “Practical Vocabulary Assur,” lines 95–97; R. Labat, “Ordonnances médicales ou magiques,” *Revue d’Assyriologie* 54 (1960): 171 (AO 17618:1–3); *ibid.*, 172 (AO 17615:1–3); and *ibid.*, 172 (AO 17624:1–3). This group is frequently mentioned in the very beginning of lists. The groups 5 and 6 twice follow each other (Köcher, *BAM* 255:1–5; KADP 36 iii 3–7).

²⁰ Goltz, “Apothekerinventar,” p. 106 n. 35.

²¹ Goltz, “Apothekerinventar,” p. 106.

²² Goltz, “Apothekerinventar,” p. 107.

²³ These groupings survived in Late Babylonian medicine (e.g., *erēnu*, *šurmēnu*, and *asu* in H. Hunger, *Spätbabylonische Texte aus Uruk* 1, *Ausgrabungen der Deutschen Forschungsgemeinschaft in Uruk-Warka* 9 [Berlin: Gebrüder Mann, 1976], No. 62:7–8; and *kukru* and *burāšu* in Hunger, *Uruk*, No. 63:1), as may be expected since the same corpus was in use (I. L. Finkel, “On Late Babylonian Medical

Training,” in *Wisdom, Gods and Literature: Studies in Assyriology in Honour of W. G. Lambert*, edited by A. R. George and I. L. Finkel [Winona Lake: Eisenbrauns, 2000], p. 145).

²⁴ Campbell Thompson, *Dictionary of Assyrian Botany*, pp. 363–64; CAD s.v. *sihu* B; Kinnier Wilson, “Notes on the Assyrian Pharmaceutical Series,” p. 47.

²⁵ CAD s.v. *maštakal*; CAD s.v. *sikillu*.

²⁶ Kinnier Wilson, “Notes on the Assyrian Pharmaceutical Series,” p. 47.

- (6) *Burāšu* and *kukru* (iii 6 and 7) are also often attested together: Hunger, *Uruk*, No. 9 63: 1; Köcher, *BAM* 200: 1, 255:4–5, 262:1–2; Finkel, “Medical Training,” p. 186, No. 28 rev. iii 7’–8’; Labat, “Ordonnances,” p. 174 (AO 17613:1–2). Often *šumlalû* is listed adjacently (AMT 50,3:8; Köcher, *BAM* 261:1–2; Köcher, *BAM* 168:79, 202 rev. iv 17; Küchler, *Beiträge*, pl. 11 iii 63; R. Caplice, “Namburbi Texts in the British Museum III,” *Orientalia* NS 36 (1967): 297:15) or closely (Köcher, *BAM* 200:2; Finkel, “Medical Training,” p. 186 No. 28 rev. iii 11’) to these two plants. In KADP 36, however, *šumlalû* is situated far from *burāšu* and *kukru* (KADP 36 iv 33). This combination is also attested in a Middle Assyrian text (Lambert, “Middle Assyrian Medical Text,” p. 21).
- (7) The sequence *erēnu*, *šurmēnu*, *duprānu*, and *asu* (iv 26–29) is well attested in medical texts (e.g., Hunger, *Uruk*, No. 62:7–8; Köcher, *BAM* 168:33,54, 482 iii 40).²⁷ This combination is also attested in a Middle Assyrian text (Lambert, “Middle Assyrian Medical Text,” p. 29:20).

Moreover, it should be noted that there is sometimes some kind of system at work. Section 6 has especially (dyeing) minerals; section 9 consists for the most part of non-Mesopotamian aromatic plants;²⁸ section 10 begins with nine drugs that come from the sea; section 11 enumerates carriers; except for mentioning one plant section 13 is focused on categories of medication.

Next to these faint traces of systematization there is one aspect of the text—undoubtedly the most remarkable one—which could point to an internal system being used in the text. The list gives us in some sections the way in which the plants were stored. Only sections 5–7 and the last section do not indicate this, but here it should be mentioned that the last section does not need it, since the preparations were not stored as such.

Interestingly, the fourth section also gives the total of the first four sections. This number is not preserved but can be restored by adding the four sectional totals: 15, 20, 17, and 16, which gives 68. This procedure is not repeated for the subsequent sections. As a matter of fact, this aspect constitutes the only identifiable classification system in the text,²⁹ although it is not known whether the scribe deliberately arranged the plants according to this system. The mentioning of the shelves and containers might just as well be purely informative. Anyhow, if one applies this system to the text, then the text is divided into four parts with the last section acting as a separate fifth part:

- Part 1: 1) Total: 15 (or 16) on top shelf no. 1.
 2) Total: 20 on shelf no. 2.
 3) Total: 17 on shelf no. 3.
 4) Total: 16 on shelf no. 4 // [68] on four shelves.
- Part 2: 5) Total: 15.
 6) Total: 18.
 7) Total: 15.
- Part 3: 8) Total: 11 clay pans used for roasting, or: 11 plants, stored in clay pans.
 9) Total: 19 clay pans used for roasting, or: 19 plants, stored in clay pans.
- Part 4: 10) Total: 15 *qabūtu*-containers, or: 15 plants, stored in *qabūtu*-containers.
 11) Total: 6 *qabūtu*-containers, or: 6 plants, stored in *qabūtu*-containers.
 12) Total: 10 *qabūtu*-containers, or: 10 plants, stored in *qabūtu*-containers.

The first place of storage is denoted by the logogram ^{gi}PA, which may correspond to two Akkadian words: *ḥaṭṭu* “stick, scepter”³⁰ or *ḥuṭāru* “branch, stick; staff,”³¹ although all scholars choose the former possibility.³² It is also

²⁷ CAD s.v. *asu* A; CAD s.v. *duprānu*; CAD s.v. *šurmēnu*.

²⁸ Goltz, “Apothekerinventar,” p. 106.

²⁹ Goltz, “Apothekerinventar,” p. 98. Goltz seems to contradict herself by first indicating that the mention of the way the plants were stored points toward a classification system (p. 98) and that the classification system cannot be recognized with certainty (p. 107).

³⁰ AHw. s.v. *ḥaṭṭu(m)*; CAD s.v. *ḥaṭṭu*.

³¹ AHw. s.v. *ḥuṭāru(m)*; CAD s.v. *ḥuṭāru* A.

³² B. Landsberger apud Köcher, KADP, p. 10; E. K. Ritter, “Magical Expert (= *Āšipu*) and Physician (= *Asû*): Notes on Two Complementary Professions in Babylonian Medicine,” in *Studies in Honor of Benno Landsberger on His Seventy-Fifth Birthday, April 21, 1965*, Assyriological Studies 16 (Chicago: University of Chicago Press, 1965), p. 308; Goltz, “Apothekerinventar,” p. 98; Edzard and Veenhof, “Inventare,” p. 139.

widely accepted³³ that *ḥaṭṭu* should mean here something like “shelf,” despite the general absence otherwise of this meaning for *ḥaṭṭu* in Akkadian.³⁴ The determinative GIŠ indicates that the shelf was made of wood.

The second form of storage is the ^{DUG}*qālītu*. The meaning of this word is well known. Most dictionaries agree that this word denotes a vessel for parching.³⁵ Only in one dictionary is the phrase ^{DUG}*qālītu* (*karpāt qālītu*) translated “clay pots containing parched grain.”³⁶

The last receptacle is the ^{DUG}*qabūtu*. One dictionary has “Becher, Kelch,”³⁷ while another remains vague (“a bowl”).³⁸ Fortunately, elsewhere the dictionary is more precise: “pitcher for pouring water into a basin.”³⁹ The most precise definition, however, is given by Leichty, who considers it to be a flask associated with the washing of hands, also used in rituals and sometimes used to hold fruit (apple) or other items (oil, honey).⁴⁰ According to Leichty, who also gives an illustration of a *qabūtu* on a tablet edge (fig. 1),⁴¹ they are mostly made of metal, but wooden and clay examples are also attested in texts.



Figure 1. Drawing of a *qabūtu*-flask on a tablet edge.

³³ Ritter, “Magical Expert,” p. 308; Goltz, “Apothekerinventar,” p. 98 n. 11; H. Limet, “Croyances, superstitions et débuts de la science en Mésopotamie ancienne,” *Oikumene* 5 (1986): 77–79.

³⁴ B. Landsberger, *Die Serie ana ittišu*, Materialien zum sumerischen Lexikon 1 (Rome: Pontificio Istituto Biblico, 1937), p. 174, was the first to propose a meaning “shelf” for *ḥaṭṭu*. He based his proposal on the expression *ša ina ḥaṭṭu šunūlu*, lit., “auf die Stöcke auslegen,” “to lay out on sticks”; he considered *ḥaṭṭu* to be some kind of wooden frame or rack.

³⁵ CAD s.v. *qālītu* A.

³⁶ *AHW*, s.v. *qālītu*.

³⁷ *AHW*, s.v. *qabūtu*.

³⁸ CAD s.v. *qabūtu* A.

³⁹ CAD s.v. *mû* A.

⁴⁰ E. Leichty, “*Qabūtu*, *šāḥu* and *mê qāti*,” in *Assyriologica et Semitica: Festschrift für Joachim Oelsner anlässlich seines 65. Geburtstages am 18. Februar 1997*, edited by J. Marzahn and H. Neumann, *Alter Orient und Altes Testament* 252 (Münster: Ugarit-Verlag 2000), p. 243.

⁴¹ The vessel illustrated in fig. 1 indicates that only fluids could be stored in it. Plants would be hard to store in such a long-necked container.

3.3. THE ARCHITECTURAL SETTING OF KADP 36

The architectural setting of this text is unfortunately not mentioned and consequently not known, although it is quite obvious that there will have been some construction containing at least four shelves (the first of which is the upper one). The name “pharmacy” is conventionally mentioned in this regard, but the only justification for using this name is the contents of the text, that is, medicinal materials, especially plants. One may, however, assume that only one room is involved.

3.4. INDICATION OF TIME OR REASON

The text nowhere gives an indication of the time when or the reason why the inventory was made up. Mostly inventories are produced when property changes ownership, when a person dies, or when a king adds new territory to his realm. That the compiler of this text apparently did not want to be associated with it is implied by the fact that he did not add a colophon.⁴² Only the findspot of the text links it with a famous family of exorcists, but the text itself does not mention any person (physician, priest, scholar, etc.), institution, or time period. A colophon would automatically have provided us with more information on the background of the text. It is thus impossible to know whether the plants belonged to one or more persons, or even to an institution.

3.5. INTERNAL DISCREPANCIES

At the end of each section a total is given, which oddly is usually not the same as the actual number of plants listed in the particular section. In at least seven sections the total of items does not correspond to the total listed, and the listed total is usually lower than the actual total of items.⁴³ Only in section 7 is the total given higher than the actual numbers of items.

<i>Section</i>	<i>Actual Total of Items</i>	<i>Total Given in Text</i>
1	16	15/16(?)
2	21	20
3	17/19+	17
4	21	16
5	27	15
6	22	18
7	14	15
8	12	11
9	19	19
10	29	15
11	10	6
12	10	10

In the first section, sixteen plants are listed although the last line reads “Total: 15 on shelf one, the upper shelf.” It must be noted, however, that the number could also be “16,” since the copy indicates that the sign is slightly damaged. The second section lists nineteen plants and twice the seed of one of these plants (tamarisk and laurel). This does not agree with the total of twenty, which is indicated at the end of this section. This section also makes clear that the totals did not necessarily refer only to plants, but also to other materials.

⁴² Goltz, “Apothekerinventar,” p. 98.

⁴³ Goltz, “Apothekerinventar,” p. 98 n. 10.

Since part of the third section is lost and it is impossible to determine how many lines are missing,⁴⁴ one cannot determine whether the total of seventeen items is correct. The section mentions at least sixteen plants and the fruit of one of these plants twice. Yet, in line 39 another plant name certainly has to be restored. This brings the minimum to seventeen plants. Section 8 has twelve items and a given total of eleven, again a discrepancy. A plausible solution for these discrepancies is hard to find. Several possibilities may be considered, but none of them holds for all sections.

- (1) Some plants were not stored, only mentioned.
- (2) Some sections have synonyms, for example, section 8.
- (3) The given totals do not refer to the number of plants listed in each section. They might refer to the weight of the plants, but if this were true, it would be more logical to mention the weight of each separate item, not of a group of items. On the other hand, the totals could refer to the bowls (*qālītu* and *qabūtu*) in which the plants were kept. In that case the translation of the last line of each section should be “x *qālītu/qabūtu*-receptacles.”
- (4) The discrepancies are a reflection of some kind of internal system used by the scribe, unknown to the modern scholar. One of the possible systems implies that the totals mentioned refer to groups of plants (e.g., family, character, color, etc.), but in that case the various groups are rather small and sometimes can consist of only one plant. Nevertheless, this explanation might be useful to account for some discrepancies.

Section 2: If *šakirû* and *šakir* ^d*Šamaš* are considered one group then the discrepancy disappears. Support for this is offered by the fact that the latter plant is extremely rare and occurs only in plant lists in the immediate vicinity of the more common *šakirû*.

Section 2: The alum (im.saḥar.na₄.kur.ra, im.saḥar.babbar.kur.ra, and im.saḥar.gi₆.kur.ra) and the salts (mun.kù.pad, mun.eme.sal-*lim* and mun *a-ma-nim*) may each be counted as units. This yields an actual total of 18, which corresponds to the total given.

Section 11: There are six lines of items. This could correspond to the total of six as given.

This system does not explain every discrepancy. For example, in section 7 one would expect that the *kamūnu* and the *kamūnu ša šadî* would be counted as one unit, giving an actual total of thirteen, not fourteen.

- (5) Scribal inaccuracies may be the cause of the internal discrepancies. In that case, however, there are suspiciously many mistakes. Nevertheless, the discrepancy in section 7 may well be the result of a scribal error, since it is the only occasion where the total mentioned is more than the actual number of items.

At least some of the systems mentioned here offer possible explanations for some discrepancies, although not all discrepancies can be solved by any one system. Sections 5 and 10, the sections with the largest discrepancies, remain unresolved. Perhaps their contents were also divided into groups (e.g., the sea-drugs in section 10), but the distinctions between and within these groups remain unknown.

4. THE LAST SECTION

Section 13 of the text lists not medicinal materials, but various categories of drugs: potions, fumigations, daubings, balms, suppositories, lotions, powders, ..., bandages for the kidney, bandages for the forehead, bandages for the nails. These categories, containing different preparations for which the plants listed could be used, is not exhaustive:⁴⁵ nothing is said about pills, the eating of medicines, tampons, or drops.

⁴⁴ Limet, “Croyances,” p. 78, believes that there is a gap of six lines, while the copy only indicates three missing lines (i 40–42). If Limet is correct, then the total of seventeen is indeed lower than the number

of at least twenty-two plants and seeds listed. The number of plants given here is based on the copy.

⁴⁵ Goltz, “Apothekerinventar,” p. 110.

It should also be noted that the preparations described in this list were not stored as such.⁴⁶ Two reasons can be found for this. First, the carriers (enumerated in section 11) cannot be preserved for long. This is illustrated clearly by the bandages. These actually are pulpous cataplasms, which as a result of dehydration lose their pharmaceutical effect (e.g., softening of the skin or the muscles) after a certain time of storage. Also butter (for ointments) or beer (for potions) did not have a long preservation time. Second, Mesopotamian physicians prepared each medication for immediate and unique use, so it was not necessary to store the ingredients for a long time.

Finally, it is remarkable that one plant, *qulqullânu*, is included in this section. In all probability there is a scribal mistake involved here.

5. KADP 36 IN A WIDER CONTEXT

5.1. GENERAL ASPECTS OF KADP 36

Let us sum up the main aspects of the so-called Neo-Assyrian Pharmaceutical Inventory. First of all, it is generally incomplete. Not all medicinal plants, minerals, etc. are listed, not even all major ones. Second, its internal classifying system is problematic, unless the scribe arranged his medicinal items according to the manner of storage (e.g., shelves, clay pans for parching, or some kind of flasks). Nevertheless, the scribe was not ignorant of botanical knowledge and he formulated some parts of his text systematically. Third, the architectural setting of this text is unfortunately not mentioned and there is also no indication of the time when the inventory was composed. Finally, the text contains some internal discrepancies.

5.2. KADP 36 AND MESOPOTAMIAN PLANT LISTS

Mesopotamian literature contains various plant lists, which can be divided into four categories.⁴⁷

- (1) Lists mentioning only the plant names (e.g., CT 14, pls. 21–22 and passim).
- (2) Two-columned lists establishing relationships between at least two plants, in a defined pattern (plant x: looks like plant y; e.g., CT 14, pl. 22 vii 43).
- (3) Two-columned lists with the plant names and the corresponding disease or organ against which or for which the plant is used (e.g., CT 14, pl. 29 K.4566+; *ibid.*, pl. 36 81-2-4, 267).
- (4) Three-columned lists. The first column gives the name of the plant, the second indicates the disease or the organ against which or for which the plant is used, and the third column provides information on preparing the plant (Köcher, *BAM* 1). The texts belonging to this category mostly serve therapeutical purposes and therefore are not pure plant lists.

At first sight, KADP 36 belongs to the first category. There is, however, one aspect about our text that distinguishes it from the other plant lists: the possible internal classification system, indicating how the plants are stored: shelves, *qālîtu*-vessels, and *qabûtu*-cups. If one wants to consider this text a “plant list,” it certainly constitutes a fifth category.

In addition, KADP 36 is also distinct from some plant lists in function. While some plant lists (the ones belonging to types 1 and 2 above) are purely lexical, our text is clearly not.

⁴⁶ Goltz, “Apothekerinventar,” pp. 110–14.

⁴⁷ B. Meissner, *Babylonien und Assyrien 2*, Kulturgeschichtliche Bibliothek. Reihe 1: Ethnologische Bibliothek 4 (Heidelberg: C. Winter, 1925), p. 295; Goltz, “Apothekerinventar,” pp. 96–97.

5.3. KADP 36 AND THE MESOPOTAMIAN AND DELIAN INVENTORIES

Excavations throughout Mesopotamia have yielded various inventories, and it is useful to compare these texts with the text discussed here. Our text has similarities with but also differs from Mesopotamian inventories. This should not surprise us, since Mesopotamian inventories themselves are not uniform. The most difficult aspect to study is the incompleteness of inventories found in Mesopotamia. A spatial inventory should be listing all items that are present in one space. Yet it is hard to determine whether an ancient text really lists all objects in a particular room or belonging to a particular person. The Neo-Assyrian inventory of the palace and the temple of Muṣaṣir only contains precious goods, but in all probability less valuable goods, not listed in the text, will also have been present in these buildings. The same probably applies to our text: some frequently used medicinal plants are not listed, but that does not necessarily mean they were not present in the room.

Internal classification systems are found in some Mesopotamian inventories, although they are not always clear to us. An example is J. A. Knudtzon, *Die El-Amarna-Tafeln*, Vorderasiatische Bibliothek 2 (Leipzig: J. C. Hinrichs, 1915), No. 14, in which metal objects are arranged according to the material of which they are made. First the gold objects are listed, followed by the silver ones, bronze, etc. The Middle Assyrian inventory of Urad-Šerūa (J. N. Postgate, *The Archive of Urad-Šerūa and His Family: A Middle Assyrian Household in Government Service* [Rome: Herder, 1988]) seems to use the same system as KADP 36, that is, the way the items were stored: chests are the basic storage unit. Not all Mesopotamian inventories have an architectural setting and because of that it cannot be determined whether they are limited to one specific architectural space (e.g., the inventories provided in letters). Others clearly mention where the goods are stored: the Middle Assyrian inventory of Urad-Šerūa (lower store room of the *šahūru*-building) and the Neo-Assyrian inventory of the Ḫaldi-temple in Muṣaṣir (F. Thureau-Dangin, *Une relation de la huitième campagne de Sargon (714 av. J.-C.)*, Textes Cunéiformes du Louvre 3 [Paris: P. Geuthner, 1912], lines 351–67).

In that regard the Mesopotamian inventories are no exception to other inventories from the ancient Near East or the classical world. Some Egyptian inventories have an architectural setting. Also various Delian inventories (e.g., IG XI.2 287B) and the biblical inventory of the temple in Jerusalem (1 Kings 7:15–51) are confined to one architectural space.

Along with the similarities between KADP 36 and the Mesopotamian inventories there are also some significant differences, suggesting that this text is not a real inventory. First of all, there is no connection between the text and a person or a god. In other words, the owner of the items listed in the inventory or the composer of the text is not known. KADP 36 is an exception in this regard in the corpus of Mesopotamian inventories since all other inventories mention a person or god (e.g., Köcher, *BAM* 366, a Neo-Assyrian inventory, mentioning 315 stones and composed by Kišir-Aššūr or Kišir-Nabû).⁴⁸

Second, most inventories (including Köcher, *BAM* 366) mention the quantities of the objects, that is, four chariots, two chests, etc., while KADP 36 only provides the totals per section. Here, too, the Mesopotamian inventories fit into the broader ancient Near Eastern context. It should be noted that Köcher, *BAM* 366, has a fine way of indicating the quantities: the first section (unfortunately not fully preserved) starts with the highest units, the second section lists the stones of which there are nine pieces stored, the third section always has eight pieces of a particular stone, etc. The last section lists those stones of which there is only one piece. At least eighty-five kinds of stones are listed.

A third difference between KADP 36 and the Mesopotamian inventories is in the aspect of time. Most Mesopotamian inventories indicate the date when the inventory is drawn up. Exceptions are our text and the Urad-šerūa inventory.

It appears that there are several types of Mesopotamian inventories. A classification of inventories could be made using the above-mentioned criteria. If one really wants to consider KADP 36 an inventory it would have to be listed under “Mesopotamian inventories,” subcategory “architecturally limited, with internal system, not complete, no indication of time or reason, no connection with person or god.”

⁴⁸ The name of the author of this text cannot be determined with certainty, because the latter part of his name is destroyed (𐎎Ki-šir- [...], line 22'). See O. Pedersén, *Archives and Libraries in the City of Assur: A Survey of the Material from the German Excavations*,

part 2, Acta Universitatis Upsaliensis, Studia Semitica Upsaliensia 8 (Uppsala: Almqvist & Wiksell, 1986), p. 46.

It is interesting to see that some younger Delian inventories (e.g., ID 3 1417, IG 11.2 287B,⁴⁹ places within the architectural unit, especially the prodromos) to some extent make subdivisions within one architectural unit. Others, however, go further and mention the places where the items were stored. Two such places are attested: rows and chests. The rows (στίχος and ῥυμός; ID 2 442B, ID 3 1450, IG 11.2 203B24) are probably some kind of shelves, an assumption which is favored by the Greek denotations, the second of which may mean “shelf.” The chests (κίβωτός; ID 2 442B, 3 1417, IG 11.2 287B) are simple boxes or coffers.

5.4. THE FUNCTION AND CHARACTER OF KADP 36

Determining the real function and character of this text is not easy. It has become clear that KADP 36 is different from both the Mesopotamian plant lists *inter alia* because of its inclusion of the manner of storage of the plants. Therefore one could argue that it is a true inventory, but in that case it is clear that KADP 36 would make up a unique category within this genre. Naturally, this depends on what definition of “inventory” one prefers. If the general definition of inventory (“a catalogue”) is preferred, then our text is certainly an inventory, but in that case many Mesopotamian lists could be labeled inventories. More rigid definitions of inventory (e.g., “list of objects present within an architectural space, made up at a certain moment, indicated in the list”) exclude the text from the group of Mesopotamian inventories.

A further argument against the inventory character of the text is the inclusion of the last section, mentioning medical preparations, some of which could not even be stored (e.g., bandages). In sum, I am inclined to believe it is not an inventory.

Scholars have proposed several possibilities concerning the function and character of this text.

- (1) The tablet may be composed according to an already existing order of medications and served as a stocking tool.⁵⁰ It is thus a real inventory of a real pharmacy.⁵¹ This explanation, however, is no longer accepted because of the incompleteness of the text and the non-inventorial character of the text.
- (2) Possibly our text was a private inventory of the collection of one physician,⁵² a possibility supported by the fact that the text was discovered in a private house owned by a family of exorcists and in which many other medicinal and literary texts were found.⁵³ Again, the non-inventorial character of the text contradicts this. Further, information about the owner would be expected.
- (3) It may be a memo for a collection of medications that has yet to be purchased.⁵⁴ This would explain the incompleteness of the text and the absence of some frequently used medicinal carriers such as beer, since these materials were available at all times in the house. If such were the case, however, the text should offer more information (e.g., the quantities to be purchased) or a heading (e.g., “to be purchased”).
- (4) There were larger storehouses where medicinal plants were distributed to physicians who needed them. The existence of such institutions can be shown through some receipts for plants and medicinal ingredients received by physicians (e.g., A. Clay, *Documents from the Temple Archives of Nippur Dated in the Reigns of Cassite Rulers*, Publications of the Babylonian Section 2/2 [Philadelphia: University Museum, 1912], No. 107). The high number of plants listed in KADP 36 suggests that the text was an inventory of such a larger storage place.⁵⁵ However, the incompleteness of the text does not support this theory (one would expect that many more plants were stored in such a storehouse).
- (5) It is a text with a didactic character, some kind of guide for the arrangement of medications. Possibly this guide is based on a real example.⁵⁶ In order to study this possibility a comparison with other late Mesopotamian medical school-texts is appropriate. The greater part of the known medical school-texts contains recipes,

⁴⁹ F. Dürnbach, *Inscriptions de Délos: Comptes des Hiéropes (Nos 372–498). Lois ou règlements, contrats d’entreprises et devis (Nos 499–509)* (Paris: Champion, 1929); and F. Dürnbach, *Inscriptiones Deli*, *Inscriptiones Graecae* 11.2 (Berlin: Dietrich Reimer, 1912).

⁵⁰ Goltz, “Apothekerinventar,” p. 98.

⁵¹ This is considered improbable by Edzard and Veenhof, “Inventare,” p. 139.

⁵² This is considered improbable by W. Farber, “Drogerien in Babylonien und Assyrien,” *Iraq* 39 (1977): 224.

⁵³ Pedersén, *Archives and Libraries*, pp. 41–76.

⁵⁴ Goltz, “Apothekerinventar,” p. 98.

⁵⁵ Farber, “Drogerien,” p. 224.

⁵⁶ B. Landsberger apud KADP, p. 10; see Edzard and Veenhof, “Inventare,” p. 139, who prefer this possibility to the first possibility.

but there are also twenty-five lists, plant lists, stone lists, or lists containing various kinds of ingredients.⁵⁷ Some of these lists (Köcher, *BAM* 355; Figulla, *Business Documents*, Nos. 146, 148, 151, 152) mention the quantities of ingredients and consequently are designed in connection with specific recipes. Therefore they should be situated somewhere between lists and recipes. Other texts (Köcher, *BAM* 109;⁵⁸ Finkel, “Medical Training,” p. 186 No. 28; Labat, “Ordonnances,” p. 54) reveal the disease against which the ingredients should be used. KADP 36 does not give these data, as is also the case with Köcher, *BAM* 200, 255, 261, 262, and Figulla, *Business Documents*, UET 4, No. 149. Another difference between KADP 36 and the other lists is the size: KADP 36 is a large tablet, while the other lists are rather small. Yet Finkel, “Medical Training,” p. 186 No. 28 (listing 78 plants), is also larger than a normal medical school-tablet. A remarkable similarity between both texts is that Finkel, “Medical Training,” p. 186 No. 28, indicates that the plants are used for salves, while KADP 36, which lists many more plants, indicates that they are used for potions, fumigations, daubings, balms, ointments, lavages, powders, and various bandages.

The conspicuous grouping of some plants has already been mentioned. That does not, however, imply that the order in which the plants were listed was approximately the same in the medical lists, as illustrated by the following table, comparing some examples of the three biggest lists. These lists do not follow the order established in the canonical Uruanna-series either.

	<i>KADP 36</i>	<i>Köcher, BAM 255</i>	<i>Finkel, “Medical Training,” p. 186 No. 28</i>
<i>aktam</i>	i 13	—	i 15
<i>atā ʾišu</i>	i 14	—	i 6
<i>karan šēlibi</i>	i 15	11	i 25
<i>maštakal</i>	i 16	—	—
<i>sikillu</i>	i 17	—	i 13
<i>elkullu</i>	ii 9	19	i 9
<i>ašqulālu</i>	iii 12	8	i 19
<i>amīlānu</i>	iii 12	18	—
<i>elikulla</i>	iii 13	20	i 10
<i>elikulla sāmu</i>	iii 14	—	i 11
<i>ēdu</i>	iii 16	10	i 12
<i>zēr ēdi</i>	iii 16	10	i 13

The only similarity is between KADP 36 iii 13–16 and Finkel, “Medical Training,” p. 186 No. 28 i 10–13. It is also surprising to see that in KADP 36 the distance between *elkulla* (ii 9) and *elikulla* (iii 13) is so great.

According to Finkel⁵⁹ the medical school-training started with the acquisition of literacy. Thereafter the apprentice doctor would have to learn the corpus of medical recipes and the way to use them, both by writing by dictation one or two recipes on small tablets and by listening to the further explanations by the teachers. The use of small tablets would unavoidably lead to a huge number of such tablets lying about in the building, a situation which would encourage the students to write these recipes down on larger tablets and simultaneously to make larger collections of related recipes. Perhaps a parallel situation existed for the acquisition of botanical knowledge, which was most

⁵⁷ Köcher, *BAM* 109, 200, 255, 261, 262, 355; Finkel, “Medical Training,” pp. 183–87 Nos. 25–30; Labat, “Ordonnances,” p. 54 171 (AO 17618 and 17622), 172 (AO 17615), 174 (AO 17613 and 17617); H. Figulla, *Business Documents of the New-Babylonian Period*, Ur Excavation Texts 4 (London: Harrison, 1949), Nos. 146–53.

⁵⁸ The last line (17) of the tablet is destroyed, but the penultimate line (16) reads 23 Ú.ḪI.A. The expected text tells what the medicines are used for.

⁵⁹ Finkel, “Medical Training,” pp. 141–43.

likely a part of medical training, coming before the learning of recipes. KADP 36 would then be written by a student who was somewhere in the process of his botanical education.⁶⁰

Without being absolutely certain concerning this text, I tend to believe the last theory: KADP 36 is an educational text, not based on any real example. The main indications for such an opinion are the incompleteness of the list, the fact that some plants are mentioned twice, the scribal errors, the similarities it has with medical school-lists, and the formulaic grouping of plants. The latter is the result of literary concerns rather than pharmacological ones. The order in which the plants are listed might reflect nothing more than the order in which the scribe learned about the plants. Furthermore, the scribe may have had some botanical knowledge, but he certainly did not apply all such knowledge to his text. This leads one to think the scribe was still under instruction and that KADP 36 is a school text. If that is the case one is dealing here with a text from the Faculty of Medicine of the University of Assur⁶¹ and not with a real inventory.

⁶⁰ This could explain why the method for storing the plants is explicitly mentioned. It is the duty of a botanical expert to know how the various plants were to be stored in an ideal way. Once the student was more involved with recipes and how to use the plants, the way of storing the plants would no longer be that important.

⁶¹ Consequently, I propose that we stop using the denotation "Pharmaceutical Inventory" and simply call this text by its publication number, KADP 36.

LEXICOGRAPHICAL STUDY OF THE ALREADY-ANCIENT IN ANTIQUITY*

Jon Taylor, British Museum

INTRODUCTION

This paper presents a short study of a group of compositions, mostly lexical texts, from the Old Babylonian period.¹ This group is distinguished from other Old Babylonian compositions in that it was already of considerable antiquity by that time. Special attention will be paid to the Standard Professions List (also known as Early Dynastic Lu A), although the other members of the group are also considered.

The origins of the Standard Professions List (SPL) extend back to the very beginnings of writing. No fewer than five manuscripts of what might be termed “forerunners” to the Standard Professions List are known from the Uruk IV period, thus accounting for almost half of the known lexical manuscripts from that time. Having taken its canonical form during the Uruk III period, the list spread from Uruk to other sites across Mesopotamia and the Near East, as far as Ebla to the west and Susa to the east.

The Standard Professions List, like many other lists, reached a point where its text became stable. Variation in the order of entries almost seems to be restricted to a small number of hot-spots throughout the text. This means that we may safely infer certain features of the sources even when preserved only in very fragmentary condition.

OLD BABYLONIAN COPIES OF ARCHAIC AND EARLY DYNASTIC COMPOSITIONS

Several Archaic and Early Dynastic compositions survived through the third millennium and down into the Old Babylonian period. Dating post-Sumerian exemplars of these compositions is difficult since most lack archaeological context and the application of paleographical techniques to such texts is not straightforward. Here an attempt will be made to distinguish between Old Akkadian–Ur III period manuscripts and Ur III–Old Babylonian manuscripts;² the latter will be referred to simply as Old Babylonian. The Old Babylonian copies of Archaic/Early Dynastic compositions known to me are listed in table 1 below.³

* This study was undertaken with the generous financial support of the British Academy.

¹ This group was first noted in Niek Veldhuis, “The Sur₉-Priest, the Instrument ^{gi}Al-gar-sur₉, and the Forms and Uses of a Rare Sign,” *Archiv für Orientforschung* 44–45 (1997–98): 114–28. A study appeared recently in Niek Veldhuis, *Religion, Literature, and Scholarship: The Sumerian Composition Nanše and The Birds, with a Catalogue of Bird Names*, Cuneiform Monographs 22 (Leiden: Brill; Boston: Styx, 2004), pp. 91–95. A further study by the same author is due to appear as “Guardians of Tradition: Early Dynastic Lexical Texts in Old Babylonian Copies,” in *Your Praise is Sweet: A Memorial Volume Presented to Jeremy Allen Black by Colleagues, Students, and Friends*, edited by Heather Baker, Eleanor Robson, and Gábor Zólyomi (forthcoming).

² In most cases this distinction is based on a consideration of both the type of object and the script employed. Any objects known to be Ur III or considered likely to be Ur III have been assigned to the early group rather than the Old Babylonian group. Obviously this process entails a degree of subjectivity, and it may be necessary to revise the classifications as we learn more about these objects.

³ A more up-to-date list of sources will be provided by Veldhuis, “Guardians of Tradition.” Two further compositions known from Early Dynastic sources are preserved into the Old Babylonian period: 5.6.1 The Instructions of Šuruppak and 4.80.2 The Kesh Temple Hymn. In contrast to the compositions listed below, these two remained part of the standard teaching corpus; the latter was particularly common. This difference in function is reflected in differences in the types of tablet on which these compositions are found.

Table 1. Archaic/Early Dynastic Compositions Known from Old Babylonian Copies.

<i>Composition</i>	<i>Number of Sources</i>
Standard Professions List	9
Early Dynastic Proverbs	3
Early Dynastic Birds	3
Early Dynastic Fish	3
Early Dynastic Plants	1
Early Dynastic Pots/Garments	1
Early Dynastic Word List C	1

As can be seen, quite a number of compositions are attested; again, the Standard Professions List is conspicuously popular. The question arises as to who used these texts, and how. The answer lies in the formatting of the source tablets themselves.

In Old Babylonian schools there are four types of tablet upon which lexical lists are normally found: these are known simply as types I, II, III, and IV.⁴ It makes sense to separate the two sub-types of the type I tablets: prisms/cylinders and large tablets. Below, in table 2, the sources of two compositions are divided according to type. In the first row are listed the manuscripts of the professions list that was commonly studied by Old Babylonian scribes, Proto-Lu; this provides an indication of the kind of distribution to be expected for a lexical list at this time. The sources of the Standard Professions List are listed in the second row.

Table 2.⁵ Comparison by Tablet Type of the Sources of SPL and Old Babylonian Proto-Lu.

	<i>Ia</i> (prism/cylinder)	<i>Ib</i> (tablet)	<i>II</i>	<i>III</i>	<i>IV</i>
<i>Proto-Lu</i>	1	12	74	5	10
<i>SPL</i>	(2/1)	(3+1+1)	1	0	0

From table 2, it is immediately obvious that the Standard Professions List has a very different distributional pattern from that of Proto-Lu. It is found almost exclusively on type I text vehicles. There is only one example of what is normally the most common type, type II (on the reverse), while types III and IV are completely lacking.⁶ This distribution is related to a significant feature of these manuscripts. In contrast to the compositions comprising units of the “standard” elementary curriculum (such as Proto-Lu), the copies of Archaic/Early Dynastic compositions were almost always written in their entirety. Only type I and the reverse of type II tablets could accommodate texts of this length. This feature also suggests an interest primarily in content, rather than using the text as a model for handwriting practice or learning elements of the cuneiform writing system. Even taking into account the preponderance of type I text vehicles, it is noticeable that there are an unexpectedly high number of prisms. Type I tablets are normally much more common. There is even a fully round cylinder, a very unusual type indeed. From this distribution we may reasonably deduce that the Standard Professions List was not a set part of the curriculum in the same way as was Proto-Lu and neither was it studied in the same way.

⁴ For more detail, see M. Civil et al., *The Series lú = ša and Related Texts*, Materials for the Sumerian Lexicon 12 (Rome: Pontificium Institutum Biblicum, 1969), pp. 27–28 (henceforth MSL 12).

⁵ In the second row some numbers are given in parentheses because they, and the other Old Babylonian copies of Early Dynastic lists, are of a slightly different type to the ones of the common type I. This is partly, though not completely, due to the difference in length between

the Early Dynastic lists—each about 100–150 lines—and the Old Babylonian lists—each about 800–1,000 lines. Numbers in the table are listed in the format x+y when more than one sub-type is attested. The physical features of the types and sub-types attested are explained below.

⁶ A type III tablet is attested for Early Dynastic Birds (YBC 4613; Veldhuis, *Religion, Literature, and Scholarship*, pls. 24–25).

THE POSSIBLE ROLE OF THE STANDARD PROFESSIONS LIST IN ELEMENTARY EDUCATION

There is some evidence for the Standard Professions List playing a role in elementary scribal education in the shape of the type II tablet. Type II tablets are characteristic for elementary education. They contain a short extract of one composition on the obverse, and a longer one of another composition on the reverse. It has been shown by Veldhuis⁷ that the text on the reverse was a revision of a text studied previously to that on the obverse. Thus in this instance, the Standard Professions List was studied before the lexical list Nigga,⁸ an elementary composition. A further indication of this source's production early in the education of a scribe is that the columns of the reverse are inscribed from left to right, instead of the usual order of right to left. This sometimes happens in school texts but its incidence decreases as the scribe becomes more experienced.

Additional hints to the use of the Standard Professions List during scribal education may be found in other texts. One such hint may be found in Proto-Diri Nippur. In line 373 there (M. Civil, *The Series DIRI = (w)atru*, Materials for the Sumerian Lexicon 15 [Rome: Pontificium Institutum Biblicum, 2004], p. 26: source O1, type II/1), a variant [PA].DÛN.GAL for PA.DÛN is found. This variant is incorrect here (note that the reading gloss is  u-ur-saġ) and must be influenced by the appearance of this term in line 116 of the Standard Professions List (GAL.PA.DÛN); this archaic term is not otherwise known from Old Babylonian texts. Again, the scribe appears to have knowledge of the Standard Professions List prior to studying a relatively elementary composition. A second hint may be found in a list of canals and ditches from Old Babylonian Nippur: UM 29-16-239 (copy in M. Civil and E. Reiner, *The Series  AR-ra =  ubullu Tablets XX–XXIV*, Materials for the Sumerian Lexicon 11 [Rome: Pontificium Institutum Biblicum, 1974], pl. 3). There a very unusual group of entries is listed; it resembles a section of the Standard Professions List closely:

<i>UM 29-16-239</i>	<i>Standard Professions List</i>
ii' 2' pa ₅ NU[N.ME]	15 NUN.ME
ii' 3' pa ₅ GAL.�UNKEN? ¹	16 GAL.UNKEN
ii' 4' pa ₅ GAL.TE	17 GAL.TE
ii' 5' pa ₅ GAL.SUKKAL	18 GAL.SUKKAL

Thus here, too, the scribe seems to have knowledge of the Standard Professions List prior to studying what appears to be an elementary composition.⁹

THE TYPE I SOURCES

The type I text vehicles for Old Babylonian copies of Archaic/Early Dynastic texts fall into two groups: prisms/cylinders and tablets. Examples of each of these types are now known from across Babylonia, covering several compositions. There is a noticeable regularity in the formatting of these text vehicles,¹⁰ suggesting the existence of a standard system for studying Archaic and Early Dynastic lists during the Old Babylonian period. Further indications of this will be seen shortly.

⁷ Niek Veldhuis, "Elementary Education at Nippur: The List of Trees and Wooden Objects" (Ph.D. diss., University of Groningen, 1997).

⁸ See here also Veldhuis, *Religion, Literature, and Scholarship*, p. 94 n. 38.

⁹ The situation is rather complicated. The fragment is small and preserves little other text. While Old Babylonian compositions are characteristically flexible in their content, and furthermore multiple versions may exist, this fragment appears to belong to a non-standard version of the text. As such, it may belong outside the curriculum; for this see Veldhuis, *Religion, Literature, and Scholarship*, p. 90. However, even were this tablet to attest an extracurricular text at Nippur, one would

still be left to explain how such entries became part of what would have been a curricular text at the site of its origin.

¹⁰ For this reason the present writer is a little hesitant to accept the "sets" posited in Veldhuis, *Religion, Literature, and Scholarship*, p. 92, until we know more about these texts. The similarities between the manuscripts and the relative rarity of copies of Archaic/Early Dynastic compositions in the Old Babylonian period may lead to manuscripts being grouped erroneously. At the same time, it may be that manuscripts of different types do belong together in as-yet unrecognized groupings.

A) PRISMS AND CYLINDERS

Prisms containing the Standard Professions List are typically seven-sided,¹¹ with one column of text per face. As noted above, prisms were not very commonly used as text vehicles for Old Babylonian lexical texts. Neither were they commonly so used during the Archaic or Early Dynastic periods. From what little we have of Old Akkadian and Ur III lexical material, there are indications that the practice of copying such compositions onto prisms may have begun at that time. Cylinders are even less common than prisms in Old Babylonian schools, to the extent that they may be considered rare. In addition to the Sippar cylinder BM 30041+ (to be published elsewhere by the author), another cylinder bearing the Standard Professions List is known (A. Clay, *Miscellaneous Inscriptions in the Yale Babylonian Collection*, Yale Oriental Series, Babylonian Texts 1 [New Haven: Yale University Press, 1915], No. 12), said to come from Nippur. It appears to be somewhat earlier than the Sippar cylinder. A third cylinder is known: an Ur III(?) copy of the Abu Salabikh Names and Professions List of unknown provenance.¹² The use of prisms and cylinders to contain copies of Archaic/Early Dynastic compositions seems to be more a continuation of an earlier practice of copying already ancient texts rather than an innovation of Old Babylonian scribes or a simple continuation of original practice in studying such texts.

Two prisms and a cylinder with the text of the Standard Professions List are now known from the Old Babylonian period. Together with the other prisms from the Old Babylonian–Ur III group¹¹ and those belonging to the earlier Old Akkadian–Ur III group, they display a number of interesting features. Often, although not always, the prisms/cylinders contain lines of equal height, aligned across columns. In such examples, each column must have held the same number of lines. Since the text of the Standard Professions List was fixed, we can usually calculate the length of the columns even from relatively small fragments bearing that composition. This feature will shortly become useful below. Old Babylonian scribes were not normally very concerned with such details of formatting. The arrangement is more reminiscent of third-millennium practice. Indeed the “lines” look more like “cases.”

B) TABLETS

The most common sub-type of the type I tablets is the two-column tablet. Such tablets are written in “portrait” orientation, with two columns of text on the obverse, continuing in the same manner on the reverse. It is noticeable that this type seems regularly to contain glosses, as shown in table 3 below.

Table 3. The Distribution of Glosses According to Tablet Type (SPL sources only).

	Type Ia (prism/cylinder)	Type Ib (two-column tablet)	Type Ib (other)	Type II
<i>glossed</i>	0	3+1 [?]	0	0
<i>not glossed</i>	2/1	0	1	1

When glosses are found, they occur not occasionally but throughout the text. The tablets without glosses seem to be of different types. The source entered with a question mark in the “glossed” row is Chiera, *Sumerian Lexical Texts*, No. 24. It provides readings, although not as glosses but in a separate column. This may be interpreted as a variant of the standard two-column tablet format. The “not glossed” source in the “type Ib (other)” column is Chiera, *Sumerian Lexical Texts*, No. 112. It is unusual in several ways. In addition to being a multi-column tablet

¹¹ The Standard Professions List contains 128 entries. The prisms contain columns that are typically nineteen lines long. Since the prisms contain the entire composition, this means that seven columns are required. For a prism to have fewer than seven sides, each column would have to contain at least twenty-two entries; to have more than seven sides, each column would have to contain eighteen or fewer entries. E. Chiera, *Sumerian Lexical Texts from the Temple School of Nippur*, Oriental Institute Publications 11 (Chicago: University of Chicago Press, 1929), No. 113, is described in Civil, MSL 12, p. 9, and Veldhuis, *Religion, Literature, and Scholarship*, p. 92, as being hexagonal. Since it has nineteen lines per column, however, it ought to be heptagonal; note that the fragment (Civil, MSL 12, p. 9 source Y) to which Chiera, *Sumerian Lexical Texts*, No. 113, is said to be

joined, is described in Civil, MSL 12, as heptagonal. Likewise, the Kisurra prism (B. Kienast, *Die altbabylonischen Briefe und Urkunden aus Kisurra*, Freiburger altorientalische Studien 2 [Wiesbaden: Steiner, 1978], pl. 92 F20) is also likely to be seven- rather than six-sided. The prism from Lagash (Civil, MSL 12, p. 9 source S) is unusual in several ways. One of these is that it is a hexagonal prism with nineteen lines per column. Note, however, that it is also unusual in not containing the complete text; columns iii–v simply repeat column ii, and column vi contains a colophon.

¹² Published in Frederick Mario Fales and Theo J. H. Krispijn, “An Early Ur III Copy of the Abu Salabikh ‘Names and Professions’ List,” *Jaarbericht Ex Oriente Lux* 26 (1979–80): 39–46.

rather than a two-column tablet, it contains more than one composition; preceding the Standard Professions List is a list of personal names. As a rule, type I tablets contain only a single composition. It is perhaps little surprise that this tablet with unusual format is unusual also in that it does not contain glosses. The prisms/cylinders never contain glosses. This is not a law of cuneiform but a result of choice.

A similar picture emerges when the sources of other Old Babylonian copies of Archaic/Early Dynastic compositions are counted, as shown in table 4 below.

Table 4. The Distribution of Glosses According to Tablet Type (all compositions).

	Type Ia (prism/cylinder)	Type Ib (two-column tablet)	Type Ib (other)	Type II
<i>glossed</i>	0	6+1 [?] +2	1	0
<i>not glossed</i>	4/1	2	2	1

Again, no prisms/cylinders contain glosses. And of the eleven two-column tablets, only two lack glosses.¹³ The “glossed” source listed in the “type Ib (other)” column is Chiera, *Sumerian Lexical Texts*, No. 11, a multi-column tablet. The two two-column tablets with glosses that are listed separately are two fragments of copies of Early Dynastic Proverbs. The format of these pieces is Sumerian with glosses in the left-hand column and Akkadian translations in the right-hand column. This may be interpreted as a further variant of the standard two-column arrangement.

The high degree of uniformity of features constitutes further evidence of standardization of practice. The distributional pattern of glossed two-column tablets and un-glossed prisms is striking and invites explanation. There is no clear evidence for pre-Old Babylonian glossed tablets, although the Ur III fragment 6 N-T 681+685 (G. Pettinato, *Testi lessicali monolingui della Bibliotheca L. 2769*, *Materiali epigrafici di Ebla 3* [Naples: Istituto Universitario Orientale, 1981], pp. 275–77) may turn out to be such a piece.

THE GLOSSES

The orthography of third-millennium texts must have been a challenge to the Old Babylonian scribes.¹⁴ For example, the Standard Professions List writes the word *enkud* “tax collector” simply as ZAG; the word is more familiar to both the Old Babylonian scribe and modern reader in the fuller form ZAG.ĤA. Other entries require signs to be read in unexpected ways. For example, the following two lines suggest that GAL may sometimes be read /nir/:

112 GAL^{[(x)]-ri-ni-ir}MUŠ
119 GAL^{[lu?]-uš-ĥu-um-ni-ir}LUĤŠU

A more vexing problem is posed by line 118. Two sources from Ur inform us that PA.ŠA₆ is read /tidim/:

UET 7 86:¹⁵ [GAL.PA]^{[ti-di-im-gal}ŠA₆
U 30497: [GAL.PA]^{ti-di-im-gal}ŠA₆

The PA.ŠA₆ is actually known from canonical *lú = ša* II 1 (Civil, MSL 12, p. 116), there translated *kisaluhĥu* “courtyard sweeper.” The matter is complicated by an unusual lexical text from Old Babylonian Ur (UET 7 93 rev. 29):¹⁶ PA^{e-ri-daš}ŠA₆ = *ki-sà-lu-ĥu-um*). This confirms the translation *kisaluhĥu* but offers instead a reading /erida/, which itself requires explanation.

¹³ One copy of Early Dynastic Birds and one of Early Dynastic Fish.

¹⁴ Our own difficulty in reading them is largely due to the fact that our knowledge of the reading of cuneiform signs is dominated by Old Babylonian and later usage.

¹⁵ O. R. Gurney, *Middle Babylonian Legal Documents and Other Texts*, Ur Excavations Texts 7 (London: British Museum, 1974).

¹⁶ Published by Åke Sjöberg, “UET 7 no. 93: A Lexical Text or a Commentary?,” *Zeitschrift für Assyriologie* 86 (1996): 223.

However, the preserved glosses do seem to indicate a good level of understanding. The glosses preserved in the various sources agree with each other. Two examples are provided here by way of illustration. The reading of line 86 is (now) predictable:

BM 58680: [IDIGNA]en-^fku-id^l-ig-la[ZAG]
Chiera, *Sumerian Lexical Texts*, No. 24: [IDIGNA.ZAG] [e]n-kù-idigna

The reading of line 88 is less predictable:

BM 58680: GAL^fla^l-ab-galD[U₆]
Chiera, *Sumerian Lexical Texts*, No. 24: [GAL.DU₆] [la-a]b-gal

In each case the source from Sippar (BM 58680) and that from Nippur (Chiera, *Sumerian Lexical Texts*, No. 24) agree. A high level of agreement is also found between the Sippar source and two sources from Ur, as here in line 115:

BM 58680: [GAL]sa-an-da-^fx-x^fSANGA.GÁN^l
UET 7 86: [GAL.SANGA]^[x]-an-da-ga-naGÁN
U 30497: [GAL.SANGA]^[l...d]a-ga-naGÁN

and line 119:

BM 58680: [GAL][...]-^fum-ni-ir^lLUḪŠU
UET 7 86: [GAL][...]-um-ni-irLUḪŠU
U 30497: [GAL]^[lu?]-uš-ḫu-um-ni-ir[LUḪŠU]

Where a check with material outside the list is available, again there is agreement. The example of enku^d was noted already above. Another example is the reading /ḫursaḡ/ for PA.DÙN. Two sources from Ur provide the reading (line 116):

UET 7 86: [GAL.PA]^[ḫ]u-ur-sa-ḡ-galDÙN
U 30497: [GAL.PA]^[ḫ]u-ur-saḡ-galDÙN

The correctness of this reading for these signs has been established by Civil.¹⁷

The agreement between sources shows us that the ancient compositions were not being copied unthinkingly just because they were old. Knowledge of how to read the signs in these ancient contexts was preserved, although it was of little or no use for other compositions. The comprehension displayed in the sources gives us grounds for confidence in readings that are unpredictable and difficult to explain.

DOUBLE RULINGS

A second interesting feature of the tablets is the presence of double rulings in several of the sources. To date, this feature is only attested in copies of the Standard Professions List. The presence of such rulings is unexpected. In Old Babylonian school texts, double rulings are used to indicate conceptual breaks of various sorts. For example, they may occur at the end of a written assignment (see, e.g., Chiera, *Sumerian Lexical Texts*, No. 128); where a long composition is broken into two or more theoretical “tablets” to make it more manageable (see, e.g., Chiera, *Sumerian Lexical Texts*, No. 240); between individual proverbs in collections (see, e.g., O. R. Gurney and S. N. Kramer, *Sumerian Literary Texts in the Ashmolean Museum*, Oxford Editions of Cuneiform Texts 5 [Oxford: Clarendon Press, 1976], No. 35), since they are semi-independent. Likewise, such rulings are found separating the various thematic sections of ur₅-ra (see, e.g., Chiera, *Sumerian Lexical Texts*, No. 46), and sometimes sections of the lists of personal names (see, e.g., E. Chiera, *Lists of Personal Names from the Temple School of Nippur*, University of Pennsylvania, University Museum, Publications of the Babylonian Section 11/3 [Philadelphia: University Museum, 1919], No. 33).

¹⁷ Miguel Civil, “Early Dynastic Spellings,” in *Oriens Antiquus* 22 (1983): 1–5.

The double rulings in the Standard Professions List manuscripts are not explicable in any of the above ways. Again the stability of the text helps provide the answer. It is possible to calculate that the double rulings occur at regular intervals; more specifically, every nineteen lines. In Chiera, *Sumerian Lexical Texts*, No. 112, from Nippur, they occur after lines 19 and 57 (= 3×19). In UET 7 86, from Ur, a double ruling is found after line 114 (= 6×19). It was noted above that some of the prisms/cylinders had fixed column lengths. Of the three exemplars, two (BM 30041+, Ni 1600+) have columns nineteen lines long, while the third is too fragmentary to judge. The double rulings, then, are to be interpreted as marking the ends of columns on the originals from which the tablets were copied and thus constitute further evidence for the importance attached to the format of the original. A subsidiary question arises here, namely “why nineteen lines”? No particular significance to the number nineteen suggests itself. On practical grounds one might have expected a preference for objects in shapes simple to construct and use, namely with an even (and low) number of sides. Perhaps the heptagon was deliberately chosen for the difficulty of its construction. For a heptagon, the nineteen-line format leaves less space blank than would a twenty- or twenty-one-line format. Likewise, for a hexagon the twenty-two-line format leaves less space blank than twenty-three or twenty-four, and for an octagon sixteen lines is best. The perfect fit of the text on the octagon in sixteen-line format (16×6 = 128) might be expected to have had aesthetic merit. However, in terms of the overall shape of the objects, the heptagon with nineteen lines may have been a compromise between the short and stocky octagon and the tall and thin hexagon. Of course, it is possible that the selection of object and format was arbitrary.

Formatting features such as the use of “cases,” fixed column lengths, and double rulings to indicate the physical features of an original from which a text was copied are alien to standard Old Babylonian school practice. They are more familiar from third-millennium practice. Turning to the earlier group of post-Sumerian sources (Old Akkadian–Ur III), the same features are present. The prism from Lagash¹⁸ also has nineteen lines per column. Clay, *Miscellaneous Inscriptions*, No. 12, a cylinder said to come from Nippur, has only eighteen lines per column, however. The nineteen-line format and double rulings are survivals of a practice best attested at Ebla, as documented some years ago by Archi.¹⁹ The results of immediate relevance to this paper are summarized briefly below.

At Ebla two sets of tablet types can be distinguished for lexical texts: one for native lists and one for lists borrowed from Mesopotamia, such as the Standard Professions List. Four sources of Standard Professions List are known from Ebla: two large, square tablets and two smaller, round ones. The two square tablets each have nineteen lines per column (see, e.g., Pettinato, *Testi lessicali monolingui*, pl. 2); variations between them indicate that they were copied from different originals. The two round tablets each insert double rulings after every nineteen lines (see, e.g., Pettinato, *Testi lessicali monolingui*, pl. 1). That this is marking the ends of columns on the original is shown by the colophon on one of them, which states that it copies one of the aforementioned large tablets.

Fixed column lengths are common for Ebla copies of Mesopotamian lists, although the exact length may vary both between different compositions and between the individual manuscripts of a single composition. Fixed column lengths are also commonplace at Tell Abu Salabikh. Among the Standard Professions List manuscripts from that site, three have eighteen-line columns, two have seventeen-line columns, and there is one example each of twenty-two-, sixteen- (probable), fifteen-, and twelve-line columns.²⁰

Fixed column lengths are far less common among the Fara texts. Of the five Standard Professions List manuscripts from that site, three have no fixed length, one has twenty-one lines (A. Deimel, *Schultexte aus Fara* [Leipzig: J. C. Hinrichs, 1923], No. 75), and the other apparently copied a source with that same length (Deimel, *Schultexte*, No. 76). So it would seem that the standardized, nineteen-line format may be a product of the late Early Dynastic period.

¹⁸ Woldemar G. Schileico, “Das sechsseitige Tonprisma Lugal-ušumgal’s aus der Sammlung Lichatschew,” *Zeitschrift für Assyriologie* 29 (1914–15): 78–84, copy p. 79.

¹⁹ Alfonso Archi, “The Transmission of the Mesopotamian Lexical and Literary Texts from Ebla,” in *Literature and Literary Language at Ebla*, Quaderni di Semitistica 18 (Florence: University of Florence, 1992), edited by Pelio Fronzaroli, pp. 1–39.

²⁰ My thanks to Robert Biggs for sending me photos of these texts. The slight uncertainty surrounding the manuscript with a probable sixteen lines is because one section of text contains entries from a “hot-spot” of variation (lines 40–43; the text has [...], 41, 43, 44?, [...]). The manuscript with twelve-line columns contains only the first seventy-two lines. The manuscript with twenty-two-line columns comes from an early level. A further three manuscripts are either unavailable or too fragmentary for the column length to be determined.

CONCLUSION

The Standard Professions List and the other Archaic/Early Dynastic compositions were the object of occasional study by Old Babylonian scribes. Just how occasional remains a matter of speculation. The scribes were interested in the text itself and display a good level of understanding of it, but they were interested also in the formatting of the text.

A surprising degree of standardization is evident, both in the models and in the copies made. This speaks against the possibility that study of these compositions was on an ad hoc basis. Rather, the Old Babylonian scribes seem to have been consciously continuing a tradition, in terms both of the objects upon which the compositions were written and in the manner of writing.

It is possible to trace the history of the various features found in the Old Babylonian copies. The text ultimately derives from the Uruk IV period, settling into canonical form during Uruk III. The concern with the physical format appears to be late Early Dynastic. The copying of the text onto prisms and cylinders appears to be Old Akkadian. And the provision of glosses is perhaps Ur III or maybe an Old Babylonian innovation. Thus it was not simply the text but even the method of studying the text that was ancient. The Old Babylonian copies stand at the end of an extremely long tradition.

One might speculate that the Old Babylonian scribes first copied directly from a model prism onto another prism, carefully preserving the formatting features of the original. Subsequently, the text was perhaps copied onto two-column tablets, where glosses were added to explain the text. At this stage little regard was given to the original formatting; rather than aligned “cases” of equal height, we find the usual Old Babylonian practice of lines of variable height. Occasionally, however, the ends of columns were noted in the tablets with a double ruling, mimicking the appearance of the model prisms. Also occasionally, the composition could be revised on a standard school tablet (the type II tablet discussed above) or could be collected together with other unusual compositions (as in the case of Chiera, *Sumerian Lexical Texts*, No. 112). The proposed order is contrary to what is normally found in Old Babylonian schools, where as a general rule the more a scribe knows, the less is written. However, this is an unusual group of compositions; and while the above remains hypothetical, in the opinion of the author it best accounts for the evidence currently available.

A CLASSIFIED PAST: CLASSIFICATION OF KNOWLEDGE IN THE HITTITE EMPIRE

Theo van den Hout, University of Chicago

1. INTRODUCTION

In 1324 B.C., the Hittite Great King Šuppiluliuma received an embassy from Egypt requesting he send a son to marry the widow of the late pharaoh. Once he had overcome his initial suspicions, he consented and this great moment of Hittite-Egyptian unity was solemnly celebrated by having read aloud a one-hundred-year-old treaty between the two monarchies: “And when the tablet had been read out loud to them, my father spoke as follows: ‘In the past Ḫattuša and Egypt were friends with each other but now this too has happened between the two of us so that Ḫatti and Egypt will be friends with each other for evermore!’”¹

Judging by this and numerous other examples, Hittite kings controlled their past, that is, they were able to order and retrieve at will older records and actively did so for a range of purposes: festive occasions like the one just referred to, but also for oracular inquiries, cultic traditions, historiography, etc. Basically, they kept records of any genre which they expected they might want to consult in the future. This implies that Hittite kings and their staff must have kept a system and preserved older tablets out of an interest in their own past. Is something of this ancient system, the classification of their own written-down knowledge, retrievable for us?

It is only recently that this topic has gained a wider interest in Hittitology. One reason for this is the young age of the field: it is only a century ago that in October 1905 Hugo Winckler was shown the first Hittite tablets found near the small village of Boğazköy, and ninety years since the recognition of Hittite as an Indo-European language in 1915. To put this in perspective: just six years later, in 1921, the Chicago Assyrian Dictionary was started.² Priorities in those early days were editing the most important and as many texts as possible and sketching the basic political-military and cultural history on the basis of these texts. Understandably, all such efforts concerned the contents, not the tablets themselves. Another reason is the loss of information on the findspots of the first four excavation seasons between 1906 and 1912, the sometimes not very precise recording of findspots after the campaigns resumed in 1931, and the confusing or seemingly confusing archaeological record when the findspots are known. Add to this unrealistic and not always well-informed notions of ancient administration, and the idea of a futile and thankless enterprise easily takes hold.

Only occasionally do we find attempts that reach beyond the philology of single texts. As early as 1922, Emil Forrer characterized the collections as a library simply because there often were multiple copies of the same composition.³ In 1949, Emanuel Laroche looked at scribes and colophons to gain insight into the organization of the Hittite tablet collections,⁴ and in 1955 Heinrich Otten attempted a wider look in his article “Bibliotheken im alten Orient.”⁵ Combining archaeology and philology, he identified the main locations of tablet collections and their layout. Textual evidence came from what were considered the ancient catalogues, that is, tablets listing tablets (nowadays mostly referred to as shelf lists), and colophons as well as labels that once marked series of tablets on a shelf or in a basket. It is interesting to see how those same years of the 1950s saw a surge in publications dealing with archival matters.

¹ Hans G. Güterbock, “The Deeds of Suppiluliuma as Told by His Son, Mursili II,” *Journal of Cuneiform Studies* 10 (1956): 98, quoting KBo 14 12 iv 33–39; for the chronology, see Theo van den Hout, “Der Falke und das Kücken: Der neue Pharao und der hethitische Prinz?,” *Zeitschrift für Assyriologie* 84 (1994): 87 f.

² On the CAD’s history see Erica Reiner, *An Adventure of Great Dimension: The Launching of the Chicago Assyrian Dictionary*, Transactions of the American Philosophical Society 92, Part 3 (Philadelphia: American Philosophical Society, 2002).

³ Emil Forrer, “Die Inschriften und Sprachen des Ḫatti-Reiches,” *Zeitschrift der Deutschen morgenländischen Gesellschaft* 76/NF 1 (1922): 182.

⁴ Emanuel Laroche, “La bibliothèque de Ḫattuša,” *Archiv Orientalní* 17 (1949): 7–23.

⁵ Heinrich Otten, “Bibliotheken im alten Orient,” *Das Altertum* 1 (1955): 67–81.

Especially valuable was the involvement by some archivists venturing into the territory of ancient Near Eastern studies and interpreting the material but, unfortunately, their articles were largely ignored and the use of the terms “archive” and “library” in our fields remains highly idiosyncratic. The topic was not taken up again in Hittology until the 1980s. It was once more Otten who briefly reaffirmed the basic library character of the Hittite tablet collections at the 30th Rencontre in Leiden in 1983.⁶ Not long after, in 1991, Hans Güterbock analyzed the relationship between so-called shelf lists found in one of the major buildings and its actual tablet holdings.⁷ By then, in the late 1980s, the younger generation had stepped in. No doubt at the behest of Otten, the Akademie der Wissenschaften und der Literatur in Mainz started the first systematic and by now invaluable project entitled *Konkordanz der hethitischen Texte* on the Web-site Hethitologie Portal Mainz.⁸ This has been developed and maintained by Silvin Košak and has grown into a complete concordance of texts, findspots, paleographic dating, and basic bibliography.⁹ In 1995 he also gave a first interpretation of the material concentrating on Building A. Dividing the material up according to paleographic dating into Old Script (OS), Middle Script (MS), and New Script (NS), Košak observed the relatively large number of OS and MS texts as well as the low number of purely administrative records and took this as confirming Otten’s characterization of Building A as a library. He was followed in this by Silvia Alaura who analyzed both Buildings A and E on Büyükkale and claimed that in some cases tablets were removed from E to A while others were discarded. Correctly, in my opinion, she termed A a “Depot,” although I do not agree with the idea that the tablets stored there had lost their practical value.

Despite the ongoing labeling of Hittite tablet collections as libraries, I argued in 2002 that almost the entire Hittite text corpus qualifies as archival according to the definition of archive(s) as used in archival science: “An archival collection is the whole of the written documents, ... officially received or produced by an administrative body or one of its officials, in so far as these documents were intended to remain in the custody of that body or of that official.”¹⁰ The overwhelming majority of Hittite records were the product of the Hittite administration, comprising both the records produced by that administration and the incoming records from elsewhere insofar as they were addressed to that administration. In an empire such as that of the Hittites this is true both of records that in ancient Near Eastern studies are traditionally seen as archival, that is, administrative in a narrow sense (e.g., legal, fiscal, or commercial records), but it is no less true of cultic compositions such as hymns and prayers, festival scenarios, oracles, myths, and other compositions traditionally referred to as “literary” as long as they are directly related to the state cult or activities of the ruling class.

2. THE HITTITE WRITTEN LEGACY

For the second millennium B.C., the tablet collections of Ḫattuša are unique both in their diversity and in their coherence: they contain an unrivaled diversity of genres distributed over several primary locations, while at the same time genres and storage places form part of a single administration and, I would argue, a single coherent administrative system. What is more, these tablet collections not only comprised the administration of the most recent past, but also the ruling class must have held on to certain records for hundreds of years because it wanted to and deliberately perpetuated such records by repeatedly copying them—often adjusting and updating them while not throwing away the older ones. The copying of compositions is evident in the countless duplicates we possess as well as in many colophons, while the texts themselves regularly refer to older tablets.

⁶ Heinrich Otten, “Archive und Bibliotheken in Ḫattuša,” in *Cuneiform Archives and Libraries*, edited by K. R. Veenhof, Uitgaven van het Nederlands Historisch-Archaeologisch Instituut te Istanbul (Leiden: Nederlands Instituut voor het Nabije Oosten, 1986), pp. 184–90.

⁷ Hans G. Güterbock, “Bemerkungen über die im Gebäude A auf Büyükkale gefundenen Tontafeln,” *Archiv für Orientforschung* 38–39 (1991–92): 132–37.

⁸ <http://www.orient.uni-wuerzburg.de>.

⁹ Initially published in book form as Silvin Košak, *Konkordanz der Keilschrifttafeln I–III/2*, Studien zu den Boğazköy-Texten 34, 39, 42, and 43 respectively (Wiesbaden: Harrassowitz, 1992, 1995,

1998, 1999; henceforth referred to as StBoT and the volume number), but since then only accessible through <http://www.hethport.uni-wuerzburg.de/hetkonk/>; its most current version used for the following remarks is 0.6 and henceforth referred to as *Konkordanz*.

¹⁰ S. Muller, J. A. Feith, and R. Fruin, *Manual for the Arrangement and Description of Archives, Drawn Up by Direction of the Netherlands Association of Archivists*, translation of the second edition by A. H. Leavitt (New York: H. W. Wilson, 1968), p. 13. After “written documents” the authors included in their definition “drawings and printed matter.” Obviously, the latter is not applicable and drawings, although attested, seem to come as part of written documents only.

An overview of Hittite text genres shows a systematic division between records that were as a rule copied and often also kept indefinitely (A), and those that were not copied and were regularly recycled or otherwise discarded (B). As a consequence, we have of the latter group as a rule only the latest records. Compare the following chart:¹¹

<i>A. Texts in Multiple Copies</i>	<i>B. Texts in Single Copies</i>
historical prose, treaties, edicts (CTH 1–147, 211–16)	correspondence (CTH 151–210)
instructions (CTH 251–75)	land deeds (CTH 221–25)
laws (CTH 291–92)	lists and rosters (CTH 231–39)
hymns and prayers (CTH 371–89)	economic administration (CTH 240–50)
rituals (CTH 390–500)	court depositions (CTH 293–97)
festival scenarios (CTH 591–21)	cult inventories (CTH 510–30)
celestial omina (CTH 531–35)	non-celestial omina (CTH 536–60)
mythology, Anatolian (CTH 321–38) and non-Anatolian (CTH 341–69)	oracle reports (CTH 561–82)
Hattian, Palaic, Luwian, Hurrian texts (CTH 725–91)	vows (CTH 583–90)
hippological texts (CTH 284–87)	tablet collection shelf lists (CTH 276–82)
lexical lists (CTH 299–309)	tablet collection labels (CTH 283)
Sumerian and Akkadian compositions (CTH 310–16, 792–819) and the Hurrian-Hittite bilingual (CTH 789)	

Let us look at the basic facts first. The *Konkordanz* currently lists for the Hittite capital Ḫattuša 26,789 numbers,¹² that is, every item or fragment from an entire tablet or the smallest piece of it and everything in between, each having its own museum or excavation number.¹³ Silvin Košak estimated some ten fragments to a tablet but, of course, not all 26,789 pieces will eventually fit together to over 2,600 tablets. Many fragments and tablets have been completely lost and many were recycled by the Hittites themselves. Moreover, there were also the wooden writing boards. Finally, the entries just mentioned do not include the thousands of bullae with Hieroglyphic Luwian inscriptions that were also an integral part of the empire's administration.

Of the 26,789 pieces mentioned, 11,856 were found at what can be regarded as the three major places of tablet storage in the Hittite capital: in Building A atop the acropolis Büyükkale, in the Lower City, in the storerooms surrounding Temple 1, and in the Haus am Hang (see fig. 1). It should be remembered that for another 11,444 pieces the findspot is unknown. We do know, however, that some 8,500 to 9,000 pieces of these come from the storerooms around Temple 1 and the Haus am Hang area.¹⁴ There were other places where tablets were found that can be con-

¹¹ For this chart and more detailed comments, see Theo van den Hout, "Another View of Hittite Literature," in *Anatolia Antica: Studi in memoria di Fiorella Imparati*, edited by Stefano de Martino and Franca Pecchioli Daddi, Eothen 11 (Florence: LoGisma, 2002), pp. 857–78.

¹² This number and those used in the following were arrived at by adding the totals of fragments as given under each findspot in the *Konkordanz*. They are likely to be imprecise and will include double counted entries. However, the exact numbers are not really important: what counts is the relative size of those numbers and the resulting percentages.

¹³ Each number is a *Datensatz* in the *Konkordanz* and several *Datensätze* can be joined to form a tablet or as much as can be restored of a single tablet. Silvin Košak, "The Palace Library 'Building A' on Büyükkale," in *Studio Historiae Ardens: Ancient Near Eastern Studies Presented to Philo H. J. Houwink ten Cate on the Occasion of*

His 65th Birthday, edited by Theo van den Hout and Johan de Roos, Uitgaven van het Nederlands Historisch-Archaeologisch Instituut te Istanbul (Leiden: Nederlands Instituut voor het Nabije Oosten, 1995), pp. 173–79, uses the term "entry" for the latter.

¹⁴ In 1906 Winckler worked in the area of Bldg. E only and some 2,500 pieces were unearthed; see Otto Puchstein, *Boghasköi: Die Bauwerke*, Wissenschaftliche Veröffentlichungen der Deutschen Orient-Gesellschaft 19 (Osnabrück: Zeller, 1984; original publication Leipzig, 1912), p. 2; and Silvia Alaura, "Archive und Bibliotheken in Ḫattuša," in *Akten des IV. Internationalen Kongresses für Hethitologie Würzburg, 4.–8. Oktober 1999*, edited by Gernot Wilhelm, Studien zu den Boğazköy-Texten 45 (Wiesbaden: Harrassowitz, 2001), p. 19. The remaining 8,500 to 9,000 tablets and fragments were excavated in the later campaigns of 1907, 1911, and 1912 in the Lower City.

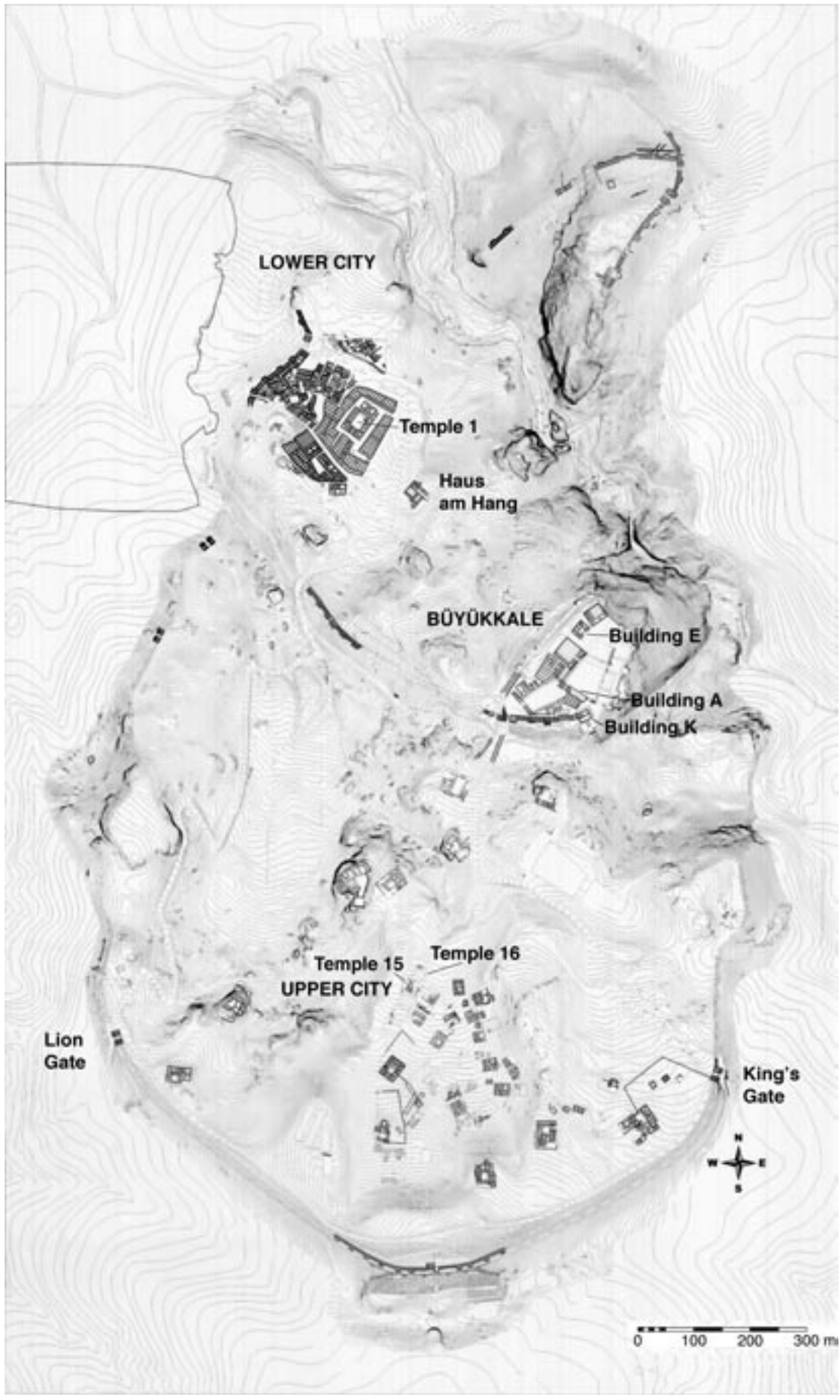

Figure 1. Map of Hattusa.

sidered with certainty as primary places of tablet storage in antiquity such as Building K on Büyükkale or Temples 15 and 16 in the Upper City. The primary character of some other locations is more difficult to ascertain while yet others are clearly secondary. On the whole, however, the number of tablets found at these other locations is very modest compared to those found at the three major ones.

3. BUILDING A, THE STOREROOMS SURROUNDING TEMPLE 1, AND THE HAUS AM HANG COMPARED

As found, all three locations reflect the situation as it was when the ruling elite decided to give up the residence and abandon it.¹⁵ That is, the combination of contemporary late-thirteenth-century tablets and older ones from as early as ca. 1600 B.C. represents the real inventory of each structure.¹⁶ The older records do not come from older strata and have not secondarily contaminated what theoretically could have been an original collection of, say, thirteenth-century records only.¹⁷

Focusing on Building A, the storerooms surrounding Temple 1 (StT1), and the Haus am Hang (HaH), I give below the number of pieces per building. For each building the numbers are broken down by date according to the script.

Old Script (OS)	1650–1500 B.C.
Middle Script (MS)	1500–1350 B.C.
New Script (NS)	1350–1180 B.C.

As a subgroup of NS we can identify

Late New Script (LNS)	1240–1180 B.C.
-----------------------	----------------

Needless to say, all dates are approximate and transitions were gradual. Note also that especially small fragments do not always contain enough diagnostic signs to determine a paleographic date. The number of dated pieces per building will therefore always be smaller than the total number for a building. In the following tables I have combined in the second column “OS?” with OS; likewise “OS?/MS?” and “MS?” were counted as MS. NS and LNS (Late New Script), however, I have kept separate.

<i>Building A</i>			
Total: 4,719			
Total datable to distinct periods (OS, MS, NS, LNS): 3,852			
<i>OS</i>	247	279	7.2%
<i>OS?</i>	32	—	—
<i>OS?/MS?</i>	9	—	—
<i>MS</i>	1,087	1,359	35.3%
<i>MS?</i>	263	—	—
<i>NS</i>	2,051	2,051	53.3%
<i>LNS</i>	163	163	4.2%

¹⁵ For the latest assessment of the end of the Hittite capital, see Jürgen Seeher, “Die Zerstörung der Stadt Ḫattuša,” in *Akten des IV. Internationalen Kongresses für Hethitologie Würzburg*, pp. 623–34.

¹⁶ Cf. explicitly Otten, “Bibliotheken im alten Orient,” pp. 71–73, further Peter Neve, *Büyükkale, die Bauwerke: Grabungen 1954–1966*, Boğazköy-Ḫattuša 12 (Berlin: Gebrüder Mann, 1982), pp. 104–07; see also Güterbock, “Bemerkungen,” p. 136, and Otten apud Košak, *Konkordanz I*, pp. 6, 8.

¹⁷ This is exactly the reason why the recognition of older ductus types had to wait until 1952, when for the first time in an archaeologically Old Hittite stratum a fragment was found that made it possible to distinguish in previously excavated material OS from MS and NS; cf. Heinrich Otten, “Die inschriftlichen Funde,” *Mitteilungen der Deutschen Orient-Gesellschaft* 86 (1953): 59–64. Laroche, “La bibliothèque de Ḫattuša,” p. 14, still admitted the possibility that the Hittite written tradition did not start until the beginning of the Empire period.

<i>Haus am Hang</i>			
Total: 1,635			
Total datable to distinct periods (OS, MS, NS, LNS): 1,538			
<i>OS</i>	18	23	1.5%
<i>OS?</i>	5	—	—
<i>OS?/MS?</i>	—	—	—
<i>MS</i>	41	67	4.4%
<i>MS?</i>	26	—	—
<i>NS</i>	1,243	1,243	80.8%
<i>LNS</i>	205	205	13.3%

<i>Storerooms Surrounding Temple 1</i>			
Total: 5,502			
Total datable to distinct periods (OS, MS, NS, LNS): 4,528			
<i>OS</i>	41	44	1%
<i>OS?</i>	3	—	—
<i>OS?/MS?</i>	5	—	—
<i>MS</i>	220	370	8.2%
<i>MS?</i>	145	—	—
<i>NS</i>	3,846	3,846	84.9%
<i>LNS</i>	268	268	5.9%

The figures for the storerooms surrounding Temple 1 and the Haus am Hang do not include the number of fragments excavated during the campaigns of 1906/1907 and 1911/1912. These excavations were carried out by Hugo Winckler in the areas of the storerooms surrounding Temple 1, the Haus am Hang in the Lower City, and Building E on top of the west slope of Büyükkale. Although it seems that at least initially the general division of the more than 11,000 fragments found over these two main areas was known, this knowledge was soon lost.¹⁸ It is only through later joins, diary entries of Winckler, and some scattered early remarks that we sometimes know at least the general locus (that is, either the storerooms surrounding Temple 1 or Building E) of some of these pieces, but their number is extremely small.

As stated above, the end of the tablet collections of Ḫattuša came with the abandonment of the capital by the ruling elite not long after 1200 B.C. Disregarding for the moment the tablets they may have taken with them, the archaeological situation thus reflects the state of the collections at that moment. So if we take ca. 1200 B.C. as our vantage point, we can view in a very general way tablets in OS and MS as the older ones and those in NS and LNS as contemporaneous. Although the NS period is longest of all, it is a reasonable assumption that the overwhelming majority of the NS tablets dates to the second half of the thirteenth century: general recycling principles versus the preservation of older records point in that direction.¹⁹

¹⁸ Cf. van den Hout, "Another View of Hittite Literature," p. 859 n. 5, to which can be added Kurt Bittel, "Vorläufiger Bericht über die Ausgrabungen in Boğazköy 1936," *Mitteilungen der Deutschen Orient-Gesellschaft* 75 (1937): 33; Hans G. Güterbock, "A View of Hittite Literature," *Journal of the American Oriental Society* 84 (1964): 107; and Silvia Alaura, "Osservazioni sui luoghi di ritrova-

mento dei trattati internazionali a Boğazköy-Ḫattuša," in *Šarnikzel, Hethitologische Studien zum Gedenken an Emil Orgetorix Forrer*, edited by Detlev Groddek and Sylvester Rössle, *Dresdner Beiträge zur Hethitologie* 10 (Dresden: Verlag der TU Dresden, 2004), pp. 140 f.

¹⁹ See Muller, Feith, and Fruin, *Manual*, pp. 44–47; and van den Hout, "Another View of Hittite Literature," pp. 869 f.

We immediately see some interesting differences between Building A on the one hand and the storerooms surrounding Temple 1 and the Haus am Hang on the other:

	<i>OS and MS</i>	<i>NS including LNS</i>
<i>Bldg. A</i>	42.5%	57.5%
<i>HaH</i>	5.9%	94.1%
<i>StT1</i>	9.2%	90.8%

Another striking difference concerns the number of fragments in the very late script, LNS, per building:

Building A	4.2%
StT1	5.9%
HaH	13.3%

Let us look at the distribution of records in OS/MS and NS first. Building A stands out for its older holdings, an observation that can already be found in Hittitological literature although not in relation to other structures or to the empire's larger administrative system.²⁰ In both the storerooms surrounding Temple 1 and the Haus am Hang, OS tablets are rare while the number of MS records, though in itself not inconsiderable, is definitely small compared to that of Building A. It would now be interesting to see whether it can be determined if the NS tablets and fragments of Building A also contain a significant number of earlier records in that chronological range, that is, dating to Šuppiluliuma I, Muršili II, or Muwatalli II, roughly the period 1350–1275 B.C. As was stated above, the NS period is the longest and it may be possible that just as we can distinguish the LNS for the last two or three decades, we might also be able to distinguish an older type for the earliest NS layer.

These general observations match conclusions I recently drew from a more restricted corpus of almost 800 entries in an article on the administration in the reigns of the last three Hittite Great Kings.²¹ On the basis of ephemeral records, that is, those that were as a rule not copied (see above § 2 Group B), records such as lists, economic and religious administration, court depositions, and letters on the one hand, and on the other hand those of Group A that can be securely dated to one of the last three known kings, some distribution of tasks or functions per building emerges. It is evident, for instance, that Building A does very poorly in the Group B records: lists and court depositions were never kept there while economic administration was virtually absent. The only ephemeral records that appear with some significance in Building A are oracles and correspondence, that is, the least ephemeral ones and those that, although not copied, were most likely to have longer-term implications and might be kept indefinitely if dealing with sensitive enough information.²² Building A, on the other hand, does very well on long-term records of the most traditional kind: festivals and rituals. However, political documents such as treaties dating to the latest period are absent again.

Turning to the Haus am Hang, just as in Building A economic administration is surprisingly lacking there as well. Otherwise, all ephemeral genres (Group B) are found in good numbers there. Of these, cultic administration is clearly the dominant category of texts. Of the Group A texts, festivals and rituals datable to the latest period are rarely attested but there are four treaties — all, moreover, to be dated to the last known Hittite king, Šuppiluliyama II.

²⁰ Otten apud Košak, *StBoT* 34, p. 8; Košak, "The Palace Library 'Building A,'" pp. 173–79; Alaura, "Archive und Bibliotheken," p. 26.

²¹ Theo van den Hout, "Administration in the Reign of Tuthaliya IV and the Later Years of the Hittite Empire," in *The Life and Times of Hattušili III and Tuthaliya IV*, edited by Theo van den Hout, pp. 77–106. Uitgaven van het Nederlands Historisch-Archaeologisch Instituut te Istanbul (Leiden: Nederlands Instituut voor het Nabije Oosten, 2006).

²² It has been claimed by Alaura, "Archive und Bibliotheken," p. 25, that the oracle texts in Building A are of a different character than the ones found elsewhere, that is, those of Building E would be dealing with the Hittite royal family, their political, cultic, and health-related problems exclusively; those of Building A she does not characterize in similar fashion. This claim is hard to substantiate when almost all Hittite oracle texts involve such issues; for a listing of topics, see

Ahmet Ünal, *Ein Orakeltext über die Intrigen am hethitischen Hof (KUB XXII 70 = Bo 2011)*, *Texte der Hethiter* 6 (Heidelberg: Carl Winter, 1978); for a listing of NS oracle texts from Building A dealing with those same problems, see van den Hout, "Administration." That the only older oracle records come from Building A (Alaura, *ibid.*) cannot be maintained either: it is true that with a single exception all older oracle fragments whose findspot we know were found on Büyükkale but only half can be traced back to Building A. The older ones that were found in Boğazköy and whose findspot we do not know can theoretically come from the storerooms surrounding Temple 1, the Haus am Hang, or Building E but not from A; on this, see Theo van den Hout, "Bemerkungen zu älteren hethitischen Orakeltexten," in *Kulturgeschichte, altorientalische Studien für Volkert Haas zum 65. Geburtstag*, edited by Thomas Richter, Doris Prechel, and Jörg Klinger (Saarbrücken: Saarbrücker Druckerei und Verlag, 2001), pp. 432 f.

The storerooms surrounding Temple 1 have the widest coverage of genres of the three locations: all ephemeral genres are amply attested. It was clearly *the* center for economic administration. While relatively low on festivals and rituals, diplomatic documents such as treaties and edicts are well represented. Interesting, however, is that all that are securely datable stem from the reign of Tuthaliya IV. No diplomatic documents of his second successor Šuppiluliyama can be identified. The same trend can be observed in cultic administration: those explicitly mentioning Tuthaliya are found almost exclusively in the storerooms surrounding Temple 1.

So apart from the fact that the Haus am Hang seems to have had no role in the economic administration, which seems to have been handled (almost?²³) exclusively by the storerooms surrounding Temple 1, the main difference otherwise between the Haus am Hang and the storerooms on the basis of this restricted corpus is chronological. As far as records go that mention a specific king, the Haus am Hang shows a significant presence of Šuppiluliyama records while the storerooms surrounding Temple 1 tend toward Tudhaliya IV, his predecessor. On this basis one can hypothesize a first-line role for the Haus am Hang in the political and cultic administration, with the no-longer-quite-current documents being moved to the storerooms surrounding Temple 1. The next destination was either recycling or Building A. The high percentage of LNS records from the Haus am Hang (13.3%) vis-à-vis the other two (Bldg. A and the storerooms surrounding Temple 1 with 4.2% and 5.9% respectively) fits this observation remarkably well. A central role for the storerooms surrounding Temple 1 in economic administration is not surprising when one looks both at their layout as storage units as well as at their location between two streets that led immediately to two city gates where one imagines caravans with goods coming and going. Seen from a logistical perspective, a location of the economic administration on the acropolis — as has sometimes been suggested in the past — is quite unlikely.

Another conclusion to be drawn from all this is that there is no reason to assume a separate palace and temple administration for Hattuša where Building A would represent the interests of the palace while the storerooms surrounding Temple 1 would belong to the temple or priesthood.²⁴ The fact that storerooms contain the widest coverage of genres overlapping with both Building A and the Haus am Hang makes such a division improbable. This also means that the records found in the storerooms surrounding Temple 1 do not necessarily have a connection with the temple in their midst.²⁵

4. TABLET COLLECTIONS AND THE HITTITES' CLASSIFICATION OF KNOWLEDGE

The labeling of Building A as a library²⁶ is, I think, confusing and misleading. The presence of old or older documents is by no means characteristic of a library and the breadth of genres represented there — even if slightly less broad than the storerooms surrounding Temple 1 — would raise the question of how this “library” differed from the collections in the storerooms surrounding Temple 1 and the Haus am Hang. As I have already claimed above, almost the entire Hittite text corpus qualifies as archival according to the definition of archive(s) as used in archival science. The overwhelming majority of Hittite records were the products of the Hittite administration, encompassing both the records produced by that administration and the incoming records from elsewhere insofar as they were addressed to that administration.

An archive is passive and grows organically whereas a library actively selects. The two come together in a way when an administration regularly cleans up its holdings and through a process of appraisal and selection creates a center of records it wants to keep. Every administration faces the problem of an ever-growing number of records that have to be controlled, a past that has to be controlled. Weeding out records that are no longer useful from those that might be needed in the future is a necessary task. The result is a record center. It, too, is created through active selection, but the essential difference between a library and a record center is in its genesis: a library arises through acquisition and thus continuous *expansion* whereas a record center comes into being through a process of *reduction* of the much wider collection of the living archive.

²³ For the possibility that economic administration was also partly located in Bldg. E, see my remarks in “Administration.”

²⁴ See, for instance, Trevor Bryce, *Life and Society in the Hittite World* (Oxford: Oxford University Press, 2002), pp. 64 f.; compare also J. de Roos, “Vows Concerning Military Campaigns of Hattušiliš III and Tuthališ IV,” in de Martino and Pecchioli Daddi, eds., *Anatolia*

Antica, pp. 182 f., where he already notes the difficulties for the vow genre if we accept such a dual administration.

²⁵ Theoretically this may originally have been the case, but this was no longer true in, say, the thirteenth century and there is nothing that points to an older, different function.

²⁶ See above § 1.

Given the fact that Building A, the storerooms surrounding Temple 1, and the Haus am Hang existed simultaneously, we should try to see them as parts of a larger, coherent system. Within that larger context Building A seems to have functioned in modern archival terms as a record center and, judging by the presence of LNS records in Building A, the practice of appraisal and selection continued until the last moment.

The existence of such record centers or (historical) archives in the relatively modern American usage has usually been denied for the ancient Near East.²⁷ For the ancient Near East outside of Anatolia, this seems largely true: not one (second-millennium) site shows the same diversity of genres as part of one coherent administrative system combined with the time depth of almost 500 years as do the tablet collections of Ḫattuša.

Older archival theory saw a collection of records as directly reflecting an administration. Modern archivists take a more liberal approach: they focus “on the larger or ‘macro’ context of the records, as revealed through their creators’ functions, programs, activities, and transactions, that is, through the context of their creation.”²⁸ This shift in approach has everything to do with the task of the modern archivist: namely, to appraise and select. The resulting archive should now be “reflective of society at large.” Archivists of the nineteenth and early twentieth century wrote about record collections of a distant, mostly medieval, past as part of a historian’s profession. They primarily *described* collections that had already been appraised and selected by “the rude wasting of old times.” Their colleagues of the 1930s and later, on the other hand, facing an ever mounting and increasingly unwieldy number of records of contemporary administrations, had themselves to appraise and select in order to provide the future historian with the necessary and yet manageable amount of records. If we apply this view of archives as “reflective of society at large” to ancient Near Eastern collections as a descriptive tool instead of a prescriptive guideline, “society” in the Hittite case equals the empire’s ruling class, the creators of the records, and virtually the only level of Hittite society we are informed about. If so, what do the above observations say about them?

Despite his use of the word “library,” Heinrich Otten’s words are still true: “Die Frage nach dem Vorhandensein von Bibliotheken im alten Orient ist zunächst ein geistesgeschichtliches Anliegen, ist doch, nach der Erfindung der Schrift, die Sammlung und Tradierung von Wissensgut eine der wesentlichen Voraussetzungen menschlicher geistiger Entwicklung.”²⁹ The global distinction between administrative centers in the Lower City, right there where daily business was conducted, and a special reference collection in a record center atop the acropolis reflects not just the workings of Hittite administration but also says something of its use of history. It is a well-known fact that Hittite kings legitimized their acts not so much by divine right as by historical inevitability. Political decisions were explicitly and routinely founded on past experience. In order to do so effectively—and if anything, Hittites seem to have been effective bureaucrats³⁰—one needs to preserve such older sources, to have a system in place to appraise and select contemporaneous records as well as to retrieve them. Building A was that place where older sources were kept for ready reference, and its collection was the result of appraisal and selection, reflecting the Hittites’ classification of their knowledge. The organization of that classification, how texts were grouped and shelved within that center, is a question for the future, just as is Building A’s exact relationship to the storerooms surrounding Temple 1,³¹ but the records themselves contain ample illustration that Hittite officials were able to find their way around the thousands of records kept there.

²⁷ Thus relatively recently Klaas R. Veenhof, “Cuneiform Archives: An Introduction,” in Veenhof, *Cuneiform Archives and Libraries*, p. 7; followed by Jeremy Black and William Tait, “Archives and Libraries in the Ancient Near East,” in *Civilizations of the Ancient Near East*, edited by Jack Sasson (New York: Scribner, 1995), p. 2202a. For older remarks to the same effect, see G. Goossens, “Introduction à l’archivéologie de l’Asie antérieure,” *Revue d’Assyriologie* 46 (1952): 100; Johannes Papritz, “Archive in Altmesopotamien: Theorie und Tatsachen,” *Archivalische Zeitschrift* 55 (1959): 18; and Ernst Posner, *Archives in the Ancient World* (Cambridge: Harvard University Press, 1972), pp. 4f. An interesting exception can be found at Ugarit where less current records, some of which went back to 150 years, were kept “upstairs” and the current ones “downstairs”: see on this Wilfred

van Soldt, “The Palace Archives at Ugarit,” in Veenhof, *Cuneiform Archives and Libraries*, pp. 196–204.

²⁸ Terry Cook, “Archives in the Post-Custodial World: Interaction of Archival Theory and Practice Since the Publication of the Dutch Manual in 1898,” *Archivum* 43 (1997): 200.

²⁹ Otten, “Bibliotheken im alten Orient,” p. 67.

³⁰ See Laroche, “La bibliothèque de Ḫattuša,” p. 71: “les bibliothécaires hittites étaient gens ordonnés.”

³¹ It is possible we will never know for lack of enough detailed archaeological evidence, but a more detailed analysis of the records kept there will no doubt bring us further.

THE MEASURE OF MAN: THE LEXICAL SERIES UGU-MU

*Joan Goodnick Westenholz, Bible Lands Museum Jerusalem,
and Marcel Sigrist, École Biblique et Archéologique Française de Jérusalem*

INTRODUCTION

Among the few thematic lexical lists outside of the major series of 𒄠AR-ra (ur₅-ra) = *hubullu* is a list entitled Ugu-mu¹ by ancient and modern scholars alike.² Its opening line (incipit), ugu-mu, was recognized according to the entry in one catalogue of literary and scholarly texts (UET 5 86:19).³ Usually translated “my head,” this list contains a compendium enumerating all known parts of the human anatomy.

In this paper, we hope to give an introduction to the lexical series, its contents, its spatial and temporal distribution, as well as its purpose and place in the school curriculum. Further, we will investigate the function of this lexical list, attempt to place it in its context, and discuss its relationship to other lexical and medical series. In order to deduce the anatomical knowledge of the ancient Mesopotamians and to highlight the various problems in understanding this source, we will concentrate on one section of the lexicon, the initial five lines dealing with the head. We will analyze these lexemes to see how they can be paired with modern terminology.

THE TEXT

The many fragments and versions, both monolingual Sumerian and bilingual Sumerian and Akkadian, bearing sections of this lexical list were first assembled by Miguel Civil in 1967.⁴ After 1967, other fragments of this text, both monolingual and bilingual, were found and edited in scattered publications.⁵ Some still remain unedited, including two tablets that originally held the complete text of Ugu-mu.⁶ On the basis of these new manuscripts, we are making a revised edition of the text.

¹ The phonetic reality of the first-person possessive pronoun in Sumerian is most probably 𒄠₁₀. The present transliteration maintains the traditional reading.

² For discussions of Ugu-mu, see Miguel Civil, “Ancient Mesopotamian Lexicography,” in *Civilizations of the Ancient Near East*, edited by Jack Sasson (New York: Scribner, 1995), p. 2311; and Antoine Cavigneaux, “Lexikalische Listen,” *Reallexikon der Assyriologie* 6 (Berlin: Walter de Gruyter, 1983): 630 § 18.3. It was entitled SA₆. ALAN-mu before 1967.

³ H. H. Figulla and W. J. Martin, *Letters and Documents of the Old-Babylonian Period*, Ur Excavation Texts 5 (London: British Museum, 1953) [henceforth UET 5], No. 86:19, was first identified by Miguel Civil in B. Landsberger and M. Civil, *The Series 𒄠AR-ra = hubullu XV*, *Materialien zum sumerischen Lexikon* 9 (Rome: Pontificium Institutum Biblicum, 1967) [henceforth MSL 9], p. 59, note to line 1. See further Dominique Charpin, *Le Clergé d'Ur au siècle d'Hammurabi (XIX^e–XVIII^e siècles av. J.-C.)* (Geneva and Paris: Librairie Droz, 1986), pp. 453–55.

⁴ This reconstructed partial text was published in MSL 9, pp. 49–73. Note that the source S₆ is not CBS 6755 but CBS 6754 (identified by Niek Veldhuis). The bilingual text MM 502 has now been published in photograph in Manuel Molina Martos, “Lexical and Other School Tablets in the Montserrat Museum,” in *Studi sul Vicino Oriente Antico dedicati alla memoria di Luigi Cagni*, edited by Simonetta Graziani, Istituto Universitario Orientale Dipartimento di Studi Asiatici, Series Minor 61 (Naples: Istituto Universitario Orientale, 2000), pp. 752 and 758 (photographs).

⁵ Abdul-Hadi al-Fouadi, *Lenticular Exercise School Texts*, Texts in the Iraq Museum 10 (Baghdad: Ministry of Culture and Arts, 1978) [henceforth TIM 10], Nos. 27, 48, 65, 66, 78, 79, 111, 113, 114, 115 (all monolingual lenticular school tablets); O. R. Gurney, *Middle Babylonian Documents and Other Texts*, Ur Excavation Texts 7 (London: British Museum, 1974) [henceforth UET 7], Nos. 95, 96; Daniel Arnaud, *Texte aus Larsa*, Berliner Beiträge zum Vorderer Orient Texte 3 (Berlin: Dietrich Reimer, 1994), No. 63 IM 73363; Antoine Cavigneaux, *Uruk, Altbabylonische Texte aus dem Planquadrat Pe XVI-4/5*, Ausgrabungen in Uruk-Warka, Endberichte 23 (Mainz am Rhein: Philipp von Zabern, 1996), No. 179 (all bilingual texts); Stephanie Dalley, *Old Babylonian Texts in the Ashmolean Museum, Mainly from Larsa, Sippar, Kish and Lagaba*, Oxford Editions of Cuneiform Texts 15 (Oxford: Clarendon, 2005) [henceforth OECT 15], No. 135 Ash 1923-337. In addition, there is a trilingual (Sumerian, Akkadian, and Hittite) fragment from the ancient Hittite capital, Boghazköy, H. Otten, *Texte aus Stadtplanquadrat L/18*, 2, Keilschrifttexte aus Boghazköi 13 (Berlin: Gebrüder Mann, 1967) [henceforth KBo 13], No. 2.

⁶ Library of Congress No. 7, YBC 7299, YBC 7321 (all lenticular school tablets); UM 29-16-653, N 5005, 3NT-920e (Nippur monolinguals); 13N 179 (MB Nippur bilingual fragment, references courtesy of Miguel Civil); HS 1847 and 2027 (Nippur monolinguals, reference courtesy of Niek Veldhuis); BM 59501 and 64183 (Sippar lenticular school tablets, references courtesy of Jon Taylor); MS 2888 and SC 4146 (Schøyen collection), to be published by Miguel Civil, who

SUMMARY OF CONTENTS

This lexical text provides a vocabulary of anatomical terms arranged according to the ordering of the parts of the human body, working downward from the head to the toes. The number of entries depends on the various manuscripts; the estimated totals range from between 220 to 270 entries.⁷ In the following summary, the parts of the body indicated within brackets are missing in the gaps of the text. The contents include:

Skull

Hair Types

Facial Features (including a few blood vessels)

Region of the Eye and Cheeks

Region of the Nose

Region of the Mouth

Region of the Ear

Neck, Throat, Jugular Vein, Pipe, Trachea, and Musculature

Upper Extremities: Arm and Hand, Parts and Dimensions

Torso Back: Shoulder Blades (scapula), Backbone (vertebral column), and Musculature

Torso Front: Chest, Ribs, Pectoral Area, Mammary Glands

Abdomen: Epigastric, Navel and Hypogastric Regions

Viscera Internal Organs: Heart, Lungs, Stomach, Intestines (large and small), Spleen, [Liver,] Gall Bladder

Sexual and Urinary Organs (kidneys, bladder) and Fluids (male)

Rear of the Body and Bodily Wastes

Lower Extremities: Region of the Legs and the Feet

General Physiology: Body, Skin, Blood, Skeleton

Ages of Man: Childhood, Adolescence, Maturity, Old Age

Post-Death Remains

Physical and Mental States

Surveying the anatomy provided by the Ugu-mu text, we can make the following deductions: both external and internal parts were taken into account with an undue emphasis on the head and its components. In regards to the internal circulatory system, certain blood vessels including the jugular vein are mentioned. However, there are many problems in the interpretation of this anatomical lexicon; some words have general import such as šà-mu in Sumerian equated with *qirbū 'a* in Akkadian with the meaning “my insides,” and some are completely unknown hapaxes providing lexicographical puzzles.

THE SPATIAL AND TEMPORAL DISTRIBUTION OF UGU-MU

Various versions of the Ugu-mu word list existed throughout the Mesopotamian region as well as its eastern neighbor, Elam, some with slightly altered order, some with expanded sections, and some with terse sections. The spatial distribution of the manuscripts of Ugu-mu covers many of the sites in southern Mesopotamia: Nippur, Ur, Larsa, Uruk, Harmal, Sippar, as well as Boghazköy, the Hittite capital in Anatolia. Note that it has not yet been found in Assyria.

has generously let us cite relevant passages. In addition, there are two further tablets from other private collections.

⁷ The estimate of 270 entries by Miguel Civil, “Ancient Mesopotamian Lexicography,” p. 2311, probably reflects the Nippur monolingual tradition.

The earliest exemplar that can be dated is that found in Uruk in the so-called Scherbenloch. Cavigneaux has argued that the Scherbenloch, which contained Ugu-mu among the mixture of school texts, administrative documents, and letters, represents a coherent archive to be dated between Rim-Sîn years 32 and 43.⁸ Accordingly, the Uruk school texts belong to the end of the early Old Babylonian period of lexical innovation.⁹ The Nippur and Ur exemplars date from the middle Old Babylonian period which ended with the crisis of Samsu-iluna's eleventh year.¹⁰ Although it was established as a definitive text in the second millennium, at which time it was very popular, the lexical text Ugu-mu did not survive into the first millennium B.C.¹¹ Furthermore, there are only two extant exemplars from late second millennium, one from Nippur in the center of Mesopotamia (13N 179, Nippur bilingual) and one from the periphery, from the Hittite capital in Anatolia (KBo 13 No. 2, Boghazköy in present-day Turkey).

THE LEXICAL LIST UGU-MU IN CONTEXT

It is most probable that the lexical list Ugu-mu was created in and for the school system. The characteristic tablet types used for pedagogic transmission of lexical texts are:¹² Type I prisms and large multi-columned tablets, Type II teacher-student exercises, Type III small one-column excerpt tablets, and Type IV round lentil-shaped tablets. Versions of Ugu-mu have been found written on all these tablet types. While nearly all the Nippur exemplars are Type II teacher-student exercises (with only a few exceptions), the editions from other cities span all types.

Although the distribution of tablet types indicates that Ugu-mu was definitely used in the teaching curriculum, its place in that curriculum is uncertain.¹³ Primary education in Nippur is known to have consisted of four phases: (1) elementary exercises, (2) thematic lists, (3) advanced lists, and (4) model contracts and proverbs.¹⁴ The teaching of Ugu-mu has been placed in the third grade, stage, or phase¹⁵ of this primary school education. In this grade or phase, the students supposedly learned the "advanced lists,"¹⁶ which included the metrological tables, sign lists, ac-

⁸ Cavigneaux, *Uruk, Altbabylonische Texte*, pp. 1–5.

⁹ On the dating of Old Babylonian lexical development, see Niek Veldhuis, "Elementary Education at Nippur: The Lists of Trees and Wooden Objects" (Ph.D. diss., University of Groningen, 1997), pp. 18 ff.

¹⁰ While there is meager evidence of the findspots of the early expeditions, the tablets from the post-World War II campaigns can be dated approximately (Veldhuis, "Elementary Education," p. 22). The unpublished source 3NT-920e is from room 191 in House F, a scholastic center, whose tablet collection has been studied by Eleanor Robson, "The Tablet House: A Scribal School in Old Babylonian Nippur," *Revue d'Assyriologie* 95 (2001): 39–66, and "More than Metrology: Mathematics Education in an Old Babylonian Scribal School," in *Under One Sky: Astronomy and Mathematics in the Ancient Near East*, edited by John M. Steele and Annette Imhausen, *Alter Orient und Altes Testament* 297 (Münster: Ugarit-Verlag, 2002), pp. 325–65. This house was built during the reign of Rim-Sîn and continued in use until the early years of the reign of Samsu-iluna; the tablets were found in secondary context used as construction rubble. Similarly, two other published sources were also found in the same level (X): A 30183 (3NT-234) in a small room in House J and A 30196 (3NT-286) in the "kitchen" of House K; for the discussions of the stratigraphy of these houses, see Elizabeth C. Stone, *Nippur Neighborhoods, Studies in Ancient Oriental Civilization* 44 (Chicago: The Oriental Institute, 1987), pp. 41–53, and 54–55. Although the Ur exemplars have lost their field numbers, they could be from no. 1 Broad Street where Ugu-mu appears in the catalogue of literary and scholarly texts (UET 5 86:19). Robson, "More than Metrology," p. 329, dates the tablets from no. 1 Broad Street to about 1790 B.C. (according to the Middle Chronology) and thus earlier than the Uruk school tablets from the Scherbenloch. The Old Babylonian tablets published in UET 7 were apparently not used by Charpin in *Le Clergé d'Ur*.

¹¹ Miguel Civil, "Lexicography," in *Sumerological Studies in Honor of Thorkild Jacobsen on His Seventieth Birthday*, edited by Stephen J. Lieberman, *Assyriological Studies* 20 (Chicago: The Oriental Institute, 1975), p. 127. Although D. Arnaud, *Texte aus Larsa*, *Berliner Beiträge zum Vorderen Orient Texte* 3 (Berlin: Dietrich Reimer, 1994), p. 9, has designated the Larsa bilingual text as Neo-Babylonian, its palaeography and orthography belie that designation. Its findspot E.F. XIII tells us little as these squares on the map of the 1933 first campaign show no activity in that locus. For the map, see André Parrot, "Les Fouilles de Tello et de Senkereh-Larsa, La 1^{re} Campagne à Larsa," *Revue d'Assyriologie* 30 (1933): pl. 2 (pp. 175–82).

¹² Identification of the four tablet formats is based on that established by M. Civil, "Ancient Mesopotamian Lexicography," pp. 2305–14, in particular p. 2308; and M. Civil, *The Series lú = ša and Related Texts, Materials for the Sumerian Lexicon* 12 (Rome: Pontificium Institutum Biblicum, 1969) [henceforth MSL 12], pp. 27 f.; M. Civil, *Ea A = nâqu, Aa A = nâqu, with Their Forerunners and Related Texts, Materials for the Sumerian Lexicon* 14 (Rome: Pontificium Institutum Biblicum, 1979) [henceforth MSL 14], pp. 5 ff. Further, see Steve Tinney, "On the Curricular Setting of Sumerian Literature," *Iraq* 61 (1999): 159–72, in particular 160; Veldhuis, "Elementary Education at Nippur," pp. 28–39; and Robson, "The Tablet House," pp. 39–66, in particular 45–47.

¹³ See discussions by Cavigneaux, "Lexikalische Listen," p. 611, where he suggests it follows Proto-Hh, Proto-Lu, Proto-Izi, Proto-Diri, and lú-azlag = ašlaku (OB Lu).

¹⁴ Veldhuis, "Elementary Education at Nippur," passim; and Robson, "The Tablet House," pp. 39–66.

¹⁵ The term "phase" is used differently by Veldhuis and Robson; Robson, "The Tablet House," p. 47, breaks down this phase of Veldhuis's into four phases.

¹⁶ Veldhuis, "Elementary Education at Nippur," p. 59.

rographic lists, mathematical tables, and also a few thematic lists such as Proto-Lu. Among the Type II tablets from the Old Babylonian Nippur school bearing Ugu-mu on one side and other text types on the other side, the evidence provides general confirmation of its suggested placement. That this was the case can be concluded from an analysis of obverse/reverse correlations in which the obverse holds the exercise to be learned and the reverse a repetition of a school text previously studied (see chart 1).¹⁷

Chart 1. The place of Ugu-mu in the curriculum. Obverse/reverse correlations.

	Ugu-mu			
	<i>Monolingual Obverse</i>	<i>Bilingual Obverse</i>	<i>Monolingual Reverse</i>	<i>Bilingual Reverse*</i>
<i>Hh. Thematic Lists</i>	GIŠ List (CBS 6476)	GIŠ List (CBS 19753) IM and KUŠ (CBS 11392) GI (CBS 2136+)	Hh. 21 Cities List (A 30196)	—
<i>Advanced Lists Acrographic</i>	Proto-Izi (CBS 6474) Nigga (CBS 11395, N 5333)	Proto-Izi 1 (CBS 9858) Nigga (UM 29-16-546) Multiplication Table (CBS 12708, UM 29-15-410)	Proto-Ea (UM 29-16- 546) Metrological List (A 30183) God List (N 5150)	—
<i>Model Texts and Proverbs</i>	—	—	Proverb Collections (CBS 6868, 7895, N 5308)	—
<i>Literary Texts</i>	—	—	Fable of the Crane and the Raven (CBS 6559+)	—

* B₄ UM 29-15-109 is the only tablet with bilingual reverse, but the text on the obverse is uncertain.

In the two first columns of chart 1, Ugu-mu occurs on the obverse, that is, when the student is just beginning to study the series. Thus, we can see that while the student was studying Ugu-mu he had already mastered Hh. in second grade. The next row shows that while the student was copying Ugu-mu, he had already learned the acrographic lists Proto-Izi,¹⁸ Nigga, and mathematical texts. This is the expected placement among the advanced lists. In the two last columns Ugu-mu occurs on the reverse, indicating that the student had already mastered Ugu-mu when beginning to study other series. Thus, we can see that in one example, the student had mastered monolingual Ugu-mu when beginning to learn Proto-Ea, the sign lists taught to advanced students entering the third grade, showing Ugu-mu had already been mastered before instruction in the sign lists.¹⁹ This is completely unexpected. Continuing down the column, we see, as expected, Ugu-mu mastered by the time the student began learning metrology, proverbs, and other pieces of literature.

It is interesting to note the existence of two tablets having the bilingual version on the obverse and the monolingual on the reverse (B₁₂/S₈ and B₁₀/S₁₉). Although these might be construed as ancient ponies or crib sheets, these specific exemplars do not have the same text on both sides. B₁₂ has section D 12–23 comprising the terms for hand and fingers, while S₈ contains various earlier sections; B₁₀ has D 18–28 comprising the terms for wrist through fingers, while S₁₉ has the voice section. This seems to indicate that the bilingual version of Ugu-mu was taught after the monolingual edition was mastered.

¹⁷ Veldhuis, "Elementary Education at Nippur," p. 35.

¹⁸ Niek Veldhuis places Proto-Izi after Proto-Lu and in the same curricular phase as Proto-Kagal and Nigga ("Elementary Education at Nippur," pp. 55 f.).

¹⁹ See the discussion of the place of Proto-Ea and Ea in scribal education by Niek Veldhuis, "Continuity and Change in the Mesopotamian Lexical Tradition," in *Aspects of Genre and Type in Pre-Modern Literary Cultures*, edited by Bert Roest and Herman Vanstiphout (Groningen: Styx Publications, 1999), pp. 106 f., 110 f.

THE PURPOSE AND FUNCTION OF UGU-MU

It has been suggested that Ugu-mu was a mnemonic device for teaching young schoolchildren who were trained in anatomical terms by having to point to their body parts. This suggestion was offered to explain the first-person possessive suffix on all the entries, the mu [ḡu] “my” of Ugu-mu “my ‘skull/cranium’.”²⁰ However, since it is impossible to point to all the internal organs, it appears that the extant manuscripts of Ugu-mu are the finished works of individual scholars. Further, the Ages of Man cannot be pointed out, nor can mental states. Consequently, a second opinion has been advanced that the presence of the first-person possessive suffix is due to a linguistic feature of the Sumerian language: in Sumerian, names of the parts of the body belong to the linguistic category of “obligatory possessed,” that is, a class of words that should normally be provided with a possessive.²¹ A precursor might be seen in two entries in the Ebla vocabulary: saḡ-SÙ (VE 259a MEE 4 227 with no Eblaite gloss)²² and SAG×NI-SÙ (VE 266c MEE 4 228 with Eblaite gloss *mu-hu-um*), where the suffix -sù may be an Akkadogram rendering the possessive suffix.²³ However, the Eblaite gloss does not translate the possessive.

ANATOMICAL KNOWLEDGE IN LEXICAL AND OTHER TEXTS

Disparate evidence exists concerning anatomical knowledge relating to the human body in ancient Mesopotamia. From the third millennium, there are entries in one Abū Ṣalābīkh text²⁴ and in several monolingual Sumerian lexical lists from the city of Ebla in Syria enumerating human body parts.²⁵ Further, there are additional terms for human body parts in the monolingual “éš-bar-kin_x” acrographic lists with scattered translations of certain terms from Sumerian into Eblaite, in the Ebla vocabulary.²⁶ On this basis we can deduce the existence of lists of body parts in the third millennium prior to Ugu-mu.

A contemporary Old Babylonian lexical text related to the body is the Sag Tablet²⁷ known from its incipit: saḡ meaning “head” in Sumerian is equated with “man” in Akkadian (saḡ = *awīlu*, “head = man”). It is of similar size to Ugu-mu, extending over 312 lines and having monolingual and bilingual versions. On the other hand, it is arranged acrographically according to the graphic shape of the written signs, rather than thematically according to the anatomical parts of the body. Consequently, items, terms, and states not pertinent to the human body are listed and it thus provides less anatomical information.

²⁰ Cavigneaux, “Lexikalische Listen,” p. 630; see Barbara Böck, *Die Babylonisch-assyrische Morphoskopie*, Archiv für Orientforschung, Beiheft 27 (Vienna: Institut für Orientalistik der Universität Wien, 2000), pp. 45 f.

²¹ Civil, “Ancient Mesopotamian Lexicography,” p. 2311.

²² Giovanni Pettinato, *Testi lessicali bilingui della biblioteca L. 2769*, Materiali Epigrafici di Ebla 4 (Naples: Istituto Universitario Orientale, Seminario di Studi Asiatici, 1982) [henceforth MEE 4]. It occurs in the monolingual éš-bar-kin_x list: Giovanni Pettinato, *Catalogo dei testi cuneiformi di Tell Mardikh, Ebla*, Materiali Epigrafici di Ebla 1 (Naples: Istituto Universitario Orientale, Seminario di Studi Asiatici, 1979) [henceforth MEE 1], No. 1861; and Sergio A. Picchioni, *Testi lessicali monolingui “éš-bar-kin_x”*, Materiali Epigrafici di Ebla 15 (Rome: Università degli Studi di Roma “La Sapienza,” Dipartimento di Studi Orientali, 1997) [hereafter MEE 15], No. 1 vii 30. See also 2-saḡ-SÙ VE 259b MEE 4 288 with no Eblaite gloss which appears in monolingual sources as 2-saḡ MEE 1 No. 4145 = MEE 15 No. 57 iv 01, and Robert D. Biggs and J. Nicholas Postgate, “Inscriptions from Abū Ṣalābīkh, 1975,” *Iraq* 40 (1978): 108 IAS 523 rev. iv 3, copy, p. 112.

²³ Manfred Krebernik, “Zu Syllabar und Orthographie der lexikalischen Texte aus Ebla 2 (Glossar),” *Zeitschrift für Assyriologie* 73 (1983): 12, where he explains the suffix -sù as the Eblaite possessive suffix and notes its absence in line 264.

²⁴ IAS 523 rev. (Biggs and Postgate, “Inscriptions from Abū Ṣalābīkh, 1975,” pp. 108, copy, p. 112). For the identification of this tablet

and its comparison to the Ebla lists, see Francesco Pomponio, “Notes on the Lexical Texts from Abū Ṣalābīkh and Ebla,” *Journal of Near Eastern Studies* 42 (1983): 285–90 (reference courtesy of Marco Bonechi).

²⁵ Giovanni Pettinato, *Testi lessicali monolingui della biblioteca L. 2769*, Materiali Epigrafici di Ebla 3 (Naples: Istituto Universitario Orientale, Seminario di Studi Asiatici, 1981) [henceforth MEE 3], Nos. 68, 70, 71.

²⁶ MEE 4; see also Picchioni, *Testi lessicali monolingui*, where further fragments of “éš-bar-kin_x” monolingual lists can be found. For discussion of items in the Ebla vocabulary, see Krebernik, “Zu Syllabar und Orthographie,” p. 8 and passim; Åke Sjöberg, “Notes on Selected Entries from the Ebla Vocabulary. eš₃-bar-kin₅ (II),” in *Munuscula Mesopotamica: Festschrift für Johannes Renger*, edited by Barbara Böck, Eva Cancik-Kirschbaum, and Thomas Richter, *Alter Orient und Altes Testament* 267 (Münster: Ugarit-Verlag, 1999), pp. 526 f. No. 266b, 529 No. 417; Åke Sjöberg, “Notes on Selected Entries from the Ebla Vocabulary. eš₃-bar-kin₅ (I),” in *Festschrift für Burkhardt Kienast*, edited by Gebhard Selz, *Alter Orient und Altes Testament* 274 (Münster: Ugarit-Verlag, 2003), pp. 543 f. Nos. 260, 265b.

²⁷ Miguel Civil, “The Sag-Tablet,” in *Materials for the Sumerian Lexicon, Supplementary Series*, vol. 1, edited by Miguel Civil, Oliver R. Gurney, and Douglas A. Kennedy (Rome: Pontifical Biblical Institute Press, 1986), pp. 1–41.

Later lexical traditions containing some anatomical information exist but do not provide a systematic approach to anatomy.

Outside of the lexical series, the human body is treated in the medical corpus, the major part of which is preserved only from the first millennium.²⁸ On the other hand, anatomical knowledge can also be gleaned from contemporary literary texts and magical incantations that make reference to body parts.

On the basis of the late material on the human body, it is clear that the Sumerian and Akkadian traditions in the field of anatomy are distinct. There is no one-to-one correspondence between the Sumerian and Akkadian terms despite their juxtaposition in lexical texts. For instance, it is apparent that *zé* means “gall, bile, a yellow bodily liquid” in Sumerian whereas it is equated with the organ *martu* “gall bladder” in Akkadian.²⁹ Consequently, one explanation for why *Ugu-mu*, which is based on Sumerian anatomical terminology, falls into disuse at the end of the second millennium is because it has become obsolete.

ANATOMY

In order to highlight the various problems in understanding this anatomical lexicon, we will concentrate on the first five lines. There are eight known versions of *Ugu-mu* containing this section (see chart 2).

Chart 2. First section of *Ugu-mu* lexical list.

<i>Ugu-mu</i>	<i>Nippur Monolingual*</i>	<i>Susa Monolingual</i>	<i>New Monolingual</i>	<i>Larsa Bilingual</i>	<i>Library of Congress 7</i>	<i>TIM 10 78</i>	<i>MS 2888</i>	<i>OECT 15 135</i>
ugu-mu	1	3	1	2	1	1	[1]	1
ugu-NI(dig)-mu	2	—	2	1	2	2	—	2
ugu-dílím-mu	3	2	3	3	3	[3]	5	3
sağ-du-mu	4	1	4	4	—	—	11	4
sağ-ki-mu	5	(5)	5	17(?)	—	—	—	5

* There are three manuscripts containing the first five lines of the *Nippur Monolingual* and two further containing lines 3–5, both of which are too broken to provide more than the first words of the lines in question.

The first issue that faces the scholar delving into *Ugu-mu* is the variation between versions and manuscripts.³⁰ The majority of versions begin with the line *ugu-mu*. The *Ur catalogue incipit* also gives evidence that this was the first line of the text in their tradition. Nevertheless, the *Susa Monolingual Ugu-mu* begins with line 4, *sağ-du-mu*, and the *Larsa bilingual Ugu-mu* begins with line 2, *[ugu]-NI-*mu*, attesting to different textual traditions. *MS 2888* has two partially preserved sections with five entries each on *ugu* and *sağ-da*, thus ten entries corresponding to the first four.

The second issue is the lack of correspondence between the Sumerian and Akkadian terms. For this section in particular, we are missing good bilingual manuscripts, as we shall see.

²⁸ See the overviews by Robert D. Biggs, “Medizin,” *Reallexikon der Assyriologie* 7 (Berlin: Walter de Gruyter, 1990): 623:25; and by Nils P. Heeßel, “Reading and Interpreting Medical Cuneiform Texts, Methods and Problems,” *Journal des médecines cunéiformes* 3 (2004): 2–9.

²⁹ Piotr Michalowski, “Carminative Magic: Towards an Understanding of Sumerian Poetics,” *Zeitschrift für Assyriologie* 71 (1981): 8 f., dis-

cussed by Thomas Richard Kämmerer, “Pathologische Veränderungen an Leber und Galle: Das Krankheitsbild der Gelbsucht,” *Revue d’Assyriologie* 94 (2000): 81–83.

³⁰ This is characteristic of Old Babylonian lexical lists in general; see Veldhuis, “Continuity and Change,” pp. 102, 105, 108 f.

LINE 1

The first entry, ugu-mu “my calvarium, cranium,” is seemingly simple. Nonetheless, the traces of the extant Akkadian translation pose the first problem. The only preserved Akkadian exists in the Larsa bilingual line 2: 𒄠𒌷-*hi*¹ and the copy of 𒄠𒌷 does not resemble /mu/. On the other hand, the equation ugu = *muḥḥu* is supposedly a well-known one in Sumerian and Akkadian. Yet, it is neither provided by the Old Babylonian lexical lists³¹ nor is it as common in Sumerian literature as expected.³²

One of the few Sumerian literary references is:

ᵈ[GIŠ.BÍL-ga-mes ḥa-zi]-ᵈin[?] 7 gú[?]-un[?]1-àm **ugu**-bi e-ne ba-an-sàg
gud-e **saḡ** 1l-la 1l-la im-ma-ab-diri ...
lugal-e **saḡ** gud-kam bí-in-gub ér gig ì-šěš(IGIXA)-šěš(IGIXA)

Gilgameš himself smote its **ugu** with his ax weighing seven talents.
Lifting its **saḡ** aloft the bull collapsed from a height
Standing by(?) the Bull’s **saḡ**, the king wept bitter tears.

(Gilgameš and the Bull of Heaven, *Meturan* 127–28, 132)³³

From this reference, it can be deduced that the ugu was differentiated from the saḡ; the ugu referring to the top of the head, the calvarium or cranium, while the saḡ was a general term for the whole head. Note that there is no entry saḡ in Ugu-mu, perhaps because of the Sag Tablet and perhaps because it was not considered an anatomically distinct lexeme and the term for the whole head is given below in line 4, saḡ-du. On the other hand, ugu is derived from U+SAG and the earlier third-millennium word lists from Ebla show a profusion of sag terms. In fact, two of the three lists of body parts have only terms for the head.

LINE 2

The second entry provides the first lexicographical puzzle. Although all traditions except that of Susa preserve the line ugu-NI, its meaning is not obvious. The Akkadian translations are only partially preserved (see chart 3). Since the Akkadian does not provide a translation for us, we are forced to concentrate on the Sumerian text. Let us look at possibilities regarding the meaning of the sign NI in Sumerian.

Chart 3. Skull section of Ugu-mu lexical list.

Sumerian	Akkadian	Translation
ugu-mu	𒄠𒌷- <i>hi</i> ¹	my calvarium / cranium
ugu-NI(dig)-mu	[...] <i>muḥḥija</i> / <i>qaqqadija</i>	my brain (lit., “my soft cranium”)
ugu-dílim-mu	<i>itqurti muḥḥija</i> / <i>qaqqadija</i>	my brain pan (lit., “the shallow bowl of my head”)
saḡ-du-mu	<i>qaqqadi</i>	my head
saḡ-ki-mu	(<i>pūti</i>)	my forehead

³¹ A.KA = *mu-úḥ-ḥu-um*, *e-li*, *a-še-er* OB Diri Nippur 299–301, in M. Civil, *The Series DIRI = (w)atru*, Materials for the Sumerian Lexicon 15 (Rome: Pontificium Institutum Biblicum, 2004) [henceforth MSL 15], p. 22, cf. later lists *ú-ga* A.SAG = *mikra*, *ú-gu* A.KA, *ú-gu* 𒄠𒌷²¹ = *muḥḥu*, *ú-gu* U.KA = *muḥḥu*, *eli*, *aššēr*, *qaqqadu*, *qablat qaqqadi*, *buppāni*, *sihip pāni* Diri III 142 ff. (MSL 15, p. 142); and *ú-gu* = *eli*, *muḥḥu* S^b 274–74a, in H. Schurter and B. Landsberger, eds., *Materialien zum sumerischen Lexikon* 3 (Rome: Pontificium Institutum Biblicum, 1955) [henceforth MSL 3], p. 120; B. Landsberger et al., eds., *Materialien zum sumerischen Lexikon* 4 (Rome: Pontificium Institutum Biblicum, 1956) [henceforth MSL 4], p. 207. See the discussion in Miguel Civil, “From Enki’s Headaches to

Phonology,” *Journal of Near Eastern Studies* 32 (1973): 58 ff. where he suggests reading A.KA as ugu₂ from possibly *agu or *abu.

³² The overwhelming majority of references in Sumerian literature are to the verb ugu “to give birth” found frequently in apposition to a- and ama and in the preposition “upon, from” derived from the noun ugu “skull.”

³³ Antoine Cavigneaux and Farouk N. H. al-Rawi, “Gilgameš et Taureau de Ciel (šul-mè-kam) (Textes de Tell Haddad IV),” *Revue d’Assyriologie* 87 (1993): 107 f.; see ETCSL (= J. A. Black, G. Cunningham, J. Ebeling, E. Flückiger-Hawker, E. Robinson, J. Taylor, and G. Zólyomi, *The Electronic Text Corpus of Sumerian Literature* [http://etcsl.orinst.ox.ac.uk/], Oxford 1998–2006) 1.8.1.2 *Meturan* Segment D 46, 47, 51.

Possibility (1), based on the most common reading of NI as ì “oil,” results in “my oil-anointed cranium(?)” Although sensible, this translation is to be discarded since it is not a description of a physical attribute of the body.

Possibility (2) depends on other readings of the sign NI. The reading dig is given in Proto-Ea 93 (MSL 14 35) and NI with the reading dig is equated with *narbu* adj. “moist, soft” in Ea II 14 (MSL 14 247). This yields “my soft cranium.” The tentative proposition of “soft” may refer to the child’s head whose skull bones are soft until they close and harden with age.

The third possibility (3) might be “my soft cranium” yielding “my brain.” This line might be compared to SAG×NI = *mu-ĥu* SAG in the Ebla vocabulary VE 264 (MEE 4 228)³⁴ “the *muhĥu* of the head.” Proceeding from the Akkadian verb *mahĥu* “to soak, to soften,” we arrive at a translation of *muhĥu* “soft part of the head” as the translation of the Eblaite. Note that it has been suggested that the basic meaning of **muhĥ* in Semitic is “brain,”³⁵ while **qa/udqa/ud* is “skull, head.”³⁶ Such a meaning of “brain” for *muhĥum* in Akkadian has recently been proposed by Marten Stol.³⁷ It is evident that the one Akkadian word *muhĥu* collapsed the Sumerian distinction between *ugu* “cranium” and *ugu-dig* “brain.”³⁸

LINE 3

For the third entry we have both the Sumerian term *ugu-dĥlim* and the Akkadian translation *it-qú-ur-ti qá-qá-di-ia*.³⁹ The Sumerian term was identified by Miguel Civil as “the upper part of the skull” on the basis of a verse from Enki and Ninĥursaġa describing the ailing parts of Enki’s body.⁴⁰ However, headaches such as Enki is suffering from are felt as exploding inside the skull rather than on top of the head. As to the Akkadian *it-qú-ur-ti qá-q[á-di-ia]* or *mu-uh-ĥi-ia*,⁴¹ the *itqurtu* is found as a “spoon for dipping up ointments” which is the characteristic implement of the physician and as a bowl for ointments.⁴² In either case, it is a concave vessel. Kramer’s guess “brain pan,” literally, the shallow bowl of my head, might thus be nearer the mark.⁴³ As to the anatomical identification, there are two possible sections of the skeletal structure of the cranium that can be described as a bowl or spoon: the inferior side of the cranium and the interior side of the cranium. The latter is shaped more like a concave vessel.

LINE 4

The fourth entry is the simplest of these five lines; the Sumerian lexeme *saġ-du*, its Akkadian translation *qaqqadu*, and a general understanding of its anatomical definition as “head” in general or “skull” in particular is commonly accepted.⁴⁴ This term refers to the head as a whole that can be cut off at the neck. For instance,

den-ki-du₁₀ íb-ba lipiš bal-a-ni gú-ni im-ma-an-ku₅
šà^{kuš}a-ġá-lá-šè mu-un-da-ġar

³⁴ SAG×NI also appears in one monolingual list MEE 3 68 i 5, and in several monolingual “éš-bar-kin_x” acrographic lists MEE 15 No. 1 vii 32 f., No. 9 i’ 10’, in addition to the Ebla vocabulary lines 264, 266a–d, 0346 i 90. For a reading of SAG×NI as *azad_x*, see the suggestion in Pennsylvania Sumerian Dictionary (PSD) A/1 202. This logogram appears to have two meanings in Ebla: (1) *mu-ĥu* SAG and (2) *qišti* (*gi-si-tum*) SAG. Whereas the latter may refer to the hair, the former has no such obvious connection. There seems to be no reason to follow the suggestion of the PSD.

³⁵ Alexander Militarev and Leonid Kogan, *Semitic Etymological Dictionary*, vol. 1, *Anatomy of Man and Animals* (Münster: Ugarit-Verlag, 2000), pp. 169 f. No. 187.

³⁶ A. Militarev and L. Kogan, *Semitic Etymological Dictionary*, pp. 144 f. No. 159.

³⁷ Review of CDA 1999, in *Bibliotheca Orientalis* 57 (2000): 628: “The primary meaning is in Semitic ‘brains, marrow’.”

³⁸ For a fuller discussion of the lexemes in Sumerian and Akkadian for “brain,” see our article “The Brain, the Marrow and the Seat of Cognition” in *Journal des médecines cunéiformes* 7 (2006): 1–10.

³⁹ In OECT 15 135:4 the line reads *ugu-NI-dĥlim-mu*. It is uncertain whether the NI should be understood as a scribal mistake or a meaningful addition.

⁴⁰ *ugu-dĥlim-mu ma-gig* “the top of my head hurts me” (Enki and Ninĥursaġa, line 252); see Civil, “From Enki’s Headaches,” 57 f., and

Pascal Attinger, “Enki et Ninĥursaġa,” *Zeitschrift für Assyriologie* 74 (1984): 45 “le sommet de ma tête.” (According to the online edition of ETCESL 1.1.1, this line is 255.)

⁴¹ This translation negates Civil’s postulation (“From Enki’s Headaches,” p. 58) that the Akkadian translation of *ugu-dili₂* is *abbuttu*.

⁴² E.g., *dĥlim-i-šéš* = *nap-šá-áš-tum*; see Nabnitu XXIII 339, in I. L. Finkel, *The Series SIG₇.ALAN = Nabnitu*, Materials for the Sumerian Lexicon 16 (Rome: Pontificium Institutum Biblicum, 1982) [henceforth MSL 16], p. 221, and CAD N/1 s.v. *napšaštu* “ointment, salve or spoon or bowl for ointments.”

⁴³ C. J. Gadd and S. N. Kramer, *Ur Excavation Texts*, vol. 6: *Literary and Religious Texts, Part 1* (London: British Museum, 1963), p. 2. According to the Oxford English Dictionary Online (Oxford University Press, 2005), “brain pan,” is that which contains the brain. It is composed with the lexeme “pan,” a shallow broad vessel.

⁴⁴ The Akkadian equation with *qaqqadu* is found in the Larsa bilingual *Ugu-mu* and in other Old Babylonian and later lexical sources, for example, Sag A i 37 (Civil, “The Sag Tablet,” p. 19), S^b I 245 (MSL 3, p. 116), and Hh. I 76 (B. Landsberger, *The Series ĤAR-ra = hubullu, Tablets I–IV*, Materialien zum Sumerischen Lexikon 5 [Rome: Pontificium Institutum Biblicum, 1957] (henceforth MSL 5), p. 15).

igi ^den-líl-lá-šè i-ni-in-ku₄-re-eš
 igi ^den-líl-lá-šè ka ki su-ub-ba-ni-ta
^{úg}a-ḡá-lá bí-in-šub saḡ-du-ni bí-in-è-dé
 igi ^den-líl-lá-šè im-ma-ni-in-ḡar-re-eš
^den-líl-le saḡ-du ^dhu-wa-wa igi ba-ni-in-du₈-a
 inim ^dBil₄-ga-mes šà bí-in-dab₅

Enkidu, full of rage and anger, cut his (Huwawa's) throat.
 He put (his head) in a leather bag.
 They entered before Enlil.
 After they had kissed the ground before Enlil,
 they threw the leather bag down, tipped out his head,
 and placed it before Enlil.
 When Enlil saw the head of Huwawa,
 he spoke angrily to Gilgameš

(Gilgameš and Huwawa, Version A 179–85)⁴⁵

Consequently, this term provides us only with an anatomical term of general import.

LINE 5

The Sumerian of the fifth entry is the familiar lexeme saḡ-ki. It appears on inscriptions from the earliest period:

á-zi-da-za ^dutu iri-è saḡ-ki-za IZI.DU.IGI.ÚS iri-kéš

At your right side Utu will rise, on your “forehead” a ...⁴⁶ will be bound.

(Stele of the Vultures, Ean. 1 vii 6–11)⁴⁷

Whereas the monolingual traditions agree on this entry, its Akkadian equivalent is uncertain. It is probably to be found in the Larsa bilingual line 17 in which the Sumerian is broken but the Akkadian reads *pu-ú-ti*. The equation of saḡ-ki with *pu-ú-tum* “forehead” is found in the Ebla vocabulary⁴⁸ and Old Babylonian and later lexical texts.⁴⁹ However, it is only one among other Akkadian translations, the most common of which is *nakkaptu* “temples.”⁵⁰ While it is apparent that Sumerian saḡ-ki does not distinguish between the forehead and the temples as does the Akkadian, its general anatomical placement can be deduced from citations such as:

saḡ-ki mu-un-da-an-gur₅-uš zú mu-un-da-UD.UD

He (Huwawa) furrowed his brow, baring his teeth at him.

(Gilgameš and Huwawa, Version B 125)⁵¹

⁴⁵ This is a composite text. For a score of the various sources, see Dietz Otto Edzard, “Gilgameš und Huwawa A. II. Teil,” *Zeitschrift für Assyriologie* 81 (1991): 228–29.

⁴⁶ For the latest discussion as to the identity of this object as a victory symbol, see Bendt Alster, “Images and Text on the *Stele of the Vultures*,” *Archiv für Orientforschung* 50 (2003/2004): 7. It is likely that this object should be a sign upon his forehead indicating the god's protection. See also Thorkild Jacobsen, “The Stele of Vultures Col. I–X,” in *Kramer Anniversary Volume*, edited by Barry L. Eichler, *Alter Orient und Altes Testament* 25 (Kevelaer/Neukirchen-Vluyn: Verlag Butzon & Bercker/Neukirchener Verlag, 1976), p. 253 n. 28 (“diadem”); Horst Steible, *Die altsumerischen Bau- und Weihinschriften*, part 2, *Kommentar zu den Inschriften aus “Lagaš.” Inschriften ausserhalb von “Lagaš.”* Freiburger altorientalische Studien 5/2 (Wiesbaden: Franz Steiner, 1982), p. 42 n. 44.

⁴⁷ For other translations, see Jacobsen, “The Stele of Vultures Col. I–X,” pp. 258 f., who translates “at your right Utu will rise for you, on your forehead a diadem(?) he will tie”; Horst Steible, *Die altsumerischen Bau- und Weihinschriften*, p. 125, who translates “an deiner rechten Seite wird dir der (Sonnengott) Utu aufgehen! Auf deiner Stirn wird dir ... angebunden sein!”; Jerrold S. Cooper, *Sumerian*

and Akkadian Royal Inscriptions, vol. 1, *Presargonic Inscriptions*, American Oriental Society Translation Series (New Haven: American Oriental Society, 1986), p. 34, who translates “The sun-(god) will shine at your right, and a ... will be affixed to your forehead.”

⁴⁸ saḡ-ki = *bi-a-tum* VE 251 b (MEE 4 227); see Militarev and Kogan, *Semitic Etymological Dictionary*, p. 180 No. 204 [2].

⁴⁹ Cf. saḡ-ki = *pu-tum* Sag A i 30 (Civil, “The Sag Tablet,” p. 18), saḡ-ki = *pu-ú-tum* Hh. I 77 (MSL 5 15), saḡ-ki = MIN (*pūtu*) Nabnitu I 82 (MSL 16 52).

⁵⁰ Cf. saḡ-ki = *zīmu*, *panu*, *hidirtu*, *sakkū*, *pūtu* Sag A i 26 ff. (Civil, “The Sag Tablet,” p. 18); *uzu.saḡ-ki* = *pu-ú-tum*, *nak-[kap]-tum* Hh. 15 11–11a (MSL 9 6); saḡ-ki = MIN (*būnu*) Nabnitu I 10 (MSL 16 51); saḡ-ki = *nak-kap-[tu]* Nabnitu 1 97 (MSL 16 53); saḡ-ki = MIN (*zīmu*) Nabnitu I 106 (MSL 16 53).

⁵¹ Dietz Otto Edzard, “*Gilgameš und Huwawa*”: *Zwei Versionen der sumerischen Zedernwaldepisode nebst einer Edition von Version “B,”* Bayerische Akademie der Wissenschaften, Philologisch-Historische Klasse, Jahrgang 1993, Heft 4 (Munich: Verlag der Bayerische Akademie der Wissenschaften, 1993), p. 30; see ETCSL 1.8.1.5.1 line 132.

Despite the lack of anatomical clarity, this is the most productive lexeme of this group of terms. Its use in symbolic imagery is significant, in particular to express emotions, such as in the compound verbs: *saḡ-ki—gíd* “to be angry, to frown (lit., to have a long forehead)” and *saḡ-ki—zalag* “to be pleased, to smile (lit., to have a shining forehead).”

ANATOMICAL KNOWLEDGE RELATING TO THE HUMAN SKULL

These five ancient Mesopotamian anatomical terms can be correlated with modern anatomical nomenclature. The **ugu** is either the calvarium, the domelike upper portion of the cranium composed of the superior portions of the frontal, parietal, and occipital bones, or the whole cranium which is formed of all the fused skull bones: the parietals, temporals, ethmoid, sphenoid, frontal, and occipital. The **ugu-dig** is the soft matter inside the cranium, the brain. The **ugu-dilim** is the interior side of the calvarium or the inferior side of the cranium. The **saḡ-du** is the skull, the skeletal structure of the head, composed of the facial and cranial bones. The **saḡ-ki** is the frontal bone which forms the forehead, a portion of the nose and the superior portions of the orbits.

To sum up, we have presented in this paper the earliest complete lexicon of physiological terms and shown its place in the educational curriculum. We have seen the Sumerian orientation of the lexical entries and their lack of direct correspondence with the Akkadian. In our work on Ugu-mu, we are attempting to deduce the anatomical knowledge of the ancient Mesopotamians. Some results of our progress in this direction are presented in this paper.

ICONOGRAPHY AND ART HISTORY

KING OF SUMER AND AKKAD, KING OF UR: FIGURAL TYPES, ASTRAL SYMBOLS, AND ROYAL TITLES IN THE NEO-SUMERIAN PERIOD*

Mehmet-Ali Ataç, Bryn Mawr College

The imagery on the cylinder seals of the Ur III period in Mesopotamia (ca. 2112–2004 B.C.) has a standardized and repetitive quality that has often been noted by scholars.¹ It has also been emphasized that we should not see this quality as a mechanical or uninspired repetitiveness in a pejorative sense, but should rather examine this imagery for its potential for greater significance.² The principal formula of this visual tradition, the presentation scene (figs. 1 and 2), has received substantial scrutiny in relevant iconographic studies.³ My objective here is to revisit elements of this important and long-lived ancient Mesopotamian visual formula from points of view that have not been fully explored, and which, I believe, are relevant to the theme of this volume, “Classifications of Knowledge in the Ancient Near East.” To this end, I should like to juxtapose and correlate three parameters that belong to the presentation of kingship in the Ur III period: figural types, the royal image in particular; astral symbols, a phenomenon that is lately receiving increased attention from scholars such that these signs are understood as more than just space fillers;⁴ and, finally, royal titles, some of which also appear in legends on seals.⁵ Variations in the way these parameters appear in visual and textual sources may not be random and may instead suggest certain patterns and significance, though by no means rigid, behind their use and articulation.

* I am grateful to Mete Ataç, Harriet Crawford, Benjamin Studevent-Hickman, and Irene Winter for valuable suggestions.

¹ See, for instance, E. Douglas Van Buren, “Homage to a Deified King,” *Zeitschrift für Assyriologie* 50 (1952): 92; Irene J. Winter, “The King and the Cup: Iconography of the Royal Presentation Scene on Ur III Seals,” in *Insight Through Images: Studies in Honor of Edith Porada*, edited by Marilyn Kelly-Buccellati et al., *Bibliotheca Mesopotamica* 21 (Malibu: Undena, 1986), p. 253; Dominique Collon, *First Impressions: Cylinder Seals in the Ancient Near East* (Chicago: The University of Chicago Press, 1987), p. 36; Irene J. Winter, “Legitimation of Authority through Image and Legend: Seals Belonging to Officials in the Administrative Bureaucracy of the Ur III State,” in *The Organization of Power: Aspects of Bureaucracy in the Ancient Near East*, edited by McGuire Gibson and Robert D. Biggs, *Studies in Ancient Oriental Civilization* 46 (Chicago: The Oriental Institute, 1991), p. 60; and R. Mayr, “Intermittent Carving of Seals in the Neo-Sumerian Period,” in *Seals and Seal Impressions*, edited by William W. Hallo and Irene J. Winter, *Proceedings of the XLV^e Rencontre Assyriologique Internationale*, part 2, Yale University (Bethesda: CDL Press, 2001), p. 53.

² Winter, “King and the Cup,” p. 253; Winter, “Legitimation of Authority,” p. 60; Claudia Fischer, “Siegelabrollungen im British Museum auf Ur-III-zeitlichen Texten aus der Provinz Lagaš: Untersuchung zu den Verehrungsszenen,” *Baghdader Mitteilungen* 28 (1997): 98.

³ In addition to the studies cited above, see Henri Frankfort, *Cylinder Seals: A Documentary Essay on the Art and Religion of the Ancient Near East* (London: Macmillan & Co., 1939), pp. 142–46; Judith A. Franke, “Presentation Seals of the Ur III/Isin-Larsa Period,” in *Seals and Sealing in the Ancient Near East*, edited by McGuire Gibson and Robert D. Biggs, *Bibliotheca Mesopotamica* 6 (Malibu: Undena, 1977), pp. 61–66; Piotr Steinkeller, “Seal Practice in the Ur III Period,” in *Seals and Sealing*, pp. 41–53; Richard L. Zettler, “Sealings as Artifacts of Institutional Administration in Ancient Mesopotamia,” *Journal of Cuneiform Studies* 39 (1987): 197–240; Martha Haussperger, *Die Einführungsszene: Entwicklung eines mesopotamischen Motivs von der altakkadischen bis zum Ende der altbabylonischen Zeit* (Berlin: Profil Verlag, 1997); R. Mayr, “The Seal Impressions of Ur III Umma” (Ph.D. diss., University of Leiden, 1997).

⁴ See, most recently, Irene J. Winter, “The Conquest of Space in Time: Three Suns on the Victory Stele of Naram-Sîn,” in *Assyria and Beyond: Studies Presented to Mogens Trolle Larsen*, edited by J. G. Dercksen (Leiden: Nederlands Instituut voor het Nabije Oosten, 2004), pp. 612 ff. Though not on visual arts, another recent work with a focus on ancient Mesopotamian astronomy is Francesca Rochberg, *The Heavenly Writing: Divination, Horoscopy, and Astronomy in Mesopotamian Culture* (Cambridge: Cambridge University Press, 2004).

⁵ See, for instance, Winter, “Legitimation of Authority,” p. 62.



Figure 1. Ur III cylinder seal impression depicting a presentation scene with seated god, ca. 2112–2004 B.C.
New York, The Pierpont Morgan Library 277E.



Figure 2. Ur III cylinder seal impression depicting a presentation scene with seated Ibbi-Sîn, 2028–2004 B.C.
New York, The Pierpont Morgan Library 292E.

FIGURAL TYPES

In iconography, one of the most well-known classifiers is the horned crown, which distinguishes its bearer as a divine being. Naram-Sîn's (2254–2218 B.C.) adoption of the divine determinative dingir in the writing of his name no doubt parallels his visual representations that show him wearing a horned helmet (fig. 3). In contrast to the horned crown of full divinities that features a set of multiple horns in ancient Mesopotamian art, Naram-Sîn's helmet is characterized by a single pair of horns in accordance with many Akkadian depictions that show lesser and sometimes even high gods wearing single pairs of horns.⁶

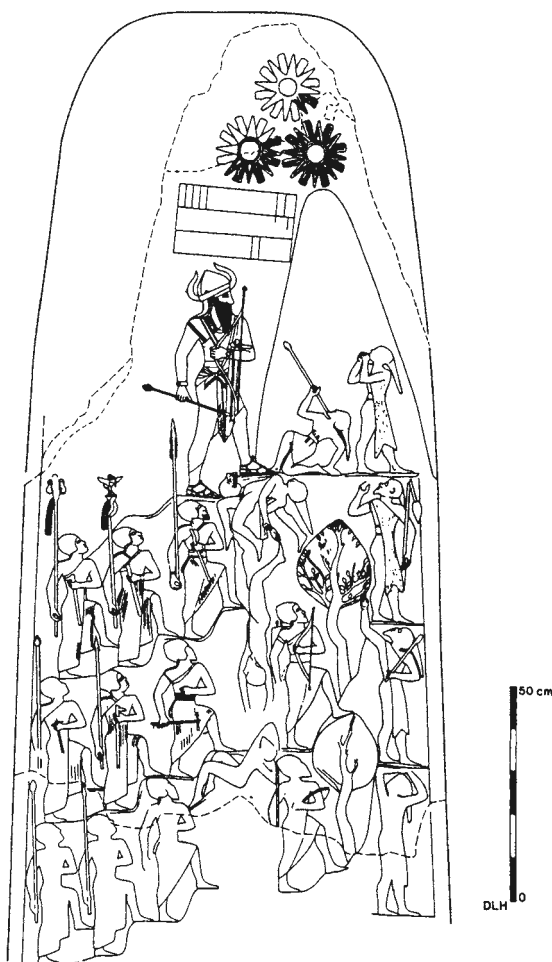

Figure 3. Drawing of the stela of Naram-Sîn, 2254–2218 B.C., by Denise Hoffman (after Winter, “Conquest of Space,” fig. 2. Paris, Musée du Louvre AO Sb4, reproduced by permission).

⁶ The horned helmet worn by Naram-Sîn on his stela has long been seen as the visual counterpart of the addition of the determinative for god, dingir, before his name in written records. See, for instance, Henri Frankfort, *The Art and Architecture of the Ancient Orient*, Pelican History of Art, fourth edition (New Haven and London: Yale University Press, 1970), p. 86; and Hans J. Nissen, *The Early History of the Ancient Near East 9000–2000 B.C.*, translated by Elizabeth Lutzier, with Kenneth J. Northcott (Chicago and London: The University of Chicago Press, 1988), p. 172. On the idea that “the divine crown worn by Naram-Sîn is not one of multiple tiers of horns, as worn by the high gods of the pantheon, but it rather consists of a single tier of horns, often used to distinguish lesser divinities on

seals,” see Irene J. Winter, “Sex, Rhetoric, and the Public Monument: The Alluring Body of Naram-Sîn of Agade,” in *Sexuality in Ancient Art: Near East, Egypt, Greece, and Italy*, edited by Natalie Boymel Kampen (Cambridge: Cambridge University Press, 1996), p. 24 n. 35. One should nevertheless note that there are examples of Akkadian glyptic that do show the high gods wearing crowns with single pairs of horns, such as BM 89548 (Collon, *First Impressions*, p. 109 n. 102), which shows the sun god rising from the mountains of the East. There are also presentation scenes that feature a gradation in the type of horned crowns depicting the seated god wearing a headdress “with more tiers of horns than the headgear of the interceding deity when present” (Winter, “King and the Cup,” p. 254).

As is well known, the Ur III adoption of the divine determinative dingir in the writing of the royal name from Shulgi (2094–2047 B.C.) onward is not paralleled by a horned headdress in the depictions of the Ur III kings. Instead, what we see in Ur III glyptic is the seated king in lieu of the seated god of the “classic” presentation scene configuration. The more traditional scene with seated god is perhaps best exemplified by the seal and certain fragmentary stelae of Gudea,⁷ on which the ensi is shown being led into the presence of a seated god (fig. 4). The fact that on seals the seated Ur III king now appears in a position formerly occupied only by the god might not be a direct visual indication of his deification, unlike, say, the horned crown; however, neither could the co-extensiveness of this visual development with the Ur III kings’ assumption of divine attributes from Shulgi on have been fortuitous.⁸ In two articles, Irene Winter analyzed in detail the mechanics and semantics of this iconographic shift, drawing attention to the fringed garment, occasionally alternating with the flounced dress, the skull cap now worn by the king, the treatment of the throne on which he is seated, as well as the cup that is sometimes held in his hand (figs. 1 and 2).⁹ I shall not therefore repeat these important observations and shall rather concentrate on a number of points that have not been addressed in detail in prior studies on Ur III iconography.

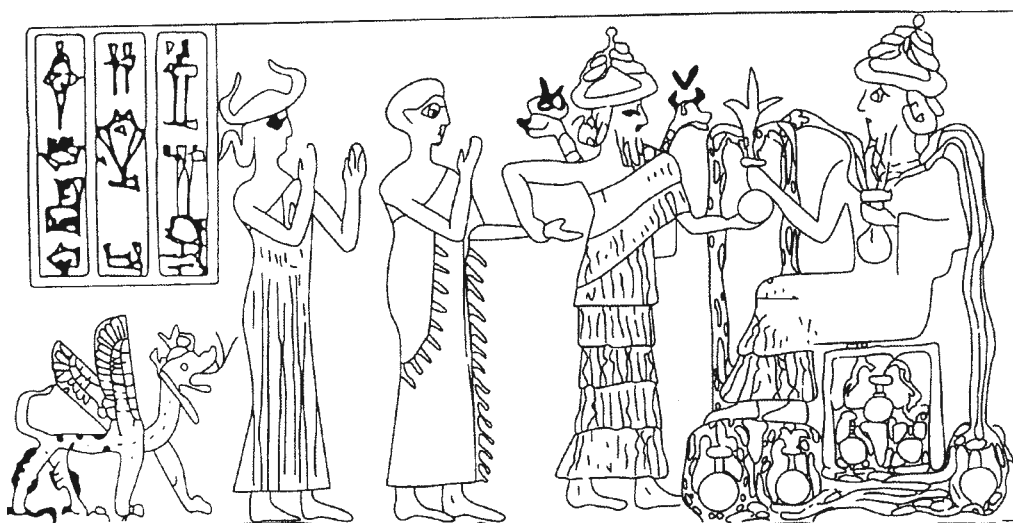

Figure 4. Drawing of the seal impression of Gudea, ca. 2100 B.C., based on two fragmentary impressions. Paris, Musée du Louvre AO 3541-2 (after Louis Delaporte, *Catalogue des cylindres, cachets et pierres gravées de style oriental*, vol. 1, p. 12).

⁷ Jutta Börker-Klähn, *Alt Vorderasiatische Bildstelen und vergleichbare Felsreliefs 2* (Mainz am Rhein: Philipp von Zabern, 1982), esp. pls. 35 and 41a–b. On the stelae of Gudea, see also Claudia E. Suter, *Gudea's Temple Building: The Representation of an Early Mesopotamian Ruler in Text and Image*, Cuneiform Monographs 17 (Groningen: Styx Publications, 2000), pp. 161 ff.

⁸ On this complex issue, see Winter, “King and the Cup,” pp. 256 ff., and Winter, “Legitimation of Authority,” p. 60. The divine implications of this position of the king in seal representations was taken for granted without much substantiation by Frankfort (*Cylinder Seals*, p. 146) and Van Buren (“Homage to a Deified King,” pp. 92 ff.), who both thought that the divine nature of the king was an outcome of his having participated in the “sacred marriage” ceremony, which the Ur III kings are indeed known to have practiced.

⁹ Winter, “King and the Cup,” pp. 256 ff.; Winter, “Legitimation of Authority,” pp. 60 ff. Before Winter, the manner in which the seated

king is depicted was also dealt with in some detail by Van Buren, “Homage to a Deified King,” pp. 93, 101. Claudia Fischer warns, however, that a neat classification of Ur III presentation scenes based on a consistent occurrence of certain attributes associated with the figures of the king and god may not be possible. For example, the fleece-covered stool often associated with the seated king may appear as the seat of a god, and the cup, also primarily associated with the king, may be held by a god not represented with a horned crown (Fischer, “Siegelabrollungen,” p. 130). Winter also notes a few such deviations from the “standard” in the representation of the king that entail attributes that are usually associated with the god, such as the flounced dress and the “seat approximating the architectural façade” (“King and the Cup,” p. 255).

Also prevalent in the Ur III version of the presentation scene is the occurrence of an astral entity composed of a solar orb inscribed in the crescent moon, prominently depicted between the seated god or king and the approaching group of standing figures (figs. 1 and 2). We see the same element in what little remains from the monumental art of the period, for example, on the stela of Ur-Namma (fig. 5). Most reconstructions of this monument seem to agree on the presence of an entity, simultaneously solar and lunar, on the apex of the obverse.¹⁰ When we juxtapose the obverse of the Ur-Namma stela with the composition on the stela of Naram-Sîn, without losing sight of the difference in subject matter—and perhaps function as well—between these two monuments, we realize that there is an emphasis on purely solar elements on the Akkadian stela, whereas the stela of Ur-Namma rather favors a conjugal formula bringing together these two major astral entities of the heavens. On a rather playful level, it is as if the horns of Naram-Sîn's crown had migrated upward to join the solar element on the stela of Ur-Namma.

When we look at the royal figures on these stelae, we see comparable lavish beards on both, but different head-dresses, as already noted. Even though the deification of the Ur III kings came about with the reign of Shulgi,¹¹ it is the same figural type that characterizes the royal image in both the Ur-Namma stela and later Ur III glyptic representations. Given the affinity between the Akkadian and Ur III states in terms of efforts to establish central authority over what is essentially a pluralistic political tradition,¹² it is reasonable to think that iconographically the Ur III period would draw upon aspects of Akkadian representational strategies, regardless of the absence of the horned headdress for royal figures.

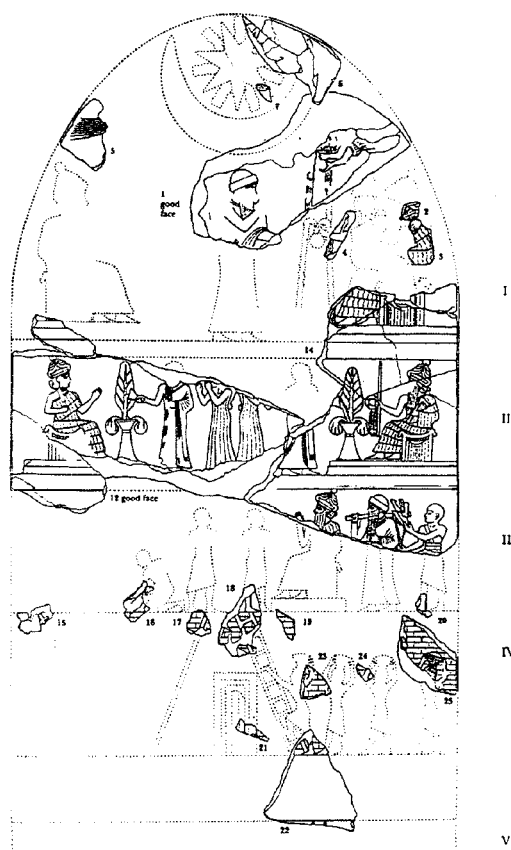

Figure 5. Reconstruction drawing of the obverse of the stela of Ur-Namma, 2112–2095 B.C. Philadelphia, The University of Pennsylvania Museum of Archaeology and Anthropology CBS 16676.14, reproduced by permission.

¹⁰ See, for instance, Jenny Vorys Canby, *The “Ur-Nammu” Stela*, University Museum Monograph 110 (Philadelphia: University Museum, 2001), p. 14.

¹¹ The divine determinative dingir preceding the king's name was integrated by Shulgi to both his own name and posthumously to that of his father Ur-Namma. On this matter, see William W. Hallo, *Early Mesopotamian Royal Titles: A Philologic and Historical Analysis* (New Haven: American Oriental Society, 1957), pp. 60, 125; Claus Wilcke, “Zum Königtum in der Ur III-Zeit,” in *Le palais et la royauté (Archéologie et Civilisation)*, edited by Paul Garelli, 19^e Rencontre

Assyriologique Internationale, Paris (Paris: P. Geuthner, 1974), pp. 177 ff.; and Winter, “King and the Cup,” p. 256. For an identification of the time range between his tenth and twentieth year of reign as the exact period in which Shulgi was deified, see Walther Sallaberger, “Ur III-Zeit,” in Walther Sallaberger and Aage Westenholz, *Mesopotamien: Akkade-Zeit und Ur III-Zeit*, *Orbis Biblicus et Orientalis* 160/3 (Freiburg: Universitätsverlag, 1999), p. 152.

¹² On the ancient Mesopotamian oscillation between “centralism and particularism,” see Nissen, *Early History*, pp. 165 ff.

This approach can be furthered by another visual juxtaposition, this time one between the Ur III king and the more or less contemporary ensi of Lagash, Gudea (ca. 2100 B.C.). Carried away by the unique plasticity and portrait-like elements of the statues of Gudea, one is often apt to forget that what we in fact see here is a formulaic figural type: bald and wearing the fringed robe (fig. 4).¹³ This is the very figural type that appears in Ur III presentation scenes as the individual presented to the seated god or king, often referred to, perhaps erroneously, as the worshiper. One other instance in which the Ur III king is shown by means of this figural type is the foundation figurine, even though such figurines show the ruler with a bare torso rather than wearing a fringed garment.¹⁴ They further represent him carrying a basket of clay to mold a brick or mortar to lay it.¹⁵ Certain examples depict Ur-Namma bald and clean-shaven, virtually identical in facial appearance with images of Gudea (fig. 6).



Figure 6. Foundation figurine of Ur-Namma holding a basket (New York, The Pierpont Morgan Library MLC2).

¹³ In this regard, see Suter, *Gudea's Temple Building*, p. 57. It is important to note, nevertheless, that there is a degree of overlap in such presentation scenes between the seated king and the worshiper, since whereas certain images of Gudea show him bare-headed, especially those on stelae, many, particularly the statues, represent him wearing the rounded cap associated with the ruler figure, with the simple fringed garment draped over one shoulder as the unchanging element in both of these guises of the ensi. Further, even though the majority of the seated king figures in Ur III presentation scenes are bearded, some are beardless. See, for instance, the typological study on the royal figure in Marie-Thérèse Barrelet, avec une contribution de J.-M. Durand, "La 'figure du roi' dans l'iconographie et dans les textes depuis Ur-Nanše jusqu'à la fin de la I^{re} dynastie de Babylone," in *Le palais et la royauté*, p. 52 and fig. 1 (F.100-1), for the two sub-categories of the seated royal figure in the Ur III period, as exemplified by the bearded and beardless representations of Ibbi-Sîn (2028–2004 B.C.). For a depiction of the beardless Ibbi-Sîn on a cylinder seal, see also Joan Aruz, with Ronald Wallenfels, eds., *Art of the First Cities: The Third Millennium B.C. from the Mediterranean to the Indus* (New York: Metropolitan Museum of Art; New Haven

and London: Yale University Press, 2003), p. 448, fig. 320. On representations of the seated king depicting him either bearded or beardless, and wearing either a flounced or a fringed robe, see also Collon, *First Impressions*, p. 37. The "worshiper," however, is "always shaven-headed and beardless, wears a fringed robe with curved ends and raises his right hand" (*ibid.*, p. 36).

¹⁴ Figurines first appear under Gudea, but become standard in Ur III times and thereafter (Suter, *Gudea's Temple Building*, p. 61).

¹⁵ The classic study on foundation figurines is Richard S. Ellis, *Foundation Deposits in Ancient Mesopotamia*, Yale Near Eastern Researches 2 (New Haven and London: Yale University Press, 1968), especially p. 23, where it is stated that the canephorous foundation figurines of both Gudea and Ur-Namma in all likelihood represent the ruler himself. Some ambiguity nevertheless exists in that "the figurines have no features that could indicate rank or identity; the dress is restricted to a knee-length kilt in Gudea's figures, and is not shown at all on later ones. To judge from the appearance, they could represent any worker." Ellis points out, however, that the ruler did perform manual labor, albeit in a ritualized sense, and he assumes "that it is the ruler who is represented in the figurines."

One wonders in this regard if the bearded appearance of Ur-Namma on his stela within the context of a ceremonial building activity is an anomaly within both the extant record of the Neo-Sumerian period and the greater tradition of such scenes in Sumerian culture (figs. 5 and 7). The figure appears on the obverse of the stela in the third register from the top, walking toward the left with various tools, “preceded by a god and followed by a man with shaven head and face, who adjusts or helps with the burden.”¹⁶ The extant sculptural representations of Gudea, many of which are directly or indirectly associated with temple building, never depict the ensi with a beard. Likewise, Ur-Nanshe of Lagash is shown without a beard on his well-known plaques from the Early Dynastic period.¹⁷ The fact that the bearded ruler figure is so strictly absent from representations of Gudea while it is ubiquitous in the Ur III visual record might lead one to make a connection between this difference in visual conventions and in political ideology between these two manifestations of the so-called Neo-Sumerian renaissance. Whereas Gudea was always ensi of his city-state Lagash, Ur III kings were certainly lugal in charge of a greater territorial state.¹⁸ It is from this standpoint that I would suggest the existence of a subtle “Akkadianizing” element in the bearded image of the Ur III ruler, perhaps clear in relatively larger-scale depictions such as that on the Ur-Namma stela, especially when viewed in comparison with representations of Akkadian rulers with long and lavish beards.¹⁹

When one looks at the fragment from the stela of Ur-Namma that shows the king with building tools, we see all three figural types in question here presented in a gradation from left to right, as if they constituted a catalogue: the god wearing the horned crown; the bearded king who is ruler over a territorial state, albeit without a horned helmet; and what is in great likelihood a priestly official assisting in the ceremony, who “looks more like the [royal]



Figure 7. Partial view of a fragment of the stela of Ur-Namma, 2112–2095 B.C. Philadelphia, The University of Pennsylvania Museum of Archaeology and Anthropology CBS 16676.14, reproduced by permission.

¹⁶ Ellis, *Foundation Deposits*, pp. 22–23; see also Canby, “Ur-Nammu” Stela, p. 20.

¹⁷ Anton Moortgat, *The Art of Ancient Mesopotamia: The Classical Art of the Near East* (London and New York: Phaidon, 1969), pls. 109 and 111.

¹⁸ The exact significance of the terms ensi and lugal with respect to one another throughout the early history of ancient Mesopotamia is still rather controversial. According to Piotr Steinkeller, even though ensi and lugal are complementary titles that describe the same kind of kingship, ensi has religious overtones in defining “the status of a ruler in his rapport with the divine owner of the city-state,” whereas lugal “describes the position of a ruler in relation to his subjects as their chief political and military leader.” In this respect, according to Steinkeller, “Eannatum, though an ensik of Lagash vis-à-vis Ningirsu, is a lugal of Lagash on the level of socio-political relationship” (“On Rulers, Priests and Sacred Marriage: Tracing the Evolution of Early Sumerian Kingship,” in *Priests and Officials in the Ancient Near East: Papers of the Second Colloquium on the Ancient Near East – The City and its Life Held at the Middle Eastern Culture Center in Japan [Mitaka, Tokyo]*, edited by Kazuko Watanabe [Heidelberg: C. Winter,

1999], p. 112). For a comparable opinion, see Nissen, *Early History*, p. 140. In his classic work *Early Mesopotamian Titles*, Hallo sees lugal as the royal title par excellence in ancient Mesopotamia (p. 10), and, although he understands ensi as a title that connotes subordination with respect to lugal, he does present many instances from the pre-Sargonic period in which ensi was a full royal title (pp. 34 ff.). Hallo nevertheless notes that by the late Sargonic period, ensi simply meant “‘titular head of a city and its dependent territories’ and was applied wherever tradition associated no other title with the city” (*ibid.*, p. 45). For a skeptical view on the utility of speculating on the definitions of royal titles such as en, ensi, and lugal in light of available sources, see Dietz Otto Edzard, “Problèmes de la royauté dans la période présargonique,” in *Le palais et la royauté*, esp. p. 149.

¹⁹ In addition to the figure of Naram-Sin on his stela, examples include the well-known bronze head found in Nineveh, thought to depict an Akkadian ruler, and another unprovenanced bronze head now in the Metropolitan Museum of Art in New York. For images of these two heads, see Moortgat, *Art of Ancient Mesopotamia*, pl. 154; and Joan Aruz and Ronald Wallenfels, eds., *Art of the First Cities*, fig. 136, respectively.

canephorous statues than does the king.”²⁰ In short, what is at stake here is a number of types of royal and non-royal images, the use of which in the visual record is fluid, perhaps also elastic, but by no means random. The use of each type of image must no doubt have been governed by rules of decorum that are not always mechanically rigid and consistent.

In analyzing the figural types especially within the context of the presentation scene it is also worthwhile to probe the stratification and hierarchical relations that may be thought to exist among them. In her 1991 work, Winter took issue with the older idea that Ur III presentation scenes that feature the seated king mainly entailed the depiction of “homage to a deified king” in a purely cultic sense.²¹ She argued that this position of the king rather denoted his being the recipient of petitions, giver of justice, and maintainer of order in the land, and that “worship and audience, ritual and civil petition, and sacred as opposed to secular were not subject to modern divisions.”²² Winter further emphasized that this configuration conveyed information regarding the place of the seal owner within the administrative hierarchy. It signaled the legitimate authority of the seal owner, as granted by the king, to exercise his office within the Ur III bureaucracy, and the legitimate authority of the king himself to grant the particular office to the seal owner and exercise his own divinely-sanctioned rule.²³ Hence the royal presentation seal, parallel to the phenomenon of the “deification” of the Ur III ruler, reveals the addition of a fourth tier to the Ur III social and political hierarchy with a central authority now presiding over local authorities, as illustrated graphically in Winter’s article (fig. 8).²⁴

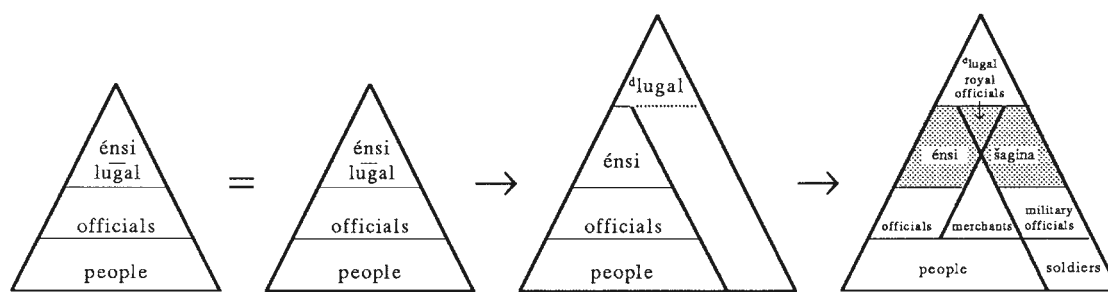

Figure 8. Schematic Model of Administrative Reorganization under Shulgi (after Winter, “Legitimation of Authority,” fig. 1, reproduced by permission).

Without questioning Winter’s principal observations relating seal imagery and legend to the socio-political structure of the Ur III period, I would like to suggest that the religious or sacred component addressed by the seal imagery can co-exist with the socio-political and should not be confined to the “worship” of or “homage” to a deified king.²⁵ In this regard, one can talk about a conceptual dimension behind this configuration that goes beyond a particular activity, be it audience, worship, homage, or petition. From the point of view of *Wissenschaftsgeschichte*, whereas the scholars of the 1980s and 1990s turned away from the views of a previous generation of scholars who tried to explain everything from a religious perspective without sufficient substantiation and favored exclusively socio-political approaches instead, it may now be useful to explore the religious dimension again in greater conscientiousness and nuance.²⁶

²⁰ Ellis, *Foundation Deposits*, p. 23.

²¹ Winter, “Legitimation of Authority,” p. 75.

²² *Ibid.*, p. 60; see also Winter, “King and the Cup,” p. 253.

²³ Winter, “Legitimation of Authority,” p. 60.

²⁴ *Ibid.*, p. 76.

²⁵ An attempt to look at the religious dimensions of the presentation scene from an alternative perspective is also Christopher G. Frechette, “The Name of the Ritual: Investigating Ancient Mesopotamian ‘Hand-Lifting’ Rituals with Implications for the Interpretations of Genre in the Psalms” (Th.D. diss., Harvard University, 2005), in which notions

of salutation, auspiciousness, and reciprocity are highlighted in relation to the “client” and the “patron” of the presentation.

²⁶ Winter, for instance, expresses her reaction to this 1950s school as represented by Henri Frankfort and E. Douglas Van Buren by pinpointing the subtitle of Frankfort’s *Cylinder Seals: A Documentary Essay on the Art and Religion of the Ancient Near East* (emphasis mine). Interest in the relationship between the visual arts and the political and economic systems from which they derive has developed more recently, and markedly so over the past fifteen years” (“King and the Cup,” p. 254).

In order to approach this matter in a broader framework, I would like to appeal to a visual phenomenon from ancient Egypt, a culture that displays many systemic parallels with Mesopotamia. What one might identify as a kind of presentation scene is found in Egypt as well. On a scene from the tomb of the Nineteenth Dynasty king Sety I, we see Horus leading the king into the presence of the enthroned Osiris (fig. 9), just as Gudea, ruler of Lagash, is led into the presence of a seated supreme god by his personal god Ningishzida on both his seal and at least one of his stela (fig. 4).²⁷ Given the mortuary context of most of Egyptian art, the relation between the king and god here is clear: the king's assimilation to Osiris in the afterlife.²⁸ In an example of the royal version of the Egyptian presentation scene, we see a bureaucrat, Userhet, approaching king Thutmose I (1504–1492 B.C.) depicted in his identity with Osiris (fig. 10).²⁹ No doubt this encounter, albeit without an interceding divinity, is more than simply homage, offering, or worship.³⁰ It further ensures the non-royal deceased's participation in the favorable afterlife guaranteed for the now “Osirified” king, in addition to showing his merits to deserve both the tomb and such a promise.³¹

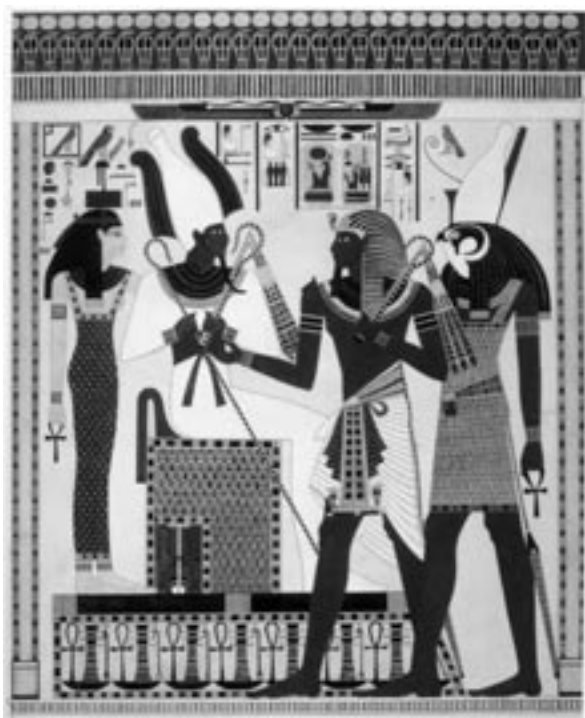

Figure 9. Scene with enthroned Osiris on the rear wall of the upper pillared hall in the tomb of Sety I, 1306–1290 B.C., Nineteenth Dynasty (watercolor rendering by James Burton, ADD 25641 f53, by permission of The British Library).

²⁷ For presentation scenes in the art of Gudea as well as a discussion on the identity of the seated god on the seal of Gudea, see Suter, *Gudea's Temple Building*, pp. 66 ff.

²⁸ *Pyramid Texts*, Utterance 219, R. O. Faulkner, trans., *The Ancient Egyptian Pyramid Texts* (Oxford: Clarendon Press, 1969, Special Edition 1998), pp. 46–48.

²⁹ On the appearance of the pharaoh in the tombs of his subjects, see also H. A. Groenewegen-Frankfort, *Arrest and Movement: An Essay on Space and Time in the Representational Art of the Ancient Near East* (London: Faber & Faber, 1951), pp. 78 ff.

³⁰ I am unable to delve into a discussion of the typology of Ur III presentation scenes within the confines of this essay. However, scholars have recognized the unmediated encounter between a seated king and a standing bureaucrat as a form of presentation scene as well, one that



Figure 10. Drawing of wall paintings from the Tomb of Userhet: “The upper part shows the worship of Osiris by Userhêt and his family; the lower, their adoration of Thothmes I and his Queen, of whose mortuary cult Userhêt was priest,” Thebes, Nineteenth Dynasty (after Norman de Garis Davies, *Two Ramesside Tombs at Thebes* [New York: Metropolitan Museum of Art, 1927], pl. 5).

perhaps signaled a closer relationship between the official and the seated king. See, for instance, Franke, “Presentation Seals,” pp. 64 ff.; Winter, “Legitimation of Authority,” p. 66; Mayr, “Intermittent Recarving of Seals,” p. 53, where this type of scene is termed “a *salutation scene*” and its far less common occurrence in Ur III glyptic is mentioned; and Fischer, “Siegelabrollungen,” p. 131, where the type is referred to as an “audience” scene.

³¹ See, for instance, Christine Beinlich-Seeber and Abdel Ghaffar Shedid, *Das Grab des Userhat (TT 56)*, *Archäologische Veröffentlichungen* 50 (Mainz am Rhein: Philipp von Zabern, 1987), p. 25. The configuration of the deceased directly and closely facing the seated divine king is understood in this case as an indication of the closeness of the tomb owner to the ruler.

What I would like to suggest is that the hierarchical relationship between the king and the official may not only be a matter of socio-political classification as mapped out by Winter's pyramidal chart, but an ontological one in the Ur III visual record as well. Though not of any mortuary significance, the cylinder seal was more than just an administrative object; it was one that was carried, worn, and appreciated for its amuletic value by its owner.³² Given that the king's divinity in the Ur III period cannot be divorced from his acting in lieu of the deity in presentation scenes, one might consider this relation between the official and the king in glyptic art as one in which the official also aspires to partake of the godlike privileges of the king, especially since such seals are "restricted to a class of highly public officials ranking just below the king."³³ In other words, what we would then see in the royal presentation scene is perhaps a formulaic visual expression of "initiation" whereby the potential initiate is led into the presence of a figure who qualifies as an initiator on account of his special qualities.³⁴ This configuration would by no means conflict with the administrative function of the cylinder seal, especially within a theocratic political system in which the king was divine and the bureaucrats themselves were members of an intellectual elite.

In light of this suggestion, the clean-shaven figural type wearing the fringed garment may be thought to reflect the formulaic representation of an administrative-cum-sacerdotal character, of which the ensi Gudea is certainly the hallmark, and to which the leading members of the second tier of the Ur III bureaucratic system may be thought to aspire.³⁵ I would venture to go even further and suggest that the clean-shaven image of the ruler is one that shows him in his capacity as the ultimate initiate. The other, bearded appearance of the Sumerian king may hence have reflected a subdued degree of Akkadianization, a "heroized" king without overt divine attributes,³⁶ while the clean-shaven figural type certainly continued to function as a royal image in certain distinctive contexts that perhaps entailed a greater devotional or sacerdotal character. The "bearded" image, however, would also have been deemed appropriate for representing the master or the initiator receiving the candidate. The whole picture is perhaps not unlike the use of the terms *lugal* and *ensi*: both royal titles, but with differently nuanced semantics.

Finally, the presentation scene has also been understood in relation to the domain of rendering judgment and "just decisions" on the part of both kings and gods, with the seated figure as the one who exercises such authority.³⁷ The semantic affinity of the presentation scene to the act of rendering judgment can be seen in a group of Akkadian presentation scenes of mythological content that depict a bird-man brought before the seated Enki/Ea for judgment.³⁸ In the ancient Mesopotamian tradition, it is especially the sun god Utu/Shamash who is most closely associated with judgment, and this god's nocturnal descent to the netherworld, as in Egypt, can be seen as an extension of his "judicial" faculties to the affairs of the afterlife.³⁹ In fact, ancient Egyptian scenes of post-mortem judgment

³² Collon, *First Impressions*, p. 13.

³³ Winter, "Legitimation of Authority," p. 60; see also *ibid.*, p. 78.

³⁴ Even though discussions of the concept of initiation are rare in ancient Near Eastern studies, the notion should by no means come across as vague or "esoteric" in an eccentric way, since it is certainly addressed in its proper sense in the scholarly literature. See, for instance, W. G. Lambert, *Babylonian Wisdom Literature* (Oxford: Clarendon Press, 1960), p. 2, where it is stated that in ancient Mesopotamian diction several adjectives for "wise" are rarely used with a moral content: "Generally 'wisdom' refers to skill in cult and magic lore, and the wise man is the initiate." Other studies that deal with notions of initiation include Dominique Prévot, "L'épopée de Gilgamesh: un scénario initiatique?" in *Homo Religiosus 13, Les rites d'initiation, Actes du Colloque de Liège et de Louvain-la-Neuve, 20-21 novembre 1984*, edited by Julien Ries (Louvain-la-Neuve: Centre d'Histoire des Religions, 1986), pp. 225-41; Alasdair Livingstone, *Mystical and Mythological Explanatory Works of Assyrian and Babylonian Scholars* (Oxford: Clarendon Press, 1986); Livingstone, *Court Poetry and Literary Miscellanea*, State Archives of Assyria 3 (Helsinki: University of Helsinki Press, 1989); Paul-Alain Beaulieu, "New Light on Secret Knowledge in Late Babylonian Culture," *Zeitschrift für Assyriologie* 82 (1992): 98-111.

³⁵ In principle, such an expression of hierarchy between an official or scribe and the king from an ontological perspective is not unlike levels of initiation that characterize certain later secret organizations.

³⁶ Barrelet also sees the bearded representation of the ruler along similar lines, stating that this guise of the royal figure shows him trium-

phant and "heroized," but not necessarily "deified" ("Figure du roi," p. 58).

³⁷ Winter, "King and the Cup," pp. 260 ff. Winter has specifically proposed a connection between the seated king holding the cup and the antediluvian king-sage of Sippar, Enmeduranki, who was the recipient of the craft of oil divination, *bārūtu*, from the gods Shamash and Adad. If Winter's hypothesis is correct, Enmeduranki would certainly also qualify as a master initiator on the basis of his having received a priestly craft directly from the gods. On Enmeduranki, see also W. G. Lambert, "Enmeduranki and Related Matters," *Journal of Cuneiform Studies* 24 (1971/72): 126-38.

³⁸ Winter, "King and the Cup," p. 254; Collon, *First Impressions*, p. 178 nn. 847-49.

³⁹ On the Mesopotamian "belief in a sungod who brings light to the netherworld where he functions as judge," see Wolfgang Heimpel, "The Sun at Night and the Doors of Heaven in Babylonian Texts," *Journal of Cuneiform Studies* 39 (1987): 146. In ancient Egypt as well, the main purpose of the sun god's descent to the netherworld is the caring for Osiris and sending his enemies to slaughter. On Egyptian concepts of judgment in the afterlife, see, for instance, Erik Hornung, *The Ancient Egyptian Books of the Afterlife*, translated from the German by David Lorton (Ithaca and London: Cornell University Press, 1999), esp. pp. 56 ff. and 85. On the Mesopotamian sun god tradition in relation to the destinies, see Janice Polonsky, "Ki-^dutu-^a: Where Destiny is Determined," in *Landscapes: Territories, Frontiers and Horizons in the Ancient Near East, Papers Presented to the XLIV^e Rencontre Assyriologique Internationale, Venezia 7-11*

in the netherworld again feature a form of presentation scene, with the deceased shown being led by the hand to the place of judgment presided over by Osiris, a god who has at once chthonic and solar characteristics (fig. 11).⁴⁰ This close semantic affinity of the concept of judgment to the afterlife in both Mesopotamia and Egypt further ties such “judicial” notions, in both the visual and textual realms, with those of initiation inasmuch as the latter is concerned with the mysteries of death and the beyond.



Figure 11. Horus introducing the Scribe Ani to Osiris, from the Papyrus of Ani, BM Pap., No. 10470 (after *The Book of the Dead* [British Museum, 1922], p. 28).

ASTRAL SYMBOLS

It might also be rewarding to see if the astral signs that appear in both monumental and glyptic art in both the Akkadian and Ur III periods reflect patterns of signification comparable to those dealt with in relation to figural types. As already pointed out, one particularly novel element that characterizes Ur III presentation scenes is the appearance of a prominent emblematic element formed by the conjunction of the sun and the crescent moon. Even though the presence of this conjugal astral element in the Ur III visual record has been noted by scholars,⁴¹ surprisingly no attempt has been made to probe its semantics. Ancient Mesopotamian iconography clearly distinguishes the solar orb from the stellar by means of radiating wavy lines added between the triangular elements, perhaps the triangular radials corresponding to light, and the wavy ones to heat. As for the star sign that corresponds to Ishtar as Venus, it is composed only of triangular radials.⁴² What could be the significance of this unified symbol in the Ur III visual record?

July 1997, Part 3 (Padua: Sargon srl, 2000), pp. 89–100. On the connection between the sun god and justice as one of the Mesopotamian king’s primary areas of responsibility, see Gary Beckman, “‘My Sun-God’: Reflections of Mesopotamian Conceptions of Kingship among the Hittites,” in *Ideologies as Intercultural Phenomena*, edited by A. Panaino and G. Pettinato, Proceedings of the Third Annual Symposium of the Assyrian and Babylonian Intellectual Heritage Project Held in Chicago, USA, October 27–31, 2000, Melammu Symposia 3 (Milan: Università di Bologna, 2002), p. 40.

⁴⁰ On the solarization of Osiris and the “gradual unification of solar and Osirian ideas during the New Kingdom,” see Richard H. Wilkinson, *The Complete Gods and Goddesses of Ancient Egypt* (London: Thames & Hudson, 2003), p. 122. On a connection between the hand-holding motif of Mesopotamian presentation scenes and cer-

tain “Egyptian scenes of presentation to the Underworld” in relation to Achaemenid reliefs from Persepolis that also depict rows of dignitaries holding hands, see Margaret Cool Root, *King and Kingship in Achaemenid Art: Essays on the Creation of an Iconography of Empire*, Acta Iranica 19 (Leiden: Brill, 1979), p. 277; and Root, “The Parthenon Frieze and the Apadana Reliefs at Persepolis: Reassessing a Programmatic Relationship,” *American Journal of Archaeology* 89 (1985): 113, where the religious dimension of the presentation scene, understood here as “initiation,” is referred to as “apotheosis.”

⁴¹ A relatively recent example is Fischer, “Siegelaabrollungen,” pp. 113 ff., where it is also noted how certain seals feature an eagle, sometimes lion-headed, along with the crescent-and-orb.

⁴² Winter, “Conquest of Space,” p. 620.

Again, as already mentioned, on the Stela of Naram-Sîn we see only the solar element, even though it is multiplied. I shall not discuss how many suns may have been depicted on the original stela, as the reconstruction of Jutta Börker-Klähn that proposes seven suns⁴³ has recently been challenged by Winter, who has suggested that only three suns would have constituted the celestial elements of the stela.⁴⁴ What is noteworthy for my purpose is the idea that this solar emphasis on the monument is consistent with the solar iconography of the period as well as with the likelihood that the stela was originally installed in Sippar, the primary cult center of the sun god.⁴⁵

Even though, unlike Egypt, there may not be a consistent fundamental correlation between kingship and the sun in ancient Mesopotamia, an understanding of a “sun king” is not altogether foreign to either the Akkadian or Ur III formulations of kingship. For one thing, the sun god Shamash is the most frequently represented god in Akkadian glyptic.⁴⁶ Further, Claudia Fischer has argued that a new imperial ideology is discernible in Akkadian visual imagery that now shows the king assuming the role of the sun god, visible on the Stela of Naram-Sîn in both the stance of Naram-Sîn himself and his relation to a mountain-like entity (fig. 3), which are both comparable to the way the sun god is shown on Akkadian cylinder seals rising from the eastern mountains.⁴⁷ The sun imagery is also used for Naram-Sîn in the text known as the *Curse of Agade*, which refers to the king as “rising like the sun on the throne of Akkad.”⁴⁸ Even though there may not have been an official solar royalty in the Akkadian period, the symbolism of the sun, encompassing power and heat as well as light and radiance, may be thought to suit well the Akkadian understanding of a militaristic and territorial rule.⁴⁹

As for the Ur III period, again as discussed by Fischer, we observe the growing importance of the moon god Nanna-Suen who now subsumes under his identity aspects of the sun god as well.⁵⁰ In other words, rather than a linear shift in importance from the sun to the moon, we see an amalgamation of the two, which again seems to go along with the synthetic achievement of the Ur III period in blending “Akkadianizing” elements with “something else.” In this regard, Fischer points out that certain hymns to Nanna describe the god’s sanctuary as “the temple which arises like(?) the sun,” and the rise of Nanna himself is described as “when he comes out of the darkened mountains, he stood like Utu (stands) at noon.”⁵¹ Further, a Shulgi hymn describes the king as making his entry to Ekishnugal, the

⁴³ Börker-Klähn, *Alt Vorderasiatische Bildstelen*, vol. 2, pl. 26k.

⁴⁴ Winter, “Conquest of Space,” pp. 621 ff.

⁴⁵ Claudia Fischer, “The Twilight of the Sun-God,” *Iraq* 64 (2002): 131.

⁴⁶ Frankfort, *Cylinder Seals*, pp. 93 ff.; Rainer Michael Boehmer, *Die Entwicklung der Glyptik während der Akkad-Zeit* (Berlin: Walter de Gruyter, 1965), pp. 71 ff. See also Piotr Steinkeller, “Early Semitic Literature and Third Millennium Seals with Mythological Motifs,” in *Literature and Literary Language at Ebla*, edited by Pelio Fronzaroli, *Quaderni Semitistica* 18 (Florence: Università di Firenze, 1992), p. 256.

⁴⁷ Fischer, “Twilight of the Sun-God,” pp. 130–31. Following Winter (“Conquest of Space,” p. 622 n. 14), I would also question Fischer’s argument that this assumption of divine solar qualities on the part of Naram-Sîn, carried on by Ur III kings as well, entails a displacement of the sun god himself from the contemporary religious sphere (Fischer, “Twilight of the Sun-God,” p. 125).

⁴⁸ “Its (Agade’s) king, the shepherd Naramsin, / Rose like the sun on the holy throne of Agade,” Jerrold S. Cooper, *The Curse of Agade* (Baltimore: Johns Hopkins University Press, 1983), pp. 52–53, composite text lines 401 ff., cited in Winter, “Conquest of Space,” p. 622.

⁴⁹ On the Akkadian “centralization” and military expansion, see Nissen, *Early History*, pp. 168 ff. On the idea that there were already different traditions of rule at home in the north and the south in the pre-Sargonic period, with the northern tradition “strong, authoritarian, and predominantly secular,” and the southern weak from a military standpoint and more theocratic, see Piotr Steinkeller, “Early Political Development in Mesopotamia and the Origins of the Sargonic Empire,” in *Akkad, The First World Empire: Structure, Ideology, Traditions*, edited by Mario Liverani, *History of the Ancient*

Near East, *Studies* 5 (Padua: Sargon srl, 1993), p. 120. Further, on the Akkadian tradition of kingship, see Mario Liverani, “Model and Actualization: The Kings of Akkad in the Historical Tradition,” in *Akkad, The First World Empire*, pp. 41 ff.

⁵⁰ Fischer, “Twilight of the Sun-God,” p. 125. In the Gilgamesh tradition, too, there are elements that point to the assimilation of Gilgamesh to the sun god Utu-Shamash. In Tablet IX of the Standard Babylonian Version, after the death of his companion Enkidu, in quest of eternal life, Gilgamesh enters the netherworld from the twin mountains of Mashu, which guard the rising sun, and travels in it for twelve “double-hours” just like the sun itself (lines 38 ff.). In this regard, see also Heimpel, “Sun at Night,” pp. 140 ff. It is noteworthy that certain Akkadian seals depict the sun god rising between two mounds, no doubt a visual reference to the gateway of the netherworld whence the sun emerges in the morning. By the same token, one could think that on his stela, not only is Naram-Sîn visually assimilated to the sun god, but can also, on account of the presence of a mound-like element, albeit only one, be thought of as represented in association with the entrance to the netherworld. The sun god Utu-Shamash also appears in both the Standard Babylonian Epic and the discrete Gilgamesh poems in Sumerian. In the former, he acts as arbiter and judge, his traditional roles, in revoking Enkidu’s curse on the harlot Shamhat (VII 134 ff.). As for the latter poems, the sun god again plays an important role in them, especially in the poem known as *Gilgamesh, Enkidu, and the Netherworld*, or *Bilgames and the Netherworld*, again in connection with the netherworld, notions of judgment and arbitration, and as helper of Gilgamesh (Benjamin Studevent-Hickman, “The Sun-God in the Gilgamesh Tradition” [unpublished ms]).

⁵¹ Fischer, “Twilight of the Sun-God,” p. 128 n. 19, citing M. G. Hall, “A Study of the Sumerian Moon-god Nanna/Suen” (Ph.D. diss., University of Pennsylvania, 1985), p. 401 and p. 488 respectively.

sanctuary of the moon god Nanna in Ur, like the sun which illuminates men,⁵² again suggesting an idea of conjunction between the sun and the moon. Further evidence for the solarization of the Ur III king can also be found in royal inscriptions that refer to the king as “the sun god of the land,” ^dUtu-kalam-ma.⁵³

Thus, it is in this framework that the prominent graphic union of these two celestial entities in Ur III presentation scenes might make more sense. It should be pointed out, however, that this unified emblem is not a ubiquitous element in Ur III glyptic. Many Ur III seals feature the crescent moon alone, and to complicate matters even further, certain Akkadian seals feature only the crescent moon as well.⁵⁴ Be that as it may, as is all too common in the Ur III visual record, a lack of mechanical consistency in the occurrence of certain elements, signs, and symbols in contemporary glyptic should not deter us from taking notice of this unified element peculiar to the Ur III period and reflecting on its significance.

ROYAL TITLES

One final parameter might help further to complement the picture: royal titles, especially the two titles that perhaps have the greatest cosmological reference, “king of the four quarters” (lugal an-ub-da-limmu-ba), and “king of Sumer and Akkad” (lugal ki-engir ki-urim). Both of these titles are part of the royal titulary in the Ur III period, supplementing the main title “king of Ur” (lugal urim₂^{ki}-ma).⁵⁵ However, these two titles, “king of Sumer and Akkad” and “king of the four quarters,” never occur together in the same formula in the Ur III period. Ur-Namma never bore the title “king of the four quarters,” using instead the title “king of Sumer and Akkad.” Shulgi’s titulary included either one or the other, but never both at the same time, while the last three kings of the Ur III dynasty used “king of the four quarters” to the exclusion of “king of Sumer and Akkad.”⁵⁶ Thus, there is reason to assume that whatever meaning was embodied by “king of the four quarters,” a title first attested under Naram-Sîn, that meaning was also signified by “king of Sumer and Akkad” and the two titles were interchangeable.

Perhaps the combination of Sumer and Akkad here should be understood as more than a reference to a geographic or territorial union, or control over Nippur,⁵⁷ and should also be considered as a binary formulation of the cosmic totality of complementary principles, the concept that is also in all likelihood signaled by the union of the crescent and the solar orb. For instance, as pointed out by Mark E. Cohen, the major festivals in Ur marked turning points in the duration of the moon’s appearance in the sky in relation to that of the sun, creating a calendar whose cardinal points were approximately the equinoxes and the solstices, thus a simultaneously binary and quaternary configuration.⁵⁸

One might even wonder if there could be a parallel between the sun and Akkad on the one hand and between the moon and Sumer on the other, on a thoroughly symbolic plane. Both celestial deities, however, must have been

⁵² Eléna Cassin, *La splendeur divine: Introduction à l'étude de la mentalité mésopotamienne* (Paris and The Hague: Mouton, 1968), p. 68.

⁵³ See, for instance, Amar-Suena E 3/2.1.3.16: 4–12, Douglas Frayne, *Ur III Period (2112–2004 BC)*, *The Royal Inscriptions of Mesopotamia Early Periods 3/2* (Toronto, Buffalo, and London: University of Toronto Press, 1997), p. 263. Further, on the equation of certain Mesopotamian rulers, such as the semi-legendary Enmerkar, Rim-Sîn I of Larsa, and Hammurapi, as well as several Neo-Assyrian kings, with the sun god, see Beckman, “‘My Sun-God,’” p. 39.

⁵⁴ For seals with only the crescent moon in Akkadian glyptic, see, for instance, Boehmer, *Entwicklung*, pls. 43 and 54; in Ur III glyptic, see Edith Porada, *Corpus of Ancient Near Eastern Seals in North American Collections: The Collection of the Pierpont Morgan Library*, vol. 1, *The Bollingen Series 14* (New York: Pantheon Books, 1948), pl. 44.

⁵⁵ Along with lugal kalam-ma and lugal Kiš, only the title lugal urim-ma “king of Ur” originated in the pre-Sargonic period. The other, Ur III titles, lugal an-ub-da-limmu-ba “king of the four quarters,” first

attested under Naram-Sîn, and lugal ki-engir ki-urim “king of Sumer and Akkad,” originated in later periods (Hallo, *Royal Titles*, p. 11). On Mesopotamian royal titles, see also M. J. Seux, *Epithètes royales akkadiennes et sumériennes* (Paris: Letouzey & Ané, 1967).

⁵⁶ Hallo, *Royal Titles*, p. 52.

⁵⁷ Hallo proposes a significant correlation between the assumption of the title “king of Sumer and Akkad” and the possession of Nippur, especially during the two periods when it was chiefly used, from Ur-Namma to Shulgi and from Ishme-Dagan (1953–1935 B.C.) to Hammurapi (1792–1750 B.C.) (Hallo, *Royal Titles*, p. 83).

⁵⁸ Mark E. Cohen, “The Sun, the Moon, and the City of Ur,” in *Religion and Politics in the Ancient Near East*, edited by Adele Berlin (Bethesda: University Press of Maryland, 1996), pp. 16 ff.; cited in Fischer, “Twilight of the Sun-God,” p. 129 n. 19. On two-fold and four-fold formulations of political and universal totality in the ancient Near East and Egypt, see Mario Liverani, *Prestige and Interest: International Relations in the Near East ca. 1600–1100 B.C.* (Padua: Sargon srl, 1990), p. 44.

at home in both the “Sumerian” and the “Semitic” traditions before the syncretism of the middle of the third millennium that produced such compound names as Nanna-Suen.⁵⁹ Further interest on the part of the Akkadian state in the moon god can also be seen in the appointment of Sargon’s daughter Enheduanna as the *entu* priestess of Nanna-Suen in Ur.⁶⁰ Notwithstanding this co-extensiveness of solar and lunar notions in both Akkadian and Ur III contexts, it might nevertheless be worth keeping in mind the almost topological emphasis on the sun in Akkadian iconography, as already discussed, and that on the moon god in Ur in the Neo-Sumerian period.⁶¹ Further correlation might be thought to exist between the Akkadian formula of a ruler of the four quarters of the cosmos and the way the solar orb is rendered in the Ur III visual domain, often with a cruciform element at the center that divides the circle into four quadrants (fig. 1). Perhaps the unified symbol under consideration reflects and reinforces the Ur III tendency to bring together and amalgamate two different conceptual traditions of rule and kingship, one associated with Akkad and the north and the other with archaic Sumer, resulting in the synthesis not only of “king of Ur” but also of a solarized Nanna-Suen. The Ur III tendency to unite, reconcile, and amalgamate can further be seen in Ur-Namma’s effort to assume the title “en of Uruk” along with the title “king of Ur,”⁶² again in a way combining a more archaic traditional notion of rule with a more encompassing and imposing formulation of royalty that also finds expression in the epithet *lugal kalam-ma*, “king of the land,” a title equivalent to *lugal urim-ma*, “king of Ur.”⁶³

The parameters I have attempted to consider here—figural, semiotic, and titular—might not be rigidly matched with certain corresponding concepts. However, within Neo-Sumerian culture, they certainly have a potential to reveal levels of meaning beyond the socio-political not only in Neo-Sumerian glyptic iconography but also in the ideology of kingship at large in later third-millennium B.C. Mesopotamia.

⁵⁹ Cohen, “Sun, the Moon,” p. 10.

⁶⁰ On Enheduanna, see especially Irene J. Winter, “The Disk of Enheduanna, the Beginning of the Office of En-Priestess, and the Weight of Visual Evidence,” in *La femme dans le proche-orient antique: compte rendu de la 33^e Rencontre Assyriologique Internationale (Paris, 7–10 Juillet 1986)*, edited by D. Charpin and Jean-Marie Durand (Paris: Éditions Recherche sur les Civilisations, 1987), pp. 189–201; and Joan Goodnick Westenholz, “Enheduanna, En-Priestess, Hen of Nanna, Spouse of Nanna,” in *DUMU-E₂-DUB-BA-A, Studies in Honor of Åke W. Sjöberg*, edited by Hermann Behrens et al. (Philadelphia: Occasional Publications of the Samuel Noah Kramer Fund 11, 1989), pp. 539–56.

⁶¹ Fischer also states that the moon god Nanna-Suen was the father of the sun god Utu/Shamash in Akkadian and Ur III theology (“Twilight of the Sun-God,” p. 130). She uses this piece of evidence to strengthen her argument that in this period, the sun god was lower in rank than the moon god. One could nevertheless again consider a “symbolological” dimension in this relation as well, in that the lunar element was

perhaps seen here as a conceptually, or cosmically, senior or more archaic element in relation to the solar, defying the actual natural subordination of the moon to the sun. This seniority would then be not unlike that attached to the god Enki/Ea and his sacred city Eridu in relation to certain other high-ranking deities. On a brief discussion of Eridu as the oldest city in the Sumerian tradition, see William W. Hallo, “Enki and the Theology of Eridu,” *Journal of the American Oriental Society* 116 (1996): 232. If my hypothesis of an Ur III construct of associating what Sumer and Akkad represents with the moon and the sun respectively on the same symbolic plane has validity, the same seniority may then be considered to be attached to Sumer in its relation to Akkad.

⁶² Hallo, *Royal Titles*, p. 7. On the Ur III and Isin kings’ assuming the title “en of Uruk” along with their participation in the “sacred marriage” ceremony as symbolic spouses of the goddess Inanna, see Steinkeller, “Rulers, Priests and Sacred Marriage,” pp. 126 and 130.

⁶³ Hallo, *Royal Titles*, p. 19.

THE KNOWLEDGE OF TRADITION: A TEXTUAL AND ICONOGRAPHIC INTERPRETATION

*Anna Maria Gloria Capomacchia and Marta Rivaroli,
Università di Roma “La Sapienza”**

1. A THEORETICAL APPROACH

Good knowledge and a deep analysis of the textual documentation and the archaeological materials are required for a careful and complete study of ancient civilizations. We have to analyze these documents in different ways. A philological analysis is important above all, not only to translate the texts but also to evaluate their position in a specific historical context and in a certain cultural sphere. Nonetheless, the evidence needs to be examined also with an archaeological and historical-artistic approach and, for a proper interpretation of the data, it is also necessary to evaluate the geographic and environmental context for a full study. For ancient civilizations the religious component is an essential element in realizing the structure of these kinds of societies. The importance of sacral elements in the context of the cultures of the ancient Near East is evident and a correct analysis of these elements can produce good results also in classifying the materials starting from the moment of excavation itself. It is clearly a question of methodology. We can use a method of research based on the study of religious elements to analyze documents and materials that are generally examined only from a philological or archaeological perspective. Thus we can reach new interpretations of the data and a more complex, exhaustive, knowledge of the documents and of the tradition that was their background. This is the historical-religious method.

In each human group the proper function of the religious component is to ensure stability and to provide a way of controlling features and structures basic to the identity of the group. This kind of control is strictly linked to the way a specific culture faces groups other than itself and to the way it confronts the risky situations that every society encounters both on a daily basis and in more occasional historical events. This kind of sacral guarantee bases itself upon two elements: myth and ritual practice. The mythological complex constitutive of the sacred tradition peculiar to any specific group is the focus of its religious beliefs and founds that culture at a sacral level. The very origin and foundation of identity marks, cultural customs, and organization of a certain society are connected to events that happened at the time of origins, events preserved indeed in the mythical traditions. The description of the events—through which the cosmological foundation occurred and the environment in which the society is inserted was formed— involves the action of entities such as the gods themselves. These divine characters find their origins and reach their whole characterization in mythical time through the events involving them.¹ These divine entities permanently guarantee reality in historical time by giving humankind the possibility of acting on a ritual level. Thanks to the divine guarantee, human beings are given the chance to assign the changes that upset the structure of the society in daily life and in larger historical events to a fixed and ordered dimension.

Thus mythical and ritual plans ensure a continuous wardship on a sacral level upon stability of the present reality. Nonetheless, this sacred foundation is not at all firmly static. On the one hand, this dimension is not supposed to recur: the finiteness of mythical time is itself a guarantee of the stability of the components inserted into its frame. On the other hand, every time a new foundation or a reconfirmation is needed—for a changed situation, institution, authority—it is possible and even necessary to recall ritually the sacred dimension in order to ensure a legitimate foundation. It is only because of the support of the mythical tradition that the ritual action obtains its efficacy guaranteeing the social structures in history.² An organization founding its own order on such sacred bases gives a new

* A. M. Gloria Capomacchia is responsible for § 1, Marta Rivaroli for § 2, and both for the conclusion.

¹ Angelo Brelich, *Introduzione alla storia delle religioni* (Rome: Edizioni dell'Ateneo, 1966), pp. 9–12.

² Maria Giovanna Biga and Anna Maria Gloria Capomacchia, *Il politeismo vicino-orientale: Introduzione alla storia delle religioni del Vicino Oriente antico* (in press).

perspective for the interpretation of iconographic and written documents employed in order to represent and often to celebrate the events within the society itself. The written and figurative expressions represent in fact the way a given society seeks to portray itself in a particular historical moment. This self-portrait could not be extemporaneous in any way: it must be composed in a frame resting on the cultural pivots of social structure. Every representation, of course, refers to a specific event or historical situation. On the other hand, the way it is expressed has to be located in the exigence of founding itself through the mythical tradition, giving it sacred guarantee. Through this connection the portrait of an event or even of a distinct character finds proper expression because it is tied to the religious bases upon which a group or a single person correctly operates.

With this perspective, we can find references to mythical tradition at different levels of expression, as representations of landscape and characters of the elements that define the environmental context. These references to the myth can reveal a value often misunderstood. Also, in describing an event, in the words, expressions, or attributes used in the texts to represent it, even in the attitude of the personages and the elements often considered merely decorative or incidental in a figurative representation, the mythical references can give us a means of interpretation that we cannot minimize. The mythical tradition and the protagonists of the mythical tales, with their heroic actions, in that primeval dimension where the cosmic and human order has its origin, are often the sacral background of these representations.³ Unfortunately, we know only a small part of the ancient Near Eastern mythical tradition. So, we cannot understand all the references to mythical events and characters that our texts and figurative images can hide. Certainly, these texts and representations revealed their sacral tradition to the men of ancient times, who knew those mythical tales. These images and texts sent them a message whose origin was in the sacral beliefs of the whole community. This paper attempts to show the perspective that the historical-religious method can open up. This essay focuses on a specific documentary context: Neo-Assyrian royal inscriptions and reliefs.

2. AN ANALYTICAL APPROACH

As clearly expressed on a theoretical level by A. M. Gloria Capomacchia, the chosen documentation is strictly connected to the self-definition of Assyrian identity. Moreover, we should keep in mind that this documentary sample certainly is an expression of the upper levels of society and, in particular, the royal apparatus and consequently the way it perceives and defines itself. Therefore the Assyrian identity analyzed here finds its roots in the institution of kingship. Self-definition, both individually or collectively conceived, involves a comparison with the “other than the self.”⁴ The confrontation makes apparent one’s own identity and one’s own affiliation to a group and, at the same time, it allows a separation and a marking of difference with the other, considered as a stranger. Between “us” and “them” there must be a border, even if not physically manifested through a “real frontier.” This demarcation allows the two polarities (“us” and “them”) consistency and to define each in relation to the other.⁵ The construction of the Assyrian cultural identity takes place through internal definition and self-delimitation thanks to the distinction from the other in time and space (fig. 1). The relationship between core and periphery, as shown by Liverani,⁶ includes a spatial and also a temporal difference: on the one hand the opposition between an ordered and regulated world—the “inside”—and a chaotic and uncivilized territory—the “outside”; on the other hand a primordial chaos—“before”—and a world ordered under Assyrian law—“now.” The way in which the polarity core–periphery is affirmed, both in inscriptions and reliefs, is through the employment of models clearly recalling the mythical tradition. Furthermore, the king exalts his own kingdom by stressing the difference with a historical and not equally positive past and at the same time connecting his rule to a “mythical” past: the time of origins.⁷ The connection with the mythical time is obtained through the heroic identification of the king with the topic of the god as conqueror and

³ A. M. Gloria Capomacchia, “Heroic Dimension and Historical Perspective in the Ancient Near East,” in *Historiography in the Cuneiform World*, Part 1, edited by Tzvi Abusch et al. (Bethesda: CDL Press, 2001), pp. 91–97; see also Marta Rivaroli, “Aspetti sacrali dell’idea di confine nel periodo neo-assiro: Dimensione urbana e limite territoriale” (Ph.D. diss., University of Rome, 2004), pp. 11–37.

⁴ Jan Assmann, *Das kulturelle Gedächtnis: Schrift, Erinnerung und politische Identität in frühen Hochkulturen* (Munich: Beck’sche Verlagsbuchhandlung, 1992, Italian translation, 1997), p. 99.

⁵ Marcello Massenzio, *Sacro e identità etnica: Senso del mondo e linea di confine* (Rome: Franco Angeli, 1997), p. 149.

⁶ Mario Liverani, “The Ideology of the Assyrian Empire,” in *Power and Propaganda: A Symposium on Ancient Empires*, edited by Mogens Trolle Larsen, Mesopotamia 7 (Copenhagen: Akademisk Forlag, 1979), pp. 306–14.

⁷ Mario Liverani, “The Deeds of Ancient Mesopotamian Kings,” in *Civilizations of the Ancient Near East*, vol. 4, edited by Jack Sasson (New York: Scribner, 1995), pp. 2361–62.

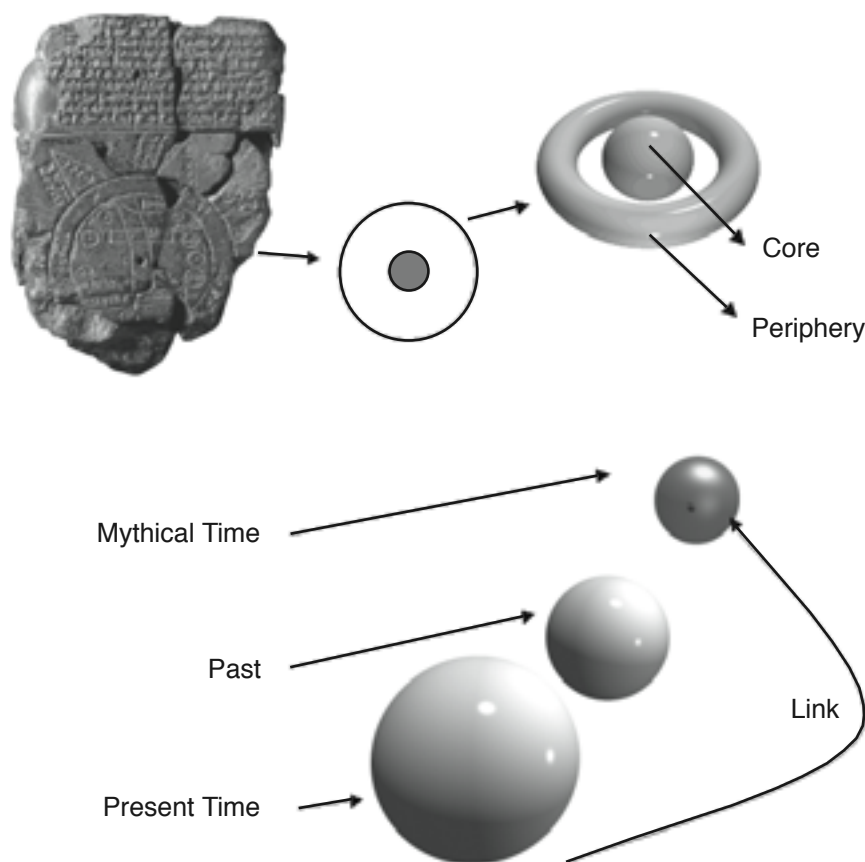

Figure 1. Assyrian identity scheme. Spatial and temporal contraposition. Mappa Mundi (BM 92687), Copyright the Trustees of The British Museum.

orderer. The ruler sets his actions on the same level as the divine one, but of course in a ritual way, as will be later clarified. In the official documentation there are inserted, as already noted by other scholars,⁸ mythical memories by which the king relates his own actions to those of the extra-human beings at the time of origins. Moreover, at first glance it is clear that in the documents are present not only memories of the mythical tradition, but also ritual elements. In our opinion, they are necessary because it is through these elements that the king legitimates his actions in historical time. The purpose of this essay is not simply to single out the mythical and ritual references, but to insert them in a framework—observing their interconnected relations inside the textual and iconographic narrative scheme—in order to understand how and to what extent such “historical” expressions mirror the cultic foundations of Assyrian culture.

There are four Mesopotamian literary compositions that tell of a god’s fight with the destructive forces: *Lugale*, the *Anzû Myth*, the *Labbu Myth*, and *Enûma Eliš*. The *Labbu Myth* has been left out of consideration here because of its poor state of preservation. The other three myths will be analyzed, noting also that they were well known during the Neo-Assyrian period.⁹

⁸ See Elnathan Weissert, “Creating a Political Climate: Allusions to *Enûma Eliš* in Sennacherib’s Account of the Battle of Halule,” in *Assyrien im Wandel der Zeiten* (Papers Read at the 39^e Rencontre Assyriologique Internationale, Heidelberg, 1992), edited by Hartmut Waetzoldt and Harald Hauptmann, *Heidelberger Studien zum alten Orient* 6 (Heidelberg: Heidelberger Orientverlag, 1997), pp. 191–202; Stefan M. Maul, “Der assyrische König – Hüter der Weltordnung,” in *Priests and Officials in the Ancient Near East* (Papers Read at the Second Colloquium on the Ancient Near East – The City and Its Life, at the Middle Eastern Culture Center in Japan, Mitaka-Tokyo), edited by Kazuko Watanabe (Heidelberg: C. Winter, 1999), pp. 201–14.

⁹ See the editions by Jan van Dijk, *Lugal ud me-lám-bi nir-gál, La récit épique et didactique des Travaux de Ninurta du Déluge et de la nouvelle Création, Texte, traduction et introduction* (Leiden: Brill, 1983); Amar Annus, *The Standard Babylonian Anzu Epic*, State Archives of Assyria Cuneiform Texts 3 (Helsinki: The Neo-Assyrian Text Corpus Project, 2001); Wilfred G. Lambert, *Enûma eliš, The Babylonian Epic of Creation: The Cuneiform Text* (Oxford: Clarendon, 1966). See also Jean Bottéro and Samuel Noah Kramer, *Lorsque les dieux faisaient l’homme, Mythologie mésopotamienne* (Paris: Éditions Gallimard, 1989).

Below is presented a comparative scheme of the narrative structure common to the mythical compositions and to the historical documentation:

<i>Mythical Text</i>	<i>Royal Inscription</i>	<i>Relief</i>
Opening motivation	Opening motivation	—
Choice of the god	— ? —	— ? —
Arrangements for departure	Arrangements for departure	Arrangements for departure
Departure	Departure	—
Crossing the border	Crossing the border	Crossing the border
Fight	Fight	Fight
Victory / submission	Victory / submission	Victory / submission
Ordering new reality	Ordering new reality	Ordering new reality
Fixing new boundaries	Fixing new boundaries	Fixing new boundaries
Back Home	Back Home	Back Home

At a first glance it is apparent that the narrative compositional scheme follows a temporal logic in the sequence of events. Analyzing it more deeply it is possible to recognize a perfect correspondence between the mythical and the historical documentation that leads to a detailed analysis of the single elements of the framework.

OPENING MOTIVATION

In the three mythical texts the opening section is about the background determining the successive action of the main character. In Lugale, Ninurta is told by Sharur that Asakku—a chaotic entity living on the Mountain—has rebelled and is threatening to usurp his sovereignty with the help of the Mountain and the children begotten from her: the stones (Lugale 26–70). In the Anzû Myth, the mythical bird has stolen the “Tablet of Destinies,” betraying Enlil’s trust. Anzu resolved in his heart to make off with supremacy and then flew off to the mountain (Anzu III 13, 17, 22). In Enūma Eliš, the god Ea reports to Anshar that Tiamat, instigated by her children, decided to destroy her progeny and created a mass of monstrous beings, giving to Qingu command of the army and the Tablet of Destinies (En. el. II 111, III 73–114). In the mythical narratives the gods do not act on their own initiative but react to a critical situation of “disorder.” Ninurta and Marduk act either after a rebellion (Asakku-Mountain), or the breaking of an oath, i.e., a betrayal (Anzu) or a conspiracy (Tiamat). In the annalistic accounts the narration opens by giving the reasons for the setting up of a military expedition: the king generally is informed by means of a report carried to him about a new disorder.¹⁰ The most frequently attested causes are: enemy’s rebellion (*nabalkutu*);¹¹ menace of the “crossing over” the frontiers in the physical sense (*ebēru*);¹² betrayal or breaking of a former treaty (*maddattu kudurru ša Aššur iklû*);¹³ illegitimate annexation of an allied country, a conspiracy, and the carrying out of military actions against Assyrians.¹⁴ In all cases the ruler’s choice is justified by the need to safeguard the Assyrian state: the news of a state of disorder induces the Assyrian king to act. The reasons for the beginning of a military campaign are at any rate due to the “guilt” (*hītu*) of the enemy. Enemy’s guilt and king’s reaction thus find their sacral foundation in the mythical texts.

¹⁰ Mario Liverani et al., “Studies on the Annals of Assurnasirpal II: I, Morphological Analysis,” *Vicino Oriente* 5 (1982): 13–73.

¹¹ The typical verb employed is *nabalkutu* (“to rise against,” “to rebel”), a term typical of the idea that political change is the “overthrow” of the established order.

¹² “While I was in Calah this report was brought to me: ‘All the people of the land Laqû, the city Khindanu, and the land Sukhu have rebelled (*nabalkutu*) and crossed (*ebēru*) the Euphrates.’” See A. Kirk Grayson, *Assyrian Rulers of the Early First Millennium B.C., I (1114–859 B.C.)*, The Royal Inscriptions of Mesopotamia, Assyrian

Period 2 (Toronto, Buffalo, and New York: University of Toronto Press, 1991), p. 214, iii 26b–28a.

¹³ “A report was brought back to me saying Ameka and Arashtua had withheld the tribute and the corvée of Assur, my lord” (Grayson, *Assyrian Rulers*, vol. 2, p. 205, ii 49–50).

¹⁴ “Merodach-baladan, king of Babylonia, whose heart is wicked, an instigator of revolt, plotter of rebellion ... brought over to his side ...” (Daniel David Luckenbill, *The Annals of Sennacherib*, Oriental Institute Publications 2 [Chicago: University of Chicago Press, 1924], p. 48, A1, 6–7).

CHOICE OF THE GOD

The question mark that appears in the narrative scheme apparently suggests that the “choice of the god/king” element is not present in the historical accounts. The reason for the “choice of the god” is self-evident in the Anzû Myth and in Enūma Eliš: the chaotic element has overwhelmed order and someone must restore reality to an ordered dimension. Royalty has not been fixed yet (Marduk) or has collapsed (Anzu) and the gods have to choose their “champion.” It is interesting to note that it is not the god (Ninurta/Marduk) who proposes himself. He is selected by Ea as the best candidate and, for this reason, he must accept the appointment with its risks (laws, duties). In our opinion, in this sequence it is possible to recognize the same process for the foundation of the divine grant of “earthly” rulership and the subsequent acceptance of the kingship by the king. Seen in this perspective the absence of the analyzed pattern in Lugale is indicative: Ninurta is already king; therefore he cannot refuse to face Asakku. Thanks to this text we understand the absence of the function “choice of the king” in the historical documentation. There is no need to describe the choice of the king: his royalty has already been fixed and ratified. This is evident in the king’s titulary exhibited at the beginning of the accounts which could be compared with the description of Marduk’s royal investiture in Enūma Eliš: Marduk asks Anshar for the power of “fixing destinies” in exchange for his acceptance of the enterprise.¹⁵ Similarly the king receives not only a scepter (*ḥaṭṭu*) for ruling over Assyria but also a weapon (*kakku la padu*) for conquering lands.¹⁶

The god’s bestowing the royal insignia may be the connecting point between historical and mythical levels. The pattern revealed in the royal titulary finds an exact iconographic correspondence: the relief in the throneroom of Assurnasirpal II representing the god assigning the insignia to the king (fig. 2). As observed by Irene J. Winter, the position of the slab within the throneroom is crucial: it occupies the primary location immediately behind the throne base.¹⁷ The Assyrian king, like Ninurta or Marduk, is entrusted by the gods and empowered to accomplish his sacral duties.

ARRANGEMENT

In the mythical tales the divine protagonist obtains moral and practical support from the other gods.¹⁸ In the historical accounts the king first receives the favor of the gods and only afterwards can he assemble the army. The divine benevolence is expressed by means of stereotyped formulae.¹⁹ They could be read as the translation of ritual divinatory acts enacted by the king in order to obtain the sacral requisites necessary for the military action: divine approval and support. These formulae reveal, in fact, on the one hand the king’s need of continually justifying on a ritual level his public actions; on the other hand the active role fulfilled by the king himself as a mediator between the divine and human levels: he decides upon the military enterprise and asks the gods for their support in order to act with the approval of the divine will and thus to ensure the success of his initiative on a sacral level. At the explicit human news of disorder there follows, immediately, the explicit divine indication of how to restore order.

The support of the gods can be identified in another iconographic representation in the throneroom of Assurnasirpal II: the carved slab placed directly opposite the main doorway in the south wall of the room. It shows the god giving to the king the bow necessary to defeat the enemies.²⁰

¹⁵ “They bestowed in full measure *scepter, throne, and staff*. / They gave him *unopposable weaponry* that vanquishes enemies” (En. el IV 29–30).

¹⁶ “When Assur, the lord who called me by name and made my *sovereignty supreme* over kings of the four quarters ... he placed his *merciless weapon* in my lordly arms and sternly commanded me to rule, subdue, and direct the lands and mighty highlands.” See Grayson, *Assyrian Rulers*, vol. 2, p. 196, lines 41, 44–45.

¹⁷ Irene J. Winter, “The Program of the Throneroom of Assurnasirpal II,” in *Essays on Near Eastern Art and Archaeology in Honor of Charles Kyrle Wilkinson*, edited by Prudence Oliver Harper and Holly Pittman (New York: Metropolitan Museum of Art, 1983), p. 16. For an interpretation of the sacral values behind the figurative of the program of the throneroom, see also Rita Dolce, “Dualità e realtà virtuale nel palazzo nord-ovest di Assurnasirpal II a Nimrud,” *Contributi e Materiali di Archeologia Orientale* 7 (1997): 141–62; Rita Dolce, “Concezioni e rappresentazioni del potere: La maestà, il dominio, il prestigio,” in *Dai palazzi Assiri: Immagini di potere da Assurnasirpal II ad Assurbanipal (IX–VII sec. a.C.)*, edited by Rita

Dolce and Maresita Nota Santi (Rome: “L’Erma” di Bretschneider, 1995), pp. 25–43; Paolo Matthiae, *Il sovrano e l’opera: Arte e potere nella Mesopotamia antica* (Rome and Bari: Editori Laterza, 1994), pp. 106–10; Paolo Matthiae, *L’arte degli Assiri: Cultura e forma del rilievo storico* (Rome and Bari: Editori Laterza, 1996), pp. 37–59.

¹⁸ “On the path to success and authority did they set him marching” (En. el. IV 34); “The hero heard the utterance of his mother. He writhed with rage, he was furious, he made his way to his mountains” (Anzu II 28–29). In Lugale, divine approval is not mentioned by virtue of the recognized role of Ninurta as holder of kingship.

¹⁹ “With the support of Assur, the great lord, my lord, and the divine standard which goes before me, and with the fierce weapons which Assur, my lord, gave to me” (Grayson, *Assyrian Rulers* 2, p. 244, ii 83–85).

²⁰ See also the drawing of Slab 13B, the king receiving the bow, in J. Meuszynski, *Die Rekonstruktion der Reliefdarstellungen und Ihrer Anordnung im Nordwestpalast von Kalhu (Nimrud)*, *Baghdader Forschungen* 2 (Mainz am Rhein: Philipp von Zabern, 1981), p. 2.1.



Figure 2. The king receives the royal insignia. Nimrud, Northwest Palace, Throneroom B. Assurnasirpal II (Slab 23B, BM 124531, Copyright the Trustees of The British Museum; from P. Matthiae, *La storia dell'arte dell'Oriente antico: I grandi imperi, 1000–300 a.C.* [Milan: Electa, 1996], p. 58).

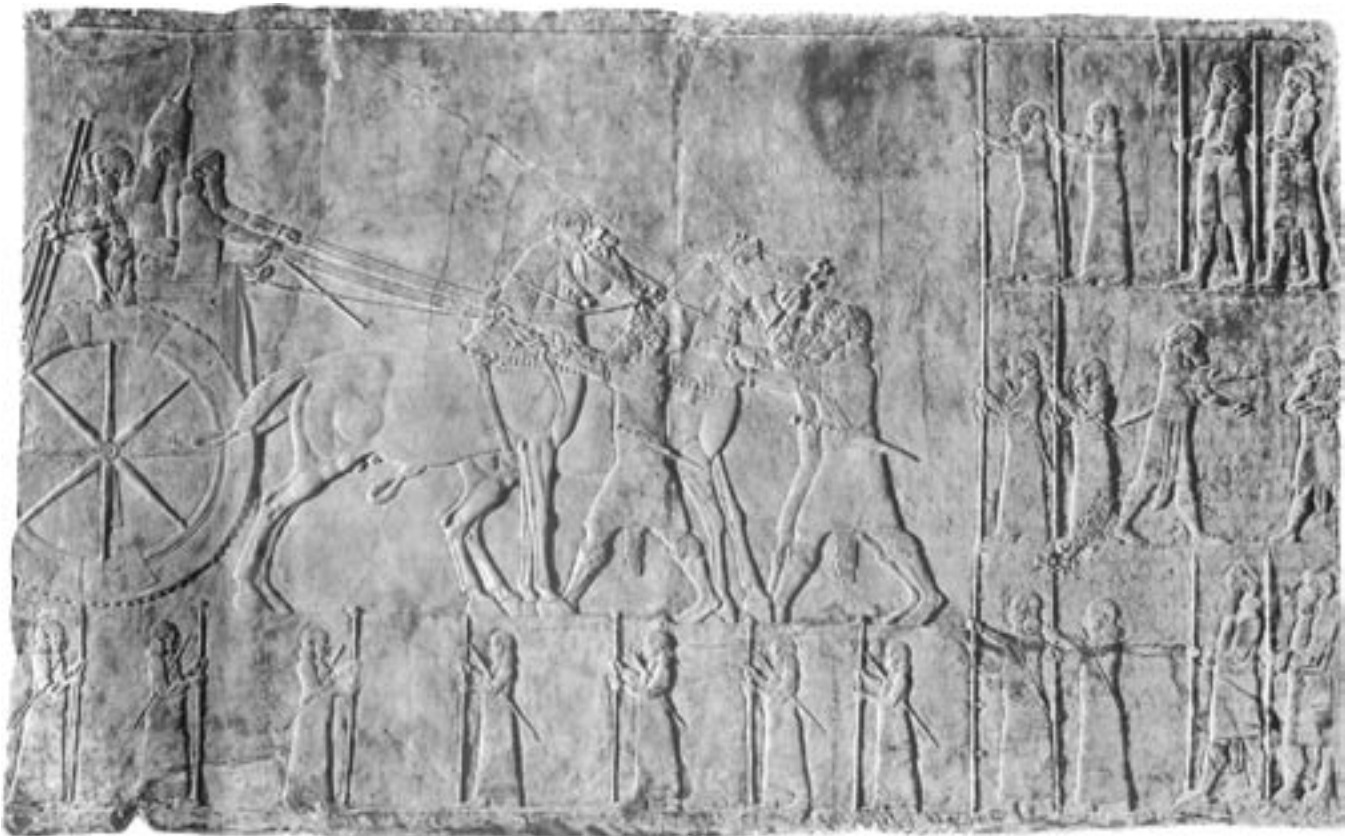

Figure 3. Preparations for the ritual hunt. Nineveh. North Palace, Room C. Assurbanipal (Slabs 4–6. BM 124781, 124858–61, and 124884, Copyright the Trustees of The British Museum; from R. D. Barnett, *Sculptures from the North Palace of Ashurbanipal at Nineveh (668–637 B.C.)* [London: British Museum, 1976], pl. 5).

TECHNICAL ARRANGEMENTS

In the mythical narratives, the gods complete the arrangements by equipping themselves with invincible weapons before confronting the chaotic Enemy (Anzu II 31–34; En. el. IV 35–59).

The weapons of the equipment of the divine beings described in the arrangement phase are to be found, as we will observe later, in the historical texts in relation to the phase of the fight between the Assyrian king and the enemy: they probably stress the relationship between the action of the king and the action of the god. In the royal inscriptions the technical arrangements usually are expressed through fixed formulations.²¹ There are no iconographic examples showing the arrangements prior to the military expedition, but it is worth noting that the reliefs represent the preparations for the ritual hunt that is, as we are going to demonstrate later, strictly connected with the framework of the battle (fig. 3).

DEPARTURE

Both in mythical and historical accounts the moment of departure is described only briefly and it is, moreover, strictly connected to the crossing of borders. In the mythical texts the departure is expressed with details stressing the fact that the combat should be located outside the ordered reality.²² The same is true for the historical documentation: the king is described leaving his capital, the core of his own country, and entering the enemy's territory. In this way the description provides evidence that the battlefield is to be located in the spatial setting of the chaotic reality and not inside the ordered dimension.

CROSSING THE BORDERS

In the mythical tales the moment of crossing the borders is very synthetically described, while it is instead well described in the historical documentation. This difference is extremely noteworthy: as previously pointed out the main features of the Assyrian identity take shape through the description of the "other than the self." For this reason the very moment of the passage acquires an undoubtable importance. The action of crossing the borders is focused on the connotation of the "other" expressed through the landscape and the enemy. Sea, river, desert, mountain by their own nature symbolize the liminal space and are thus perceived as borders separating the inner core from the periphery. Their crossing involves an "entering" (*erēbu*) into a dimension different than the Assyrian one. With the progress of military expansion the previously peripheral elements (river, mountain, desert, sea) gradually are absorbed into the Assyrian reality and thus lose their liminal value. In order to stress the "wholly other" connotation of the outer landscape it is necessary to employ additional adjectives, metaphors, and similes. These "characterizations" are functional, in our opinion, in showing the peripheral landscape as distinct from the Assyrian one, which in its turn has already incorporated—through the preceding conquests—realities previously perceived as "other." The Assyrian country is thus described through simple toponyms while fixed phraseologies give the place where the crossing of the border happens a particular nuance: the liminal value is now held by a characterized toponym (fig. 4). Through this kind of "coloring," the contraposition between periphery (inaccessible, dark, impenetrable) and the Assyrian country, i.e., the ordered world (bright, accessible, organized) takes form.²³ It is possible to detect a similar use of the landscape also in the iconography. The environmental representation appears to be aimed at a contextual recognition of the event as pertaining to an external setting, one other than Assyrian.²⁴ Inside the decorative program of the throneroom of Assurnasirpal II natural details are inserted in order to stress the very moment of the crossing of the border, exalting in this way the heroic character of the king who enters into an unknown world (fig. 5). Inside the decorative cycles of the successive kings, in contrast, the same iconographic data mark both the military march in the "other" territory (fig. 6) and the setting of the battle: they are probably aimed at stressing that the battle takes place in the still-uncontrolled territory of the enemy. There is more. As the characterization of the

²¹ "By the command of Assur, the gods Shamash and Adad, the gods who help me, I mustered my chariotry and troops" (Grayson, *Assyrian Rulers* 2, p. 200, i 104).

²² "He made his way towards his *mountain*" (Anzu II 29); "The Lord made straight and pursued his way towards raging *Tiamat* (read: *sea*)" (En. el. IV 59–60).

²³ See also Simonetta Ponchia, "Analogie, metafore e similitudini nelle iscrizioni reali assire: Semantica e ideologia," *Oriens Antiquus* 26

(1987): 235–55. Mario Liverani, "Confine e frontiera nel Vicino Oriente del Tardo Bronzo: Spunti di discussione e riflessione," *Scienze dell'Antichità* 2 (1988): 79–99.

²⁴ This theme has been treated by Davide Nadali and Marta Rivaroli in a lecture held in December 2004 at the University of Rome, to appear in the next issue of *Studi e Materiali di Storia della Religioni* 73/1 (2007, in press).

Toponyms:*Desert, Mountain, River, Forest*

King goes through his territory

Adjectives:*Steep Mountain — High Water — Place of Thirst*

King enters into enemy's territory

Metaphors and Similes:*Rugged mountains which rose perpendicularly to the sky like the points of daggers*

Figure 4. Function of landscape in Assyrian royal inscriptions.



Figure 5. The king crosses the Euphrates with his army. Nimrud, Northwest Palace, Throneroom B. Assurnasirpal II (Slabs 10–9B, BM 124540–43, Copyright the Trustees of The British Museum; from Matthiae, *L'arte degli Assiri*, pl. 2.17).



“None of the kings who lived before me, had traveled the unblazed trails and wearisome paths which (stretch) along these rugged mountains”



Figure 6. The king in his chariot moves with his army in the mountains. Nineveh, Southwest Palace. Sennacherib (from A. H. Layard, *Discoveries in the Ruins of Nineveh and Babylon*, vol. 1 [London: J. Murray, 1853], pls. 40, 42, 43, and 45).

mountain reveals the “diversity” of the enemy territory, so too the description of the enemy, portrayed with different clothing and showing different customs, marks the border between the Assyrian and the foreign man and is thus functional in the building of the specific Assyrian identity.²⁵ The theme of the enemy as expression of alterity has been broadly analyzed. The enemy is described and represented either through his own ethnic marks—he is a Babylonian, an Aramean, a Phoenician—or through his liminal geographical origins (nomad, man of the mountain). He reveals his alterity even in his manners: he is weak, he is a coward, and at the same time he is a rebel, hostile, treacherous, and a liar.

THE FIGHT

In the mythical accounts the struggle of the god against the chaotic entity is visualized as a hand-to-hand fight between the two antagonists (fig. 7). The final result is to find in the annihilation of the disordered dimension (symbolized by the chaotic figure / the mountain / the stones), the necessary premise for the re-establishment of an ordered condition. In the same way, in the historical texts the goal of the royal military expedition is the destruction of “diversity” conceived as a menace to the Assyrian state. In the detailed description of the military action it is possible to trace most of the mythical recalls both in an allusive and in an explicit way.²⁶ This is probably due to the importance of this culminating phase, the most risky one: here the kings probably felt the need to bind their acts to the mythical dimension with the twofold purpose of achieving sacral legitimacy and at the same time of celebrating their role as holders of kingship. On a historical level, this proposes again the clash of two dimensions: the ordered and regulated against the uncivil and chaotic. For this reason the king thus portrays himself—in the conquest

²⁵ See also F. M. Fales, “The Enemy in Assyrian Royal Inscriptions: ‘The Moral Judgement,’” in *Mesopotamien und seine Nachbarn* (Papers Read at the 25^e Rencontre Assyriologique Internationale, Berlin, 1978), edited by Hans-Jörg Nissen and Johannes Renger (Berlin: Reimer, 1982), pp. 425–35; Carlo Zaccagnini, “The Enemy in the Neo-Assyrian Royal Inscriptions: The ‘Ethnographic’ Description,” in *Mesopotamien und seine Nachbarn*, pp. 409–24; Beate Pongratz-Leisten, “The Other and the Enemy in the Mesopotamian Conception of the World,” in *Mythology and Mythologies: Methodological*

Approaches to Intercultural Influences, edited by Robert M. Whiting, Melammu Symposia 2 (Helsinki: The Neo-Assyrian Text Corpus Project, 2001), pp. 195–231.

²⁶ See Weissert, “Creating a Political Climate,” pp. 194–95; Maul, “Der assyrische König,” pp. 210–11. See also Amar Annus, *The God Ninurta in the Mythology and Royal Ideology of Ancient Mesopotamia*, State Archives of Assyria Studies 14 (Helsinki: The Neo-Assyrian Text Corpus Project, 2002), pp. 94–101.

phase—employing topics parallel to the mythical ones even though from king to king different selections were adopted.²⁷ As the king is represented with elements that recall mythical actions, so the enemy is portrayed in a way similar to the descriptions of destructive demons in the mythical tales. Sennacherib calls the Babylonians “wicked demons” (*gallê lemnūti*).²⁸ In the same way Sargon II defines his enemy Marduk-apla-iddina as “a copy of the evil *gallû*” and this expression is later adopted by Assurbanipal, who describes the king of the Cimmerians as “the likeness of a *gallû*” (*tamšil gallê*). The *gallû*-demon is one of the allies of Tiamat in Enūma Eliš and the characteristic “evil being” (*lemnu*) is one of the epithets of Anzu in the Anzu Myth (Anzu II 21, 117, 139). Similarly, the verbs employed in the descriptions of the final overwhelming by the victorious gods of their chaotic counterparts, such as “tread upon (*kabāsu*) the neck of the enemy” and “trample (*dāšu*) the enemies”²⁹ are frequently attested in the Assyrian royal inscriptions.³⁰ The image of the king’s chariot overwhelming the enemies’ corpses as a *manifesto* of royal victory could be the iconographic counterpart of this theme. Moreover, this kind of visual rendering of victory over the enemy finds a formally identical correspondence in the hunting scenes of the reliefs of Assurnasirpal II and Assurbanipal. As noted above, the hunt is, in our opinion, a ritual counterpart of military action. On a historical level the king shows himself capable of defeating and overwhelming the enemy. It is our hypothesis that on a ritual level this very result is ratified through the representation of the lion hunt; the lions killed by the king are a symbolical version, on the one hand, of the enemy, and on the other hand, of the subdued chaotic forces.³¹ This is quite clear



Figure 7. Mythical fight between Ninurta and Anzu. Nimrud, Ninurta Temple (from A. H. Layard, *The Monuments of Nineveh*, vol. 2 [London: John Murray, 1853], pl. 5).

²⁷ For example, Assurnasirpal II relates but does not wholly identify himself with the deity. This is evident in the reliefs in his throne-room: the king is represented accompanied by—or better—driven by the god in the battle. Both are depicted through the same gestures. Sennacherib instead explicitly identifies himself with Marduk; this could be argued from the textual description of the battle of Khalule. As shown by Weissert, this description of Marduk’s equipment finds a parallel with Sennacherib’s: the terminology is in fact very similar to that used in the description of the god Marduk. As I pointed out in an earlier paper the way Sennacherib acts and presents himself is contrary to the parameters of proper sacral behavior supposed to be held by the kings in the tradition. See Rivaroli, “Aspetti sacrali dell’idea di confine,” pp. 176–78.

²⁸ Luckenbill, *The Annals of Sennacherib*, p. 41 v 18.

²⁹ “Then he turned back to Tiamat whom he captured. The Lord trampled upon the frame of Tiamat, with his merciless mace he crushed her skull” (En. el. IV 130).

³⁰ “Strong male who treads upon the necks of his foes, trampler of all enemies” (Grayson, *Assyrian Rulers 2*, p. 275: 3).

³¹ For the royal hunt theme, see Elena Cassin, “Le roi et le lion,” *Revue de l’Histoire des Religions* 198 (1981): 355–401; Chikako E. Watanabe, *Animal Symbolism in Mesopotamia: A Contextual Approach*, Wiener Offene Orientalistik 1 (Vienna: Institut für Orientalistik, 2002); Matthiae, *L’arte degli Assiri*, pp. 195–212; Elnathan Weissert, “Royal Hunt and Royal Triumph in a Prism Fragment of Ashurbanipal (82-5-22,5),” in *Assyria 1995: Proceedings of the 10th Anniversary Symposium of the Neo-Assyrian Text Corpus Project (Helsinki 1995)*, edited by Simo Parpola and Robert M. Whiting (Helsinki: The Neo-Assyrian Text Corpus Project, 1997), pp. 339–58.

in the visual—other than conceptual—juxtaposition of the two royal actions in the reliefs in the throneroom of Assurnasirpal II (fig. 8). The connection confirms the homology between the historical and ritual levels related to this crucial climax. In the Assyrian inscriptions up to Shamshi-Adad V, the hunting episodes are mostly placed after the summary of the military expeditions although sometimes they are inserted in the text after only a single campaign (Tukulti-Ninurta II, Assurnasirpal II, and Shamshi-Adad V). The narrative style and scheme of the hunt are similar to those of the military expeditions: as during the battle the king faces different enemies inhabiting the world outside of Assyria so too during the hunt he faces many species of beasts (lions, wild bulls, ostriches, and elephants) on the mountains or beyond the Euphrates, that is, in a peripheral setting. In addition, in both cases the king acts on behalf of the gods.³² Moreover, it is interesting to note that in the throneroom of Assurnasirpal II the representations of the ritual hunt are located at the beginning of the south wall immediately to the right of the throne base and then close to the relief representing the divine legitimation of the king. Directly afterwards—without apparently any clear separation—are the battle scenes. This “narrative” sequence is the exact reverse of the one previously revealed in the written documents.



Figure 8. Historical and ritual enemies of the king. Nimrud, Northwest Palace, Throneroom B. Assurnasirpal II (Slabs 19B–11B. BM 124534–124541, Copyright the Trustees of The British Museum; from Matthiae, *L'arte degli Assiri*, fig. 2.7).

³² “The gods Ninurta and Nergal, who love my priesthood, gave to me the wild beasts and commanded me to hunt” (Grayson, *Assyrian Rulers 2*, p. 291: 84–86).

VICTORY/SUBMISSION

In Enūma Eliš there is a very interesting passage: “As for the eleven creatures, the ones adorned with glories, and the demonic horde, which all went at her side. He *put on lead ropes*, he bound their arms. He *trampled them under*, together with their belligerence” (En. el. IV 59–60).

These actions—trampling on someone and putting on lead ropes—are iconographically rendered with the scenes of enemies’ submission by the Assyrian king: the defeated enemies are brought in chains before the king (fig. 9a) and in the act of submission the ruler “humiliates” the adversary precisely by trampling on his neck with his foot (fig. 9b). This gesture is the symbol of final victory achieved by the king upon the chaotic dimension. This is accomplished through the submission (*kanāšū*) of the enemies and their “assimilation” so that they can “enter” (*erēbu*) into the Assyrian empire as one of its components.

ORDERING NEW REALITY

In the mythical tradition, right after the overwhelming of the antagonist and his allies, the god starts the unavoidable ordering of the new reality. In Enūma Eliš there is an ex-novo foundation; in Lugale there is a re-establishment. Moreover, it is worth noting that during this creative process the subdued peripheral element is not totally erased. It is instead inserted in the newly ordered pattern with a “functional” aim. For example Tiamat, during the creative process accomplished by Marduk, becomes the very material substance employed to form the new reality. Furthermore, after the final ordering, the rival is firmly confined in a dimension from which he/she could not possibly escape (Asakku and Anzu are banished into the Netherworld, Tiamat is confined at the borders of the new ordered reality). This stage is to be recognized also in the historical accounts: the rebuilding of cities destroyed during the war; the renaming of the enemies’ cities with Assyrian toponyms; the erection of administrative palaces in their middle. These actions are

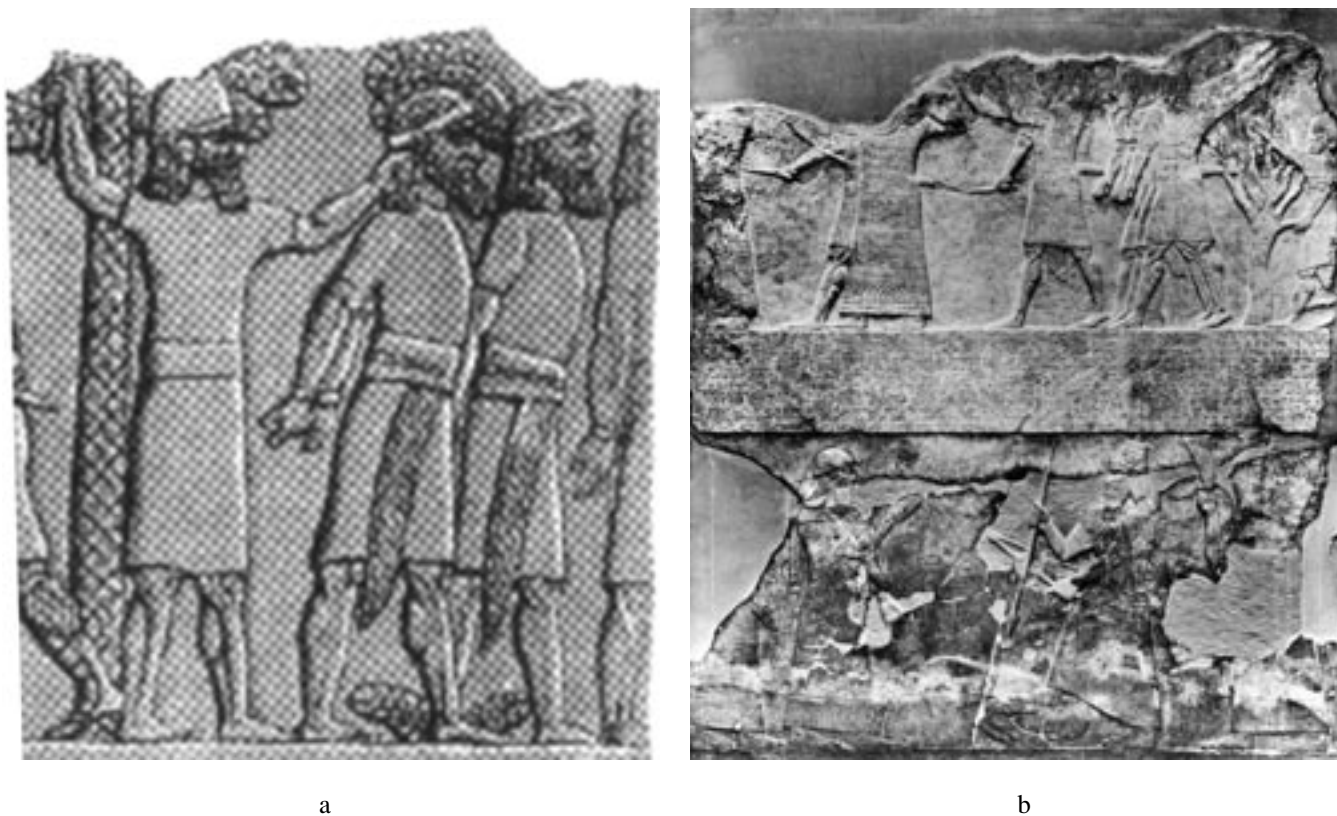

Figure 9. (a) Enemies are brought in chains in front of the Assyrian king. Nineveh, North Palace, Throneroom M. Assurbanipal (Slab 13 [detail], BM 124946, Copyright the Trustees of The British Museum; from Barnett, *Sculptures from the North Palace*, pl. 35); and (b) the Assyrian king “humiliates” the enemy trampling on his neck with his foot. Nimrud, Southwest Palace. Tiglath-Pileser III (Slab 34, BM 118933, Copyright the Trustees of The British Museum; from R. D. Barnett and M. Falkner, *The Sculptures of Assur-Nasir-Apli II (883–859 B.C.), Tiglath-Pileser III (745–727 B.C.), Esarhaddon (681–669 B.C.) from the Central and South-West Palaces at Nimrud* [London: British Museum, 1962], pl. 89).

carried out in order to erase practically and symbolically any remnant of the “chaotic” essence of the newly acquired “periphery.” The final act of the conquest is visualized in the reliefs through the procession of the vanquished enemy being led toward the king and carrying to him goods and tribute. This iconography clearly expresses the movement of the periphery toward the core and finds a parallel in the historical description.³³ The enemy’s capture and his inclusion in the Assyrian system represents another possible connection between the themes of Hunt and War: in the hunt ritual, royal duty pertains not only to the slaughtering of animals; the king is also represented entrapping wild animals and bringing them alive into “his country” so that his people could admire them.

FIXING NEW BOUNDARIES

In *Enūma Eliš* we read: “After he completed the work inside the sea, He loosened his net and let it out completely, Then he inspected heaven and earth [...] *their bonds ... twined*. He then cast down the lead-ropes, he made Ea take them” (En. el. V 61–68). Despite the break in the text it is clear that Marduk, after having created and internally organized the two cosmic regions, binds them to a third one—the Apsu—and holds them together. Only after this conclusive act can the last element created—the earth—be called *eršetu*. As is clearly expressed, it is only after the phases of crossing the borders, fight, submission, and organization of the new reality that it is possible to fix the newly acquired borders. On a ritual level the king parallels the commanding god. Two ceremonies can be recognized as connecting the king to this phase. One is the ritual ceremony of erecting the stele. The stele is the very symbol of the stability of the new fixed reality: in its entirety as iconographic representation and text it is always to be interpreted as a “border mark.” Once fixed it becomes the “image” (*šalmu*) of the king, ever-present, a kind of ritual substitute guaranteeing that what has been done is not alterable and it is so an immutable acquisition. Fixing a border is in the Assyrian concept the act immediately preceding the full constitution of a new reality. The process by which the new reality comes into being involves its delineation and separation from the rest, its inner ordered arrangement, its definition through a function, its being secured through the consolidation of the new border, and finally its acquiring stability and “existence” through the determination of its name. Only after having accomplished these duties can the mythic or historical main character go back and devote himself to the reorganization of the core. That is why the phase subsequent to the fixing of borders, the last of the narrative scheme, is here called “back home.” This phase represents the logical ending of the conquest and marks the restoration of order. On a mythical level we have seen the example of Marduk. On the historical level it corresponds to the act of erecting the stele by the king together with the presentation of tribute by the vanquished enemies to the king himself.³⁴ On a ritual level, in our opinion, these acts correspond to the concluding phase of the royal hunt as iconographically represented: the libation by the king over the dead lion (fig. 10). The parallelism of hunt and war previously revealed in relation to



Figure 10. The king libating over the dead lions. Nineveh, North Palace, Room S'. Assurbanipal (Slab D [detail], BM 124886, Copyright the Trustees of The British Museum; from Barnett, *Sculptures from the North Palace*, pls. 61–62).

³³ See, for example, Luckenbill, *The Annals of Sennacherib*, p. 24: 29–32.

³⁴ The erection of the stele symbolizes the ultimate conquest of the territory while the presentation of tribute symbolizes the full subjugation

of the enemy himself. Through these two actions the Assyrian king completes practically and culturally the process of “assyrianization.”

the moment of the struggle finds thus its final ratification in the concluding acts: on the “real” level the presentation of tribute; on the ritual level the act of libation. In the throneroom of Assurnasirpal II the two levels are in this case perfectly juxtaposed, suggesting an undeniable interrelation.³⁵ As noted before, in the fight phase the logical connection between the two levels is reversed in written documents and images: in the written narrative, the military episodes precede the venatorial ones; in the visual representation, they are reversed.

INSCRIPTION SEQUENCE

titulary – war – hunt

ASSURNASIRPAL II RELIEFS SEQUENCE

king’s presence – hunt – war

We miss in this scheme an important component: the phase of the core ordering after the enlargement of the borders. It is expressed in the inscriptions through the accounts regarding the building activities of the ruler. In the reliefs in the throneroom of Assurnasirpal II, it is expressed by the representation of the ordering king on the slab behind the throne podium—thus in the physical presence of the living king himself while he sits on the throne. So the sequence is:

INSCRIPTION SEQUENCE

titulary – war – hunt – building activity

ASSURNASIRPAL II RELIEFS SEQUENCE

king’s presence – hunt – war – living king’s presence

The reason for the difference between the written and iconographic sequence is, in our opinion, to be found in the different purposes of communication of the two media. From a historic-religious perspective, the ritual and the historical levels express two similar, but nonetheless not strictly identical concepts: the hunt is a ritual action, the war represents historical facts though sacrally safeguarded. Both in the written and iconographic narrative, these two levels are well defined and separated. For example, in the iconographic rendering of the throneroom of Assurnasirpal II the royal libation is right below the hunting action: the two representations in themselves sum up the whole ritual ceremony. The royal hunting scenes are located at the starting point of the “reading” sequence and, in our opinion, constitute the link between the king-god connection behind the throne and the military exploits of the king himself along the walls. The liminal position of the ritual actions perfectly matches the ritual prerogative guaranteeing spatially the connection between the god’s will and its “practical” enactment by the king. The same liminal location can be revealed in the narrative sequence of the inscriptions. The hunting descriptions are inserted at the end of the military accounts, as has already been pointed out, and before the building activity. The intended logic is the same; it changes the perspective. In the king’s palace, in the middle of the “core,” the reading sequence is conceived as moving from the core (the king sitting on the throne of “his” palace and with the god of the Assyrian state behind him) to the periphery (the battles) with the ritual action in the middle. In the Annals the sequence is inverted moving from the periphery (acquisition) to the core (building activity, i.e., palace) with the ritual in the middle. At the beginning, we saw the existence of a contraposition between core and periphery. The ritual action makes possible the “dialogue” between these two opposing realities (fig. 11).

³⁵ See also Meuszynski, *Die Rekonstruktion der Reliefdarstellungen*, pl. 1, for the juxtaposition of historical and ritual actions.

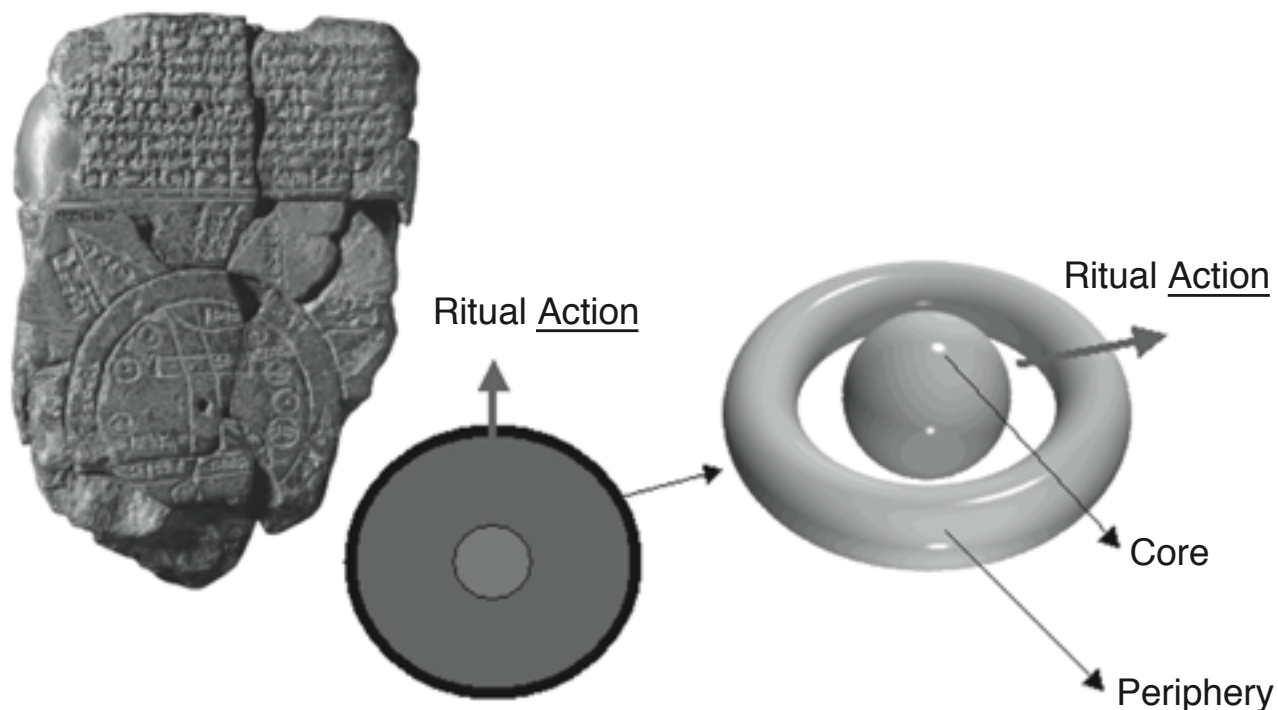

Figure 11. The ritual function. Mappa Mundi (BM 92687), Copyright by the Trustees of The British Museum.

3. CONCLUSION

As Amar Annus affirmed:

Some scholars have observed that formulations in the Assyrian royal inscriptions consciously create the image of the Assyrian king as terrestrial counterpart of the divine hero Ninurta/Marduk. His battle against political enemies is conceived as a re-actualization of Ninurta's mythic battle against Asakku (or Anzu) or Marduk's battle against Tiamat. This served as a mythologization of the Assyrian claim for expansion.³⁶

This kind of explanation is, in our opinion, not satisfactory. It is true that in the historical documentation there are clear mythical memories. They link the king's actions to divine actions that operated in a certain way in the time of origins (way of action, typology of weapons, terminology, etc.). It is true that these memories are possible only because they are justified by memories to a ritual practice. In the previous analysis we have stressed the presence of both mythical and ritual memories. In our opinion, the official documents were elaborated with a constant focus on the three levels through which the royal action was properly accomplished: the historical, ritual, and mythical levels. The three levels are well recognizable both in text and images though presented and marked in different ways. The differences are, in our opinion, connected primarily to the typology and therefore the potentiality of the medium of communication. In the written sources—as pointed out above—the description of the royal actions stresses the sacral attentiveness of the king and therefore his correctness. In every phase of the report the king acts only after having ritually obtained the favor of the deities. The ritual component is important—moreover, necessary—because it allows the king the connection with the time of origins without his being accused of acting with hubris. He does not dare to compare himself directly to the gods. He achieves nonetheless his purpose by recalling the god's action on a ritual level. As pointed out before, the divine entities permanently guarantee reality in the historical time by giving humankind the possibility of acting on a ritual level. The ritual action is the medium allowing a society to operate on the historical plan guaranteeing at the same time the stability of reality and identity. The written or iconographic medium is conceived thus as the expression at the same time of an ideology and of the tradition: a determined society

³⁶ Annus, "The God Ninurta," p. 95.

can in this way maintain firmly its own tie with the original dimension finding in it the guarantee and the possibility of an operative projection in the historical continuum. The re-actualization of the time of origins through the ritual practice is for this reason—in the historic-religious perspective—sacrally essential. Through divine confirmation the king shows to his court and to future kings that he acted (in military expeditions, tribute collecting, and building activity) in accordance with his role as mediator between divine will and human reality. Acting at the same time on a historical and on a ritual level he is authorized to insert the new conquered territory into the Assyrian reality by any means: in a political as well as a fully “cultural” way. In this perspective the mythical memories appear to be fundamental also in those documents defined by us as “historical” as well as in their iconographic counterparts. The presence of mythical and ritual motifs throws thus a new light on the textual and iconographic compositions and on that apparatus we call “propaganda.”³⁷ The commonly accepted propagandistic purpose of these media appears in this way far more complex than in our modernistic assumptions.

With this analysis we tried thus to reveal the complex mythical-ritual mechanism hidden behind the documents, both written and iconographic. The necessity of a sacral support comes clearly to light even analyzing the commonly defined “propagandistic expressions.”

³⁷ On the subject of royal propaganda there is an extensive bibliography. For a sample, see Paul Garelli, “La propagande royale assyrienne,” *Akkadica* 27 (1982): 16–29; Paolo Matthiae, “Il sovrano nei programmi figurativi e negli spazi architettonici dei palazzi assiri,” in *Assiri: L'arte, la guerra, il potere*, edited by Anna Vivante (Milan:

Guerini, 1995), pp. 117–45; Julian Reade, “Ideology and Propaganda in Assyrian Art,” in Larsen, ed., *Power and Propaganda*, pp. 329–43; Irene J. Winter, “Art in Empire: The Royal Image and the Visual Dimension of Assyrian Ideology,” in Parpola and Whiting, eds., *Assyria 1995*, pp. 359–81.

RECONSTRUCTING LEXICOGRAPHY IN GLYPTIC ART: STRUCTURAL RELATIONS BETWEEN THE AKKADIAN AGE AND THE UR III PERIOD

Alessandro di Ludovico and Marco Ramazzotti,
Università di Roma "La Sapienza"*

Our understanding of these mechanisms, though only fragmentary, does seem to me to have real implications for the study of human psychology. By pursuing the kinds of research that now seem feasible and by focusing attention on certain problems that are now accessible to study, we may be able to spell out in some detail the elaborate and abstract computations that determine, in part, the nature of percepts and the character of the knowledge that we can acquire the highly specific ways of interpreting phenomena that are, in large measure, beyond our consciousness and control and that may be unique to man.

— Noam Chomsky, *Language and Mind*, 1968

I. INTRODUCTION

Natural computing¹ can be considered a sector of cybernetics whose goal is the reproduction of some segments of the cognitive process.² On the methodological level, it is one of the most advanced sets of techniques dealing with the problems of the seriation and classification of data.³ Since it reproduces and expands some functions of

* Alessandro Di Ludovico is responsible for parts II and III, Marco Ramazzotti is responsible for part I; parts IV and V are the preliminary results of an ongoing discussion of methods, techniques, perspectives, and meanings of the archeological-historical communication related to some specific Near Eastern archaeological themes. Both authors are grateful to the Semeion Research Centre of Sciences and Communication (Rome), in particular to Prof. Dr. Paolo M. Buscema, Dr. Giulia Massini, Dr. Stefano Terzi, Dr. Guido Maurelli, Dr. Marco Intraligi, Dr. Vittorio Carlei, and Dr. Sabrina Ottaviani; their equipment, help, and suggestions have been fundamental in the development of this and future studies. Special thanks to George and the team of "Olympia Building," 613 N. Wells St., Chicago, for their wise words and our useful discussions.

¹ Natural computing is a general term referring to computing occurring in nature and computing inspired by nature. When complex phenomena occurring in nature are observed as computational processes, our understanding of these phenomena and of the essence of computation is enhanced. In this way one gains valuable insight into both natural science and computer science. Characteristic of human-designed computing inspired by nature is the metaphorical use of concepts, principles, and mechanisms underlying natural systems. This type of computing includes evolutionary algorithms, neural networks, molecular computing, and quantum computing.

² By natural computing we mean a set of informational methods and techniques destined to simulate some aspects of human rationality. The debate is still open as to the possibilities offered by the New Mathematical-Dynamical Technologies; since the origins of cybernetics (as a science related to the study of the cognitive processes), the artificial reproduction of semantic relations has been intended as the

central operative mechanism of each artificial language; see Norbert Wiener, *The Human Use of Human Beings* (Boston: Houghton Mifflin, 1950); William Ross Ashby, *An Introduction to Cybernetics* (London: Chapman and Hall, 1956); Marvin Minsky, ed., *Semantic Information Processing* (Cambridge: M.I.T. Press, 1968).

³ The application of connectionist models to the classification processes has grown during the last two decades; see David H. Ackley, *Connectionist Machine for Genetic Hill Climbing* (Boston: Kluwer Academic Publishers, 1987); Christopher M. Bishop, *Neural Networks for Pattern Recognition* (Oxford: Oxford University Press, 1995); Murray Smith, *Neural Networks for Statistical Modeling* (New York: Van Nostrand Reinhold, 1993); Brian Ripley, *Pattern Recognition and Neural Networks* (Cambridge: Cambridge University Press, 1996). However, the application of connectionist models to archaeological research is a later development linked both to "contextual" epistemological and theoretical problems; see Marco Ramazzotti, *La bassa Mesopotamia come laboratorio storico: Le Reti Neurali Artificiali come strumento di ausilio alle ricerche di archeologia territoriale* (Rome: Università di Roma "La Sapienza," 1999), pp. 37–70; Marco Ramazzotti, "La 'Rivoluzione Urbana' nella Mesopotamia meridionale: Replica 'versus' Processo," *Accademia Nazionale dei Lincei, Classe delle Scienze Morali Storiche e Filologiche, Rendiconti*, Serie 9, vol. 13 (2002): 651–752; to "specific" themes as the critical recognition of historical cultural horizons, see Marco Ramazzotti, "La fase 'Middle Uruk': Studio tramite Reti Neurali Artificiali su un orizzonte latente nella protostoria della Bassa Mesopotamia," in "Studi in memoria di Henri Frankfort (1897–1954) presentati dalla scuola romana di Archeologia Orientale," edited by Paolo Matthiae, special issue, *Contributi e Materiali di Archeologia Orientale* 7 (1997): 495–522;

cognitive and perceptive behavior,⁴ it can be reasonably applied also to the iconographic interpretation of ancient documents.⁵

The object of the preliminary study presented here is glyptic, in particular the group of images cut on the surfaces of the cylinder seals which derive from a symbolic language that can be directly associated with the state administrations of Mesopotamia (fig. 1a–c).

The simulations concern a particular Mesopotamian glyptic production dating to the Akkadian, the Post-Akkadian, and Ur III periods. Obviously, the origins and the absolute chronology of these findings are just part of the wide range of problems related to them. In fact, the project of understanding the figurative organization of these scenes requires an in-depth investigation of their complex lexicon, and the problems concerning the communicative and expressive aspects are complicated.

After a careful formalization of the data into mathematical language, some numerical matrixes have been formed. In these matrixes the images cut on the cylinder seals can be represented by a number of variables which, in theory, could be infinite.

D. L. Clarke,⁶ as well as other scholars after him,⁷ have written about matrix mathematics and their use in archaeology. What needs to be highlighted in this study is the empirical method: drawing up of the matrixes has followed a methodology that has allowed the checking and the comparison of the data at each step of the work (fig. 2).

By means of self-organizing maps (SOMs), or neural nets, some classes of discrete variables have been obtained which transfer the position and the weight of each figure in a multi-factorial space.⁸ The interpretation of the “codebooks,” i.e., the information included in each class, has led to the exploration of the reasons for the distinction of one cluster from the others.⁹ Finally, a non-linear technique of classification (called Pick-and-Squash Tracking, PST) was applied to the codebooks.¹⁰

Marco Ramazzotti, “Dall’analisi diacronia all’analisi sincronica: indagine sulle dinamiche insediamentali del periodo Jemdet Nasr nella regione di Warka,” *Scienze dell’Antichità* 10 (2000): 9–38; and for the fuzzy analysis of spatial and economical activities, see Marco Ramazzotti, “Analisi qualitativa dei depositi archeologici come indice guida delle ricerche a scala territoriale,” in *Reti Neurali Artificiali e sistemi sociali complessi: Teoria – Metodi – Applicazioni*, vol. 2, edited by Massimo Buscema (Milan: Franco Angeli, 1999), pp. 261–69; Marco Ramazzotti, “Modelli Insediamentali alle soglie del Protodinastico in Mesopotamia meridionale, centrale e nord-orientale: Appunti per una critica alla formazione “secondaria” degli stati nel III Millennio a.C.,” *Contributi e Materiali di Archeologia Orientale* 9 (2003): 15–71.

⁴ In particular the analogy between connectionist models and structural systems of the cognitive process has a long research tradition both in experimental psychology and in computer science; for a general but thorough view of the problems, see Jagjit Singh, *Teoria dell’informazione: Linguaggio e cibernetica* (Milan: Mondadori, 1969); John S. Denker, *Neural Networks for Computing* (New York: Snowbird Utah, 1986); *Neural Networks and Natural Intelligence*, edited by Stephen Grossberg (Cambridge: M.I.T. Press, 1988); Stephen I. Gallant, *Neural Network Learning and Expert System* (Cambridge: M.I.T. Press, 1993); Matthew Zeidenberg, *Neural Network Models in Artificial Intelligence* (New York: Ellis Horwood, 1990); *The Handbook of Brain Theory and Neural Networks*, edited by Michael A. Arbib (Cambridge: M.I.T. Press, 1995).

⁵ Indeed the main aim of this work is to study the iconography as natural language, processing in a reductionist way when considered from the traditional point of view in which explicit theories of the phenomena are built. The aim is to study semantics and pragmatics to see which phenomena might be successfully modeled using the artificial neural network approach based on self-organizing maps, and to consider the characteristics of its practical applications.

⁶ David L. Clarke, “Matrix Analysis and Archaeology with Particular Reference to British Beaker Pottery,” *Proceedings of the Prehistoric Society* 28 (1962): 371–83; David L. Clarke, “A Tentative Reclassification of British Beaker Pottery in the Light of Recent Research,” in *Analytical Archaeologist: Collected Papers of David L. Clarke*, edited by David L. Clarke (London: Academic Press, 1979), pp. 503–23.

⁷ Jean-Claude Gardin, “Problème d’analyse descriptive en archéologie,” *Études archéologiques* 8 (1963): 133–50; David G. Kendall, “Some Problems and Methods in Statistical Archaeology,” *World Archaeology* 1 (1969): 68–76; James C. Lingoes, “A General Nonparametric Model for Representing Objects and Attributes in a Joint Matrix Space,” in *Archéologie et calculateurs: problèmes mathématiques et sémiologiques*, edited by Jean-Claude Gardin (Paris: Éditions du CNRS, 1970), pp. 277–97; Stephen Shennan, *Quantifying Archaeology* (Edinburgh: Edinburgh University Press, 1985); Jaroslav Malina and Zdeněk Vašíček, *Archeologia: Storia, problemi, metodi* (Milan: Electa, 1997); Ken R. Dark, *Theoretical Archaeology* (London: Duckworth, 1995).

⁸ Self-organizing maps are a data visualization technique invented by Teuvo Kohonen which reduce the dimensions of data through the use of self-organizing neural networks. The problem addressed by data visualization is that humans simply cannot visualize high dimensional data unaided.

⁹ The way SOM operate in reducing dimensions is by producing a map, usually of two dimensions; this map represents the similarities of the data by grouping them together. So SOM codebooks accomplish two functions: they reduce dimensions and display similarities. See Teuvo Kohonen, *Self-Organization and Associative Memory* (New York: Springer, 1988); Teuvo Kohonen, “Self-Organized Formation of Topologically Correct Feature Maps,” *Biological Cybernetics* 43 (1988): 59–69; Teuvo Kohonen, “The Self-Organizing Map,” *Proceedings of the Institute of Electrical and Electronics Engineers* 78 (1990): 1464–80; Teuvo Kohonen, *Self-Organizing Maps* (New York: Springer, 1997).

¹⁰ The software realized in the Semeion laboratory in Rome in 1999 can generate distance matrixes coded in different measures. The PST places each point in a two-dimensional space using a non-linear evolutionary approach and minimizing the global error of projection. New space is defined only by minimal distortion of original distances: PST tries to “squash” information hidden in the original data in two dimensions; see Massimo Buscema and Stefano Terzi, “Un approccio evolutivo al problema della riduzione delle dimensioni,” *Sistemi Artificiali Adattivi in Biomedicina* 1 (2005): 154–64.



a



b



c

Figure 1. Impressions of cylinder seals dated to the (a) Akkadian period (Collon et al., *Catalogue of the Western Asiatic Seals*, no. 213), (b) Post-Akkadian period (Collon et al., *Catalogue of the Western Asiatic Seals 2*, no. 288), and (c) Ur III period (Buchanan, *Early Near Eastern Seals*, no. 626).

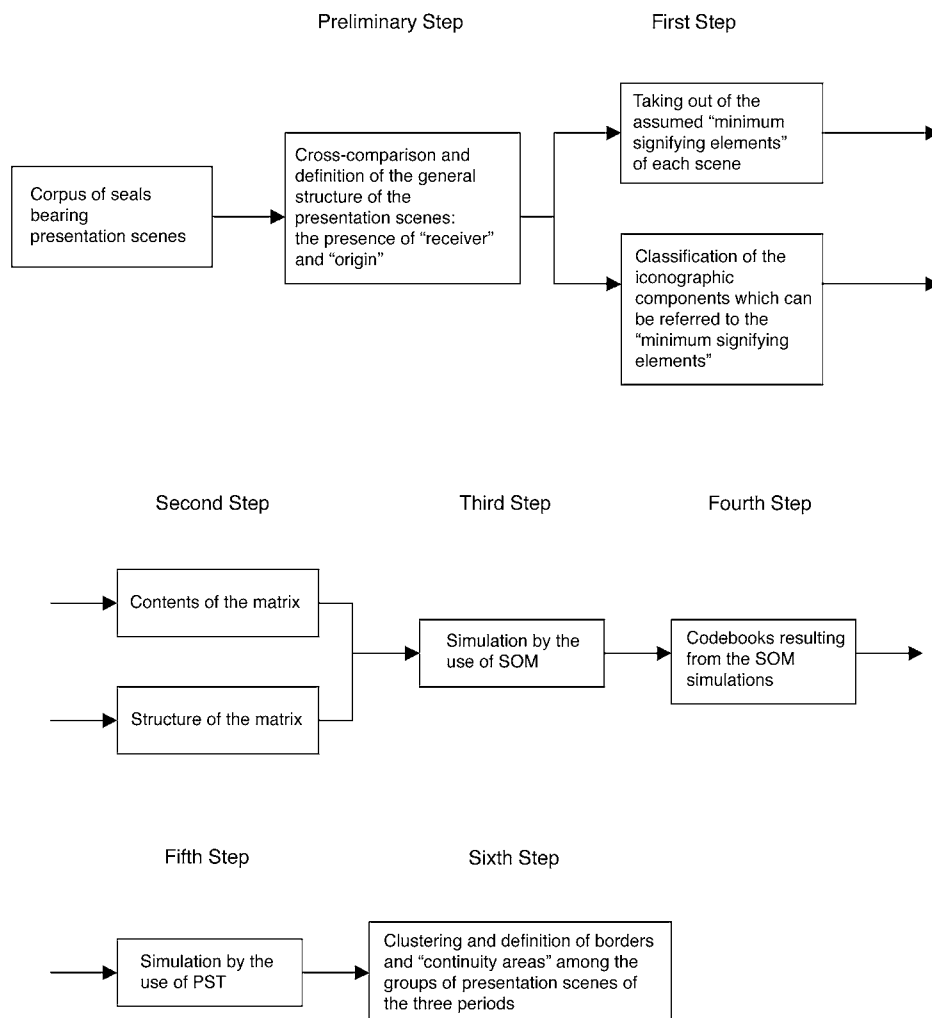

Figure 2. The experimental process.

The results are examined in a historical perspective, but it is of importance to consider the epistemological implications of this approach. First, there is the idea that every kind of language can be studied after being transferred to a non-linear sequence of variables. Recently, Kohonen has dealt with such complex correlations between the elements of nature.¹¹ Second, there is the effort to pursue a classification which is not grounded only on linear or

¹¹ It seems likely that the methods available are more suitable for the study of morphology and syntax. Furthermore, the artificial neural network models can offer a working methodology for dealing with these problems; see David E. Rumelhart and James L. McClelland, *Parallel Distributed Processing*, vol. 2, *Psychological and Biological Models* (Cambridge: M.I.T. Press, 1986), pp. 216–71; for a theoretical overview of the methods and techniques, see Marco Ramazzotti, *Archeologia e Semiotica: linguaggi, codici, logiche e modelli* (in press); indeed many scholars have also presented connectionist models for simulating both normal and disordered word production as well as child language acquisition; see Kimmo Koskeniemi, "Two-Level Morphology: A General Computational Model for Word-Form Recognition and Production" (Ph.D. diss., University of Helsinki, 1983). Despite the possibility of modeling linguistic phenomena in new ways, much of the connectionist linguistic study has dealt mainly with syntax and parsing and many models rely on the framework of well-known symbolic grammars; see Kanaan A. Faisal and Stan C. Kwasny, "Design of a Hybrid Deterministic Parser," in *Proceedings of the 13th Conference on Computational Linguistics*, vol. 1 (Morristown, New Jersey: Association for Computational Linguistics,

1990), pp. 11–16; Masami Nakamura, "Neural Network for Word Category Prediction," in *Proceedings of the 13th Conference on Computational Linguistics*, vol. 1, pp. 213–18. Connectionist approaches have been criticized with the claim that a proper linguistic method should be able to represent constituent structures and to model compositionality; see Jerry A. Fodor and Zenon W. Pylyshyn, "Connectionism and Cognitive Architecture: A Critical Analysis," *Cognition* 28 (1988): 3–71. Multiple responses can be given to this line of criticism. As for semantics and pragmatics, contextuality may be considered to be more important: the final interpretation of an expression is determined by the context in which it appears. In addition, specific models that capture compositionality have been developed using Recurrent Auto-Associative Memory; see Jordan B. Pollack, "Recursive Distributed Representations," *Artificial Intelligence* 46 (1990): 77–105. Moreover, the SOM can also represent implicit hierarchical structures; an introduction to several articles is given by Stefan Wermter, Ellen Riloff, and Gabriele Scheler, *Connectionist, Statistical and Symbolic Approaches to Learning for Natural Language Processing* (New York: Springer, 1996).

analogical principles. The most advanced stage in this kind of application has been reached by the applications of Multiple Correspondence Analyses to binary variables.¹² This classification, however, is not founded on the concept of the non-linear relations among the classes, and conceives the language as structured, rather than generated.¹³

In this study we accept that figurative language, like other languages, depends on hidden structures of consciousness that can generate many different expressive forms.¹⁴ This idea has been applied here to the study of Mesopotamian glyptic in an attempt to discover and follow the course of those hidden, non-linear processes which trace the differences. The ultimate aim is that of drawing a map which could allow us to recognize and diversify the lexicon of this figurative language.

II. THE DATA-SET DESCRIPTION: THE PRESENTATION SCENES IN GLYPTIC

The concept of presentation scenes has been fixed only in general terms and its boundaries are not well determined.¹⁵ This can be seen in particular in the different ways presentation scenes can be defined by scholars of different periods or of different nationalities.¹⁶

Since this motif is quite widespread in the glyptic of lower Mesopotamia and is attested over a long period of time, starting at least from the end of the Early Dynastic period, it can be assumed that it includes representations having a diverse range of meanings. It is, furthermore, apparent that diverse functions and meanings are found in the various cultural and political contexts in which presentation scenes occur.

The use in glyptic of scenes that can be referred to as a “presentation” group is first attested in the late Early Dynastic III period,¹⁷ but this theme appears to acquire importance only in the reigns of Naram-Sin and Šarkališarri of Akkad, though it is still not the most frequently attested.¹⁸ Presentation scenes acquire their greatest official importance only during the Third Dynasty of Ur, when they are clearly one of the main means of expressing state guarantee of transactions and documents.¹⁹

¹² Jean Gran-Aymerich et al., “Sur deux groupes de bucchero examinés au Louvre,” *Mélanges de l'École Française de Rome, Antiquité* 93 (1985): 243–95; Amilcare Bietti and Stefano Grimaldi, “Patterns of Reduction Sequences at Grotta Breuil: Statistical Analysis and Comparisons of Archaeological vs. Experimental Data,” *Quaternaria Nova* 1 (1990): 346–79; Jacques Hinout, “Les outils et armatures standards mésolithiques dans le Bassin Parisien par l'analyse des données,” *Revue archéologique de Picardie* 1 (1994): 9–30; Elena Rova, *Ricerche sui sigilli a cilindro vicino-orientali del periodo di Uruk/Jemdet Nasr*, *Oriens Antiqui Collectio* 20 (Rome: Istituto per l'Oriente C. A. Nallino, 1994); Elena Rova, “Metodi di codifica e analisi per lo studio di immagini strutturate: Un'applicazione ai sigilli cilindrici del periodo di Uruk/Jemdet Nasr,” *Archeologia e Calcolatori* 6 (1995): 7–34; Elena Rova and Sergio Camiz, “Exploratory Analyses of Structural Images: A Test on Different Coding Procedures and Analysis Methods,” *Archeologia e Calcolatori* 12 (2001): 7–45.

¹³ Jean-Paul Benzécri et al., eds., *L'analyse des données*, vol. 1, *La taxinomie*, vol. 2, *L'analyse des correspondances* (Paris: Dunod, 1973).

¹⁴ The problem has been discussed also for other categories of archaeological records; see Marco Ramazzotti, “Segni, codici e linguaggi nell'“agire amministrativo” delle culture protostoriche di Mesopotamia, Alta Siria e Anatolia,” in *ina kibrāt erbetti: Studies in Honor of Paolo Matthiae Offered by Colleagues and Friends on the Occasion of His 65th Birthday*, edited by Francesca Baffi et al. (Rome: Sapienza, 2006), pp. 487–511.

¹⁵ This theme has been discussed by Alessandro Di Ludovico, “Scene-in-frammenti: Una proposta di analisi delle ‘scene di presentazione’ dei sigilli a cilindro mesopotamici orientata all'elaborazione statistica ed informatica dei dati,” in “Studi in onore di Paolo Matthiae in occasione del suo 65° compleanno,” edited by Alessandro Di Ludovico and Davide Nadali, special issue, *Contributi e materiali di archeologia orientale* 10 (2005): 57–95. The concept of the presentation scene was used first by French scholars; in particular, the phrase was introduced by L. Heuzey and was originally applied to Ur III

glyptic, as Georges Contenau, *Umma sous la dynastie d'Ur* (Paris: P. Geuthner, 1916), p. 45, states: “Les deux scènes caractéristiques de la glyptique de cette époque sont ce que M. Heuzey a nommé les présentations.” Although the phrase has been in wide use at least since the 1930s (see, for example, Georges Contenau, *Manuel d'archéologie orientale: Depuis les origines jusqu'à l'époque d'Alexandre*, vol. 2 [Paris: Auguste Picard, 1931], pp. 754–56 and 789–93; Anton Moortgat, *Die bildende Kunst des alten Orients und die Bergvölker* [Berlin: Hans Schoetz, 1932], p. 19; Henri Frankfort, *Cylinder Seals: A Documentary Essay on the Art and Religion of the Ancient Near East* [London: MacMillan and Co., 1939], p. 143), the presentation scene has never been clearly defined.

¹⁶ Di Ludovico, “Scene-in-frammenti.” The problem of “translating” the concept of presentation scene is particularly evident, for example, in the disagreement between M. Haussperger and R. H. Mayr about the advisability of including in the group of presentation scenes those scenes with two figures: Rudolph H. Mayr, review of Martha Haussperger, *Die Einführungsszene: Entwicklung eines mesopotamischen Motivs von der altakkadischen bis zum Ende der altbabylonischen Zeit*, München–Wien 1991,” in *Bibliotheca Orientalis* 52 (1995): 460–64.

¹⁷ Anton Moortgat, *Vorderasiatische Rollsiegel: Ein Beitrag zur Geschichte der Steinschneidekunst* (Berlin: Gebrüder Mann, 1940), p. 22; Rainer M. Boehmer, “Glyptik von der frühsumerischen bis zum Beginn der altbabylonischen Zeit,” in *Der Alte Orient*, edited by Winfried Orthmann, *Propyläen Kunstgeschichte* 14 (Berlin: Propyläen, 1975), p. 221.

¹⁸ Rainer M. Boehmer, *Die Entwicklung der Glyptik während der Akkadzeit, Untersuchungen zur Assyriologie und Vorderasiatischen Archäologie, Ergänzungsbände zur ZA, n.F.*, 4 (Berlin: Walter de Gruyter, 1965), pp. 110–14.

¹⁹ One of the most thorough excursuses about the functions and meanings of the presentation scenes in the Ur III period is by Irene J. Winter, “Legitimation of Authority through Image and Legend: Seals

In the Ur III period these scenes appear to be increasingly standardized from compositional and formal viewpoints.²⁰ Though they play different roles in the different ages, it is very likely that the presentation scenes of the Akkadian period and those of the Ur III period are related and can be considered as representatives of different stages of the development of the same formal theme.²¹

This development continues in the following epochs, but our research has been limited to the periods in which this kind of scene starts to be used and reaches the apex of its diffusion in glyptic. A possible definition of what constitutes a presentation scenes follows.

The basic elements of a scene of this kind are the presence of a character who receives at least one other figure and the presence of a point, on the surface of the seal, where one can locate the beginning and the end of the scene. This point can be called the origin of the scene. The receiver almost always can be identified as well as the point of the origin, which is very often marked on the surface of the cylinder by inscriptions or objects, or by a different orientation of figures who are supposed to be opposite each other.

In our research a corpus of 297 seals bearing presentation scenes has been handled using tools based on the logic of computer science. The corpus is composed of scenes appearing on 103 Akkadian seals, 90 post-Akkadian seals, and 104 seals from the Ur III period. The so-called Post-Akkadian²² seals are not always easily recognizable, both because the duration of this period is limited and because the stratigraphic and epigraphic markers are scanty.²³ The points of reference used here to date seals to the Post-Akkadian period are primarily the seals found in contexts which can be set between the Akkadian and the Ur III periods.²⁴ Stylistic features have also been considered, but they can sometimes be misleading. The size of the sample used here is also limited to those having highly readable seals, since our analysis demands a large number of details.

III. CODIFYING THE INFORMATION: THE DATA SET

Our entire study is predicated on the idea that the presentation scenes are expressions of a formal language which essentially can be understood by a simulation by deconstructing its interacted elements. On the one hand, this kind of simulation permits one to translate the mechanisms of that formal language into a form that fits the logic

Belonging to Officials in the Administrative Bureaucracy of the Ur III State,” in *The Organization of Power: Aspects of Bureaucracy in the Ancient Near East*, edited by McGuire Gibson and Robert D. Biggs, *Studies in Ancient Oriental Civilization* 46 (Chicago: The Oriental Institute, 1987), pp. 69–116.

²⁰ Dominique Collon, *Catalogue of the Western Asiatic Seals in the British Museum, Cylinder Seals 2, Akkadian—Post Akkadian—Ur III Periods* (London: British Museum Publications, 1982), p. 129: “The presentation scene, which became increasingly common in the Old Akkadian period and remained popular throughout Post-Akkadian times ... was to be the chief subject in the seal-cutter’s repertoire for many generations and centuries to come. The subject itself became remarkably stereotyped.”

²¹ This idea is widespread; it is expressed explicitly and implicitly by Moortgat, *Vorderasiatische Rollsiegel*, p. 27; Edith Porada, *The Pierpont Morgan Library Collection, Corpus of Near Eastern Seals in North American Collections 1, The Bollingen Series 14* (Washington: Pantheon, 1948), p. 35; Frankfort, *Cylinder Seals*, p. 143; Martha Haussperger, *Die Einführungsszene: Entwicklung eines mesopotamischen Motivs von der altakkadischen bis zum Ende der altbabylonischen Zeit*, *Münchener Vorderasiatische Studien* 11 (Munich and Vienna: Profil, 1991).

²² The expression “Post-Akkadian” was first used by Porada, *Corpus of Near Eastern Seals*, pp. 31–32. In this study we use this expression although we do not consider it suitable, especially in regard to glyptic. Moreover, as discussed in Alessandro Di Ludovico, “Between Akkad and Ur III: Observations on a ‘Short Century’ from the Point of View of Glyptic,” to appear in the publication of the Proceedings of the 4th International Congress on the Archaeology of the Ancient Near East, Berlin, March 29th–April 3rd, 2004, edited by Hartmut Kühne et al.,

there is an absence of appropriate terms to refer to the period (and the material culture production) from the death of Šarkališarri to the ascension of Ur-Nammu. The use of paraphrase makes the descriptions much too tortuous.

²³ McGuire Gibson, *The City and Area of Kish* (Miami: Coconut Grove, 1972), pp. 49–50; Robert McC. Adams and Hans J. Nissen, *The Uruk Countryside: The Natural Setting of Urban Societies* (Chicago and London, University of Chicago Press, 1972), pp. 35–37; Paolo Matthiae, *La storia dell’arte dell’Oriente Antico: Gli stati territoriali, 2100–1600 a.c.* (Milan: Electa, 2000), pp. 9–11; William W. Hallo, “Gutium (Qutium),” in *Reallexikon der Assyriologie und Vorderasiatischen Archäologie* 3 (Berlin: Walter de Gruyter, 1957–71), p. 710; Jean-Jacques Glassner, *La chute d’Akkadé: L’événement et sa mémoire*, *Berliner Beiträge zum Vorderen Orient* 5 (Berlin: Dietrich Reimer, 1986), p. 48; Di Ludovico, “Between Akkad and Ur III.”

²⁴ McGuire Gibson, “A Re-evaluation of the Akkad Period in the Diyala Region on the Basis of Recent Excavations at Nippur and in the Hamrin,” *American Journal of Archaeology* 86 (1982): 531–38; Reinhard Dittmann, “Glyptikgruppen am Übergang von der Akkad zur Ur III-Zeit,” *Baghdader Mitteilungen* 25 (1994): 75–117; McGuire Gibson and Augusta McMahon, “Investigation of the Early Dynastic–Akkadian Transition: Report of the 18th and 19th Seasons of Excavations in Area WF, Nippur,” *Iraq* 57 (1995): 1–39; Donald Matthews, “The Early Dynastic–Akkadian Transition Part I: When Did the Akkadian Period Begin?,” *Iraq* 59 (1997): 2; McGuire Gibson and Augusta McMahon, “The Early Dynastic–Akkadian Transition Part II: The Authors’ Response,” *Iraq* 59 (1997): 9–14; Susan Pollock, “Chronology of the Royal Cemetery of Ur,” *Iraq* 47 (1985): 135–43.

which sustains the critical examination of ancient artifacts. On the other hand, it can stimulate self-criticism by showing the limits and arbitrariness of the scholar's epistemological behavior.²⁵ Since the corpus includes presentation scenes dating to at least three different historical periods, and since the formal homogeneity of these scenes appears to change abruptly in the Ur III period, it seemed important to investigate the presence of a wide range of details with a great number of variables.

The first step of the analysis is to break up every scene into its minimum significant elements (fig. 2). Of course, this operation has two problems. First, there is the need for a standard classification of the elements of all presentation scenes. Second, those elements need to be contextualized, as far as it is possible, within the continuity of the representation to which they belong. These minimum signifying elements are atomic parts that have, in fact, no independent meaning, since they have to be placed in relation to other similar elements in order to be part of a coherent message. This is approximately the way these elements have been considered here.

Dealing with the first problem, we have prepared a set of categories which contain and organize the elements of each scene. These categories are related to general concepts, but it is mainly important to adjust them periodically. The basic problems on which they are focused concern the features which describe the characters of the scene (their number, their sex, the directions toward which they are oriented, their poses, their clothing, their headdresses and beards, and the objects which serve as their attributes), the integrative motifs, and the inscriptions (both for the content and the way they are introduced into the composition).

Then, each feature empirically observed has been translated into variables, the number of which agree with the possible theoretical combinations between the features and the contexts to which they could belong. For instance, for the protagonists of the scene, every feature was referenced to at least six contexts, since the maximum attested number of participants is six. This method has led to a range of 1,332 variables.

Each seal has been *translated* into a string of 1,332 figures, each equivalent to 0 or 1, signifying respectively the absence and the presence of a feature. Two further adjustments, due to removing variables which are never attested in the 297 seals of the sample, have led to a reduction in the number of variables to 611. Of course, the variables which have been developed through the categories imply a certain loss of nuances, but they allow us to compare other scenes which are very different in date and composition.

Addressing the second problem, every element of each scene has been tied to at least one of the two spatial points of reference that can be seen in all presentation scenes. These two references are the *origin* of the scene and the figure in the role of the *receiver*, both mentioned above (fig. 3). They are of primary importance since they preserve the original order of the elements of the scenes after the formalization of those elements in a processing of variables through binary logic. Basically, this means that the formalization of the scenes and every subsequent simulation will always consider the variables as inserted in a "connective tissue" in which they are each placed together in relations that are comparable to those actually binding them in the composition of the scene.

In fact, in conformity with the structuralist assumption stated above, each of the elements which form the scenes acquires meaning depending on its relationship to the others. A formalization converting the scenes into a series of juxtaposed elements without specific reciprocal relations may lead to drastic distortion. For these reasons, the ideal "connective tissue" guiding the formalization process is of great importance.

In the set of variables the origin of the scene has been represented by O, while the receiver has been named figure 1. The other figures in the scene have been labeled by a progressive numbering, on the basis of the relations between their position and that of figure 1. The farther away they are from figure 1, the higher is the number assigned to them. This method, based on inner points of reference, allows us to consider all the figures in the scene, except the receiver, without preconceptions.²⁶ Both the other figures and the origin of the scene play the same role as does figure 1; the positions of the integrative motifs and the inscriptions are related to them, so that their contribution to the sense of the scene is constantly considered as depending mainly on the spatial context into which they are inserted.

²⁵ On this methodological and epistemological problem the debate is still open; see Ramazzotti, *Archeologia e Semiotica*.

²⁶ Scholars usually attribute very specific roles to the figures represented in the presentation scenes, as discussed in Di Ludovico, "Scene-in-frammenti."



a



b

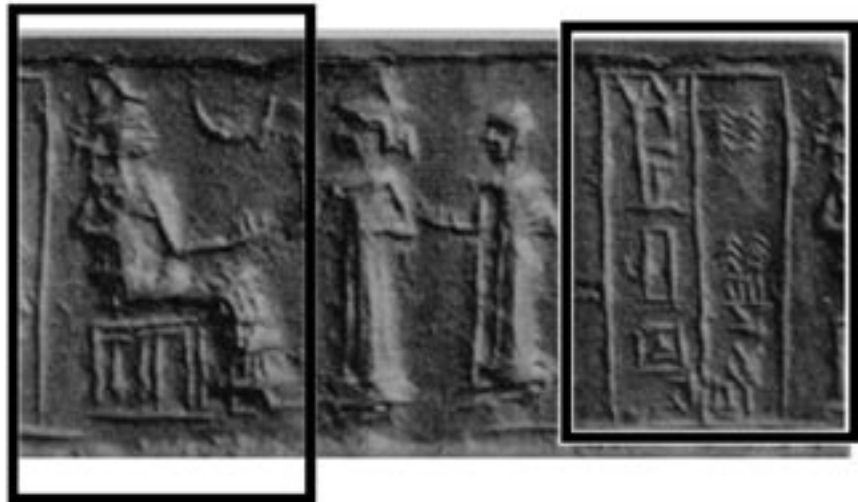

c

Figure 3. The basic elements of each scene. (a) Moortgat-Correns, "Die ehemalige Rollsiegel," no. 56; (b) Collon et al., *Catalogue of the Western Asiatic Seals* 2, no. 162; and (c) Moortgat, *Vorderasiatische Rollsiegel*, no. 261.

IV. THE RESULTS

The application of SOM models in the Semeion laboratory in Rome to the data set has led to the drawing of a multi-factorial map which distributed the seals of the corpus through sixteen knots of a net. The classes have been arranged in the net on the basis of the reciprocal similarity of the codebooks. The final map shows the kind of difference of each class from the others: the weight of each class of seals is graphically represented by the size of a sphere.

As stated above, the self-organizing maps belong to the group of the Autopoietic Artificial Nets, which are not supervised. In other words, they do not require an external input to develop the knowledge they need to achieve their results. A test of the map related to the chronological distribution of the seals has shown how the classes have been divided coherently into the three traditional periods. The Net has outlined codebooks which can be partly related to the specific production of each period and partly to overlapping or transitional phases (fig. 4).

The distribution of the codebooks relating to the Akkadian seals covers a wide area of the map, suggesting that the model classified those scenes as quite heterogeneous as regards their general semantic and syntactic arrangement. The distribution shows also that a number of types of presentation scenes of the Akkadian period is peculiar to this phase.

The production of the Post-Akkadian period appears to be much less heterogeneous and dispersed. According to the map, in this phase the themes of presentation tend toward a great reduction of the number of the codebooks. This probably means that the presentation scenes are now more standardized both compositionally and narratively. The scenes from the period of the Third Dynasty of Ur are clustered in codebooks which appear to be very close to each other and to collect a large number of records. The general trend seems to be that of an intensive standardization and a more clear-cut definition of the presentation scenes. These readings are not surprising, since in the long tradition of glyptic studies the Ur III period has been almost always considered an age of strong formalization and extensive use of this theme (fig. 5).

In order to investigate in more depth the *quality* of the differences of the codebooks, the results developed by the SOM have been further examined by means of a non-linear classification technique, the PST. The PST model projects onto a bi-dimensional space the actual distances which separate the codebooks. Thus, its application is particularly useful to display these Euclidean distances and interpret them as semantic relations.

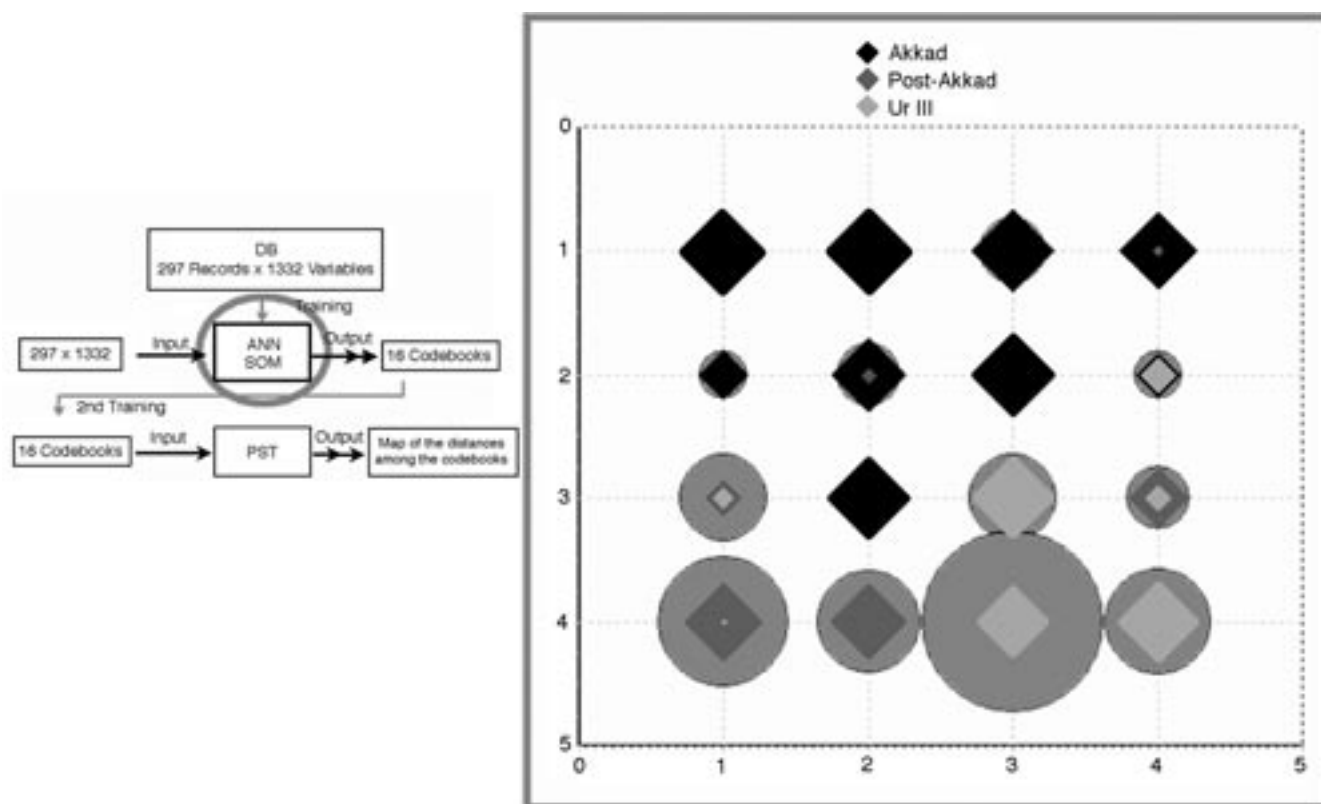

Figure 4. SOM pertaining to the presentation scenes of the three periods.

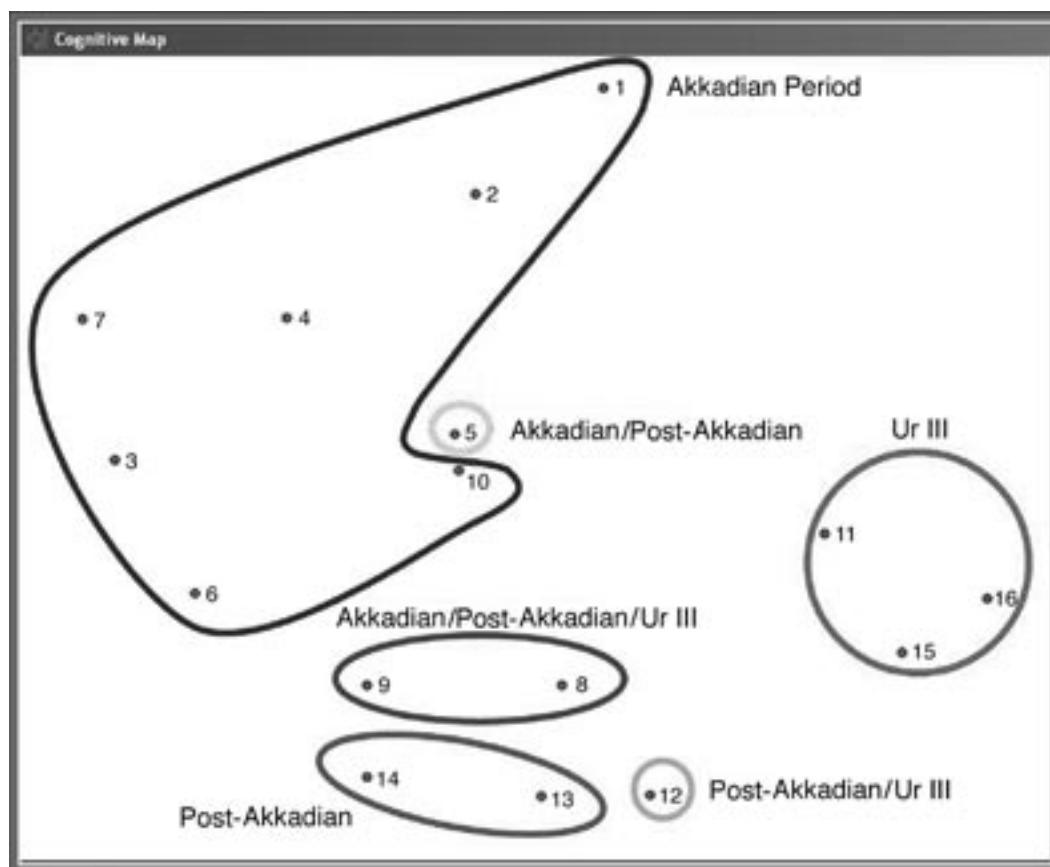

Figure 5. PST (Pick-and-Squash Tracking) Cognitive Map.

The sixteen codebooks obtained by the means of the SOM have been projected onto a new map by PST. The map shows in its central area the codebooks which can be interpreted as interfaces. Around this central area it is possible to single out several clusters, which, in the logic of the map, group semantically related codebooks.

The heterogeneity of the Akkadian scenes is clearly visible in this map. It is now possible to recognize more specific semantic relations among the ends of the cluster concerning this period. The Post-Akkadian scenes are partly distributed through the borderline areas of the map, and partly grouped in a well-circumscribed region. Finally, a large part of the Ur III scenes, grouped in three codebooks, have been placed in an isolated area, but the relationships of this production with those of the earlier periods are readable in some borderline clusters.

The Akkadian codebooks can be further classified into several different groups (fig. 6A:a–f; fig. 6B:a–d). Codebooks 1 and 2 include scenes which show, on the average, a high number of figures, mainly of divine nature.

These scenes can be organized following two major compositional schemes: that of the “introduction,” i.e., that which shows two figures hand-in-hand (fig. 6A:a–b), and that which shows a sequence of figures that are not physically connected and have varying poses (fig. 6A:c–d).

In Codebook 3, very far from 1 and 2, one finds again the hand-in-hand pair of figures, but in a different context (fig. 6A:e–f). In this group the pair is always a human figure and a deity; the scenes showing more than three protagonists usually include additional human figures besides figure 1 and the pair, such as the “situla bearer.” Most of the scenes in which the role of figure 1 is played by the sun god or by Enki are also included in this codebook.

The fundamental element of the scenes of Codebook 7 is the presence of a divine character placed between figure 1 and the hand-in-hand pair, or between figure 1 and a deity followed by a human being (fig. 6B:a–b).

In Codebook 6 some scenes are included which show a series of figures who face figure 1 and do not wear horned crowns (fig. 6B:c–d). All these characters appear to play similar roles in the scenes.

Codebooks 10 and 5 are not very numerous and seem to be quite heterogeneous (fig. 7:a–c). Codebook 10 includes only Akkadian seals. The map could suggest that they belong to a final phase of the period, since they are clearly close to those of group 5, which date to both the Akkadian and the Post-Akkadian periods. In most of the scenes of both codebooks the integrative motifs are infrequent.

Codebooks 13 and 14 include primarily Post-Akkadian scenes (fig. 8:a–d). They include scenes with the pair of characters who are hand-in-hand, as well as scenes in which figures are not in physical contact. In the first, the importance of the crescent as a distinguishing feature is very interesting: the presence or absence of this astral symbol coincides with the belonging of a scene to one or another of these groups. As for the second, the distinction seems to be based on the poses of the figures who face figure 1: in Codebook 14 they tend to be slightly different, while in Codebook 13 they tend to be similar.

Codebooks 8, 9, and 12 form the borderline between the three periods (fig. 9:a–c). Codebooks 8 and 9 include almost all the scenes in which two figures face each other in symmetrical poses (fig. 10:a). Except for those with the pair of figures shown hand-in-hand, most of the scenes that show the presence of an altar or a table between figure 1 and the other figures are in these groups. Codebook 12 includes very few scenes, most of them with only female figures, often in the arrangement of the pair approaching the seated figure 1 (fig. 10:c–d).

The corpus of Ur III scenes is mostly distributed through three codebooks (fig. 10:a–g). It is interesting that in the Codebooks 11 and 15 only scenes having an astral symbol in the upper part of the register, between figure 1 and figure 2, have been included. In Codebook 11 the astral symbol is mainly the one formed by the sun-disc inscribed in the crescent (fig. 10:c–e). It may also be significant that in this codebook scenes representing the goddess leading the human being by the hand and facing figure 1 are grouped together with scenes in which a small-sized female deity is placed in the lower half of the field between figure 1 and the standing human figure (fig. 10:e). This could mean that the role of the two female deities, the one leading the bald man and the small-sized one placed between the standing human being and figure 1, are semantically very close to each other.

In Codebook 15 one finds mainly the crescent, sometimes with the inscribed asterisk, placed in the upper part of the field between figures 1 and 2. In this group, there is a similarity between the scenes with two characters facing the goddess in the role of figure 1 and the scenes with just one goddess standing opposite the seated goddess (fig. 10:a–b).

Codebook 16 includes presentation scenes without astral symbols in the field. In this codebook the scenes always show the pair of figures who are represented hand-in-hand. Many of the various integrative motifs which can appear in these scenes seem not to have much influence on the general semantics of the compositions.

V. CONCLUSION

Who never doubted, never half believed. Where doubt is, there truth is — it is her shadow.

— Ambrose Bierce

The application of the Artificial Neural Nets has permitted a simulation process to match and integrate the information dynamically. The results show how crossed comparisons between the strings representing the scenes of the seals highlight a number of relations of semantic continuity and discontinuity in the general message of the scenes. Many of these relations are unexpected from the viewpoint of linear and analogical comparisons of the same records. This first step in using natural and self-organized classification systems concerns human ambition to handle the processes of the creation of figurative languages, and more generally those of that endless metaphor that is language. The path which develops is surely full of temptations which are a fundamental part of our humanity.

Both authors are particularly grateful to people and institutions who gave them permission for using photos of seal impressions: U. Kasten and Yale Babylonian Collection, New Haven; V. Ennor and British Museum, London; H. Kühne, U. Moortgat-Correns, and Freie Universität Berlin, Berlin; C. Giraudon and Musée du Louvre, Paris; L. Schramer and the Oriental Institute, Chicago; A. Gutow and Vorderasiatisches Museum, Berlin.

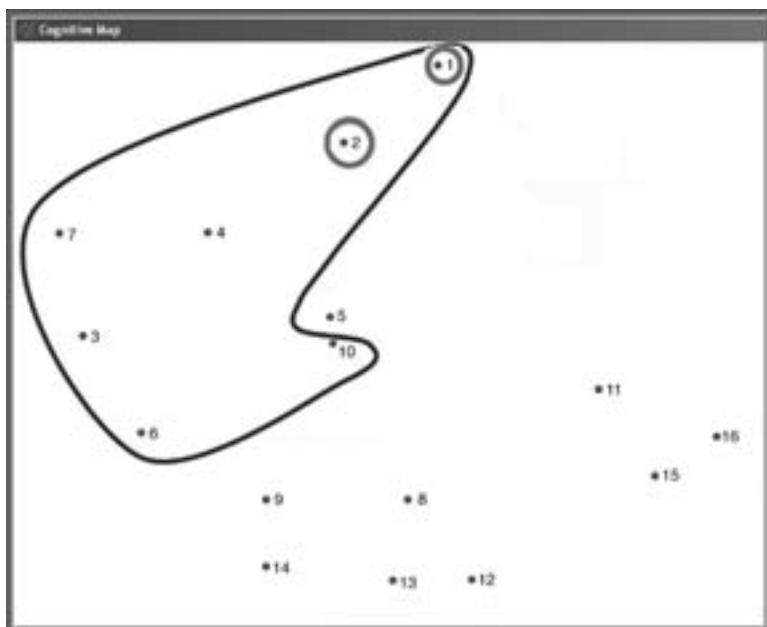

a



b



c



d



e



f

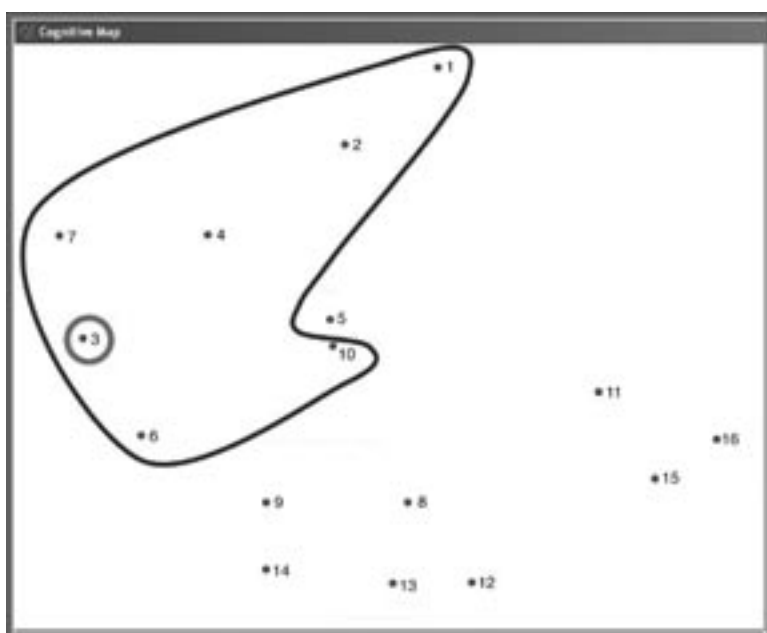
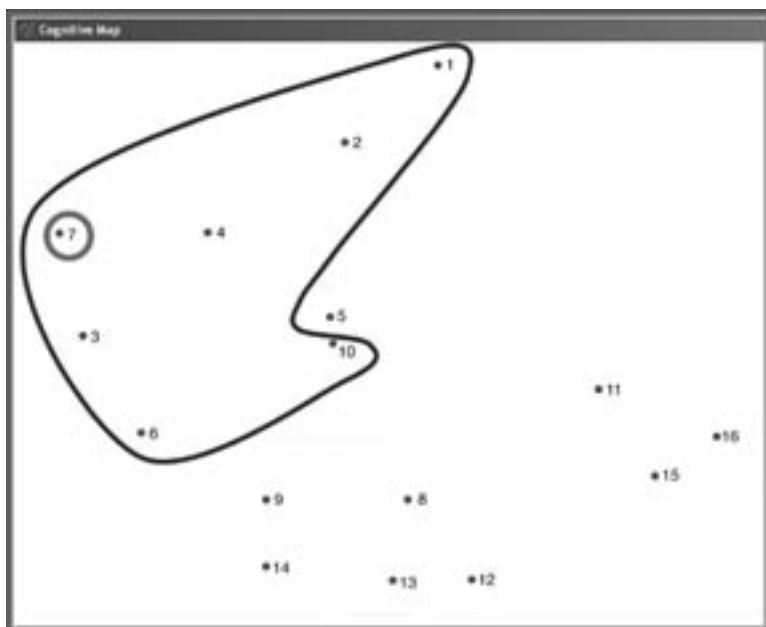

Figure 6A. (a) Buchanan, *Early Near Eastern Seals*, no. 470; (b) Frankfort, *Stratified Cylinder Seals*, no. 644; (c) Frankfort, *Stratified Cylinder Seals*, no. 609; (d) Collon, *Catalogue of the Western Asiatic Seals 2*, no. 231; (e) Collon, *Catalogue of the Western Asiatic Seals 2*, no. 159; (f) Frankfort, *Stratified Cylinder Seals*, no. 636.



a



b

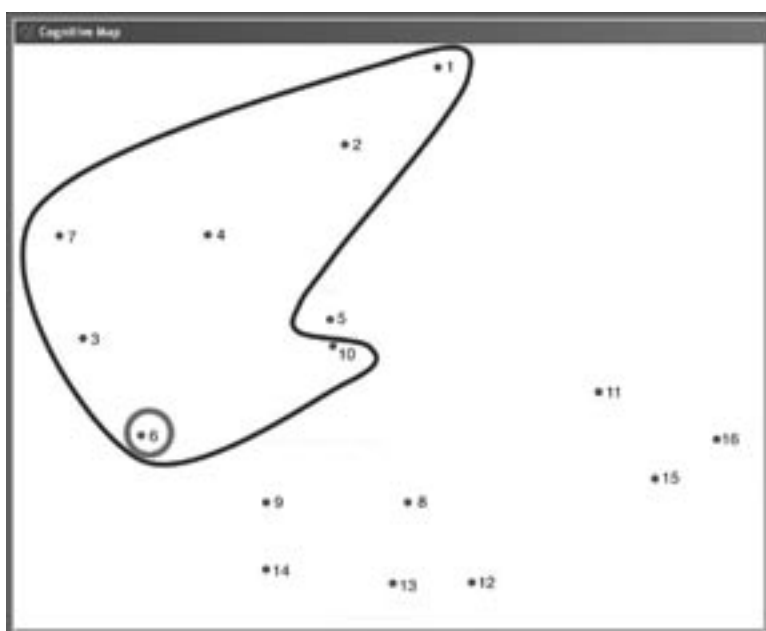

c



d

Figure 6B. (a) Collon, *Catalogue of the Western Asiatic Seals 2*, no. 157; (b) Collon, *Catalogue of the Western Asiatic Seals 2*, no. 162; (c) Collon, *Catalogue of the Western Asiatic Seals 2*, no. 217; (d) Parrot, *Glyptique mésopotamienne*, no. 196.

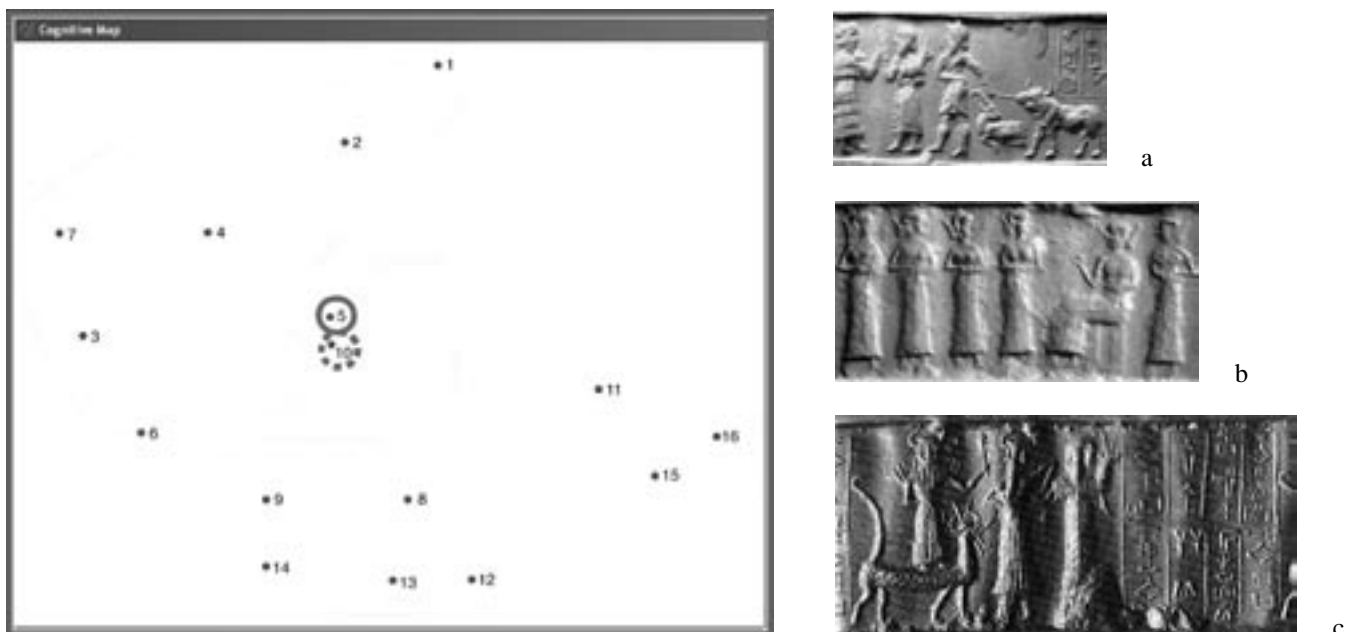

Figure 7. (a) Buchanan, *Catalogue of the Ancient Near Eastern Seals*, no. 367; (b) Buchanan, *Catalogue of the Ancient Near Eastern Seals*, no. 375; (c) Collon, *Catalogue of the Western Asiatic Seals 2*, no. 144.

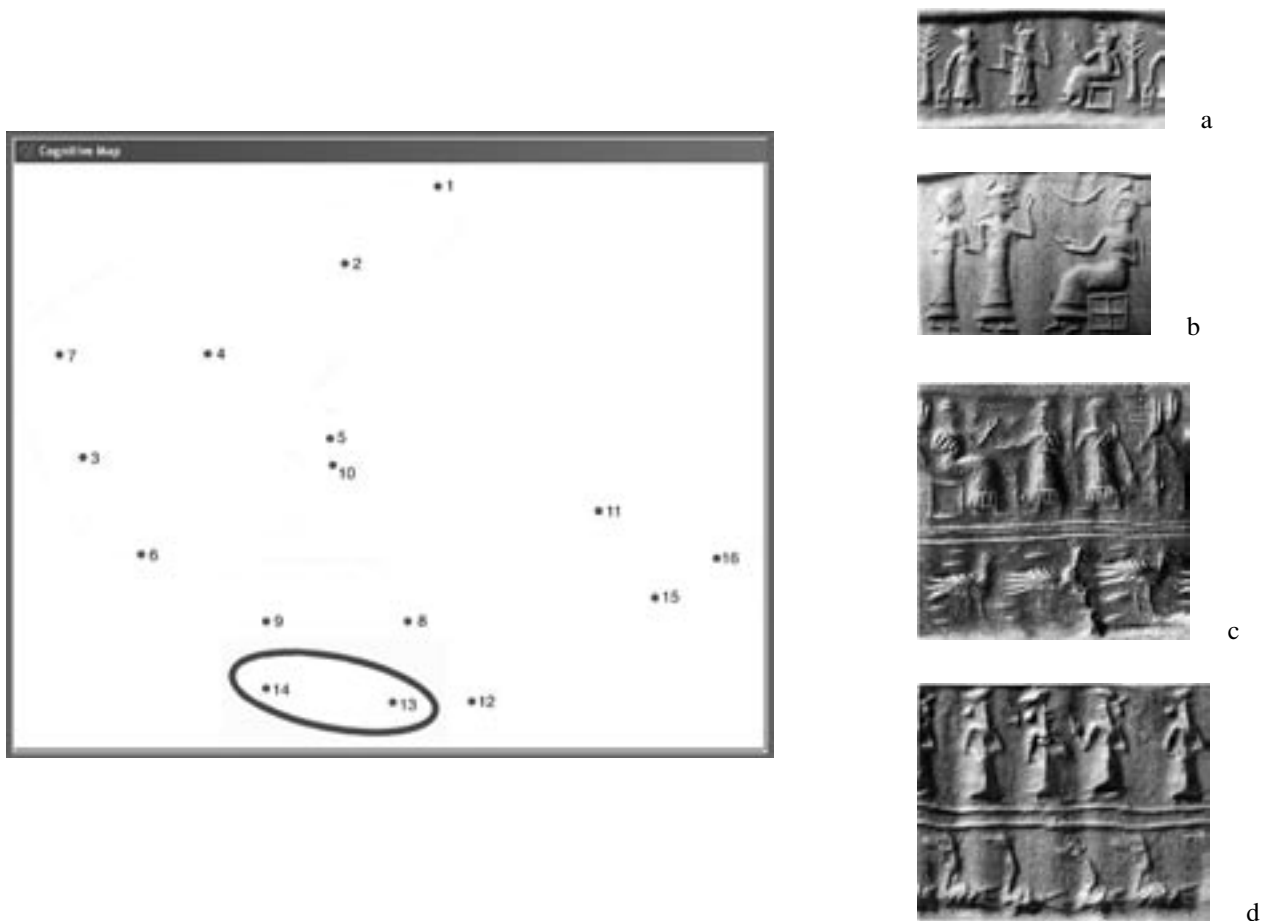
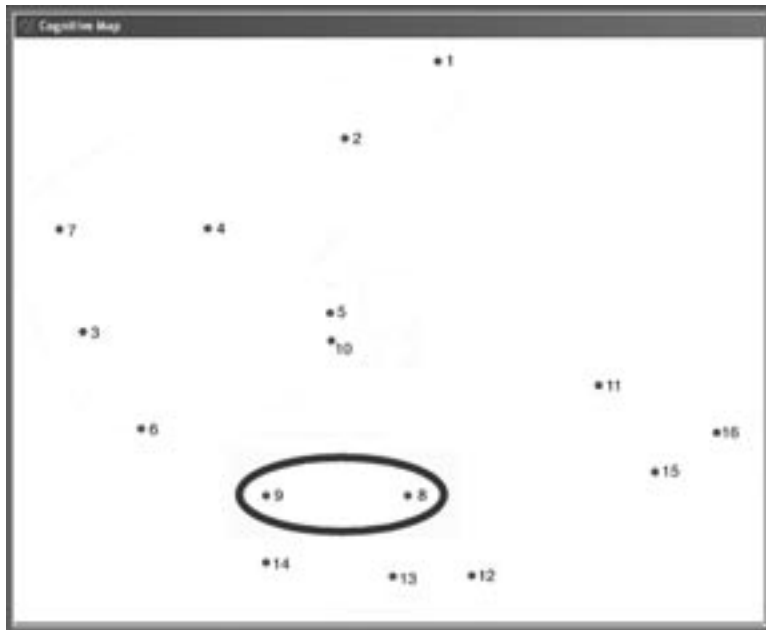

Figure 8. (a) Collon, *Catalogue of the Western Asiatic Seals 2*, no. 309; (b) Woolley, *Ur Excavations 2*, no. 294; (c) Frankfort, *Stratified Cylinder Seals*, no. 982; (d) Collon, *Catalogue of the Western Asiatic Seals 2*, no. 286.



a



b

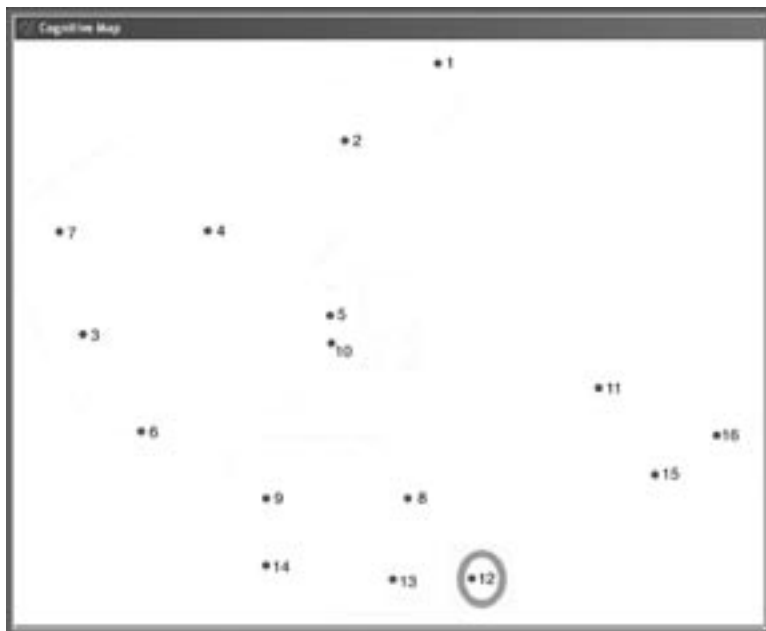

c

Figure 9. (a) Collon, *Catalogue of the Western Asiatic Seals* 2, no. 186; (b) Woolley, *Ur Excavations* 2, no. 188; (c) Legrain, *Ur Excavations* 10, no. 367.

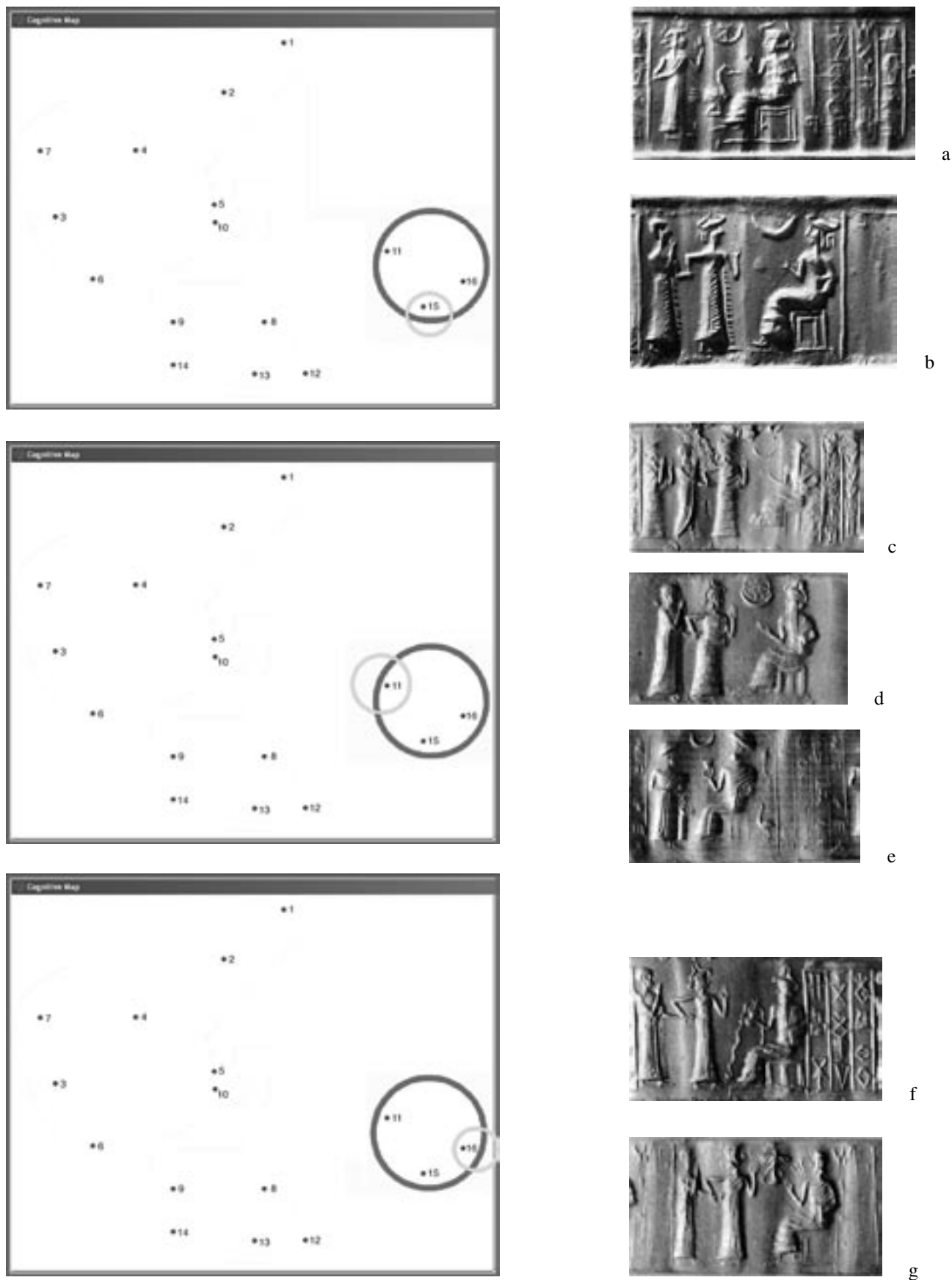

Figure 10. (a) Frankfort, *Stratified Cylinder Seals*, no. 768; (b) Buchanan, *Early Near Eastern Seals*, no. 552; (c) Collon, *Catalogue of the Western Asiatic Seals 2*, no. 437; (d) Collon, *Catalogue of the Western Asiatic Seals*, no. 432; (e) Collon, *Catalogue of the Western Asiatic Seals 2*, no. 451; (f) Collon, *Catalogue of the Western Asiatic Seals 2*, no. 439; (g) Collon, *Catalogue of the Western Asiatic Seals 2*, no. 390.

CATALOGUE OF THE SEALS USED FOR THE RESEARCH

- Erica Bleibtreu, ed., *Rollsiegel aus dem vorderen Orient: Zur Steinschneidekunst zwischen etwa 3200 und 400 vor Christus nach Beständen in Wien und Graz* (Vienna: Vorderasiatisches Museum, 1981): Nos. 33, 37, 38, 42, 47, 48, 49
- Briggs Buchanan, *Catalogue of the Ancient Near Eastern Seals in the Ashmolean Museum*, vol. 1, *Cylinder Seals* (Oxford: Oxford University Press, 1966): Nos. 344, 347, 348, 367, 369, 370, 373, 375, 381, 382, 383, 384, 385, 387, 389, 390, 392, 393, 395, 396, 399, 420, 421, 422, 424, 425, 441, 442, 446
- Briggs Buchanan, *Early Near Eastern Seals in the Yale Babylonian Collection* (New Haven and London: Yale University Press, 1981): Nos. 470, 472, 474, 475, 477, 478, 479, 480, 495, 538, 543, 545, 550, 551, 552, 553, 555, 557, 561, 562, 567, 626
- Dominique Collon, *Catalogue of the Western Asiatic Seals in the British Museum, Cylinder Seals 2, Akkadian—Post Akkadian—Ur III Periods* (London: British Museum Publications, 1982): Nos. 144, 157, 159, 160, 161, 162, 163, 164, 165, 166, 168, 169, 171, 184, 186, 187, 188, 193, 194, 195, 196, 198, 210, 211, 212, 213, 214, 216, 217, 219, 220, 221, 222, 223, 224, 225, 226, 227, 228, 230, 231, 233, 234, 236, 238, 286, 287, 288, 298, 299, 306, 307, 309, 311, 312, 314, 316, 317, 331, 332, 334, 368, 369, 370, 371, 372, 373, 374, 377, 378, 382, 384, 385, 386, 387, 389, 390, 391, 394, 396, 397, 403, 406, 415, 429, 432, 433, 437, 438, 439, 440, 446, 447, 448, 450, 451, 452, 453, 454, 459, 463, 467, 469, 470, 471, 472
- Louis Delaporte, *Catalogue des cylindres orientaux, des cachets et pierres gravées du Musée du Louvre* (Paris: Hachette, 1920): pl. 5, no. 11 (T.122), pl. 5, no. 1 (T.95), pl. 33, no. 3 (S.470), pl. 33, no. 12 (S.477), pl. 50, no. 5 (D.21), pl. 50, no. 7 (D.23)
- Claude Doumet, *Sceaux et cylindres orientaux: la collection Chiha*, *Orbis Biblicus et Orientalis, Series Archaeologica* 9 (Freibourg: Éditions Universitaires, 1992): Nos. 92, 94, 95, 96, 97
- Henri Frankfort, *Stratified Cylinder Seals from the Diyala Region*, *Oriental Institute Publications* 72 (Chicago: University of Chicago Press, 1955): Nos. 395, 404, 423, 438, 520, 577, 585, 589, 600, 609, 614, 617, 618, 626, 628, 636, 644, 647, 659, 662, 664, 669, 677, 689, 690, 691, 700, 709, 712, 768, 778, 982, 987
- Wilfred G. Lambert, "Near Eastern Seals in the Gulbenkian Museum of Oriental Art, University of Durham," *Iraq* 41 (1979): 1–45: No. 10
- Leon Legrain, *Ur Excavations*, vol. 10, *Seal Cylinders* (Oxford: Oxford University Press, 1951): Nos. 327, 329, 336, 343, 348, 356, 366, 367, 370, 388
- Anton Moortgat, *Vorderasiatische Rollsiegel: Ein Beitrag zur Geschichte der Steinschneidekunst* (Berlin: Gebrüder Mann, 1940): Nos. 193, 195, 203, 207, 213, 214, 215, 216, 250, 251, 259, 260, 261, 262, 265, 268, 269, 270, 271, 272, 273, 279, 280
- Ursula Moortgat-Correns, "Die ehemalige Rollsiegel – Sammlung Erwin Oppenländer." *Baghdader Mitteilungen* 4 (1968): 233–97: Nos. 46, 56, 57
- André Parrot, *Glyptique mésopotamienne: Fouilles de Lagash (Tello) et de Larsa (Senkereh) (1931–1933)* (Paris: P. Geuthner, 1954): Nos. 30, 31, 32, 34, 35, 39, 165, 169, 176, 177, 182, 196
- Edith Porada, *Corpus of Near Eastern Seals in North American Collections*, vol. 1, *The Pierpont Morgan Library Collection*, *The Bollingen Series* 14 (Washington: Pantheon, 1948): Nos. 245, 246, 247, 255, 257, 258, 260, 274, 275, 276, 277e, 282, 292e

Elizabeth D. Van Buren, *The Cylinder Seals of the Pontifical Biblical Institute*, *Analecta Orientalia* 21 (Rome: Pontificium Institutum Biblicum, 1940): No. 20

Hans H. van der Osten, *Ancient Oriental Seals in the Collection of Mr. Edward T. Newell*, *Oriental Institute Publications* 22 (Chicago: University of Chicago Press, 1934): Nos. 114, 115, 116, 117, 118, 122, 124, 126, 135, 136, 140, 141, 143, 186

C. Leonard Woolley, *Ur Excavations*, vol. 2, *The Royal Cemetery* (London: British Museum, 1934): Nos. 351 (U.11987), 306 (U.8916), 345 (U.11447), 343 (U.9586), 346 (U.10796), 281 (U.15302), 292 (U.12471), 294 (U.17912), 295 (U.17904), 282 (U.15308), 293 (U.17815), 188 (U.7956)

KNOWING THE FOREIGN: POWER, EXOTICA, AND FRESCOES IN THE MIDDLE BRONZE AGE LEVANT

Marian H. Feldman, University of California at Berkeley

The occurrence of apparently Aegean-type frescoes in the eastern Mediterranean during the second millennium, in particular the finds from Alalakh, Qatna, Tel Kabri, and Tell ed-Daba, has prompted a cacophony of theories regarding their source of origination, the identity or identities of their creators, and their significance with respect to intercultural relations between the Aegean and the East. At the root of all such questions lies a fundamental reliance on classification: are these “Aegean” frescoes and what does that ultimately mean? Classification systems are not invariant; nor are they self-evident. Indeed, it is important at least to attempt a reconstruction of how such frescoes may have been understood within their ancient context(s) before assuming that any classification system we impose upon them can be projected back in time. With a sensitivity to recovering ancient organizational conceptions of how the frescoes relate to other material culture and social identity as a whole, new perspectives on issues of interconnections can unfold.

FRESCOES IN THE EASTERN MEDITERRANEAN

In his early twentieth-century excavations at Alalakh (Tell Atchana) in the Amuq plain, Leonard Woolley discovered some of the most publicized of the eastern Mediterranean frescoes. Though often cited and at the center of many debates, they were rather poorly published in the 1950s and languished in the Ashmolean Museum in Oxford until recently when Barbara Niemeier and Wolf-Dietrich Niemeier re-examined them, substantially clarifying issues of subject matter and composition.¹ The Niemeiers’ interest in the Alalakh frescoes derives directly from their participation in excavations at Tel Kabri in Israel where a frescoed floor and fragments of what appears to be a miniature frieze were found in a palatial building.² In the 1920s, Robert du Mesnil du Buisson, working at Qatna (Tell Mishrife) along the middle Orontes River, discovered several fragmentary pieces of wall painting.³ These represented abstract marbling patterns that were dated, without much evidence, to the Mitannian period. Recently, however, the German component of the renewed Syrian-Italian-German expedition at the site has found more fragments that clearly date to the late Middle Bronze period.⁴ Perhaps the most spectacular of the eastern Mediterranean frescoes, yet also the most controversial, are those found in the eastern Delta of Egypt at Tell ed-Daba, the ancient Hyksos capital of Avaris, where multiple wall painting compositions were recovered, primarily from secondary contexts.⁵

¹ Leonard Woolley, *Alalakh: An Account of the Excavations at Tell Atchana in the Hatay, 1937–1949* (Oxford: Society of Antiquaries, 1955), pp. 228–34; Barbara Niemeier and Wolf-Dietrich Niemeier, “Aegean Frescoes in Syria-Palestine: Alalakh and Tel Kabri,” in *The Wall Paintings of Thera: Proceedings of the First International Symposium*, vol. 2, edited by S. Sherratt (Athens: Thera Foundation, 2000), pp. 780–89.

² Barbara Niemeier and Wolf-Dietrich Niemeier, “The Frescoes in the Middle Bronze Age Palace,” in *Tel Kabri: The 1986–1993 Excavation Seasons*, edited by Aharon Kempinski (Tel Aviv: Tel Aviv University Press, 2002), pp. 254–98.

³ Comte du Mesnil du Buisson, *La site archéologique de Mishrifé-Qatna* (Paris: E. de Boccard, 1935), p. 143.

⁴ Mirko Novák and Peter Pfälzner, “Ausgrabungen in Tall Misrife-Qatna 2001: Vorbericht der deutschen Komponente des internationalen Kooperationsprojektes,” *Mitteilungen der Deutschen Orient-Gesellschaft* 134 (2002): 226–31. Also from western Syria is a series of wall paintings from Tell Sakka near Damascus, which are said to

be executed in a technique similar to that of the Qatna paintings; see A. Taraqji, “Nouvelles découvertes sur les relations avec l’Égypte à Tell Sakka et à Keswé, dans la région de Damas,” *Bulletin de la Société Française d’Égyptologie* 144 (1999): 27–43. The imagery, however, is clearly egyptianizing rather than Aegean in content. In the absence of more complete publication, it is difficult at this point to assess the significance of the Tell Sakka paintings.

⁵ With references to earlier publications, Manfred Bietak, *Avaris: The Capital of the Hyksos, Recent Excavations at Tell el-Dab’a* (London: British Museum, 1996); Manfred Bietak and Nanno Marinatos, “The Minoan Wall Paintings from Avaris,” *Ägypten und Levante / Egypt and the Levant* 5 (1995): 49–62; Manfred Bietak, Nanno Marinatos, and Clairry Palyvou, “The Maze Tableau from Tell el Dab’a,” in *Wall Paintings of Thera*, vol. 1, pp. 77–88; Lyvia Morgan, “Minoan Painting and Egypt: The Case of Tell el-Dab’a,” in *Egypt, the Aegean and the Levant: Interconnections in the Second Millennium BC*, edited by W. V. Davies and L. Schofield (London: British Museum, 1995), pp. 29–53.

What appears to distinguish the paintings at Alalakh, Kabri, Qatna, and Daba from other Near Eastern and Egyptian paintings is the fresco technique, in which the paint pigment is applied directly to a lime plaster surface while it is still damp. There remains discussion regarding the exact nature of the various painting techniques used and the extent to which they occur at any one site; however, the primary technical distinction between the so-called Aegean painting style and wall paintings typically found in the Near East and Egypt is the use of a lime plaster surface that was damp for at least part of the decorative process.⁶ For example, the dampness of the plaster at the time of decoration is evident in impressed string lines, fingernail impressions, areas of plaster relief, incised outlines, and tool marks.⁷ This is in contrast to the tempera painting technique that uses a binding medium such as egg whites or glue to adhere to a dry surface, reflected in the use of guidelines created by snapping a paint-covered string against the dry surface.⁸ Likewise, the use of lime as the base for the plaster in these “Aegean-style” paintings differs from that of mud or gypsum-based surfaces typical of the Near East and Egypt,⁹ although in the absence of scientific analysis distinguishing between lime and gypsum plasters can be difficult. A further challenge lies in assessing the extent to which the fresco technique was applied similarly among different sites, which remains a complex question because of evolving modern technical analyses and inconsistent excavation practices.¹⁰

EASTERN MEDITERRANEAN FRESCOS AND CONNECTIONS WITH THE AEGEAN

Traditionally, scholarship on the frescoes found in the eastern Mediterranean has concentrated on artist identities and singular directions of influence.¹¹ Such studies debate whether the frescoes were created by Minoan and/or Cycladic artists, who may have traveled around the eastern Mediterranean as itinerant craftsmen. For example, in the final report on the frescoes from Tel Kabri, published in 2002, Niemeier and Niemeier write:

The presence of fresco paintings of Minoan style and iconography in foreign lands and cultural surroundings bear [*sic*] witness to export beyond the ethnic boundaries which has to be explained.... There are various possibilities: the frescoes were painted by travelling Aegean artisans; they were painted under the supervision of Aegean artists with the assistance of Levantine painters trained by them; they were painted by Levantine painters trained by Aegean masters. It is difficult to decide which is correct solutions [*sic*].¹²

Often accompanying such debates is the question of directionality for a presumed “dominant flow of influence,” typically understood as from east to west or vice versa.

Recent critiques of these approaches have shifted emphases to multidirectional exchanges and the role of artistic production in the construction of elite ideologies. Regarding artistic identity, such critiques have noted, in the words of Susan Sherratt, that “it does not seem ... to be helpful to stick ‘ethnicities’ firmly onto the creators ... of these East Mediterranean frescoes ... as though that were in itself some sort of complete and sufficient explanation for their existence.”¹³ Moreover, as Bernard Knapp has pointed out with respect to these frescoes, “ethnicity is a fluid

⁶ Ann Brysbaert, “Common Craftsmanship in the Aegean and East Mediterranean Bronze Age: Preliminary Technological Evidence with Emphasis on the Painted Plaster from Tell el-Dab’a, Egypt,” *Ägypten und Levante / Egypt and the Levant* 12 (2002): 95–107; Sara Immerwahr, *Aegean Painting in the Bronze Age* (University Park: Pennsylvania State University Press, 1990), pp. 14–15; Astrid Nunn, *Die Wandmalerei und der glasierte Wandschmuck im alten Orient* (Leiden: Brill, 1988), pp. 5–17; and see the various contributions under Session 1: Technical Dimension, in *Wall Paintings of Thera*, vol. 1.

⁷ Brysbaert, “Common Craftsmanship,” pp. 96–99.

⁸ Maria C. Shaw, “Grids and Other Drafting Devices in Minoan and Other Aegean Wall Painting: A Comparative Analysis including Egypt,” in *METRON: Measuring the Aegean Bronze Age*, Proceedings of the 9th International Aegean Conference, New Haven, Yale University, 18–21 April 2002 (Aegaeum 24), edited by Karen Polinger Foster and Robert Laffineur (Liège: Université de Liège; Austin: University of Texas at Austin, Program in Aegean Scripts and Prehistory, 2003), p. 186.

⁹ Brysbaert, “Common Craftsmanship”; Nunn, *Die Wandmalerei*, pp. 5–17.

¹⁰ The forthcoming publication of Ann Brysbaert’s recently completed dissertation at the University of Glasgow, in which she applies standard analyses to painted plaster fragments from most of the major second-millennium sites in the Aegean and Near East, should rectify this problem.

¹¹ For a review of scholarship, see A. Bernard Knapp, “Mediterranean Bronze Age Trade: Distance, Power and Place,” in *The Aegean and the Orient in the Second Millennium*, Proceedings of the 50th Anniversary Symposium, Cincinnati, 18–20 April 1997 (Aegaeum 18), edited by Eric H. Cline and Diane Harris-Cline (Liège: Université de Liège; Austin: University of Texas at Austin, Program in Aegean Scripts and Prehistory, 1998), pp. 200–02.

¹² Niemeier and Niemeier, “Frescoes in the Middle Bronze Age Palace,” pp. 281–82.

¹³ Susan Sherratt, “Comment on Ora Negbi, The ‘Libyan Landscape’ from Thera: A Review of Aegean Enterprises Overseas in the Late Minoan IA Period,” *Journal of Mediterranean Archaeology* 7/2 (1994): 237.

and dynamic, contested phenomenon, manifested in different ways in different contexts, with relation to different forms and scales of interaction.”¹⁴ Likewise, the issue of influences has been challenged, primarily because of its neglect of agency and selection on the part of the receivers.¹⁵ Overlooking the element of choice that producers make when they adopt or emulate foreign elements, the concept of influence rarely acknowledges that an entity, whether a person or a culture, cannot be influenced unless it is receptive. Scholars such as Sherratt and Knapp argue instead for the active role that these frescoes may have played in “the forging of an élite *koiné*.”¹⁶ Knapp goes one step further, suggesting that the appearance of these frescoes in the eastern Mediterranean should be understood as a display of exotica signaling knowledge of distant places. Building on work done by anthropologists such as Mary Helms, he notes that “objects, information, and experiences obtained from afar are imbued with latent power and have the capacity to increase the prestige and status of those who acquire them.”¹⁷

Yet if we pursue this kind of thinking, we are ultimately talking more about reception, or at least anticipated receptions, since that is what underlies motivations for production according to these theories. And to approach reception is to enter the realm of knowledge; specifically, how did the people at Alalakh, Qatna, Kabri, or Daba view these frescoes? Did they consider them “foreign,” “exotic,” or “other,” or were they instead part of a commonly accepted and known “*koiné*”? Answering these questions is of course not simple, and indeed there is probably no one answer but rather multiple answers depending on various audiences.¹⁸ At the most basic level, “otherness”—that which makes something “exotic” or “foreign”—is based on difference.¹⁹ Thus, one way to get at this question is to try to evaluate degrees of difference or variation between the frescoes and other areas of material culture. It is also useful to keep in mind how difference or otherness might have been purposely accentuated or spotlighted by elites as a central means to provoke awareness of their exclusivity, including the exclusivity that comes with knowledge.

CLASSIFICATION OF FRESCOES

Instinctively, it might seem that textual evidence would provide the soundest avenue into questions concerning reception and knowledge. Near Eastern sources, however, are notoriously laconic when it comes to exposition on or ekphrasis of material culture remains. Apart from several accounting references to items designated as of Kaptara, most likely Crete, in the Mari letters,²⁰ there is little in the written documents to give clues about perceptions of “otherness” or exoticism.²¹ The texts do, nonetheless, make clear that contact with areas and/or people (merchants) of the Aegean occurred, if on an infrequent basis, confirming what might already be guessed, namely that individuals were moving throughout the area of the eastern Mediterranean.²² This evidence at least answers the question of how to explain the use of an “Aegean” technology, since ideas circulate with people, even if it does not necessarily shed light on the motivation(s) for the choice. The “who” behind the actual painting of the frescoes, thus, may be of less importance than the “why.” Regardless of whether these paintings were physically executed by artists who were

¹⁴ Knapp, “Mediterranean Bronze Age Trade,” p. 202.

¹⁵ For example, see discussions in Marian H. Feldman, *Diplomacy by Design: Luxury Arts and an “International Style” in the Ancient Near East, 1400–1200 BCE* (Chicago: University of Chicago Press, 2006), pp. 3–4; Irene J. Winter, “Perspective on the ‘Local Style’ of Hasanlu IVB: A Study in Receptivity,” in *Mountains and Lowlands: Essays in the Archaeology of Greater Mesopotamia*, edited by L. D. Levine and T. Cuyler Young, Jr. (Malibu: Undena, 1977), pp. 381–82.

¹⁶ Sherratt, “Comment,” p. 237.

¹⁷ Knapp, “Mediterranean Bronze Age Trade,” p. 195.

¹⁸ Our ability to distinguish specific audiences that may have had access to the buildings in which these frescoes appear is fairly limited.

¹⁹ For one discussion of exoticism in the arts, albeit with respect to nineteenth-century European reception of Mesopotamian art, see Frederick N. Bohrer, *Orientalism and Visual Culture: Imagining Mesopotamia in Nineteenth-Century Europe* (Cambridge: Cambridge University Press, 2003), pp. 10–41.

²⁰ Michaël Guichard, “Les mentions de la Crète à Mari,” in *L’acrobate au taureau: Les découvertes de Tell el-Dab’a (Égypte) et l’archéolo-*

gie de la Méditerranée orientale (1800–1400 av. J.-C.), edited by Annie Caubet (Paris: La Documentation Française and Musée du Louvre, 1999), pp. 165–77; see also the brief review of textual evidence in Ora Negbi, “The ‘Libyan Landscape’ from Thera: A Review of Aegean Enterprises Overseas in the Late Minoan IA Period,” *Journal of Mediterranean Archaeology* 7/1 (1994): 84–85.

²¹ The designation of objects, generally small-scale, portable items of value, as Kaptaran may, in itself, signal a response to their “foreignness,” but this must be inferred; there is nothing explicit in the texts themselves. Some of the Mari texts provide information of a more detailed kind regarding the physical appearance of the Kaptaran items, which also might be taken to indicate their unusual qualities (Guichard, “Les mentions de la Crète,” pp. 173–74).

²² G. Dossin, “La route de l’étain en Mésopotamie au temps de Zimri-Lim,” *Revue d’Assyriologie* 64 (1970): 97–106; Guichard, “Les mentions de la Crète,” pp. 167–68; Cécile Michel, “Le commerce dans les textes de Mari,” in *Amurru 1: Mari, Ébla et les Hourrites: Dix ans de travaux*, part 1, edited by Jean-Marie Durand (Paris: Éditions Recherche sur les Civilisations, 1996), pp. 406 and 414.

born and trained in the Aegean or born elsewhere but trained in the techniques of Aegean-type fresco painting, the more pressing question is why rulers of eastern Mediterranean polities desired and commissioned such frescoes for their public buildings.

In the specific case of the frescoes, artifactual evidence can assist more productively than texts in exploring questions of reception, because human beings construct identities and negotiate social relations in part through the material culture items with which they surround themselves (that is, items that they produce, consume, exchange, display, etc.).²³ To assess difference, the frescoes in the Levant²⁴ need to be approached through a framework of total “social structuration,”²⁵ within the largest possible sweep of Middle Bronze Age material culture.²⁶ There are, of course, inherent challenges in such an approach that must be kept in mind. One of the most profound is the unevenness and inconsistency of the surviving artifactual evidence, which weakens any arguments based on absence of evidence.

Many of the debates regarding whether Aegean artists painted the Levantine frescoes rest on similar exercises of evaluating difference. I want to stress, however, that I am in complete agreement with Susan Sherratt, Bernard Knapp, and others who argue that determining a presumed ethnic or national identity of the artist is both extremely tenuous and, more to the point, ultimately not productive in explaining the social role of these frescoes in a Levantine context. Thus, what I am trying to demonstrate through this analysis is not who created the frescoes, but how they might have been understood by Levantine audiences. One way to access Levantine reception of the frescoes is to calibrate degrees of their “Levantine-ness” or “Aegeanness.” Since human beings create and use material objects to structure their environment and social relations, and because these social materializations encompass the entire range of artifactual production, we should be able to evaluate degrees of perceived otherness through analysis of interconnected sets of physical assemblages in which ancient audiences were immersed.

While a majority accepts the view that the frescoes found in the Levant are Aegean in both technique and motival details and style, others have questioned this stance. For example, Susan Sherratt wrote provocatively, “[i]f Bietak had got to Dab’a, or Kempinski and Niemeier to Kabri, before Evans got to Knossos, I doubt if the question of a diaspora of Aegean fresco artists to the east would seriously have arisen.”²⁷ Sherratt is right to challenge what she calls the Aegeocentric view of the frescoes, yet in my opinion the greater issue is the *assumption* of “Aegeanness” without demonstration, and further, the implication that “Aegeanness” must indicate “Aegean” artists.

The first task, then, is to compare degrees of difference (or similarity) between the frescoes and other material culture in the Aegean. Evaluating the motifs and styles of the Levantine frescoes is, nonetheless, difficult given their extremely fragmentary nature and the still-early stages of their reconstruction. At Alalakh, according to the new studies by the Niemeiers, the subject matter includes pale, swaying reeds against a red background, a frontal bull’s head and possibly a sacred ax between its horns, and a couchant griffin.²⁸ Floral and geometric motifs associated with the Aegean, such as running spirals, pinnate foliage, and blue palmate leaves predominate among the Qatna fresco fragments, as well as more unusual motifs including a crab and a series of turtles.²⁹ Tel Kabri is somewhat unusual in having preserved a frescoed floor with a grid pattern, alternating light and dark colored squares, containing variegated stone patterning and sprays of yellow crocuses and blue irises.³⁰ The irises, of a “V-type,” match types found on Late Minoan IA pottery and other Aegean arts.³¹ In addition to the floor painting, over 2,000 pieces belonging to an extremely fragmentary miniature frieze were excavated from a secondary context.³² These fragments appear to show scenes similar to the miniature frieze of the West House at Akrotiri on Thera, including town architecture of white and blue isodomic masonry and round timber beams, grasses, boats, swallows, and a possible griffin in flying

²³ See, for example, Colin Renfrew and Chris Scarre, eds., *Cognition and Material Culture: The Archaeology of Symbolic Storage* (Oxford: Oxbow Books, 1998).

²⁴ For the rest of this analysis, I concentrate on only the three Levantine cases, putting aside the Daba frescoes given the myriad problems of their context and chronology as well as their geo-cultural remove from the other three.

²⁵ Sturt W. Manning, Sarah J. Monks, Georgia Nakou, and Francis A. De Mita, Jr., “The Fatal Shore, the Long Years and the Geographical Unconscious: Considerations of Iconography, Chronology, and Trade in Response to Negbi’s “The ‘Libyan Landscape’ from Thera: A Review of Aegean Enterprises Overseas in the Late Minoan IA Period” (*JMA* 7.1),” *Journal of Mediterranean Archaeology* 7/2 (1994): 220.

²⁶ For a similar exercise, see Irene J. Winter, “Thera Paintings and the Ancient Near East: The Private and Public Domains of Wall Decoration,” in *Wall Paintings of Thera*, vol. 2, pp. 745–62.

²⁷ Sherratt, “Comment,” p. 238.

²⁸ Niemeier and Niemeier, “Aegean Frescoes in Syria-Palestine,” figs. 14–22.

²⁹ Mirko Novák and Peter Pfälzner, “Ausgrabungen in Tall Misrife-Qatna 2000: Vorbericht der deutschen Komponente des internationalen Kooperationsprojektes,” *Mitteilungen der Deutschen Orient-Gesellschaft* 133 (2001): fig. 16; Novák and Pfälzner, “Ausgrabungen in Tall Misrife-Qatna 2001,” figs. 13–16.

³⁰ Niemeier and Niemeier, “Frescoes in the Middle Bronze Age Palace,” pls. 9–18.

³¹ *Ibid.*, p. 259.

³² *Ibid.*, pls. 19–36.

gallop pose.³³ With the exception of the crab and turtles from Qatna, all the motifs found in the Levantine frescoes are also found in the Aegean repertoire, whether frescoes or other artistic production.³⁴ Moreover, the frescoes found in the Aegean themselves appear to belong to a long-standing and ongoing artistic tradition that crosses media, seen for example in vase painting, faïences, ivories, seals, and even the rare sculptural piece.³⁵

Assessing the “Levantine-ness” of the frescoes is a trickier proposition given the general difficulty in defining a coherent artistic tradition for the Middle Bronze Age Levant; however, material from Ebla and now Qatna, as well as broad assemblages of seals and ceramics, offer a starting place. Unlike in the Aegean, painted pottery is rare in the Levant. When it does occur, it is characterized by black, red, or bichrome geometric designs such as stripes, circles, triangles, or occasionally schematically rendered animals that are distinct from the fresco imagery (for example, Syro-Cilician Painted Ware, Ebla Common Painted Ware, Levantine Painted Ware, and Tell al-Yahudiyeh Ware).³⁶ Often associated with the Aegean, the later, so-called Nuzi Ware itself stands out from the rest of the local ceramic production, comprising only a small part of the total assemblage.³⁷ Seals also provide a useful body of evidence, and while there are several known seals that depict motifs related to the Aegean such as bull-leaping, like Nuzi Ware these form a very small percentage of the overall corpus.³⁸ By the Middle Bronze II period, seals “combine a delicately modeled style with a restraint and order in composition that evoke the term ‘classical’ ... with greater volume and stronger curved lines,”³⁹ contrasting strongly with the feel of immateriality produced by the frescoes. Larger sculpture, which is typically carved from basalt, follows closely the qualities displayed in the seals, arguing for the participation of both artistic types in a coherent Levantine tradition. Three-dimensional figural pieces intended for tomb or temple locations display solid, compact forms that convey mass and immobility.⁴⁰ Two-dimensional relief carvings, such as basins and a stele from Ebla, exhibit related formal properties, highlighting anthropomorphic figures set in balanced registers with an emphasis on clarity of design.⁴¹

In addition, we can consider architectural contexts. While painted frescoes appear in numerous building types within the Aegean sphere, in the Middle Bronze Age Levant and possibly at Tell ed-Daba, they appear restricted to palatial structures.⁴² For example, on Crete and in the Cyclades (such as Akrotiri on Thera and Ayia Irini on Kea), frescoes are used in several different forms of architecture, including palatial, residential, and possibly cultic structures, and at least on Crete they span a relatively extended chronological time frame.⁴³ In comparison with the Aegean, the frescoes from the Levant at Alalakh, Qatna, and Kabri occur in singular architectural structures—palaces—and appear to be restricted to a single chronological horizon within the Middle Bronze Age period, that of the Middle Bronze IIB (although the chronological aspects of the frescoes are extremely fraught with uncertainty).⁴⁴

³³ *Ibid.*, pp. 266–67.

³⁴ For Aegean frescoes, see Immerwahr, *Aegean Painting*; Lyvia Morgan, *The Miniature Wall Paintings of Thera: A Study in Aegean Culture and Iconography* (Cambridge: Cambridge University Press, 1988); Sherratt, *Wall Paintings of Thera*. We should, however, remember that in many instances our reconstructions of the highly fragmentary remains at Kabri and Alalakh are based on the more complete examples from the Aegean, so it may not be entirely surprising that they end up looking alike.

³⁵ For a well-illustrated, general overview of Aegean arts, see Sinclair Hood, *The Arts in Prehistoric Greece* (New Haven: Yale University Press, 1994) [first published 1978].

³⁶ Peter M. M. G. Akkermans and Glenn M. Schwartz, *The Archaeology of Syria: From Complex Hunter-Gatherers to Early Urban Societies (ca. 16,000–300 BC)* (Cambridge: Cambridge University Press, 2003), pp. 294, 320; Amihai Mazar, *Archaeology of the Land of the Bible, 10,000–586 B.C.E.* (New York: Doubleday, 1992), pp. 182–84, 214–17.

³⁷ Akkermans and Schwartz, *Archaeology of Syria*, pp. 331–33.

³⁸ For general studies on Middle Bronze Age Levantine seals, see Dominique Collon, *First Impressions: Cylinder Seals in the Ancient Near East* (Chicago: University of Chicago Press, 1987), pp. 52–55; Edith Porada, “Syrian Seals from the Late Fourth to the Late Second Millennium,” in *Ebla to Damascus: Art and Archaeology of Ancient Syria*, edited by Harvey Weiss (Washington, D.C.: Smithsonian Institution Press, 1985), pp. 94–99; Beatrice Teissier, *Egyptian Iconography on Syro-Palestinian Cylinder Seals of the Middle Bronze Age*, *Orbis Biblicus et Orientalis, Series Archaeologica* 11 (Freibourg:

University Press and Göttingen: Vandenhoeck & Ruprecht, 1996). For examples of bull-leaping seals, see Joan Aruz, “Imagery and Interconnections,” *Ägypten und Levante / Egypt and the Levant* 5 (1995): 33–48; Dominique Collon, “Bull-leaping in Syria,” *Ägypten und Levante / Egypt and the Levant* 4 (1994): 81–85.

³⁹ Joan Aruz, “Ancient Syria: Centers of International Exchange,” in *Ancient Art in Miniature: Near Eastern Seals from the Collection of Martin and Sarah Cherkasky*, edited by Holly Pittman (New York: Metropolitan Museum of Art, 1987), pp. 37–38.

⁴⁰ For sculpture from Alalakh, see Woolley, *Alalakh*, pls. 40–43. For sculpture from Ebla, see Paolo Matthiae, “Ebla and Syria in the Middle Bronze Age,” in *The Hyksos: New Historical and Archaeological Perspectives*, edited by Eliezer D. Oren (Philadelphia: University Museum, 1997), figs. 14.18–14.20. For sculpture from Qatna, see Mirko Novák and Peter Pfälzner, “Ausgrabungen im bronzzeitlichen Palast von Tall Misrife-Qatna 2002: Vorbericht der deutschen Komponente des internationalen Kooperationsprojektes,” *Mitteilungen der Deutschen Orient-Gesellschaft* 135 (2003): figs. 17–20.

⁴¹ Matthiae, “Ebla and Syria,” figs. 14.21–14.24.

⁴² Winter, “Thera Paintings and the Ancient Near East,” pp. 747–49.

⁴³ For an overview of locations of frescoes on Crete and in the Cyclades, see Immerwahr, *Aegean Painting*, pp. 1–5, figs. 14, 15, 24.

⁴⁴ Woolley, however, published frescoed plaster fragments from a house in the Late Bronze Age level IV (*Alalakh*, p. 228, pl. 39). It should also be noted that archaeology of settlements in the Near East has tended to concentrate primarily on palatial and temple structures, perhaps skewing the apparent distribution data.

A final area in which difference might be assessed is the visual appearance that resulted from using the fresco technique itself, which would probably have been conspicuous to ancient audiences accustomed to wall painting done in the tempera manner, such as those at Mari. Because pigments in the fresco technique lack a binding agent and, to some extent, permeate the damp plaster, they can appear less saturated, and the need to work quickly while the plaster is damp may impart a looseness to the painting. In contrast, the tempera technique relies on additives that allow the pigment to adhere to the surface of the plaster, producing opaque, vivid colors that are often contained within heavy dark outlines.⁴⁵ Comparing the “Aegean-style” frescoes with tempera paintings such as those at Mari brings out this visual contrast.⁴⁶ Indeed, the technology of fresco painting, discernible to the naked eye even once the painting process was complete, most likely promoted as rich a significance as the imagery itself, serving as an index of access to and control of specialized technical knowledge.⁴⁷

CONCLUSIONS

Although cautious archaeologists may warn that the only way to get into the head of ancient people is with a pick (or spade or trowel), it is possible to attempt assessments of ancient reception based on webs of material assemblages. Because human beings know and make sense of the world around them through experience of physical forms, reconstructing holistic material culture settings can allow us access into realms of knowledge. Frescoes, while probably imbued with special meaning even in the Aegean, appear comfortably situated within an Aegean artistic and cultural tradition. In contrast, the frescoes found in the Levant, in both technique and imagery, strike a sharp chord of difference with their surrounding material culture assemblage. It seems then that we might profitably pursue the suggestion that, for the Levantines, these frescoes represented exotica from distant lands. Their placement in palatial structures further supports the conclusion that their exotic qualities were known and actively deployed by the local elites, who sought to accentuate this difference and so showcased their own exclusive knowledge.

⁴⁵ Immerwahr, *Aegean Painting*, p. 14.

⁴⁶ In addition, there may be actual differences in pigments used, which would also produce a visual effect; see, for example, on the question of blue pigment, Ann Brysbaert and Peter Vandenabeele, “Bronze Age Painted Plaster in Mycenaean Greece: A Pilot Study on the Testing and Application of Micro-Raman Spectroscopy,” *Journal of Raman Spectroscopy* 35 (2004): 686–93.

⁴⁷ See, for example, some recent anthropological scholarship that approaches technological choices as culturally motivated and socially and politically significant: Marcia-Anne Dobres and Christopher R. Hoffman, eds., *The Social Dynamics of Technology: Practice, Politics, and World Views* (Washington, D.C.: Smithsonian Institution Press, 1999); Pierre Lemonnier, ed., *Technological Choices: Transformation in Material Cultures Since the Neolithic* (London: Routledge, 1993).

AUSTIN'S ASIATIC ANTIQUITIES: THE FIRST CUNEIFORM INSCRIPTIONS PUBLISHED IN AMERICA *

Steven W. Holloway, American Theological Library Association, Chicago

1. THE TOPICALITY OF BABYLON IN ANTEBELLUM AMERICA

The Bible, America's iconic book, delivered a nearly inexhaustible fount of images for social, moral, and political mirroring into the hands of the reform minded.¹ The adversaries of the Israelites proved especially adaptable for constructing contemporary allegories serviceable for nation building; both Egypt and the Bible kingdom of perfidious Babylon assumed unusual prominence in the early American cultural history, often borrowing initial inspiration from the Old World. For example, political cartoons in England caricatured Napoleon's propagandistic efforts to pass himself off as a latter-day Cyrus. For instance, in *The Hand-Writing on the Wall* (1803), the British cartoonist James Gillray scurrilously portrayed Napoleon as Belshazzar, feasting in captive London on the spoils of conquest, surprised by the unbidden hand of God.² While in London following the War of 1812, the youthful American painter Washington Allston produced a series of preliminary studies for *Belshazzar's Feast*, the most celebrated American painting of its age. A veritable sermon in paint, the symbolism in Allston's *Belshazzar's Feast* extends beyond an immediate allegory of the fall of Napoleon to encompass French materialism and radical politics. Given Allston's passionate identification with the ideals of the New England clerisy, the elite merchant class, and intelligentsia of Boston with their staunch Federalist leanings, it is possible that behind the figure of Belshazzar lurks Thomas Jefferson, with his perceived threat to the American Republic through sympathies with godless French Revolutionary thought, or, worse, Andrew Jackson, the populist democrat who was unmoved by New England claims to natural supremacy.³ Early evangelical American Protestants put Babylon through her paces in highly topical sermons, political diatribes, and the visual arts, thus whetting an appetite for the "real thing," for artifacts and first-hand travel stories.

* I am grateful to the National Endowment for the Humanities for a 2004 Summer Stipend award that materially facilitated research for this essay.

¹ Sacvan Bercovitch, *The Puritan Origins of the American Self* (New Haven: Yale University Press, 1975); Bercovitch, "The Biblical Basis of the American Myth," in *The Bible and American Arts and Letters*, edited by Giles Gunn, 3rd ed., The Bible in American Culture 3 (Philadelphia: Fortress Press; Chico, California: Scholars Press, 1983), pp. 219–29; John D. Davis, "Holy Land, Holy People? Photography, Semitic Wannabes, and Chautauqua's Palestine Park," *Prospects* 17 (1992): 241–71; Davis, *The Landscape of Belief: Encountering the Holy Land in Nineteenth-Century American Art and Culture*, The Princeton Series in Nineteenth-Century Art, Culture, and Society (Princeton: Princeton University Press, 1996); Conrad Cherry, *God's New Israel: Religious Interpretations of American Destiny*, rev. and updated ed. (Chapel Hill: University of North Carolina Press, 1998); Paul G. Gutjahr, *An American Bible: A History of the Good Book in the United States, 1777–1880* (Stanford: Stanford University Press, 1999); Burke O. Long, *Imagining the Holy Land: Maps, Models, and Fantasy Travels* (Bloomington: Indiana University Press, 2003); Andrew Chamberlin Rieser, *The Chautauqua Moment: Protestants, Progressives, and the Culture of Modern Liberalism* (New York: Columbia University Press, 2003); David Daniell, *The Bible in English: Its History and Influence* (New Haven and London: Yale University Press, 2003), pp. 580–603, 624–58, 701–33.

² David Bjelajac, *Millennial Desire and the Apocalyptic Vision of Washington Allston*, New Directions in American Art (Washington,

D.C.: Smithsonian Institution Press, 1988), fig. 26. Other Continental caricaturists quickly followed Gillray's lead; see Alexander Meyrick Broadley and J. Holland Rose, *Napoleon in Caricature 1795–1821* (London and New York: John Lane Co., 1911).

³ A long history of American fascination with the theme of Belshazzar's Feast can be documented, beginning perhaps with the poetry of Anne Bradstreet (1612–1672). Renditions of Belshazzar's Feast by Old Masters figured in many illustrated Bibles until John Martin's immensely popular painting by that title swept the field in 1820. The first American to produce an oil painting of *Daniel Interpreting to Belshazzar the Handwriting on the Wall* (1775), Benjamin West, exhibited it at the Royal Academy in London the following year, probably intended as a veiled reference to the American Revolution. West's painting circulated widely through engraved reproductions by Valentine Greene and Alexander Anderson. The Connecticut portrait painter Joseph Steward (1755–1822) painted a picture with the same title as West's for the Hartford Museum. John Martin's lurid *Belshazzar's Feast* became extremely popular in America during the 1820s, reproduced countless times in individual mezzotints, illustrated Bibles, and paint copies. The American historical painter Thomas Cole (1801–1848) painted a Belshazzar's Feast early in his career. The theme of Belshazzar's Feast figured in many American sermons during the War of 1812 and the Napoleonic wars. See Bjelajac, *Millennial Desire*, pp. 33–45, 127–34, pls. i, vii, and viii (Allston's *Belshazzar's Feast*) and pl. v (West, *Daniel Interpreting to Belshazzar the Handwriting on the Wall*).

2. CAPTAIN HENRY AUSTIN AND HIS BRICKS

The story of how the first cuneiform bricks reached America is something of an epic. A merchant captain, one Henry Austin, resident of either Boston or New York,⁴ made two trips to the Persian Gulf in search of commercial opportunities, the last in 1816. From his own journal we learn that Austin voyaged up the Euphrates in a small vessel towed by twenty “trackers,” with a complement of four seamen, twelve Sepoys, “a native for a cook, and a Persee for a servant” — and a mounted howitzer. He tried to cross over to the Tigris through the miles of mudflats, but could not manage it due to the draught of the boat and the low water level of the summer season. Once he procured canoes and sent his boat back to Basra, he and his suite reached “Coot” on the Tigris after four days, where he procured four “miserable” horses and journeyed for four more days to Baghdad, sharing the quarters of the “sheep-feeders” along the way.⁵ Austin, associating the biblical Tower of Babel with the cuneiform-inscribed bricks that abounded in southern Mesopotamia, and possessed of the self-same civic-mindedness that inspired other American seafaring merchants to gift the Salem East India Marine Society with Egyptian artifacts as early as 1803,⁶ gathered bricks from various locales and brought them home. A “gentleman” who traveled with Austin on this voyage relates that one inscribed brick was procured from an undisclosed site in Babylon, one from the Tower of Babel itself, probably Birs Nimrūd, one from Ctesiphon, and a fourth from the Tomb of Zobeida, also in Baghdad.⁷ The Persian authorities granted the worthy captain leave to travel “many miles” in the desert to the Tomb of Daniel, where he obtained an inscribed brick, presumably at Pīrs Dāniyāl, the Mosque of the Tomb of Daniel in Sūs, ancient Susa.⁸ Austin himself wrote that specimens will be presented to the Boston Athenaeum, the New York Literary and Philosophical Society, and Yale College, and that others will be sent to Washington.

The bricks displayed in New York City produced a minor sensation in the winter of 1817.⁹ We learn that a Dr. Mitchill (fig. 1) presented one of the bricks to the Literary and Philosophical Society of New York. “Many are the witnesses of the impressions made in the cement by the straw which was mingled with it; and of the black hue and pungent smell of the bitumen, which is a component of the mortar.” The inscriptions were copied by a C. H. Smith, an “able antiquarian.” Engravings of the text were made by Alexander Anderson, “in his best manner,” and were promised to be distributed to the literati in the United States and elsewhere.¹⁰ The inscriptions were pronounced to have no analogy to Persian or Sanskrit by “our learned Orientalist” Baron L’Escallier, undoubtedly Daniel Lescallier (1743–1822), French consul-general to the United States in 1811 and Persian translator.¹¹

The Dr. Mitchill responsible for donating the Austin bricks to the Literary and Philosophical Society of New York played a key role in early American arts, sciences, and politics. Samuel Latham Mitchill, the “Nestor of American science,” a practicing physician, was also professor of natural history, agriculture, and chemistry at Columbia College of New York. Mitchill belonged to most of the major learned societies in antebellum America, including the American Antiquarian Society, in whose initial volume of transactions he published erudite letters deal-

⁴ A portrait of Captain Austin was painted by Ethan Allen Greenwood of Boston in 1815; see *Proceedings of the American Antiquarian Society* 56 (1946): 144.

⁵ Henry Austin, “An Extract from a Letter of One of our Countrymen to a Gentleman in Boston, Containing Brief Notices of an Excursion Upon the Euphrates and the Tigris, Dated January 1817,” *Boston Intelligencer, and Morning and Evening Advertiser* no. 25, February 1, 1817, 2 col. pp. 1–2; Anon., “Ancient Persian Bricks,” *North American Review and Miscellaneous Journal* 4 no. 12 (1817): 328 ff.; Anon., “Ruins of Babylon,” *Niles’ Weekly Register* 11 (1817): 333; Anon., “Austin’s Asiatic Antiquities,” *Boston Intelligencer, and Morning and Evening Advertiser* no. 24, January 25, 1817, 2 col. p. 3, originally published in the *New-York Mercantile Advertiser*.

⁶ Bruce G. Trigger, “Egyptology, Ancient Egypt, and the American Imagination,” in *The American Discovery of Ancient Egypt*, edited by Nancy Thomas (Los Angeles and New York: Los Angeles County Museum of Art, 1995), p. 21.

⁷ Anon., “Ancient Relics,” *Boston Intelligencer, and Morning and Evening Advertiser* no. 23, January 18, 1817, 2 col. p. 3, originally published in the *Connecticut Herald*.

⁸ Samuel L. Mitchill, “Ruins of Babylon,” *The National Register, A Weekly Paper* 3 no. 5 (1817): 31; M. Streck, “al-Sūs,” in Brill’s *Encyclopedia of Islam Online* (<http://www.encyislam.brill.nl/start2.asp>, accessed June 11, 2005).

⁹ Anon., “Austin’s Asiatic Antiquities,” 2 col. p. 3.

¹⁰ A reproduction of this engraving may be seen in William B. Dinsmoor, “Early American Studies of Mediterranean Archaeology,” *Proceedings of the American Philosophical Society* 87 no. 1 (1943), fig. 2, facing p. 74. I am indebted to Benjamin R. Foster for this reference.

¹¹ Anon., “Austin’s Asiatic Antiquities,” *The National Register, A Weekly Paper* 3 no. 5 (1817): 79, originally published in the *New-York Mercantile Advertiser*. Henry Meigs, Esq., working with a Chinese dictionary, determined that “the inscription upon the brick from the tomb of Daniel the Prophet, seems to be an eulogy on that great man, for the wisdom of his administration under Nebuchadnezzar, Darius, and Cyrus, in teaching the people to irrigate their lands with the water of the rivers, and thereby enabling them to procure an abundance of rice for food.”



Sam L. Mitchill

Figure 1. Dr. Samuel Latham Mitchill (1764–1831), the “Nestor of American science.” *Appleton’s Cyclopaedia of American Biography* (1888), vol. 4, p. 348.



Alex^r Anderson

Figure 2. Alexander Anderson (1775–1870), engraver. *Appleton’s Cyclopaedia of American Biography* (1888), vol. 1, p. 68.

ing with Native American antiquities and origins.¹² He published many technical studies on botany, zoology, and medicine and received numerous awards and commendations from foreign academic societies. He served New York as a member of the House of Representatives beginning with the seventh Congress of the United States in 1800.¹³

Alexander Anderson, a gifted and industrious artisan of New York City, took a medical degree in 1794 but gave up practice to become a full-time illustrator (fig. 2). Our Dr. Mitchill supervised Anderson’s medical dissertation at Columbia College and commissioned a portrait engraving from his young student. Anderson illustrated many Bibles in the first half of the nineteenth century, worked for the American Tract Society, and had a hand in illustrating over two thousand publications.¹⁴

¹² Samuel L. Mitchill, “Communications from Dr. Samuel Mitchill, LL.D. &c.: Specimens of the Poetry and Singing of the Osages; Description of the Mummy Found in Kentucky; On the Resemblance between the Original Inhabitants of America, and the Malays of Australasia, and the Tartars of the North; The Original Inhabitants of America Shewn to be of the Same Family and Lineage with Those of Asia; Answer to Remarks on ditto; On the Migration of Malays, Tartars and Scandinavians to America; Further Conjectures Respecting the Origin and Antiquities of the Aborigines of America,” *Archaeologia Americana: Transactions and Collections of the American Antiquarian Society* 1 (1820): 313–32, 38–55.

¹³ “Mitchill, Samuel Latham,” in *The National Cyclopaedia of American Biography* (Clifton: J. T. White, 1897), vol. 4, p. 409; “Mitchill, Samuel Latham,” in *Lamb’s Biographical Dictionary of the United States*, edited by John Howard Brown (Boston: James H. Lamb Company, 1903), vol. 5, pp. 511–12.

¹⁴ On the life and creations of Dr. Alexander Anderson, see Benson J. Lossing, “Engravings by Dr. Alexander Anderson, with

a Biographical Sketch of the Artist,” *The Art Journal* (September 1858): 271–72; idem, *A Memorial of Alexander Anderson, M.D., the First Engraver on Wood in America: Read before the New York Historical Society, Oct. 5, 1870* (New York: New York Historical Society, 1872); Evert A. Duyckinck, *A Brief Catalogue of Books Illustrated with Engravings by Dr. Alexander Anderson: With a Biographical Sketch of the Artist* (New York: Thompson & Moreau, 1885); Frederic Martin Burr, *Life and Works of Alexander Anderson, M.D., the First American Wood Engraver* (New York: Burr Brothers, 1893); Jane R. Pomeroy, *Alexander Anderson’s Life and Engravings: With a Checklist of Publications Drawn from His Diary* (Worcester: American Antiquarian Society, 1990). Anderson frequently did not sign his work, a fact that leaves open the possibility that he engraved the Tower of Babel plate (see below). As a resident of New York City for ninety years, a well-known and respected figure in the cultural affairs of the antebellum metropolis, and one of the most sought-after engravers in America, it is not surprising that he played a key role in the exhibition of such fascinating “Bible antiquities.”

The original Anderson woodcut commissioned by Dr. Mitchill circulated widely but, to my knowledge, was first published in the *Proceedings of the American Philosophical Society* of 1943 (fig. 3). Efforts to locate the Austin bricks themselves have proven to be in vain. The New York Historical Society, Yale University, the New York Public Library, and the Smithsonian have no records of having ever owned such objects. Only the Boston Athenaeum is possessed of an institutional memory sufficiently tenacious to corroborate the prior possession of an Austin brick.¹⁵ The inscription in the lower illustration is identical to thousands of bricks bearing the stamp of Nebuchadnezzar II. The damaged inscription at the top, however, is a remarkably accurate copy of a brick of the Middle Elamite king Kutir-Nahunte II (fig. 4).¹⁶



Figure 3. Woodcut of Captain Austin's inscribed bricks, engraved by Alexander Anderson in 1817. The original document is located in the American Philosophical Society Library in Philadelphia, APS Pamphlets vol. 453, no. 2. Published with permission of the American Philosophical Society.

¹⁵ E-mail communication from Hina Hirayama, Associate Curator of Paintings and Sculpture, The Boston Athenaeum, February 28, 2005.

¹⁶ For a transliteration of this text, see Steven W. Holloway, "A 'New' Kutir-Nahunte II Text," *NABU* 2004/104.



Figure 4. Enhanced detail of Anderson's woodcut, a Middle-Elamite inscription of Kutir-Nahhunte II, probably found at the site of ancient Susa.

3. "ANCIENT PERSIAN BRICKS"

Stop-press publications of the Austin cuneiform bricks grant us an uncommonly discriminating instrument for assessing ancient Near Eastern scholarship in the early United States, the technical literature available on the East coast, and the sophistication with which the academic theories were exploited. In the March 1817 issue of *The North American Review and Miscellaneous Journal*, an anonymous essay entitled "Ancient Persian Bricks" attempts to describe the latest and best opinions available on cuneiform inscriptions from Babylon and construction techniques of Mesopotamian temple-towers. The author begins by reprinting, with editorial asides, an article by Joseph Hager (1756–1819), "General Observations on the Persepolitan Characters, with a Description and Representation of Some Bricks Lately Sent to Europe, from the Site of Ancient Babylon," published in 1801.¹⁷ The London article is a condensation of a short monograph, *A Dissertation on the Newly Discovered Babylonian Inscriptions*,¹⁸ undoubtedly the most sophisticated inquiry into the ancient Babylonian and Assyrian language in its day: our American author made an auspicious selection. The anonymous American author, following Hager, describes the forms of the Persepolis cuneiform inscriptions, citing the British Orientalist Sir William Jones (1746–1794), and the debates roiling around the identification of ancient Persepolis, rehearsing the arguments of Oluf Gerhard Tychsen of Rostock (1734–1815)¹⁹ and others.

The rationale for Hager's essay is the twelve inscribed bricks that arrived in London, 1801, sent from Baghdad to the East India Company. I reproduce the accompanying composite hand copy by Hager, which was available and known to the American writer of "Ancient Persian Bricks" (fig. 5). Hager then canvasses the theories of the direction in which the cuneiform was read, whether left to right like Sanskrit or another language of India and Europe, right to left like Hebrew and Arabic, top to bottom, like Chinese, Mongolian, and Japanese, or bottom to top, like the hieroglyphs of the ancient Mexicans, citing José de Acosta (1540–1600), Carsten Niebuhr (1733–1815), Tychsen, Rudolf Erich Raspe (1737–1794),²⁰ and Samuel Friedrich Günter Wahl (1760–1834).²¹ Are the "nail-headed charac-

¹⁷ Joseph Hager, "General Observations on the Persepolitan Characters, with a Description and Representation of Some Bricks Lately Sent to Europe, from the Site of Ancient Babylon," *The Monthly Magazine; or, British Register* 12 (1801): 2–6.

¹⁸ Joseph Hager, *A Dissertation on the Newly Discovered Babylonian Inscriptions* (London: Wilks & Taylor Printers for A. Tilloch, 1801).

¹⁹ Tychsen, a German Protestant who studied Talmud under the noted Rabbi Jonathan Eibenschütz and Tamil, Ethiopic, and Arabic at Halle, taught Hebrew and Oriental languages at Bützow and Rostock. He published a treatise in 1798 entitled *De cuneatis inscriptionibus Persepolitianis*. Tychsen had the distinction of being the first to notice the presence of word-dividers in the Persepolis inscriptions. Ernest Grégoire, *Nouvelle biographie générale depuis les temps les plus reculés jusqu'à 1850–60* (Paris: Firmin Didot Frères, 1866), vol. 45, pp. 755–57; Robert William Rogers, *A History of Babylonia and*

Assyria (New York: Eaton Mains and Cincinnati: Jennings & Pye, 1900), vol. 1, 38–39; *Deutsche biographische Enzyklopädie* (Munich: K. G. Saur, 1998), vol. 10, p. 120.

²⁰ Raspe studied natural history and philology at Göttingen and Leipzig and was librarian at Hanover before emigrating to England, where he is best known as the author of the Baron Münchhausen stories. *Deutsche biographische Enzyklopädie*, vol. 8, p. 146.

²¹ Samuel Friedrich Günter Wahl, *Allgemeine Geschichte der morgenländischen Sprachen und Litteratur: Worinnen von Sprache und Litteratur der Armenier, der Egypter und Kopten, der Araber, der Phönicier und Ebräer, der Aethiopier, Syrer, Samaritaner, und Chaldäer, auch der Sineser, der ostindischen Völker, vorzüglich aber der Perser systematisch und ausführlich gehandelt wird: Nebst einem Anhang zur morgenländischen Schriftgeschichte* (Leipzig: Breitkopf, 1784).

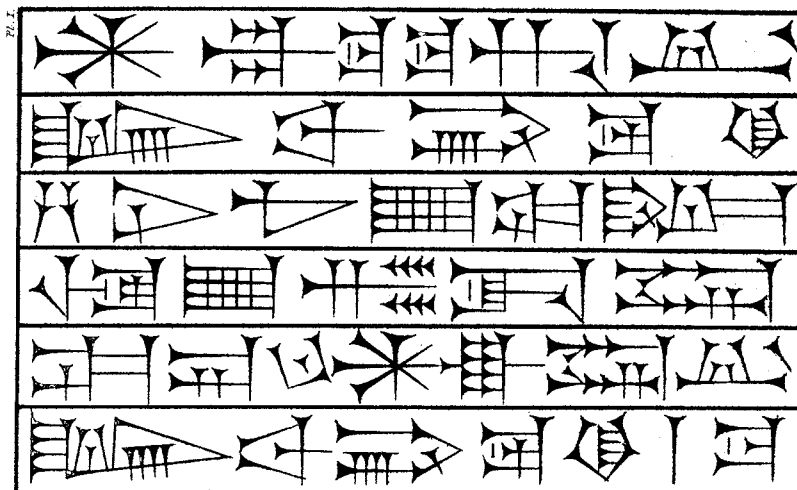

Figure 5. Composite drawing by Joseph Hager of Nebuchadnezzar II bricks in East India House, London. From Hager, *Dissertation on the Newly Discovered Babylonian Inscriptions*, pl. 1, facing p. 36.

ters” alphabetic like the languages of Europe, syllabic like Devanagari, “hieroglyphical” like Egyptian, or capable of expressing complete ideas by arbitrary signs like Chinese and other languages of Southeast Asia? In this connection our author engages Edward Hyde, the first Earl of Clarendon (1609–1674),²² Samuel Simon Witte (1738–1802), Niebuhr, and Tychsen. A comparison with Irish runes is dismissed by Sir William Jones due to the paucity of discrete characters in the runic system.

A reply to Hager’s essay in the London *Monthly Magazine* of 1802 observes that a Father Emanuel de St. Albert, a contemporary of Pietro della Valle (1586–1652), was actually the first European to notice in writing the existence of cuneiform inscriptions on Babylonian bricks, citing the French savant Jean Baptiste Bourguignon d’Anville (1697–1782)²³ and Gassendi’s *Life of Peiresc*, translated into English in 1657.²⁴

The intrepid author of “Ancient Persian Bricks” then draws on Sir John Malcolm’s *The History of Persia, from the Most Early Period to the Present Time*, published by John Murray in 1815, in his disquisition on Babylonian bricks.²⁵ His last major source is the authoritative 1800 survey by Major John Rennell *The Geographical System of Herodotus, Examined and Explained, by a Comparison with those of other Ancient Authors, and with Modern Geography*, whose chapter on the provenience, composition, and metrology of the inscribed bricks of Babylon he cites verbatim for deadly long pages, replete with Rennell’s footnotes and source citations.²⁶ The valuable work of Major Rennell, the American author is happy to relate, “may be found in the Boston Athenaeum [*sic*].”

“The Boston Athenaeum, one of the oldest independent libraries in the United States, was founded in 1807.”²⁷ A search of the Athenaeum online catalogue reveals that all the monographs and periodical works cited in 1817 in “Ancient Persian Bricks” are today part of the collection. Our pedantic author regrets that he cannot lay hands on

²² On the career of the extraordinary Edward Hyde, see Paul Seaward, “Hyde, Edward, First Earl of Clarendon (1609–1674),” in *Oxford Dictionary of National Biography* (Oxford: Oxford University Press, 2004); online edition, May 2005 (<http://www.oxforddnb.com/view/article/14328>, accessed September 29, 2005).

²³ D’Anville, who was thoroughly versed in the Greco-Roman classics, published numerous maps and geographical studies of antiquity. Rossel, (*Michaud*) *Biographie universelle ancienne et moderne* (Paris: Ch. Delagrave, 1870–1873), vol. 2, pp. 97–98.

²⁴ Pierre Gassendi, William Rand, and Richard Gaywood, *The mirror of true nobility & gentility, Being the life of the renowned Nicolaus Claudius Fabricius Lord of Pieresk* (London: J. Streater for Humphrey Moseley, 1657).

²⁵ John Malcolm, *The History of Persia, from the Most Early Period to the Present Time: Containing an Account of the Religion, Government, Usages, and Character of the Inhabitants of that Kingdom* (London: John Murray, 1815). Sir John Malcolm (1769–1833), soldier, diplomat, and administrator in India, was the first Englishman to be appointed envoy to Persia since the time of Elizabeth I; see Robert

Eric Frykenberg, “Malcolm, Sir John (1769–1833),” in *Oxford Dictionary of National Biography*; online edition, May 2005 (<http://www.oxforddnb.com/view/article/17864>, accessed September 29, 2005).

²⁶ James Rennell, *The Geographical System of Herodotus, Examined and Explained, by a Comparison with those of other Ancient Authors, and with Modern Geography. In the Course of the Work are Introduced, Dissertations on the Itinerary State of the Greeks, ... The Whole Explained by Eleven Maps, Adapted to the Different Subjects; and Accompanied with a Complete Index* (London: printed by W. Bulmer and Co. for the author, and sold by G. and W. Nicol, 1800), pp. 335–88.

²⁷ <http://www.bostonathenaeum.org/general.html#intro>, first paragraph (accessed September 19, 2004). On the history of the Boston Athenaeum, see Mabel Munson Swan, *The Athenaeum Gallery, 1827–1873: The Boston Athenaeum as an Early Patron of Art* (Boston: The Boston Athenaeum, 1940); Josiah Quincy, *The History of the Boston Athenaeum, with Biographical Notices of its Deceased Founders* (Cambridge: Metcalf and Company, 1851).

Claudius James Rich's *First Memoir on the Ruins of Babylon*, published the year before, but a book review²⁸ "confirms what is said in general on the subject of the arrow-headed characters in the foregoing pages; and shews, that the subject is not new to the oriental scholars of Europe." In fine, American savants accurately rehearsed but added nothing original to the great cuneiform debates. An American entrepreneur, however, promptly hustled the matter out of the ivory tower into the family parlor.

4. CUNEIFORM IN BIBLES AT BRATTLEBORO?

The epic continues. John Holbrook (1761–1838), a shrewd businessman with no prior experience in the publishing field, assumed proprietorship in 1815 of a newspaper and printing firm in Brattleboro, Vermont. The following year he issued a well-received family Bible with illustrated plates by, among others, Alexander Anderson of New York City. Sandwiched in between Genesis 12:5 and 6 is an engraving of the Tower of Babel, a classicizing circular tower with rounded arches, monumental staircases, and minuscule staffage figures²⁹ (fig. 6). In truth, the Brattleboro engraving closely reproduces a widely circulated copperplate from a seventeenth-century study of the Tower of Babel by Athanasius Kircher (1602–1680), the first European to exhibit one of Pietro della Valle's cuneiform bricks in his *Wunderkammer* in Rome (fig. 7).³⁰ The Vermont Bible woodcut simplified the Kircher-Turris foreground and background but faithfully preserved the details of the Tower itself.³¹

In 1818, two years later, a new-and-improved edition of the Brattleboro family Bible appeared, with the same plate but with a striking alteration: hand copies of two cuneiform texts now flank the Tower (fig. 8). The neat cursive legends reproduce the data from the original Anderson woodcut of Austin's bricks.³² The enhanced Tower of Babel plate would be reproduced in the 1819 edition of the Brattleboro Bible and also appears as an adornment in the article on the Tower of Babel printed by Holbrook in an 1824 Bible commentary.³³

²⁸ Anon., "Extracts from C. J. Rich, *Memoir on the Ruins of Babylon*," *North American Review and Miscellaneous Journal* 2 no. 5 (1815): 183 ff.

²⁹ *The Holy Bible: Containing the Old & New Testaments: Together with the Apocrypha: Translated out of the Original Tongues, and with the Former Translations Diligently Compared and Revised. With Marginal Notes and References. Together with the Apocrypha. To which are Added an Index: An Alphabetical Table of all the Names in the Old and New Testaments, with their Significations; and, What has Never Before been Added, an Account of the Lives and Martyrdom of the Apostles and Evangelists* (Brattleboro: J. Holbrook's Stereotype Copy, 1816).

³⁰ For the remarkable figure of Athanasius Kircher, see Joscelyn Godwin, *Athanasius Kircher: A Renaissance Man and the Quest for Lost Knowledge* (London: Thames and Hudson, 1979), and Ingrid D. Rowland, *The Ecstatic Journey: Athanasius Kircher in Baroque Rome* (Chicago: Department of Special Collections, University of Chicago Library, 2000).

³¹ Athanasius Kircher, *Turris Babel, sive Archontologia qua primo priscorum post diluvium hominum vita, mores rerumque gestarum magnitudo, secundo Turris fabrica civitatumque extractio, confusio linguarum* (Amsterdam: Ex officina Janssonio-Waesbergiana, 1679), p. 38.

³² The legend (bottom of page) reads "Tower of Babel. — or Nimrods Tower — 102 years after the flood — 3 years preparing and 12 years in building. Contained 8 Towers one above another, and each 75 feet high. (*Hist.*) Genesis Ch. XI. Supposed to be converted into an Idolatrous Temple BELUS in BABYLON and enlarged by Nebuchadnezer out of the spoils of the Temple at Jerusalem Dan. c I v II and Chron XXXIV v VII On its summit was an Observatory and golden Image forty feet high in value abt 15,575,000 dolls. Herodotus, Bochart, Strabo and other Histo.^s Gen.^s XI Isaiahs predictions completely fulfil'd. c. XIII." Left: "Copy of the Inscription on a Fragment of Brick taken from the Mosque at the Tomb of Daniel the

Prophet situated in the Desert forty miles NW of Basra." Below the bricks: "Antiquities from Asia brought to New York in Jan. 1817 by Capt. Henry Austin and now at D. Mitchells." Right: "Copy of the Characters distinguishable on the Bricks nearly thirteen inches square and three inches thick from the ruins of ancient Babylon." *The Holy Bible: Containing the Old & New Testaments* (1818). I am indebted to Christine Wenderoth, Director of the Jesuit-Krauss-McCormick Library in Chicago for permission to photograph and reproduce the plate, and Emilie Pulver, Cataloguer and Special Projects Librarian, for actually disinterring the volume.

³³ John Brown, *A Dictionary of the Holy Bible: Containing an Historical Account of the Persons; a Geographical and Historical Account of the Places; a Literal, Critical, and Systematical Description of Other Objects, Whether Natural, Artificial, Civil, Religious, or Military. With an Explication of the Appellative Terms Mentioned in the Writings of the Old And New Testaments. The Whole Comprising Whatever Important is Known Concerning the Antiquities of the Hebrew Nation and Church of God—Forming a Sacred Commentary, a Body of Scripture History, Chronology, and Divinity. To Which is Annexed, the Life of the Author. Embellished with Plates* (Boston: Joseph Teal, 1824), facing page 88. Apparently no further editions of this Bible dictionary were issued. John Holbrook and Holbrook & Fessenden of Brattleboro continued to publish family Bibles through 1835. I have not examined any Brattleboro Bibles published later than 1819 to ascertain whether they continue to sport the Tower of Babel plate embellished with cuneiform inscriptions. For information on the Brattleboro editions, albeit incomplete, see Margaret Thorndike Hills, *The English Bible in America: A Bibliography of Editions of the Bible and the New Testament Published in America, 1777–1957* (New York: American Bible Society, 1961), nos. 293, 327, 346, 372, 396, 415, 465, 490, 523, 530, 533, 586, 613, 629, 741, 894. For the history of the Fessenden-Holbrook publishing enterprise, see Gutjahr, *American Bible*, p. 60, and Daniell, *Bible in English*, pp. 654–55.

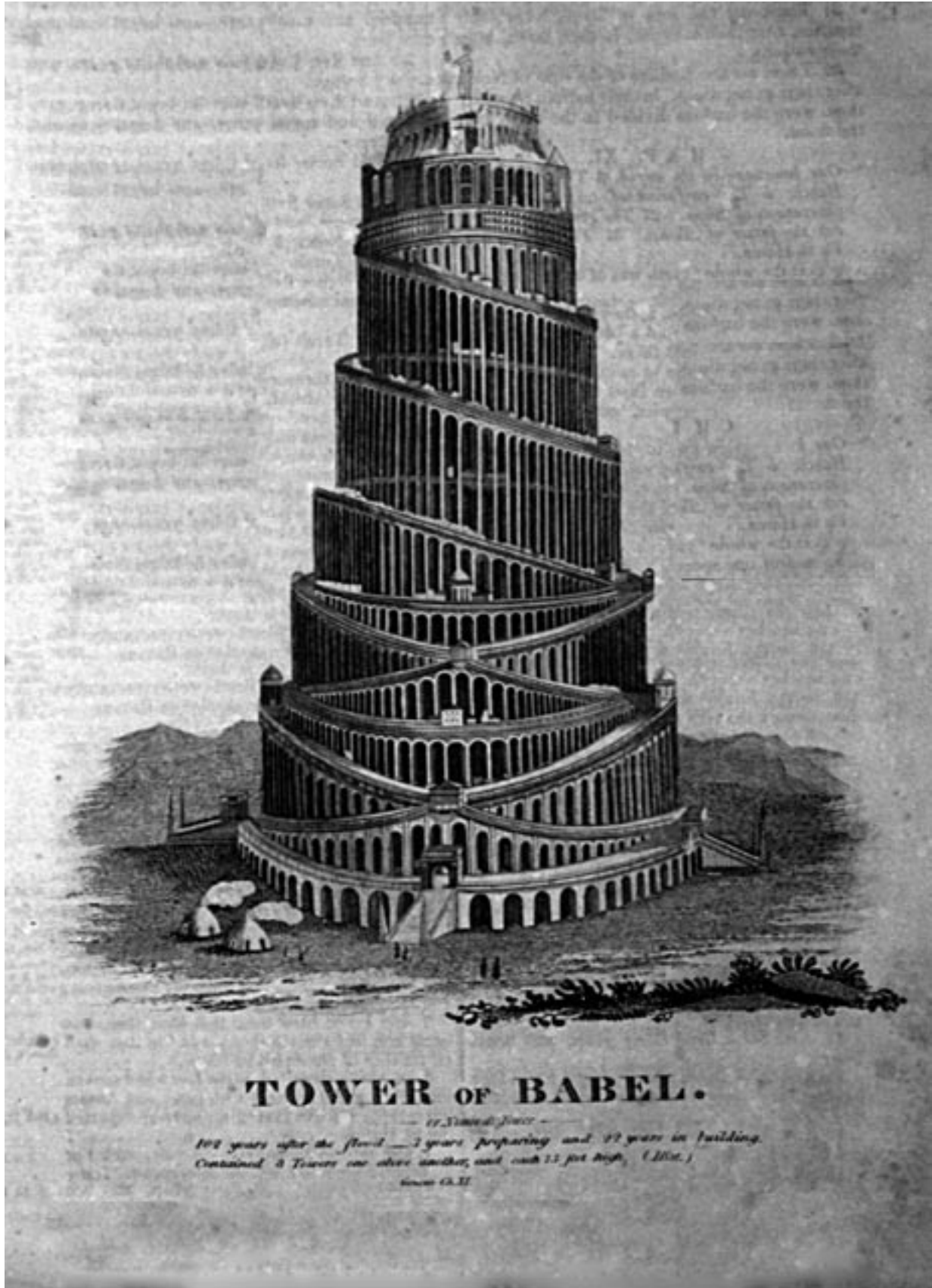

Figure 6. Tower of Babel woodcut in Holbrook's Brattleboro Bible (1816).

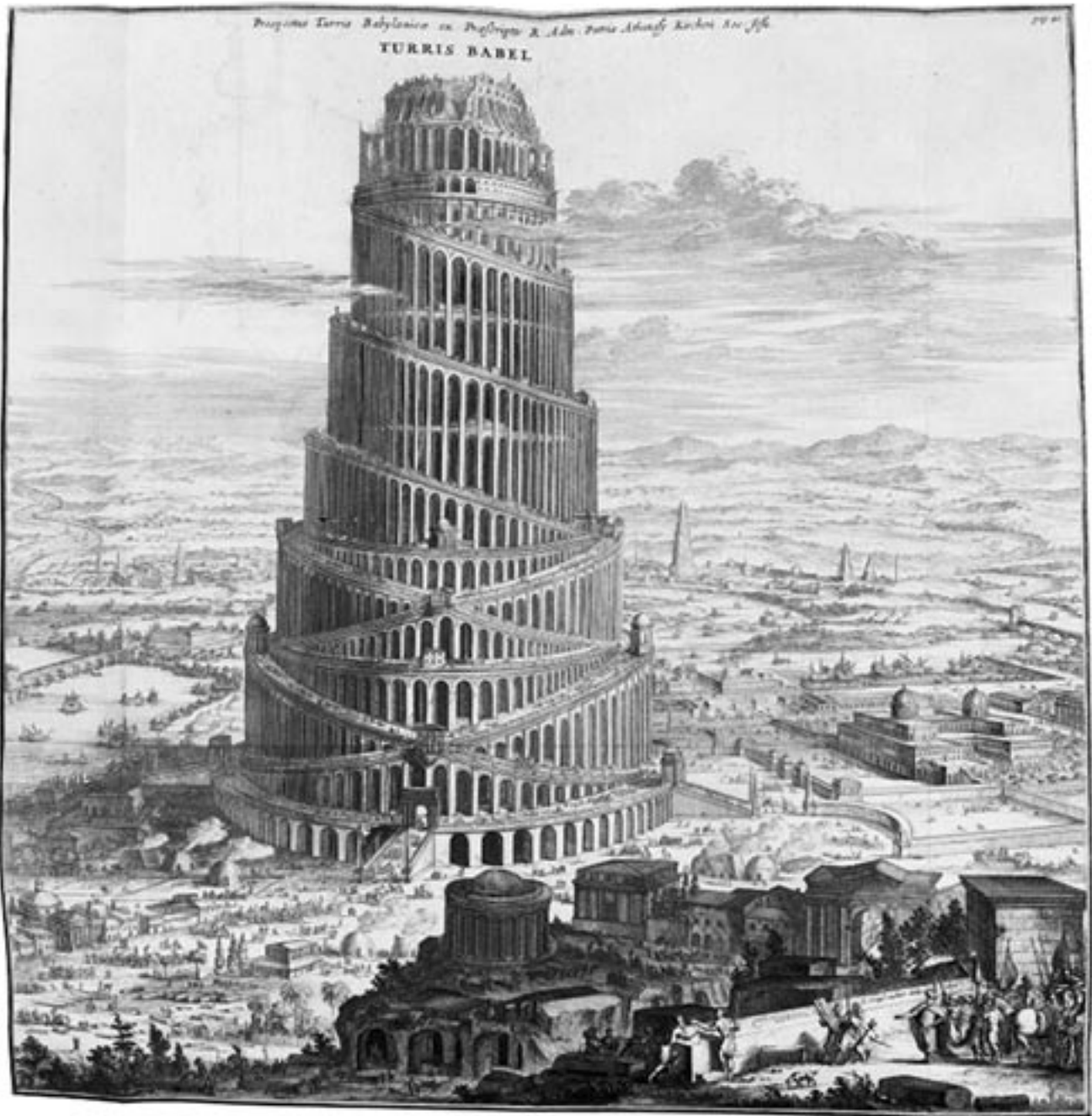

Figure 7. Tower of Babel copperplate by Lieven Cruyl in Athanasius Kircher, *Turrus Babel, sive Archontologia ...* (1679), facing p. 41. Published with permission of Asian and Middle Eastern Division, The New York Public Library, Astor, Lenox and Tilden Foundations.

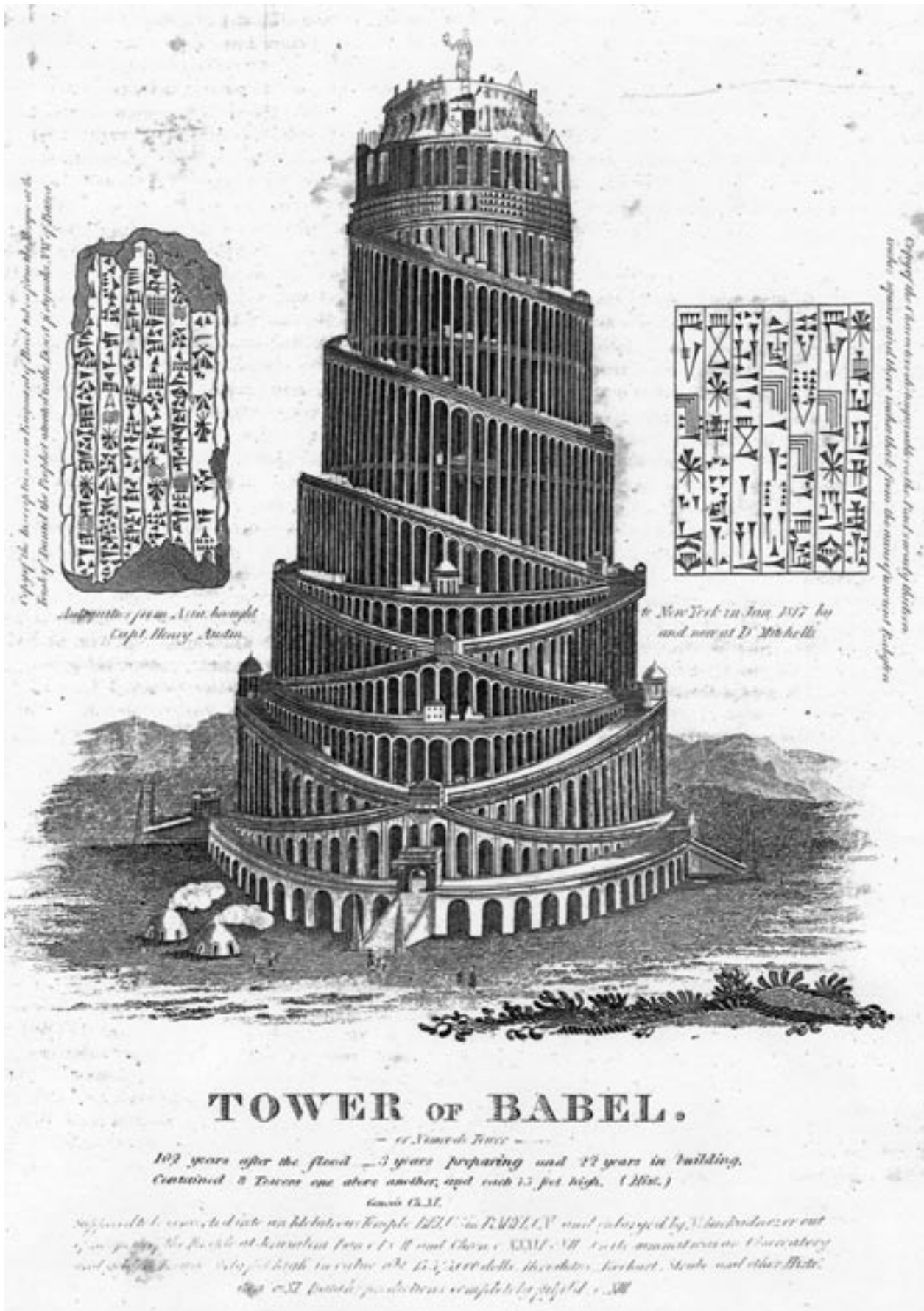

Figure 8. Tower of Babel woodcut in Holbrook's Brattleboro Bible (1818).

The anonymous engraver, probably Anderson, set the long axis of both texts vertically so that the interlinear separators would mirror the columns of the Tower. By flanking the Tower, the two inscriptions and their captions preserve the strong symmetry of the overall engraving, while at the same time adding mass to the structure, shoring it up, as it were. The story of the Tower of Babel captures the myth of primordial linguistic confusion visited upon human hubris. Surrounding the Tower with texts in an exotic and, in 1818, undeciphered script of the ancient Near East was a felicitous touch, Orientalizing the biblical narrative by marriage to those exciting Near Eastern artifacts. Notice that the artist chose not to represent the much larger form of the Nebuchadnezzar II brick itself, but only the inscription, giving the elegant elongated arrows and *Winkelhacken* the appearance of a type font, emphasizing the linguistic rather than material aspect of the object. Whatever the source of inspiration, the Tower of Babel plate in the 1818 Brattleboro Bible in all likelihood represents the first original publication of a cuneiform text in America, and probably the first in a Bible anywhere, a remarkably precocious foray into the biblical archaeology movement. And, last but not least, the cursive caption that trumpets the fact that these objects were the very “Antiquities from Asia brought to New York in Jan. 1817 by Capt. Henry Austin and now at D. Mitchells,” injects an element of nationalistic pride by linking the razed Tower of Babel with Yankee maritime prowess and presence of mind.

5. DR. MITCHILL'S ADDRESS

Indeed, as a journalist noted in 1819, Dr. Mitchill, in his capacity as vice-president of the New York Corresponding Association for the Promotion of Internal Improvement, addressed the organization on “the importance, in relation to national character and dignity, of gathering together the fragments of American history, and saving them, by prompt exertion from the oblivion that awaits them. This branch of public improvement he illustrated by the care and skill which the ruins of Babylon and Nineveh had been recently investigated. The results, [Mitchill] rejoiced to say, afforded the fullest confirmation of the truths contained in the historical and prophetic books of the holy scriptures.” Mitchill describes in considerable detail the contemporary scholarly debate between Major James Rennell and the British Consul Claudius James Rich on Babylon, and how the work of the latter authenticated “everything told by our enterprising citizen, Capt. Henry Austin.” Mitchill gives pride of place to Rich's observations at Nineveh, relating the dimensions of Kouyunjik, the existence of a Muslim shrine to Jonah, and the fact that “many uncommon antiquities” have been extracted from it. He is pleased to share the information that “Dr. Grotefend of Frankfurt” is making substantial progress in the decipherment of “the cuneiform or arrow-pointed characters inscribed on the bricks and cylinders of Babylon and Persepolis.”³⁴

6. SUMMARY

By 1819, when Congressman Dr. Mitchill addressed his New York constituency, American scholars with access to the intellectual resources of Boston and New York were capable of contextualizing certain ancient Near Eastern artifacts with a sophistication comparable to that of their European counterparts. Inscribed cuneiform bricks were compared with drawings of similar or identical examples collected from the environs of ancient Babylonia, empirically utilizing size, composition, color, ductus, and text in order to match the objects with specimens in the East India House collection in London and elsewhere. Although the inscriptions remained undeciphered, it was generally recognized that the language corresponded to whatever was spoken in Achaemenid Persia and, most probably, to the lost tongue of the builders of the Tower of Babel long ages before the Persians. Expectations ran high that European savants like Grotefend would someday decipher the language. The Bible, of course, provided the unquestioned historical firmament against which the meaning of Mesopotamian artifacts was parsed out and digested. At the same time, American scholars, like their European counterparts, tapped into a dense corpus of specialized knowledge,

³⁴ Samuel L. Mitchill, “Internal Improvements,” *The National Register, A Weekly Paper* (1819): 210. Anon., “Drs. Dekay and Mitchill,” *The New-York Mirror: A Weekly Gazette of Literature and the Fine Arts* 12 (1835): 365 is a confusingly written account of an

interview with Samuel L. Mitchill, in which he (Mitchill) describes Babylonian bricks either in his personal collection or in that of the New York Lyceum; nothing is said of Henry Austin, so the bricks may have reached the city from other sources.

based on scientific surveys, regarding the topography of key ancient sites, the nature of the surface remains, building techniques, and, within limits, they were capable of visualizing ancient monumental architecture like the ruined ziggurats of Birs Nimrūd and ‘Aqar-Qūf. Unlike their European counterparts, however, enterprising Americans almost immediately commodified their Mesopotamian artifacts by using them to boost sales of deluxe family Bibles and Bible commentaries, and, anticipating the British and French national museum contest over Assyriological antiquities by thirty years, Americans had the gall to boast of their own antiquarian exploits in the hallowed pages of *Genesis*. The bricks dropped by Captain Henry Austin in 1817 dramatically illustrate for us the complex birth pangs of the American biblical archaeology movement, nascent Assyriology, and the cash value of Asiatic antiquities.

BOVINE STONE VESSELS OF THE LATE URUK PERIOD

Trudy S. Kawami, Arthur M. Sackler Foundation, New York

Excavations of the Late Uruk/Jemdet Nasr levels at Uruk produced numerous images of cattle including on stone seals, figurines, and fragments of larger sculptures. At an earlier Rencontre, I discussed the cow-shaped stamp seals¹ and mentioned a series of bovine stone vessels associated with the site. Carved from a fine-grained black or dark gray limestone, they depict standing or recumbent cows and bulls often ornamented with colored inlays. When considered together, they form a remarkably uniform group.

THE VESSELS

The only scientifically excavated bovine stone vessel (fig. 1) was found at Uruk between 1928 and 1931 in the backfill for the second-millennium B.C. Karaindash Temple² and is now in Berlin.³ This vessel, produced from a single piece of stone, has a series of interior voids created by drilling. A narrow channel sunk vertically into the back connects with a larger horizontal boring through the body from the hindquarters into the chest. A second channel was drilled through the forehead and down the neck to connect with the body cavity. A narrow channel was then drilled from the center of the closed muzzle to connect with the neck and a thin copper tube was fitted into the muzzle for a spout. The opening through which the neck was bored had been sealed with a triangular inlay now missing. The result was a vessel that could be filled from the back and the fluid poured out the muzzle of the animal.

Ears and horns were made separately and inserted into drilled sockets, and the eyes were fitted into oval depressions cut into the stone. The animal's body was ornamented with small multi-petalled rosettes, each formed by a ring of small drilled holes arranged around a central drilling. Another rosette decorated the muzzle. The inlays, presumably of a contrasting color, are all missing as are the ears, horns, and eyes.

The form of the recumbent bull or cow—both genders have horns so in the absence of genitals we do not know which is depicted—is compact with the legs drawn up under the body and only summarily indicated. Likewise the line of the shoulder, the dewlap, and the forms of the hips are simple and linear. This contrasts with the naturalistically soft modeling of the head, especially around the muzzle. The general style of the sculpture, the compact shape with its emphasis on simple rounded forms, a small muzzle, and the use of shallow incisions to provide the few interior details are seen on a smaller scale in the many bovine figures from Uruk and other sites.⁴ They all exhibit the stylistic characteristics of the late Uruk period in Mesopotamia.⁵

A stone vessel very similar to the Uruk example entered the Louvre before 1926 with Uruk as its claimed origin (fig. 2).⁶ Carved of dark gray limestone, its horns and ears were added and its body was decorated with trefoil-

¹ Trudy S. Kawami, "The Cattle of Uruk: Stamp Seals and Animal Husbandry in the Late Uruk/Jemdet Nasr Period," *Papers Presented to the 45^e Rencontre Assyriologique Internationale*, vol. 2, *Seals and Seal Impressions* (Bethesda, Maryland: CDL Press, 2001), pp. 31–47; Manfred Robert Behm-Blancke, *Das Tierbild in der altmesopotamischen Rundplastik*, *Baghdader Forschungen* 1 (Mainz am Rhein: Philipp von Zabern, 1979), nos. 4–12, 33–64, pp. 71, 73–76, pls. 2, 8, 9, and color pl. facing p. 6.

² J. Jordan, *Erster vorläufiger Berichte über die von der Notgemeinschaft der Deutschen Wissenschaft in Uruk unternommenen Ausgrabungen* 1 (Berlin: Walter de Gruyter, 1930), p. 42 and pl. 18.

³ Accession no. VA 10108; Behm-Blancke, *Tierbild*, no. 64, p. 73, and pl. 10.

⁴ Behm-Blancke, *Tierbild*, pp. 71, 73–76, pls. 2, 8, 9, and color plate facing p. 6.

⁵ Dominique Collon, *Ancient Near Eastern Art* (Berkeley and Los Angeles: University of California Press, 1995), p. 48; Winfried Orthmann, *Der alte Orient, Propyläen Kunstgeschichte* 14 (Berlin: Propyläen, 1975), pp. 21–25; Anton Moortgat, *The Art of Ancient Mesopotamia* (New York and London: Phaidon, 1969), pp. 7–16; Henri Frankfort, *The Art and Architecture of the Ancient Orient*, rev. ed. (New York: Penguin, 1970), pp. 25–37.

⁶ Accession no. AO 7021; Sidney Smith, "Tricks of Babylonian Priestcraft: Bulls with Internal Borings," *Illustrated London News*, Nov. 13, 1926, p. 945, figs. 1–3; Georges Contenau, *Monuments mésopotamiens nouvellement acquis ou peu connus (Musée du Louvre)* (Paris: Les éditions d'art et d'histoire, 1934), pp. 17–18 and pl. 10; Behm-Blancke, *Tierbild*, no. 67, p. 88, and pl. 12.

shaped inlays, simpler in execution than those on the Uruk vessel. Like the Uruk vessel, the Louvre bovine has a large cavity bored through the body from the rear, connecting with a channel from the top of the back. A second channel drilled through the neck connects the body cavity to a very narrow channel in the head. The access hole in the forehead was once sealed with a triangular inlay.

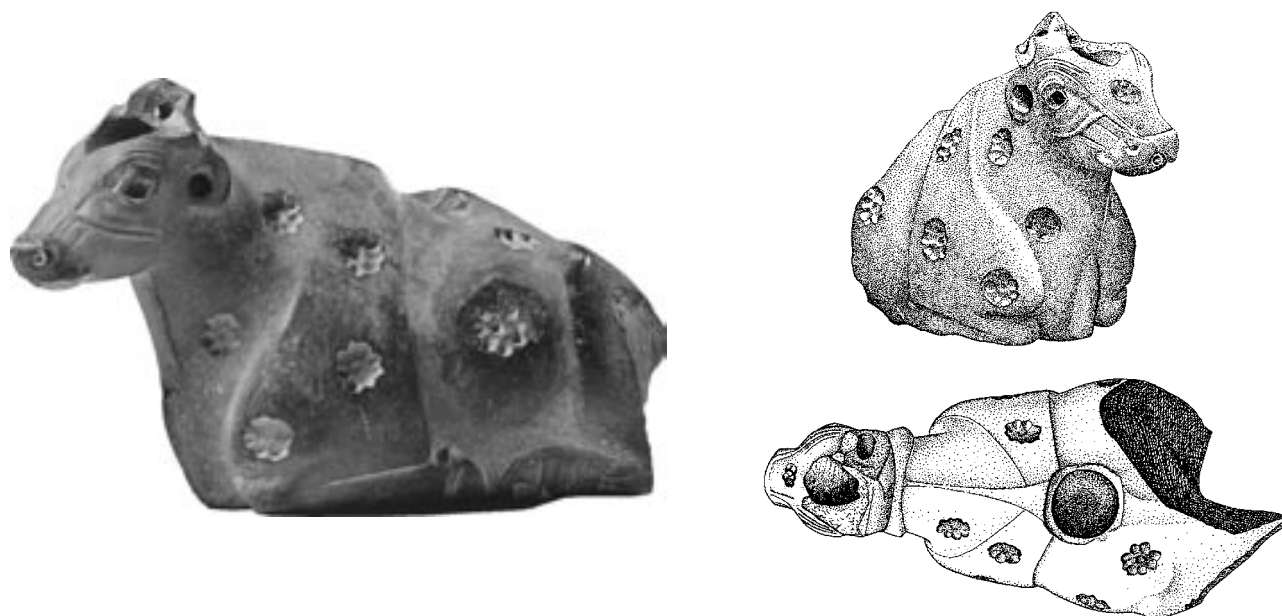

Figure 1. Uruk. Stone vessel, now in Berlin, Vorderasiatische Abteilung, VA 10108. Side view, photo by Juergen Liepe, Bildarchiv Preussischer Kulturbesitz/Art Resource, New York. Front and top views after Behm-Blancke, *Tierbild*, pl. 10.

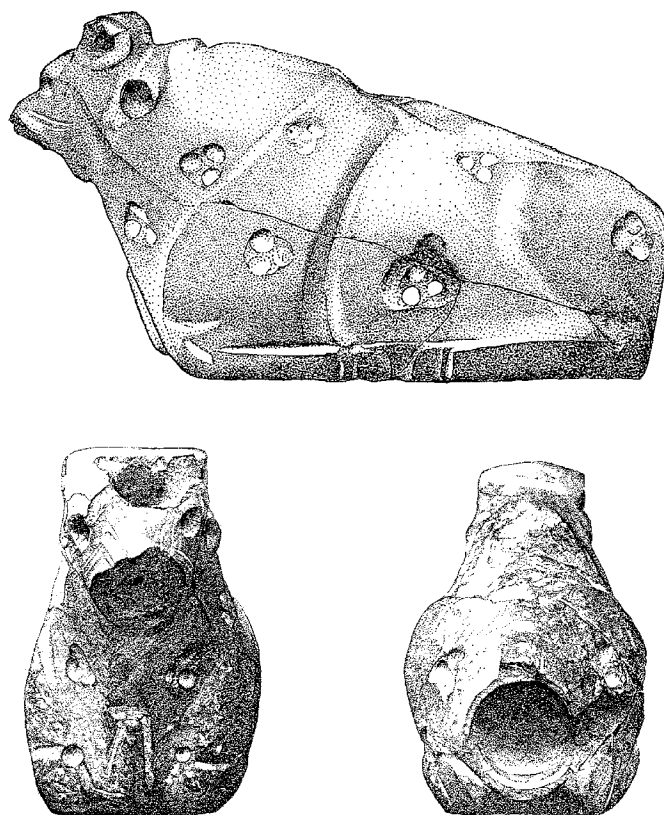

Figure 2. Stone vessel, Louvre, AO 7021. Side, front, and rear views after Behm-Blancke, *Tierbild*, pl. 12.

A third recumbent bovine vessel in the Yale Babylonian Collection (fig. 3) was acquired between 1915 and 1935.⁷ The head is missing, but the hindquarters are sufficiently intact to show the tip of the tail in the curve of the hock on the proper right side (fig. 3b). The general body forms are naturalistic though the delineation of haunches, shoulder, tail tip, and legs are linear and worked with a point; there are no broad chisel marks.⁸ The body is decorated with sunken circles formed with a tubular drill about 1.5 cm in diameter. The naked eye can discern the swirling lines of the drill and the rough surface where the residual tube of stone in the center of each drilling was broken off. The underside of the vessel is relatively flat, the folded legs simply indicated and the surface worn. The interior drilling of the Yale example is exactly the same as the Uruk and London vessels (fig. 4).

A fourth recumbent bovid (fig. 5) with added horns and ears, a forehead triangle, and trefoil inlays on the body like the Louvre example also shows the tip of the tail within the curve of the hock on the proper right. It too has the drilled chambers and channels so that it could be filled from the back and the liquid poured out the muzzle. In 1923 it was owned by Walter A. Roselle of New York⁹ and was later in the collection of A. E. Gallatin, better known for his Egyptian collection which is now in the Metropolitan Museum of Art, New York.¹⁰ The present location of this piece is unknown to me.



Figure 3. Stone vessel, Yale Babylonian Collection, Yale University. YBC 2264. (a) Proper left side, (b) proper right side. Photos courtesy of the Yale Babylonian Collection.

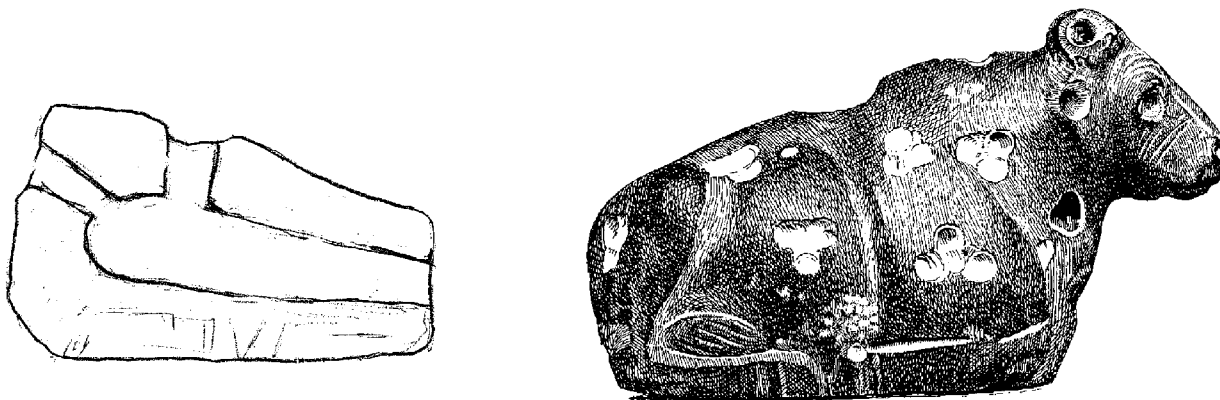

Figure 4. Stone vessel, Yale Babylonian Collection, Yale University. YBC 2264. Diagram of interior channels by the author.

Figure 5. Stone vessel, Roselle and Gallatin collections; present location unknown. After Behm-Blancke, *Tierbild*, pl. 11.

⁷ Accession no. YBC 2264; Briggs Buchanan, "Ancient Near Eastern Art in the Yale Babylonian Collection," *Archaeology* 15 (1962): 268–69. The vessel first appears in the 1935 inventory lists of the collection but was likely acquired years, if not decades, earlier. Personal communication from Ulla Kasten, Associate Curator, Yale Babylonian Collection, June 15, 2005.

⁸ For stone-cutting tools of this period, see P. R. S. Mooney, *Ancient Near Eastern Materials and Industries: The Archaeological Evidence* (Winona Lake: Eisenbrauns, 1999), p. 57.

⁹ Walter A. Roselle, "Three Pieces of Ancient Babylonian Art," *Art in America* 11 (1923): 324 and 325, center.

¹⁰ Ida Ely Rubin, ed., *The Guennol Collection*, vol. 1 (New York: Metropolitan Museum of Art, 1975), p. 63.

A variation on the recumbent bovine form is seen in two vessels in the form of standing cattle. A black stone standing bull vessel said to be from Larsa came into the British Museum about 1924 as a gift from Major V. E. Mocatta (fig. 6).¹¹ The London sculpture is impressive for its fine state of preservation and naturalistic curving forms. It is missing only the inlaid eyes, horns, and ears as well as the lower legs. The heavy, almost humped neck and the pendant area beneath the belly suggesting a sheath indicate that this is a bull, rather than a cow. The interior cavity of the body, the triangular inlay to mask the neck channel, and the narrow circular tube drilled into the muzzle parallel the interior drilling of the recumbent forms completely.

A second standing example in fine-grained black stone is in the Guennol Collection¹² (fig. 7) and for many decades was on loan to the Brooklyn Museum. It had the same inserted horns, ears, and forehead triangle as the other examples. The circular inlay cells on its body were made with a tubular drill linking it technically to the Yale example (fig. 3). The pendant ridge on the belly indicates that the animal is male. It has the same internal cavities and channels as the other vessels (figs. 8 and 9).

These six works are made of the same material: a very dark, fine-grained limestone, and were fashioned by the same type of tools: sharp points or gravers and tubular drills.¹³ The interior drilling forms the same pattern of connecting channels through the head, neck, back, and body. The horns, ears, and eyes as well as forehead triangle and body ornament—either circles or rosettes based on circular forms—were added and probably of a contrasting color. The scale of these works is also fairly uniform. The largest is the Louvre example at 23 cm long; the smallest is the Roselle/Gallatin vessel, 18.4 cm long. These characteristics suggest that the vessels were produced in a fairly limited area over a fairly short time, perhaps for one particular purpose.

It is unlikely, however, that we are dealing with one workshop. The differences in styles between some of the vessels, like the British Museum (fig. 6) and Guennol (fig. 7) works, show differing interpretations of the same basic image.



Figure 6. Stone vessel, the British Museum, ANE 116686, Side and front views, Photos courtesy of the Trustees of the British Museum.

¹¹ Accession no. ANE 116686; Smith, *Illustrated London News*, p. 945, figs. 4–4; H. R. Hall, *La sculpture babylonienne et assyrienne au British Museum* (Paris and Brussels: G. von Oest, 1928), pl. 7; André Parrot, *Sumer: The Dawn of Art* (New York: Golden Press,

1961), p. 81, fig. 100; Behm-Blanke, *Tierbild*, no. 69, p. 88, and pl. 13; Collon, *Art*, p. 48.

¹² Rubin, *Guennol*, pp. 63–67.

¹³ For tubular drills, see Moorey, *Materials and Industries*, pp. 56, 103, 105, 108.



Figure 7. Stone vessel, Guennol Collection, present whereabouts unknown. (a) Proper right side and (b) proper left side. Photos courtesy of the late James Romano.

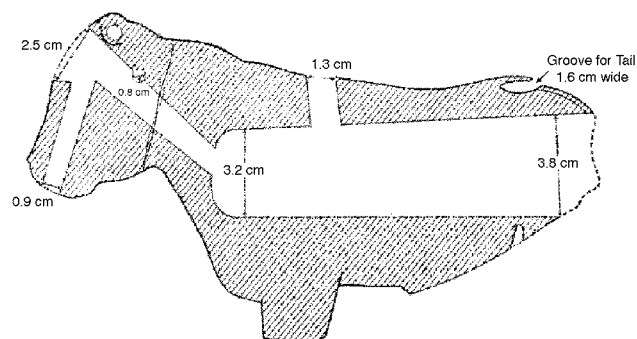

Figure 8. Stone vessel, Guennol Collection, diagram of interior channels after Rubin, *Guennol*, p. 67.



Figure 9. Stone vessel, Guennol Collection, view of channel in body after Rubin, *Guennol*, p. 67.

PARALLELS

Zoomorphic vessels of stone in the shape of a bovine, a hare, and a hedgehog are known from the sixth-millennium B.C. site of Tell Bouqras on the Middle Euphrates.¹⁴ The stones used this early period were locally available limestones, sandstones, and alabasters/marbles in pale colors and banded patterns. This preference for pale figured stones is also noted in southwestern Iran at the same time.¹⁵

Preferences in color changed in the later fourth millennium B.C. when dark stones, often called steatite, diorite, or bituminous limestone, appear more frequently. The term bituminous limestone has been used in a very general way to indicate a dark gray/black fine-grained stone. It should not be confused with the true bituminous mastic produced in the Susa region for several thousand years.¹⁶ All the vessels discussed above are stone; none shows the molded forms and shrinkage cracks associated with ancient mastic. The examples that I have been able to examine directly retain the marks of the graver or point in the unsmoothed areas and the use of tubular drills for both major openings and for inlays. None of the vessels have been subjected to accurate geological identification.

While the stone of the bovine vessels may well be imported,¹⁷ the style and hence the production was local. One can compare the stone vessels with the composite bull excavated at Uruk and now — one hopes — in the Iraq Museum, Baghdad, having a white stone body, colored inlays of two shapes, and silver limbs.¹⁸ This taste for poly-

¹⁴ Peter M. M. G. Akkermans and Glenn M. Schwartz, *The Archaeology of Syria* (Cambridge, United Kingdom: Cambridge University Press, 2003), pp. 120–23, 131, and esp. p. 144. For photographs of two of these vessels, see Glenn M. Schwartz, “Bouqras,” in *Ebla to Damascus: Art and Archaeology of Ancient Syria*, edited by Harvey Weiss (Washington, D.C.: Smithsonian Institution, 1985), nos. 8 and 9, pp. 60–63 and 69.

¹⁵ Moorey, *Materials and Industries*, pp. 39–41.

¹⁶ Jacques Connan and Odile Deschesne, *Le bitumen à Suse: Collection du Musée du Louvre* (Paris: Réunion des Musées Nationaux, 1996).

¹⁷ Moorey, *Materials and Industries*, p. 42.

¹⁸ Orthmann, *Alte Orient*, p. 162 and pl. 14b; Moortgat, *Art*, pl. 25.



Figure 10. Stone vessel fragment, Oriental Institute Museum, Chicago. A2512. (a) Proper right side, (b) proper left side, and (c) top of head showing borings for the neck channel, and inset ears and horns. Photos courtesy of the Oriental Institute.

chromy in stonework also occurs on stone vessels from Uruk¹⁹ and evokes the Intercultural Style stone vessels that were imported throughout Mesopotamia.²⁰ Differences in stone and carving technique, as well as style, are clearly evident between the two groups of stone vessels. Intercultural Style vessels do not show the use of a tubular drill.

A link between these two groups of stone vessels may be a fragmentary head and neck of a bovine vessel of chlorite or steatite (fig. 10a–c). Acquired by James Breasted in Paris in the 1920s for the Museum of the Oriental Institute, Chicago,²¹ it is without a documented archaeological context. Its style, however, links it closely with the dark stone bovine vessels, while its material connects it to the Intercultural Style works. Its pale color sets it apart from both groups. The Chicago fragment has been treated by heating to produce this pale surface that in places has an almost crystalline quality, quite different from the matte appearance of the unheated stone.²² The naturalistic modeling of the head and the soft swelling of the crested neck place the carving in the same general stylistic group as the British Museum bull.

Where were the stone vessels produced? The only scientifically excavated piece comes from Uruk. The Louvre vessel and the Roselle/Gallatin pieces were believed to be from Uruk and associated with the German excavations, work that had been halted during World War I. The British Museum example was supposed to be from Larsa and the Guennol bovine from Umma. However imprecise the information may be, a southern Mesopotamian origin seems likely.

Nearly all these vessels were first recorded in the 1920s and early 1930s. Both the Guennol and Roselle/Gallatin examples were acquired from Joseph Brummer, a famed dealer in both New York and Paris, who handled numerous important works of art in the first third of the twentieth century.²³ He sold the Roselle vessel before 1923, and the Guennol piece was acquired from Brummer's estate after his death in 1947.²⁴ The Louvre and Oriental Institute works were acquired in Paris in the 1920s. The British Museum received its vessels as a gift from a British military officer about 1924, and the Yale example seems to have entered its collection about the same time though it was not published until 1962.²⁵ This tight clustering in time suggests that there may have been a single hoard or a single

¹⁹ Elke Lindemeyer and Lutz Martin, *Uruk, Kleinfunde III*, *Ausgrabungen in Uruk-Warka, Endberichte 9* (Mainz am Rhein: Philipp von Zabern, 1993), nos. 236, 508–12, 534, 536, 541, pls. 29, 54, 55, 58, 59.

²⁰ For an extended discussion of the Intercultural Style, also called the *série ancienne*, and the stone vessels in this style, see Moorey, *Materials and Industries*, pp. 46–49; for illustrations, see Joan Aruz, ed., *Art of the First Cities: The Third Millennium B.C. from the Mediterranean to the Indus* (New York and New Haven: Metropolitan Museum of Art and Yale University Press, 2003), pp. 325–45. For Intercultural Style stone vessels from Uruk, see Lindemeyer and Martin, *Kleinfunde III*, nos. 690, 920, 1102, pls. 61, 64, 68.

²¹ Accession no. A 2512.

²² For the process of heating steatite/chlorite to change its color and surface, see Moorey, *Materials and Industries*, pp. 169–71.

²³ The estate sale was conducted by Parke-Bernet, New York; *The Notable Art Collection Belonging to the Estate of the Late Joseph Brummer*, April 20–23, May 11–14, and July 8–9, 1949. Brummer was active in supporting and selling contemporary art as well as antiquities. He knew Jacques Lipschitz, handled the works of Jules Pascin, and Henri Rousseau painted his portrait in 1909.

²⁴ Rubin, *Guennol*, p. 67.

²⁵ Buchanan, "Ancient Near Eastern Art," p. 269.

site in the vicinity of Uruk that yielded all the bovine vessels to plunderers in the years during and just after World War I.²⁶ The fact that the majority of these vessels can be linked to Paris or to Joseph Brummer who had shops in both New York and Paris reinforces the unity of this group.

FUNCTION

The similarity of the Uruk and related vessels to the animal-shaped vessels shown on the celebrated Warka Vase²⁷ (fig. 11) suggests that the bovine vessels were temple furnishings. But for which deity? It is pertinent to note that neither vessel carved on the Warka vase is bovine, indeed both depict wild, not domesticated animals. Perhaps a deity other than Inanna is indicated. Both Anu, the sky god of Uruk and father of Inanna, and Anu's son Enlil, the "wind" god of Nippur, have bull epithets²⁸ and these vessels would be appropriate in their temples. However, I do not mean to directly identify these vessels with either deity, as centuries separate the production of the vessels from the texts that provide the names and titles. But these titles taken with the dramatic yet ambiguous imagery of the "Bull of Heaven" in the Gilgamesh Epic²⁹ suggest a stratum of theriomorphic imagery associated with Anu, Enlil, and Inanna.



Figure 11. Uruk. Detail of stone vase showing animal-shaped vessels. Iraq Museum, Baghdad.
Photo after Lindemeyer and Martin, *Uruk, Kleinfunde III*, pl. 22.

²⁶ Roselle, "Three Pieces," p. 327.

²⁷ Lindemeyer and Martin, *Kleinfunde III*, pls. 19, 22:f.

²⁸ Gwendolyn Leick, *A Dictionary of Ancient Near Eastern Mythology* (London and New York: Routledge, 1991), pp. 7–8, 45–47.

²⁹ Tablet VI. For an overview of the text and its history, see William Moran, "The Gilgamesh Epic: A Masterpiece from Ancient Mesopotamia," in *Civilizations of the Ancient Near East*, vol. 4, edited by Jack M. Sasson (New York: Scribner, 1995), pp. 2327–36.

Finally, of course, is the question “What did the vessels hold?” Milk, of course, is the first and obvious suggestion.³⁰ But I am not sure that milk was the fluid poured from the vessel. These stone bovines hold a relatively small amount, at most a cup, and the very narrow spout in the muzzle would produce a dribble rather than a strong arc of fluid. Cream is another possible fluid, but it is thicker than milk and could easily clog the narrow spout. Water, of course, could have been poured out. Another possibility is that the fluid held in the vessel was only needed in small amounts, perhaps perfumed oil to anoint a statue or person³¹ or clarified butter (ghee) as a symbolic food offering.³²

This herd of stone vessels forms a discrete group of highly specialized containers. The complexity of production and the luxury of the materials indicate their place in an elite religious context. These vessels should be included in the limited corpus of temple furnishings like the Warka Vase and the White Head,³³ datable to the latter part of the fourth millennium B.C.

ADDENDUM. MASTIC BOVINE VESSELS

Two fragmentary bovine heads, very close in style to the stone vessels discussed above, form a distinct category of their own by virtue of their material: bituminous mastic. Mastic is a man-made asphalt-based material whose production center was in the lowlands of southwestern Iran.³⁴ One bovine head, excavated at Susa in the early twentieth century, is now in the Louvre (fig. 12).³⁵ It once had inlaid eyes, ears, and horns as well as undulating bands on the neck suggestive of a loosely wrinkled hide. It has recently been dated to the early second millennium B.C. despite its clear stylistic parallels to art of the Late Uruk/Jemdet Nasr period a millennium earlier.

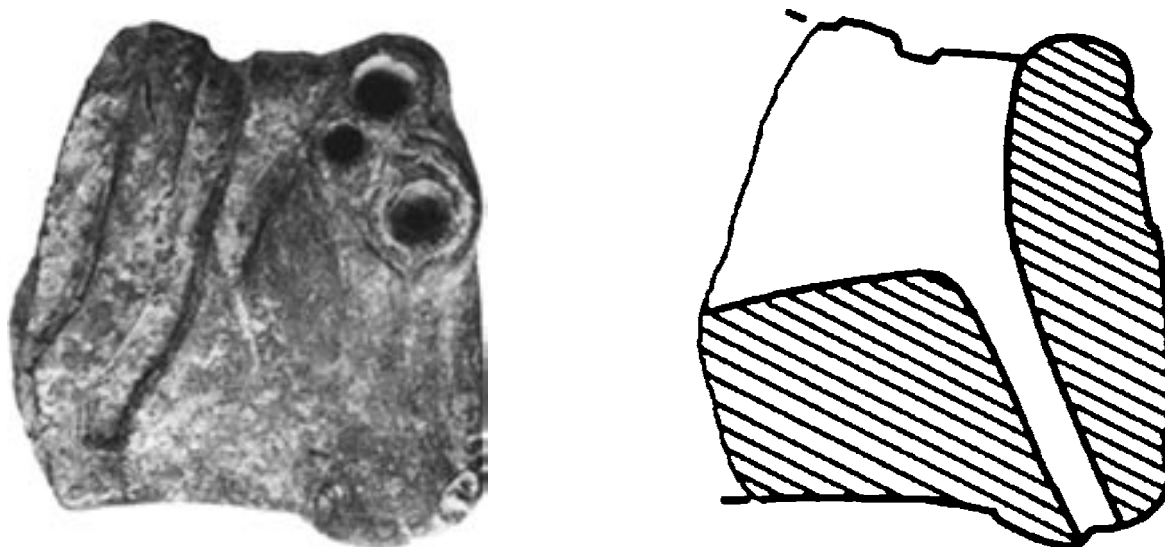

Figure 12. Susa. Mastic bovine vessel fragment. Louvre, Sb 9421. Photo after Connan and Duschesne, *Bitumen*, p. 262.

³⁰ Early texts provide much information on dairy production around Uruk. See Robert K. Englund, “Late Uruk Period Cattle and Dairy Products: Evidence from Proto-Cuneiform Sources,” *Bulletin on Sumerian Agriculture* 8 (1995): 33–48; Marten Stol, “Milk, Butter and Cheese,” *Bulletin on Sumerian Agriculture* 7 (1993): 99–113; Robert K. Englund, “Archaic Dairy Metrology,” *Iraq* 53 (1991): 101–04.

³¹ Smith, *Illustrated London News*, p. 945. For later evidence from Mesopotamia, see Erich Ebeling, *Parfümrezepte und kultische Texte aus Assur* (Rome: Pontificium Institutum Biblicum, 1950). See also Mikhail Dayagi-Mendels, *Besamin ve-Tamrukim* (Jerusalem: Israel Museum, 1989), pp. 89–109, and Lise Manniche, *Sacred Luxuries: Fragrance, Aromatherapy and Cosmetics in Egypt* (Ithaca: Cornell University Press, 1999).

³² Irene Winter, “‘Idols of the King’: Royal Images as Recipients of Ritual Action in Ancient Mesopotamia,” *Journal of Ritual Studies* 6 (1992): 29–30.

³³ The best photos of the White Head are found in Edith Porada, “Mesopotamien und Iran,” *Frühe Stufen der Kunst, Propyläen Kunstgeschichte* 13 (Berlin: Propyläen, 1975), pp. 148–50, pls. 74, 75. See also Collon, *Art*, p. 50, fig. 32; Moortgat, *Art*, pls. 19–21, 26; Frankfort, *Art*, p. 26, figs. 9, 10 and p. 31, fig. 20.

³⁴ Connan and Duschesne, *Bitumen*, p. 212, fig. 4, pp. 39–44, 56–59, 74–75, 115–117.

³⁵ Now in the Musée du Louvre, accession no. Sb 9421. Connan and Duschesne, *Bitumen*, p. 262.

A second fragmentary mastic head now in the Metropolitan Museum of Art³⁶ (fig. 13) was once owned by Walter A. Roselle who also owned one of the stone vessels. Though made of mastic like the Susa fragment and pierced through the head and neck like all the bovine vessels, the Metropolitan Museum piece is distinct from all other examples. It depicts a wild bison (*Bison bonasus*),³⁷ not the domesticated bovine (*Bos taurus*). The animal depicted and the material used point to a somewhat different meaning, and use, of these two works.



Figure 13. Mastic bovine vessel fragment, Roselle Collection. New York, Metropolitan Museum of Art, 49.134.2.
Photo courtesy of the Metropolitan Museum of Art.

³⁶ Accession no. 49.134.2; Roselle, "Three Pieces," pp. 324–25, right; Behm-Blanke, *Tierbild*, no. 70, p. 21, pl. 14.

³⁷ On bison (German *Wisent*), see Behm-Blanke, *Tierbild*, p. 47; Juliet Clutton-Brock, *Domesticated Animals from Early Times* (Austin: University of Texas Press, 1981), p. 66.

THE AKKADIAN “BELLO STILE”*

Davide Nadali and Lorenzo Verderame, Università di Roma “La Sapienza”

Style is a replication of patterning, whether in human behavior or in the artifacts produced by human behavior, that results from a series of choices made within some set of constraints.

— Leonard B. Meyer¹

1. INTRODUCTION

Observing an artifact of the Akkadian period, the refined and elegant style of both paleography and iconography is immediately evident. The definition we have used is not merely an explanation of a phenomenon distinguishing Akkadian art and writing, but it is a result of something that we try to explain through the following comparative analysis: the refinement of writing and art in the Akkadian period is not the cause of what we have labeled the Akkadian “Bello Stile”; rather than giving an explanation, it is an effect that requires an explanation. More precisely, it deals with the identification of rules and strategies to decode the “originality” of the Akkadian production.

Speaking of “bello,” beautiful, is not intended as a mere aesthetic judgment that emphasizes any superiority of Akkadian over Sumerian art and writing: it is neither an aesthetic appreciation nor an ethnic differentiation between Sumerians and Akkadians, or more simply between a Sumerian and a Semitic production in terms so general and imprecise that only with great difficulty can it be applied to Mesopotamian writing and artistic expressions.² In particular, we would like to point out the spatial relations between each figure in glyptic and relief, and between each sign in cuneiform tablets: the alternation of “full” and “empty” spaces, sometimes suitably left for the inscription as on the seals, becomes the stylistic characteristic that distinguishes the Akkadian production from that of the previous and following periods. The Akkadian style is to be recognized and studied as a style of actions that combine the manner—how a work is conceived and created—with the matter—what is asserted.

The word “stile,” style, derives from the Latin *stilum*; moreover, “stile” is a proper variant of the word “stilo,” the tool used to write. This short linguistic digression that points out the original meaning of the word “stile” as concerning writing helps in developing the aim of the present study: the *grafein* (writing) of both the icons (*iconography*) and the cuneiform signs (*paleography*) is the instrument by which the Akkadian artistic and written production is here studied and analyzed.³ The manner of writing (*grafein*) the images and signs becomes the distinctive element of the Akkadian period. The Akkadian style consists not only of what is written and carved, but also of empty space: instead of writing only the images and cuneiform signs, the Akkadian production also distinguishes “the writing of the void” as a necessary component of its distinctiveness.⁴

* The present work is a collaboration between the authors. It is not possible to distinguish each person’s contribution; for academic purposes we assign the research on the archaeological sources to Davide Nadali and that on epigraphic sources to Lorenzo Verderame; the former wrote §§ 1–3, the latter, §§ 4–5.

¹ Leonard B. Meyer, “Toward a Theory of Style,” in *The Concept of Style*, edited by Berel Lang (Ithaca and London: Cornell University Press, 1987), p. 21.

² H.-J. Nissen, *Grundzüge einer Geschichte der Frühzeit des Vorderen Orients* (Darmstadt: Wissenschaftliche Buchgesellschaft, 1983), p. 183; H.-J. Nissen, “‘Sumerian’ vs. ‘Akkadian’ Art: Art and Politics in Babylonia of the Mid-Third Millennium B.C.,” in *Insight Through Images: Studies in Honor of Edith Porada*, edited by Marylyn Kelly-Buccellati et al., *Bibliotheca Mesopotamica* 21 (Malibu: Undena, 1986), pp. 189–96; S. Tricoli, “Sargon the Semite: Preliminary Reflections on a Comparative Study on Sargon of Akkad and His Dynasty,” in *Ethnicity in Ancient Mesopotamia* (Papers Read at the

48th Rencontre Assyriologique Internationale, Leiden, 2002), edited by W. H. van Soldt (Leiden: Nederlands Instituut voor het Nabije Oosten, 2005), pp. 372–92; I. J. Winter, “Aesthetics in Ancient Mesopotamian Art,” in *Civilizations of the Ancient Near East*, vol. 4, edited by J. M. Sasson (New York: Scribner, 1995), pp. 2569–80; I. J. Winter, “Defining ‘Aesthetics’ for Non-Western Studies: The Case of Ancient Mesopotamia,” in *Art History, Aesthetics, Visual Studies*, edited by M. A. Holly and K. Moxey (New Haven and London: Yale University Press, 2002), pp. 3–28; Z. Bahrani, *The Graven Image: Representation in Babylonia and Assyria* (Philadelphia: University of Pennsylvania Press, 2003), pp. 13–49.

³ P. Michalowski, “Early Mesopotamian Communicative System: Art, Literature, and Writing,” in *Investigating Artistic Environments in the Ancient Near East*, edited by Ann C. Gunter (Washington: Smithsonian Institution, 1990), pp. 53–69.

⁴ Nissen, *Grundzüge einer Geschichte*, p. 184.

2. GLYPTIC: ACTION IN THE SPACE VERSUS PRESENCE IN THE SPACE

Instead of looking for *what* is represented in the Akkadian glyptic,⁵ the present study reflects on *how* the theme is reproduced and developed in one picture;⁶ in other words, “instead of looking for a rendering of the scene which in our mind is the most characteristic one of a myth, we should start finding out what in the minds of the ancients may have been the scene, the depiction of which would answer their religious or social needs best.”⁷ The “originality” of the Akkadian production particularly fits with the aspect of recreating themes and subjects already known.

The aim of narrating an event or a story deeply influences the use of the figurative space of the individual image. Early Dynastic III and Akkadian I (“Akkadisch I a”) cylinder seals⁸ arrange the figures differently from the later mature Akkadian seals: they occupy the whole space in superimposed and crossed positions that do not leave any part of the small surface empty (fig. 1). The space in Early Dynastic seals is completely occupied either by vertical figures that cross each other following diagonal lines or by smaller figures in superimposed rows. The rolling of the seal produces a long band in which figures are continuously repeated in well-defined positions and schemes with crossed and symmetrical compositions and with their heads either in frontal view or in profile.⁹

In the contest scenes, the figures in Early Dynastic seals are placed next to one another each covering the other in the typical crossed position (fig. 1), while the characters of the mature Akkadian glyptic occupy their own positions in a more essential composition with a reduced number of figures (fig. 2a–b). The former seem to occupy the space with a series of schemes continuously repeated, while the latter act in the space. When one observes an Akkadian



Figure 1. Impression of an Early Dynastic III seal, contest scene. VA 3407 (Moortgat, *Vorderasiatische Rollsiegel*, pl. 19, no. 116).

⁵ In his brilliant essay that developed a thesis already expressed in a previous study (H. Frankfort, “Gods and Myths on Sargonid Seals,” *Iraq* 47 [1934]: 2–29), Henri Frankfort searched for a direct link between the Akkadian figurative repertoire and some texts of later periods, labeling the scenes depicted as mythological (H. Frankfort, *Cylinder Seals: A Documentary Essay on the Art and Religion of the Ancient Near East* [London: Macmillan, 1939], pp. 91–94, 143). Anton Moortgat, *Tammuz: Der Unsterblichkeitsglaube in der altorientalischen Bildkunst* (Berlin: Walter de Gruyter, 1949), interpreted the scenes on Akkadian cylinder seals as representations all referring to the main theme of Tammuz. Marie Thérèse Barrelet, “Étude de glyptique akkadienne: L’imagination figurative et le cycle d’Éa,” *Orientalia* NS 39 (1970): 213–51, did not consider the scenes depicted as representations of myths, but as reproductions of ritual and cultic practices. Finally, Pierre Amiet focused his attention on some scenes referring to mythological themes rather than to specific texts of myths: in Amiet’s hypothesis, the cylinder seal scenes portraying the eternal cosmological cycle linked to nature; see P. Amiet, “Pour une interprétation nouvelle du répertoire iconographique de la glyptique d’Agadé,” *Revue d’Assyriologie* 71 (1977): 109–10; P. Amiet, “The Mythological Repertory in Cylinder Seals of the Agade Period,” in *Ancient Art in Seals*, edited by E. Porada (Princeton: Princeton University Press, 1980), pp. 37–39. In general, concerning all hypotheses just quoted, see E. Porada, “Of Professional Seal Cutters and Nonprofessionally

Made Seals,” in *Seals and Sealing in the Ancient Near East*, edited by M. Gibson and R. D. Biggs, *Bibliotheca Mesopotamica* 6 (Malibu: Undena, 1977), p. 8; R. Bernbeck, “Siegel, Mythen, Riten: Etana und die Ideologie der Akkad-Zeit,” *Baghdader Mitteilungen* 27 (1996): 164–71; and P. Matthiae, “Figurative Themes and Literary Texts,” in *Literature and Literary Language at Ebla*, edited by P. Fronzaroli, *Quaderni di Semitistica* 18 (Florence: Dipartimento di Linguistica Università di Firenze, 1992), pp. 219–22.

⁶ I. J. Winter, “After the Battle Is Over: The Stele of Vultures and the Beginning of Historical Narrative in the Art of the Ancient Near East,” in *Pictorial Narrative in Antiquity and the Middle Ages*, edited by H. L. Kessler and M. Shreve Simpson, *Studies in History of Art* 16 (Washington: National Gallery of Art, 1985), p. 12.

⁷ H.-J. Nissen, “Settlement Patterns and Material Culture of the Akkadian Period: Continuity and Discontinuity,” in *Akkad: The First World Empire*, edited by M. Liverani (Padua: Sargon, 1993), p. 103.

⁸ R. M. Boehmer, *Die Entwicklung der Glyptik während der Akkad-Zeit* (Berlin: Walter de Gruyter, 1965), pp. 7–14 and pls. 1–4.

⁹ E. Porada, “Sumerian Art in Miniature,” in *The Legacy of Sumer*, edited by D. Schmandt-Besserat, *Bibliotheca Mesopotamica* 4 (Malibu: Undena, 1976), p. 117. For an impression of an Early Dynastic III contest scene, see E. Porada, *Corpus of Ancient Near Eastern Seals in North American Collections*, The Collections of the Pierpont Morgan Library (Washington, D.C.: Pantheon, 1948), pl. 12 n. 75.



Figure 2. (a) Impression of an Akkadian seal, contest scene. BM 104489 (Collon, *Catalogue of the Western Asiatic Seals, Cylinder Seals 2*, pl. 15, no. 112); (b) Impression of an Akkadian seal, contest scene. BM 89147 (Boehmer, *Die Entwicklung der Glyptik*, fig. 236). Copyright by the Trustees of The British Museum.

seal impression, even though it represents a single, small image one has the sensation of being able to distinguish a foreground from a background: the high relief of the images, proportionally organized in the space, gives the idea of a broader surface in which the “empty” space is the essential balance of the space occupied by the figures.

The main feature of Akkadian glyptic production, however, is the development of mythological themes. With this aspect of telling a story, the interesting point is the organization of the space with a single, small image to represent an episode or an event. We would like here to deal with the so-called Etana seals (fig. 3a–c).¹⁰ The Akkadian seal cutters seem to refer to the themes of the legend, representing not only the “culminating scene,”¹¹ that is the final part of the text and story reproduced in a sole image—but several episodes within the whole event.¹² Thus, we should look for how the ancient seal cutters chose the images to reproduce and represent the story.¹³ The typical representation of a man on a flying eagle with the pastoral scene in the lower part of the seal seems to refer to the legend of Etana.¹⁴ The artists selected two episodes from Etana’s life, one linked generally to daily pastoral life, the other referring precisely to the “adventure” of the king of Kish.¹⁵ The figures are no longer represented next to each other in a continuous band, but are linked together to tell a story — they act to represent the event.¹⁶

¹⁰ Frankfort, *Cylinder Seals*, pp. 137–39; A. Moortgat, *Vorderasiatische Rollsiegel: Ein Beitrag zur Geschichte der Steinschneidekunst* (Berlin: Gebrüder Mann, 1940), pp. 24–25; Boehmer, *Die Entwicklung der Glyptik*, pp. 122–23; D. Collon, *Catalogue of the Western Asiatic Seals in the British Museum: Cylinder Seals II: Akkadian, Post Akkadian, Ur III Periods* (London: The British Museum, 1982), pp. 78–79; M. P. Baudot, “Representations in Glyptic Art of a Preserved Legend: Etana, the Shepherd, Who Ascended to Heaven,” in *Studia Paulo Naster Oblata II Orientalia Antiqua*, edited by J. Quaegebeur, *Orientalia Lovaniensia Analecta* 13 (Leuven: Katholieke Universiteit Leuven, Departement Orientalistik, 1982), pp. 1–8; P. Steinkeller, “Early Semitic Literature and Third-Millennium Seals with Mythological Motifs,” in Fronzaroli, ed., *Literature and Literary Language at Ebla*, pp. 248–55; Bernbeck, “Siegel, Mythen, Riten,” pp. 174–80; B. Hrouda, “Zur Darstellung des Etana-Epos in der Glyptik,” in *Festschrift für Hans Hirsch zum 65. Geburtstag gewidmet von seinen Freunden, Kollegen, Schülern*, edited by A. A. Ambros and M. Köhbach, *Wiener Zeitschrift für die Kunde des Morgenlandes* 86 (Vienna: Institut für Orientalistik, 1996), pp. 157–60. The Akkadian seals with representations of the Etana legend are all dated to the Akkadian III phase (“Akkadisch III,” Boehmer, *Die Entwicklung der Glyptik*, pp. 122–23, 137).

¹¹ A. Perkins, “Narration in Babylonian Art,” *American Journal of Archaeology* 61 (1957): 55, 58–59.

¹² Bernbeck, “Siegel, Mythen, Riten,” p. 180. On the distinction between “episode” and “event” in the narrative visual art, see J. P. Small, “Time in Space: Narrative in Classical Art,” *Art Bulletin* 81 (1999): 568.

¹³ Nissen, “Settlement Patterns and Material Culture,” p. 103.

¹⁴ T. Jacobsen, *The Sumerian Kinglist*, *Assyriological Studies* 11 (Chicago: University of Chicago Press, 1939), pp. 80–81; A. Westenholz, “The Old Akkadian Period: History and Culture,” in *Mesopotamien: Akkade-Zeit und Ur III-Zeit*, edited by P. Attinger and M. Wäfler, *Orbis Biblicus et Orientalis* 160/3 (Göttingen: Vandenhoeck & Ruprecht, 1999), pp. 80–82; Steinkeller, “Early Semitic Literature,” p. 252.

¹⁵ Instead of speaking of a “culminating scene,” we prefer to use the term synoptic/simultaneous narrative, where, in a single picture, different episodes of an event are reproduced and represented next to each other; see A. M. Snodgrass, *Narration and Allusion in Archaic Greek Art* (London: David Brown Book Co., 1982), p. 4; M. D. Stansbury-O’Donnell, *Pictorial Narrative in Ancient Greek Art* (Cambridge: Cambridge University Press, 1999), pp. 5–6. On the contrary, there are seals in which the single episode of Etana ascending to heaven on the eagle is used, here properly a “culminating scene,” as a figurative motif in unrelated scenes representing a classical contest scene or fighting gods; see B. Buchanan, *Catalogue of Ancient Near Eastern Seals in the Ashmolean Museum*, vol. 1, *Cylinder Seals* (Oxford: Clarendon Press, 1960), no. 332; Boehmer, *Die Entwicklung der Glyptik*, figs. 666, 168, 192; Baudot, “Representations in Glyptic Art,” pp. 5–6, pl. 2, figs. 6–9.

¹⁶ H. A. Groenewegen-Frankfort, *Arrest and Movement: An Essay on Space and Time in the Representational Art of the Ancient Near East* (London: Faber & Faber, 1951), p. 165.

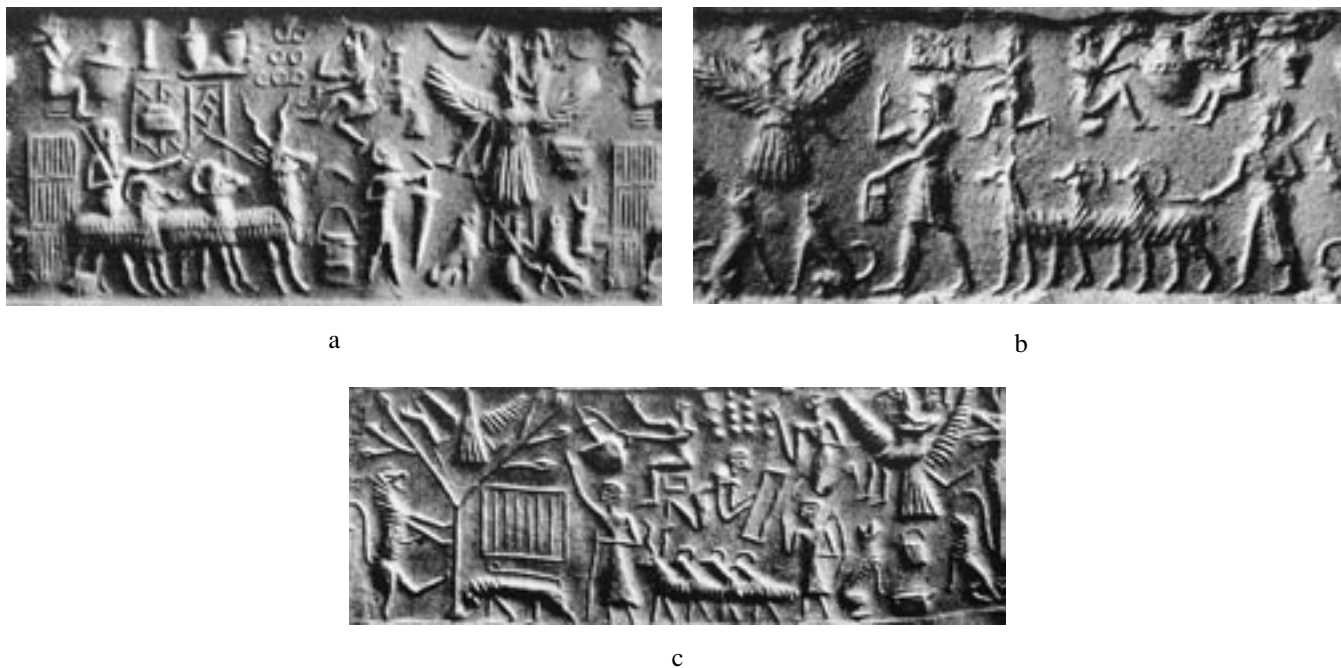

Figure 3. Seal impressions with the representation of Etana's legend. (a) VA 3456 (Boehmer, *Die Entwicklung der Glyptik*, fig. 693); (b) VA 8795 (Boehmer, *Die Entwicklung der Glyptik*, fig. 695); (c) BM 129480 (Collon, *Catalogue of the Western Asiatic Seals, Cylinder Seals 2*, pl. 22, no. 151). Copyright by the Trustees of The British Museum.

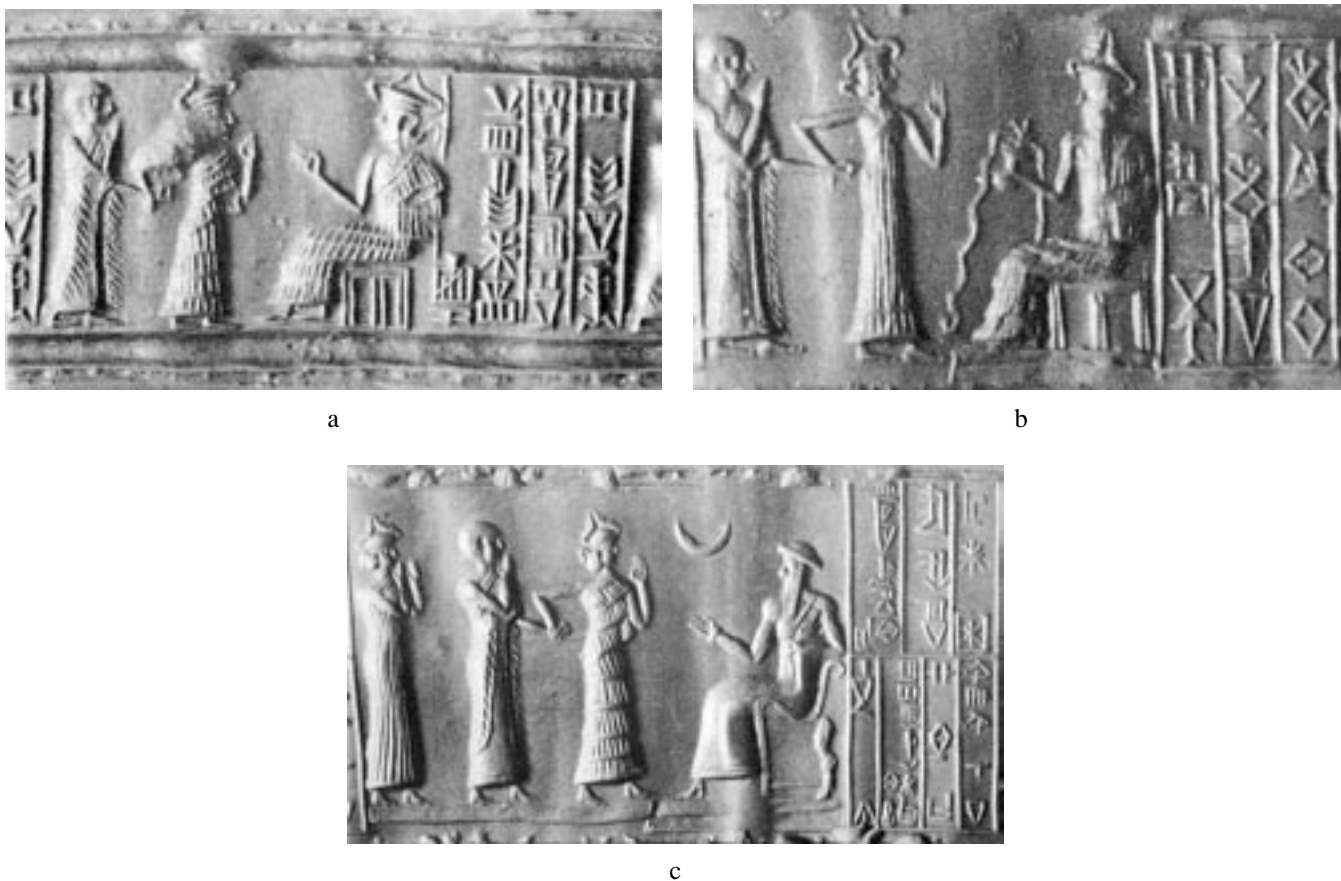

Figure 4. Seal impressions of Ur III presentation scenes. (a) BM 89187 (Collon, *Catalogue of the Western Asiatic Seals, Cylinder Seals 2*, pl. 46, no. 391); (b) BM 132848 (Collon, *Catalogue of the Western Asiatic Seals, Cylinder Seals 2*, pl. 49, no. 439); (c) BM 89126 (Collon, *Catalogue of the Western Asiatic Seals, Cylinder Seals 2*, pl. 52, no. 469). Copyright by the Trustees of The British Museum.

In the following period, mythological themes totally disappear from the cylinder seals, while the so-called presentation scene becomes the main theme depicted in the glyptic of the Third Dynasty of Ur (fig. 4a–c).¹⁷ In the years from the fall of the Akkadian dynasty to Gudea’s dynasty and the Third Dynasty of Ur (Post-Akkadian/Ur III seals),¹⁸ some of the typical Akkadian contest scenes were still produced.¹⁹

Concerning the use of space, the nearly exclusive use of the presentation scene on seals of the Third Dynasty of Ur causes a change in the disposition of the figures and in their reciprocal relation:²⁰ the presentation scene is not only the sole widespread iconography, but it follows a typical pattern that rarely changes.

The generally adopted term “presentation scene” elucidates the character of the depiction: instead of narrating an event or an episode, it depicts a scene;²¹ instead of representing an event or an episode, it simply presents it.²² In the narrative seals of the Akkadian period, figures act in a defined picture to produce a *dynamization* of the space where each character strictly impacts the position and movement of the neighboring one. The presentation scenes of the Ur III glyptic appear more static: they simply present a scene without any *dramatic* attitude.²³ On the contrary, dramatic aspect is clearly evident in the Akkadian seals, even in those with contest scenes with their frequent symmetry and balance in the image, the wider and open disposition of the few selected figures, and their strong and “fast” movements dynamizing their apparent static nature.²⁴

3. RELIEF: MONUMENTAL SPACE

Of the sculpted Akkadian works, only a few examples of both reliefs and statues survive;²⁵ therefore, the common conclusion that the figurative themes of the seals could derive from the statuary of the same period is not entirely justified.²⁶ We will take into consideration only the stelae of Sargon, the founder of the Akkadian dynasty, that of Rimush, Sargon’s son, and finally that of Naram-Sin, the last powerful Akkadian ruler.

In contrast to the analysis of the glyptic, there is no difference between a presentation and a *representation*, since Eannatum’s Stele of the Vultures has also rightly been considered a historical narrative monument, but more particularly it uses space to tell and represent a story.²⁷

¹⁷ Frankfort, *Cylinder Seals*, p. 143; E. Porada, “Why Cylinder Seals? Engraved Cylindrical Seal Stones of the Ancient Near East, Fourth to First Millennium B.C.,” *The Art Bulletin* 75 (1993): 571.

¹⁸ Collon, *Catalogue of the Western Asiatic Seals, Cylinder Seals 2*.

¹⁹ D. Collon, *First Impressions: Cylinder Seals in the Ancient Near East* (London: The British Museum, 1987), p. 36.

²⁰ Such an iconography was already known in the previous Akkadian production; see Moortgat, *Vorderasiatische Rollsiegel*, pp. 22, 27–28; Boehmer, *Die Entwicklung der Glyptik*, pp. 110–14; Nissen, “Settlement Patterns and Material Culture,” p. 102; M. Haussperger, *Die Einführungsszene: Entwicklung eines mesopotamischen Motivs von der altakkadischen bis zum Ende der altbabylonischen Zeit* (Munich and Vienna: Profil Verlag, 1991).

²¹ Frankfort, *Cylinder Seals*, p. 144.

²² On the significance of the modern definition “presentation scene,” as typological marker used in the analysis of the glyptic, and the derived implication on the value of the subject depicted, see Alessandro Di Ludovico, “Scene-in-frammenti: Una proposta di analisi delle ‘scene di presentazione’ dei sigilli a cilindro mesopotamici orientata all’elaborazione statistica ed informatica dei dati,” in *Studi in onore di Paolo Matthiae presentati in occasione del suo sessantacinquesimo compleanno*, edited by Alessandro Di Ludovico and Davide Nadali, *Contributi e Materiali di Archeologia Orientale* 10 (Rome: Università di Roma “La Sapienza,” 2005), pp. 60–68.

²³ Groenewegen-Frankfort, *Arrest and Movement*, pp. 165–66.

²⁴ A. Westenholz, “The World View of Sargonic Officials: Differences in Mentality Between Sumerians and Akkadians,” in Liverani, *Akkad: The First World Empire*, pp. 160, 165; A. Westenholz, “The Old Akkadian Period,” p. 85.

²⁵ P. Amiet, “Altakkadische Rundplastik,” in *Propyläen Kunstgeschichte*, vol. 14, *Der alte Orient*, edited by W. Orthmann (Berlin: Propyläen Verlag, 1975), pp. 171–74; P. Amiet, “Altakkadische Flachbildkunst,” in Orthmann, *Der alte Orient*, pp. 193–97; P. Amiet, *L’art d’Agadé au Musée du Louvre* (Paris: Éditions des Musées Nationaux, 1976); A. Invernizzi, *Dal Tigri all’Eufrate*, vol. 1, *Sumeri e Accadi* (Turin: Le Lettere, 1992), pp. 324–44.

²⁶ E. Porada, “Introduction,” in *Ancient Art in Seals*, edited by E. Porada (Princeton: Princeton University Press, 1980), p. 10. This possible relation between seals and reliefs would be particularly interesting considering the remarks by Irene J. Winter on the Assyrian production of seals and reliefs (I. J. Winter, “*Le palais imaginaire: Scale and Meaning in the Iconography of Neo-Assyrian Cylinder Seals*,” in *Images as Media: Sources for the Cultural History of the Near East and the Eastern Mediterranean (1st Millennium BCE)*, edited by C. Uehlinger, *Orbis Biblicus et Orientalis* 175 [Göttingen: Vandenhoeck & Ruprecht, 2000], pp. 64–65); the seals often copied the scenes of a major relief—as the examples of the lion hunt of Assurnasirpal II prove (Winter, “*Le palais imaginaire*,” pls. 8–9). If the image was copied directly from the relief onto the seal, then the impression of that seal would reproduce a reversed image compared to the relief. This device implies that palace reliefs were used by the Assyrian seal cutters as a source for the iconography of the seals (Winter, “*Le palais imaginaire*,” p. 65). If the Akkadian documentation was so rich as well, one could wonder whether the cylinder seals really duplicated the main monuments (statues, stelae, reliefs), or if the contrary was possible, that the seals were used as a source for major works.

²⁷ Winter, “After the Battle Is Over,” p. 11.

The few surviving Akkadian works testify to a vivid introduction of new elements in well-defined and coded figurative themes characteristic of the ancient Sumerian world.

Stele Sb2 of Sargon (fig. 5) has the same figurative scheme as that of Eannatum's stele (fig. 6) with a character holding a net filled with enemies; the difference between the two is marked by the identification of this character with Sargon himself and also by the definition of the space. Eannatum's stele (fig. 6) is typical in that it distinguishes two episodes (the battle and triumph) and two characters (Eannatum and Ningirsu) in two distinct spaces (the two sides of the stele);²⁸ Sargon's stele does not divide the event into episodes but presents only the final moment (fig. 5).²⁹

The use of a monolithic figurative space is more clearly expressed in Naram-Sin's Victory Stele (fig. 7): the stele does not present any rigid subdivision but has a single narrative direction from bottom to top.³⁰ The dramatic unity of space is characterized even more by the "free" disposition of the figures on the surface.³¹ In this more dramatic and dynamic dimension, the insertion of the landscape with the trees on the right side of the stele seems to have more complete meaning: the space is not only organized in a free and dynamic way, but it is also characterized by the presence of natural elements completely absent in Eannatum's stele and earlier Akkadian monuments.³²



Figure 5. Stele Sb2 of Sargon. Paris, Louvre (Moortgat, *Die Kunst des alten Mesopotamiens*, fig. 126).

²⁸ A. Becker, "Neusumerische Renaissance? Wissenschaftliche Untersuchungen zur Philologie und Archäologie," *Baghdader Mitteilungen* 16 (1985): 283–88.

²⁹ L. Nigro, "Visual Role and Ideological Meaning of the Enemies in the Royal Akkadian Relief," in *Intellectual Life of the Ancient Near East* (Papers presented at the 43rd Rencontre Assyriologique Internationale, Prague, 1996), edited by J. Proseck (Prague: Oriental Institute, 1998), p. 285; L. Nigro, "La stele di Rimush da Tello e l'indicazione del rango dei vinti nel rilievo reale accadico," *Scienze dell'Antichità* 11 (2001–2003): 76.

³⁰ On the original shape of the monument, see the reconstructions by J. Börker-Klähn, *Alt Vorderasiatische Bildstelen und vergleichbare Festreliefs*, *Baghdader Forschungen* 4 (Mainz am Rhein: Philipp von Zabern, 1982), p. 136, fig. 26k; L. Nigro, "Per un'analisi formale dello schema compositivo della stele di Naram-Sin," *Contributi e Materiali*

di Archeologia Orientale 4 (1992): 93–99, fig. 15; and more recently I. J. Winter, "How Tall Was Naram-Sin's Victory Stele? Speculation on the Broken Bottom," in *Leaving No Stones Unturned: Essays on the Ancient Near East and Egypt in Honor of Donald P. Hansen*, edited by E. Ehrenberg (Winona Lake: Eisenbrauns, 2002): pp. 301–02, figs. 4–5 and 10.

³¹ Becker, "Neusumerische Renaissance?," pp. 277–78 and 288–89; Nigro, "Per un'analisi formale," p. 62.

³² H. J. Kantor, "Landscape in Akkadian Art," *Journal of Near Eastern Studies* 25 (1966): 145–52; Nigro, "Per un'analisi formale," p. 72; I. J. Winter, "Tree(s) on the Mountain: Landscape and Territory on the Victory Stele of Naram-Sin of Agade," in *Landscapes, Territories, Frontiers and Horizons in the Ancient Near East* (Papers presented to the 44th Rencontre Assyriologique Internationale, Venice, 1997), edited by L. Milano et al. (Padua: Sargon, 1999), p. 64.



Figure 6. Stele of the Vultures, Paris, Louvre: (a) divine side and (b) human side (E. de Sarzec, *Découvertes en Chaldée* [Paris: E. Leroux, 1884–1912], pls. 3^{bis} and 4^{bis}).



Figure 7. Naram-Sin's Victory Stele. Paris, Louvre (J.-D. Forest, *Mésopotamie: L'apparition de l'état VII^e–III^e millénaires* [Paris: Méditerranée, 1996], pl. 82).

Considering Sargon's stele Sb1 (fig. 8) and the fragmentary stele of Rimush from Tello (fig. 9),³³ it is possible to retrace the steps in the creation and development of the rules and strategies of a distinct Akkadian style that is elaborated upon and further developed under Naram-Sin. Both monuments, although incomplete and fragmentary, subdivide the surface into registers, and the disposition of the figures and the narration of the episodes follow this internal division.³⁴ As with the cylinder seals where we noticed a decrease of the figures and a selection of only a few characters instead of a long sequence of standing figures, so too the space on the reliefs, although comprising more than one scene on the registers, is similarly planned.

Each register shows a pair of figures, usually an Akkadian soldier facing his antagonist; it is in the Akkadian period that the passage from a collective, indistinct representation to an individual representation of both the Akkadian soldiers and the defeated enemies is first introduced.³⁵



Figure 8. Stele Sb1 of Sargon. Paris, Louvre (Moortgat, *Die Kunst des alten Mesopotamiens*, fig. 125).



Figure 9. Stele of Rimush from Tello. Paris, Louvre (Moortgat, *Die Kunst des alten Mesopotamiens*, fig. 134, 135).

³³ B. R. Foster, "The Sargonic Victory Stele from Telloh," *Iraq* 47 (1985): 15–30.

³⁴ Nigro, "Visual Role and Ideological Meaning," p. 286.

³⁵ Nissen, *Grundzüge einer Geschichte*, pp. 193–94; Nissen, "Settlement Patterns and Material Culture," pp. 104–05; P. Matthiae, *Il sovrano e l'opera: Arte e potere nella Mesopotamia antica* (Rome and Bari: Laterza, 1994), p. 103; L. Nigro, "Legittimazione e consen-

so: iconologia, religione e politica nelle stele di Sargon di Akkad," in *Studi in memoria di Henri Frankfort (1897–1954) presentati dalla scuola romana di Archeologia Orientale*, edited by P. Matthiae, *Contributi e Materiali di Archeologia Orientale* 7 (Rome: Università di Roma "La Sapienza," 1997), figs. 13, 15–20; L. Nigro, "Visual Role and Ideological Meaning."

As a consequence, in Naram-Sin's stele the space becomes totally narrative without any solution of continuity; in an undivided space, narrative is expressed by ascending and descending dynamic lines in an evident tension and contrast between the standing victorious Naram-Sin and his soldiers and the dying, suppliant, and dead enemies.³⁶

This difference is even clearer when one looks at the stelae of the Neo-Sumerian period (the stelae of Gudea—preserved in a few fragments³⁷—and of Ur-Nammu). The artists prefer to organize the narrative following a clear division of the surface in a progressive passage from one register to another, from bottom to top.³⁸ Moreover, the theme changes: Ur-Nammu's stele celebrates the ruler as the king-builder of temples and canals, and as the dispenser of peace who pays homage to the gods ("good face," second register).³⁹ The stele follows the ancient Sumerian style: subdivision into registers and representation of the scenes on both sides of the monument.⁴⁰

Each register repeats the figure of Ur-Nammu, moving from the bottom to the top and shifting from a side to a central position in the upper part of the monument—centrality that is also attained by the ruler in the upper register of the battle side of the Standard of Ur and by Eannatum on the Stele of the Vultures:⁴¹ the king is repeated in each register and for that reason the action can be read both synchronically and diachronically. The early Akkadian monuments, although adopting the subdivision into registers, can be considered as an entire dramatic space in which the registers are not the synchronous part of the whole action. Naram-Sin's Victory Stele overtakes the dual possibility of reading: it represents the action in a single dramatic space without any division and repetition, and it develops the dynamic lines of direction for each character in a proper continuous surface.

Just as with the cylinder seals of the Early Dynastic and Neo-Sumerian periods, the figures are juxtaposed one next to the other, so that the space on the reliefs is organized by means of superimposed registers. In the Akkadian period, the selection of a few figures in the seals and the organization of the surface of the reliefs as a unique dramatic space determine the change from a simple paratactic juxtaposition to a hypotactic relation among the characters in the action.

4. EPIGRAPHIC SOURCES

Concerning the epigraphic sources, the Akkadian period is certainly not the best example in Mesopotamian history.⁴² Despite the relevance of the dynasty for fundamental changes in Mesopotamian history such as the creation of the first regional state, with all the effects and consequences deriving from its management, very little is preserved from this time; the Akkadian period is one of the most poorly documented "imperial" periods in Mesopotamia.

The paucity of data limits our full and correct understanding of the lines of development in the period. The absence of valuable elements recorded in the documents, such as a date system, makes the situation worse and does not allow us to set in space and time the epigraphic documents as we can do within Neo-Sumerian *corpora*.

Despite this clear limitation to the research, there is total agreement among scholars on the peculiarity and development of the principal lines of the period. Identification of an artifact or document as belonging to this period is immediate and generally led simply by an aesthetic evaluation. This evaluation, far from being objective, seems to be diffuse: the Akkadian style, epigraphic or iconographic, is unanimously said to be "beautiful."⁴³ The style of the Akkadian period is synthesized in this unique word.

But does a single word suffice to express the complexity of an entire period? And if the answer is positive (as many scholars declare), shall we consider this generally accepted subjective evaluation as a result of the creator's objective will of differentiation?

³⁶ Nigro, "Per un'analisi formale," figs. 3, 6.

³⁷ A. Moortgat, *Die Kunst des alten Mesopotamiens: Die klassische Kunst Vorderasiens* (Cologne: M. DuMont Schauberg, 1967), p. 72, fig. 48.

³⁸ Moortgat, *Die Kunst des alten Mesopotamiens*, p. 73.

³⁹ Moortgat, *Die Kunst des alten Mesopotamiens*, fig. 194; and J. V. Canby, *The "Ur-Nammu" Stela*, University Museum Monograph 110 (Philadelphia: University of Pennsylvania Press, 2001), pl. 10.

⁴⁰ Becker, "Neusumerische Renaissance?," pp. 290–92 and 295.

⁴¹ Winter, "After the Battle Is Over," pp. 19 and 26.

⁴² Westenholz, "The Old Akkadian Period," pp. 18 ff.

⁴³ Benjamin R. Foster, "Archives and Record-Keeping in Sargonic Mesopotamia," *Zeitschrift für Assyriologie* 72 (1982): 3; Ignace J. Gelb, *Old Akkadian Inscriptions in Chicago Natural History Museum, Fieldiana: Anthropology* 44.2 (Chicago: Chicago Natural History Museum, 1955), p. 177; Gelb, *Old Akkadian Writing and Grammar, Materials for the Assyrian Dictionary* 2, second edition (Chicago: University of Chicago Press, 1961), p. 13.

Iconographic style generally develops faster than do epigraphic styles that are tied to a deep-rooted and slow administrative system. However, in the Akkadian period the two seem to have a parallel development, both reaching the same expression in the classical period.

From an epigraphic point of view, the evolution of the writing system and tablet format are a natural development of a mainly administrative tool responding to the needs of a new bureaucratic structure that constituted the backbone of the new power in a centralized state. The administrative structure and related tools had already been developed in the previous periods. At the beginning of the Akkadian period, the only need was to adapt this inheritance to the new socio-economic reality, that is to say, no longer a city-state administration but now a regional structure that needed unified systems of weights, taxes, calendar, etc.

Despite the meager data, we have clear traces of these phenomena. For example, the writing system shows changes in the *ductus*, in the tablet shapes, and in particular in the values of signs. The new features are generally documented in the “archives” or in documents coming from cities inside or outside Mesopotamia (such as Susa) without noteworthy local variants.⁴⁴ This is the expression of a centrally educated administrative class functioning according to the policy of total control by the crown.⁴⁵ On the other hand, unification clashed with certain local systems, such as the calendar.

Indeed, in the transition from the Early Dynastic period to the beginning of the Akkadian period, there is no clear difference between the two periods in the *ductus* and shapes of tablets.⁴⁶ In the absence of clear internal information (such as prosopography), we are unable in many cases to date documents with certainty.

Nevertheless, scholars usually speak of a distinctive, beautiful style that corresponds to the reign of king Naram-Sin, lasting into his successor’s reign. The shape of the tablet develops by flattening the obverse and squaring the previously rounded corners. The signs are written carefully and precisely; the spatial relations between them and the general format of the tablet show clear harmony in the composition. Thus we can talk about a real calligraphic style.

These features together with other changes in the administrative system have led many scholars to propose a bureaucratic reform during the second half of Naram-Sin’s reign.⁴⁷

5. CONCLUSION

In conclusion, in this brief analysis we have pointed out how the Akkadian style is distinguished, but ask why it is so distinctive and what marks the difference. From a *generic* point of view, the Akkadians inherited from the previous period the tools and themes for power management: they adopted the writing and administrative systems as well as the artistic *media*. The evolution of this inheritance appears to be a natural development according to the new socio-economic and political reality of a national state, at least at the beginning.⁴⁸ This leads to adapting the inherited tools and *media* to new needs: the king has to impose a new ideology using the old tools within new adequate parameters. The paleographic development of the writing with the creation of a bureaucratic apparatus, as well as the codification of a new unique royal image controlling the whole territory, visibly contrasts with the ancient political system: in the Early Dynastic period, individual city-states used their own parameters for their bureaucratic administrations and presented their own victory monuments. Each city and king was presented as the only good and successful ruler before its own patron deity. In the Akkadian period, for the first time in Mesopotamian history, all these cities were unified under a single political control; there was now a single king controlling all territory and presenting himself as the only successful ruler who has defeated all his enemies. Furthermore, the bureaucratic administrative system was reorganized: local variants of measurements, calendars, taxes, etc. were unified into a single system presented and managed by the central power.

⁴⁴ Robert D. Biggs, “On Regional Handwritings in the Third Millennium Mesopotamia,” *Orientalia* NS 42 (1973): 40; Gelb, *Old Akkadian Writing and Grammar*, p. 40.

⁴⁵ Westenholz, “The Old Akkadian Period,” pp. 39, 50.

⁴⁶ Biggs, “On Regional Handwritings in the Third Millennium Mesopotamia,” pp. 39 f.; Foster, “Archives and Record-Keeping

in Sargonic Mesopotamia,” p. 3 and n. 17; Gelb, *Old Akkadian Inscriptions in Chicago Natural History Museum*, 170 n. 4; Giuseppe Visicato, *The Power and the Writing: The Early Scribes of Mesopotamia* (Bethesda: CDL Press, 2000), pp. 6 ff.

⁴⁷ Visicato, *The Power and the Writing*, p. 9.

⁴⁸ Westenholz, “The World View of Sargonic Officials,” p. 163.

The creation of a new bureaucracy, necessary for the management of a state composed of several provinces each with its own traditions, is the direct expression of geographic, political, economic, and administrative centralization. The new bureaucracy causes the development of a unified administrative system which included the writing system, that is, shape of the tablets, format of the texts, *ductus*, and values of signs.

The creation of a new political control determines the making of a new royal image. The *media* and theme remain generally the same, but the new regional king has to justify his position with different stylistic expressions. This is particularly evident in Naram-Sin's Victory Stele in which the soldiers, although they follow a "free" disposition in the surface, are arranged following a scheme that recalls the Sumerian subdivision of the space into exactly four registers, as in the Sumerian stelae of Eannatum and Ur-Nammu. One can say that if the rules remained the same, the strategy changed, that is, the realization of new rules and the consequent "originality" of the Akkadian production to express a new message.⁴⁹

Early in the Akkadian period, the epigraphic and iconographic styles evolve progressively from the previous Early Dynastic period: the shape of the tablets and the *ductus* do not show any particular or obvious difference, and the date of certain tablets or whether they belong to the Early Dynastic or the Akkadian period are sometimes doubtful. On the contrary, the first Akkadian monuments are immediately identifiable and differentiated, presenting the same subject—such as Sargon's Stele Sb2—in a new strategic composition; on the other hand, the same figurative themes, such as contest scenes in glyptic and war in reliefs, are still used, but they are arranged following a new distinct style.

The so-called classical or mature Akkadian period represents an evident exception from this linear and progressive development. Naram-Sin shows a clear, conscious will in creating a "personal" and very distinctive style.⁵⁰ The idea of a discontinuity in the Akkadian period, differentiating it from the Early Dynastic and Neo-Sumerian periods, could be de facto limited to the "classical" Akkadian period that corresponds to Naram-Sin's reign. All changes in styles fit with the innovation in the propaganda apparatus of this king; for example, he is the first deified king and the first "King of the Four Quarters of the World."

The deviation from the typical and normal images of the king marks Naram-Sin as the exception in the tradition, creating appositely the image of a cursed king voluntarily ignored by the Neo-Sumerian kings.⁵¹ De facto, the kings of the Third Dynasty of Ur inherited the new tools and themes, created and developed by the cursed Akkadian king, such as deification and royal titles.⁵² From the beginning of the Akkadian period, the new dynasty adopted and adapted the inherited tools to their needs; thus we cannot speak of a pure and simple discontinuity, but rather of a refinement and distinction of the ancient schemes to express a new political ideology, and of the application of a new strategy for the coding of new rules. Naram-Sin was the ruler promoting and developing these new rules in a strategy that derived from ancient and previous codes, now revisited and re-adapted. The refined epigraphic and artistic production is the reflection of this new political power and the "beauty" and stylistic difference of the Akkadian works were probably first perceived by the king himself along with his entourage in a self-celebrative and self-contemplative form, as seems to be proven also by the self-deification.⁵³

The distinction and impact of the new political entity with its own peculiar expressions were so strong and effective that even after the Akkadian dynasty collapsed, Mesopotamia was no longer simply the Land of Sumer, but the Land of Sumer and Akkad.

⁴⁹ P. Amiet, "Les statues de Manishtusu, roi d'Agadé," *Revue d'Assyriologie* 66 (1972): 97.

⁵⁰ It seems paradoxical to label as "classical" the period that evidently marked the difference in Mesopotamian history and broke the pattern with new choices in the action and the creation of epigraphic and artistic media, reflecting the increasing political status of Naram-Sin.

⁵¹ On the possible date of composition of the text the Curse of Akkad, see M. Liverani, "Model and Actualization: The Kings of Akkad in the Historical Tradition," in Liverani, *Akkad: The First World Empire*, pp. 56–59, dating the text to the early Isin dynasty. For a previous date to Ur-Nammu's kingdom, see A. Westenholz, "The Old Akkadian Empire in Contemporary Opinion," in *Power and Propaganda: A Symposium on Ancient Empires*, edited by M. T.

Larsen, *Mesopotamia 7* (Copenhagen: Akademisk Forlag, 1979), pp. 122–23 n. 36; Westenholz, "The Old Akkadian Period," p. 55.

⁵² Westenholz, "The Old Akkadian Empire," p. 115; Westenholz, "The World View of Sargonic Officials," pp. 168–69; Becker, "Neusumerische Renaissance?," pp. 303–04, 308; W. Sallaberger, "Ur III-Zeit," in *Mesopotamien: Akkade-Zeit und Ur III-Zeit*, edited by P. Attinger and M. Wäfler, *Orbis Biblicus et Orientalis* 160/3 (Göttingen: Vandenhoeck & Ruprecht, 1999), pp. 178–79.

⁵³ J. S. Cooper, "Mesopotamian Historical Consciousness and the Production of Monumental Art in the Third Millennium B.C.," in *Investigating Artistic Environments in the Ancient Near East*, edited by Ann C. Gunter (Washington, D.C.: Smithsonian Institution, 1990), p. 48.

The difference created by the first Akkadian sovereigns, especially by Naram-Sin, in the Mesopotamian tradition later became a way to magnify the meaning of a new political system and thinking—generally cursing the deeds of Naram-Sin but emulating him as well as the stylistic codes of the policy and art of the Akkadian dynasty, changing yet again the strategy for the formulation of new rules of a new official style.⁵⁴

⁵⁴ On the success of Akkadian power as a model for the later periods, see the considerations of M. Liverani, “Model and Actualization,” pp. 46–52. See also, J. S. Cooper, “Paradigm and Propaganda: The Dynasty of Akkade in the 21st Century,” in Liverani, *Akkad: The First World Empire*, pp. 14–15 and 22–23; B. R. Foster, “Management and Administration in the Sargonic Period,” in Liverani, *Akkad: The First World Empire*, p. 37; Westenholz, “The World View of Sargonic

Officials,” p. 169; I. J. Winter, “Legitimation of Authority through Image and Legend: Seals Belonging to Officials in the Administrative Bureaucracy of the Ur III State,” in M. Gibson and R. Biggs, eds., *The Organization of Power*, Studies in Ancient Oriental Civilization 46 (Chicago: The Oriental Institute, 1987), p. 89. See also the paper of Memet-Ali Ataç in the present volume.

THE CLASSIFICATION OF METHODS OF PICTORIAL NARRATIVE IN ASSURBANIPAL'S RELIEFS*

Chikako E. Watanabe, Osaka Gakuin Junior College

The aim of this paper is to establish the principles for representation as applied to the scheme of pictorial narrative in Assurbanipal's reliefs, and then to classify the reliefs in accordance with the principles established. A particular type of representation was used during the time of Assurbanipal in order to show the development of a story, step by step. This technique was called the "kinematographische Erzählungsform" by Unger¹ or the "strip-cartoon effect" by Reade² in the field of Assyriology, and the "continuous style" by Wickhoff³ or the "cyclic method" by Weitzmann⁴ in the field of aesthetics. A typical feature of this technique is the depiction of different stages of the story, as it unfolds, within a unified space, where the same character is shown repeatedly at different moments of the narrative. This method of representation can also be called "continuous actions," as distinct from the method of "continuous scenes" that depict a story's development scene by scene.⁵ In this paper, I focus on three groups of reliefs from the time of Assurbanipal: 1) the battle of Til-Tuba, 2) the royal lion hunt from Rooms S and S¹ of the North Palace, and 3) the royal lion hunt from Room C of the same palace. They are examined in particular according to the role played by the protagonists, the main characters of the stories.

1. THE BATTLE OF TIL-TUBA

The relief representing the battle of Til-Tuba came originally from Room 33 of the Southwest Palace at Nineveh (figs. 1–3).⁶ It depicts a historic event: Assurbanipal's army invaded Elam in the year 653 B.C., defeating the Elamite troops at Til-Tuba on the river Uлай.⁷ The fate of the Elamite king, Teumman, is depicted in the manner of the "continuous style," integrated into the battle scene, in the background, which is crammed with detail.⁸ The whole composition is divided into three horizontal registers, each indicated by a simple ground line in order to signify the recession of space within an open area.

* I should like to express my sincere gratitude to my colleague Mr. Peter Stubbs and my friend Ms. Rosemary Graham for their generous help in revising my English, and to Professor Irene Winter for her helpful comments. The research has been supported by the academic research fund of Osaka Gakuin University.

¹ E. Unger, "Kinematographische Erzählungsform in der altorientalischen Relief- und Rundplastik," in *Aus fünf Jahrtausenden morgenländischer Kultur: Festschrift Max Freiherrn von Oppenheim zum 70. Geburtstag*, edited by E. F. Weidner, *Archiv für Orientforschung Beiheft 1* (Berlin: E. F. Weidner, 1933), pp. 127–33.

² J. Reade, "Narrative Composition in Assyrian Sculpture," *Baghdader Mitteilungen* 10 (1979): 52–110.

³ F. Wickhoff, *Römische Kunst (Die Wiener Genesis)*, Die Schriften Franz Wickhoffs, edited by Max Dvorák, 3. Band (Berlin: Meyer & Jessen, 1912), p. 30.

⁴ K. Weitzmann, *Illustrations in Roll and Codex: A Study of the Origin and Method of Text Illustration*, 2nd printing (Princeton: Princeton University Press, 1947), pp. 12–36.

⁵ W. Welliver, "Narrative Method and Narrative Form in Masaccio's Tribute Money," *Art Quarterly*, n.s., 1 (1977): 40–58.

⁶ It is known that the theme of the battle of Til-Tuba was also depicted on the wall of Room I of the North Palace. Judging from the drawings of the relief, however, the method of presenting the continuous actions is not found in Room I, because Teumman's detailed episode of flight and execution is not included in the surviving portion of reliefs, which are known only from Butcher's drawings. See R. D. Barnett, *Sculptures from the North Palace of Ashurbanipal at Nineveh (668–627 B.C.)* (London: British Museum, 1976), pl. 25.

⁷ For previous studies, see E. F. Weidner, "Assyrische Beschreibungen der Kriegs-Reliefs Aššurbânâplis," *Archiv für Orientforschung* 8 (1932–33): 175–203; Reade, "Narrative Composition," pp. 96–109; P. Gerardi, "Epigraphs and Assyrian Palace Reliefs: The Development of the Epigraphic Text," *Journal of Cuneiform Studies* 40 (1988): 1–35; J. M. Russell, *The Writing on the Wall: Studies in the Architectural Context of Late Assyrian Palace Inscriptions* (Winona Lake: Eisenbrauns, 1999), pp. 154–99; O. Kaelin, *Ein assyrisches Bildexperiment nach ägyptischem Vorbild: Zu Planung und Ausführung der "Schlacht am Uлай"* (Münster: Ugarit-Verlag, 1999).

⁸ C. E. Watanabe, "The 'Continuous Style' in the Narrative Scheme of Assurbanipal's Reliefs," *Iraq* 66 (2004): 103–14.



Figure 1. The battle of Til-Tuba, left panel, from Room 33, Southwest Palace, Nineveh, about 660–650 B.C. (BM ANE 124801a); photograph by the author.



Figure 2. The battle of Til-Tuba, center panel, from Room 33, Southwest Palace, Nineveh, about 660–650 B.C. (BM ANE 124801b); photograph by the author.



Figure 3. The battle of Til-Tuba, right panel, from Room 33, Southwest Palace, Nineveh, about 660–650 B.C. (BM ANE 124801c); photograph by the author.

The story, to be read from left to right, starts in the middle of the top register, turns to the lower register, then returns to the top register and moves out to the left of the scene (fig. 4). First Teumman and his son Tammaritu are shown being thrown out of their broken chariot. Then the wounded king is led away by his son. The direction of the narrative is indicated by the movement of the two figures hurrying to escape to the right; while Tammaritu looks back to the left, his right hand is raised to indicate the previous scene represented on the left (fig. 5). This posture functions as a “narrative signal” which directs the viewer’s eyes to the “cause” of the event and provides an explanation for the incident currently taking place.

In the third stage of the episode, the king and his son are surrounded and are being charged by Assyrian soldiers. Tammaritu resists by drawing his bow, while his father kneels beside him. Tammaritu is next shown being executed with a blow from a mace, and his decapitated body lies on top of his father, who has been forced to the ground and is about to be beheaded.⁹ The position of this scene between the top and middle registers indicates the continuation of the episode into the middle register.¹⁰ The posture of two Assyrian soldiers also points to the lower left—a “narrative signal” to guide the viewer’s eyes to the middle register, where we see an Assyrian soldier walking toward the left, waving Teumman’s head. To the left of this scene, another Assyrian soldier is walking with Tammaritu’s head held in a similar way. Next, the heads of the two Elamites appear at a base camp, represented in the top register on the left, where the two heads are held up for identification. Finally, again on the left, the story continues as an Assyrian soldier, waving the head of Teumman, rides to Assyria to proclaim the good news.

⁹ An epigraph carved above this scene mentions that their heads were cut off in front of each other, and this is confirmed by the placing of Tammaritu’s headless body on top of that of his father. For all related epigraphs, see Weidner, “Assyrische Beschreibungen,” pp. 180–81, no. 9; Gerardi, “Epigraphs,” p. 31, slab 3 (a six-line inscription); Russell, *Writing on the Wall*, pp. 166–81.

¹⁰ The sequence of episodes up to this point was identified in earlier studies, but the fact that the story continues immediately into the middle register was not recognized. Cf. Reade, “Narrative Composition,”

pp. 96–101, 107; Kaelin, *Assyrisches Bildexperiment*, pp. 14–25 (Register 2: Scenes 24, 30). Russell noticed the Assyrian soldiers carrying two heads in the middle register and assumed that the heads belonged to Teumman and Tammaritu. However, he did not identify each head, resulting in a misidentification of Tammaritu’s head (appearing between the figures of Ituni and Urtak: Russell, *Writing on the Wall*, fig. 57, p. 174) as “the head of Teumman,” as stated in Russell’s caption.

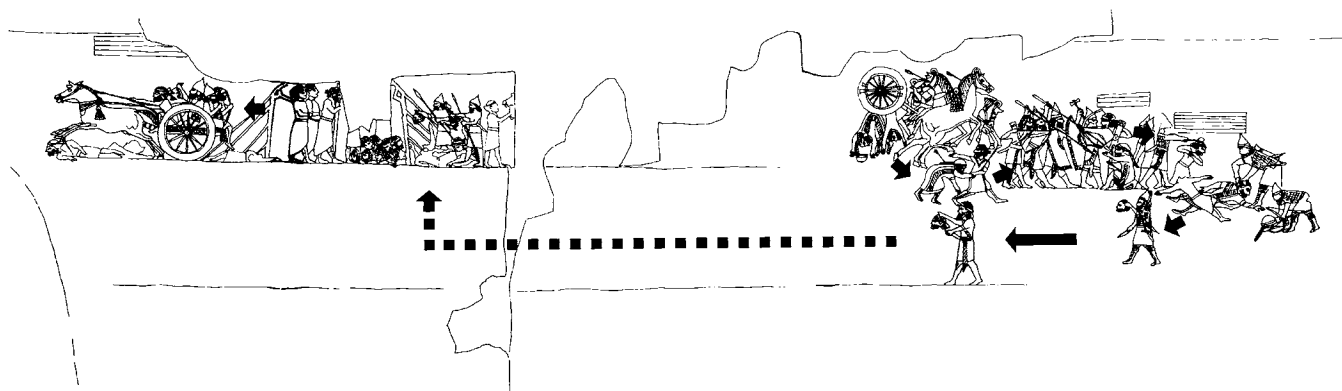

Figure 4. The battle of Til-Tuba (the sequence of episodes).



Figure 5. Flight of the Elamite king and his son Tammaritu, who looks back to indicate the previous scene; from Room 33, Southwest Palace, Nineveh, about 660–650 B.C. (BM ANE 124801b: upper register); photograph by the author.

If we look at this relief cycle with a view to establishing who the protagonists are, it can be observed that Teumman and Tammaritu, in the first two scenes, function as the main characters and move toward the right, where the next story is represented. However, the main role in the third scene is assumed by the Assyrian soldiers, who create a dynamic movement to the right by their act of charging. In the following scenes, concerning the decapitated heads, Assyrian soldiers carry them from the right to the left of the scene, which continues in the upper register, where the soldiers holding the heads both face to the left. The role of the protagonists is thus given to Teumman and Tammaritu only at the beginning of the episode, and as soon as the Assyrian soldiers appear in the scene, they take over that role and then act as executioners and transporters of the heads. The direction in which the story develops, therefore, is the same as the direction indicated by the movement of the main characters depicted in the scene.

According to Wickhoff, a special effect of the “continuous style” is that the viewer is motivated to “read” and follow the development of the story as if he were present all the way through and witnessing each individual inci-

dent along with the protagonists.¹¹ For example, Trajan's Column is carved with scenes depicting the Roman army fighting against Dacia in the year A.D. 113. The Roman Emperor appears more than ninety times in the course of the campaign, and the viewer has to go around the column twenty-three times in order to see all the episodes carved on it.¹² This form of representation stirs the viewer's imagination, prompting him to "accompany" the Roman Emperor throughout his risky military campaign in order to see the final conquest of Dacia. By following each episode, the viewer feels he has participated in the campaign and has fought the battle alongside the Emperor Trajan. This causes the viewer to follow the story unconsciously from the point of view of the protagonists. In the same way, the representation of the Battle of Til-Tuba is intended to direct the viewer's attention to the victory as perceived by the Assyrians, by giving the Assyrian soldiers the role of the protagonists who guide the viewers to the conclusion of the story.

2. THE ROYAL HUNT SCENES FROM ROOMS S AND S¹

The way in which the narrative scenes are organized in the battle of Til-Tuba presents a typical feature of "linear" arrangement: the story proceeds in one direction as it unfolds.¹³ A similar principle is applied to the depiction of royal-hunt scenes from Rooms S and S¹ of the North Palace, where Room S¹ was located above Room S, forming the structure of *bīt-hilāni*.¹⁴ The general composition of the reliefs from these rooms is commonly divided into three horizontal registers. This time, however, the registers are separated by broad borders which indicate that a scene depicted in any one register is to be perceived as taking place in a different setting, whereas single horizontal lines indicate a recession of space. In both rooms, almost identical scenes are portrayed in the upper register, which depicts the king hunting a lion (fig. 6): a lion emerges from a cage, is shot in the back with an arrow, dashes forward in anger, and leaps at the king.¹⁵ The identification of these animals as the same lion is established by a text on the far left, beyond this scene. This part of the relief survives only in the form of a drawing¹⁶ in Room S¹. It shows the king grasping the lion by the throat and thrusting a sword into the animal's stomach. The epigraph states that a lion was released from a cage in order to be shot with arrows. But the lion did not die, so the king stabbed it with an iron dagger to finish it off. The story in these scenes develops from the right to the left in a straightforward linear sequence.



Figure 6. Lion-hunt scene of Assurbanipal, from Room S¹, North palace, Nineveh, about 645–640 B.C. (BM ANE 124886–7: upper register); photograph by the author.

¹¹ Wickhoff, *Römische Kunst*, pp. 124–26.

¹² Trajan's Column represents the method of "continuous scenes" and not the method of "continuous actions" used in the battle of Til-Tuba. See Watanabe, "The 'Continuous Style,'" p. 105.

¹³ For "linearity" and "symmetry" as observed in Assyrian narrative compositions, see I. J. Winter, "Royal Rhetoric and the Development of Historical Narrative in Neo-Assyrian Reliefs," *Visual Communication* 7/2 (1981): 2–38; H. Pittman, "The White Obelisk and the Problem of Historical Narrative in the Art of Assyria," *The Art Bulletin* 78 (1996): 334–55; S. Lumsden, "Narrative Art and Empire: The Throneroom of Aššurnasirpal II," in *Assyria and Beyond: Studies*

Presented to Mogens Trolle Larsen, edited by J. G. Dercksen (Leiden: Nederlands Instituut voor het Nabije Oosten, 2004), pp. 366–70.

¹⁴ A room of the palace provided with a portico.

¹⁵ Barnett, *Sculptures from the North Palace*, pls. 50–51: slabs 11–13, upper register (Room S) and pl. 59: slabs D–E, upper register (Room S¹).

¹⁶ Barnett, *Sculptures from the North Palace*, p. 53: an inscription is engraved on the relief shown on pl. 56, slab B (sic), Or. Dr. V 4; M. Streck, *Assurbanipal und die letzten assyrischen Könige bis zum Untergange Niniveh's*, part 2, Text (Leipzig: J. C. Hinrichs, 1916), p. 308, d 1.

3. THE LION-HUNT SCENES IN ROOM C

Now, as we turn our attention to the lion-hunt scenes represented in Room C of the same palace, we realize that the way in which the story develops is not clearly indicated, unlike the previous examples (fig. 7). The theme of the royal lion hunt covers the entire wall surface of this room. The figure of the king is repeated four times, and each time he is holding a different weapon for killing lions.¹⁷ The major hunting scenes comprise two groups. One group is depicted on the northeast wall and continues into the corner of the southeast wall. In this scene, the hunt is taking place within an enclosure guarded by soldiers with hounds and shields. The other group is represented on the southwest wall, where the hunt appears to be occurring in an open space. The personal features of the king seem to be identical in all four cases (figs. 8, 11, 13, 14), thus I assume that each figure represents the same king, Assurbanipal, at a different moment in the narrative.

The story starts on the left side of the northeast wall, where we find a scene that prepares us for the hunting activities. The king on a chariot receives his bow (figs. 7:5 and 8), while horses are brought and harnessed to the vehicle. More horses are being brought forward from the right of this scene.¹⁸ The preparatory scene is followed by the depiction of a wooded hill on which stands a royal stele (figs. 7:9 and 9), and the citizens of Nineveh are climbing up the hill in order to watch the hunt, which is also represented on the stele itself (fig. 10). To the right of the scene the hunting activities begin: wounded lions move or face toward the left, to be met by the rows of soldiers. Altogether eighteen lions and lionesses are represented in this scene, including a lion which is about to emerge from a cage of which the other end is guarded. A strong leftward movement is created by the representation of the royal chariot, from which the king shoots an arrow (fig. 11). Weissert's interpretation of this scene proposes that the killing of eighteen lions in the Nineveh arena was to secure symbolically the eighteen gates of the city wall surrounding greater Nineveh.¹⁹ All the lions represented on this part of the wall have the same type of mane, flanking the face below the ears: two rows of small locks of fur are arranged to face each other, forming a total of four vertical rows (fig. 12: type A).

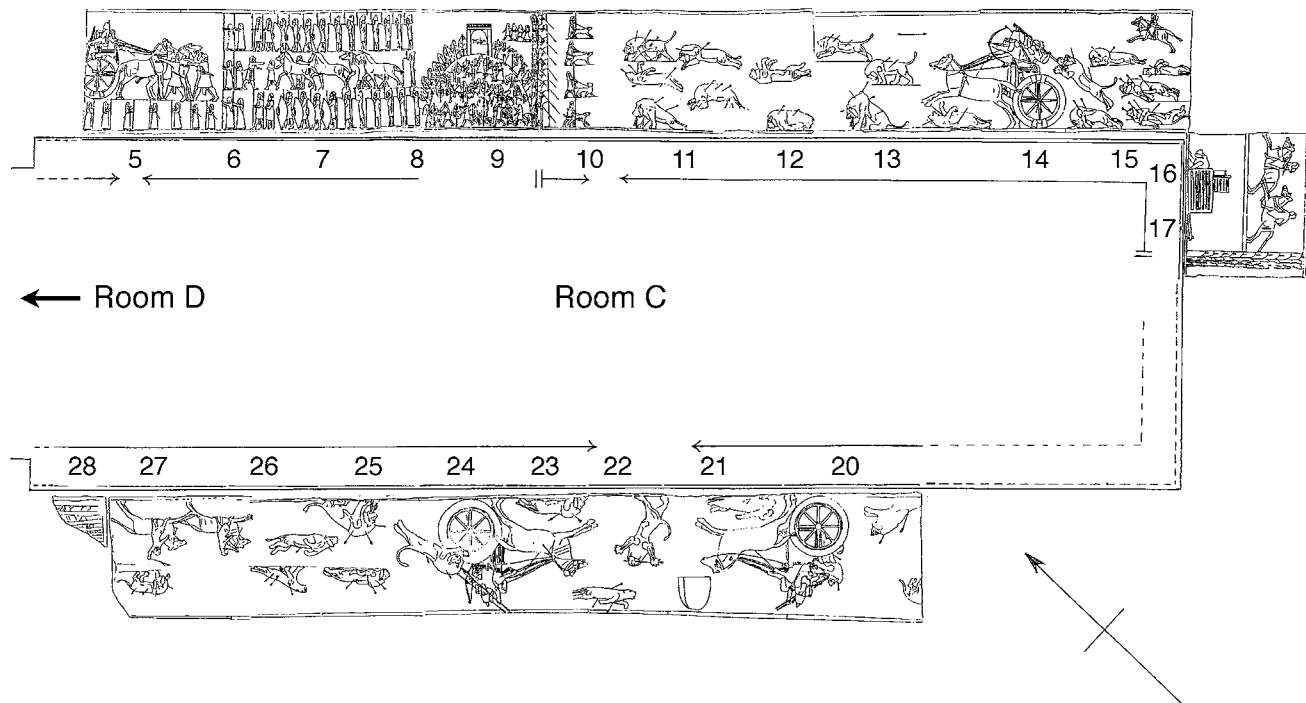

Figure 7. Plan showing the location of reliefs in Room C of the North Palace, Nineveh.

¹⁷ Barnett, *Sculptures from the North Palace*, pls. 5–13.

¹⁸ These additional horses may or may not be the same horses already harnessed on the left of the scene.

¹⁹ E. Weissert, "Royal Hunt and Royal Triumph in a Prism Fragment of Ashurbanipal," in *Assyria 1995: Proceedings of the 10th Anniversary*

Symposium of the Neo-Assyrian Text Corpus Project, edited by S. Parpola and R. M. Whiting (Helsinki: University of Helsinki Press, 1997), pp. 351–56.



Figure 8. The king receiving his bow, from Room C, North Palace, about 645–640 B.C.; photograph by the author.



Figure 9. Wooded hill with a royal stele on its top, from Room C, North Palace, about 645–640 B.C.; photograph by the author.



Figure 10. Royal stele showing the lion hunt (a detail from fig. 9), from Room C, North Palace, about 645–640 B.C.; photograph by the author.



Figure 11. The king shooting an arrow, from Room C, North Palace, about 645–640 B.C.; photograph by the author.

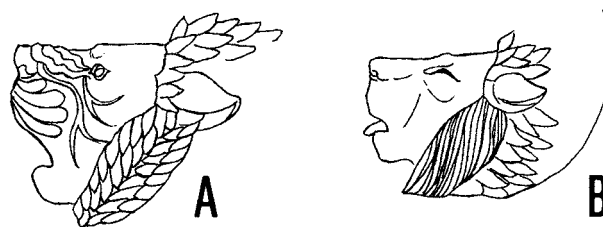

Figure 12. Two types of mane flanking the face of lions represented in Room C.

The relief on the southwest wall depicts a scene in which two royal chariots face each other, with the figure of a rampant lion between the two vehicles (figs. 7:20–23 and 13–15). Some lions on this side of the wall have a different style of face-flanking mane: strokes of vertical lines (fig. 12: type B), which are clearly observed in the case of three lions depicted closer to the entrance of the room. The king on the chariot on the left thrusts a dagger into the throat of the lion (fig. 16), and the king on the right holds a lance to pierce the lion (fig. 17) which has sprung onto the wheel of the chariot. These two chariots are dashing toward each other, which would result in a head-on collision in real life. This unnatural impression is, however, carefully avoided by the placing of the figure of the rampant lion, which is suspended in the air as it has been shot with an arrow between the eyes (fig. 15). The posture of this lion functions as a buffer in order to absorb two dynamic movements that are about to clash.

From a narrative point of view, I honestly do not know how to interpret this scene. The same king is represented twice within a unified space, without any indication of the relative time or the location of the event or events taking place in the scene. This seems to indicate that the artist intended to represent different stages of one event. The whole composition has a symmetrical arrangement, in which most animals move or face toward the center. A similar arrangement is also observed in the preparatory scene, where the figures of attendants move or face toward the central focal point: the king receiving his bow.

In conclusion, the lion-hunt reliefs from Room C—unlike the previous examples—were executed according to a different principle, in which the linear development of pictorial narrative had clearly been abandoned. It was presumably the case that the main aim was not the depiction of the development of the story, but rather the “glorification” of the royal figure shown in a symmetrical arrangement in each unit of the narrative. According to Reade, the battle of Til-Tuba has been dated to 660–650 B.C. and both hunting scenes from the North Palace to 645–640 B.C.²⁰ However, the method of representation adopted in the battle of Til-Tuba and that in Rooms S and S¹ belong to the same category by showing a linear sequence. There are also other reliefs in Room S¹ with a theme closely related to the battle of Til-Tuba, such as the famous royal garden scene, in which the head of Teumman reappears.²¹ Thus, I speculate that the date of the reliefs in Rooms S and S¹ is not so different from that of the battle of Til-Tuba. Representation in the form of “continuous actions” as observed in these reliefs, however, is rarely seen in the other reliefs in the North Palace. The question that arises, then, is: what was the reason for the change of the method in representation after producing the reliefs in Rooms S and S¹? Although there is no conclusive evidence, I should like to suggest a possible explanation with reference to the protagonists.

²⁰ *Art and Empire: Treasures from Assyria in the British Museum*, edited by J. E. Curtis and J. E. Reade (New York: Metropolitan Museum of Art, 1995), pp. 72–77 and 86–87.

²¹ Barnett, *Sculptures from the North Palace*, pl. 65.



Figure 13. Royal chariot represented on the southwest wall (left), from Room C, North Palace, about 645–640 B.C.; photograph by the author.



Figure 14. Royal chariot represented on the southwest wall (right), from Room C, North Palace, about 645–640 B.C.; photograph by the author.



Figure 15. Rampant lion between the two chariots, from Room C, North Palace, about 645–640 B.C.; photograph by the author.



Figure 16. The king thrusting a dagger into the throat of a lion, from Room C, North Palace, about 645–640 B.C.; photograph by the author.



Figure 17. The king piercing a lion with a lance, from Room C, North Palace, about 645–640 B.C.; photograph by the author.

As we look at the lion-hunt reliefs from Rooms S and S¹, it is clear that the role of the protagonist is not given to the king but to the lions, which face and move in the direction of the next story (fig. 18). The artist must have intended to depict in detail the episode of how the animal was hunted down. By doing so, however, he unconsciously gave the king a secondary role, making him face away from the direction of the development of the story. Thus, the hunt is reported from the victim's point of view. As a result, the artist failed to glorify the king in these images, because the viewer naturally follows the story from the point of view of the lion.

Barnett must also have sensed something extraordinary in these scenes, as he noted:

... one is tempted to suspect the hand of an alien, such as a Babylonian master-sculptor, perhaps a prisoner, ... perhaps the unknown genius, by the exposure of his master's senseless cruelty, aimed to express his real hatred of, and revenge himself on, the oppressor of his native city.²²

Barnett clearly implied that the viewer's sympathy is with the lion, though we do not know whether such sympathy was characteristic of ancient times. It would not be surprising, however, if the king was irritated by the relief every time as he saw himself being charged by the lion and almost pushed into the corner on the left of the scene. Although the final victory is the king's in both texts and art, the visual image presented in the form of continuous actions unfortunately conveys a different message. It is not known whether this effect was intended, as Barnett suspected; it may have been pure artistic passion that prompted the adoption of an innovative new technique. If this was indeed the case, the artist certainly made a political misjudgment, and it is no wonder that this method had been abandoned by the time the Room C relief was composed.



Figure 18. Original drawing of lion-hunt relief from Room S¹ by Boucher (upper register), Or. Dr. V 4; reproduced with permission of the Trustees of the British Museum.

²² Barnett, *Sculptures from the North Palace*, p. 13.

SENNACHERIB'S EXPERT KNOWLEDGE: SKILL AND MASTERY AS COMPONENTS OF ROYAL DISPLAY

Irene J. Winter, Harvard University

Sennacherib remains among the most intriguing of the Neo-Assyrian rulers. From his annals we can reconstruct that he participated in relatively few field campaigns during his reign (704–681 B.C.); yet his accounts of various enterprises at home in Nineveh remain unrivaled—the name given to his own palace.¹ Most well known is his expedition to quarry stone for the great colossi that would flank city and palace gates—studied by John Russell, and depicted in Court VI of the Southwest Palace at Nineveh.² Equally elaborate is his account of the construction of a complex water-delivery system, substantiated in the field through the Jerwan aqueduct initially published by Thorkild Jacobsen and Seton Lloyd, and more recently studied as part of the larger urban fabric of Nineveh by Julian Reade, Stephen Lumsden, Ariel Bagg, and Jason Ur—the physical depiction of a part of which is thought to be represented in one of the relief sequences of his grandson Assurbanipal.³ And finally, in addition to the construction of the palace overall, Sennacherib celebrates the innovative metal-casting technology he mastered in order to realize great bronze lion column bases and columns—again thought to have been represented in later palace reliefs.⁴

The relief depictions provide visual records of the king's many undertakings as he shifted the Assyrian capital to Nineveh. In the present study, however, I would like to discuss some of the *verbal* tropes associated with his undertakings—particularly the vocabulary Sennacherib, and several other Neo-Assyrian rulers, used in order to claim or ascribe the requisite knowledge, skill, and expertise, for carrying out their appointed tasks.

This ascription of skill—and the knowledge such skill entails—serves to distinguish works associated with high status from works of domestic or ordinary production. In this, I have found useful the recent work of anthropologists Mary Helms,⁵ Arjun Appadurai,⁶ Liz Brumfiel,⁷ and Cathy Costin.⁸ Significant for the Mesopotamian sequence is that one can demonstrate throughout a highly developed vocabulary and an explicit cultural context for conceptualizing and evaluating qualities associated with high-end production of material culture. In this, Sennacherib stands as a paradigmatic ruler claiming knowledge as an index of royal leadership.

I should add that it is possible for an art historian minimally trained in Assyriology to have access to the vocabulary appropriate to materials, works, and mastery through the CAD and other dictionaries, along with the publication of royal inscriptions and text corpora—particularly in the series overseen by Kirk Grayson and Simo Parpola, and

¹ See on this Stephen Lumsden, “Power and Identity in the Neo-Assyrian World,” in *The Royal Palace Institution in the First Millennium BC*, edited by Inge Nielsen, Monographs of the Danish Institute at Athens 4 (Athens: The Danish Institute, 2001), pp. 33–52; also John M. Russell, *Sennacherib's Palace Without Rival at Nineveh* (Chicago: University of Chicago Press, 1991).

² John M. Russell, “Bulls for the Palace and Order in the Empire: The Sculptural Program of Sennacherib's Court VI at Nineveh,” *Art Bulletin* 69 (1987): 520–39; R. D. Barnett, Erika Bleibtreu, and Geoffrey Turner, *Sculptures from the Southwest Palace of Sennacherib at Nineveh* (London: British Museum, 1998), pls. 99, 102–03.

³ Thorkild Jacobsen and Seton Lloyd, *Sennacherib's Aqueduct at Jerwan*, Oriental Institute Publications 24 (Chicago: University of Chicago Press, 1935); Julian E. Reade, “Studies in Assyrian Geography, Part 1: Sennacherib and the Waters of Nineveh,” *Revue d'Assyriologie* 72 (1975): 47–72, 157–80; Stephen Lumsden, “On Sennacherib's Nineveh,” in *Proceedings of the First International Congress on the Archaeology of the Ancient Near East*, edited by Paolo Matthiae et al. (Rome: La Sapienza, 2000), pp. 815–34; Ariel M. Bagg, *Assyrische Wasserbauten: Landwirtschaftliche Wasserbauten im Kernland Assyriens zwischen der 2. Hälfte des 2. und der 1. Hälfte des 1. Jahrtausends v. Chr.*, Baghdader Forschungen 24 (Mainz

am Rhein: Philipp von Zabern, 2000); Jason A. Ur, “Sennacherib's Northern Assyrian Canals: New Insights from Satellite Imagery and Aerial Photography,” *Iraq* 67 (2005): 317–45.

⁴ See Barnett et al., *Sculptures from the Southwest Palace*, pl. 226; R. D. Barnett, *Sculptures from the North Palace of Ashurbanipal at Nineveh (668–627 B.C.)* (London: British Museum, 1976), pls. 23, 25–26; and Julian E. Reade, “Some Assyrian Representations of Nineveh,” *Iranica Antiqua* 33 (1998): 81–94.

⁵ Mary W. Helms, *Craft and the Kingly Ideal: Art, Trade and Power* (Austin: University of Texas Press, 1993), esp. p. 13.

⁶ Arjun Appadurai, ed., *The Social Life of Things: Commodities in Cultural Perspective* (Cambridge: Cambridge University Press, 1983).

⁷ Elizabeth Brumfiel, “Elite and Utilitarian Crafts in the Aztec State,” in *Specialization, Exchange and Complex Societies*, edited by E. Brumfiel and T. Earle (Cambridge: Cambridge University Press, 1987), pp. 102–18.

⁸ Cathy Lynne Costin, “Craft Specialization: Issues in Defining, Documenting, and Explaining the Organization of Production,” in *Archaeological Method and Theory* 3, edited by M. B. Schiffer (Tucson: University of Arizona Press, 1991), pp. 1–56.

for Sennacherib, the recent editions of Eckart Frahm⁹—such that, with a modicum of discernment, one can pursue important operative terms, their semantic range, and the contexts in which they are used.

This topic seems appropriate to discuss in the context of Mesopotamian knowledge—not classification per se, but rather the relationship that had to have existed between the *knowledge* implicit in claimed expertise and the *special status* claimed for both producer and finished work. Given this relationship, declarations of skilled crafting are to be understood as not merely descriptive, but as ideologically invested, especially when they appear in rhetorical, largely royal or literary texts. As noted by Helms, crafting described as skilled is “value-laden” and tends to be “grander and more ostentatious than ordinary production.”¹⁰ Such declarations, therefore, effectively mirror the underlying classes and qualities of value ascribed to works in their own time.

An elaborate vocabulary for conveying expertise exists, both in Sumerian and Akkadian. Some of the Sumerian vocabulary I have dealt with elsewhere.¹¹ I shall focus here on the Akkadian terminology: *nēmequ*, literally “knowledge,” “wisdom,” “craft”; *naklu*, *nakliš*, *nikiltu*, *nukkulu*, “artful,” “ingenious,” “masterful”; *lē’û*, “able,” “capable.” These terms and attitudes can be employed explicitly to describe actual works, or implied, as in a Neo-Assyrian letter of the time of Sargon II (721–705 B.C.), where an official writes to the king anticipating the king’s pleasure when he sees the “work(manship) of the temples.”¹²

Verbs, nouns, and adjectives conveying “ability/capability,” of course, have a wider range of applications than just craft production, as they are also used with respect to the effective enterprises of gods and kings in general, or are applied broadly to the rendering of legal judgments and knowledge exercised with understanding.¹³ But when these terms are used to refer to capability with respect to material production, they imply the knowledge that translates as skill or ingenuity that will have gone into the construction process.

Such skill can be attributed to deities, to actual craftsmen engaged in labor, and/or to the patron/ruler who assumes ultimate responsibility for a particular undertaking. Not surprisingly, the deity most frequently mentioned as having inspired skill in others, or as having offered his own skill toward important ends, is Ea/Enki, god of knowledge and craft, known as *bēl nēmeqi*, frequently translated as “Lord of Wisdom.”¹⁴ Additional deities are associated with expert craftsmanship in the Neo-Assyrian period, particularly with respect to metalwork.¹⁵

References also abound to skilled craftsmen recognized by rulers as employed in their undertakings. The greatest number of these references occur with respect to architects (Akk. *šitingallû*) who were engaged in royal building projects. Sennacherib, for example, declares in the first person: “I artfully built (the palace) as my royal seat, through the work of wise/knowledgeable architects,” *ina šipir šitingallê enqūti*.¹⁶ His son and heir, Esarhaddon (680–669 B.C.), too, makes reference to “the capable/able architects who lay out plans,” *šitingallê lē’ûti mukinnu gišhurri*, whom the king had gathered together to do the requisite work.¹⁷

Often high-end craftsmen are simply referred to as *ummānu*, literally “master” or “expert” with respect to their specific crafts—particularly when experts are distinguished from juniors or apprentices. The Assyrian *ummānu* has been identified as a possessor of esoteric knowledge, a scholar.¹⁸ It is also the case that the designation has broader

⁹ Eckart Frahm, *Einleitung in die Sanherib-Inschriften*, Archiv für Orientforschung, Beiheft 26 (Vienna: Institut für Orientalistik, 1997).

¹⁰ Helms, *Craft and the Kingly Ideal*, p. 14.

¹¹ Irene J. Winter, “Surpassing Work: Mastery of Materials and the Value of Skilled Production in Ancient Sumer,” in *Culture through Objects: Ancient Near Eastern Studies in Honour of P. R. S. Moorey*, edited by T. Potts et al. (Oxford: Griffiths Institute, 2003), pp. 403–21.

¹² S. Parpola, *The Correspondence of Sargon II*, part 1, *Letters from Assyrians in the West*, State Archives of Assyria 1 (Helsinki: University of Helsinki Press, 1987), p. 110 No.133 rev. 1’ (= ABL 216).

¹³ CAD s.v. *le’û*.

¹⁴ See, for example, Samuel Noah Kramer and John Maier, *Myths of Enki, The Crafty God* (New York and Oxford: Oxford University Press, 1989). The clarification of what it means to be responsible for crafting/creating the physical object is perhaps best exemplified in the Atrahasis Myth (Andrew George and Farouk al-Rawi, “Tablets from the Sippar Library VI, Atra-hasīs,” *Iraq* 58 [1996]: 197 ff.:83–84), where Enlil instructs the divine midwife Bēlet-ilī to create mankind, and she says: “Though the power to do it is indeed mine, the work of it (Akk. *šipru*, that is, the way it is done) is the business of Ea.”

¹⁵ As discussed by Stephanie Dalley, “Neo-Assyrian Textual Evidence for Bronzeworking,” in *Bronzeworking Centres of Western Asia c. 1000–539 BC*, edited by John Curtis (London and New York: Kegan Paul, 1988), pp. 97–110, esp. 99.

¹⁶ Daniel David Luckenbill, *The Annals of Sennacherib*, Oriental Institute Publications 2 (Chicago: University of Chicago Press, 1924), p. 129 vi 57; Frahm, *Einleitung*, p. 92 vii 15. See also, Frahm, *Einleitung*, pp. 71–80, building inscriptions T10 and T11, esp. p. 72: 8–9; CAD s.v. *šitingallu* usage c.

¹⁷ Riekle Borger, *Die Inschriften Asarhaddons, Königs von Assyrien*, Archiv für Orientforschung, Beiheft 9 (Osnabrück: Biblio-Verlag, 1967 [1956]), p. 21:36–37.

¹⁸ For discussions of the Neo-Assyrian *ummānu* as learned scholar, see Francesca Rochberg-Halton, “The Forlorn Scholar,” in *Language, Literature, and History: Studies Presented to Erica Reiner*, edited by F. Rochberg-Halton, American Oriental Series 65 (New Haven: American Oriental Society, 1987), pp. 257–78; M.-A. Ataç, “Visual Decorum and the Agency of Scribal and Sacerdotal Personnel in the Production of the Neo-Assyrian Palace Reliefs” (Ph.D. diss., Harvard University, 2003).

significance in some usages, as any “possessor of specialized knowledge or craft—(whether) scribe, artist, (or) artisan.”¹⁹

A text from the reign of Sargon II makes the distinction between the plan of the deity designated “master builder” and the “experts” who actually do the work. In an account of the rebuilding of a sacred precinct, the project is realized: “through the work of (the god) Kulla, the master builder, and the experts ...,” *ina šipir Kulla ... u ummâni*.²⁰ The Sargon correspondence led Simo Parpola to suggest that “... the men designated as *ummânu* were ‘masters,’ or highly-trained experts of specific crafts,” as well as scribes and scholars.²¹ Certainly, this is strongly implied in the text of Esarhaddon referring to work in the atelier known as the *bīt-mummi*, where he tells us: “I brought in and set to work “able/capable masters,” *mārē ummâni lē'ûti*;²² just as in the Tarbiṣu cylinder of Sennacherib, we are told that the king took as booty not only treasures in gold, silver, and furniture, but “all the master craftsmen, as many as there were,” *ummâni mala bašû*.²³

What is most interesting for our purposes is that the vocabulary for skill and excellence is also employed with respect to rulers themselves, who, pointing to their own or divinely inspired ingenuity, claim merit in the production of valued works. On such occasions, rulers declare their own wisdom and/or the ingenuity requisite for the fruitful realization of their projects.²⁴

Sennacherib is especially noteworthy in this regard. His keen interest in aspects of technology is remarkable. In articulating his innovative techniques for the casting of bronze, his text refers in the first person to “the artful understanding with which Ea, the Lord of Wisdom, endowed me,” *ina uzni nikilti ša ušatlima Ea bēl nēmeqi*.²⁵ This understanding was needed in order to produce eight great lions, “open at the knees,” which utilized some 11,000 talents of bronze. Sennacherib includes complex technical vocabulary demonstrating his understanding of the technology required, in order to sustain his assertion, referring to the same bronzes: “I am capable of undertaking their casting/fashioning” (Akk. *ale 'ê anāku*, using the verb *le'û*, “to be able/capable”).²⁶ With respect to the dedication of the Akītu-temple, he further notes: “From the foundation to the parapet, on my *own* initiative, I skillfully built it” (*ina tēm ramni-ia nakliš ušepišma*).²⁷ And finally, he asserts that his ingenuity and know-how far exceeds that of kings who had preceded him.²⁸

It may also be relevant that in an inscription of his father, Sargon II, something similar is implied when the king asserts in the Display Inscription of Room 14 at Khorsabad: “I planned and thought day and night in order to make this city ...”²⁹—especially as I am persuaded that Sennacherib was largely responsible for the building of Khorsabad while his father was often away on campaign, honing skills there (like the casting of large-scale bronze lions) which were later applied to Nineveh. (But that is a topic for another paper on another occasion.)

The works produced were frequently referred to as having been “artfully” or “skillfully” made—whether through the king’s own knowledge, or through his agency in having commissioned able craftsmen (e.g., *nakliš ušēpiš*, lit. “I had artfully made”).³⁰ Sennacherib’s grandson, Assurbanipal (668–627 B.C.) assumes direct agency as

¹⁹ Jean-Jacques Glassner, “The Uses of Knowledge in Ancient Mesopotamia,” in *Civilizations of the Ancient Near East*, vol. 3, edited by J. M. Sasson (New York: Scribner, 1995), pp. 1815–23, esp. 1816. See also C. B. F. Walker, “Further Notes on Assyrian Bronzeworking,” in Curtis, ed., *Bronzeworking Centres of Western Asia*, p. 117, with reference to bronzesmiths; and G. Lanfranchi and S. Parpola, *The Correspondence of Sargon II, part 2, Northern and Northeastern Provinces*, State Archives of Assyria 5 (Helsinki: University of Helsinki Press, 1990), p. 50 No. 56, with reference to masters and apprentices in the building trade. What would be interesting in this regard would be to pursue *why* the same term would be employed for experts in esoteric knowledge on the one hand and specific crafts on the other; and whether, with Stella Kramrisch’s argument for medieval India (Samuel Parker, “Artistic Practice and Education in India: A Historical Overview,” *Journal of Aesthetic Education* 21/3 [1987]: 123), that temple and temple-image making was believed to draw upon, and so its practitioners possess, powers beyond the merely technical.

²⁰ CAD s.v. *šitimgallu* usage c.

²¹ Simo Parpola, *Letters to Assyrian Scholars*, part 2, *Commentary and Appendix*, *Alter Orient und Altes Testament* 5/2 (Neukirchen-Vluyn: Neukirchener Verlag, 1983), p. 270 re: No. 279:19.

²² Borger, *Inschriften Asarhaddons*, p. 83:29.

²³ Amer Sulaiman, *Cuneiform Writing and Arabic Alphabet: Cuneiform Texts from Tarbisu* (Mosul: Mosul University Press, n.d.), p. 152:33.

²⁴ On the initiative of the king, as separate from the credit given to the deity, see Sylvie Lackenbacher, *Le roi bâtisseur* (Paris: Éditions Recherche sur les Civilisations, 1982), passim, incl. p. 67.

²⁵ Luckenbill, *Annals of Sennacherib*, p. 109 vii 1–3, cited also in Geoffrey Turner, “Tell Nebi Yūnus: The *Ekal Māšarti* of Nineveh,” *Iraq* 32 (1970): 68–85, esp. 75.

²⁶ See Frahm, *Einleitung*, p. 85, citing F. Joannès; also CAD s.v. *le'û*.

²⁷ L. Kataja and R. M. Whiting, *Grants, Decrees and Gifts of the Neo-Assyrian Period*, State Archives of Assyria 12 (Helsinki: University of Helsinki Press, 1995), pp. 105–06 No. 86:17–18, emphasis mine.

²⁸ Frahm, *Einleitung*, p. 73, T10 and T11, lines 35–37.

²⁹ Simo Parpola, “The Construction of Dur-Šarrukin in the Assyrian Royal Correspondence,” in *Khorsabad, le palais de Sargon II, roi d'Assyrie*, edited by A. Caubet (Paris: La Documentation Française, 1996), pp. 49–77, esp. 52.

³⁰ Khorsabad silver foundation tablet = Andreas Fuchs, *Inschriften Sargons II. aus Khorsabad* (Göttingen: Cuvillier Verlag, 1994), p. 49:16–17.

he is made to state in a royal inscription: “I artfully made (*nakliš ēpuš*) a bed of wood, gold, and precious stones for the sanctuary of the gods Marduk and Zarpanitu.”³¹

So, too, Sennacherib. In addition to claiming ingenuity as understanding received from the god Ea, cited above, he refers to the building of a palace arsenal in Nineveh, “which surpassed previous ones in size and artfulness/ingenuity,” *ša eli mahrīti ma ʿdiš šūturat rabāta u naklat*; and he also refers to the bronze colossi for his royal palace as “artfully/ingeniously fashioned,” *nakliš ippatquma*.³²

Now, I have two reasons for bringing this vocabulary to the fore: first, to introduce the proclamation of skilled crafting into discourses on knowledge, value, and even aesthetics; and second, to discuss the limits of semantic range for these terms.

For the first, skilled crafting: the Assyrian case supports Helms’s argument that claims to skill do not represent empty rhetoric; rather, association with skilled crafting by artisans, or, especially, the assumption of the role of skilled craftsman himself, constitutes for the ruler “an explicit and substantial index” of his knowledge, and as such, of “the ... worth and valor of [not only the work, but also] ... of leadership itself.”³³ Not surprisingly, those types of production prove to be not only what is immediately necessary for the palace/state maintenance, but also covers those luxury goods/elite production units that produce for temple and palace ceremonial use and for inter-polity gifting, of the sort likely to be mentioned as skillfully made in our texts. Placing such production units in the context not only of royal monopolies from an economic standpoint, but also royal signals of control from a rhetorical standpoint, helps us to see the fluctuations of royal workshop production in more complex terms and would warrant further study.

A full discussion of attributes often formulaically associated with skilled making—particularly references to embellishment and the resultant judgment of “perfection”—will be undertaken elsewhere. Suffice it to say that even when terms referencing skill, describing embellishment or decoration, and ascribing perfection are not used explicitly, they are frequently implied, as in the formula closing many Neo-Assyrian royal accounts of construction and production: *usim ušarriḥ*, literally, “(I made) fitting and splendid.”³⁴ Assurbanipal makes this relationship explicit in an account of the building and reconstruction of a temple, where he emphasizes he made all “its work (*epšētu*) splendid, its appearance (*nabnītu*) artful/ingenious,” *epšētišu ušarriḥ nabnītašu unakkil*.³⁵

³¹ For work on this text, I am grateful to the generosity of Jamie Novotny and Barbara Nevling Porter (Novotny, personal communication, with respect to text K.2711 for a forthcoming RIM volume [collated 2001]; B. N. Porter, “Beds, Sex and Politics, The Return of Marduk’s Bed to Babylon,” in *Sex and Gender in the Ancient Near East*, part 2, CRRAI 47, edited by S. Parpola and R. M. Whiting [Helsinki: University of Helsinki Press, 2002], pp. 523–35; also E. Matsushima, “Les rituels du mariage divin dans les documents accadiens,” *Acta Sumerologica [Japan]* 10 [1988]: 99f.). This citation may serve as an exemplar. However, before one profiles either individuals or period attitudes with respect to agency, I suspect it will be necessary to factor in the type of text and its placement/disposition. For example, Assurnasirpal II (883–856 B.C.) gives credit to the god Ea for the “cunning,” *hisāt libbi*, literally “intelligence/inspiration of the heart,” necessary for the renovation of his capital Nimrud/Calah in an early part of an important and lengthy text, yet for the remainder, articulates in the first person all his accomplishments in building, decorating, and furnishing the palaces and temples (Grayson, RIMA 2, No. 30). The personal agency in Assurnasirpal’s case may well be a consequence of the fact that the text was inscribed on a freestanding stone slab, known as the “Banquet Stele,” installed in the Northwest Palace at Nimrud itself. One could infer from this that a stele, as a designated royal monument, is more likely to foreground the ruler than, say, an inscription intended to be placed in a temple and dedicated to one of the primary Assyrian deities. Or, it may be a pattern to declare divine inspiration first and then proceed with an account of royal agency, for a later Assyrian inscription of Esarhaddon does just this, ascribing his metal sculptures as skillfully achieved through the work of two patron deities at first, then subsequently in the same text omitting the names of the deities and simply referring in the first person to skill in the making of other liturgical objects in precious

metal (“...artfully I fashioned,” *nakliš aptikma*; Borger, *Inscripfen Asarhaddons*, p. 95 ¶ 64 rev. 9–15). In any case, since Esarhaddon on another occasion credits wise master craftsmen with similar production (cited CAD s.v. *gurgurru* mng. 1), it may well be that variations need to be analyzed on a literary and/or rhetorical basis for each instance.

³² Luckenbill, *Annals of Sennacherib*, p. 129 vi 55–56; Turner, “Tell Nebi Yūnus,” pp. 73 and 76. See also, Frahm, *Einleitung*, p. 78, T10 and T11, lines 195–204. Note that the Akkadian term *uznu*, “understanding,” is also sometimes used alone to imply skill, as in the Erra Epic where we are told that workmen were granted understanding and happy/productive hands (so that they might make a piece of jewelry shining)—cited CAD s.v. *lullū*

³³ Helms, *Craft and the Kingly Ideal*, pp. 14, 69–87. This observation provides perspective on Costin’s (1991) distinction of “attached” vs. independent production, following Earle and Brumfiel (see note 7). We know that production of certain materials/types of objects were attached to palace workshops, with raw materials carefully dispersed and accounted for, as at Mari, for example, Denis Lacambre, “La gestation du bronze dans le palais de Mari: Collations et joints à ARMT 22,” in *Florilegium Mariannum 3, Recueil d’études à la mémoire de Marie-Thérèse Barrelet*, edited by D. Charpin and J.-M. Durand, Mémoires de NABU 4 (Paris: SEPOA, 1997), pp. 91–123.

³⁴ So Assurnasirpal II in his “Banquet Stele” account of the building of his royal residence at Calah and his restoration of earlier palaces (Grayson, RIMA 2, No. 30:27, 60–61, 82–83). Grayson actually translates this phrase as “I decorated them in a splendid fashion,” suggesting thereby that “fitting and splendid” could not be achieved without both skill and embellishment.

³⁵ CAD s.v. *sihrū* mng. 4.

When a work is deemed to have been “perfected” (Akk. *šuklulu*) through its skilled craftsmanship and embellishment, this constitutes crowning praise. Thus, Sennacherib declares that he has had made his alabaster colossi “of perfect proportions,” *mināte šuklulu*; and Assurbanipal’s Ishtar-Hymn includes an account of the ornamentation of the Akītu House at Assur, which closes with the declaration: “I completed and perfected it, and filled it with delights”: *aršip ušaklil lulē umalli*.³⁶

The Hebrew Bible preserves attitudes very close to those of Mesopotamia, as seen in the Exodus account where artisans responsible for making the tabernacle and the ark are endowed by God with “wisdom, understanding, and skill.”³⁷ Mesopotamian references also attest to that skill which brings a work to consummate value, appropriate to temples and palace as the loci of greatest status in the land.

It is my argument here that the resultant display would not have been merely economic and social—a sign that the elite can command the best workmen and rarest and costliest materials. Rather, or also, the skilled and perfect work stands as a sign that the ruler can command, and the work can embody the best, most positively charged qualities of the culture itself.

This brings us to my second issue: the translation and semantic range, not only of words, but of concepts across temporal and cultural distances.

It will be noted in consulting the translations of a number of scholars that the Akkadian words *naklu*, *nakliš*, *nikiltu*, and *nukkulu* are not infrequently rendered as “artistic,” or “artistically made.”³⁸ This I have quite consciously rejected, substituting “artful,” “skillful,” “masterful,” as better conveying the expertise that I believe is implied (comparable to Latin *ars*, Greek *techne*).³⁹ The distinction allows one to select a range of synonyms appropriate to context that do not violate the underlying sense of a term, while at the same time avoiding the assumption of an autonomous category of “art,” hence the “artistic”—that is, works valued as members of a class of *art as such*, independent of the intended context of use—so far undemonstrated for Mesopotamia.⁴⁰ It also foregrounds the importance of skill and ingenuity—“artfulness”—as a cultural category.

What, then, does this mean for the dictionaries and translations of the future? Just as it has now been demonstrated that Akkadian *šalmu* does not mean “sculpture,” “engraving,” “painting,” or “relief,” but rather means “image” and is then *applied* in cases where the imagery is carried by or realized in one medium or another,⁴¹ so also a term like *nakliš* actually means “artful/skillful/masterful/ingenious” The art historian would therefore ask of Assyriological colleagues that, on the one hand, they distinguish between primary meanings and secondary applications or associations, as in *šalmu*, and, on the other, that they avoid translations that project semantic and classificatory categories upon a culture which were demonstrably absent historically, as in “artistic,” by selecting carefully “artful” or any legitimate synonym conveying skill.

The enterprises described in terms of the skilled production discussed above were clearly among the most important undertakings of the realm. While there is no practice of naming years after major building projects or the manufacture of high-end cultic or royal works in the Neo-Assyrian period, as there had been in previous historical

³⁶ CAD s.v. *lulū* usage b; Luckenbill, *Annals of Sennacherib*, p. 108 vi 66; Andreas Fuchs, “Die Inschrift von Ištar-Tempel,” in R. Borger, *Beiträge zur Inschriftenwerk Assurbanipals* (Wiesbaden: Harrassowitz, 1996), p. 291:33–34. Assurbanipal uses the same phrase, [*a*]r-šip ú-šak-lil, in his description of the Akītu House at Harran as well (see Jamie R. Novotny, “A Note on the Akītu-House at Harran,” in *Mining the Archives: Festschrift for Christopher Walker on the Occasion of His 60th Birthday*, edited by Cornelia Wunsch [Dresden: ISLET, 2002], p. 193).

³⁷ Exodus 31:3–6.

³⁸ Cf. J. Black et al., eds., *A Concise Dictionary of Akkadian*, SANTAG 5 (Wiesbaden: Harrassowitz, 1999), s.v. *nakliš*; Porter, “Beds, Sex and Politics,” p. 530, dealing with Assurbanipal’s text regarding the bed for the sanctuary of Marduk and Zarpanitu; Grant Frame, *Rulers of Babylon: From the Second Dynasty of Isin to the End of Assyrian Domination, 1157–612 BC*, RIMB 2 (Toronto: University of Toronto Press, 1995), pp. 262–63, with respect to a table for the sanctuary of Marduk in the later reign of Aššur-etel-ilāni; CAD s.v. *nukkulu* usage a, in reference to Neo-Assyrian “bull colossi whose shapes are very *n*.”

³⁹ As per Michael Vickers and David Gill, *Artful Crafts: Ancient Greek Silverware and Pottery* (Oxford: Oxford University Press, 1996).

⁴⁰ This would not preclude an argument that, even without a word for “art,” Mesopotamian works meet the criteria for “art”—as discussed by Denis Dutton (“But they don’t have our concept of Art,” in *Theories of Art Today*, edited by Noel Carroll [Madison: University of Wisconsin Press, 2000], pp. 233–36)—including requisite skill, rules of form and fashioning, a critical language of judgment, consciousness of the “special” nature of the works and of charged experience for both producers and audiences. (In this, Dutton’s enterprise, to examine the status of “tribal” works, must be expanded to include all “others,” that is, non- as well as pre-Western enlightenment artistic production associated with state organization.)

⁴¹ I. J. Winter, “Aesthetics in Ancient Mesopotamian Art,” in *Civilizations of the Ancient Near East*, vol. 4, edited by Jack M. Sasson (New York: Scribner, 1995), p. 2572; Zainab Bahrani, *The Graven Image: Representation in Babylonia and Assyria* (Philadelphia: University of Pennsylvania Press, 2003).

periods of the Mesopotamian sequence,⁴² I would argue that a similar degree of investment is reflected in texts such as those of Sennacherib in which his building projects and technical achievements are recounted in detail. One important text in this regard has Sennacherib declare in the first person that he has recorded “every work which I had accomplished,” along with his military campaigns, the resultant account then placed in the foundation platform of his royal palace.⁴³ This sort of permanent record of achievement, I suggest, speaks no less clearly to the importance of royal undertakings than do the earlier year names.

Interestingly, many cultures and traditions stress skill as a value in both making and appreciation, coming quite close to what may be observed for Mesopotamia. In Classical Greece, for example, “well made” or “well worked” for the artifact and “well knowing” or “artful” for the artisan constitute positive attributes celebrated in poetry as well as in narrative and is ascribed as a compliment in the *Iliad* to a fine Phoenician silver krater of surpassing beauty, “made cunningly by Sidonians well skilled in deft handiwork.”⁴⁴

This notion of skill as the means to affect is attested in many pre-modern cultures, East and West: for example, in the arts of Islam, where sources frequently link skill to the production of beauty (e.g., “a skillfully-crafted fountain [in Ottoman Istanbul] of unique beauty”).⁴⁵ Today, we may assess such works as consistent with a special category we would designate “art,” but I believe it is important to distinguish our classification system from “theirs,” whoever the “they” may be.

Certainly, for ancient Mesopotamia, workmanship labeled “artful,” “skillful,” “masterful,” and/or “ingenious” speaks to the knowledge, inspiration, and inventiveness deemed characteristic of the best makers or the most charged works issuing from the creative process. Appreciation of that very artfulness or ingenuity is then incorporated into or claimed as part of the value inherent in the work itself. What I would stress is that the skill attached to the craftsman and the skill attributed to the work are not to be seen as separate phenomena, but rather manifest a reciprocal relationship between expert knowledge in making and what is perceived as expertise in appreciation. When positive attributes were ascribed to works in royal text, as in the pronouncements of Sennacherib and his scribes, it was clearly thought necessary to stress the quality of skilled production as part of the larger picture of aesthetic and cultural value. For this reason, I would further argue that “artful” rather than “artistic” actually reveals far more of the Mesopotamian/Assyrian value system and the expert knowledge that underlies it.

Attestations of skill—along with embellishment and perfection—thus become part of the ontology of the specially-worthy made thing, the “masterwork.” They represent necessary attributes of works that qualify as “great.” As noted above, accounts of such works often close with overall assessments that the project was either “perfect” or “fitting and splendid.” The claims of rulers, particularly Sennacherib, that they made/had made splendid or perfect works in the course of their reigns is explicitly linked in textual descriptions to both skilled knowledge and masterful execution. In the end, to be deemed fitting, splendid, and/or perfect, works produced by the king and by or for the gods *had* to manifest artful craft, skill, and expertise.

⁴² For example, Marcel Sigrist, *Isin Year Names*, Institute of Archaeology Publications, Assyriological Series 2 (Berrien Springs: Andrews University Press, 1988); Jack M. Sasson, “‘Year Zimri-Lim Offered a Great Throne to Shamash of Mahanum’: An Overview of One Year in Mari, Part I,” *M.A.R.I.* 4 (1985): 437–52; and “‘Year Zimri-Lim Dedicated His Statue to Addu of Halab’: Locating One Year in Zimri-Lim’s Reign,” *M.A.R.I.* 5 (1987): 577–89.

⁴³ Luckenbill, *Annals of Sennacherib*, p. 102:91–92.

⁴⁴ *Iliad* 23.740 ff.; see F. Frontisi-Ducroix, *Dédale: Mythologie de l’artisan en Grèce ancienne* (Paris: Maspero, 1975); Sarah P. Morris, *Daidalos and the Origins of Greek Art* (Princeton: Princeton University Press, 1992); and also Vickers and Gill, *Artful Crafts*.

⁴⁵ Shirine Hamadeh, “The City’s Pleasures: Architectural Sensibility in 18th Century Istanbul” (Ph.D. diss., M.I.T., 1999), p. 274 n. 132.

ARCHAEOLOGY AND STRATIGRAPHY

THE OCCUPATION LEVELS OF TELL TWEINI AND THEIR HISTORICAL IMPLICATIONS*

M. al-Maqdissi, M. Badawy, J. Bretschneider, H. Hameeuw, G. Jans, K. Vansteenhuyse, G. Voet, and K. Van Lerberghe

1. INTRODUCTION

The bay and plain of Jebleh (Syria)¹ have long been a crucial area for polities in the northern Levant (fig. 1). Most notably, it was a contested region between the kingdoms of Ugarit and Sianu in the fourteenth and thirteenth centuries B.C. The largest tell in this region, at over 11 hectares, is Tell Tweini (fig. 2). Before habitation shifted to the modern town of Jebleh in the later Iron Age, this city must have been a dominant settlement. During the Bronze Age, it commanded an excellent sheltered harbor, created by a sea incursion. Several springs next to the tell provided the necessary fresh water for the population. Recent palynological research suggests that the silting of this lagoon coincided with a shift of habitation closer toward the seashore.²

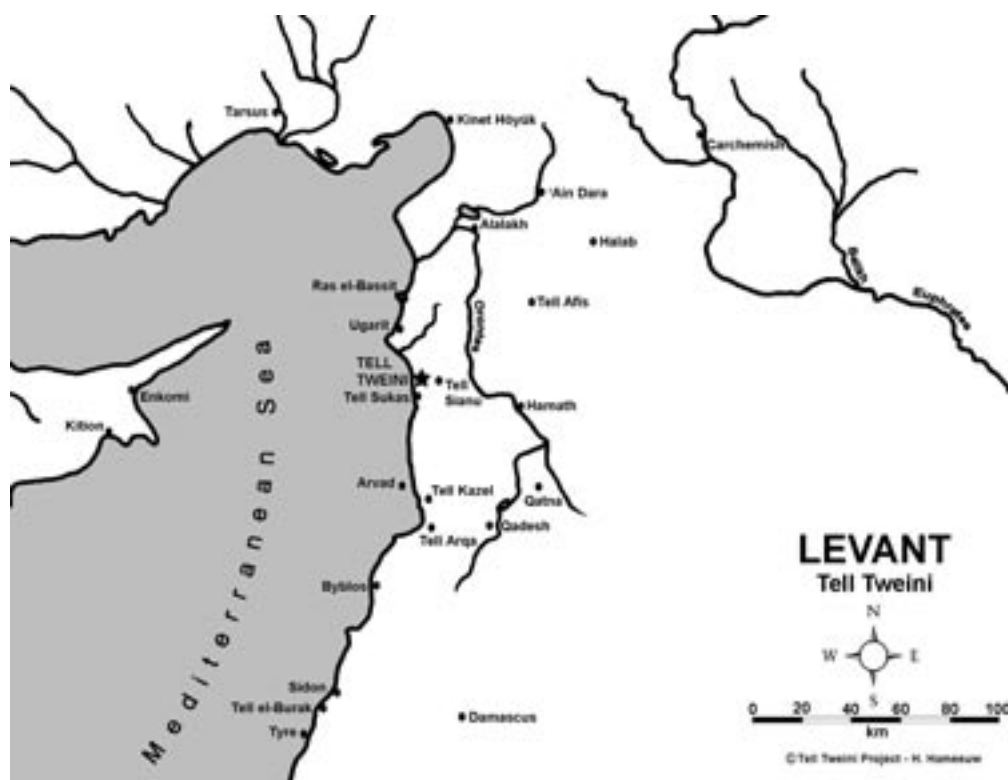

Figure 1. Map of the northern Levant — geographical location of Tell Tweini.

* The contents of this paper were presented as a poster at the 51st Rencontre Assyriologique Internationale: “Syro-Belgian Excavations at Tell Tweini, The Occupation Levels of Tell Tweini and Their Historical Implications.”

¹ Poul Jorgen Riis, Ingolf Thuesen, John Lund, and Thomas Riis, “Tall at-Tuwaini,” in *Topographical Studies in the Ġabla Plain*, Publications

of the Carlsberg Expedition to Phoenicia 13 (Copenhagen: The National Museum, 2004), pp. 27, 68–69.

² Preliminary conclusion, personal communication by David Kaniewski (Laboratorium voor Systematiek) and Etienne Paulissen (Fysische en regionale geografie), Katholieke Universiteit Leuven, spring 2005.



Figure 2. Aerial view of Tell Tweini (from Yves Calvet and Geneviève Galliano, *Le royaume d'Ougarit: Aux origines de l'alphabet* [Lyon: Musée des Beaux-arts, 2004], p. 60).



Figure 3. Field A, general view (photo by B. Vandermeulen).

One of the aims of the archaeological research project at Tell Tweini³ is to gather knowledge about the transition between the Late Bronze Age and the Iron Age. At that time, Tell Tweini formed part of the Ugaritic kingdom and thus it must have been influenced by the sudden and drastic destruction of the capital. The project attempts to understand the stratigraphy of the settlement at that time. It aims to achieve the same for the later Iron Age, when it is believed that habitation shifted to the location of the present-day city of Jebleh.

THE EXCAVATIONS

Since the project started in 1999, three excavation fields have been opened. In field B several phases of a main Iron Age temple have been excavated and in field C parts of the massive ancient city wall have been unearthed. This paper will focus on the results of Belgian excavations in field A (fig. 3). A total of nine main occupation levels have been distinguished and some of these have been divided into sublevels based on stratigraphical data. Each level consists of a construction and one or more occupation phases (e.g., Level 7A–B–C; 7C is the construction phase of two occupation phases, 7A and 7B; fig. 4). The subject of this study is the Late Bronze Age II and Iron Age I and II levels, which constitute an interesting sequence in the occupation history of Tell Tweini and whose interpretation contributes to our understanding of the history of the region. Many structures in Level 7B (Late Bronze II) are deserted and only reoccupied in Level 6A (Iron Age II), in contrast with Ras Shamra where the destruction of the Late Bronze Age settlement led to the final abandonment of the site. At Tell Tweini, one may speak of limited occupation during Level 6C (or Iron Age I). This will be illustrated by a brief overview of the archaeological finds and architectural remains of Levels 7 and 6.

OCCUPATION LEVELS — TELL TWEINI — FIELD A		
Level 1		Modern
Level 2		Byzantine–Islamic
Level 3		Hellenistic–Roman
Level 4	A	Iron Age III
	B	
Level 5	A	Iron Age II
	B	
Level 6	A	Iron Age II
	B	
Level 6	C	Iron Age I
	D	
Level 7	A	Late Bronze Age II–Iron Age I
Level 7	B	Late Bronze Age II
	C	
Level 7	D	Late Bronze Age I
	E	
Level 8	A	Middle Bronze II–Late Bronze Age I
Level 8	B	Middle Bronze Age II
	C	
Level 8	D	Middle Bronze Age I
	E	
Level 9	A	Early Bronze Age IV
	B	

Figure 4. Occupation levels — Tell Tweini — Field A. Light gray = occupation phase; dark gray = construction phase.

³ The excavations are part of the Jebleh Project directed by Prof. Dr. Michel Al-Maqdissi (Directorate-General of Antiquities and Museums, Syria) and Prof. Dr. Karel Van Lerberghe (Katholieke Universiteit Leuven, Belgium). Since 1999 the field directors are Mr.

Massoud Badawy and Prof. Dr. Joachim Bretschneider. The Jebleh Project is part of the Belgian Program on Interuniversity Poles of Attraction, inaugurated by the Belgian State Prime Minister's Office for Science Policy Programming (IAP V/14).

2. LATE BRONZE AGE II AND IRON AGE I-II OCCUPATION LEVELS

LEVEL 7B–C

The architectural remains of Level 7C are well preserved and cover the entire excavated area of field A. Three main structures can be distinguished, the largest of which, House 2, was built on terraces connected by a stairway (fig. 7a, Room 2/8). The difference in height between the two parts of House 2 is two meters. In House 3, an elaborate doorway between Rooms 6/2 and 6/1 may be part of a large (non-domestic) building.

The ceramic material from Level 7B consists of a wide range of local wares, such as “Canaanite” storage jars, plain plates with rounded rims, bowl lamps, and wall brackets. A diverse corpus of imported ceramics was found including Cypriot base-ring ware II, red lustrous wheelmade ware, red-on-black ware, white slip II, and Late Helladic IIIA and B sherds. In locus TWE-A-00185 in Room 2/9 (fig. 7a), some of these ceramics were preserved in situ: for example, a Late Helladic IIIB kylix decorated with shell motifs⁴ (fig. 5: 1) and a vessel in so-called handmade burnished ware (Fabric 3B at Tell Tweini), which is also a feature of the last phase of the Late Bronze Age at Tell Kazel (fig. 5: 2).⁵ The locus was sealed by a destruction layer ending the Late Bronze Age occupation in this part of the tell, which may be dated to the second half of the thirteenth century B.C.



Figure 5. Late Bronze Age IIB ceramics. (1) TWE-A-00185-024 and (2) TWE-A-00185-023 (photo by B. Vandermeulen).



Figure 6. Early Iron Age I ceramic vessel TWE-A-01717-C-001 (photo by B. Vandermeulen).

LEVEL 7A

The transition between the Late Bronze Age and Iron Age I at Tell Tweini is well preserved in Houses 2 and 3. Destruction by fire has been attested in only a limited number of loci and most structures seem simply to have been abandoned.

LEVEL 6C–D

There are fewer architectural structures in this level (Iron Age I) compared to Level 7B–C (Late Bronze Age II). In some places on the tell, new structures were erected. These generally have a slightly different orientation even though some 7C walls, for example, TWE-A-W01401, were partly reused as foundations in Level 6D, such as in the case of TWE-A-W01601 (fig. 7b). An interesting example of this is Room 3/1. The 7C walls and installations were largely removed in Level 6D, but TWE-A-W01956 (7C) was partly overbuilt by TWE-A-W01907 (6D) and partly demolished. As a result of this activity a dump with Late Bronze material was formed outside Iron Age I House 3, just below the Iron Age II street level.

⁴ Jacques-Claude Courtois and Liliane Courtois, “Corpus céramique de Ras Shamra-Ugarit, niveau historique, Deuxième partie,” in *Ugaritica 7*, edited by Irène Schaeffer de Chalon and Antoinette Schaeffer-Boehling, Mission de Ras Shamra Tome XVIII (Paris: Mission Archéologique de Ras Shamra, 1978), p. 307, fig. 36: 1, Inv. 27.744.

⁵ Leila Badre and Eric Gubel, “Tell Kazel (Syria): Excavations of the AUB Museum, 1993–1998, Third Preliminary Report,” *Berytus Archaeological Studies* 44 (1999–2000): 198.

The ceramics from Level 6C are, at present, limited in number and variety. Predominant among these are black and orange burnished craters and a large collection of footed cups, most of which were found in situ in Room 3/3 (TWE-A-F00027/02124). The walls of Level 6B were built directly on top of these loci, sealing the end of Iron Age I. Other craters, decorated in black and red colors with hourglass motifs, hatched triangles, and wavy lines (fig. 6), continue the Late Bronze Age tradition but can be dated to Iron Age I (see Ras Ibn Hani)⁶ or 1100–825 B.C. (see Tell Kazel).⁷ This suggests that at Tell Tweini, this tradition continued into the ninth century B.C. The craters were mainly found in large fill layers (House 1), which are suggestive of a reorganization of the settlement, probably in the second half of the ninth century B.C.

LEVEL 6A–B

Whereas in Iron Age I, architectural remains are few, during Iron Age II they are abundant. House 2 from Level 6C was enlarged and several new structures were built. Important is the reuse of some Late Bronze Age II stone paved floors (TWE-A-F04209 and F00428; fig. 7c). For the construction of House 1, some Level 7C walls of House 2 were removed by the cutting of deep foundation trenches. Other Late Bronze II walls were used as foundations directly below new walls, as for example in Houses 4 and 5. Most impressive is House 1, which is well constructed and comprises multiple rooms, up to 50 m² in size.

Typical ceramics from Level 6A include pear-shaped storage jars,⁸ red painted plates with rounded rim, and an increasing number of Cypriot imports (white painted, black slip) and local imitations of the latter. A fabric (Fabric 3A) with gray core and walls is relatively popular in this level and was exclusively used for hole-mouth vessels (cooking pots?). The decorative patterns on craters and storage jars are now restricted to Cypriot motifs such as winged lozenges or simple bands and lines. The ceramic material remains very similar in Level 5, even though the transition from Level 6 to Level 5 is marked by an architectural change. Level 6A ended near the end of the eighth century B.C. without an apparent destruction or break in habitation.

3. GEOPHYSICAL SURVEY

During the 2004 season, a geophysical survey was conducted in order to place the excavated architectural remains in a wider urban context (fig. 8).⁹ The geomagnetic results show the city plan of the ninth–eighth century B.C. (Level 6A–B). Dominant on the plan are several large urban (possibly public) structures.

Two main street orientations are distinguishable. The first is axial with a central street running from the southeast, where the main entrance gate of the city must have been located, to the northwest, where the ancient temple area is currently being excavated as field B. The Iron Age II residential area, in field A, was connected with this central passage by an excavated street (fig. 7c). A second street orientation follows the shape of the tell and has therefore been termed radial. The radial street crosses the central street twice and passes along the edges of the highest parts of the tell.

4. HISTORICAL IMPLICATIONS

The Late Bronze Age II occupation levels (7A–B–C) comprise a wide variety of architectural constructions and, in addition to a range of local ceramics, imports from all over the eastern Mediterranean. Among the more remarkable small finds are several seals from the Middle and Late Bronze Age and a Hittite-Luwian hieroglyphic inscription from a Late Bronze Age II context. The material culture of Late Bronze Age Tweini suggests a web of international relations. In the fourteenth/thirteenth century B.C., Tweini, most probably ancient Gibala, formed part

⁶ Adnan Bounni, Elisabeth Lagarce, Jacques Lagarce, and Nassib Saliby, “Rapport préliminaire sur la première campagne de fouilles (1975) à Ibn Hani (Syrie),” *Syria* 53 (1976): 276, fig. 27.

⁷ Badre and Gubel, “Tell Kazel (Syria),” p. 133.

⁸ Marie-Louise Buhl, *Sūkās 7: The Near Eastern Pottery and Objects from the Upper Strata*, Publications of the Carlsberg Expedition to Phoenicia 9 (Copenhagen: The National Museum, 1983), fig. 4.38.

⁹ Conducted by Glese, Grubert, & Hübner – Freiburg, Germany.

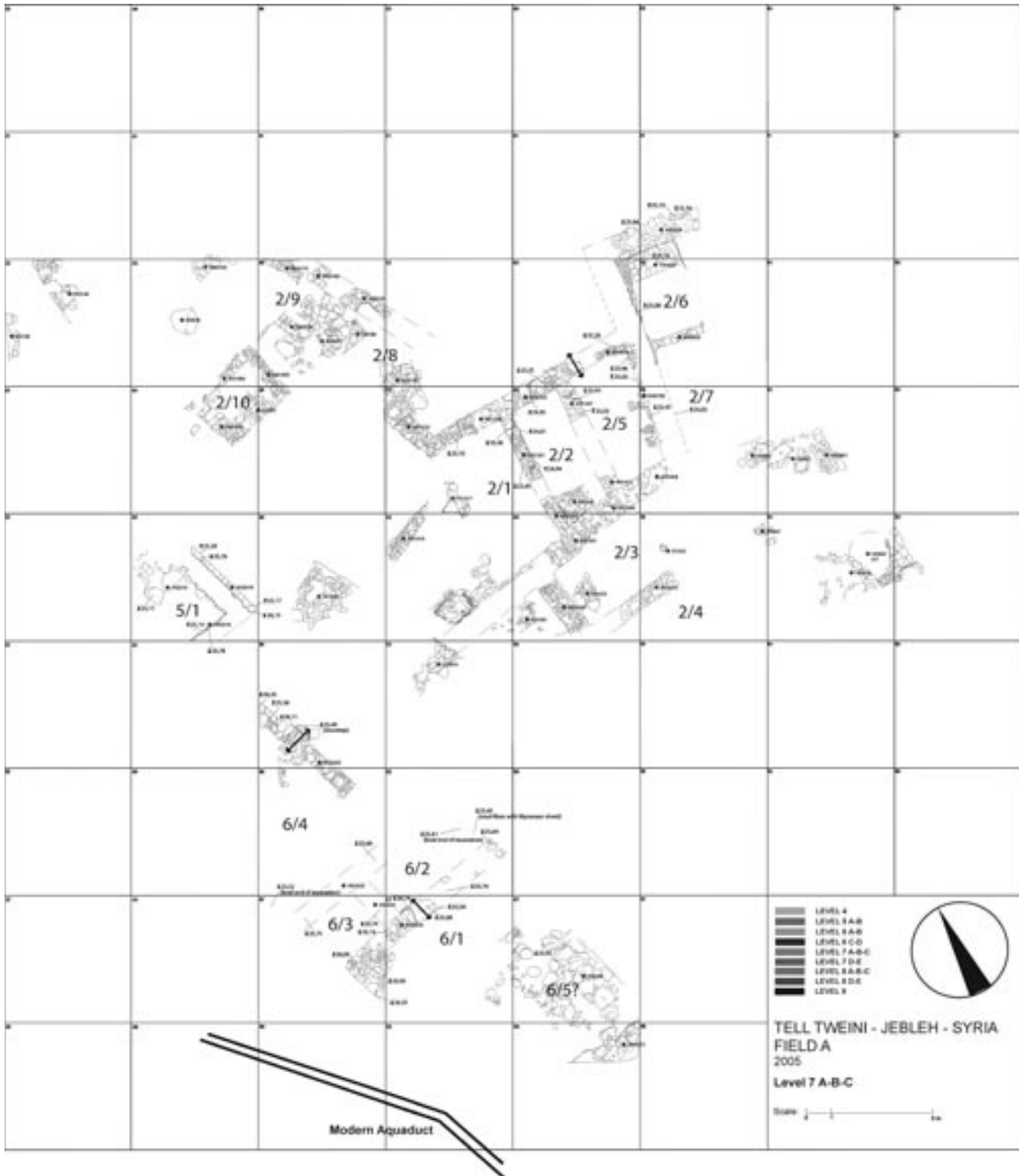

Figure 7a. Architectural plans — sequence of occupation from Late Bronze Age II through Iron Age II (plans by K. H. Bäumlér, H. Hameeuw, S. Saleh, and B. Verstraete).

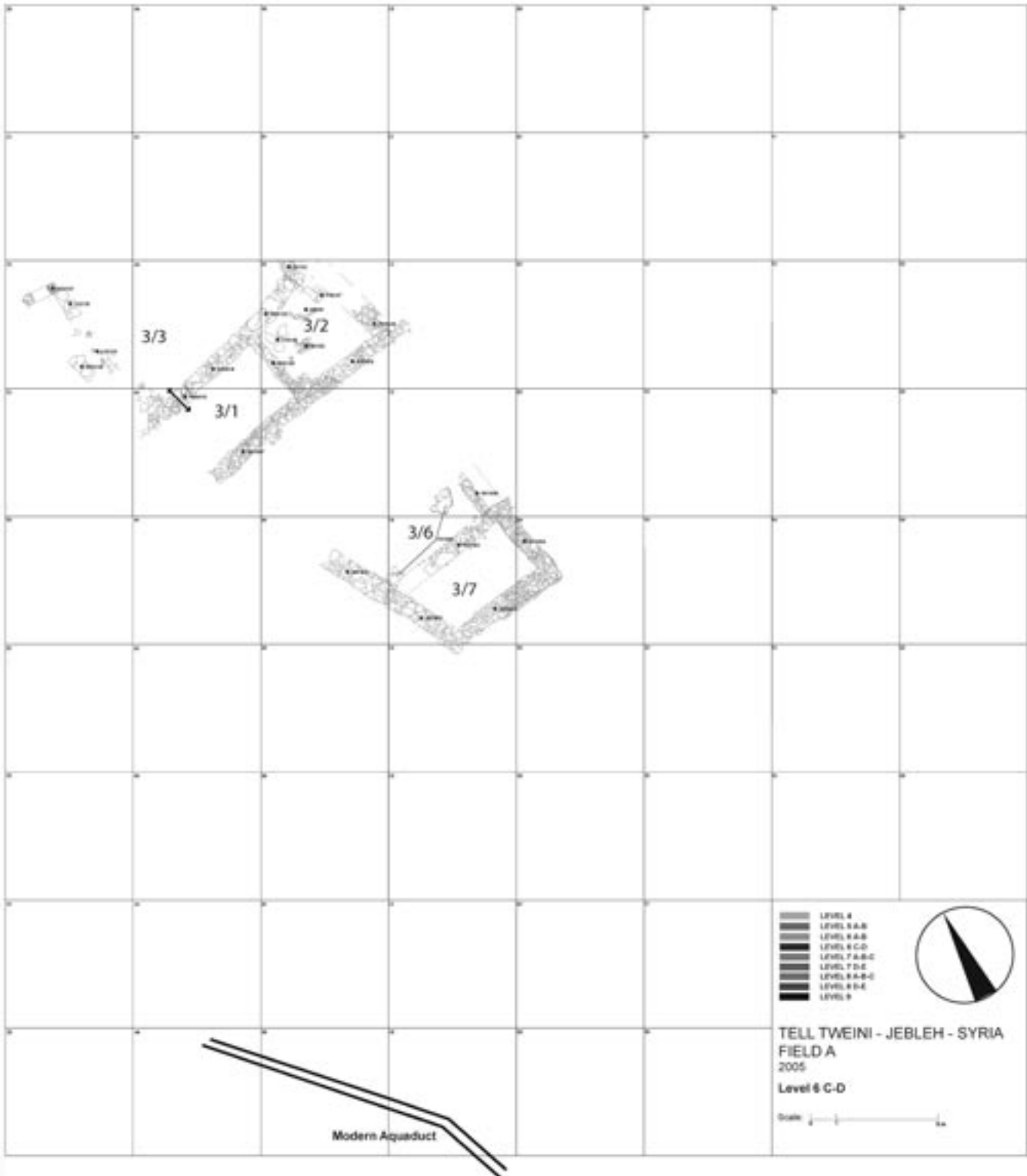

Figure 7b. Architectural plans — sequence of occupation from Late Bronze Age II through Iron Age II (plans by K. H. Bäumlér, H. Hameeuw, S. Saleh, and B. Verstraete).

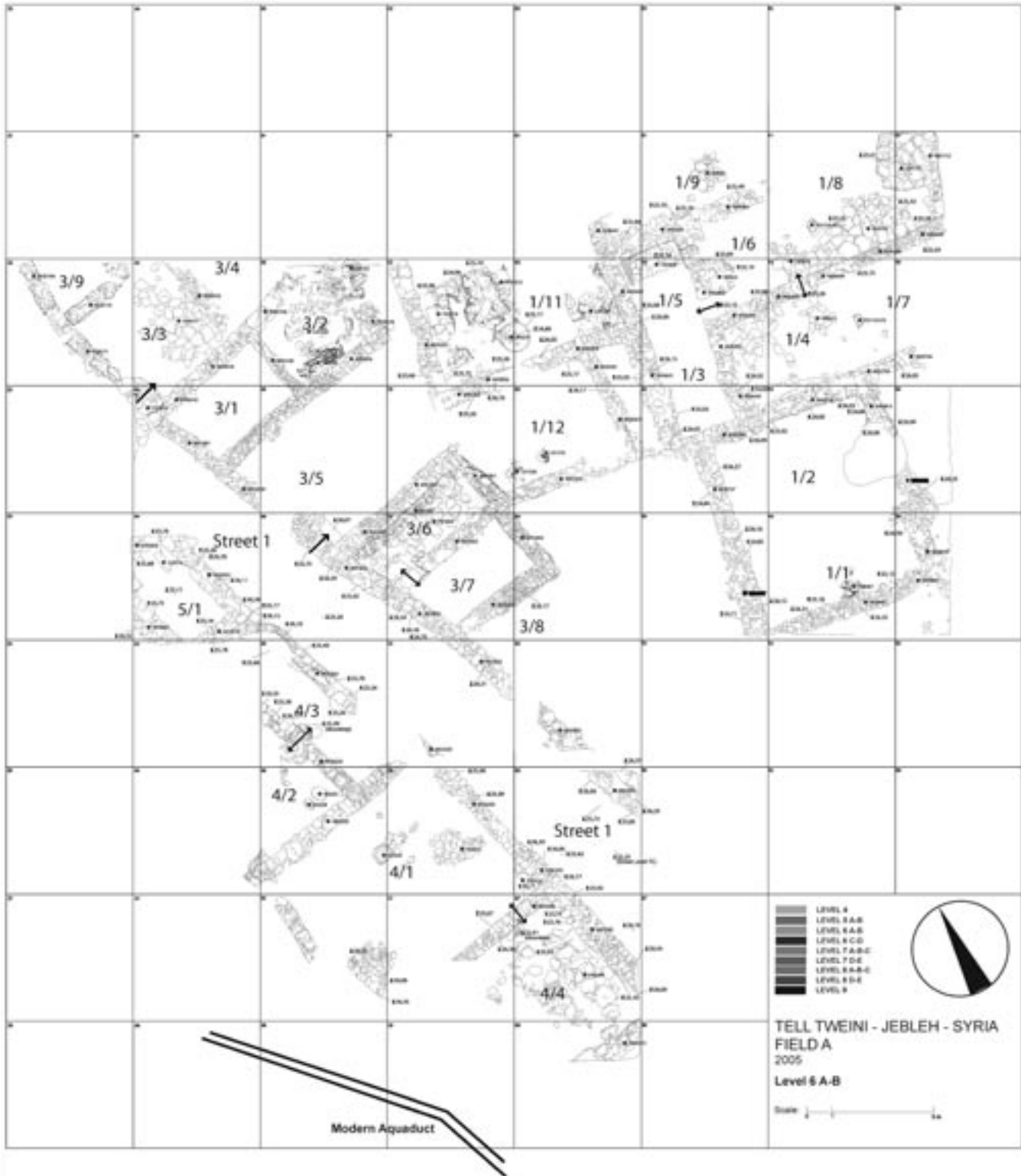

Figure 7c. Architectural plans — sequence of occupation from Late Bronze Age II through Iron Age II (plans by K. H. Bäumlér, H. Hameeuw, S. Saleh, and B. Verstraete).

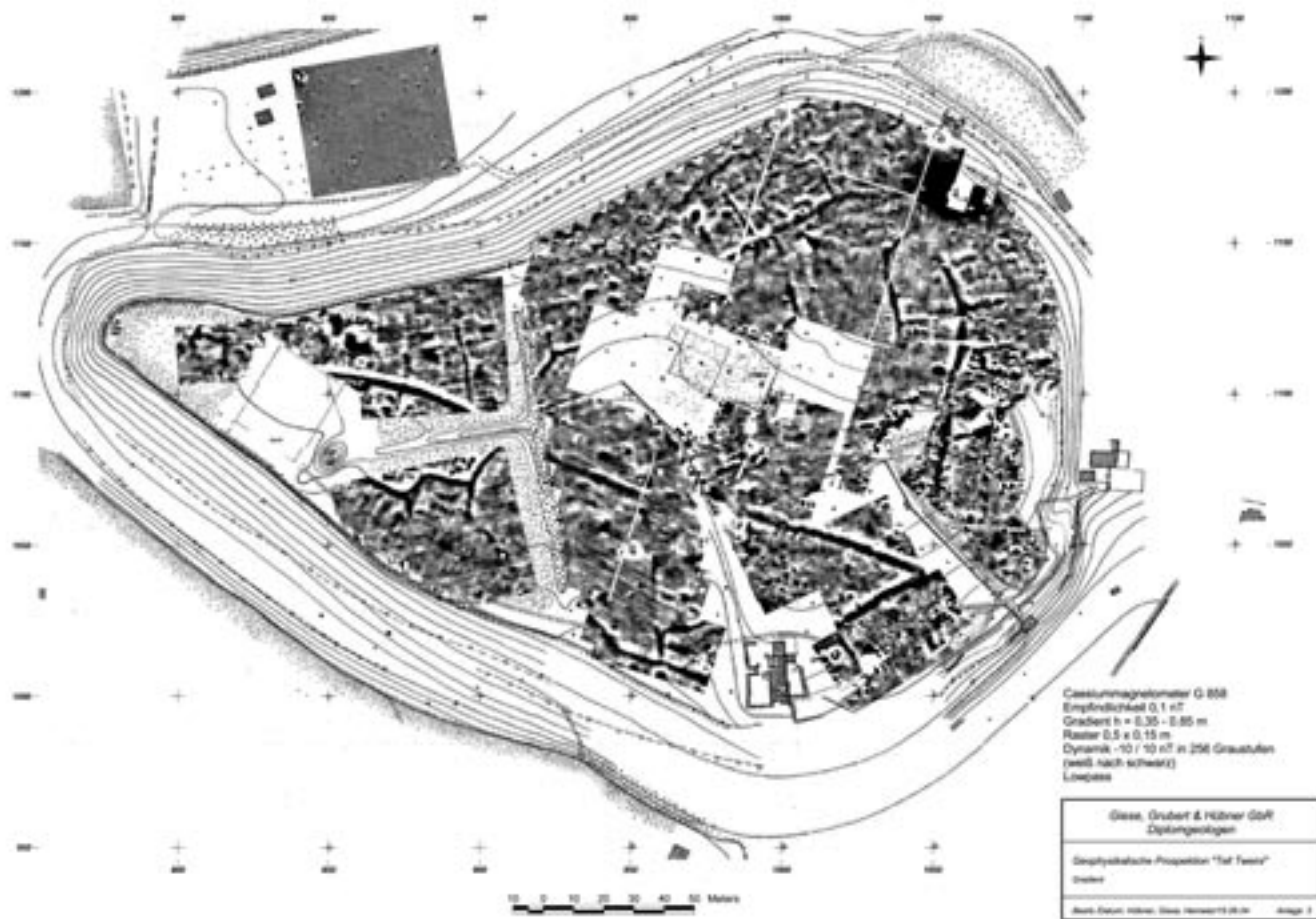

Figure 8. Results of the geophysical survey.

of the Ugaritic kingdom and was located at its southwestern border.¹⁰ In the archives of Ugarit, Gibala is mentioned in the treaty between the Hittite king Mursili II and Niqmepa, king of Ugarit.¹¹ Around 1200 B.C. the state of Ugarit, and most of the ancient Near Eastern networks of the Late Bronze Age, collapsed because of the invasion of the so-called Sea Peoples. Massive destruction layers of the Sea Peoples have not yet been found at Tweini, even though some floors showed traces of burning.

In the following period of decline during Iron Age I, only poor architectural features are attested at Tweini. It would appear that the city underwent a process of limited continuity and reoccupation of Late Bronze Age structures similar to that observed at other Syrian coastal settlements at the end of the second millennium, such as Ras ibn Hani,¹² Ras el-Bassit,¹³ Tell Kazel,¹⁴ and Tell Sukas.¹⁵ At Tweini, the earliest Early Iron Age I reoccupation is founded on the remains of Late Bronze Age structures and reuses several walls.

Due to the limited nature of the archaeological evidence, information on urban development at the beginning of the Iron Age is restricted. Throughout Iron Age I the tell seems to have been only partially inhabited, as shown by the first construction phase of House 3 (fig. 7b). For the end of Iron Age I, several occupation floors are attested and a large variety of ceramics and objects were found in situ¹⁶ (Room 3/3). Whether this discontinuity of habitation is a result of intentional destruction is not clear. At around the same time, in the middle of the ninth century B.C., the Temple Area at nearby Tell Kazel burned down¹⁷ and at Tell Sukas similar destruction is ascribed to the Assyrians,¹⁸ who campaigned repeatedly in coastal Syria between 858 and 844 B.C. After the mid-ninth century B.C., the urban plan of Tweini was profoundly changed. New, big houses are constructed directly above the Late Bronze Age remains. A new city plan with large streets and both public and private buildings is laid out across the entire tell. The revival of urban culture at Tweini and in the coastal region of Northern Phoenicia may be linked to a developing economic network connecting Cyprus, Phoenicia, and the Syrian interior. Imports of Cypriot ceramics at Tweini attest to this improving economic situation.

¹⁰ Joachim Bretschneider, Michel Al-Maqdissi, Klaas Vansteenhuyse, Jan Driessen, and Karel Van Lerberghe, "Tell Tweini, Ancient Gabala, in the Bronze Age," *Ägypten und Levante* 14 (2004): 219–20; and Wilfred van Soldt, *The Topography of the City-State of Ugarit*, Alter Orient und Altes Testament 324 (Münster: Ugarit-Verlag, 2005), pp. 64–71, 88–91.

¹¹ RS 17.235+335+344!+379+381+457 and PRU 4, pp. 71–76.

¹² Adnan Bounni, Elisabeth Lagarce, and Jacques Lagarce, *Ras Ibn Hani I: Le Palais Nord du Bronze Récent, Fouilles 1979–1995, synthèse préliminaire*, Bibliothèque Archéologie et Historique 151 (Beirut: Institut français d'archéologie du Proche-Orient, 1998), p. 101.

¹³ Paul Courbin, "Bassit," *Syria* 63 (1986): 187.

¹⁴ Leila Badre and Eric Gubel, "Tell Kazel (Syria)," p. 198; Emmanuelle Capet, "Tell Kazel (Syrie), Rapport préliminaire sur les

9^e–17^e campagnes de fouilles (1993–2001) du Musée de l'Université Américaine de Beyrouth, Chantier II," *Berytus Archaeological Studies* 47 (2003): 117.

¹⁵ John Lund, "Tell Soukas," in *Le royaume d'Ougarit: Aux origines de l'alphabet*, Les dossiers d'archéologie 10 (Dijon: 2004), p. 63.

¹⁶ Joachim Bretschneider, Tim F. Cunningham, and Karel Van Lerberghe, "Gibala: The First Two Excavations 1999 and 2000," *Ugarit-Forschungen* 31 (2000): 109–11.

¹⁷ Leila Badre and Eric Gubel, "Tell Kazel (Syria)," pp. 197–98; and Emmanuelle Capet, "Tell Kazel (Syrie)," p. 117.

¹⁸ Poul Jorgen Riis, *Sūkās I: The North-east Sanctuary and the First Settling of Greeks in Syria and Palestine*, Publications of the Carlsberg Expedition to Phoenicia 1 (Copenhagen: The National Museum, 1970), p. 161.

POTTERY FROM THE ARCHAIC ISHTAR TEMPLES IN ASSUR*

Claudia Beuger, Deutsches Archäologisches Institut, Berlin

The recent study of pottery from Assur¹ dating to the late third to the first millennium B.C. is based on the finds made in two complexes: the so-called Archaic Ishtar Temples² and in a sounding near the west end of Trench 7 (“Suchgraben 7”).³ The aim of this study is, among others, to correlate these two excavation complexes with one another (table 1).

The lowest level **H** of the Archaic Ishtar Temples⁴ represents the oldest settlement layer in Assur and lies directly upon the natural rock. Pottery forms found there do not differ essentially from forms of the following level **G**, with the exception of three vessels, which unfortunately are only preserved in sketches from the field diary (fig. 1). However, the wide mouth of the vessel forms might serve as a criterion for distinguishing them from similar pots in level **G**.

In the following level **G** there was evidence of a conflagration in which a large find complex was preserved in situ. The last use and rebuilding of this temple structure—level **F**—are in close association with the earlier levels, as reflected in the ceramic material (see fig. 6).

However, the assignment of pottery from the following level **E** is problematic, because this level was disturbed by later building activities. Therefore, the sixteen diagnostic sherds found in level **E** do not provide a very satisfactory basis for dating. It should be emphasized that the dating of pottery from the period of the Third Dynasty of Ur often uses precisely this complex as support. One example is the interpretation of level VI at Tell Taya by Julian Reade.⁵ In dating this level Reade refers to Grave 6 (Ass. 2305, fig. 2),⁶ which however Arndt Haller⁷—in his catalogue of graves and tombs in Assur—assigned to a completely different context, the area of the Ziqurrat. For Walter Andrae⁸ the so-called shoulder vase (“Schultervase”), such as the large vessel in Grave 6, is the characteristic new form for the period of the Third Dynasty of Ur. The recent study shows⁹ that this kind of vessel in general is a characteristic form even in level **G-F**; for detail see below (figs. 7 and 8).

The upper, later levels **D-A** were evaluated anew by Jürgen Bär¹⁰ with reference to the stone foundation that Andrae¹¹ had assigned to the Temple of Shalmanasser III. Bär assigns the surfaces **D**, **C**, and **B** in the courtyard to

* I would like to thank Dr. Emily Schalk for generously translating this paper.

¹ The study is part of a doctoral thesis: C. Beuger, “Keramik der spätfrühdynastischen bis spätassyrischen Zeit aus Assur—Eine Bearbeitung unter chronologischen Gesichtspunkten” (Ph.D. diss., Freie Universität Berlin, 2005). This work is associated with the Assur-Projekt directed by Johannes Renger.

² Cf. W. Andrae, *Die archaischen Ishtar-Tempel in Assur*, Wissenschaftliche Veröffentlichungen der Deutschen Orient-Gesellschaft 39 (Leipzig: J. C. Hinrichs, 1922); J. Bär, *Die älteren Ishtar-Tempel in Assur, Stratigraphie, Architektur und Funde eines altorientalischen Heiligtums von der zweiten Hälfte des 3. Jahrtausends bis zur Mitte des 2. Jahrtausends v. Chr.*, Wissenschaftliche Veröffentlichungen der Deutschen Orient-Gesellschaft 105 (Saarbrücken: Saarbrücker Druckerei und Verlag, 2003).

³ The sounding was excavated under Reinhard Dittmann’s direction, Freie Universität Berlin, in the 1980s; cf. R. Dittmann, “Ausgrabungen der Freien Universität Berlin in Assur und Kār-Tukultī-Ninurta in den Jahren 1986–89,” *Mitteilungen der Deutschen Orient-Gesellschaft* 122 (1990): 157–71. Investigations there were last carried out in 2001 by the author with the kind permission of Peter Miglus; see C. Schmidt, “Grabungsabschnitt 4,” in P. A. Miglus et

al., “Assur—Herbstkampagne 2001,” *Mitteilungen der Deutschen Orient-Gesellschaft* 134 (2002): 26–33.

⁴ For stratigraphical details, see Andrae, *Archaische Ishtar-Tempel*, and Bär, *Ältere Ishtar-Tempel*.

⁵ J. E. Reade, “Tell Taya (1967): Summary Report,” *Iraq* 30 (1968): 255 n. 43.

⁶ Andrae, *Archaische Ishtar-Tempel*, pl. 60.

⁷ A. Haller, *Die Gräber und Gräfte von Assur*, Wissenschaftliche Veröffentlichungen der Deutschen Orient-Gesellschaft 65 (Berlin: Gebrüder Mann, 1954), p. 8. Haller’s description of the context is correct; cf. the “Fundjournal” of Assur.

⁸ Andrae, *Archaische Ishtar-Tempel*, pp. 105–06: “... Eine neue Form jedoch glauben wir als Erfindung der E-Zeit hinstellen zu müssen: Die von uns so genannte Schultervase, ...”; but in contrast see W. Andrae, *Das wiedererstandene Assur* (Leipzig: J. C. Hinrichs, 1938), p. 79: “... Die sogenannte große Schultervase, ... eine Form, die schon in die G-Schicht hinaufreicht, wird jetzt gang und gäbe...”

⁹ The rim (cf. Haller, *Gräber und Gräfte*, pl. 1b) is diagnostic for levels **G-F**; see below fig. 7.

¹⁰ Bär, *Ältere Ishtar-Tempel*, pp. 38, 79.

¹¹ W. Andrae, *Die jüngeren Ishtar-Tempel in Assur*, Wissenschaftliche Veröffentlichungen der Deutschen Orient-Gesellschaft 58 (Leipzig: J. C. Hinrichs, 1935), pp. 113–18.

Table 1. Correlation of the Two Excavation Complexes.		
	<i>Temples</i>	<i>Trench 7</i>
Late Early Dynastic?	H	—
Early Akkadian	G	IIIb5
Late Akkadian/Ur III	F (1–2)	IIIb4
Ur III/Isin-Larsa (Early Old Assyrian)	E (1)	IIIb3
Isin-Larsa/Old Assyrian	E (2)	IIIb2
Old Assyrian (Šamši-Adad I?)	D	IIIb1
Late Old Assyrian/Early Mittanian?	C	IIIa3
Mittanian	B	IIIa2
Middle Assyrian (until Tukulti-Ninurta I?)	A	IIIa1
Middle Assyrian	—	IIb4
Middle Assyrian (post-Tiglath-Pileser I / Aššur-bel-kala)	—	IIb3
Early Neo-Assyrian?	—	IIb2
Early Neo-Assyrian/Neo-Assyrian	—	IIb1
Neo-Assyrian (eighth–seventh century B.C.)	—	IIa2
Late Assyrian (seventh century B.C.)	—	IIa1
Post-Assyrian	—	IIa0

the massive building E. Only surface A was connected with the stone foundation, which according to him is closely associated with mudbrick building D. The pottery that was recorded from these levels came mainly from the courtyard, whereas apparently no ceramic finds were recorded from levels B and A. Presumably these levels were destroyed in the course of building the temple of Tukulti-Ninurta I.

Pottery from level C can be dated to around 1550 B.C. This would imply — according to Bär's stratigraphy — that building E was in use for a very long time, for over five hundred years; the stone foundation had one phase of use that lasted three hundred years.

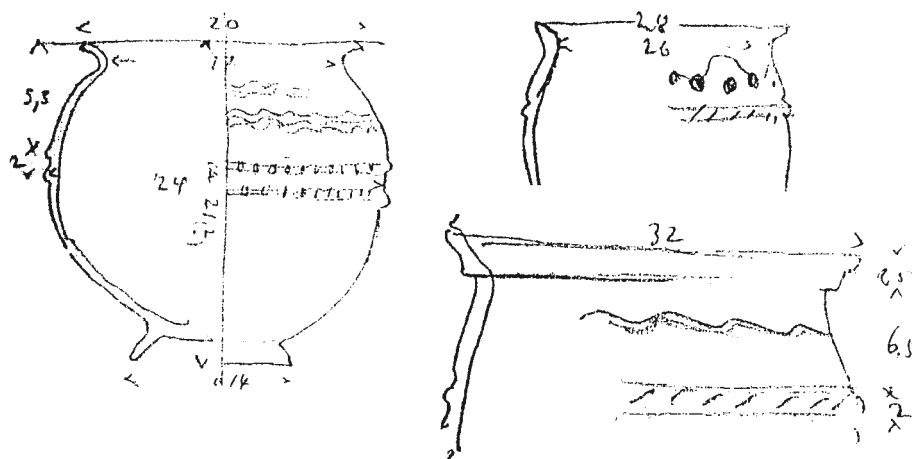

Figure 1. Pottery from level H. Field sketches.



Figure 2. Inventory of Grave 6 Ass. 2305 from W. Andrae, *Die archaischen Ishtar-Tempel in Assur*, pl. 60.

However, a few sherds (fig. 3) excavated directly from the stone foundation show a relationship to lower-lying structures with parallels among the material from the earlier levels E to C. Furthermore, in view of the elevations,¹² the floors C and B can be connected to the stone foundation rather than building E. Levels C or B–A would then complete the long duration of use of the stone foundation, from the late Old Assyrian (or early Mittanian) to the Middle Assyrian period.

There is no clear connection of the courtyard to the buildings, so nothing can be concluded about the length of time in which these temples were used.

The stratigraphic sequence in Trench 7 was determined by Paul Larsen.¹³ According to his study, a monumental building was erected in Neo-Assyrian times in the area, Larsen's **level IIa**. The demolition of this structure is presumably associated with the conquest of Assur at the end of the seventh century B.C., as evidenced by scattered human skeletal finds and perhaps the demolished walls. Only a few fragmentary architectural finds came to light in the following levels **IIb1–4**. Their foundation (level **IIb4**) is correlated with texts that have been ascribed by Ekhart Frahm¹⁴ to Olof Pedersén's Archive M7,¹⁵ which Andrae had already excavated. The archive in turn provides a *terminus post quem* for this level in the reign of Tiglath-Pileser I/Aššur-bel-kala.

A correlation (see table 1) between the levels of the Archaic Ishtar Temple is possible through the pottery complexes and the stratigraphic sequence after **level IIIa**. The latter is divided into three subphases: the founding phase **IIIa3**, the burnt horizon **IIIa2**, and the phase of decay **IIIa1**.

The oldest levels in Trench 7 (**IIIb1–5**) could only be exposed within a very small surface area. This applies especially to lowest level **IIIb5**. It remained in disuse a short time before resettlement. A burial indicates intermediate use in level **IIIb4**, then floors and a structure again appear in levels **IIIb3** and **b2**. The following level **IIIb1** founds upon these preceding walls.

¹² Andrae, *Archaische Ishtar-Tempel*, pl. 8a.

¹³ P. Larsen, *Die Stratigraphie und Architekturfunde: Bericht über die Ablagerungssequenzen in den Schichten III und II nach den von der Freien Universität Berlin durchgeführten Grabungen*, 1995 (unpublished manuscript).

¹⁴ E. Frahm, "Assur 2001: Die Schriftfunde," *Mitteilungen der Deutschen Orient-Gesellschaft* 134 (2002): 62.

¹⁵ O. Pedersén, *Archives and Libraries in the City of Assur: A Survey of the Material from the German Excavations*, part 1, *Acta Universitatis Upsaliensis, Studia Semitica Upsaliensia* 6 (Uppsala: Uppsala University, 1985), pp. 68 ff.

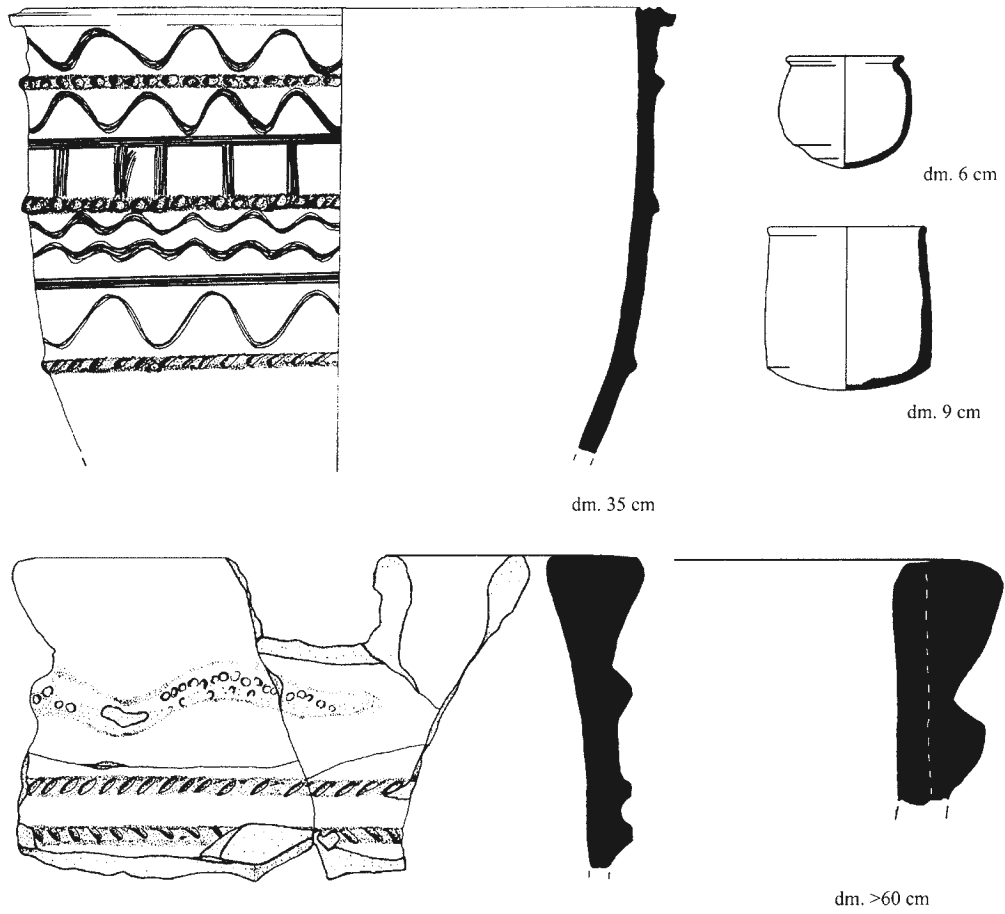

Figure 3. Pottery from the stone foundation.



Figure 4. Decorated bowls from levels G-F. Diameter 25-40 cm.

The majority of finds recovered from the sounding in Trench 7 was pottery from fills. Whereas the sixteen recognized levels or phases of use yielded more than 47,000 sherds, only 835 sherds could be evaluated for the Archaic Ishtar Temple. So-called diagnostic sherds are represented by only a small portion of the material, in the deep sounding in Trench 7 amounting to merely one-tenth.

When correlating the two excavation complexes the problem arose that some forms which were conspicuously frequent among the Temple pottery were sparse or even absent in the material from the sounding in Trench 7; the opposite situation was observed as well, possibly reflecting the different functions of the buildings. This applies especially to the large, decorated bowls with thickened rim, some with applied serpents (fig. 4). They are not present in the material from Trench 7, but, in contrast, are quite numerous in the Temple complex in level G as well as in level F.

Special note should be made of two double-mouthed bottles (fig. 5a) from level G, preserved only as sketches in a field diary. The bottles are without doubt comparable with finds of the late Early Dynastic, in particular the Akkad-period levels in Tell Yelkhi¹⁶ and Tell Brak.¹⁷ Joan Oates¹⁸ also assumes that these double-mouthed bottles had a function in a religious ritual context.

Differences in the pottery spectrum from levels G and F are hardly distinguishable (fig. 6). This is probably one reason that Andrae¹⁹ presented many of the pieces originally found in level F together with those in level G without any distinction. Whereas pottery from levels G and IIIb5 seem predominantly of Akkadian date, the statistical data for levels F and IIIb4 seem to fluctuate between the time of Akkad and the Third Dynasty of Ur.

One of the most important forms is the “shoulder vase,” characterized by a simple or notched cord on the shoulder and often a comb-stroked surface or simple painted dots. While the form and surface treatment remained rather the same, a typological development in the rim could be followed. Characteristic for levels G–F is the slightly out-curving rim with a blunt lip (fig. 7). Only these older variations are painted with symbols. In levels D–C the massive rim with triangular section and often a shorter shoulder emerges (fig. 8). Findings in Trench 7 have shown that the highest proportion of these later variations lies in level IIIb2, where conditions for preservation were better than in temple E.

A conspicuous feature in the comparison of levels E–C with level III and its subphases was the appearance of bands of horizontal grooves on the upper rim of large deep bowls as well as on the upper body of carinated bowls and beakers (fig. 9). This feature is absent in the preceding levels G–F and in IIIb5–4. Although finds were very sparse in the following level E, a few sherds display these characteristic bands of grooves and find analogies in Ur III to Old Assyrian contexts from Emar to Uruk.²⁰

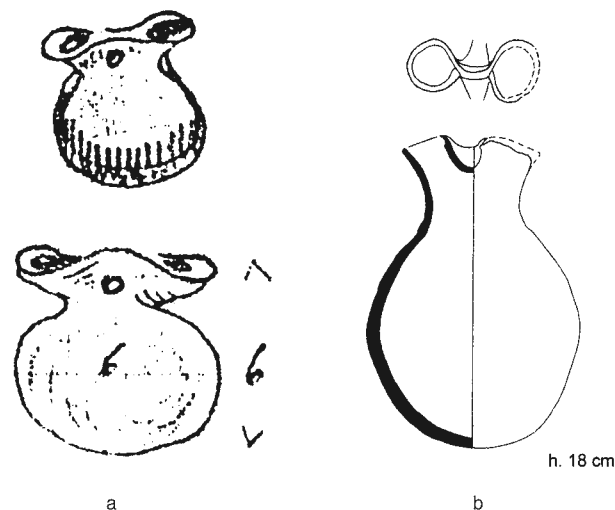

Figure 5. Double-mouthed bottles from level G.
(a) Sketches from the field diary; and
(b) R. Matthews, *Tell Brak*, vol. 4, fig. 6.55:13.

¹⁶ G. Bergamini et al., “La Ceramica di Tell Yelkhi,” *Mesopotamia* 37–38 (2002–2003): pls. 10 and 26.

¹⁷ R. Matthews, ed., *Excavations at Tell Brak*, vol. 4, *Exploring an Upper Mesopotamian Regional Centre, 1994–1996* (London: British School of Archaeology in Iraq; Cambridge: McDonald Institute for Archaeological Research, 2003), p. 199, fig. 6.8 (= 235 fig. 6.55:13); D. Oates et al., *Excavations at Tell Brak*, vol. 2, *Nagar in the Third Millennium B.C.* (London: British School of Archaeology in Iraq; Cambridge: McDonald Institute for Archaeological Research, 2001), p. 181, fig. 211.

¹⁸ Oates, *Tell Brak*, vol. 2, p. 182.

¹⁹ E.g., Andrae, *Archaische Ishtar-Tempel*, pls. 22–24.

²⁰ Emar: U. Finkbeiner, “Emar 1999—Bericht über die 3. Kampagne der syrisch-deutschen Ausgrabungen,” *Baghdader Mitteilungen* 32 (2001): 53, fig. 5h; C. Falb, “Frühbronzezeitliche Keramik aus Emar,” *Baghdader Mitteilungen* 32 (2001): fig. 2.6. Ebla: P. Matthiae, *Ebla:*

Un impero ritrovato (Turin: G. Einaudi, 1977), fig. 36.3. Mari: A. Parrot, *Le temple d’Ishtar, Mission Archéologique de Mari*, vol. 1 (Paris: P. Geuthner, 1956), pl. 72,510; N. Pons, “Les principales formes de poterie mariote de l’époque des šakkanakku à la chute de la ville sous Zimri-lim: Rapports avec la Babylonie,” *Akkadica* 114–15 (1999): “Groupe 9.” Tell Taya: Reade, “Tell Taya,” pl. 87,28. Tell Rimah: C. Postgate et al., *The Excavations at Tell al Rimah: The Pottery*, Iraq Archaeological Reports 4 (London: British School of Archaeology in Iraq, 1997), pl. 89,1040. Uruk: M. van Ess, “Keramik von der Akkad- bis zum Ende der altbabylonischen Zeit aus den Planquadraten N XV und XVI und aus dem Sinkāšid-Palast in Uruk-Warka,” *Baghdader Mitteilungen* 19 (1988): fig. 7.72; M. van Ess, “Die Keramik: Die Typen und ihre Verbreitung nach Zeitstufen, Akkad-bis altbabylonische Zeit,” in *Uruk, Kampagne 35–37, 1982–1984: Die archäologische Oberflächenuntersuchung (Survey)*, edited by Uwe Finkbeiner, *Ausgrabungen in Uruk-Warka, Endberichte* 4 (Mainz am Rhein: Philipp von Zabern, 1991), pl. 107,35.

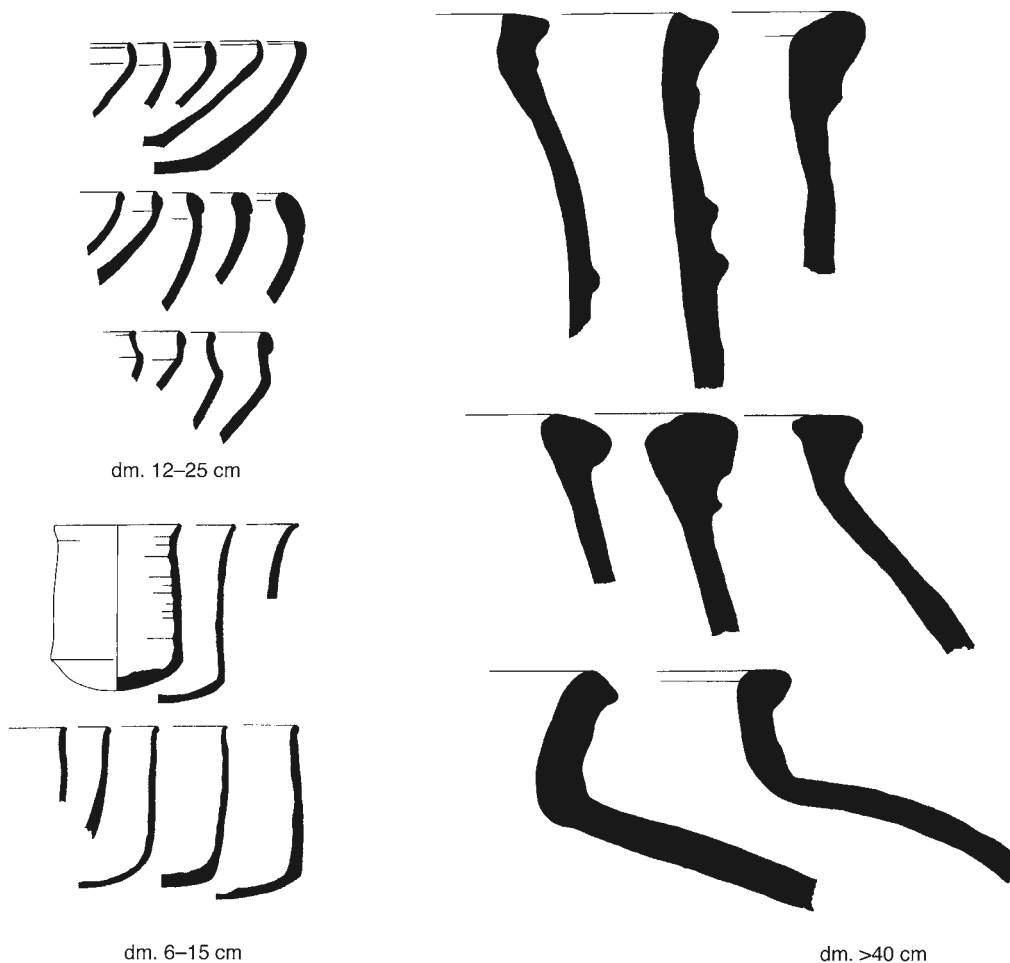

Figure 6. Typical forms from levels G-F/IIIb5-4.

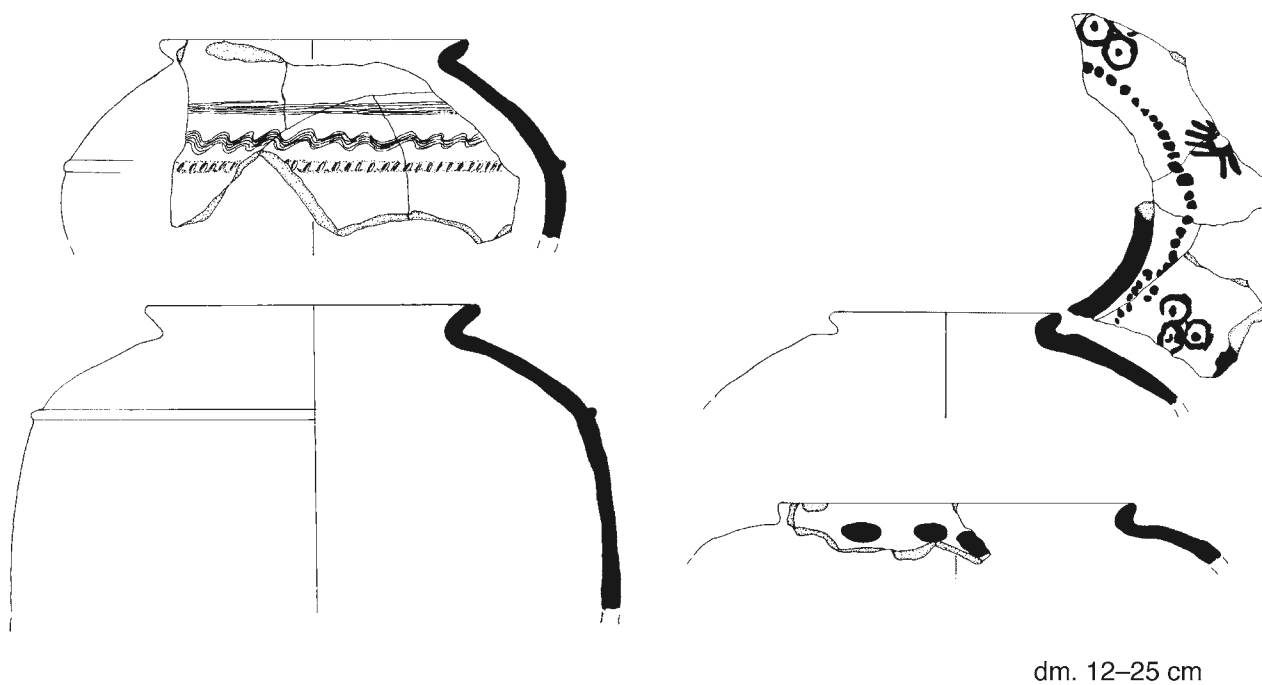

Figure 7. Characteristic "shoulder vases" of levels G-F/IIIb5-4.

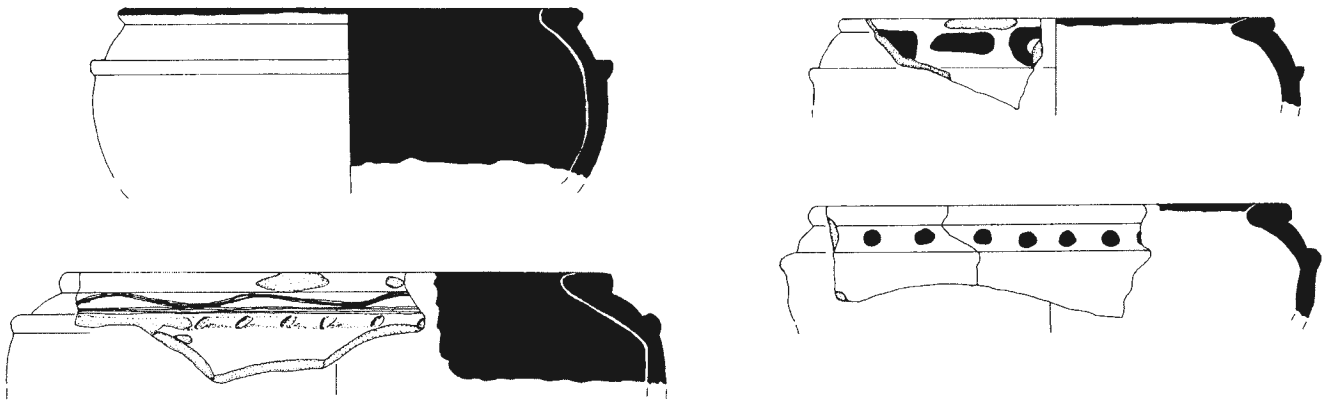

Figure 8. Characteristic “shoulder vases” of levels E-C/IIIb3–IIIa3. Diameter 12–25 cm.

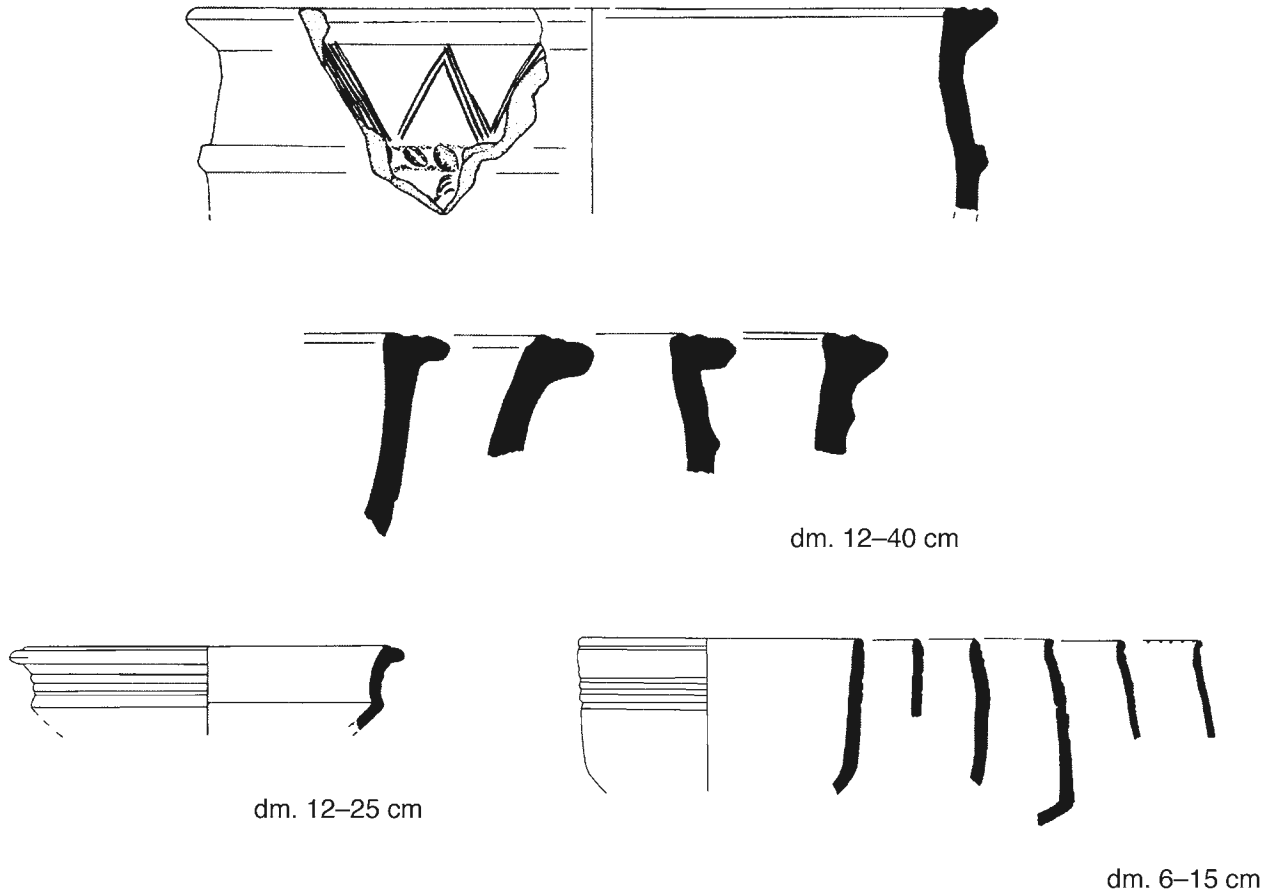

Figure 9. Typical forms with grooves from levels E-C/IIIb3–IIIa3.

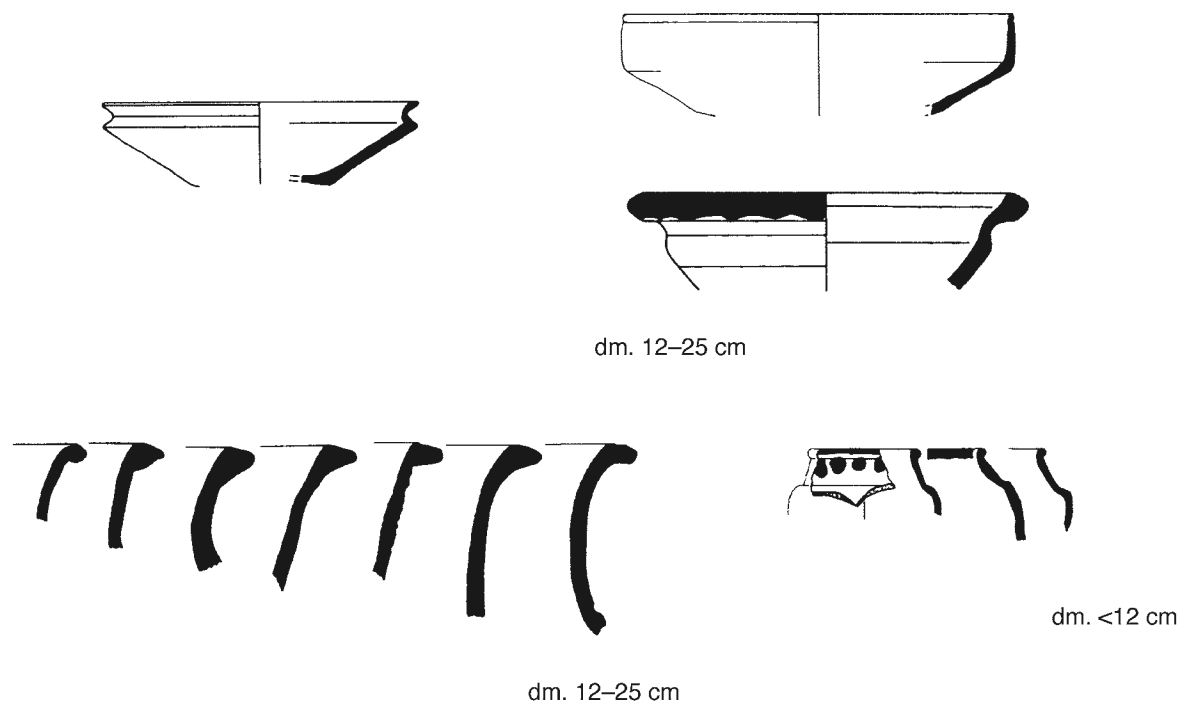

Figure 10. Typical forms from levels D-C/IIIb1-a3.

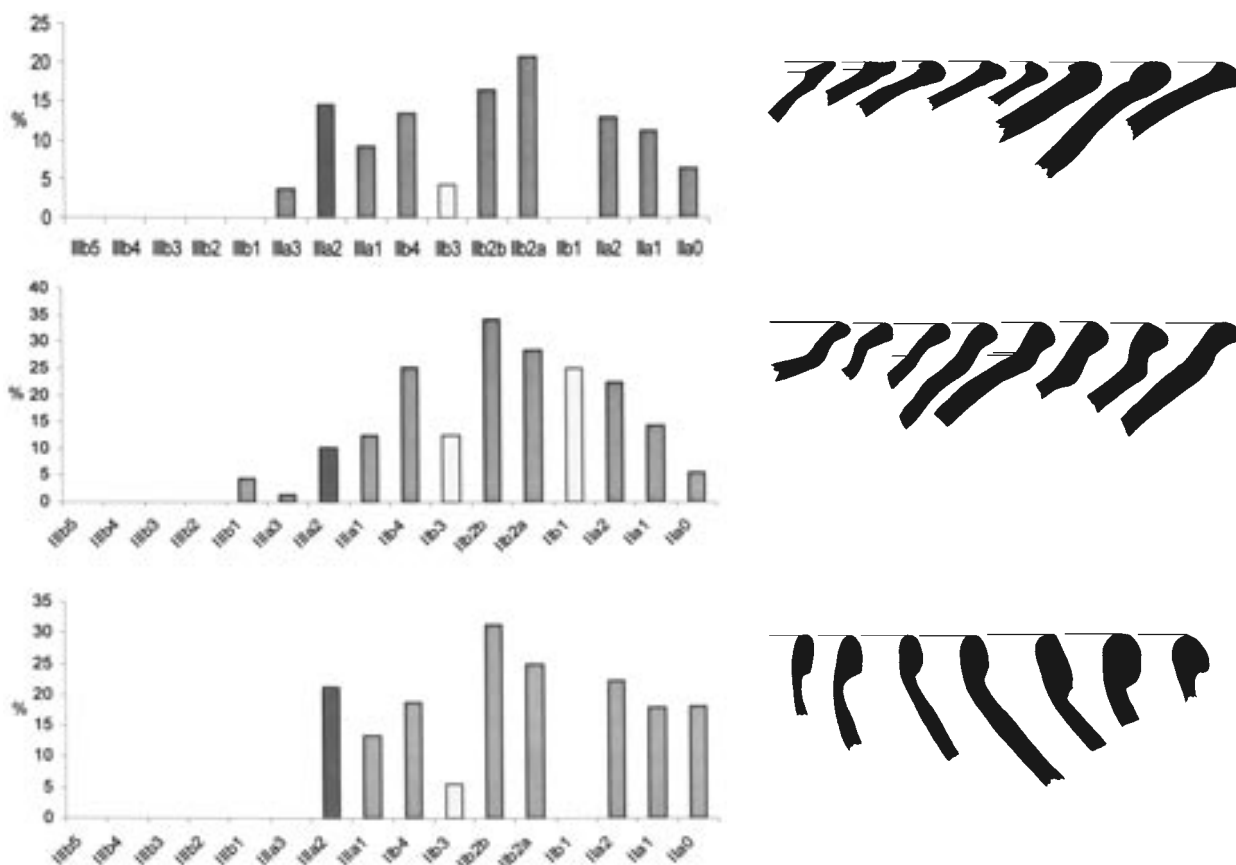

Figure 11. Typical forms from levels IIIa2-IIIb2. Diameter 12-25 cm.

The maximal count of conical bowls with concave neck and simple rim (fig. 10) found mostly in the Old Assyrian levels in Assur is also of note. Their earliest appearance can be dated through external comparisons to the late Early Dynastic or Akkadian period. In Babylonia as far as Mari their maximal count occurs in the Ur III and Isin/Larsa periods, somewhat earlier than in Assur.²¹

Furthermore, in level IIIb1 which can be correlated with Temple level D there is a great increase in significant forms as well as a distinct decrease of earlier principal forms. This change in the pottery spectrum could have a historical background during the reign of Šamši-Adad I (ca. 1813–1781 B.C.).

A further change occurs in level IIIa2, that is, the destruction level and last phase of use of the building, with the decrease of some traditional pottery forms. Comparisons with other regions show that these new forms were in long use (fig. 11), well into Middle Assyrian—and probably early Neo-Assyrian—times; further, a few fragments of younger Khabur Ware beakers (fig. 12) first emerge in this level IIIa2.

Finally, observations on the preparation of clay by adding vegetal matter²² are helpful in characterizing some developments. In the earliest levels a mineral ware predominated in the pottery in both complexes. Pottery made of clay tempered with vegetal matter was also present, but an increase in number occurs later, in level IIIa1, in the Mitanni period, and reaches a peak in level IIb2.

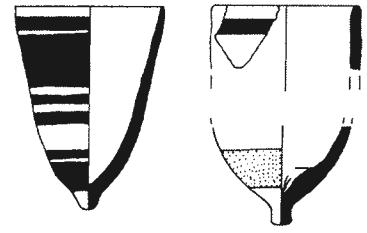

Figure 12. Beakers from level IIIa2. Diameter 6 cm.

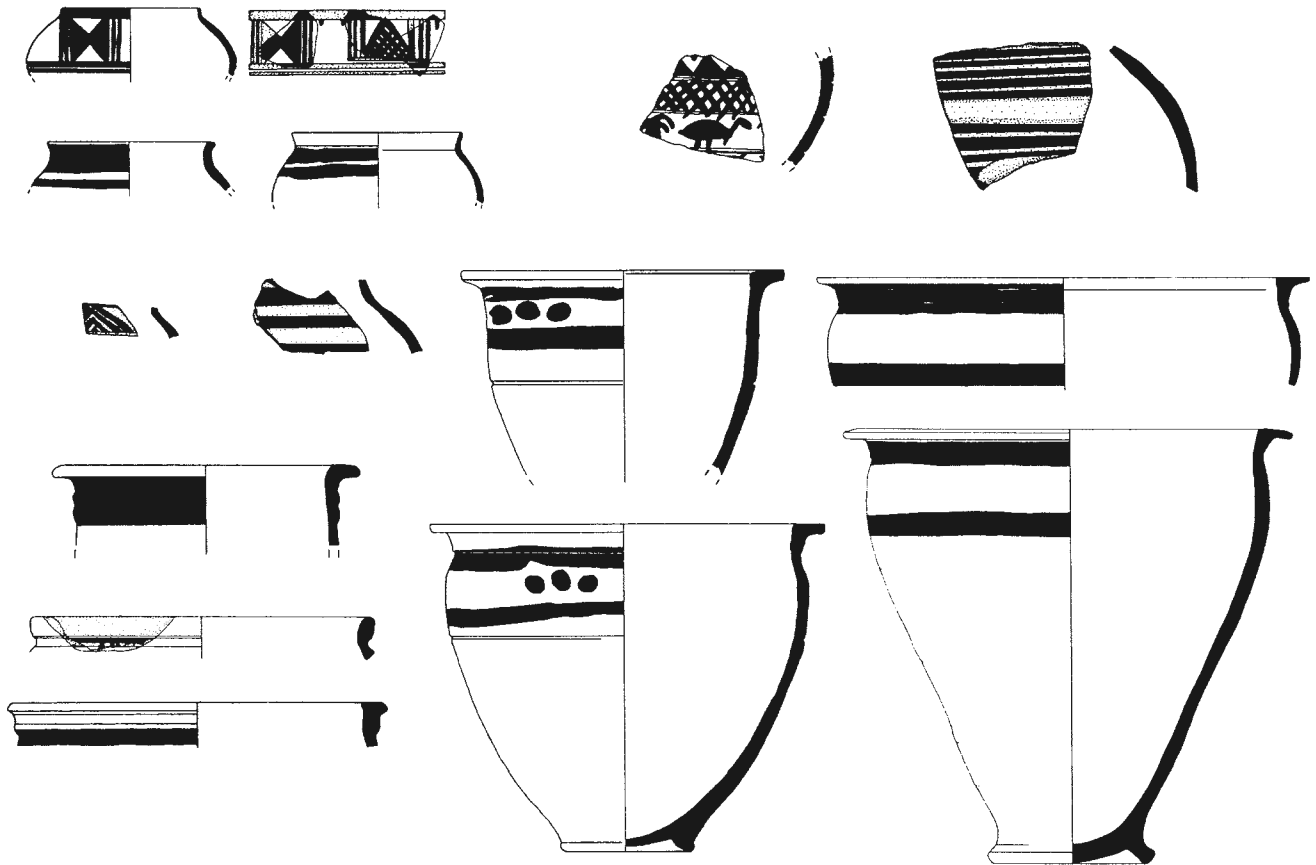

Figure 13. Khabur Ware from levels IIIb1–IIb3. Scale 1:5 cm.

²¹ Pons, "Principales formes de poterie mariote," "Groupe 8."

²² This observation was made macroscopically.

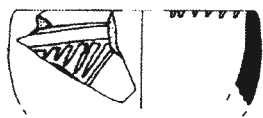

Figure 14. “Black-burnished Early Transcaucasian Ware”(?)
Scale 1:3 cm.

Yet the conflagration in level IIIa2 cannot be ascribed to any major historical event which would have caused a change in pottery; minor changes in repertory had begun in the earlier phase IIIa3 (e.g., the first emergence of nipple bottoms). Be that as it may, it still seems probable that the change reflects a new cultural influence in northern Mesopotamia under Mitanni rule.

As a whole, it has been shown that many pottery fragments appeared only as occasional, single finds, while others were consistently present throughout all periods, indicating persistent traditions in pottery production. Despite the large quantities of sherds, only 1.1% of the 1,577 diagnostic sherds found in the Neo-

Assyrian level IIa2 could be designated as principal forms. External comparisons for the principal forms sometimes were of little help in dating; in many cases a duration of several centuries or even millennia may be presumed. One reason for this is that it is not always possible to distinguish whether these forms and even the analogous sherds were actually traditional forms or simply material transposed by later activities. Only a statistical evaluation of comparative material, independent of the pottery type, will enable the placement of these levels within a chronological framework.

Here this problem of explaining an import comes into view. The questions about the place of production and the interregional distribution of sherds painted in the style of the so-called (older) Khabur Ware (fig. 13) or even Nuzi Ware still remain unanswered.²³ Painting in general and similar incised patterns are present in the earliest levels in Assur (cf. fig. 7), and macroscopic fabric examination found no variations from the spectrum in Assur. Furthermore, some fragments find parallels among unpainted examples in Assur. Hence, it seems that these sherds could be of local production.

The only examples that stood out among the mass of pottery because of their ware and unusual decoration are luminous black fragments with white incrustation (fig. 14). Until now they were found in Assur only in excavation debris. This kind of pottery seems to be like the “Black-burnished Early Transcaucasian” in Tell Brak.²⁴

Pottery from Assur finds comparisons in the south as well as in the west throughout all periods. The majority, however, remains without any reference. Yet, in view of the overall homogeneity on the one hand, and the predominating diversity on the other, at this point only local production of pottery is possible, that is, a production that through occasional imports or itinerant craftsmen adopted external forms into its repertoire. Research today still knows too little about the private and institutional mechanisms that caused a preference for specific forms, forms that were certainly ascribed with a primary function.

²³ Cf. the recent discussion, for example, C. Hamlin, “The Ḫabur Ware Ceramic Assemblage of Northern Mesopotamia: An Analysis of Its Distribution” (Ph.D. diss., University of Pennsylvania, 1971); B. Hrouda, “Ḫābūr-Ware,” *Reallexikon der Assyriologie* 4 (Berlin and New York: Walter de Gruyter, 1975), pp. 29–31; D. L. Stein, “Khabur Ware and Nuzi Ware: Their Origin, Relationship and Significance,” *Assur* 4/1 (1984); B. Hrouda, “Die Ḫābūr-Ware in neuerer Sicht,” in *Anatolia and the Ancient Near East: Studies in Honor of Tahsin Özgüç*, edited by K. Emre, M. Mellink, B. Hrouda, and N. Özgüç (Ankara: Press of the Turkish Historical Foundation, 1989), pp.

205–14; H. Oguchi, “The ‘Late’ Khabur Ware Problem Once Again,” *Al-Rafidan* 21 (2000): 103–26; H. Oguchi, “The Origins of Khabur Ware: A Tentative Note,” *Al-Rafidan* 22 (2001): 71–87; B. Hrouda, “About Ḫabur-Ware, Hopefully for the Last Time,” *Al-Rafidan* 22 (2001): 89–92.

²⁴ Oates, *Tell Brak*, vol. 2, pp. 160ff. For further similar wares, cf. H. Kühne, *Die Keramik vom Tell Chuera und ihre Beziehungen zu den Funden aus Syrien-Palästina, der Türkei und dem Iraq*, Vorderasiatische Forschungen der Max Freiherr von Oppenheim-Stiftung, Band 1 (Berlin: Gebrüder Mann, 1976).

MESOPOTAMIAN ALTAR DEPOSITS

Judy Bjorkman, Owego, New York

Altar deposits belong to the larger category of building deposits. Building deposits form an integral part of a structure¹ but are out of sight, having been put in place when the structure was being built or when repairs or rebuilding were undertaken. All building deposits (and other types of ritual deposits) are non-utilitarian, that is, there was no intention of later retrieving the deposited materials. This differentiates them from hoards, which are utilitarian, having been hidden with the intention of retrieval at a later time.² Building deposits are not limited to Mesopotamia and occur at least as early as the ninth millennium B.C., for example, the various animal bones found inside walls and a bench at Mureybit.³ Such early deposits are not presented here because of the difficulty of identifying altars or cultic furniture before the Ubaid period.

Mesopotamian altar deposits are limited in number and varied in content (see table 1). I have used the word “altar” very broadly to include what might be called cultic furniture, such as podia and benches. All examples come from buildings described as temples. The numbering of the altar deposits (table 1, second column) is that used in my dissertation. The following presentation is organized by site.

ERIDU

So far, there is only one fourth-millennium example of an altar deposit (Eridu No. 1).⁴ The body of a painted clay snake, 34 cm long, was found inside an altar of the Late Ubaid Temple VII. But the head of this snake was found lying on the floor near the south corner of the central chamber. A hole goes through the mouth and the neck of the snake, and the body itself is hollow. The snake’s head was found in the first season, presumably on the upper (later) of the two occupation levels of Temple VII (both of which were liberally sprinkled with fish bones). The body of the snake must have been built into the altar during its original construction in the earlier phase of Temple VII.

Questions arise both about this deposit and later ones. Was the snake broken deliberately? Why had its body been built into the altar? Why was its head preserved for an indeterminate time, apparently awaiting the rebuilding of the temple? Where was the head kept all that time? And why was it finally left behind, in a corner to the left of the altar in which its body was buried? It is well known that snakes had magical and spiritual connotations. Vertesalji asks whether the snake, being hollow, might have been a libation vessel.⁵ As I propose below, the deliberate breaking of artifacts may have been related to a kind of spiritual power they were believed to have, and the acts of breaking and separating the pieces may have been efforts both to diminish and to control that power.

¹ R. Ellis, *Foundation Deposits in Ancient Mesopotamia*, Yale Near Eastern Researches 2 (New Haven and London: Yale University Press, 1968), p. 1.

² J. K. Bjorkman, “Hoards and Deposits in Bronze Age Mesopotamia” (Ph.D. diss., University of Pennsylvania, 1994), pp. 7 ff.

³ M. van Loon, “The Oriental Institute Excavations at Mureybit, Syria: Preliminary Report on the 1965 Campaign,” *Journal of Near Eastern Studies* 27 (1968): 271, 275.

⁴ Fuad Safar, Mohammad A. Mustafa, and Seton Lloyd, *Eridu* (Baghdad: Republic of Iraq, Ministry of Culture and Information, State Organization of Antiquities and Heritage, 1981), pp. 88, 104, 230, and fig. 110.

⁵ P. P. Vertesalji, “Zur Bedeutung des Eridu-Friedhofs,” *Baghdader Mitteilungen* 15 (1984): 30.

Table 1. Mesopotamian Altar Deposits.

<i>Deposit Date</i>	<i>Deposit Number</i>	<i>Location</i>	<i>Artifacts</i>	<i>Number</i>	<i>Materials</i>	<i>Antiques?</i>
Late Ubaid	Eridu No. 1	Temple VII, cella, altar	hollow snake	$\frac{1}{2}$	clay	?
ED I	Khafajah No. 2	Nintu Temple III altar	steatite vase	1	stone	?
ED II	Tell Agrab No. 25	Shara Temple, Earlier building, later level; altar	amulets, clay bowls, cylinder seal	60	clay, stone	yes
ED II	Tell Agrab No. 17	Shara Temple, Shrine L 13:4, Main level, altar	pot, copper scraps, cylinder seal, jewelry	several	copper, stone, clay	?
ED II	Tell Agrab No. 4	Shara Temple, Shrine M 14:2, altar	43 mace-heads, copper tools, weapon, cup, beads, cylinder seals, stone fragments of bowls, relief, statue	70	stone, copper	yes
ED II	Tell Asmar No. 13	Square Temple, Shrine 1, altar	5 cylinder seals, stone vase, beaker and bowl sherds; stone figurine (+ beads, stamp seals, mace-heads, etc.)	ca. 16	stone	yes
ED II	Mari No. 4	Ishtar Temple c, "little sanctuary" along walls, under bench	6 <i>barcasses</i> , 1 cup	7	ceramic	no
ED II	Mari No. 5	Ishtar Temple, Cella 17, level c in podium and floors	<i>barcasses</i>	9	ceramic	no
ED II/IIIa	Khafajah No. 4	Nintu Temple, Level VI, sanctuary P 45:51, inside altar	statuary, 5 mace-heads	8	stone	yes
ED II/IIIa	Khafajah No. 5	Nintu Temple, Level VI, sanctuary P 45:52, inside altar	statue fragments	3	stone	yes
ED IIIa	Tell Brak No. 15	single-room temple (HS4, Level 5), inside altar and in surrounding fill	sealings, flint blade, unusual clay object, model wagon wheel	500+	clay, flint	?
ED III	Nippur No. 1	North Temple cella, floor 2, inside box altar	9 jars, 3 bowls, 2 frit discs	14	ceramic	no
ED III	Nippur No. 4	Inanna Temple, Level VII, large sanctuary (Locus 179), plastered onto altar/table	vase, bowl, statuary, peg	9+	stone, gold, (wood)	yes
ED III	Nippur No. 5	Inanna Temple, Level VII, room IT 173, under ablution structure	statuary and plaque fragments	ca. 5	stone	yes
ED IIIb	Mari No. 7	Ishtar Temple, Cella 17, Level b, in surface of podium, at foot of bench	<i>barcasses</i>	4	ceramic	no
ED IIIb	Mari No. 8	Ishtar Temple, Cella 17, Level a, in surface of podium	<i>barcasse</i>	1	copper	no
ED IIIb	Mari No. 9	Ishtar Temple, Cella 18, Level a, inside podium, along foot of and inside benches	<i>barcasses</i>	12	1 copper, 11 ceramic	no
ED IIIb	Mari No. 12	Ninnizaza Temple, Court 12, under bench	<i>barcasse</i>	1	ceramic	no
ED IIIb	Tell Asmar No. 14	Single-Shrine Temple, Level 1, inside altar	1 mace-head, 2 plano-convex bricks	3+	stone, mudbrick	?
Akkadian	Mari No. 18	Ninhursag Temple, pit under altar	slab + ??	50	stone + ??	yes

KHAFAJAH

After perhaps a thousand years, the next oldest altar deposit is Khafajah No. 2, from the Nintu Temple III of the Early Dynastic I period. The altar walls had been built of unbaked plano-convex bricks, and the space between was packed solid with clay. Inside the clay packing was found a greenish stone (steatite) vase, standing near the altar's upper right side. It seemed clear to the excavators that the vase was deposited there when the altar was built, not added later. The vase has not been published, but an idea of its shape and its location within the altar may be seen in figure 93 in OIP 58.⁶

Khafajah's next two altar deposits are also from the Nintu Temple (Khafajah No. 4 and No. 5), Level VI (= Early Dynastic II). At that time, the temple had three cellas, each with an altar placed against the short wall.⁷ Khafajah No. 4 and No. 5 were found in Rooms 51 and 52. These two cellas are on the left side of the temple which is accessible only through a single courtyard doorway. The deposits may have been nearly contemporary activities, made when the altars were first built, but evidence for this is inconclusive.⁸

The deposit inside the more elaborate altar in Room 51 (Khafajah No. 4) was the larger, containing the well-known aragonite statue of a bearded cow,⁹ a human-headed alabaster bull protoma,¹⁰ a headless, standing female statue,¹¹ and five "finely shaped" mace-heads.¹² No further published details are known about the mace-heads, but in general they often occur in other ritual deposits and are not found in hoards.

The smaller deposit found within the altar in Room 52 (Khafajah No. 5) contained two female heads and one small male head.¹³ Two of these heads have bitumen at the neck, indicating ancient repairs. The face of one female head is obliterated; the other seems intact except for one missing inlaid eye; the male head may be complete.

All these artifacts are made of stone. They were deposited at the beginning of Nintu VI, so their date of manufacture must be at least slightly earlier. One might suppose that artifacts to be built into an altar would be chosen with some care. But some of these are broken, and they seem somewhat miscellaneous. What else can be said about them? One altar's deposit contains a headless human body and the other contains three bodyless human heads (and neither of the female heads belongs to the body in the other altar). Why were only parts of each of the statues buried within the new altars? Based on my research on other types of ritual deposits in temples, in which broken and separated artifacts (especially worshipper statues) frequently occur, I propose that the separation of body parts and certain types of damage to the human statuary, especially to the orifices of the head (nose, mouth, eyes, and ears) were deliberate and were done for the same reasons which I mentioned earlier regarding the Eridu snake. They represent an effort to diminish and control a spiritual energy believed to be possessed by certain artifacts.¹⁴

It has been suggested that the aragonite cow was a cult statue.¹⁵ However, I prefer Spycket's proposal that its small size (11 cm high) makes it difficult to imagine as a cult image.¹⁶ I would add that the burial of cult statues inside temple altars is unknown in Mesopotamia. I agree with Frankfort's general statement that the statue served some ritual function.¹⁷ This still does not explain why it was buried in the altar, except in the sense proposed by Evans that "such deliberate burials suggest that temple offerings and equipment remained sacred even when no longer in use."¹⁸

⁶ P. Delougaz and Seton Lloyd, *Pre-Sargonid Temples in the Diyala Region*, Oriental Institute Publication 58 (Chicago: University of Chicago Press, 1942), p. 99.

⁷ Delougaz and Lloyd, *Pre-Sargonid Temples*, p. 99 and see plate 16. The cella of Room 4 on plate 16 is located where the earlier Early Dynastic I altar deposit (Khafajah No. 2) was found.

⁸ Part of the problem is that the two cellas were not excavated below Level VI. See the discussion in Delougaz and Lloyd, *Pre-Sargonid Temples*, pp. 87–92.

⁹ Delougaz and Lloyd, *Pre-Sargonid Temples*, p. 81 (fig. 72), p. 89; Henri Frankfort, *More Sculpture from the Diyala Region*, Oriental Institute Publications 60 (Chicago: University of Chicago Press, 1943), pp. 9–10, 32 (No. 293), and pls. 46–48.

¹⁰ Delougaz and Lloyd, *Pre-Sargonid Temples*, p. 89; Frankfort, *More Sculpture*, pp. 10, 32 (No. 294), and pls. 49–50.

¹¹ Delougaz and Lloyd, *Pre-Sargonid Temples*, pp. 26–27, pl. 23 (No. 240, C–D).

¹² Delougaz and Lloyd, *Pre-Sargonid Temples*, p. 89.

¹³ Delougaz and Lloyd, *Pre-Sargonid Temples*, pp. 89, 149; Frankfort, *More Sculpture*, pp. 6, 9, 24–25 (Nos. 220–22), pl. 12.

¹⁴ For further development of this theme, see Bjorkman, "Hoards and Deposits," pp. 483–97, and J. K. Bjorkman, "How to Bury a Temple: The Case of Nuzi's Ishtar Temple A," in *Nuzi at Seventy-Five*, edited by David I. Owen and Gernot Wilhelm, Studies on the Civilization and Culture of Nuzi and the Hurrians 10 (Bethesda: CDL Press, 1999), pp. 103–22.

¹⁵ Delougaz and Lloyd, *Pre-Sargonid Temples*, pp. 82, 89; Ernst Heinrich, *Die Tempel und Heiligtümer im alten Mesopotamien* (Berlin: Walter de Gruyter, 1982), p. 124.

¹⁶ Agnes Spycket, *La statuaire du Proche-Orient ancien* (Leiden: Brill, 1981), p. 132.

¹⁷ Frankfort, *More Sculpture*, p. 10 n. 10.

¹⁸ Jean M. Evans, "Nippur," in *Art of the First Cities: The Third Millennium B.C. from the Mediterranean to the Indus*, edited by Joan Aruz (New York: Metropolitan Museum of Art, 2003), pp. 66–67.

The human-headed bull protoma of Khafajah No. 4 is a minor god, probably to be associated with the sun god Utu. It often occurs in pairs in other Mesopotamian artwork.¹⁹ Its horns are missing here. There is an interesting “gradation” which appears within the artifacts of Khafajah No. 4—there are what may be representations of a god, a minor god, and a human; the first is complete, the second is separated from its partner and its horns are destroyed, the third is completely separated from an essential body part (her head). If we had better data and more such examples, we might be able to assess the significance of this “gradation” for the reconstruction of Mesopotamian religious practices.

NIPPUR

Three altar deposits were found at Nippur. They are from two different temples and are very different in content. Nippur No. 1 is composed entirely of clay items, Nippur No. 4 and No. 5 are composed entirely of stone (as far as is known).

Nippur No. 1 is from the box altar of the cella of the Early Dynastic III North Temple.²⁰ This altar was built on floor 2, was hollow inside, and contained nine baked-clay jars along with three bowls of a type which are often used as lids. One of the jars contained two bluish-green glazed frit disks (not depicted). Tunca²¹ suggests that this collection of vases may have been put into the pit which disturbed part of the altar, rather than having been placed into the altar interior, although he concludes that the photo does not allow us to decide. Beyond some ritual use, I cannot suggest a theory for the presence of the jars inside this altar. Such a ritual usage may parallel that of the Early Dynastic I jar deposit in the altar at Khafajah.

Nippur No. 4 comes from a cella of the Level II Inanna Temple. This is a peculiar example of an “altar” deposit. Hansen and Dales do refer to this structure as a “table or altar.”²² At least, it appears to be a piece of cultic furniture. The deposit itself is composed of at least nine artifacts, among them the well-known and unique worshipper statue of a woman with a sheet-gold face, three seated worshipper statues, a male statuette, a male head, a double vase supported by four birds, a micaceous bowl, and a stone peg with a bull’s head.²³ There may be more, but without a published catalogue of artifacts, this was all I could confirm. All these stone artifacts were presumably laid out next to each other and then buried within periodic clay plasterings of this “altar.” I have difficulty envisioning this, especially since the statues are not miniatures—two of them are each about 30 cm high. How would this periodic plastering work? Would the artifacts sit there, covered with some millimeters of mud plaster, semi-visible for months at a time at the end of the sanctuary, waiting for the next layer of plaster, then the next, etc.? It is unfortunate that a fuller description of the nature of the deposition is not available. What we have implies that Nippur No. 4 disappeared from sight rather slowly, unless each new layer of plaster was applied immediately after the previous one had dried sufficiently. Other altar deposits which were plastered and concealed are the Mari *barcasses*, discussed below.

Nippur No. 5 is also questionable as an “altar” deposit. It consists of some statuary and plaque fragments. The room of the deposit was close to the cella of the Level VII Inanna Temple. The room may have been used for ablutions. In its eastern corner was built, sometime after the room had been in use, a bitumen-covered structure. On it, “the broken statues had been neatly laid out in a row and covered with bitumen and mud plaster.”²⁴ According to Hansen, three fragments of an inscribed plaque dedicated to ^dNin.SAR were also built into this “bitumen-covered

¹⁹ F. A. M. Wiggermann, *Mesopotamian Protective Spirits: The Ritual Texts*, Cuneiform Monographs 1 (Groningen: Styx, 1992), pp. 149, 174 ff.

²⁰ D. E. McCown, R. C. Haines, and R. D. Biggs, *Nippur*, vol. 2, *The North Temple and Sounding E*, Oriental Institute Publications 97 (Chicago: University of Chicago Press, 1978), pp. 17, 19–20, 33, pls. 3(c), 30, and 45.

²¹ Onhan Tunca, *L’architecture religieuse Protodynastique en Mésopotamie*, Akkadica Supplementum 2 (Leuven: Peeters, 1984), pp. 93, 188.

²² Donald P. Hansen and George Dales, “The Temple of Inanna, Queen of Heaven at Nippur,” *Archaeology* 15 (1962): 79, 81.

²³ Hansen and Dales, “The Temple of Inanna,” p. 79, figs. 2 and 8; Richard C. Haines, “The Temple of Inanna at Nippur,” *The Illustrated*

London News, September 9, 1961, p. 409 and figs. 10, 12, 17, 21, 23, and fig. 3 caption; Albrecht Goetze, “Early Dynastic Inscriptions from Nippur,” *Journal of Cuneiform Studies* 23 (1970): 44; Eva Braun-Holzinger, *Mesopotamische Weihgaben der frühdynastischen bis altbabylonischen Zeit*, Heidelberger Studien zum alten Orient 3 (Heidelberg: Heidelberg Orientverlag, 1991), pp. 133, 251, 326; Evans, “Nippur,” pp. 66–67.

²⁴ Hansen and Dales, “The Temple of Inanna,” p. 79, fig. 2; Haines, “The Temple of Inanna,” p. 409, figs. 3, 8, and 9; Donald P. Hansen, “New Votive Plaques from Nippur,” *Journal of Near Eastern Studies* 22 (1963): 154 and pl. 6; Goetze, “Early Dynastic Inscriptions,” pp. 42–43; Braun-Holzinger, *Mesopotamische Weihgaben*, pp. 250, 311.

construction for ablution.”²⁵ A fourth fragment of the same plaque, differently weathered, was found in the south-east corner of the room, calling to mind the parallel situation of the Eridu snake. Some additional pieces of statuary were found on the floor and in the debris of this room. When these artifacts were left in the archaeological record is unclear. Presumably, sometime during Level VII, the ablution structure was built and the statue and plaque fragments deposited within it. The fourth plaque fragment, additional statuary fragments, and a piece of a green carved vase were left on the floor and in the fill of this room when the temple was rebuilt in Level VI. But the reasons behind the selection and burial of all these artifacts remain obscure. Haines suggests that the statue fragments inside the bitumen structure were being “re-used as a foundation pad.”²⁶ But, as I have suggested above, I think there were spiritual, not “structural,” reasons for building the broken statues into the bitumen structure, as well as for having left the separated piece of the plaque and other fragments of statuary on the floor and in the fill when the room’s use was discontinued.

MARI

The activity of plastering objects out of sight on podia, as in Nippur No. 4, also occurs several times at Mari in some of the Early Dynastic II–Early Dynastic IIIb examples of *barcasses*. These are the barge-shaped and oval dishes, made of copper, clay, or plaster, which were probably used in some kind of ritual and then left in place or built into podia, etc.

The earliest example of *barcasses* which were plastered and concealed is Mari No. 4 (Early Dynastic II). Six *barcasses* plus a small cup were found in Ishtar Temple c, in the “little sanctuary.” Parrot points out two of the ceramic *barcasses* along the north wall of the court and the four buried under the bench in the adjoining cella, and the small cup buried at the angle of the door.²⁷ Since the court floor had been replastered several times, I assume that the cup and the two *barcasses* along the wall were (eventually) out of sight and therefore, by my definition, they constituted a ritual deposit.

Mari No. 5 is in the Ishtar Temple, level c, Cella 17 (also Early Dynastic II). Nine ceramic *barcasses* were found buried here, some in the podium and some in the adjoining floor. Here again, the podium was repaired and enlarged, at which time, Parrot proposes, the *barcasses* were needed, used, left in place, and eventually disappeared under the plaster.²⁸

In Mari No. 7, when the podium of level b of Cella 17 (Early Dynastic IIIb) of the Ishtar Temple was enlarged, two ceramic *barcasses* were placed on top, flush with the podium’s surface. One was coated on its interior with plaster and thickened in its upper part by a layer of bitumen. The whole installation was plastered over, covering (one assumes) the *barcasses* on top and also rendering invisible two *barcasses* (14 and 15) which had earlier been installed at the foot of a large bench nearby. Then, two additional, identical *barcasses* (8 and 9) were placed exactly above these at the foot of the bench. It is not clear from Parrot’s description whether these last two were ever plastered over and concealed.²⁹

Mari No. 8 was found in the Ishtar Temple, level a, Cella 17 (Early Dynastic IIIb). It was a copper *barcasse*, 60 cm long, found on top of a large podium under a very thick layer of plaster which had apparently been necessary to repair the top of the podium. Above the copper *barcasse*, several new *barcasses* had been modeled in the plaster; they were nested in each other and contained ashes. Parrot counted six of these superimposed *barcasses*.³⁰ Again, this is an example of something which apparently disappeared out of sight gradually over time.

In Mari No. 9 (Early Dynastic IIIb), in Cella 18 of the Ishtar Temple, along its eastern wall, was a podium inside of which were three large *barcasses*, one copper and two ceramic. The copper example was nearly two feet long and was found buried one meter inside the podium; a ceramic *barcasse* had been buried 20 cm beneath the copper one, and a second ceramic *barcasse* was found just behind the first one.³¹ I assume that these *barcasses* had all been buried inside the podium as it was being built. Some uncertainty stems from the fact that the remains of the podium were just under the surface of the mound.

²⁵ Hansen, “New Votive Plaques,” p. 154.

²⁶ Haines, “The Temple of Inanna,” p. 409.

²⁷ André Parrot, *Le temple d’Ishtar*, Mission archéologique de Mari I (Paris: P. Geuthner, 1956), pp. 8–9, 58–61.

²⁸ Parrot, *Le temple d’Ishtar*, pp. 18, 21, 58–63.

²⁹ Parrot, *Le temple d’Ishtar*, pp. 18, 26–27, 58–63.

³⁰ Parrot, *Le temple d’Ishtar*, pp. 18, 34, 46, 58–63.

³¹ Parrot, *Le temple d’Ishtar*, pp. 37–38, 63–66.

Mari No. 12 (Early Dynastic IIIb) is from the Ninnizaza Temple. A terra-cotta *barcasse* was found under a bench in Court 12, upper floor. The *barcasse* had been installed in the floor of the earlier level of Court 12, but was not hidden until the later floor was constructed, which included benches around the court, covering the *barcasse* as well as a processional way and a bitumen hole.³² My interpretation of all this activity is much in agreement with that of Börker-Klähn,³³ viz., that the second floor and several other aspects of this situation were parts of a burial ceremony for the Ninnizaza Temple.

Mari No. 18 was found more recently: “Under an altar dedicated to the goddess Ninhursanga dating to about 2300 B.C., a pit containing fifty objects was discovered.”³⁴ Only one of the objects is depicted, a unique inscribed alabaster slab. Unfortunately, no additional details about the context were given. Fortin notes,

When a vessel or idol was no longer used in the ceremonies of a cult, it could not be thrown away as rubbish the way ordinary household utensils were. Instead, a pit was dug and the cult-related objects were buried in it. Such a pit, known as a *favissa*, was discovered in Mari in 1997, under the altar of a temple dedicated to a Sumerian mother goddess named Ninhursag. The excavators considered that this *favissa* was a sort of foundation deposit, buried beneath a temple to mark its rebuilding. This seems probable, since the cult-related installations at the temple of Ninhursag have been dated to about 2300 B.C., while the shapes of the ceremonial vessels in the deposit indicates that they date from around 3000 B.C.³⁵

Fortin’s statement that vessels or idols no longer in use were buried in a *favissa* since they could not be thrown out like household rubbish is a welcome recognition of their special status.

The practice of depositing materials which are apparently cult-related and which may be centuries older than the date of actual deposit is a common one in Mesopotamia. However, the interpretation of this Mari deposit as a kind of foundation deposit marking the rebuilding of the temple must be provisional without greater knowledge of its context. When was the *favissa* dug—before the altar was constructed, or during its time of use, or at the end of its use? As I mentioned in relation to Mari No. 12 (along with Mari No. 11) from the Ninnizaza Temple, deposits of cult-related materials can also mark the end of the use of a temple, as well as its rebuilding. More details about the artifacts contained in Mari No. 18 and their condition when deposited would be helpful in comparing this deposit with other historical examples.

TELL AGRAB

Tell Agrab No. 25 is the earliest of three Agrab altar deposits from the Shara Temple, dating to very early in the Early Dynastic II period. The altar was built over a place where a doorway had been in the preceding level. The doorway was blocked up and the altar built in such a way as to cover the lower part of it completely. The altar deposit is described as follows:

Both in the cavity within the altar and beneath the filling of the doorway, there were large collections of small clay bowls of a well known type, mostly unbroken. Some of these were either full or partially filled with charcoal. There were also some beads and broken amulets of poor quality³⁶

Unfortunately there is no more information on the “small clay bowls,” but in general this seems to be a very modest type of deposit.

Tell Agrab No. 17 (Early Dynastic II) was found inside the altar in shrine L 13:4, in a different section of the main level of the Shara Temple. It apparently had been built into the original altar of the first occupation floor. It is described in the text as containing a “cylinder seal and a heterogeneous collection of small objects and fragments of silver stored in a sealed pot”³⁷ However, in two other places the pot and its contents are described differently.³⁸

³² André Parrot, *Les temples d’Ishtar et de Ninni-zaza*, Mission archéologique de Mari 3 (Paris: P. Geuthner, 1967).

³³ Jutta Börker-Klähn, “Eine folgenreiche Fundbeobachtung in Mari,” *Zeitschrift für Assyriologie* 69 (1979): 221–33. See also Bjorkman, “Hoards and Deposits,” pp. 353–58.

³⁴ Paul Collins, “Incised Slab with an Abstract Female Figure and Animals,” in Aruz, *Art of the First Cities*, p. 163.

³⁵ Michel Fortin, ed., *Syria, Land of Civilizations*, Exhibition Catalog (Montreal: Musée de la Civilisation de Québec, 1999), p. 284.

³⁶ Delougaz and Lloyd, *Pre-Sargonid Temples*, p. 256.

³⁷ Delougaz and Lloyd, *Pre-Sargonid Temples*, p. 248.

³⁸ Delougaz and Lloyd, *Pre-Sargonid Temples*, p. 273. The catalogue indicates fragments of copper in the pot. P. Delougaz, *Pottery from the Diyala Region*, Oriental Institute Publications 63 (Chicago: University of Chicago Press, 1952), pl. 162, notes “copper scraps inside,” and the pot is said to be broken off at the neck, not sealed.

Given the unique nature of this deposit, it is unfortunate that there was not a better enumeration of the jar's contents, as well as of the rest of the altar deposit. In the contemporary shrine (L 13:6) next to this one, the altar had nothing inside.

Tell Agrab No. 4 (Early Dynastic II) is technically a miscellaneous deposit, that is, it was not built into the altar but had been inserted later, by means of a hole cut into the altar.³⁹ Sometime after this large altar in M 14:2 of the Shara Temple was built, the hole was dug into its side and nearly seventy objects were buried, including forty-three mace-heads of varying shapes and colors. This is the only altar deposit in which there is clear evidence of the altar being broken into after its construction was finished, for the purpose of depositing a large number of interesting artifacts. Apparently someone, at a later date, remembered the deposited items and dug a hole into the top of the altar in search of them, only missing the area by about 50 cm.⁴⁰

TELL ASMAR

Tell Asmar No. 13 dates to the early Early Dynastic II period. The artifacts found inside the altar of Shrine 1 of the Square (Abu) Temple were all of stone. The five cylinder seals are each of a different kind and color of stone (pink, white, hematite, crystal, serpentine). The scenes carved on them are not all the same, and they range in date from Jemdet Nasr to Early Dynastic II. Some of the stone vessels were whole, others were sherds. The stone bird vase seems to be complete or nearly so, as does the stone goddess figurine.⁴¹ According to the original excavation records from the Diyala Project of the Oriental Institute at the University of Chicago, several additional artifacts were found inside this altar: beads, stamp seals, mace-heads, pendants, and more.

Tell Asmar No. 14 (Early Dynastic IIIb) is from the altar of Level 1 of the Single-Shrine Temple. Its contents are few: one stone mace-head and a number of unbroken plano-convex bricks.⁴²

TELL BRAK

From more recent excavations at Tell Brak comes an altar deposit (Tell Brak No. 15) from a single-roomed temple (HS4, Level 5) dating to Early Dynastic IIIa (in terms of southern Mesopotamian chronology; later Ninevite 5, in terms of northern chronology).⁴³ As Matthews describes it,

Towards the west end of the room is a free-standing altar (Fig. 5:21), consisting of a plastered box built of small mud bricks, with entrance at floor level on the south west face ... Upon excavation (Fig. 5:22), the altar proved to contain large quantities of clay sealings, a sizeable flint blade, a model wagon wheel (Fig. 5.80:7) and an unusual shaped clay object in the form of a curving wedge with handle, made of unbaked clay ... (Figs. 5.23, 5.80:1)

Many sealings were also found in deposits which appear to have slumped out from the interior of the altar through the floor-level access and onto the adjacent floor probably after abandonment of this phase of the temple. Sealings additionally occurred higher up in the deliberate room fill in this part of the cella, to the southwest of the altar⁴⁴

A "distinctive assemblage of 293 clay sealings with cylinder seal impressions and 228 sealings with reverse markings but no surviving seal impressions" came out of this area within the cella.⁴⁵ The nature of the sealings led

³⁹ Delougaz and Lloyd, *Pre-Sargonid Temples*, p. 238.

⁴⁰ Delougaz and Lloyd, *Pre-Sargonid Temples*, p. 238.

⁴¹ Delougaz and Lloyd, *Pre-Sargonid Temples*, pp. 183, 185, 210; Henri Frankfort, "Oriental Institute Discoveries in Iraq, 1933/34," *Oriental Institute Communications* 19 (Chicago: University of Chicago Press, 1935), p. 24, fig. 24; Henri Frankfort, *Stratified Cylinder Seals from the Diyala Region*, Oriental Institute Publications 72 (Chicago: University of Chicago Press, 1955), Nos. 454–58.

⁴² Delougaz and Lloyd, *Pre-Sargonid Temples*, pp. 197, 199, and 212.

⁴³ Roger Matthews, ed., *Excavations at Tell Brak*, vol. 4, *Exploring an Upper Mesopotamian Regional Centre, 1994–1996* (London: British School of Archaeology in Iraq, 1997), pp. 109–11.

⁴⁴ Matthews, *Tell Brak* 4, p. 109.

⁴⁵ Matthews, *Tell Brak* 4, p. 111.

Matthews to suggest that they had been “attached to portable goods arriving at the temple for use within the cella, or that they pertained to baskets kept within the cella as containers.”⁴⁶ Perhaps the “sealings may have secured offerings made at regular intervals to the god of the temple, as worshipped at the altar, involving the burning of items in the carefully shaped stepped area in front of the altar.”⁴⁷ Such commodities, having been carefully sealed and administered, were, by implication, of great value, but even if that were so, it does not really explain why the sealings themselves would have been “deposited” in such ways.

The altar itself is unique among the other examples collected here because it is freestanding and has an entrance to its interior and because of its contents, which are like none of the other altar deposits. The entrance to the altar’s interior means that the time of deposition of the artifacts within is ambiguous, although the fact that so many sealings were both inside and outside the altar may signify that the deposition was made when that sanctuary’s use was discontinued and the sanctuary was being deliberately filled in. I also suggest that, given the number of examples of collections of sealings left behind at other sites and times, there is no need to associate the sealings solely with the cella. Perhaps sealings were regarded as having some sort of intrinsic value of a magical or economic nature, in which case they may have been collected from other places on the site, to be appropriately buried within the cella, as its use was discontinued. Such conjecture obviously needs further consideration, and I acknowledge that it is not a happy concept for those who wish to reconstruct the uses of rooms from the materials left behind in them.

CONCLUSIONS

1. What little is actually known about how Early Dynastic cellas functioned was summarized by Frankfort⁴⁸ — certain cultic acts were performed on the altar, and small quantities of liquids played a part in the ritual. Thus, the idea that some of the artifacts buried in altars may have been used for libations (such as the Eridu snake and the Mari *barcasses*) is plausible. However, the jars and bowls found inside altars (especially at Khafajah and Nippur) seem far larger than necessary for the volume of libation that may have taken place. Evidence for burning things within artifacts which later were buried in altars may be indicated by the charcoal found in a few *barcasses* at Mari and in the clay bowls of Tell Agrab No. 25, although it is also possible that the residue of materials burned elsewhere may simply have been put into the bowls and *barcasses*, to be buried with them.
2. Current evidence shows that the majority of altar deposits come from the Early Dynastic period, exceptions being the fourth-millennium Eridu snake and the Akkadian deposit at Mari. In my partial collection of second-millennium hoards and ritual deposits, only one problematic altar deposit appeared, in the Ningal Temple of the Kassite period at Ur. I am not aware of any first-millennium examples of altar deposits. This leaves open the question of why such miscellaneous altar deposits appeared on rare occasions in the third millennium B.C., then apparently no longer occurred.
3. Most altar deposits were found in the Diyala sites, Mari, and Nippur. One each was found at Eridu and Tell Brak.
4. It is difficult to see much similarity in the materials buried in altars, except for the Mari *barcasses* and perhaps the worshipper statue fragments from Khafajah No. 4 and No. 5. This indicates that concepts (mental templates) regarding which artifacts were “suitable” for burying inside an altar were local, rather than regional, in nature.
5. For the third millennium, statuary, when present in altar deposits, is only anthropomorphic or bovine in subject. Interestingly, this is also true of all statuary in the other types of Mesopotamian building deposits from the third millennium. (Of course, additional subjects appear in vases, plaques, seals, amulets, and maceheads.)
6. I have suggested that the breakage and separation of artifact pieces (such as in Eridu No. 1, Khafajah No. 4 and No. 5, and Nippur No. 5) may represent an effort to diminish and control the spiritual power they were

⁴⁶ Matthews, *Tell Brak* 4, p. 112.

⁴⁷ Matthews, *Tell Brak* 4, p. 113.

⁴⁸ In Delougaz and Lloyd, *Pre-Sargonic Temples*, pp. 300 ff.

believed to have. A different, often-made assumption is that such artifacts were put into altars because they were outdated or damaged inventory. I do not agree with this. In my opinion, the artifacts' putative spiritual power is a better path for explaining their presence inside an altar, rather than notions of wear-and-tear or of changes in fashion (a modern, Western obsession).

7. The process by which artifacts were selected for burial within an altar remains mysterious. One possibility is that *colors* may have been significant (e.g., the five cylinder seals in Tell Asmar No. 13), or certain categories may have been significant, especially in statuary. There seem to be many *single* examples of certain things—perhaps they were meant to represent similar items which had existed in greater quantities, but which had been recycled (I would add, recycled with appropriate rituals). This could explain why the number of artifacts in altar deposits is generally not very large and it is difficult to imagine them as the temple's entire inventory of ritual artifacts. The category of mace-heads deserves special attention, since they sometimes do occur in large numbers.
8. Although I have not covered ritual deposits of the Neolithic period, one only needs to read Yosef Garfinkel's article on this⁴⁹ to see certain familiar practices occurring earliest in the Neolithic of the Near East: the separation of skeletal body parts, the deliberate breaking of some items, the burial of things inside benches and other special places, the use of plaster and asphalt to cover cultic objects, etc.

This collection and discussion of altar deposits probably raises more questions than it answers. The topic has the theoretical advantage of possessing better data than other kinds of ritual deposits which are often discovered only by accident—altars and cultic furniture are usually easier to recognize, are disassembled with care, and contents and contexts are described in some detail. But all of this has not led to easy generalizations about the contents and reasoning behind the deposition of artifacts inside Mesopotamian altars.

⁴⁹ Yosef Garfinkel, "Ritual Burial of Cultic Objects: The Earliest Evidence," *Cambridge Archaeological Journal* 4/2 (1994): 159–88.

CLASSIFICATION OF KNOWLEDGE, AN ARCHAEOLOGICAL APPROACH: THE CASE OF NUZI

Simona Bracci

The main goal of this paper is the search for a possible relation between the inner and the outer space of the town of Nuzi and its social implications.

A good starting point for this analysis is in an examination of the town's inner space. The first interesting question concerning Nuzi's topography is related to its citadel. Not all scholars agree on Starr's identification of the extent of the whole town of Nuzi. A spread hypothesis suggests rather that this small area was only the citadel of a larger town which also had a lower part (figs. 1–2).

Topography is the main subject of my doctoral thesis,¹ and although that study focused on central and southern Mesopotamian towns, it is useful to refer to it here because one of its goals was the search for the possible existence of a rule involving the formation and the growth of the ancient Near Eastern town, contrary to the common idea of developmental disorder.

One general rule has been identified which deals with two observed points: first, the topographic role played by the most important buildings of the town (usually the temples), and second, the relationship between the orientations of these main structures and those of the remaining and less important buildings. In other words, the most important architectural structures of the ancient town seem to influence the rest of the urban texture. The most convincing evidence comes from the study of the ancient town of Larsa (fig. 3).

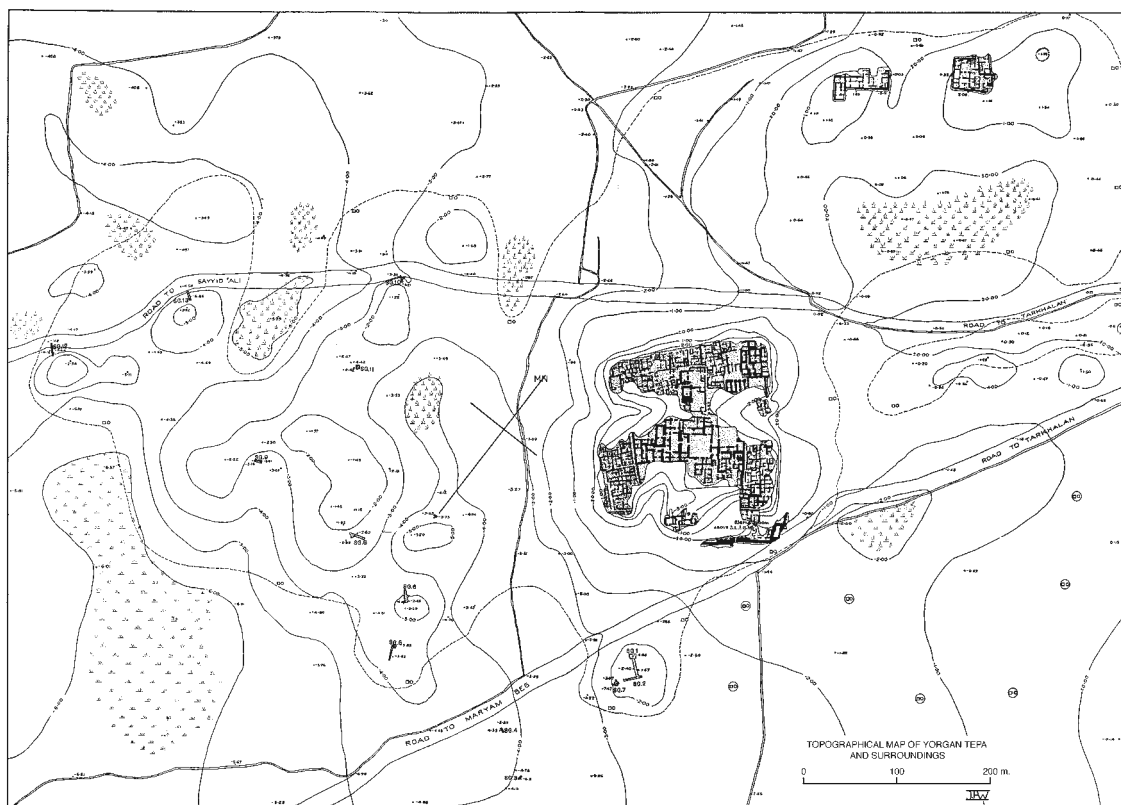

Figure 1. Nuzi, general view (after Starr, *Nuzi Excavations*).

¹ "The Relation between Private and Public Space in the Towns of the Ancient Near East during the III and the II Millennium B.C." (Ph.D. diss., University of Rome "La Sapienza," 2005).

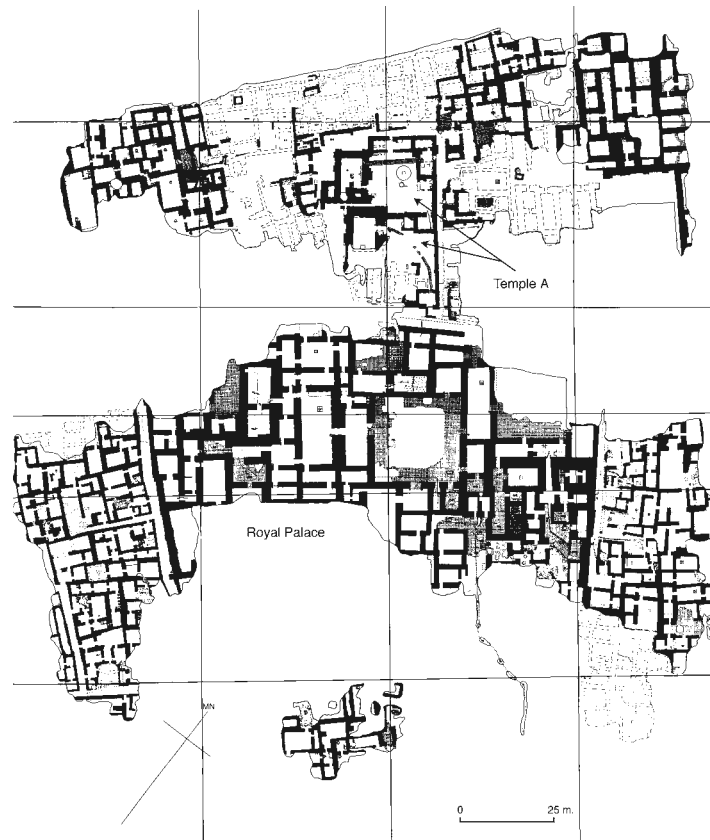

Figure 2. Nuzi, Level II (after Miglus, *Städtische Wohnarchitektur*).



Figure 3. Larsa, general view (after Huot, *Larsa*).

A careful examination of the topography of Larsa allows the observer to recognize at least three different spatial arrangements, all of them dependent on one main structure which was ideologically meaningful. The sequence of the main Larsa buildings is: the administrative structure under the Palace of Nūr-Adad (probably built during the third millennium B.C.),² the aforementioned Palace,³ and the Shamash Temple built during the Old Babylonian period.⁴ The creation of each of these huge buildings presumably reflects a new political situation, which is suggested by the location of the buildings themselves, by their extended surfaces, and by their deep political meaning.⁵

An examination of the general plan of Larsa makes it clear that each of these constructions created a new architectural and topographical focus inside the town. This is revealed by the correspondence between the orientation of each of these three main structures and the orientation of the minor structures such as private buildings. The general layout reveals that the majority of the smaller buildings have orientations that are related to one of the main structures. Presumably, these three different orientations correspond to three different topographical systematizations. It is only the superimposition of these different topographical arrangements that gives the impression of confused town planning.

The Larsa example is a useful tool for examining the Nuzi evidence, helping to understand the importance of what it seems now possible to define as “the variable of orientation.”

Nuzi’s layout shows that there are two different main building alignments and that the majority of other structures inside the town follow one of these two lines of development. The first is determined by the central complex (fig. 4), which is formed by the two temples and the palace, the second is the one held by the buildings situated on the northern ridge and in the southwest quarter. It is not possible to know whether or not these alignments depended

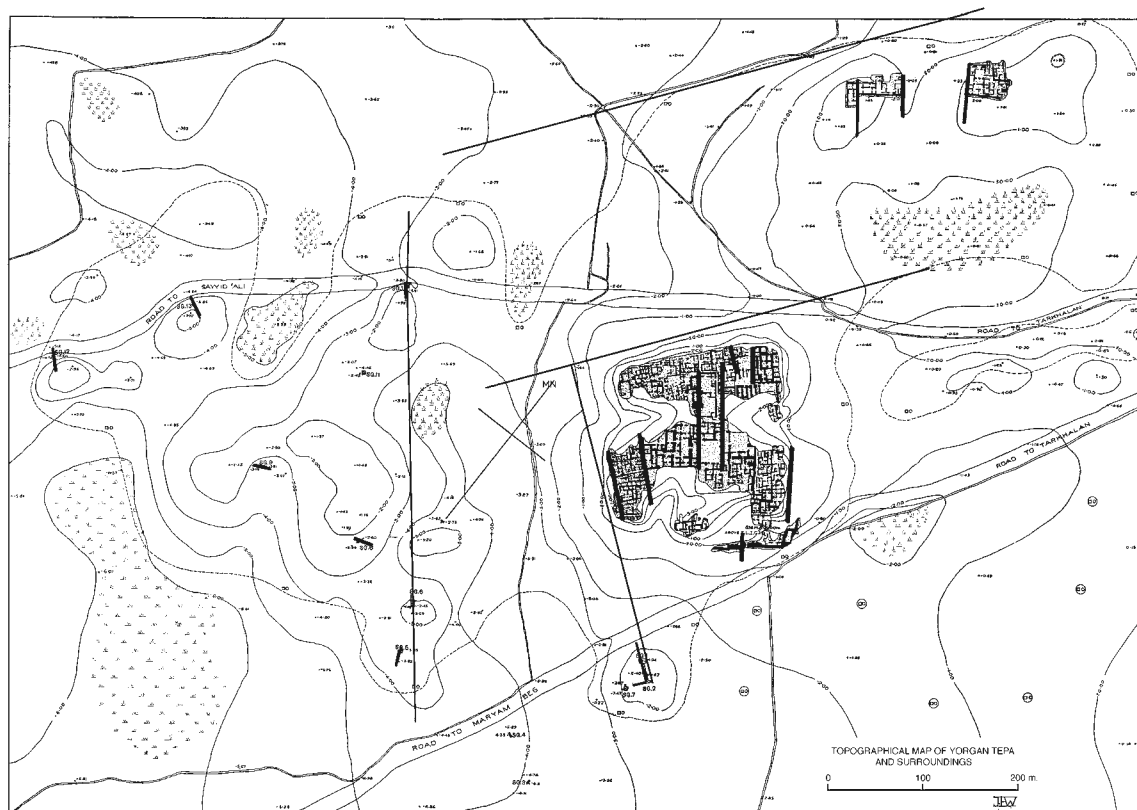

Figure 4. Nuzi, orientation of the main buildings (after Starr, *Nuzi Excavations*).

² J. C. Margueron, “Larsa, rapport préliminaire sur la quatrième campagne,” *Syria* 47 (1970): 261–77, 266, fig. 2. Recently Huot and the French archaeological mission of Larsa published a detailed study concerned with the town’s topography. J. L. Huot, *Larsa: Travaux de 1987 et 1989* (Beirut: Institut Français d’Archéologie du Proche-Orient, 2003).

³ M. Liverani, *Antico Oriente: Storia economia e società* (Rome: Bari, 1988). Liverani in pl. 13 dates Nūr-Adad’s reign between 1865 and 1860 B.C.

⁴ Huot, *Larsa*. The French archaeological mission working in Larsa noticed that Sin-iddinam during the Isin-Larsa period claimed to have built the temple; the first identified building phase is in the Old Babylonian period, although they suggest that the beginning of the temple’s life presumably is during the third millennium B.C.

⁵ Huot, *Larsa*. Larsa’s main buildings are generally located in the central part of the town and relate to the presence of the main street (or canal) that cut the city in two.

on different topographical features. Focusing on the central complex,⁶ it is easy to understand that it clearly plays a predominant role, both from an ideological and a topographical point of view. It represented the seat of the main authority as well as the largest architectural element of the investigated surface, it is located accurately in the center of the town and extended over the largest part of the town space (fig. 4). The general orientation of the whole eastern sector of the town (that is, the main building in the northeast corner and the main walls of the residential quarter) relates to the main complex's alignment. The southeast gate passage itself is oriented to the aforementioned one. Widening our observation to the outer town space, it is worth noticing that the so-called suburban houses, although far from the citadel, follow again the same alignment.

The remaining urban texture extending to the whole western part of the town followed a different, even though coherent, rule characterized by a strong northwest–southeast orientation. This further evidence could be in part related to the morphology of the land.

Nuzi's topography, therefore, seems to articulate itself with two main different orientations. In this writer's opinion, this evidence clearly demonstrates the existence of a project that underlies the spatial growth of the town. This theoretical assumption hints at the presence of a basic partition of the town space, or in this specific case, of the citadel. This overall project turns on the existence of a well-defined spatial relationship between the different topographical and architectural elements shaping the town. It seems reasonable, now, to look for the presence of a similar rule in the proximate area of the citadel.

The same criteria of seeking the alignments of different architectural features allow us to observe the correspondence between the orientations of the aforementioned topographic elements with some other features of the surrounding landscape. The morphological map of the land surrounding the citadel offers a first, interesting, although not certain, starting point.

Near the northern side of Nuzi (fig. 4) what seems to be a modern road is visible, which runs in the same direction as the northern ridge of the citadel. Of course, it is not possible to say if this modern route follows a more ancient one, although it presents an intriguing coincidence (in my opinion this could be the northern limit of the lower town).

According to the only aerial view available for the town (fig. 5), it is worth noting the existence of a sort of layout clearly visible in the surroundings of Nuzi. This image, published by Starr in his excavation report, allows us to recognize the existence of several paths just outside the town proper. An observation of their orientation is of crucial relevance: they ran parallel to both of the buildings' alignments previously identified inside the town. Previously,⁷ it was suggested that they could refer to the borders of some cultivated field just outside the town, presumably owned by the inhabitants of Nuzi. Nevertheless, the evidence of the topographical developments coming from several major Near Eastern towns allows us now to reasonably wonder whether these paths could be identified as ancient roads running into Nuzi's lower town (fig. 6).

A spatial relationship between these tracks and the buildings' alignments found inside the citadel clearly exists and is absolutely regular and homogenous. The northern sector of Nuzi's surroundings, where the aforementioned suburban houses were located, is furrowed by several major tracks which run parallel to the orientation of the main complex. Otherwise the central and the southern sectors of Nuzi's surroundings show tracks whose alignment corresponds to the one identified in the western sector of the citadel. If the paths on the eastern side of the citadel represent more doubtful alignments, the southern ones prove to be of special interest. The way they are spaced, together with their distances, appears very similar to the alignment between the eastern and western limit of the two preserved living quarters, that is to say, the southwest and southeast one.⁸

The aerial view shows the numerous roads running north–south more clearly than the single road running at 90 degrees. Nonetheless, a closer look at this photo shows some thinner tracks, preserved for shorter distances, which could presumably correspond to some minor streets (fig. 7). The double coincidence observed among the general orientations and between the inner and the outer alignments tends to exclude the possibility that these lines could be plow marks.

⁶ S. Bracci, "Remarks in the Relation between Town and Country in the Ancient Near East: The Case of Nuzi," *Acts of the 4th ICAANE* held in Berlin (in press), where it was asserted that in the author's opinion the palace and the two temples create a real complex of buildings with a prevailing palatine character.

⁷ See n. 4.

⁸ Observing the aerial view it is possible to notice and to measure roughly the distance between the tracks visible in the southern sector of the outer town and between the street which borders the palace on its western side and the supposed line of the wall, that is, the width of the southwest quarter. These measures are very close. Using a scale of 1:100, the distance observed is 1.6–1.7 cm for the southern sector and 1.5 cm for the southwest quarter.



Figure 5. Nuzi, aerial view (after Starr, *Nuzi Excavations*).



Figure 6. Nuzi, aerial view (after Starr, *Nuzi Excavations*).



Figure 7. Nuzi, aerial view (after Starr, *Nuzi Excavations*).

Therefore, it seems reasonable to suppose that Nuzi could have had a lower town, which was regularly but peculiarly projected, and whose inner topographical development followed the same alignments discovered in the citadel. The regular relationship among the alignments of the main and of some minor buildings inside the town finds a perfect correspondence with what has been observed for central and southern Mesopotamia (as exemplified by Larsa), where the most significant buildings (usually the temple) are of crucial importance in defining the urban texture. It is actually difficult to understand to which element the second orientation observed in Nuzi's western sector of the citadel is to be attributed. In southern Mesopotamian towns a relevant role in topographical development of the town is to be seen in the omnipresent canal; perhaps also here in Nuzi it is possible to relate the presence of a canal to the orientation of some buildings,⁹ although evidence is lacking at the moment.

After having established the existence of a topographical project conditioning Nuzi's growth, it is interesting to observe, when and where possible, how the town space was used by Nuzi society. This goal can be carried out thanks to the observation of the social relations inside the town. Nuzi is particularly useful to this kind of research because of the huge number of tablets found, although there are serious problems with assignment of findspots.¹⁰

In recent years Martha Morrison has studied some of these archives, particularly the southeast and southwest ones (figs. 8–9).¹¹ The written documents allowed her to discover how the neat archaeological considerations related to the social classes of the inhabitants suggested by Starr were false.¹²

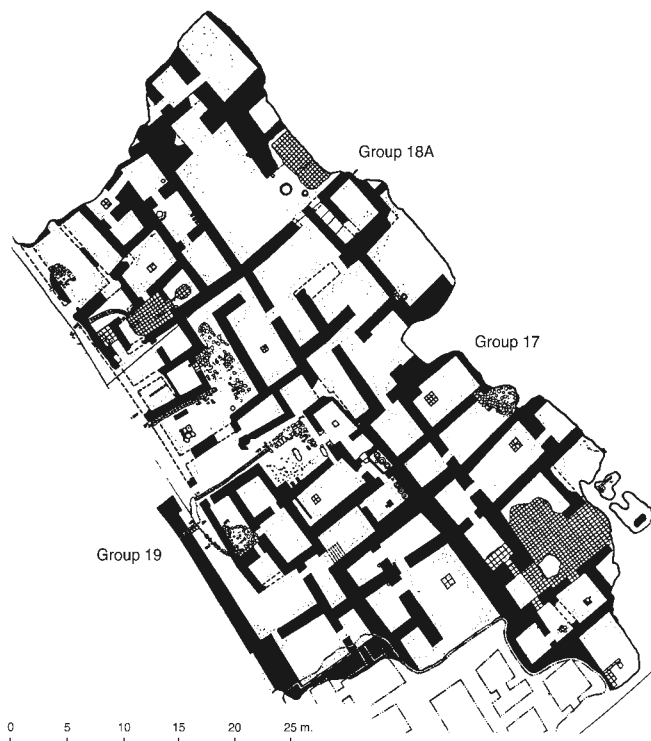

Figure 8. Nuzi, southeast quarter (after Lion, "Archives privées").

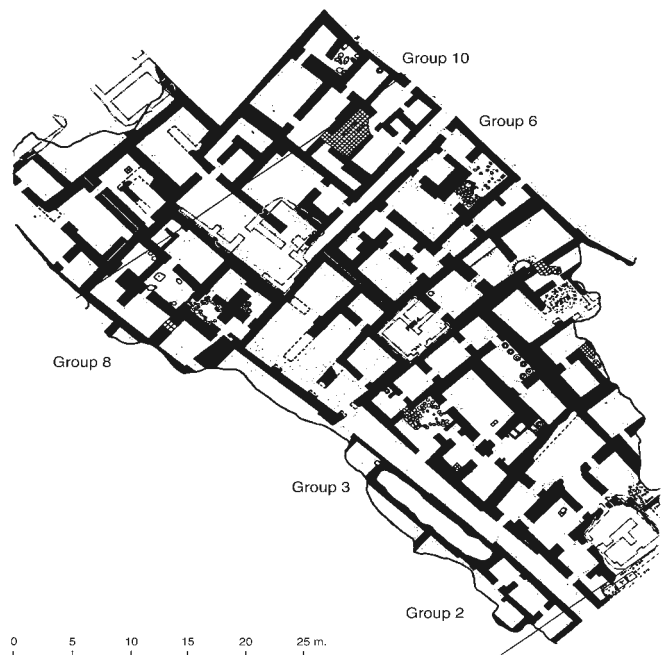

Figure 9. Nuzi, southwest quarter (after Lion, "Archives privées").

⁹ During the aforementioned observations related to the topography of southern and central Mesopotamian towns it was discovered that the role of the canal running inside the town is important. The canal often has not only a deep sacred meaning but also determined some buildings' alignments, for example, in Abu Salabikh and Nippur and presumably Tell Asmar, in Khafajah.

¹⁰ M. A. Morrison, "The Southwest Archive of Nuzi," in *General Studies and Excavations at Nuzi 9/1*, Studies on the Civilization and Culture of Nuzi and the Hurrians 2, edited by M. A. Morrison and D. I. Owen (Winona Lake: Eisenbrauns, 1987), p. 168 n. 6; E. R. Lacheman, *Excavations at Nuzi: Economic and Social Documents*, Harvard Semitic Studies 7 (Cambridge: Harvard University Press, 1958). Recently this subject has also been discussed by B. Lion, "Les archives privées d'Arrapha et de Nuzi," in *Nuzi at Seventy-five*, Studies on the Civilization and the Culture of Nuzi and the

Hurrians 10, edited by D. I. Owen and G. Wilhelm (Bethesda: CDL Press, 1999), pp. 35–62.

¹¹ Morrison, "The Southwest Archive of Nuzi"; M. A. Morrison, "The Eastern Archive of Nuzi," in *The Eastern Archives of Nuzi*, Studies on the Civilization and the Culture of Nuzi and the Hurrians 4 (Winona Lake: Eisenbrauns, 1993), pp. 3–130.

¹² P. A. Miglus, *Städtische Wohnarchitektur in Babylonien und Assyrien*, Baghdader Forschungen 22 (Mainz am Rhein: Philipp von Zabern, 1999); M. Novak, "The Architecture of Nuzi and Its Significance in the Architectural History of Mesopotamia," in Owen and Wilhelm, *Nuzi at Seventy-five*, pp. 123–40. These two recent studies deal with Nuzi's private buildings from an architectural point of view, trying to define different house typologies.

Starr supposed that the southwest quarter housed the upper classes of Nuzi.¹³ However, according to Morrison, it is more probable to connect it to a class of residents that she suggests:

... seem to be urban, middle-class individuals who coexisted with the wealthy suburban landowners ... on the other hand ... represent the group who gave up their property over the generations or who stabilized their position and essentially disappeared from the records.¹⁴

The area on the opposite side of the town has preserved the archives of what Starr,¹⁵ on the basis of archaeology, thought to be a poorer segment of Nuzi society. However, once again according to Morrison, its inhabitants

... were prosperous officials, merchants, and private citizens, hardly the poorer members of Nuzi society as was initially thought. They held positions of authority ... each of these men achieved his social and economic status.¹⁶

The wealthiest segment of society, identifiable with the Tehip-Tilla and Shilwi-Teshub families, proved to occupy the suburban area or, more probably, the northern border of the town. There was a particularly strong relationship between Tehip-Tilla and some of the people living in the residential quarters (figs. 10–11).¹⁷ A careful examination of the published texts proves that a relationship between Tehip-Tilla and the people living in the southwest quarter existed, and the tie was economic in nature.¹⁸

This first step deserves to be widened by seeking a possible relationship of Shilwi-Teshub *mār šarri* with the Nuzi inhabitants. He shows no special relationship with the residents of the southwest area, and the scribal connections between him and these men are poor.¹⁹ When there are scribal connections, they vanish with the following generation, presumably indicating that Shilwi-Teshub's influence in this area tended to diminish as time went on. A closer relation could have existed between this prince and the residents in the southeast quarter; he appeared to

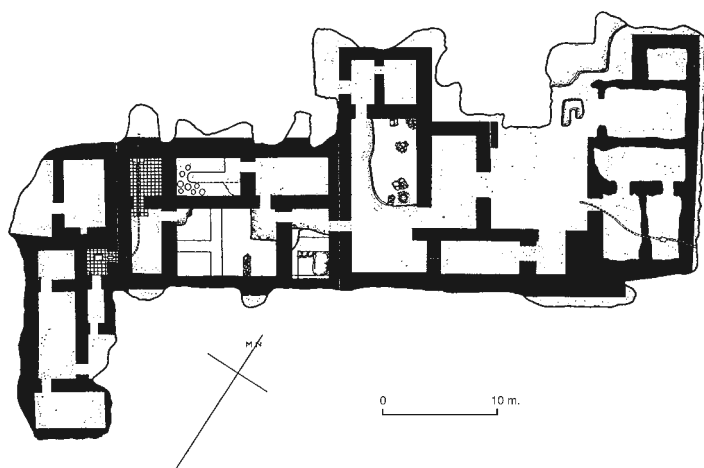

Figure 10. Nuzi suburban houses (after Starr, *Nuzi Excavations*). Tehip-Tilla and his family lived in the western half.

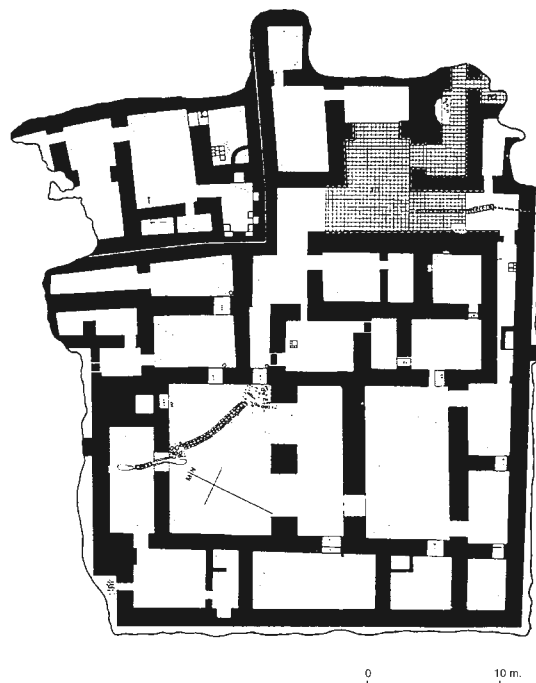

Figure 11. Nuzi suburban houses (after Starr, *Nuzi Excavations*).

¹³ R. F. S. Starr, *Nuzi Excavations* (Cambridge: Harvard University Press, 1939), p. 304.

¹⁴ Morrison, "The Southwest Archive of Nuzi," p. 195.

¹⁵ Starr, *Nuzi Excavations*, p. 321.

¹⁶ Morrison, "The Eastern Archive of Nuzi," p. 123.

¹⁷ See n. 4.

¹⁸ See n. 4.

¹⁹ P. Negri Scafa, "'ana pani abullu šaṭir': Gates in the Texts of the City of Nuzi," in *General Studies and Excavations at Nuzi* 10/2,

Studies on the Civilization and Culture of Nuzi and the Hurrians 9, edited by D. I. Owen and G. Wilhelm (Bethesda: CDL Press, 1998), pp. 154 ff.; P. Negri Scafa, "Criteri e metodologie per uno studio degli scribi di Nuzi," in Morrison and Owen, *General Studies and Excavations at Nuzi* 9/1, pp. 215–24; P. Negri Scafa, "The Scribes of Nuzi," in Owen and Wilhelm, *Nuzi at Seventy-five*, pp. 63–80. In her several studies, Negri Scafa discovered how some scribes performed their duties in particularly strong connection to some of the families dwelling in the town.

be connected with the Ar-tura family (whose archives were found among the so-called Group 17.²⁰ Uthap-tae,²¹ son of Ar-tura, appears as a witness in a text of Shilwi-Teshub DUMU LUGAL.²² The connection between Shilwi-Teshub and a man named Hutya (Group 18A), who was Shilwi-Teshub's "substitute in court on two occasions ... gives out beams of ST on loan, ... witnesses texts involving Shilwi Teshub."²³ Unfortunately, it cannot be proven whether this Hutya son of Kussy is the son of the Kussy known in the archives found in the southeast quarter.²⁴ Moreover, the southeast area was the residence of another DUMU LUGAL named Urhi-kushuk (Group 19) whose activities were centered in a town named Unapshewe and were similar to the activities of Shilwi-Teshub.²⁵ The ties between Shilwi-Teshub and the rich residents of these areas are not exclusive; Tehip-Tilla, too, had some relationships with these men, especially with the Mush-Apu' family (Group 19), though these ties appear less strong than the ones established by Shilwi-Teshub DUMU LUGAL.

One more group of private archives proved of some importance, the interesting sets of tablets found inside the temple (fig. 2). Recently, Jas in his study concerning "Old and New Archives from Nuzi,"²⁶ focused his attention on these texts, which he tentatively relates to people living in the northern ridge of the town. These groups of tablets included at least seven different archives.²⁷

The people mentioned in these texts show weak relationships with the people living in the aforementioned residential areas, even though they showed some inner connections among them (especially of a scribal nature). In this context it seems relevant to ascertain whether some correspondences between these seven different families and Tehip-Tilla or Shilwi-Teshub could really be established. The texts proved that the families that owned these archives held exclusive relationships with Shilwi-Teshub, though these are different from what are expected.

In his study, Jas records all the geographical names mentioned in the tablets to discover where these people carried out their business. The towns that recurred are Ittuhe, Hamena, Kipri, and Al Ilani. These four towns played different roles; the last one is to be identified with Arrapha and was of great importance; the other towns were less relevant.²⁸

As Morrison demonstrates in her study concerning prince Shilwi-Teshub, these four towns are all geographically connected with each other and strictly and exclusively related to the activities of Shilwi-Teshub.²⁹ Tehip-Tilla's business, in fact, seemed to have centered around the western part of the Nuzi surrounding territory far from where Shilwi-Teshub exercised economic control.³⁰

This type of geographical connection is very similar to one ascertained for Tehip-Tilla and the families living in the southern residential areas, for example, the Mush-Apu' family.³¹ They owned land in a district controlled by Tehip-Tilla. This double evidence suggests that the economic relationship between one Nuzi family and one of these two prominent men could also have been based on geographical factors.

According to the tablets, another interesting type of social relationship could be identified. One of the archives stored inside the temple was owned by Hupita son of Hamanna. Following Jas,³² Hupita should be identified as the brother of Ila-Nishu son of Hamanna who, thanks to the identification by Negri Scafa,³³ was the gatekeeper of the *Abullu ša Tišša*. It seems meaningful to note that Ila-Nishu was exclusively connected to Shilwi-Teshub, appearing as gatekeeper exclusively in his texts and appearing only in Tehip-Tilla's heirs' texts.

²⁰ Morrison, "The Eastern Archive of Nuzi," pp. 47 f.

²¹ Morrison, "The Eastern Archive of Nuzi," p. 54.

²² I. J. Gelb, P. M. Purves, and A. MacRae, *Nuzi Personal Names*, Oriental Institute Publications 57 (Chicago: University of Chicago Press, 1943), p. 134. Following this text concerned with Nuzi personal names, Shilwi-Teshub *mār šarri* and Shilwi-Teshub DUMU LUGAL ought to be the same person.

²³ Morrison, "The Eastern Archive of Nuzi," p. 85.

²⁴ Morrison, "The Eastern Archive of Nuzi," pp. 48 ff.

²⁵ A. Fadhil, *Studien zur Topographie und Prosopographie der Provinzstädte des Königsreiches Arraphe*, Baghdader Forschungen 6 (Mainz am Rhein: Philipp von Zabern, 1983). Both of these men seem to be involved in large-scale agricultural activities and to have important commercial relations; they also possess large tracts of cultivable land and presumably several *dimtus*.

²⁶ R. M. Jas, "Old and New Archives from Nuzi," in *Interdependency of Institutions and Private Entrepreneurs* (Proceeding of the 2nd MOS Symposium, Leiden, December 11–12, 1998), edited by A. C. V. M. Bongenaar (Publications de l'Institut Historique-archéologique Néerlandais de Stamboul 97, MOS Studies 2) (Istanbul and Leiden: Nederlands Instituut voor het Nabije Oosten, 2000), pp. 213–28.

²⁷ Jas, "Old and New Archives from Nuzi," pp. 219 ff. The archives are identified as the ones of Kirip-Sheri son of Hut-Teshup, Ila-nishu son of Hapira, Minash-shuk son of Enna-mati, Shurkuja daughter of Ithip-ukur, Itti-sharri son of Turari, Hupita son of Hamanna, Uthap-tae and son.

²⁸ Fadhil, *Studien zur Topographie und Prosopographie*; M. A. Morrison, "Šilwa-Tešup: Portrait of a Hurrian Prince" (Ph.D. diss., Brandeis University, 1974).

²⁹ Morrison, "Šilwa-Tešup: Portrait of a Hurrian Prince."

³⁰ C. Zaccagnini, *The Rural Landscape of the Land of Arraphe* (Rome: Università di Roma, Istituto di Studi del Vicino Oriente, 1979). Fadhil, *Studien zur Topographie und Prosopographie*. Thanks to the observations of Zaccagnini and Fadhil, in this previously mentioned study (see n. 4), it has been proved that the greatest part of Tehip-Tilla's possessions were spread in the western surrounding area of Nuzi.

³¹ Fadhil, *Studien zur Topographie und Prosopographie*. Fadhil examines all the texts connected to each city, to define the activities of all the families who had activities in the different towns.

³² Jas, "Old and New Archives from Nuzi," p. 224.

³³ Negri Scafa, "ana pani abullu šatir," p. 152.

Moreover, the sealing of a tablet in Shilwi-Teshub's archive connects the prince to another well-known gatekeeper: Taika of the *Abullu ša Zizza*.³⁴ This evidence allows us to understand that during Shilwi-Teshub's generation, someone who acted as gatekeeper held a special and exclusive relationship with Shilwi-Teshub.

It seems reasonable to suggest that Shilwi-Teshub and Tehip-Tilla managed their own businesses in different sectors of Nuzi's surroundings. Shilwi-Teshub's businesses were probably centered in Zizza and extended northward in some minor towns which in part corresponded to the ones named in the private family archives stored in the temple. During his generation he appears as the most important man from an economic point of view in one sector of Nuzi surroundings. Moreover, he had particularly close connections to two city gates, the *Abullu ša Zizza* and *Abullu ša Tišša*.

Once again this evidence matches that concerned with Tehip-Tilla and the *Abullu ša Tišša*, where one of the gatekeepers was a nephew of Tehip-Tilla.³⁵ Each of these two men had a privileged relationship, although presumably not exclusive, with the city gate.³⁶

According to Negri Scafa a possible identification of the Zizza gate is with the Northern gate named after the small town of Zizza, whose economic relevance in the Nuzi environment has already been stated, while the *Abullu ša Tišša* should be identified as the western one.³⁷ This small site, located north of Nuzi in an extremely fertile and irrigated area, has a strong connection with Shilwi-Teshub; the tablets of his archive, in fact, allowed Morrison to understand that Zizza was the second main center for Shilwi-Teshub's business.³⁸ Zizza turns out also to be very important in connection with Tehip-Tilla, again for economic reasons.

The data at our disposal seem, therefore, to shape a homogenous frame. Both the topographic and the textual evidence confirm Nuzi society as a hierarchical, rigidly separated, and palatial one. This feature is reflected in the inner division of the town space and in the regular orientation of the buildings. Both the citadel and what has been here supposed to be the lower town were ruled by the same hierarchical and articulated idea of space. Moreover, in my opinion, it seems not to be fortuitous that the two main buildings turn out to have the same orientation as the palace, perfectly fitting the topographical guidelines it determines.

At the same time, it is not a coincidence that the less ordered sector of the inner town is to be seen in the southeast quarter, that is, not only the richest but also the most important one; it is closely connected to a social class able to boast of the closest relation to the palace, even to the prince.

The textual evidence, too, fits perfectly this frame allowing for a more detailed interpretation of how the inner space was used. According to the previously mentioned hypothesis, the southwest area and its inhabitants turned out to be closely connected to Tehip-Tilla. Likewise, the northern ridge, following Jas's hypothesis, proved to have a stronger tie with Shilwi-Teshub *mār šarri*. In the third and last quarter, or southeast area, these kinds of relationships were lacking, and the people living here seem more closely connected to the palace itself.

Moreover, Tehip-Tilla and Shilwi-Teshub both had a special, though not exclusive, relationship with one or more city gates. The locations of these city gates is meaningful: Tehip-Tilla is connected with the western one while Shilwi-Teshub with the western and the northern ones. It is possible to add something more to these observations. Both Tehip-Tilla and Shilwi-Teshub spread their possessions from the northern town of Zizza out toward different areas: Tehip-Tilla once again toward the west, Shilwi-Teshub presumably toward the north. With the exception of the aforementioned town, their authority in these specific areas was exclusive. This balance changed only with the following generations.³⁹

This brief study reinforces the previously suggested hypothesis that a sharp correspondence exists between the inner and outer portions of space at Nuzi, and that this correspondence passes through a privileged relationship with one main city gate.⁴⁰ This strong relationship must involve a sort of control of the Nuzi economic life. Moreover, the renewed analysis of both textual and topographical data gives us a chance to extend the hypothesis connected to this use of space.

³⁴ Negri Scafa, "ana pani abullu šaṭir," pp. 150–51.

³⁵ Negri Scafa, "ana pani abullu šaṭir," p. 148.

³⁶ Both of these two men were personally connected to one gatekeeper, pointing toward their strong presence, or control, of this important town space. Although the number of existing gatekeepers was more than one, their relationship with the gate must be stronger than normal but not exclusive.

³⁷ Negri Scafa, "ana pani abullu šaṭir," pp. 148 and 162.

³⁸ Morrison, "Šilwa-Tešup: Portrait of a Hurrian Prince," p. 369.

³⁹ Fadhil, *Studien zur Topographie und Prosopographie*. The change of the existing balance is possible to understand thanks to Fadhil's study. He has studied all the texts found in relation to each city over several generations. In this way it is possible to observe if the Shilwi-Teshub and Tehip-Tilla heirs were able to maintain their authority in the same region.

⁴⁰ See n. 4.

It seems reasonable to wonder whether the inner organization of the town of Nuzi could refer to the so-called *bābtum*. This kind of social organization has already been identified in southern Mesopotamian towns during the Old Babylonian period. The definition of *bābtum* has been frequently debated in order to understand the social basis on which this organism was founded. Although several different suggestions have been offered by scholars, none of them seems to be completely satisfying.⁴¹ The most convincing one finds the association among the residents of the town in their familiar ties, although a first attempt to relate families to a single quarter of the town was not satisfactory; it may be more productive to connect people to sets of different houses all connected to each other. Some interesting examples of this type of social organization come from Nippur Area TA and Ur Area AH; both of these towns have revealed to archaeological investigations at least one quarter of private houses characterized by the presence of cloistered structures, each one connected with the other to form a topographical and social unit (fig. 12). The evidence from Nippur comes from the TA Area (levels XI–XA, dated to the second half of the eighteenth century B.C.),⁴² as here in the proximity of the so-called House K a set of interrelated buildings was built; most of the people living here were connected, usually by economic ties, to the main important family that owned House K.⁴³

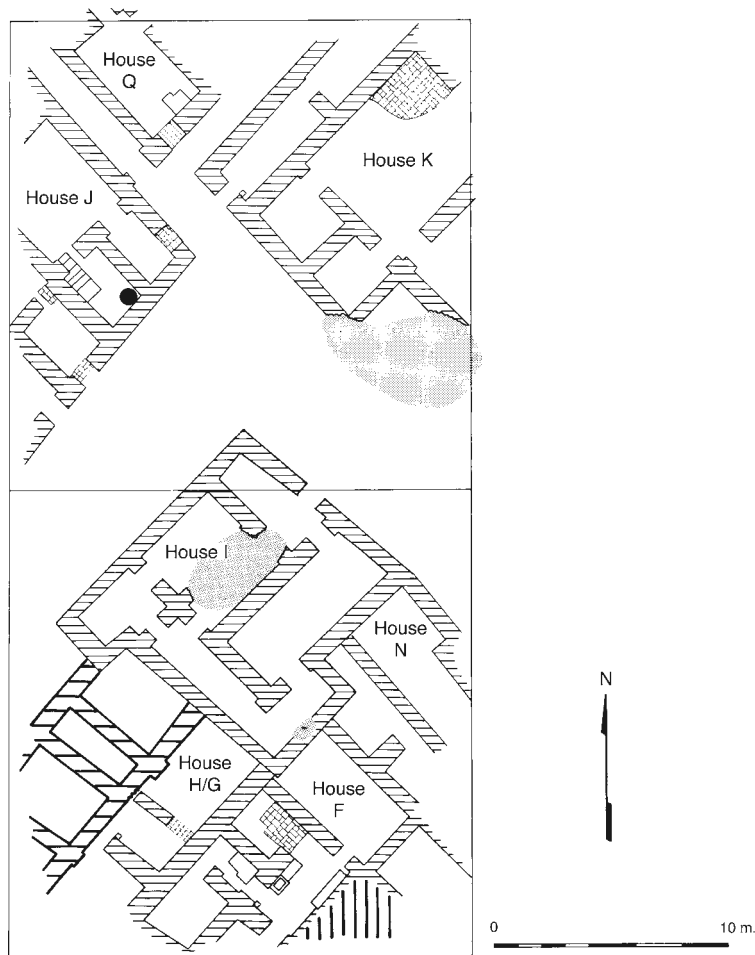

Figure 12. Nippur, Area TA, Level XI (after Stone, *Nippur Neighborhoods*).

⁴¹ See I. J. Gelb, "An Old Babylonian List of Amorites," *JAOS* 88 (1968): 39–46. Gelb interpreted this word as signifying a form of residential unit in a specific part of the town of an ethnic group. Other scholars gave different interpretations of this phenomenon. A. L. Oppenheim, "Mesopotamia, Land of Many Cities," in *Middle Eastern Cities*, edited by I. M. Lapidus (Berkeley: University of California Press, 1969), pp. 3–18, argued that this term could refer to the presence inside the town of some families, whose connection was corporate but without any special connection to the town space. M. Stol, *Studies in Old Babylonian History* (Leiden: Nederlands Historisch-

Archaeologisch Instituut te Istanbul, 1976), on the contrary, suggests that it could refer to the presence of some nomadic group that decided to settle. E. Stone, *Nippur Neighborhoods*, *Studies in Ancient Oriental Civilization* 44 (Chicago: Oriental Institute, 1987), in her study of Nippur, opted for a topographical interpretation. Recently D. Charpin, *Hammurabi di Babilonia* (Rome: Salerno, 2005), referred to a sort of corporation whose connective texture was dealing with the job category; he also argued that it had a juridical character.

⁴² Stone, *Nippur Neighborhoods*, p. 119.

⁴³ Stone, *Nippur Neighborhoods*, pp. 72–74.

Slightly different is the evidence from Ur, where at least two different private quarters have been investigated: EM and AH (fig. 13). The latter is characterized by a crowded layout which has led several scholars to talk about a lawless topographic expansion.⁴⁴ Despite this, some interesting evidence can be pointed out. The buildings seem to be connected to each other, particularly in a block in Paternoster Row formed by houses IV, IVA, VI, VIII, XII, and probably Bazaar Alley I and II. On the whole, these buildings created a sort of *insula* which is spatially cleared by the presence of the two aforementioned streets. Moreover, this idea of topographical unity is supported by two more indications: the common entrance shared by buildings IV and IVA and the inner communication among some structures (that is, IV–IVA, and IV with Bazaar Alley I). Although it is not really possible to make a comparison between the archaeological and the textual evidence, it seems reasonable to suppose that the people dwelling here could be part of a wider unit.



Figure 13. Ur, Quarter AH (after Woolley, *Ur Excavations*).

⁴⁴ C. L. Woolley, *Ur Excavations*, vol. 7, *The Old Babylonian Period* (London: British Museum, 1976), pl. 124.

These data could all point toward the same direction to the presence of an entity called *bābtum*, whose development in the different towns shows different peculiarities, depending on the geographical area and on different chronology. This idea of different development could also explain the problems arising from a univocal interpretation of this phenomenon.

The Nuzi situation differs from that of southern Mesopotamian towns, where no correspondence between architectural units and well-defined social groups can be made.⁴⁵ The so-called Nuzi citadel was divided into at least three different sectors, each occupied by people of the same social segment whose different status is reflected also in the freedom they have in regard to use of public space.⁴⁶ Moreover, the inhabitants of each quarter have a strong and quite exclusive relationship with only one of the relevant public figures of the town, that is, the aforementioned Shilwi-Teshub and Tehip-Tilla. In Nuzi this is no longer visible in the topographical connection or in the familiar tie but is now transformed into something different. It is actually difficult to determine the social connections among Nuzi inhabitants on exclusively archaeological evidence. The southwest and southeast archives and the archive stored inside the temple reveal that the typical link between the inhabitants is of economic or juridical nature; their relationships are also revealed by the use of the same scribes.⁴⁷

These ties are not of an equal nature. The people living in Nuzi, like the inhabitants of Nippur, have weaker connections among themselves, but they are all related to the main economic figure of the town in a strictly hierarchical way.

This evidence could point toward a modified relationship among the dwellers of Mesopotamian towns, which lose their familial ties in favor of new relationships of an economic nature. Such a new frame refers both to a different way of organizing the town space in southern and northern Mesopotamia or to a frame of social crisis where the familial ties lose importance in favor of economic and juridical ones. This latter hypothesis fits perfectly the social crisis during the second half of the second millennium B.C.

⁴⁵ It is difficult to establish a secure connection between the archives stored in the temple and the different house units of the northern ridge of the town.

⁴⁶ The inhabitants of the southeast area, which is the most relevant from a socioeconomic point of view, occupy the southern side of the street that borders the palace itself.

⁴⁷ Negri Scafa, “*ana pani abullu šaṭir*,” pp. 155 ff. Negri Scafa carefully studied the distribution of the scribes according to the place of writing and was able to connect the scribes to the owners of the archives. In this way she discovered possible relationships of the families through the use of some specific scribes.

THE ORIENTAL INSTITUTE AND ITS ROLE IN MESOPOTAMIAN ARCHAEOLOGY

McGuire Gibson, The University of Chicago

Mesopotamian archaeology has the advantage over all other areal specialties of having written records inscribed on clay, the most permanent medium ever invented. No other area of archaeology can count on hundreds of thousands of items from several millennia that record everyday administration, accounting, and commerce, including tracking devices, such as tags from containers. Sealings with impressions of stamp seals and cylinder seals give us a related body of material to be used in analyses that can yield information not only on economic life, but also on the social networks that formed it. Of course there are economic and other documents on papyrus that complement the monumental inscriptions in Egypt, and inked ostraca used in several civilizations, and the wooden records with a cursive script of South Arabic in Sabea civilization. But these did not have the permanence of clay tablets with impressed writing.

From its inception, the Oriental Institute acknowledged the necessity to combine the evidence from inscribed objects with that of the other artifacts. This was not a wholly new idea; the German teams at Babylon and Assur did record findspots of texts, but the information was not exploited until years later by Olof Pedersén.¹ Woolley at Ur recorded texts, but was not systematic about it, and the information was relegated to philological publications.

The Institute's expedition to Khorsabad might have been an ideal place to correlate texts and context, but there were few non-monumental inscriptions. Henri Frankfort's Diyala Expedition of the 1930s was exemplary not only in recording the exact findspots of tablets and other inscribed items, but in the person of Thorkild Jacobsen, who was a remarkable archaeologist as well as a philologist, it had someone who was aware of the importance of relating the tablets to the other material items in context. The mass of inscribed material, however, made it difficult in that pre-computer age to correlate findspot with kind of text, or content of text with the artifacts found in a locus. The first Diyala publication on the so-called Gimilsin Temple and the Palace of the Rulers² did incorporate information from tablets, but essentially only as a means of dating levels. The roughly 1,200 texts from the complex were not to be analyzed in detail and put back in their context until the 1990s by Clemens Reichel.³ The Tell Asmar expedition's excavation of the Northern Palace, done by Seton Lloyd and written up by him, rightly concluded that this was an Akkadian building that included fragments of tablets that could be related to a group of Sargonic tablets that had been bought in a dealer's shop in Baghdad. Jacobsen read the texts initially, and Gelb later published them as MAD 1,⁴ concluding that the palace was a royal establishment in which hundreds of women worked making textiles. Unfortunately, when Delougaz was preparing the archaeological monograph,⁵ he changed Lloyd's manuscript chapter, entitled "The Akkadian Palace," to make the palace a "Protoimperial" building that, he suggested on little evidence, was for the manufacture of metal objects or for tanning. Having been the editor's assistant at that time, and having heard the conversations in which those changes were being made, I knew that there was a need for a new look at the Northern Palace. A full analysis of the field records and unpublished objects in the Oriental Institute allowed me to offer a correction in 1982.⁶ I am happy

¹ Olof Pedersén, *Archives and Libraries in the Ancient Near East, 1500–300 B.C.* (Bethesda: CDL Press, 1998); "Gruft 45 in Assur und das Archiv des Babu-aa-iddina," in *Von Uruk nach Tutul: Eine Festschrift für Eva Strommenger, Studien und Aufsätze von Kollegen und Freunden*, edited by B. Hrouda et al. (Munich: Profil, 1992), pp. 163–69; "Private Archives in Assur Compared with Some Other Sites," *State Archives of Assyria Bulletin* 1 (1987): 43–52.

² H. Frankfort, S. Lloyd, and T. Jacobsen, *The Gimilsin Temple and the Palace of the Rulers at Tell Asmar*, Oriental Institute Publications 43 (Chicago: University of Chicago Press, 1940).

³ Clemens Reichel, "Political Changes and Cultural Continuity in the Palace of the Rulers at Eshnunna (Tell Asmar) from the Ur III

Period to the Isin-Larsa Period (ca. 2070–1850 B.C.))" (Ph.D. diss., University of Chicago, 2001).

⁴ I. J. Gelb, *Sargonic Texts from the Diyala Region*, Materials for the Assyrian Dictionary 1 (Chicago: University of Chicago Press, 1952).

⁵ P. Delougaz, H. Hill, and S. Lloyd, *Private Houses and Graves in the Diyala Region*, Oriental Institute Publications 88 (Chicago: University of Chicago Press, 1967).

⁶ M. Gibson, "A Re-evaluation of the Akkad Period in the Diyala Region on the Basis of Recent Excavations at Nippur and in the Hamrin," *American Journal of Archaeology* 86 (1982): 531–38.

to report that excavations in 2001 by Dr. Nawala Mutawelli of the Iraqi State Board of Antiquities at Umma revealed private houses built of plano-convex mudbricks with pottery that Delougaz would have called “Protoimperial” as well as Sargonic texts dated to Naram Sin (personal observation on site, 2001). There is still an opportunity for reworking aspects of the Diyala records, and one of my current students will most probably do her doctoral research in the Early Dynastic and Akkadian ranges of private houses.

Jacobsen in 1937 pioneered in bringing surface survey to Iraq, with his investigation of 190 sites and the visible or assumed canals that linked them.⁷ This survey, along with other surveys in the Amuq, around Alishar in Turkey, and in the area of Persepolis in Iran, reflected the regional aspect that the Institute took as a major emphasis in all of its archaeological work at that time. Erich Schmidt’s aerial photography⁸ was an adjunct to surface reconnaissance and a precursor to the remote sensing operations of the Institute today. Another major emphasis of all the Institute’s operations in the 1920s and 1930s was the establishment of vertical controls through stratigraphic trenches and the publication of ceramic chronologies.⁹

Jacobsen, as Director of the Oriental Institute in 1948, was instrumental in encouraging Robert Braidwood to mount the first archaeological project that sought to answer critical questions on the domestication of plants and animals by means of an interdisciplinary team.¹⁰ Jacobsen also decided at that time that the Institute should begin excavations at Nippur, initially as a joint expedition with the University of Pennsylvania. Jacobsen’s stated purpose¹¹ was to expose the findspots of Sumerian literary texts that had been discovered on Tablet Hill by the 1890s Pennsylvania expedition, and in the process, of course, to recover a lot more Sumerian literary texts. Once again, in this operation, epigraphers worked closely with the archaeologists, but unfortunately, the texts went into a separate catalogue, and the archaeologists paid little attention to what was in them, other than evidence of dating. At the same time, the epigraphers generally ignored the archaeological context. Had the team really been collaborating and deriving information from one another on a daily basis, the archaeologists would have become aware of the fact that they were digging on an ancient slope and were mixing material from different periods. If they had been recording their baulks, as is now routinely done, they would have recognized their stratigraphic error, but in those days, the attention to baulks was not a standard practice in Mesopotamian archaeology. As a result, the excavators published,¹² for instance, one stratum (IV) in Trench TA as dating from the “Assyrian” (i.e., early first-millennium) buildings and artifacts that were actually datable to the Kassite period at the northern end, “Assyrian” in the middle, and Achaemenid at the southern end. A group of Kassite tablets found in a house at the northern end should have signaled a problem with this level, but the archaeologists never knew of them once they had turned them over to the epigraphers. The tablets went unpublished for many years. This systematic set of errors went unnoticed until, in the 1980s, James Armstrong was able to restudy the notes, which had recorded findspots of texts as well as other artifacts, and disentangle the stratigraphy in a brilliant Ph.D. dissertation.¹³ Elizabeth Stone had, earlier, proposed a reworking of the earlier levels of the TA/TB trenches.¹⁴

The collaboration with Pennsylvania ended after three seasons, and the American Schools of Oriental Research became Chicago’s partner until 1962, during which the expedition exposed the important sequence of rebuildings of the Inanna Temple. From 1964 onwards, Chicago continued at the site on its own. The focus of the ninth and tenth seasons (1964/65, 1966/67) was on the ziggurat area. It was proposed that the team should completely re-excavate the Parthian Fortress that had incorporated the ziggurat. Then it would remove the later material so as to make it possible to investigate the early levels of the complex dedicated to Enlil. Once having exposed the impressive, though fragmentary, Parthian structure, however, it was decided that it should remain as a tourist attraction, and the work on the ziggurat complex was abandoned.

⁷ This work, though never published in detail, was the basis for the more systematic survey carried out by him with Fuad Safar and R. McC. Adams in 1957/58; the most substantial result of that survey was Adams’ *Land Behind Baghdad* (Chicago: University of Chicago Press, 1965), in which (p. vii) Jacobsen’s role in pioneering survey is discussed. But also see T. Jacobsen, *Salinity and Irrigation Agriculture in Antiquity: Diyala Basin Archeological Project, Report on Essential Results June 1, 1957 to June 1, 1958* (Baghdad, Iraq Development Board, 1958), republished as *Bibliotheca Mesopotamica* 14 (Malibu: Undena, 1982).

⁸ *Flights over Ancient Cities of Iran* (Chicago: University of Chicago Press, 1940).

⁹ E.g., P. Delougaz, *Pottery from the Diyala Region*, Oriental Institute Publications 53 (Chicago: University of Chicago Press, 1952).

¹⁰ R. J. Braidwood et al., *Prehistoric Archaeology along the Zagros Flanks*, Oriental Institute Publications 105 (Chicago: Oriental Institute, 1983).

¹¹ In correspondence with officials of the University of Pennsylvania Museum, Nippur records archive, Oriental Institute.

¹² D. McCown and R. C. Haines, *Nippur I: Temple of Enlil, Scribal Quarter, and Soundings*, Oriental Institute Publications 78 (Chicago: University of Chicago Press, 1967).

¹³ “The Archaeology of Nippur from the Decline of the Kassite Kingdom Until the Rise of the Neo-Babylonian Empire” (Ph.D. diss., University of Chicago, 1989).

¹⁴ *Nippur Neighborhoods*, Studies in Ancient Oriental Civilization 44 (Chicago: Oriental Institute, 1987).

When I took over the directorship at Nippur in the eleventh season, 1972, we deliberately turned our attention away from the ziggurat area and Tablet Hill in order to investigate the West Mound, trying to establish the location of administrative, private, and other non-religious functions of the city. Ironically, the first operation we opened, WA, exposed yet another temple, which for some years was not identified. But we did also find an Old Babylonian house below parts of badly damaged administrative buildings of the Kassite period and the early first millennium in Area WB.¹⁵ A group of tablets used to fill in a grave proved to be the governor's archive of this latter period.¹⁶ At that time, I established for the first time at the site the routine use and recording of squares and baulks in order to re-establish the sequences of pottery and other artifacts, and a system that allowed a closer tracking of objects from findspot to catalogue. Although it seems improbable now, at that time, there were to my knowledge no expeditions using squares and baulks in excavation in historical periods in Iraq, although they were routine in prehistoric sites. In the twelfth season I ended the practice of keeping a separate tablet catalogue, both as a signal that tablets are artifacts and have to be studied in context with all other artifacts, and to force the archaeologists and epigrapher to talk to one another about the contents and context of the tablets. We also began in 1972 to incorporate scientific specialists, as had become routine in prehistoric excavations but not yet in historic ones. There was at that time the sometimes-spoken assumption that because we had tablets in historical periods, we did not need evidence from bones, shells, seeds, and soils. But having started to save such material systematically, it became obvious that the texts tell only what the scribes were dealing with, not the full record, and that bones often give better indications of function and change in buildings than any other kind of artifact. We began a long-term study of the ancient soils and environment around Nippur, trying to see the city in its regional context, partly by incorporating the survey results of Adams¹⁷ and hoping to do some small site investigations of our own, although such regional excavations were almost never permitted. At about the same time the Ghent team at Tell ed-Der began very similar environmental investigations. Very soon, we formed a close working relationship with the Belgian expedition, with a major aim of publishing a definitive corpus of second-millennium pottery, which is still in preparation. Out of this cooperation have grown two important volumes, *Dating the Fall of Babylon* and *Changing Watercourses in Babylonia*.¹⁸

The Ghent expedition was fortunate enough to expose a burned building belonging to Ur-Utu, containing in situ hundreds of texts. For once, the recovery of these texts was done right, and we have the opportunity here of seeing how the Old Babylonian scribe arranged texts; in short, we have a chance to view the mental template in a way that has been lost in other cases. I think in particular of the library found in the administrative wing of the temple of Shamash at Sippar.¹⁹ This is a real library, with shelves built of mudbricks, forming compartments around three sides of a small room. In each compartment were found tablets as they had been left in the Achaemenid period. The Iraqi excavators removed the texts very carefully, noting which ones came from which compartment, and even giving the relationship between those in each compartment. The information was noted on slips of paper that accompanied each text into the expedition house. Unfortunately, philologists of Baghdad University came to view the tablets, and immediately they began to arrange them by type, losing all connection between the texts and the slips of paper. Thus, a glimpse into the mind of those ancient scribes was lost, while at the same time exposing the priorities in the minds of the modern ones.

Throughout the 1970s, we at Nippur were looking back on old records as well as forward to new questions to ask in fresh excavations. Richard Zettler combined architecture, art, and texts for a stunning new assessment of the Inanna Temple in the Ur III period.²⁰ At the same time, we were building incrementally a new pottery sequence, in particular trying to re-establish the material culture correlates of the Early Dynastic and Akkadian periods as well

¹⁵ M. Gibson, *Excavations at Nippur: Eleventh Season*, Oriental Institute Communications 22 (Chicago: University of Chicago, 1975). M. Gibson et al., *Excavations at Nippur: Twelfth Season*, Oriental Institute Communications 23 (Chicago: Oriental Institute, 1978).

¹⁶ Steven Cole, *The Early Neo-Babylonian Governor's Archive from Nippur, Nippur IV*, Oriental Institute Publications 114 (Chicago: Oriental Institute, 1996). *Nippur in Late Assyrian Times* (Helsinki: Neo-Assyrian Text Corpus Project, 1996).

¹⁷ Especially R. McC. Adams, *Heartland of Cities* (Chicago: University of Chicago Press, 1981).

¹⁸ Hermann Gasche, J. A. Armstrong, S. W. Cole, and V. G. Gurzadyan, *Dating the Fall of Babylon: A Reappraisal of Second Millennium Chronology*, Mesopotamian History and Environment 4

(Ghent: University of Ghent; Chicago: Oriental Institute, 1998); H. Gasche and M. Tanret, *Changing Watercourses in Babylonia: Towards a Reconstruction of the Ancient Environment in Lower Mesopotamia*, vol. 1, Mesopotamian History and Environment 5 (Ghent: University of Ghent; Chicago: Oriental Institute, 1998).

¹⁹ Walid al-Jadir, "Une bibliothèque et ses tablettes," *Archéologia* 224 (1987): 26–27.

²⁰ *The Ur III Temple of Inanna at Nippur: The Operation and Organization of Urban Religious Institutions in Mesopotamia in the Late Third Millennium B.C.*, Berliner Beiträge zum vorderen Orient 11 (Berlin: Dietrich Reimer, 1992).

as trying to flesh out the poorly understood second millennium.²¹ We became increasingly aware of gaps in the occupation record at Nippur, signaled by the abrupt stops and starts in the pottery sequence published in *Nippur I*. We began to propose, to a fairly skeptical academic public, that there had been a major abandonment of the site from the reign of Samsuiluna to roughly the end of the fourteenth century, when the city was once again rebuilt. We also became convinced that after the second Isin period, the city was once again abandoned, not to be reoccupied until some time around 800 B.C.²² Our conclusions were echoed for the earlier part of the second millennium in the work of the Belgian expedition. Hermann Gasche's important essay on the abandonment not just of Nippur, but also of most of Babylonia in the reign of Samsuiluna is, in my opinion, one of the most important syntheses in Mesopotamian studies.²³

I want to emphasize the importance for expansion of knowledge of Mesopotamian archaeology of one period, from 1978 until about 1982, in which Chicago and many other institutions were encouraged to put aside routine excavation at their sites in order to take part in salvage archaeology related to the building of the Hamrin, Haditha, and Eski Mosul dams. In 1977, the Nippur expedition had gotten permission, at last, to do a season of excavation at an important pottery-manufacturing site called Umm al-Hafriyat, about 30 km to the east of Nippur. Here, besides exposures of private and public architecture of the Uruk, Akkadian, Ur III/Isin-Larsa periods, we mapped in the positions of over 400 pottery kilns and dated them by kiln wasters. A projected second season had to be postponed to take part in the Hamrin Dam project, where we excavated a group of sites known collectively as Uch Tepe.²⁴ Our return for further investigations at Umm al-Hafriyat was prevented by the Gulf War of 1991.

The 1980s were productive for archaeology in Iraq even though the Iran-Iraq War brought unprecedented difficulties and dangers. Our work at Nippur continued, with important excavations related to the Kassite and early first millennium and the Early Dynastic/Akkadian transition. In this period we also returned to Tablet Hill to re-establish the correct stratigraphy of Trench TA through a new trench, TC. We also renewed excavation at WA, which was now free of most of the dunes that had covered much of Nippur from 1948 until about 1980. New irrigation schemes north and east of Nippur resulted in the rapid diminution of the dune belt that had stretched throughout the center of the alluvium, with Nippur as one of the sites at its westernmost margin. One of the surprises, when the dunes retreated, was the discovery of a small Islamic site not more than 200 meters to the north of the ziggurat. Excavation and surface collections of this village documented the existence of a heretofore unsuspected occupation of the area on a small canal in the Ilkhanid Period (ca. A.D. 1400).²⁵

Our last two field seasons in 1989–1990 were devoted once again to Area WA, where we finally identified the temple as dedicated to Gula. We then planned a ten-year excavation to expose the temple in its entirety, excavating and documenting its history in successive rebuildings, much as the Inanna Temple, just across the canal, had been investigated. We intended to open a 100 × 100 meter trench, allowing us to view not only the temple but also the immediate vicinity around it. In preparation for that program, we spent our 1990 season in Areas WF where Augusta McMahon was engaged in sinking a deep pit as far as she could go, seeking not only to delineate the transition from Early Dynastic to Akkadian, but also to examine the stratigraphy that we would encounter in the larger exposure. At the same time, we began to remove the top of the mound just to the east of WA, in Area WG, where we had the chance of recovering information to show the Sasanian-Islamic transition. Near this area, lower down, we thought we might encounter the findspot of the Murashu Archive, discovered by the Pennsylvania expedition in the 1890s.

The projected program was not carried out due to the International Sanctions, and Nippur, like most Mesopotamian sites, lay fallow. Because of our guards at the site, and the proximity of the police in the nearby

²¹ See, esp., Richard L. Zettler, *Kassite Buildings in Area WC I, Nippur III*, Oriental Institute Publications 111 (Chicago: Oriental Institute, 1993).

²² These findings are summed up in my "Patterns of Occupation at Nippur," in *Nippur at the Centennial*, edited by Maria deJ. Ellis (Philadelphia: University Museum, 1992), pp. 33–54. In that article, although I argued against it, I left open the possibility that there might have been skeleton staffs left around the ziggurat in both the gaps. But I should not have done that. I did not believe then that there were any people left there in those abandonments, and I do not now. There just is no evidence of any continued occupation by anyone at Nippur during those two gaps. The continuity in scribal and ritual traditions has to be accounted for by the relocation of the temple personnel to other cities outside the abandonment zone and their return to Nippur when water was once more restored to the site.

²³ Hermann Gasche, "Le Paléo-Babylonien final: État actuel de la Question," in *La Babylonie au 17^e siècle avant notre ère: Approche archéologique, problèmes et perspectives*, edited by H. Gasche and E. Burger-Heinrich, Mesopotamian History and Environment 1/2 (Ghent: University of Ghent, 1989), pp. 109–43.

²⁴ M. Gibson et al., *Uch Tepe I*, Hamrin Report 10 (Chicago: Oriental Institute; Copenhagen: University of Copenhagen, 1981). M. Gibson et al., *Uch Tepe II*, Hamrin Report 11 (Chicago: Oriental Institute; Copenhagen: University of Copenhagen, 1990).

²⁵ M. Gibson, J. A. Armstrong, and A. McMahon, "The City Walls of Nippur and an Islamic Site Beyond, Oriental Institute Excavations, 17th Season, 1987," *Iraq* 60 (1998): 11–44.

town of Afak, Nippur did not suffer the illicit digging that befell Umma, Umm al-Aqarib, Adab, and other sites in the more isolated reaches of the south during the 1990s. Emergency funding allowed the Iraqi State Organization of Antiquities to establish excavations at several of the endangered sites, halting the looting and revealing important and even unusual public architecture at Umma, Umm al-Aqarib, Tell Shmid, and Zabalam. For the first time, texts from Umma, which have been a mainstay of Sumerian studies, were given an archaeological context.

In another kind of archaeological research, from the late 1960s to the mid-1970s, the Oriental Institute continued its tradition of surface survey in Iraq, as Robert McC. Adams carried out very large-scale surveys in the southern alluvium.²⁶ His work sparked surveys throughout the Middle East and influenced an entire generation, including, most notably, Tony Wilkinson, who has advanced our understanding of ancient and modern landscapes from Greece to Iran and from Anatolia to Yemen, with substantial time spent in Iraq and Syria. Much of his work was done here at the Oriental Institute. His hiring, in the early 1990s, led to the formation of a training program in Geographical Information Systems (GIS) and landscape archaeology at Chicago that is helping to revolutionize our field, especially in times when we cannot work on the ground in Iraq.

Also during the 1990s, although we could not work in Iraq, we could rework old notes with new ideas, and the most notable result has been the dissertation and forthcoming book of Clemens Reichel. His restudy of the Gimilsin temple, now correctly called the Shu-Sin Temple and the Palace of the Rulers, is extraordinary and would have been impossible without computerization. He is suggesting changes not only in stratigraphy, but also in dynastic history. He demonstrates that there were as many as five generations of officials performing the same function over 150 years, keeping positions in their families despite changes not only of rulers, including probably Elamites, but also of dynasties. His work has been part of a project to computerize and publish the projected but not completed *Miscellaneous Objects from the Diyala Region* book, which has gradually evolved from a printed volume or volumes into a Web-based publication of all available knowledge on the Diyala sites.

Another graduate student, Carrie Hritz, is nearing the completion of a dissertation on the ancient landscape of southern Mesopotamia, using survey data from Adams, Wilkinson, and me, as well as satellite images and geomorphological information. Her work addresses grand questions such as the location and history of the major rivers and their settlements. Her work and that of Mark Altaweel,²⁷ who used remote sensing to outline settlement in the Assyrian empire in northern Iraq, have given us the precise locations of more than 6,500 ancient sites. Those locations became important as the war in 2003 was looming. In order to make the military aware that Iraq was not just a desert with a lot of oil, but was the home of the world's earliest civilization with more than 7,000 years of tradition, we furnished the Pentagon with those locations. I have some evidence that there was deliberate avoidance of some archaeological sites.

When the news came of the looting of the Iraq Museum, the Oriental Institute immediately began to put on a Web site pictures of as many artifacts known to be in the Iraq Museum as we could gather, often with the very generous permission of the holders of copyrights. As it became known that certain iconic objects had not been lost, the fact was noted on the Web site. It is probable that our Web site, along with others posted by, for instance, the British School of Archaeology in Iraq, made it difficult or impossible for the thieves to sell important pieces, such as the Warka Vase and the Bassetki Statue, and thus allowed them finally to be recovered. Early on, we also formulated a list of typical items for Interpol, customs officials, and others to use at border crossings. We are continuing to assist the Iraqi State Board of Antiquities by adding continually to the database of looted objects from the museum. We can do this because Lamia al-Gailani has sent a list of stolen cylinder seals by Iraq Museum number, and we can use those to match our own excavation numbers and thereby find a photograph of the items. Thus far, Karen Terras and Alexandra Witsell have identified, scanned, and posted on the Oriental Institute Web site several hundred photographs of the stolen seals from the Diyala, and hundreds more from Nippur, Umm al-Hafriyat, and other sites. They will continue to add items that can be identified from expeditions by other institutions.

The present situation in Iraq is a disaster not only for the people but also for archaeology. The thousands of tablets that are continuing to be ripped out of context from Sumerian and Babylonian sites, although they may be seen as a bonanza to philologists, are in fact worth a fraction in informational value because they have lost their as-

²⁶ In 1967, Adams and Hans J. Nissen had made a reconnaissance around Uruk, published as *The Uruk Countryside* (Chicago: University of Chicago Press, 1972). In the 1970s, Adams carried out a very extensive survey east and south of Nippur and combined the results of that work with his earlier surveys to produce *Heartland of Cities*.

²⁷ "The Roads of Ashur and Nineveh," *Akkadica* 124 (2003): 221–28. "Trade Routes to Hatra according to Evidence from Ancient Sources and Modern Satellite Imagery," *Baghdader Mitteilungen* 35 (2004): 59–86.

sociation with other artifacts and the architecture from which they came. From an inspection I made in May 2003, I can attest to groups of 250 to 300 men working illegally at Adab, Umma, Umm al-Aqarib, Zabalam, and Isin. I also saw massive damage to Umm al-Hafriyat, Girsu, Bad Tibira, Larsa, and numerous smaller sites in the Sumerian heartland. Study of satellite images shows that Shuruppak and other sites are also extensively destroyed. The looting has been going on for more than two years, and there is no end in sight. Recently, it was reported that the looting has reached as far north as the Diyala, with Ishchali and Tell Agrab specifically mentioned.²⁸ We have, effectively lost many of the great cities of Sumer and some of the most important cities of Babylonia. It is doubtful if any expedition will ever go back to some of these cities, since to work there would be like digging lace, tracing the remnants of undisturbed strata between huge and deep robber pits and tunnels.

Until work becomes possible once again in Iraq, we will continue to analyze the condition of sites through remote sensing and will work on our own notes and those of earlier excavators, preparing publications. If they are willing to accept our aid, we will cooperate with our Iraqi colleagues in publishing their findings, especially from the salvage operations at looted sites. When research becomes possible once again, much effort will have to be expended in assessing the damage to sites. We hope for a resumption of survey and excavation in Iraq, sooner rather than later, when we can once more study objects, including texts, in their contexts.

²⁸ Information from local Diyala Antiquities officials.

BRONZE RELIEFS FROM KHORSABAD*

Eleanor Guralnick, Chicago, Illinois

In the course of the three major excavation campaigns undertaken at Khorsabad between 1843 and 1935, a wide variety of worked bronze objects was found. Little of this material has been published. Much was published a very long time ago with drawings (in the nineteenth century)¹ or with poor photographic reproduction (in the late 1930s)² in very expensive, limited edition, folio size volumes and with consequent limited distribution and availability. The nineteenth century publications mainly reside in a few library rare book collections. The subsequent publications of the Louvre bronzes are poorly illustrated or not illustrated at all.³ The repoussé bronze relief from the temple doors and doorway decorations, the subject of this study, provides a particularly interesting body of material. They are analyzed for their intrinsic qualities, and an interpretation of their iconography is offered, based on a group of architectural decorations and inscriptions repeatedly found in association with the bronze relief fragments. The motifs depicted on the Khorsabad reliefs must have a symbolic significance, totally unlike the purely historical subjects of the earlier bronze door decorations of Assurnasirpal II and Shalmaneser III.

For the first time all the known Khorsabad relief fragments are presented together. It will be immediately apparent that there are repeated examples of the same motifs. New, high-quality photographs were made for many of the bronze fragments. Since a few fragments appear to be missing (from the Louvre) and others (in the Iraq Museum, Baghdad) are unavailable for photography, these are illustrated with reproductions of the original drawings, or improved prints from original photographic film.

Paul Émile Botta found worked bronze during his first year of excavation at Khorsabad, but he found no bronze relief. He reported in a letter to Jules Mohl dated June 2, 1843, that he had found flat strips of bronze curved into a ring with a diameter of 0.50 m, an element of the architecture of the monument.⁴ He probably saw them as strips that curved about and were fastened to the door posts functioning as hinges for doors. This and the pivot holes he drew at the interior end of the doorway provide the evidence that there had been a bronze decorated central doorway at A in courtyard I, through façade L into room II (fig. 1).⁵ Victor Place reported that he found twenty-five similar curved strips of metal and identified them as “gonde de porte” or door hinges. They came in a variety of sizes. One large hinge had extensions at its extremities that could fasten it to a door post. Four other large rings of copper had “recumbent tigers” at their ends. All these were found between April 20, 1852, and May 9, 1853.⁶ Gordon Loud found curved strips at the doorway to H13 in the Nabu Temple (fig. 2), referring to them as “tire fragments”⁷ but later

* Sincere thanks are extended to all whose generous assistance made this research and publication possible. Annie Caubet, Conservateur général, and Elisabeth Fontan, Curateur en Chef, Département des Antiquités Orientales, Musée du Louvre, suggested the publication of the Khorsabad bronzes in the Louvre collection and provided excellent new photographs. Geoff Emberling, Director of the Oriental Institute Museum, encouraged the publication of bronzes from Khorsabad in that collection and provided greatly improved new photographs. John Larson, Archivist of the Oriental Institute Archives, made available all the original materials relating to the Oriental Institute Khorsabad excavations. Jean Grant did the photography for the Oriental Institute. Mme. Mireille Pastereaux, Conservateur général, Bibliothèque de l'Institut de France, granted permission to research the many letters of Paul Émile Botta and Victor Place. Mme. Annie Chassagne of the archives of the Bibliothèque facilitated the research. M. Philippe Belgial, Director, Archives de France, granted permission to research the extensive materials relating to Victor Place and Gabriel Tranchand. Jean-Marie Durand of the Collège de France provided a reproduction of the Tranchand colotype.

¹ Paul Émile Botta and Eugene Flandin, *Monument de Ninive*, vol. 2, *Architecture et Sculpture* (Paris: Imprimerie Nationale, 1849), pls.

151, 154.1, 164.1; Victor Place, *Ninive et l'Assyrie*, vol. 3 (Paris: Imprimerie Nationale, 1865), pl. 72.

² Gordon Loud, *Khorsabad*, vol. 2, *The Citadel and the Town*, Oriental Institute Publications 40 (Chicago: The University of Chicago Press, 1938), pls. 49–50.

³ Adrien de Longpérier, *Musée Napoléon III, Choix de Monuments* (Paris: Musées Nationaux, 1868), Nos. 221 and 222, pl. 31.4; E. Pottier, *Khorsabad: Les Découvertes de V. Place en Assyrie* (Paris: Editions Ernest Leroux, 1918), No. 14, p. 82; E. Pottier, *Catalogue des antiquités assyriennes* (Paris: Musées Nationaux, 1924), Nos. 150 and 152, pp. 134–36.

⁴ Bibliothèque de l'Institut de France, File for Paul Émile Botta, Letter D.VII.4, dated June 2, 1843.

⁵ Botta and Flandin, *Monument de Ninive*, vol. 1, *Architecture et Sculpture*, pl. 6.

⁶ Archives de France, F21/546. V. Place, Reports No. 27 and 29, May 9, 1853. Report No. 27 affirms that on March 29, 1853, the bronzes were photographed. It has not been possible to find the current location of these unpublished collotypes. They probably served as models for the published drawings.

⁷ Oriental Institute Archives. Report by Gordon Loud to James Breasted dated December 30, 1933.

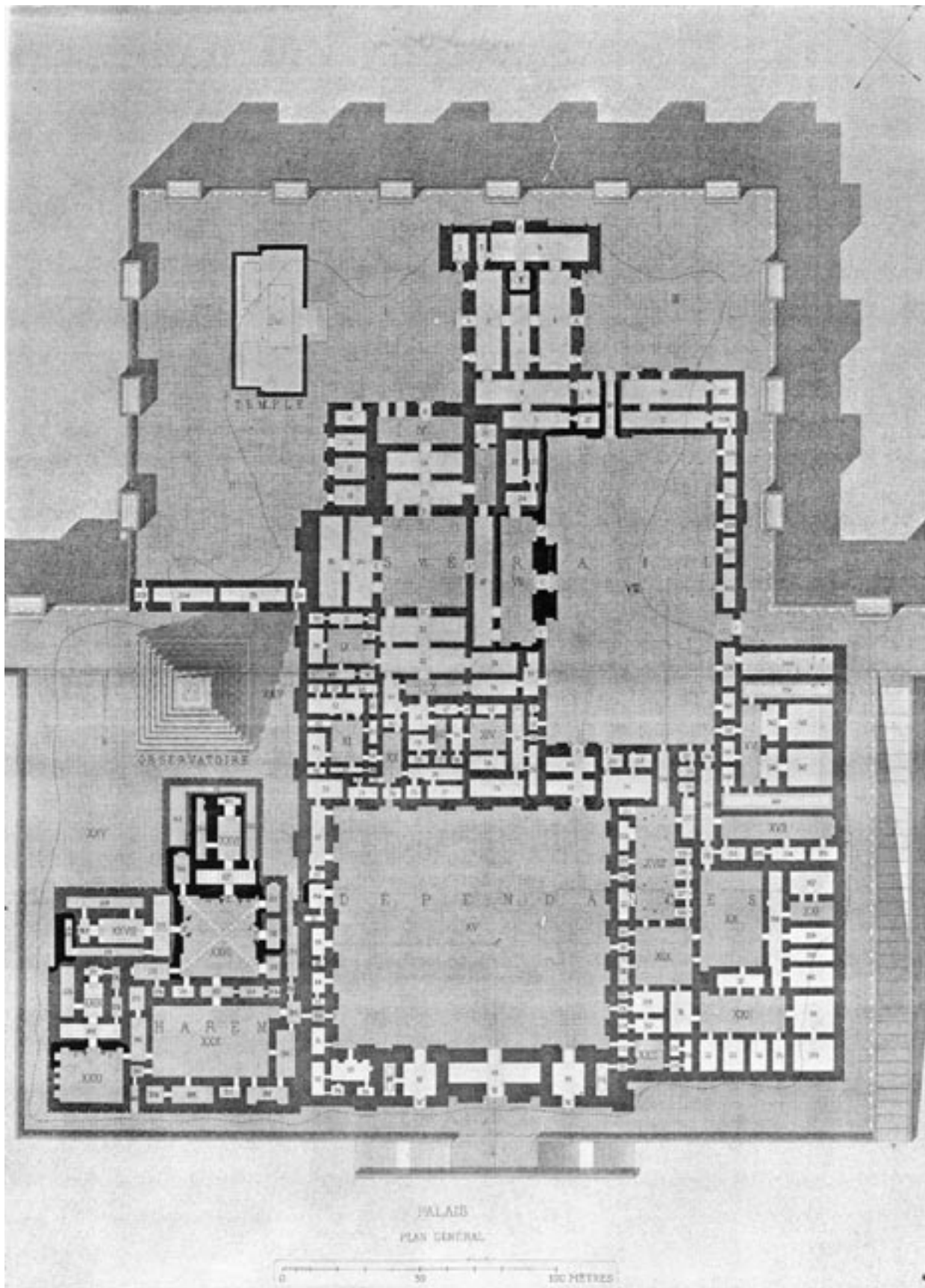

Figure 1. Restored plan of Sargon's Palace at Khorsabad. Palace temples at lower left. Blackened areas indicate portions excavated by the Oriental Institute.

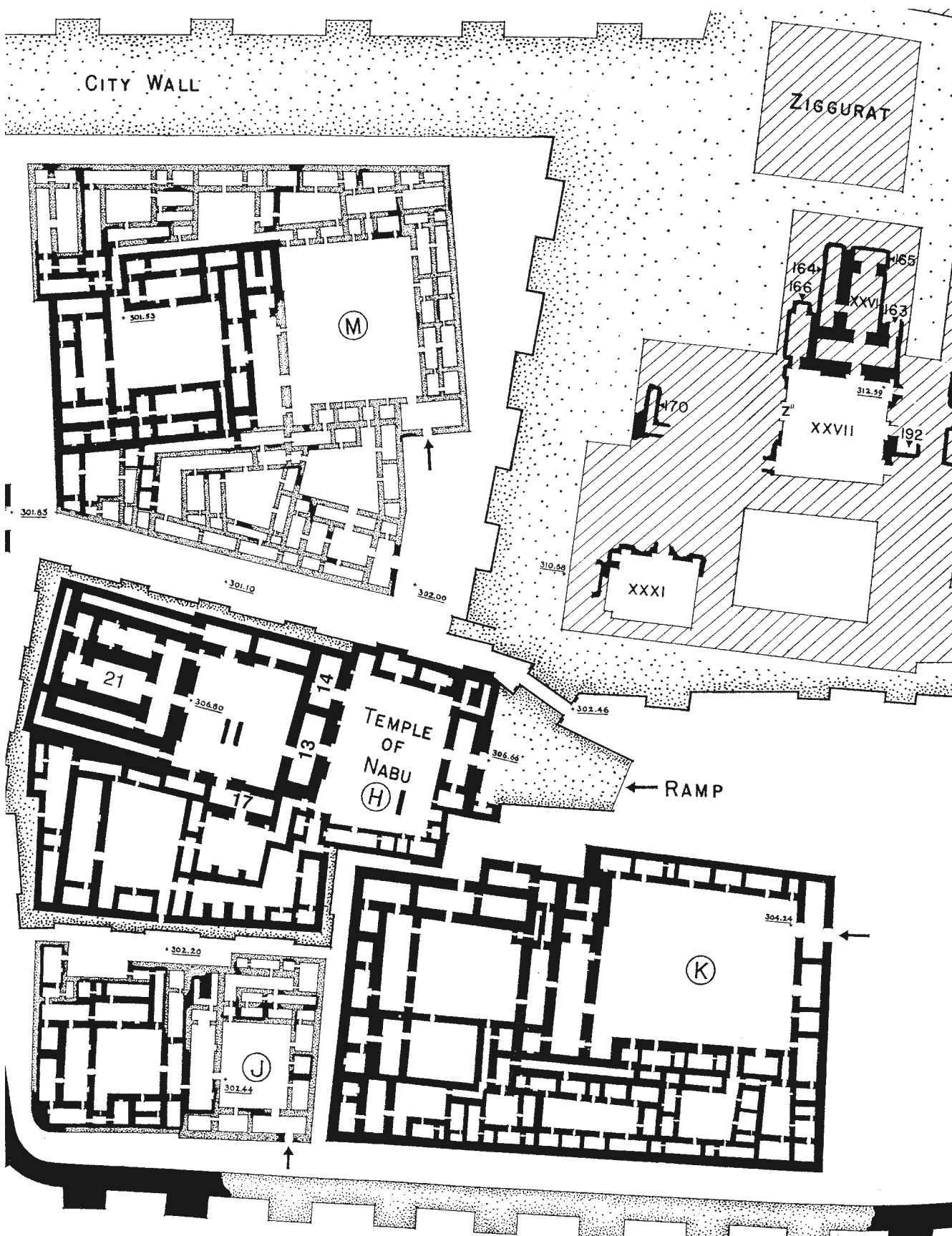

Figure 2. Nabu Temple plan below with palace temples at upper right.

recognized that they must be the same as Place's "hinges." This suggests there were many bronze decorated doors in both the palace and the temples. Fifteen small fragments of worked bronze were found by Loud at the central entrance to the throneroom of the palace. All were thrown away as little if anything could be recognized as representational work. One scrap showing the face of a man was recorded and drawn on graph paper. The fragment itself appears to be lost, although it may have been allocated to the Iraq Museum in the division of finds.

Between 1852 and 1855, Victor Place found ten fragments of bronze relief near doorways in the cluster of six temples adjacent to the palace.⁸ Several fragments were found in the Adad Temple, within room 166. A very large amount of relief worked bronze was wrapped around a fallen 10–11 meter pole just outside the entrance of the Sin Temple, room 167. Other fragments were found at the entrance to the Ea Temple, room 192. Still more fragments were found in Court XXXI, in front of the Ningal Temple, room 180. Specific find places for the small fragments were not recorded.⁹ Six worked bronze fragments survive in the Louvre Museum. Four others could not be located.

Portions of several bronze relief friezes were discovered by Gordon Loud in the Oriental Institute excavations in the 1930s.¹⁰ Three of the Nabu Temple fragments and two registers of frieze from a fallen pole in front of the Shamash Temple are on display in the Oriental Institute Museum. The division apparently assigned a second set of Shamash Temple frieze registers and six fragments from the Nabu Temple to the Iraq Museum. Many undecipherable fragments of bronze were found inside room 13 on the inner threshold of the doorway from the forecourt, or court I of the Nabu Temple. Three substantial pieces of bronze were found inside room 13, near the same doorway. Two of these were found in place separated from one another by a little more than the height of a single decorated band (fig. 3).¹¹ A fourth piece of decorated bronze, with a "mountain" design, was found in the forecourt not far from the same doorway.¹² This fragment is associated with the decorative door bands by Loud although all the other remains of the door bands were found inside room 13. Other surviving bronze fragments were found within room 14. Here, too, they were associated with the doorway and must be the remains of decorative door bands.¹³ Still other fragments of door bands were found in room 17 near the doorway leading to the Central Court.¹⁴ These apparently were not salvageable. Place's dump in Court XXVII near "Z" was found and excavated by Loud.¹⁵ There he found remains of animal figures in good shape, but there is no record that this material was retrieved. Both Place and Loud affirm that there were countless scraps of bronze everywhere that could not be reconstructed and thus were not salvaged. Thus, very little bronze was salvaged in the modern excavations, and a great deal more, in very fragmentary condition, was abandoned at the site. The very fragmentary state of so much of the surviving bronze suggests that we may have mainly the scraps that ancient salvagers neglected to sweep up. The bronze might have been hurriedly salvaged for reuse in ancient times, either when the palace was abandoned or by squatters or still later by passing armies. The Hellenistic jewelry and other artifacts found in association with the doorway between room 13 and the forecourt and in a well in the forecourt itself suggest a Hellenistic army made camp in the Nabu Temple at Khorsabad.¹⁶

Loud's photographs make it clear that the largest fragments of bronze were fastened to heavy wooden door panels at a measured distance from one another (fig. 3).¹⁷ Probably all the surviving flat friezes are portions of bands of door decoration. They functioned in the same manner as the decorated bronze bands of the Balawat Gate. The Khorsabad fragments are much less complete than those. It is clear that they cannot be restored as meaningful historic compositions. Rather, they have enigmatic images, each isolated in space and without an obvious interactive relationship to adjacent figures. The decoration does not continue around the door posts but is restricted to the doors and to the poles framing the entrances. Unique qualities and purposes inform the Sargon bronze door relief. Comparisons reveal that while their function as door decorations may be identical, the nature of the worked decoration from the Sargon temples is totally unlike that of the earlier examples and communicates a different message or at least uses a different symbolism to convey meaning.

⁸ Archives de France, F21/546, V. Place, Report No. 27, affirms that on March 29, 1853, the bronzes were photographed. It has not been possible to locate these unpublished collotypes. They probably served as models for the published drawings.

⁹ Neither the handwritten notes, nor the reports in the Archives de France, nor his publication, *Ninive et l'Assyrie*, have information relating to findspots of specific bronzes, except for a statement that some animal figures were from inside the Adad Temple and that the palm tree formed bronze sheathing was from the right side of the entrance to the Sin Temple.

¹⁰ Loud, *Khorsabad* 2, p. 96, pls. 49–50.

¹¹ Loud, *Khorsabad* 2, pp. 44, 59, 96, pl. 20d–e, 21a–b, 49.20, and 49.21.

¹² Loud, *Khorsabad* 2, p. 96, pls. 50.27.

¹³ Loud, *Khorsabad* 2, pp. 59, 96, pls. 50.22–49.26.

¹⁴ Loud, *Khorsabad* 2, p. 61, pl. 23c–d.

¹⁵ Oriental Institute Archive, Letter from Gordon Loud to James Breasted dated February 27, 1932.

¹⁶ Loud, *Khorsabad* 2, p. 98, pl. 60.

¹⁷ Loud, *Khorsabad* 2, pl. 21 A and B.



Figure 3. Two bronze door strips as found in room 13 of the Nabu Temple. Some remains of the wooden door are visible below bronzes.

The bronze pole sheathing found to the right of the entrance to the Sin Temple had a simple repetitive, scale-like design covering the entire pole to a height of at least 9 meters. The collotype photograph was made by Gabriel Tranchand (fig. 4). It has been assumed that this scale pattern is intended to simulate the trunk of a palm tree. Most likely the basic pattern was hammered into the bronze using a stone mold to form the repetitive pattern. Simple patterns like the palm bark pattern were made with a mechanical uniformity and perfection, enhanced by simple surface tooling making the shapes clear and sharp (fig. 5). Adhering fragments of gold suggest that the sheathing was covered with gold leaf. Place reported that he found a single large piece of curved pure gold “near the mutilated statue,” with the same palm tree pattern as the bronze.¹⁸ A fragment of this gold sheathing is in the Louvre (fig. 6). It displays the same pattern as the bronze mentioned above, suggesting that the bronze sheathing may have been covered in a gold sheathing. Near the pivot stone at the entrance to room 165, the Sin Temple, Loud found gold foil.¹⁹ He also found some minute fragments and beads of gold in the deposit box at the entrance to the Sin Temple.²⁰ In the Nabu Temple, Loud found a quite similar scale-patterned fragment in the forecourt (fig. 7). He referred to the pattern as “mountains.”²¹ He did not consider whether this fragment might have been the remains of decorative pole sheathing similar to the one surviving from the Sin Temple. Since the fragment itself is not available for examination, it is unknown whether it has a curve enabling it to wrap around a pole. The doorway had remains of framing tableaux. Statues and poles are assumed since they have been found with all other tableaux. The single unexamined fragment is insufficient to be certain if the decoration of the poles of the interior façade of Court I of the Nabu Temple was comparable to that of the Sin Temple.

An inscribed tablet asserts that the silver sheets to coat the doors to the Sin, Shamash, and Ningal Temples were made, but the wooden *sarāmûs* were not ready. The letter goes on to say that the five doors to be coated with bronze sheets are finished.²² Instead, a gold pole sheath with palm trunk patterning and gold foil was found in association with the Sin Temple doorway. Gold foil was found at the Nabu Temple inner doorway in Court II.²³ A little gold foil was found in Court XXX in front of the Ningal Temple. Bronze nails with silver foil and gold foil heads were found in association with more than one doorway of the Nabu Temple. The archaeological evidence from the gold pole sheathing, from the gold foil, and gold nail heads makes it likely that at least a few of the temple doorway decorations were actually covered with gold foil. There is no evidence other than the silver foil nail heads to suggest that doors were made of or covered with silver.

¹⁸ Archives de France, F21/546. V. Place, Report No. 29, May 9, 1853.

¹⁹ Oriental Institute Archives, Gordon Loud, Summary for the season 1932/1933.

²⁰ Oriental Institute Archives, Letter from Gordon Loud to James Breasted dated February 20, 1933.

²¹ Loud, *Khorsabad 2*, p. 96, pl. 50.27.

²² Simo Parpola, *The Correspondence of Sargon II*, part 1, *Letters from Assyria and the West*, State Archives of Assyria 1 (Helsinki: University of Helsinki Press, 1987), No. 66.

²³ Oriental Institute Archives, Letter from Gordon Loud to James Breasted dated December 13, 1932.



Figure 4. Palm bark pattern bronze sheathing, Sin Temple, Collotype by Gabriel Tranchand, by permission of the Collège de France.



Figure 5. Palm bark pattern bronze sheathing, Sin Temple, with the permission of the Département des Antiquités Orientales, Musée du Louvre. Photo NIII 3100 by Pierre and Maurice Chuzeville.



Figure 6. Palm bark pattern sheathing in gold, with the permission of Département des Antiquités Orientales, Musée du Louvre. Photo by Eleanor Guralnick.



Figure 7. Palm bark pattern bronze, Nabu Temple, with the permission of the Oriental Institute.



Figure 8. Bronze sheathing, Shamash Temple, with the permission of the Oriental Institute.

A pole from the right side of the entrance ensemble of the Shamash Temple was decorated with two encircling bronze bands, each composed of two registers of repoussé bronze with similar decorations. These were found in place still wrapped about the remains of the pole. About 5 meters of the pole was excavated, with more extending into unexcavated earth. One of these bands, the larger and better preserved one, was assigned to the Iraq Museum in Baghdad; the other is in the Oriental Institute (A12468) and is discussed and illustrated here (figs. 8–12). Each of the separately made bands was curved to sheath a pole 50 cm in diameter. Each band has narrow rosette decorated borders at the top and bottom. A central rosette band is shared by the two registers. A round nail head serves as the center of each rosette. The nail penetrates a round hole in the bronze fastening it to the wooden pole. All friezes from the palace temples are bordered with rosettes. The upper register has a flying bird with outspread wings at the left end (fig. 10), and a man dressed in a decorated kilt facing to the left at the right end (fig. 11). These images frame a central composition with two bulls facing the center of the register where Sargon II stands facing to the left with outstretched arms, grasping the bulls' horns with his hands. The lower register is missing its left portion. Below the king is a fig tree (fig. 9). To its right is a fragment of a plow and grain seeder. These bands are noteworthy for their extraordinary state of preservation and for the outstanding craftsmanship and artistry of the bronze workers. The emphasis on individual figures challenged the workers to make each image one of visual interest.

Each of the motifs on these bands is worthy of examining as examples of outstanding technical skill. The fig tree on the corrosion-free Shamash Temple frieze provides a first example of the sophisticated range of techniques used (fig. 9). The basic forms for this and all other motifs were probably hammered repoussé into carved stone forms. The bronze exhibits exquisite surface tooling to emphasize shapes and to add texture and details. At least six specially made tools were used for this one motif. One impressed and sharpened the general outline and form of the tree and branches. A second and third impressed the special shapes of the leaves and fruit. A fourth fine-pointed tool textured the surfaces of the fruits. A fifth shaped tool created the patterned texture of tree bark. A sixth tool created the textured bark of the branches. There is visual evidence that the additional three surviving examples of the fig tree reflect the same sophisticated tooling (see especially fig. 20 where flowers and fruit are clearly visible on the branches and the trunk is textured with still another shaped tool).

The bird, possibly an eagle, in flight from the upper register of the Shamash Temple band, has remarkable detail of the feather patterns worked into the bronze with very small feathers on the bird's face and several different patterns on the wings, body, and tail (fig. 10). Once again it is obvious that great skill and several unique tools were necessary to create the elaborate feather patterns. The man at the right end of the upper register wears an elaborately decorated kilt (fig. 11). Its decorative pattern consists of horizontal rows with concentric squares alternating with horizontal rows of squares enclosing rosettes. The kilt border has a broad band enclosing a row of large rosettes, framed top and bottom with an outlined narrow band each filled with a line of dots. The hair and beard are comparable to that of large sculptured figures with each hair strand crisp and tactile. Plastic curls terminate both the hair and beard. Smaller curls divide the beard into sections, filling the uppermost portion from ears to below the mouth. Tooling outlines the figure, enhancing its crisp separation from the background. The musculature of the hands, ears, face, legs, arms, and torso are all enhanced by additional tooling.

The central figure of Sargon is yet another example of outstanding metalworking (fig. 12). His face, hands, hair, and beard are as complexly executed as those of the kilted man. In this case he is wearing a singular long garment, elaborately fringed, decoratively belted, and bordered both horizontally and vertically with rosettes of several patterns. The bulls on each side show anatomical detail surprising on such small-scale figures. The bulls' legs and bodies have strong articulation of the muscles, folds of skin, bone, sinew, and veins, emphasized by surface tooling. Multiple special tools created the curls on the backs and undersides of the animals. These include simple circles, circles with central dots, curls, and the striations of hair. All this detail is achieved in figures about 18 cm tall. It is obvious that only an outstanding group of metalworkers could have achieved this complex and varied product. The crafting of the tools themselves speaks to the outstanding command of the bronze-working art.

There are a number of male figures from the temple door bands. A well-preserved man from room 14 of the Nabu Temple faces to the left, wears the long fringed garment of courtiers, and has a vertical staff in his left hand (fig. 13). Every strand of his hair and beard and each strand of fringe is tooled. His profile face is distinctive show-



Figure 9. Tree bronze from the Shamash Temple pole, with the permission of the Oriental Institute.



Figure 10. Bird from the Shamash Temple pole, with the permission of the Oriental Institute.



Figure 11. Man in kilt, Shamash Temple pole, with the permission of the Oriental Institute.



Figure 12. Sargon II between two bulls, Shamash Temple pole, with the permission of the Oriental Institute.



Figure 13. Man in long fringed garment with staff, with the permission of the Oriental Institute.

ing a unique human being. A second fragment from the same room depicts a portion of a man facing to the right in the same type of fringed garment (fig. 14). He carries a vertical spear with the point near the ground. The tooling on the fringes separates them into tightly packed vertical strands. A third male figure from the palace temples survives only in a drawing.²⁴ The entire upper body and head are missing. He faces left toward something large, possibly a fence or a bush (fig. 15). He wears a long garment with fringed hem and a decorated belt. He carries a vertical staff in his left hand. His right hand is raised with palm turned outward. There are two additional figures from the palace temples. A fragmentary left-facing male bearded figure holding up his right hand, possibly holding a mace, from the palace temples is in the Louvre (fig. 16). This figure wears a highly decorated kilt covered with a pattern of small concentric circles and a broad belt separated into horizontal panels with internal decoration. His beard is also the product of surface tooling in a pattern alternating horizontal and vertical areas. A fifth surviving figure of a man is followed by an open-mouthed lion, both facing to the left and both worked into the same large panel (fig. 17). The bearded man is carrying a mace in his right hand. He wears a shirt and kilt elaborately decorated with a pattern of incised circles with raised centers and a horizontally striped belt. His hair is arranged in a distinctive fashion, lying in broad flat bands across the top of his head, falling into a cluster of four large curls. The hairstyle may be compared with that of the kilted so-called Gilgamesh at the entrance to the palace.²⁵ A terra-cotta statuette with the same motif was also found at Khorsabad.²⁶ The mythological male figure with three or four large curls has a history in Mesopotamia that goes back at least to the Royal Cemetery at Ur and seems to have had a revival of representation during Sargon's reign. The partially surviving figure of the lion with open mouth has sharp pointed teeth and tongue surface tooled. The mane, too, is elaborately tooled with a pattern of flame shapes next to the face, followed by a pattern of curves, a single long heavily-emphasized curl dangles down from near the ear, and an incised diamond pattern covers the rest of the mane. The lion's power is made emphatic by its strong musculature, powerful claws, and the facial detail. The figures are reminiscent of those on the tableaux where the figure of Sargon is followed by a lion.



Figure 14. Fragmentary man with staff, with the permission of the Oriental Institute.



Figure 15. Man with staff facing fence(?), after Victor Place, *Ninive et l'Assyrie*, vol. 3, *Inscriptions*, pl. 72.

²⁴ Place, *Ninive et l'Assyrie*, vol. 3, *Inscriptions*, pl. 72.

²⁵ *Encyclopédie Photographique de l'Art* 5: n. 10 (Paris: Éditions 'Tel,' 1936), pl. 304; Andre Parrot, *The Arts of Assyria* (New York: Golden Press, 1961), p. 32, fig. 36.

²⁶ Botta, *Monument de Ninive*, vol. 2, *Architecture et Sculpture*, pl. 154.



Figure 16. Man with circle décor garment, with the permission of the Département des Antiquités Orientales, Musée du Louvre. Photo NIII 3099 by Pierre and Maurice Chuzeville.

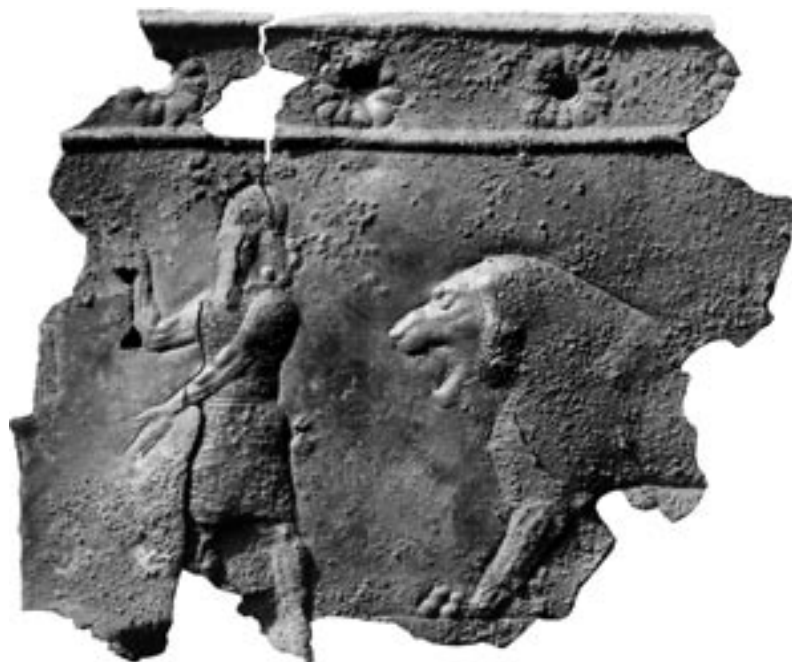

Figure 17. Man with four curls followed by a lion, with the permission of the Département des Antiquités Orientales, Musée du Louvre. Photo NIII 3099 by Pierre and Maurice Chuzeville.

Wherever the borders of the friezes from the Nabu Temple survive they are bordered with guilloche (fig. 18). Three examples of bulls survive, one from the Nabu Temple (room 13) and two from the palace temples. Although they are all easily recognized as bulls, they are not precisely alike. All three surviving bronze bulls walk toward the left. The preserved legs of the bulls emphasize the powerful musculature of the animals. Thanks to the reduced corrosion on two of the bulls, the excellent quality of the craftsmanship involved in their manufacture is visible. The Nabu Temple bull (fig. 18) has a powerful and muscular, clean and undecorated body, except for a series of wavy vertical skin folds represented at the front of the neck and chest. He holds his head perpendicularly to the ground, with his snout squared and parallel to the ground. His horns are worked repoussé near the root, gradually being transformed into incised points. Behind him is a branch. The palace temples' bulls hold their heads up. One bull has a fleshy chin and traces of several branches to his right (fig. 19). The hammered, curved wrinkles of skin framing his face and neck have surface-added curls of concentric circles with raised centers. Vertical striations suggest straight hair on his chest. Across the back from the ears to the tail are short vertical striations indicating short straight hair. The second palace temple bull is missing its head, but the position of his neck suggests that he is holding his head in about the same position as the first (fig. 20). Concentric circles have been surface worked in a broad swath over his back, haunch, and belly. The rear legs show a particularly emphatic musculature and bone structure. The branches of a fig tree are very clear behind him. The outline has been sharpened with an enhancing or impressing tool. At least three specially shaped tools were used to impress the shapes of flowers, fruit, and texture to the tree bark. A similar selection of special tools provides details on the fig tree of the Shamash Temple friezes (fig. 9). The same juxtaposition of motifs, a bull followed by a fig tree, is seen on the glazed brick tableaux that frame four major entrances in the palace temple complex and two in the Nabu Temple (fig. 21).

A fragment from the Nabu Temple with a grain seeder (fig. 22) and two fragments with details of plows from the palace temples (figs. 23 and 24) illustrate fragmentary plows with grain seeder. The Nabu Temple grain seeder combines incision with repoussé. Comparison of the surviving details with the comparable details of the image on the tableaux is persuasive of the identification. The discovery of a fragmentary, but "beautifully executed bird" in the Nabu Temple is recorded in the Oriental Institute Archives.²⁷ It was never photographed, drawn, or published. At one of the palace temples Place found a fragment showing only wings and perhaps a tail of a bird (fig. 25), here

²⁷ Oriental Institute Archives, Report written by Gordon Loud December 20, 1932. Fragments were found in Courtyard II of the Nabu Temple among other bronze fragments.



Figure 18. Bull, Nabu Temple, room 13, with the permission of the Oriental Institute.



Figure 19. Bull with fig tree branch at right, from palace temples, with the permission of the Département des Antiquités Orientales, Musée du Louvre. Photo NIII 3099 by Pierre and Maurice Chuzeville.



Figure 20. Bull with fig tree at right, from palace temples, with the permission of the Département des Antiquités Orientales, Musée du Louvre. Photo NIII 3099 by Pierre and Maurice Chuzeville.

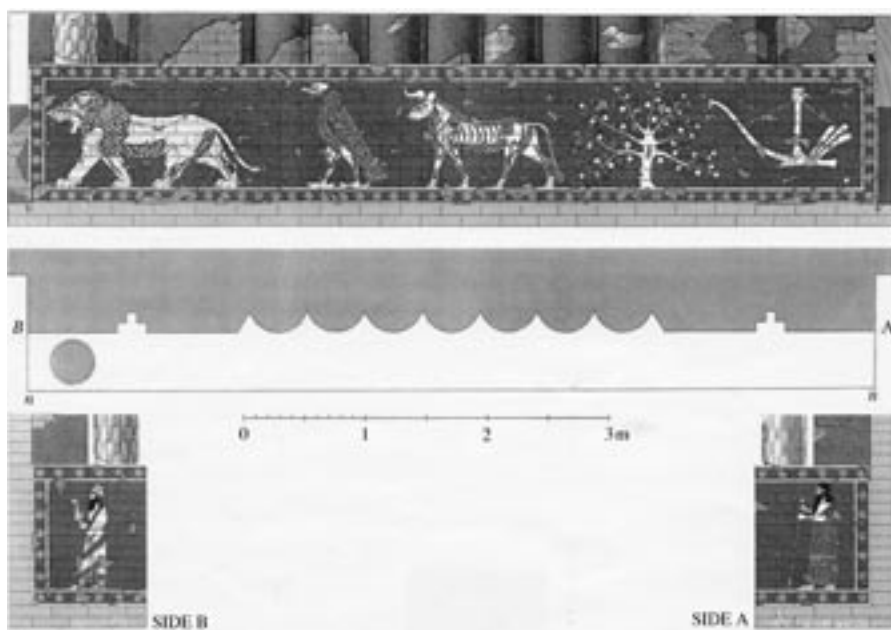

Figure 21. Glazed brick tableaux from the right façade of the Sin Temple, as drawn by Victor Place.

illustrated with a reproduction from the original Place publication.²⁸ While lacking a certain image of Sargon, these images from the fragmented door panels otherwise precisely parallel the images on the tableaux: a lion, a bird, bulls followed by fig trees, seeder-plows, and men in long fringed garments carrying spears. The Shamash Temple pole has a rather similar selection of motifs with the exception that it has two bulls rather than a lion and a bull, and a kilted man without a spear.



Figure 22. Grain seeder from plow, Nabu Temple, room 14, with the permission of the Oriental Institute.



Figure 23. Fragmentary plow with grain seeder, palace temples, after Victor Place, *Ninive et l'Assyrie*, vol. 3, *Inscriptions*, pl. 72.

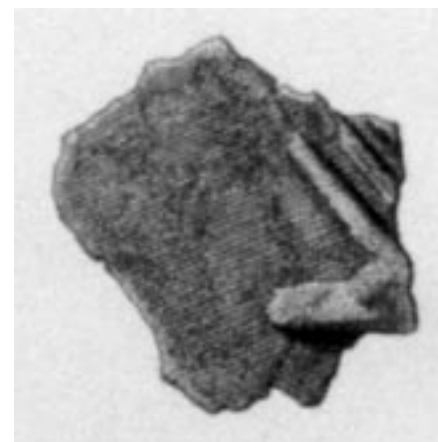

Figure 24. Fragmentary plow with grain seeder, palace temples, after Victor Place, *Ninive et l'Assyrie*, vol. 3, *Inscriptions*, pl. 72.



Figure 25. Bird wing and tail, palace temples, after Victor Place, *Ninive et l'Assyrie*, vol. 3, *Inscriptions*, pl. 72.

²⁸ Place, *Ninive et l'Assyrie*, vol. 3, *Inscriptions*, pl. 72.

There are additional images surviving from the door panels. A large corroded fragment from the Nabu Temple (room 13) has two figures, a bull-man or *kusarikku*, and a fish-man or *kulullû* (fig. 26).²⁹ A fragment from room 14 shows a *mušhuššu* with a stylus upright on its back (fig. 27). A third fragment also from room 14 has a small hillock with tall gracefully waving grasses, with surface-impressed emphasis. The textured hillock was created by surface tooling (fig. 28). An animal (now in the Louvre) has a head rather like that of a horse, but a tail that looks like that of a bull (fig. 29). Close examination reveals that there is a striated stripe along the spine connecting the upright mane to the tail. On the chest there is a pattern of vertical striations interrupted by horizontal areas free of detail. The lower belly is covered by two rows of concentric circles suggesting curls. These details suggest that the image could be another bull, but might be a wild horse (today known as a Przewalski's horse), or an onager or wild ass.³⁰ Loud reported that he found a poorly preserved horse in room 14, and two poorly preserved bulls among the Nabu Temple bronzes.³¹ This suggests that horses did figure among the bronzes. At the right edge is a goat head that may have joined with the strange animal body under an encircled star on the next fragment. A bronze from the palace temples now in the Louvre has a well-preserved animal now missing most of its head (fig. 30). In the space above the back of the animal is an encircled twelve-pointed star. This piece of relief may have been the right-hand part of the panel described next. The body may fit to the goat head at the right edge of the next figure, but the animal body does not seem particularly goat-like, although close examination reveals that the neck below the ears and the torso are covered with a pattern of striations that may be mimicking goat hair. A final strange depiction is the one to the left of a fringe-garmented man with spear (fig. 15). This most unusual and puzzling image may be a fence, or an unusually regular, broad-leafed and impenetrable plant. Its regularity seems suggestive of something man-made rather than something natural.

The variety of techniques and the quality of the craftsmanship and artistry exhibited by the bronzes from Khorsabad suggest that an outstanding group of metalworkers worked on these projects. The bronzes appear to be of the highest quality that the artistry and technological skill the palace workmen could achieve. The use of specialized tools to achieve particular details is apparent in the execution and decoration of the clothing of the elaborately dressed male figures. Their garments are decorated with several varieties and sizes of rosettes, concentric squares, circles, and concentric circles (figs. 10, 11, 15, and 16) and fringes. Equally focused attention is obvious for the rendering of the straight, wavy, and curly hair of the several animal figures, and for the leaves, flowers, fruit, and bark of the fig trees. Each of these decorations demanded a specially shaped tool. A grain seeder and the horns of the bull, both in Chicago, combine surface incision with repoussé. The sensitive artistry of the bronze workers is observed in



Figure 26. *Kusarikku* (bull-man) and *kulullû* (fish-man), Nabu Temple, room 13, with the permission of the Oriental Institute.



Figure 27. *Mušhuššu* with stylus on his back, Nabu Temple, room 14, with the permission of the Oriental Institute.

²⁹ These Nabu Temple fragments are in the Iraq Museum, Baghdad, and are not available for new photography at this time. Improved photographs were made from the original negatives to illustrate these.

³⁰ Pauline Albenda, "Horses of Different Breeds: Observations in Assyrian Art," *Amurru* 3 (2004): 321–34, figs. 5–8.

³¹ Oriental Institute Archives, Khorsabad Object Register, 1934, Nos. 707 (horse) and 705 (two bulls from room 13, Nabu Temple). These were never photographed or published. They are probably in the Iraq Museum, Baghdad.



Figure 28. Grasses or reeds on hillock, Nabu Temple, room 14, with the permission of the Oriental Institute.



Figure 29. Wild horse, with goat head at right, palace temples, with the permission of the Département des Antiquités Orientales, Musée du Louvre. Photo NIII 3099 by Pierre and Maurice Chuzeville.



Figure 30. Long-haired animal (a goat?) with circled star above its back, temple palaces, with the permission of the Département des Antiquités Orientales, Musée du Louvre. Photo NIII 3099 by Pierre and Maurice Chuzeville.

the powerful musculature of all the surviving bulls (figs. 11, 17, 18, and 19), and in the graceful depiction of grasses or reeds (fig. 28). These bronzes deserve renewed interest because of their outstanding qualities as examples of Late Assyrian art. In contrast, the earlier gates of Assurnasirpal II and Shalmaneser III³² emphasize complex compositions and seem to have somewhat less emphasis on subtle modeling and unique tooling detail.

The bronzes command interest for yet another reason. Surely the images have significance. Our understanding of the Assyrians suggests that purely decorative imagery would not be repeated at the entrances of temples. Our limited understanding of Assyrian conventions may prevent us from ever knowing with absolute certainty what this iconography was intended to signify. But that should not prevent us from thoughtful speculation. The cuneiform record asserts that some of these same images, the *mušhuššu*, the *kusarikku*, and the *kulullû*, were used to decorate the doors of the Marduk Temple in Babylon. Earlier temple door bands record history; these clearly do not. If we are ever to understand how this disparate group of images came to be used on temple doorways, it is reasonable to consider whether or not they should be understood as iconographic symbols, a way of representing the dedicatory inscription that is repeated at least five times on threshold slabs, steps, and platforms flanking steps in the Nabu Temple,³³ and on each of the five legible threshold slabs of the six palace temples.³⁴ All give the titles of Sargon as, "Sargon, King of the World, King of Assyria, Governor of Babylon, King of the Land of the Sumerian and the Land of the Akkadian, Builder of Your Throneroom." On the Sin Temple threshold and on a baked brick found in the throneroom there is the added request to make firm Sargon's "rule over the four quarters (of the world)."³⁵

This suggestion is proposed to initiate a discussion of a group of images that defy obvious explanation. The challenge is to discover whether there might be a way to persuasively relate the images of the bronzes to Sargon's inscribed titles. Such an interpretation is difficult because there are few, if any, simple correspondences between images and ideas. Place published eleven worked-bronze fragments found in association with doorways that we now know belong to the Sin, Adad, Ea, and Ningal Temples. Loud published eight bronze reliefs found in the Nabu Temple and found a set at the Shamash Temple. In all, seventeen motifs are depicted. Four of the motifs (the bull, fig tree, plow with grain seeder, and man in fringed garment holding a spear) are depicted three or more times and are found in relation to at least two, possibly three, temples. At least six of the seventeen motifs are on the tableaux framing entrances. The repeated use of the same images implies that there is significance to their use. There are an additional eleven motifs that may be understood as supplementing the set of tableaux images. These, the elaborately dressed man, the man with curled hair, *mušhuššu*, *kusarikku*, *kulullû*, encircled star, goat, wild horse (or onager or wild ass), hillock with grasses, palm tree, and the fence(?), may be understood as icons, possibly embodying reference to places other than Assyria. Many do indeed have a long history of representation in southern Mesopotamian art and some figure in early Mesopotamian literature. A few seem to have had a revival in representational art in Assyria, particularly at Khorsabad.³⁶ A written statement by Sargon's grandson, Esarhaddon, may offer a clue as to the interpretation of the beautifully executed images. He said, "I represented upon them *lamassu*-symbols, the equivalent of writing my name." A small two-register relief in the British Museum, known as the Black Stone, or Lord Aberdeen's Stone, and a prism each have an Esarhaddon inscription, and a set of images that may embody the principles expressed in that statement.³⁷ That set of symbolic images has not yielded a completely persuasive verbal interpretation. Those efforts did lead to a possible explanation for seven of the images on the Khorsabad glazed brick tableaux. Esarhaddon's statement suggests that we should try to interpret still more of the Khorsabad iconographic representations. The relief bronzes embody the largest set of symbolic images from Khorsabad, and from Assyria in general. It is possible that they may prove to be an iconographic expression of Sargon's titles.

³² Richard D. Barnett, *Assyrian Palace Reliefs and Their Influence on the Sculptures of Babylonia and Persia* (London: Batchworth Press, 1970), pls. 137–73; Richard D. Barnett, "More Balawat Gates: A Preliminary Report," in *Symbolae Biblicae et Mesopotamicae Francisco Mario Theodoro de Liagre Böhl Dedicatae*, edited by M. A. Beek (Leiden: Brill, 1973), pp. 19–22; John Curtis, "Balawat," in *Fifty Years of Mesopotamian Discovery: The Work of the British School of Archaeology in Iraq, 1932–1982*, edited by John Curtis (London: The British School of Archaeology in Iraq, 1982), pp. 113–19, fig. 86.

³³ Loud, *Khorsabad* 2, pp. 103–04.

³⁴ Loud, *Khorsabad* 1, pp. 129–33.

³⁵ Loud, *Khorsabad* 1, pp. 129–30.

³⁶ Botta, *Monument de Ninive*, vol. 2, pls. 152, 152 bis, and 153; Elisabeth Fontan, "Adrien de Longpérier et la création du musée assyrien du Louvre," in *De Khorsabad à Paris*, edited by Elisabeth Fontan with Nicole Chevalier (Paris: Réunion des Musées Nationaux, 1994), p. 235, fig. 7a and b; Jean-Claude Margueron, "Les Palais Assyriens"; Fontan, *De Khorsabad à Paris*, p. 150, fig. 4b.

³⁷ Irving L. Finkel and Julian Reade, "Assyrian Hieroglyphs," *Zeitschrift für Assyriologie* 86 (1996): 244–65, figs. 1–24; Michael Roaf and Annette Zgoll, "Assyrian Astroglyphs: Lord Aberdeen's Black Stone and the Prisms of Esarhaddon," *Zeitschrift für Assyriologie* 91 (2001): 264–95, figs. 1–11; JoAnn Scurlock "Assyrian Hieroglyphs Enhanced," *NABU* 1997/92.

“LAYER BY LAYER...” OF DIGGING AND DRAWING: THE GENEALOGY OF AN IDEA*

Maria Gabriella Micale and Davide Nadali, Università di Roma “La Sapienza”

1. INTRODUCTION

In the libraries in Berlin it is possible to come upon a surprising book dating to 1944 and entitled *Der Orient in deutscher Forschung*. This volume describes the proceedings of a conference organized by the *Berliner Orientalisten* in 1942. Among the lectures concerning the various fields of German *Orientalistik* research, the paper of Julius Jordan on the “Leistungen und Aufgaben der deutschen Ausgrabungen im vorderen Orient” is particularly interesting.¹ He asserts that German involvement in the scientific research on the ancient Near East strongly determined the development of European *Orientalistik*. In Jordan’s opinion, this occurred not only because of both the archaeological results and the high value of German publications, but also because of the highly sophisticated excavation techniques the German archaeologists developed.²

Jordan’s assumption does not reveal anything we do not know already about the qualitative effect (but let us say “quantitative” as well) of the German archaeology on the study of both the ancient Near East and Western Asia.³ Moreover, this effect was so strongly linked to the main fields of German research, philology and architecture, that Barthel Hrouda asserts that a great number of “archaeological” articles were in reality written by philologists or architects.⁴ However, it is peculiar that only a few decades after the termination of both the Assur and Babylon excavations, Jordan’s words express appreciation (and a minimum of national pride) for a profound innovation that was already legendary in the sphere of the techniques of research in the field of archaeology. Thus, a German archaeologist claims that the excavation techniques used in 1942 were already considered among the basic German contributions to archaeological research, that is, they were already part of the myth.

This is not the place to re-examine the development of stratigraphy, which at first was a technique of geological research and only later a standard practice in archaeological research.⁵ Instead, we want to pay attention to this specific circumstance: at a certain moment in the history of archaeological research in the Near East, the objects, materials, bricks, etc., that had carried meaning only in a “post-finding” perspective, started to gain significance in an *in fieri*-perspective, that is, a perspective taking shape during the course of the excavation itself.

* M. G. Micale wrote §§ 1–3; D. Nadali wrote §§ 4–5; both wrote § 6, *Conclusion*. We wish to express our gratitude to the Vorderasiatisches Museum, Berlin, in particular to Dr. Joachim Marzahn for the kind help and access to the archives of the museum and the Babylon expedition. The importance of Koldewey’s archaeological activities was highlighted in 2005 on the occasion of the 150th anniversary of the birth of the German archaeologist with a symposium held in Berlin on November 21, 2005.

¹ J. Jordan, “Leistungen und Aufgaben der deutschen Ausgrabungen im vorderen Orient,” in *Der Orient in deutscher Forschung: Vorträge der Berliner Orientalistentagung, Herbst 1942*, edited by H. H. Schaeder (Leipzig: Harrassowitz, 1944), pp. 228–38. In accordance with practices in Germany at that time, words such as “nichtjüdischen Völker,” “Indogermanistik,” or “arischen” occur in Jordan’s paper.

² Jordan, “Leistungen und Aufgaben,” p. 229. On Koldewey, see G. Wilhelm, “1898–1917: Babylon,” in *Zwischen Tigris und Nil: 100 Jahren Ausgrabungen der Deutschen Orient-Gesellschaft in Vorderasien und Ägypten*, edited by G. Wilhelm (Mainz am Rhein: Philipp von Zabern, 1998), p. 23; B. Hrouda, “Koldewey, R.,” *Neue deutsche Biographie* 12 (1980): 459f.; D. A. Warburton,

Archaeological Stratigraphy: A Near Eastern Approach (Neuchâtel: Recherches et Publications, 2003), p. 6. Recently, Beate Salje, the current director of the Vorderasiatisches Museum of Berlin, emphasizes that the finds kept in the Museum are documented stratigraphically; see B. Salje, “Vorderasiatisches Museum Staatliche Museen zu Berlin,” in *Vorderasiatische Museen: Gestern, heute, morgen: Berlin, Paris, London, New York. Kolloquium aus Anlaß des Einhundertjährigen Bestehens des Vorderasiatischen Museums Berlin am 7. Mai 1999*, edited by B. Salje (Mainz am Rhein: Philipp von Zabern, 2001), p. 7.

³ For the influence of the German excavations of W. Andrae and R. Koldewey on the image of the Near East in Europe in the eighteenth and nineteenth centuries, see M. G. Micale, “European Images of the Ancient Near East at the Beginnings of 20th Century,” in *Archives, Ancestors, Practices: Archaeology in the Light of its History*, edited by J. Nordbladh and N. Schlanger (in press, due 2008).

⁴ B. Hrouda, “Grundlagen und Methoden,” in *Methoden der Archäologie*, edited by B. Hrouda (Munich: C. H. Beck, 1978), p. 22.

⁵ Cf. Warburton, *Archaeological Stratigraphy*, p. 1.

In this new perspective, each find had significance only by remaining in place and occupying a unique point in space and time. It is possible to imagine that those scholars starting to think about archaeological research according to this new perspective mainly had a practical and intellectual need to organize the whole of the things, an approach that clashed with the work of the archaeologist—excavation and removal of artifacts.

Returning to Jordan's remarks, we have already pointed out that these words revealed a complete transformation of the historical reality of archaeological research into a mythical history of archaeological research. Nonetheless, the methodological revolution started by the German archaeologists became standard, even if it has all the features to be considered as history.

Introductory lectures in the university teach us that Robert Koldewey was the father of the historical archaeology: he is described as the first one who used stratigraphical methodology at a Near Eastern site, a method that became the basis of the so-called German School of Archaeology.

In this paper we explore what this stratigraphical method used at Babylon was in reality and why Koldewey used it. That is, we explore whether it is possible to give a narrative that is a little less mythical and a little more historical.

2. ROBERT KOLDEWEY ...

Before getting to the core of the question, it is necessary to trace part of Koldewey's professional life. After studies in architecture, archaeology, and history of art,⁶ Koldewey began a career as an architect in Hamburg. At the beginning of the 1880s, archaeology entered into Koldewey's life. All of his biographies fail to make the initial link between Koldewey and archaeology, probably because of a lack of data concerning what and/or who introduced this apparently ordinary German architect to the world of archaeological excavations.⁷ The first evidence we have about Koldewey's earliest archaeological activities concerns the architect F. H. Bacon, who appointed Koldewey as a member of the American archaeological expedition to ancient Assos, south of Troy. Koldewey's name appears in the correspondence and in the publications, where he was cited as architect of the Prussian government employed in the American expedition.⁸ However, there is no trace of any prior contact between the architect and the expedition.⁹

Bacon's statements concerning the excavation of the Säulenhalle especially interest us. In fact, Bacon asserted that it was Koldewey who established that the unearthed building seemed to have had two building phases. This was probably unusual and unexpected: Bacon admits that he received Koldewey's hypothesis as a challenge to his comprehension of the typological development of the architectural features of the building. Actually, even though Bacon was an architect, he speaks dismissively about Koldewey's detailed attention to architectural reconstruction.¹⁰ Thus, from the beginning, Koldewey considered architecture not as a static expression but as an active expression of a culture and its historical development.

Considering the final publication of these excavations, it does not seem possible that Koldewey elaborated the idea of stratigraphical excavation during this experience in Assos. However, it is clear that his deep knowledge of the processes of development of architecture led him to think "in phases" and to process archaeological data in accordance with a system of "consecutive actions."

⁶ For the relationship between the German educational system of that period and the archaeological culture, see S. Marchand, *Down from Olympus: Archaeology and Philhellenism in Germany, 1750–1970* (Princeton: Princeton University Press, 1996), pp. 24–35, 142–51; S. R. Hauser, "Not Out of Babylon? The Development of Ancient Near Eastern Studies in Germany and Its Current Significance," *Historiography in the Cuneiform World*, Proceedings of the 45^e Rencontre Assyriologique Internationale, Harvard University, Part 1, edited by T. Abusch et al. (Bethesda: CDL Press, 2001), pp. 215–16.

⁷ For biographical details on Koldewey, see W. Andrae, *Babylon: Die versunkene Weltstadt und ihr Ausgräber Robert Koldewey* (Berlin: Walter de Gruyter, 1952); Hrouda, "Koldewey."

⁸ In particular, Koldewey is mentioned in the correspondence between Edward C. Cabot, the president of the Boston Society of Architects, and Charles E. Norton, the president of the Archaeological Institute of America; see J. T. Clarke, *Report on the Investigations at Assos,*

1882, 1883, Part 1, Papers of the Archaeological Institute of America, Classical Series 2 (New York: MacMillan, 1898), pp. vii–ix, 3.

⁹ Since J. T. Clarke had studied in Germany, it is possible that he had met Koldewey or someone who knew him during that period (S. H. Allen, "'Americans in the East': Francis Henry Bacon, Joseph Thatcher Clarke, and the AIA at Assos," in *Excavating Our Past: Perspectives on the History of the Archaeological Institute of America*, edited by S. H. Allen [Boston: Archaeological Institute of America, 2002], p. 63).

¹⁰ "Eben hat er [K.] festgestellt, dass die Säulenhalle zwei Perioden hatte; damit erklären sich die beunruhigenden zwei Säulenarten. Ich necke ihn damit, dass er nächstens noch ein Mansardendach und luftig gefägte Laufbretter [jig-sawed eaves] herausbringen wird," R. Koldewey, *Ernst und heitere Briefe aus einem Archäologenleben*, edited by C. Schuchhardt (Berlin: Grote, 1925), p. 5.

In 1887, Koldewey left for Mesopotamia for the first time and led excavations at Surghul and al-Hiba on behalf of the Königlich Preussischen Museen.¹¹ Roger Matthews has recently asserted that it was at these sites that Koldewey first started to develop the technique of tracing and excavating mudbrick.¹² Is it possible to identify the scientific and methodological assumptions of the later excavations of Babylon in these early archaeological excavations?

The issue of mudbrick identification is with no doubt crucial. Actually, Matthews asserts that the identification of mudbrick itself represented a real revolution in archaeological methodology. However, of what did this revolution consist? As a matter of fact, considering the excavations conducted in the Near East at that time, the detection of a mudbrick wall that did not require its demolition was a great revolution.¹³ In our opinion, it is most interesting that this seems to be an almost accidental change, since it was neither requested nor the result of any deep methodological and scientific considerations. Actually, Koldewey seems to have continued doing what he had already been doing during previous excavations, that is, recognizing the architectural remains and analyzing the possible continuous changes that occurred over the course of time.¹⁴

In the publications of this Mesopotamian archaeological campaign, Koldewey discussed the technical approaches he used for excavation in the field. He wrote that he cut into the mound by means of a Suchgraben 1 m wide × 75 m long. Was this an innovation? It clearly was not, except perhaps for the use of trenches instead of tunnels. But this choice was surely due to circumstances at the site, since during Koldewey's later career as a Near Eastern archaeologist he repeatedly excavated by tunnel. Nonetheless, we consider his observation that the excavation of the trench had allowed the exposure of a section (Querschnitt) in which strata (Schichten) could be recognized to be a real revolution in the description of excavations at Surghul.¹⁵

Unfortunately, the publication of these excavations does not include illustrations. Thus, we do not know whether the sections exposed by the excavation were rendered into a graphic representation of the stratigraphical sequence Koldewey had observed.

After this first "oriental" period, Koldewey's archaeological experience resumed in Syria at an excavation by the Berlin Museum in ancient Sam'al, modern Zinjirli. Koldewey did not take part in the first campaign at Zinjirli in 1888 directed by C. Humann,¹⁶ the excavator of Pergamon.¹⁷ Humann himself drew some plans that were published in the first part of the final report of the excavations at Zinjirli. However, in the second part of the same volume, reporting on the campaigns in which Koldewey took part,¹⁸ Koldewey published the large section devoted to the architecture of Zinjirli and a great number of plans and drawings, quite unlike any from the periods before or after Koldewey's involvement in the excavation.¹⁹

These, then, are the experiences of Koldewey before 1899, when, after two years of travel and the founding of the Deutsche Orient-Gesellschaft (DOG),²⁰ he officially started the excavation campaign in the ancient city of Babylon, of which Koldewey himself was the director on behalf of the Berlin Museum.

¹¹ R. Koldewey, "Die altbabylonischen Gräber in Surghul und El Hibba," *Zeitschrift für Assyriologie* 2 (1887): 403–30; N. Crüsemann, *Vom Zweistromland zum Kupfergraben: Vorgeschichte und Entstehungsjahre (1899–1918) der Vorderasiatischen Abteilung der Berliner Museen vor fach- und kulturpolitischen Hintergründen*, Jahrbuch der Berliner Museen 42 (Berlin: Gebrüder Mann, 2000), pp. 81–87.

¹² R. Matthews, *The Archaeology of Mesopotamia: Theories and Approaches* (London: Routledge, 2003), p. 12.

¹³ M. Liverani, "La scoperta del mattone: Muri e archivi nell'archeologia mesopotamica," *Vicino Oriente* 12 (2000): 1–17, speaks of the "discovery of the brick."

¹⁴ For Koldewey's deliberate conscientiousness, see also Liverani, "La scoperta del mattone," p. 13.

¹⁵ Koldewey, "Die altbabylonischen Gräber," p. 428.

¹⁶ Crüsemann, *Vom Zweistromland*, p. 90.

¹⁷ C. Schuchhardt and T. Wiegand, *Der Entdecker von Pergamon Carl Humann* (Berlin: Grote, 1931), pp. 1–2. For Germany in the territories of the Ottoman Empire and the relationships between archaeological research and "other" interests, see H. Härke, "All Quiet on the Western Front? Paradigms, Methods and Approaches in West German Archaeology," in *Archaeological Theory in Europe*, edited by I. Hodder (London and New York: Routledge, 1991), pp. 187–222; M. Liverani, "'Voyage en Orient': The Origins of Archaeological Surveying in the Near East," in *The Near East and the Meaning of*

History: International Conference (23–27 November 1992), *Studi Orientali* 13 (Rome: Università di Roma "La Sapienza," 1994), pp. 6–12; Marchand, *Down from Olympus*; H. Hassmann, "Archaeology in the Third Reich," in *Archaeology, Ideology and Society: The German Experience*, edited by H. Härke (Frankfurt am Main: Peter Lang, 2000), pp. 65–139; Hauser, "Not out of Babylon"; Crüsemann, *Vom Zweistromland*; Crüsemann, "'Ja! Wir werden das Licht des Deutschen Genius auch dorthin tragen': Der Beginn der Ausgrabungen in Assur im Spiegel Preussisch-Deutscher Orientpolitik unter Wilhelm II.," in *Wiedererstehendes Assur: 100 Jahre deutsche Ausgrabungen in Assyrien*, edited by J. Marzahn and B. Salje (Mainz am Rhein: Philipp von Zabern, 2003), pp. 35–44; Micale, "European Images."

¹⁸ Crüsemann, *Vom Zweistromland*, p. 92.

¹⁹ C. Humann, *Bericht über die erste Ausgrabung von Sendschirli*, *Ausgrabungen Sendschirli* 2 (Berlin: W. Spemann, 1898), pp. 103–300.

²⁰ For the DOG and its founding, see O. Matthes, "Der Aufruf zur Gründung der Deutschen Orient-Gesellschaft vom November 1897," *Mitteilungen der Deutschen Orient-Gesellschaft* 130 (1998): 9–16; O. Matthes, "Zur Vorgeschichte der Deutschen Ausgrabungen in Babylon," in *Babylon: Focus mesopotamischer Geschichte, Wiege früher Gelehrsamkeit, Mythos in der Moderne*, 2. *Internationales Colloquium der Deutschen Orient-Gesellschaft* 24.–26. März 1998 in Berlin, edited by J. Renger (Saarbrücken: Saarbrücker Druckerei und Verlag, 1999), pp. 33–45; Crüsemann, "'Ja! Wir werden das Licht,'" pp. 38–39.

3. ...BABYLON

Is it possible to outline the genealogy of Koldewey's concept of stratigraphy? Analysis of his archaeological experiences before the excavation of Babylon demonstrates that any of them could have substantially affected Koldewey's ideas about chronological and stratigraphical sequences. Koldewey's involvement both in excavations and publications, however, changed their meaning and value. Actually, as noted concerning the excavations at Surghul and al-Hiba, Koldewey transformed an ordinary trench into an extraordinary opportunity to observe the development of the site layer by layer.

Considering the then-current excavation techniques, he did not completely disregard the traditions already established by his colleagues. Although he seldom described the excavation's progress, an analysis of the documents²¹ clearly shows the employment of wells, tunnels, and more or less wide trenches frequently provided with step-cuttings (figs. 1 and 2).²² On the other hand, it has to be acknowledged that the establishment of the Babylonian expedition was motivated by the traditional European desire to collect materials for display in European museums.²³

There is disagreement between the hypothesis that the use of tunnels was restricted to the occasional need for investigating the early levels of a structure on the one hand, and the evidence provided by the photographic records that show an extensive use of tunnels on the other.²⁴ However, the illustrations and photographic documentation clearly emphasize that Koldewey transformed an ordinary circumstance into an opportunity for innovative scientific research in this case as well. Actually, the excavation of a well or a trench represented in any case the chance to expose a section, to observe the stratigraphical sequence thus exposed, to draw it, and to process the data.

The contribution of Koldewey's educational background to both the quality of the graphic documentation²⁵ and the approach to the excavation itself was most impressive.²⁶ Actually, whereas Koldewey the archaeologist exca-

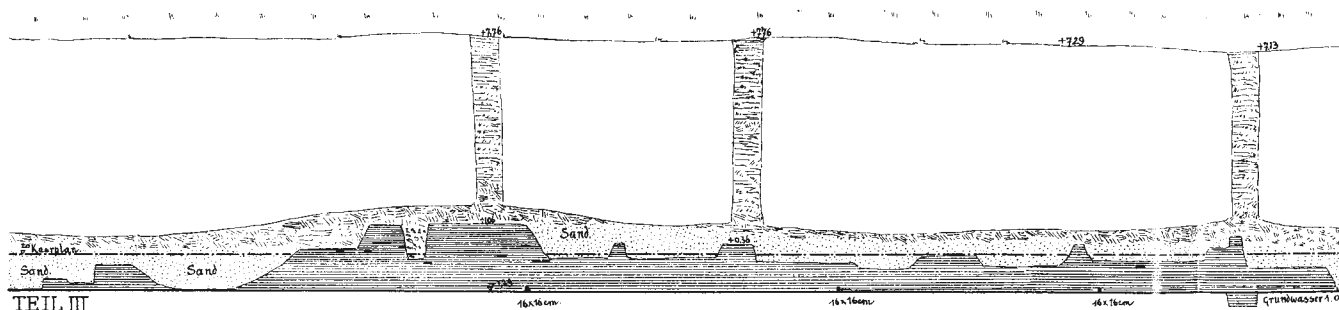

Figure 1. A section illustrating the use of wells (from Wetzel, *Die Stadtmauern von Babylon*, pl. 43).

²¹ See also R. Koldewey, *Die Königsburgen von Babylon*, Part 2, Wissenschaftliche Veröffentlichung der Deutschen Orient-Gesellschaft 55 (Osnabrück: O. Zeller, 1969), pl. 29; O. Reuther, *Die Innenstadt von Babylon (Merkes)*, Wissenschaftliche Veröffentlichung der Deutschen Orient-Gesellschaft 47 (Osnabrück: O. Zeller, 1968), pl. 9; F. Wetzel, *Die Stadtmauern von Babylon*, Wissenschaftliche Veröffentlichung der Deutschen Orient-Gesellschaft 48 (Leipzig: J. C. Hinrichs, 1930), pl. 30.

²² Concerning what Liverani defines as the "industrial exploitation" of the ancient site of Susa, he assumes that the French archaeologists had conceived this excavation technique as an innovation against the local excavation by tunnel. Moreover, he says: "Si tratta evidentemente della risposta mineraria francese alla sfida architettonica lanciata pochi anni prima dai tedeschi" (Liverani, "La scoperta del mattone," p. 10). As Liverani asserts, there is no doubt that a trench provided with step-cuttings was the typical western "industrial" way of excavation. Nevertheless, there is no doubt that European engineers and architects, such as Koldewey himself, organized the workplace as they usually had done before, that is, as a construction or industrial site, as several pictures of the Babylonian excavation and some archive documents confirm.

²³ Instruktion der Babylon-Expedition, in *Archiv der Deutschen Orient-Gesellschaft*, II.1.1.2.1.

²⁴ For a description of the excavation techniques used by Andrae and partially already used in Babylon, see J. Bär, "Walter Andrae – Ein Wegbereiter der modernen Archäologie," in *Wiedererstehendes Assur: 100 Jahre deutsche Ausgrabungen in Assyrien*, edited by J. Marzahn and B. Salje (Mainz am Rhein: Philipp von Zabern, 2003), pp. 45–47.

²⁵ "In those early days, styles of drawing and techniques of reproduction were naturally of a sort which today would be regarded as unsuitable or even primitive," [sic!] S. Lloyd, "Illustrating Monuments: Drawn Reconstructions of Architecture," in *To Illustrate the Monument: Essays on Archaeology Presented to Stuart Piggott*, edited by J. V. S. Megaw (London: Thames and Hudson, 1976), p. 28.

²⁶ For the influence of the personal education of Andrae and Koldewey on the architectural reconstruction of Assur and Babylon, see M. G. Micale, "Immagini d'architettura: Struttura e forma dell'architettura mesopotamica attraverso le ricostruzioni moderne," in *Studi in onore di Paolo Matthiae presentati in occasione del suo sessantacinquesimo compleanno*, edited by A. Di Ludovico and D. Nadali, *Contributi e Materiali di Archeologia Orientale* 10 (Rome: Università di Roma "La Sapienza," 2005), pp. 121–66; and Micale, "European Images."

vated to comprehend, Koldewey the architect drew all that his mind conceived. Thanks to the drawing and its strongly informative power, the architect can translate an idea into a visible form.²⁷ Thus, the drawings of what Koldewey unearthed became a fundamental instrument of knowledge as well. "To be able to measure things means to be able to understand them" is the opinion of Henrich Wölflin,²⁸ and it seems to have been Koldewey's opinion as well.

It is possible to hypothesize that the revolution conducted by Koldewey through the Babylon excavations was in reality an unconscious revolution that began before Babylon. Actually, Koldewey did in Babylon what usually was done in each excavation of that period, that is, cutting trenches and excavating tunnels. However, the practice of preserving the mudbricks and unearthing the buildings as widely as possible was surely perceived as a real revolution in the field of Near Eastern archaeological research.

Concerning the stratigraphical approach, there is no doubt that the attention Koldewey paid to the sequence of the strata and to the superimposed phases of a building was aimed more at the definition of the chronological phases than at the definition of stratigraphical units in a strict modern sense. However, Koldewey's approach had neither precedents nor contemporary similarities. This is clear from the documentation of the Babylonian expedition itself. The sectional drawings and the catalogues of the objects are clear: each object unearthed is unique in its place and time. This was a lesson which Near Eastern archaeology, mainly German archaeology, could not ignore. Actually, although classes in the history of archaeology teach us to look at Kathleen Kenyon's archaeological sections at Jericho as the expression of a renewed idea of the excavation of a Near Eastern site, it is because, analyzing two "anonymous" sections of Jericho, one did not ask which was drawn by German archaeologists at the beginning of the twentieth century and which by the British archaeologists in the 1960s.



Figure 2. Tunnels by the inner Stadtmauer of Babylon (from Wetzell, *Die Stadtmauern von Babylon*, pl. 70).

4. THE METHOD OF EXCAVATION I: EVIDENCE FROM THE FIELD

Although the method of excavation used by German archaeologists was the same as that previously used by the early explorers in Mesopotamia (Layard and Rassam at Nineveh and Nimrud, Botta and Place at Khorsabad),²⁹ Robert Koldewey and his team added careful analysis of the process of excavation from the top of the tell down to the lowest layers of a building. The German school of archaeology carefully observed the building techniques, distinguishing each phase of construction and the different parts that form the structures. Thus archaeologists distinguished in the first stage—the excavation itself—the different layers corresponding to the construction phase or building part; then they reported in the sectional drawings all details of the façades of the building and the fills of the rooms, registering their positions in space in the stratigraphical sequence of deposits.³⁰

²⁷ R. Recht, *Il disegno d'architettura* (Milan: Jaka Book, 2001), pp. 52–54 (Italian translation of *Le dessin d'architecture*, Paris: 1995).

²⁸ Recht, *Disegno*, p. 125.

²⁹ R. Koldewey, *Das wiedererstehende Babylon: Die bisherigen Ergebnisse der deutschen Ausgrabungen* (Leipzig: J. C. Hinrichs, 1913), p. 200, "durch tiefe Schächte und Stollen."

³⁰ R. Koldewey, *Die Königsburgen von Babylon: Erster Teil: Die Südburg*, Wissenschaftliche Veröffentlichung der Deutschen Orient-Gesellschaft 54 (Leipzig and Berlin: J. C. Hinrichs, 1931), pl. 29.

It is, however, impossible to speak of proper stratigraphy that considered the relations among the different layers during the excavation: in the first uses of stratigraphical technique in both Mesopotamia and Palestine, stratigraphy was often confused with chronology; the artifacts in those deposits depend upon the physical placement of the deposits.³¹ However, German excavations in Babylon focused attention on the architectural aspects of the excavated buildings; for that reason, the stratigraphy of the German excavations at Babylon can be considered more architectural than chronological.³²

The precise architectural location in plan and section drawings of both the different superimposed layers (Schichten) and the numerous finds is particularly useful to understand the method adopted by Koldewey. The materials are no longer important as objects per se, but they acquire their own exact meaning when they are located in situ, that is, in a precise space that can define a restricted time period.³³ The registration of all data in plans and section drawings depicts the formation of the archaeological deposits, establishing first a relative chronology—layer by layer—and then an absolute chronology by means of the study of the finds in each layer. The distinguishing of the layers in an archaeological investigation is the sole way to determine the exact chronology of a building, as strictly intended in the “architectural excavation” (Bauforschung, Baugeschichte, and Bauwerke) of Koldewey,³⁴ or more generally of the whole site. Considering the formation of the different layers as actions in succession is essential in determining the history of the building and site: the distinguishing of several layers can help in defining the exact chronology, the use of a building, and its development over time.³⁵

Although Koldewey’s method includes the use of shafts and galleries (Schachte, Stollen, and Tunnel)³⁶ along the walls to provide plans of the buildings, his innovation was the analysis of the excavation process itself.³⁷

It is important to point out that the absence of reliefs on the walls of the buildings excavated by Koldewey probably contributed to Koldewey’s different archaeological approach to the ancient ruins: if Koldewey had found reliefs such as those found by the English and French explorers in Assyria, what methodology would he have adopted? Koldewey, however, did not even search for such material, focusing his attention on the analysis of the architectural phases. This kind of attention was seen, as noted above in Koldewey’s previous archaeological experience in Assos with the American expedition. Comparing the German excavations to the contemporary American excavations at Nippur,³⁸ we see that Koldewey did not excavate by means of pits and shafts with the goal of discovering great numbers of cuneiform tablets; tablets, like all material found by the German expedition were not important as a discovery per se, but they acquired importance as a datum inserted in the stratigraphical sequence of the archaeological deposits.³⁹

³¹ D. Warburton, “Stratigraphy: Methodology and Terminology,” in *Proceedings of the International Congress on the Archaeology of the Ancient Near East, Rome, May 18th–23rd 1998*, vol. 2, edited by P. Matthiae et al. (Rome: Università di Roma “La Sapienza,” 2000), p. 1746.

³² D. Warburton, *Archaeological Stratigraphy*, p. 20.

³³ R. Koldewey, *Die Tempel von Babylon und Borsippa*, Wissenschaftliche Veröffentlichung der Deutschen Orient-Gesellschaft 15 (Leipzig: J. C. Hinrichs, 1911), fig. 18.

³⁴ W. Nagel, “Die Deutsche Orient-Gesellschaft: Rückblick 1976,” *Mitteilungen der Deutschen Orient-Gesellschaft* 108 (1976): 55.

³⁵ Matthews, *The Archaeology of Mesopotamia*, pp. 64–66; Warburton, *Archaeological Stratigraphy*, pp. 113–19.

³⁶ F. Wetzel and F. H. Weissbach, *Das Hauptheiligtum des Marduk in Babylon, Esagila und Etemenanki I, Nach dem Ausgrabungsbefund II, Nach den keilinschriftlichen Quellen*, Wissenschaftliche Veröffentlichung der Deutschen Orient-Gesellschaft 59 (Leipzig and Berlin: J. C. Hinrichs, 1938), pl. 24a.

³⁷ Liverani, “La scoperta del mattone,” p. 4; W. Andrae, *Lebenserinnerungen eines Ausgräbers* (Berlin: Walter de Gruyter, 1961), p. 78; A. Moortgat, *Einführung in die Vorderasiatische Archäologie* (Darmstadt: Wissenschaftliche Buchgesellschaft, 1971), pp. 42–44.

³⁸ J. P. Peters, *Nippur or Explorations and Adventures on the Euphrates: The Narrative of the University of Pennsylvania Expedition to Babylonia in the Years 1888–1890* (New York and London: G. P. Putnam’s Sons, 1897); H. V. Hilprecht, *Explorations*

in Bible Lands During the 19th Century (Edinburgh: T & T Clark, 1903), pp. 289–425; B. Kuklick, *Puritans in Babylon: The Ancient Near East and American Intellectual Life, 1880–1930* (Princeton: Princeton University Press, 1996), p. 145. H. V. Hilprecht, in fact, complains about and criticizes the excavation method adopted in the first three excavation campaigns (1888–1896) when John P. Peters, professor of Hebrew in the Episcopal Divinity School of Philadelphia, was the scientific director of the expedition and even when direction of the work was assumed by John H. Haynes again (Hilprecht, *Explorations in Bible Lands*, pp. 289–96, 321, 328–29, 339, 344). The lack of an architect was, in Hilprecht’s opinion, a tremendous mistake, and when Hilprecht himself became scientific director of the fourth expedition (1898–1900), Clarence S. Fisher was immediately appointed as architect to the expedition (p. 427). See C. S. Fisher, *Excavations at Nippur: Part I and II, Babylonian Expedition of the University of Pennsylvania* (Berlin: Curtius, 1907), pls. 4, 11, 17, 25, where the drawings seem to reflect the German experience that was going on in Babylon (Hilprecht, *Explorations in Bible Lands*, figure at p. 394; Kuklick, *Puritans in Babylon*, pp. 145–46).

³⁹ M. Liverani, “History and Archaeology in the Ancient Near East: 150 Years of a Difficult Relationship,” in *Fluchtpunkt Uruk: Archäologische Einheit aus methodischer Vielfalt: Schriften für Hans Jörg Nissen*, edited by H. Kühne, R. Bernbeck, and K. Bartl (Rahden: M. Leidorf, 1999), p. 2; K. Kohlmeyer and E. Strommenger, *Wiedererstehendes Babylon: Eine antike Weltstadt im Blickpunkt der Forschung: Ausstellung des Museums für Vor- und Frühgeschichte der Staatlichen Museen Preussischer Kulturbesitz* (Berlin: Enka Druck, 1991), p. 43.

The archaeological method employed by Koldewey at Babylon seems to respond to the statement of Petrie who wrote in 1904 that "archaeology is the latest born of sciences. ... It is still attracted by pretty things, rather than by real knowledge."⁴⁰ Koldewey in fact seems to have been more attracted by the real knowledge of the excavation through the study of the architecture than by the pretty things that were usually sought in the ancient tells of the Near East.

As previously noted, Koldewey's education as architect,⁴¹ as well as the presence on the site of other well-trained architects,⁴² surely influenced his approach to archaeology. The drawing of the elevations of the architectural structures is not only specific to his architectural education: although elevation views of façades are a part of a typical architect education, it is also true that in an archaeological context such elevation views of structures and related archaeological layers yield a section drawing of archaeological deposits one above the other, in a stratigraphical way.⁴³ These section drawings are, however, architectural sections aiming more at the identification of the architectural elements and phases of a building than at a sequence of archaeological deposits. Although architectural in nature, Koldewey's section drawings are surely more accurate and precise than are the drawings of the sections through the mound made by Petrie at Ajjul that Wheeler defines as belonging "technically to the infancy of archaeology" and that "were, in fact, obsolete more than a century ago."⁴⁴

Koldewey's excavations consider space as the most important instrument to decode archaeological data, both of the architecture of the buildings and the materials found in them: it is volumetric space represented horizontally (plans) and vertically (section drawings).⁴⁵ On the other hand, the system used by Petrie in his excavations at Tell el-Hesi in Palestine developed the typological, chronological analysis of the artifacts contained in the deposits.⁴⁶ Pottery was the key in Petrie's research, and he came to state that "with the brief view of Palestinian pottery gained in a few weeks, on one site at Tell el-Hesi (Lachish), I found it possible to ride over mounds of ruins and see the age of them without even dismounting."⁴⁷ The analysis of materials from surface survey has nothing to do with stratigraphy: the relation of finds-to-layer, and then layer-to-architecture is irremediably broken, and the periods of a site based on the sequence of finds can correspond to no real layer and architectural phase.

Petrie, however, also developed a stratigraphical investigation of Tell el-Hesi that included the analysis of the sections, as already experienced in his excavations in Egypt: his section drawings, like those of his excavations at Tell el-Ajjul, are, however, very simple and too schematic and do not reproduce the accurate superimposition of the deposits.⁴⁸ In Palestine, it is always interesting to take into consideration the German excavations at Jericho at the beginning of the twentieth century (1907, 1909, and 1911), conducted by the Austrian Ernst Sellin.⁴⁹ Numerous section drawings were made, some very detailed, others in a more schematic way, representing the layers in relation to the preserved architectural structures.⁵⁰

⁴⁰ W. M. F. Petrie, *Methods and Aims in Archaeology* (Oxford: Macmillan, 1904), p. vii.

⁴¹ S. A. Pallis, *The Antiquity of Iraq* (Copenhagen: E. Munksgaard, 1956), p. 307.

⁴² The practical importance of architects in the archaeological field can be seen in the American expedition at Nippur, with the above cited case of Fisher during the fourth campaign, and also with Joseph Meyer who briefly worked at Nippur as architect during the third campaign alongside the archaeologist Haynes (Hilprecht, *Explorations in Bible Lands*, pp. 364–66, 370).

⁴³ Koldewey, *Die Königsburgen von Babylon*, pl. 29.

⁴⁴ M. Wheeler, *Archaeology from the Earth* (Oxford: Penguin, 1954), p. 16; P. R. S. Moorey, *A Century of Biblical Archaeology* (Cambridge: Lutterworth, 1991), pp. 60–61; Liverani, "La scoperta del mattone," p. 15; T. W. Davis, *Shifting Sands: The Rise and Fall of Biblical Archaeology* (Oxford: Oxford University Press, 2004), p. 31. On the contrary, Petrie reports: "at the base of the plate is the detailed plan and section of the large sunken way, on the north-east of the cemetery in li, liii" [emphasis added] (W. M. F. Petrie, *Ancient Gaza II* [London: British School of Archaeology in Egypt, 1932], p. 13, pl. 45).

⁴⁵ Moortgat, *Einführung*, pp. 42–44.

⁴⁶ W. M. F. Petrie, *Tell el Hesi (Lachish)* (London: Palestine Exploration Fund, 1891); M. S. Drower, "W. M. Flinders Petrie, the Palestine Exploration Fund and Tell el-Hesi," *Palestine Exploration Quarterly* 122 (1990): 87–95; S. Gibson and T. Rajak, "Tell el-Hesi

and the Camera: The Photographers of Petrie and Bliss," *Palestine Exploration Quarterly* 122 (1990): 114–32. See also D. Oates and J. Oates, *The Rise of Civilization* (London: Elsevier-Phaidon, 1976), pp. 35–36; and Davis, *Shifting Sands*, pp. 29–30.

⁴⁷ Petrie, *Methods and Aims*, p. 17; M. Liverani, "'Voyage en Orient,'" p. 12; Liverani, "History and Archaeology," p. 4.

⁴⁸ Petrie, *Tell el-Hesi*, pp. 15–17, pl. 3; Kuklick, *Puritans in Babylon*, pp. 142, 146–49.

⁴⁹ E. Sellin and C. Watzinger, *Jericho: Die Ergebnisse der Ausgrabungen* (Berlin: J. C. Hinrichs, 1913). For an analysis of the German exploration of Palestine by the Deutschen Palästina Verein at the end of nineteenth and beginning of the twentieth century, see L. Nigro, "In the Shadow of the Bible: Archaeological Investigations by the Deutsche Palästina Verein before the First World War: Taanek, Megiddo, Jericho, Shechem," in *Archéologie dans l'Empire Ottoman autour de 1900: Entre politique, économie et science*, edited by V. Krings and I. Tassignon, Institut Historique Belge de Rome (Brussels: Institut Historique Belge de Rome, 2004), pp. 215–29; and Davis, *Shifting Sands*, pp. 36–40. All archaeological expeditions led by Sellin included a trained architect, and even G. Schumacher, who worked at Tell el-Mutesellim/Megiddo (1903–1906), was an engineer working on the construction of the railway connecting Arabia to Anatolia (Nigro, "In the Shadow of the Bible," p. 216).

⁵⁰ Sellin and Watzinger, *Jericho*, figs. 34, 53; Moorey, *A Century of Biblical Archaeology*, pp. 34–35; Nigro, "In the Shadow of the Bible," p. 225.

Babylon with Koldewey and Jericho with Sellin are a few examples (together with Troy, Zinjirli, Taannek, Megiddo, Schechem, Assur, and Uruk) of a method of excavation that distinguishes the German school of archaeology at the beginning of the last century in the region of Mesopotamia (Deutsche Orient-Gesellschaft) and Palestine (Deutsche Palästina Verein).⁵¹

5. THE METHOD OF EXCAVATION II: EVIDENCE FROM THE PUBLICATIONS

Reflections on “stratigraphy” can be seen in the publications (MDOG and WVDOG series): the excavations are carefully and meticulously recorded using photos, several plans associated with detailed section drawings, and more generally by organizing all the materials and data to reconstruct the life of the buildings and site, following a chronological sequence and order. For that reason, stratigraphy in Koldewey’s view can be defined as “architectural”; it differs from the current significance of stratigraphy, or better of “unit of stratification,” that implies the physical position of each layer in the sequence of the superimposition of different recognized layers.⁵²

The cross-use of plans (*Grundriss*) and section drawings (*Schnitt/Querschnitt*) documents the innovative method of excavation and study by the German school of archaeology (fig. 3). The distinguishing and identification of the layers yield the different architectural phases of a building (*Bauphase*).

Next to the drawings, the use of proper terms helps in understanding the process of the excavation and in organizing the analysis of the achieved data: “Schicht” is the most frequent term used in the stratigraphical description of the excavation.⁵³ It corresponds to the English “layer” or “stratum” and the French “couche.” In the accounts it is, however, employed in a more architectural way: *Schichten* are in fact the different architectural features recognized

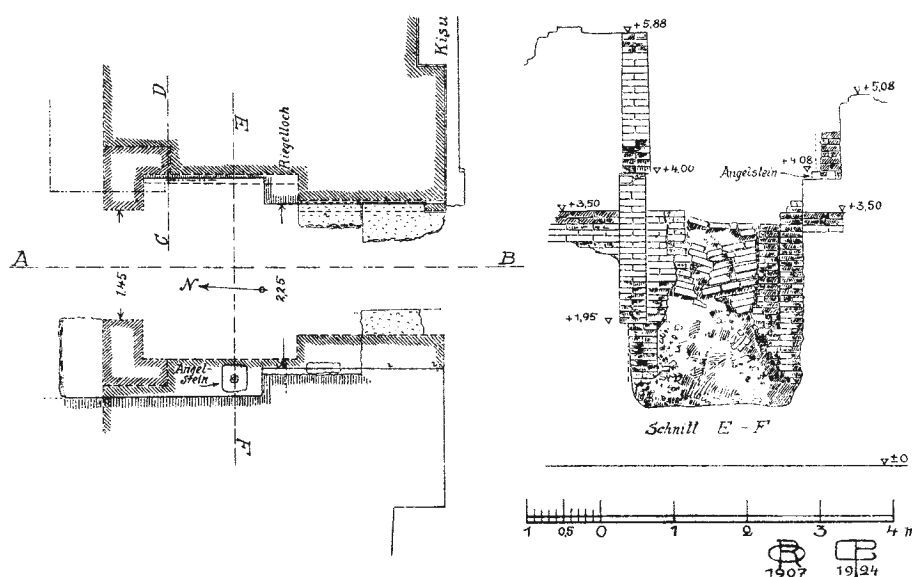

Figure 3. Example of the associated use of plan and section drawing (from Koldewey, *Die Königsburgen von Babylon*, pl. 33).

⁵¹ V. Fritz, “1903–1909: Die Arbeit des Deutschen Orient-Gesellschaft in Palästina,” in *Zwischen Tigris und Nil: 100 Jahren Ausgrabungen der Deutschen Orient-Gesellschaft in Vorderasien und Ägypten*, edited by G. Wilhelm (Mainz am Rhein: Philipp von Zabern, 1998), pp. 101–04.

⁵² Warburton, *Archaeological Stratigraphy*, p. 7; Moorey, *A Century of Biblical Archaeology*, p. 180; E. Harris, *Principles of Archaeological Stratigraphy* (London: Academic Press, 1997), pp. 12–13.

⁵³ R. Echt, *Kāmid el-Lōz 5: Die Stratigraphie*, Saarbrücker Beiträge zur Altertumskunde 34 (Bonn: Dr. Rudolf Habelt, 1984), pp. 19–

22; R. Eichmann, *Uruk: Die Stratigraphie: Grabungen 1912–1977 in den Bereichen ‘Eanna’ und ‘Anu-Ziqqurat,’* Ausgrabungen in Uruk-Warka Endberichte 3 (Mainz am Rhein: Philipp von Zabern, 1989), pp. 3–4; V. Fritz, *Einführung in die biblische Archäologie* (Darmstadt: Wissenschaftliche Buchgesellschaft, 1985), p. 49. See also D. Warburton, review of R. Echt, *Kāmid el-Lōz 5: Die Stratigraphie* (= Saarbrücker Beiträge zur Altertumskunde 34), Bonn, 1984, in *Zeitschrift für Assyriologie* 82 (1992): 292–95; D. Warburton, “Tellstratigraphie oder Archäologie?,” *Baghdader Mitteilungen* 27 (1997): 395–411.

6. CONCLUSION

In conclusion, our analysis shows that stratigraphical excavation is not optional. Actually, stratigraphy represents the basis of all archaeological knowledge of context and its historical and human development. Moreover, it gives archaeology scientific value. It is often asserted that archaeology is not properly a science, since the excavation process can be performed only once and cannot be repeated and verified. Thus, stratigraphy is the only device we have to verify after the excavation what has been excavated, that is, the sequence of actions and chronological phases.⁵⁹ Since Koldewey was trained as an architect, he was aware of the importance of distinguishing changes in the superimposition of different architectural features. Thanks to his education, it is possible to observe the marked difference between German excavations and the previous and contemporary excavations, although Koldewey often used the same methods as Layard and Rassam, defined by Hilprecht as “injurious and antiquated.”⁶⁰ This is even more striking considering both the assumptions and aims of the European and American institutions that sponsored the archaeological investigations in those areas.

From the first, Koldewey’s archaeological approach has been considered the most scientific system at that time. Two- and three-dimensional records of the data allowed one to recognize the historical development of a site as never before and even today allows us to retrace that development.

At the beginning of the twentieth century, Koldewey was a well-trained architect and used his eyes to see and recognize things. At the beginning of the twenty-first century, however, archaeologists seem to perceive things not through their eyes but by means of computers and modern techniques. We presume to gain the truth through our sophisticated technologies, but we forget that a human being, an eye, and a mind are behind each instrument. The excavations at Babylon marked the beginning of the history of Near Eastern archaeology since behind them there were the mind and eye of a human.

⁵⁹ See in general J. Oates, “Writing Archaeology,” in *Historiography in the Cuneiform World*, Proceedings of the 45^e Rencontre Assyriologique Internationale, Harvard University, Part 1, edited by T. Abusch et al. (Bethesda: CDL Press, 2001), pp. 365–71.

⁶⁰ Hilprecht, *Explorations in Bible Lands*, p. 339.

CLASSIFYING WOMEN: THE “HAREM” AND WHAT IT DOES AND DOESN’T TELL US ABOUT WOMEN

Elna K. Solvang, Concordia College, Moorhead, Minnesota

The poet Aleksandr Polezhaev offers the following depiction of “harem” life:

There is a feast for feelings and eyes!	Burns and languishes,
Eastern beauties,	Another sings to him,
One sweeter than the other,	And sweetly ...
One more playful than the other,	Charming girls
Obedient slave girls,	Light as Zephyres
Will die with him each moment!	Flutter, circle around,
With the soul of a demigoddess	Now curl around him, now fly about,
In fiery ecstasies	Now rapidly line up.
His soul will flow together	Meanwhile in the smoke of a hookah pipe,
Fall asleep—and again wake up,	On a velvety divan
Again to drown	The sybarite in love
In an abyss of delight!	Reclines in luxury
There a burning breast	Devouring with his gaze
Attracts the imagination;	The movements of the houris of paradise,
There a white arm	He trembles and burns
Lightly beckons to him	And to the voluptuous maiden
And passionately embraces him;	The desired pledge of happiness,
One kisses him	His kerchief flies ... ¹

It is hard to imagine Inib-šarri, daughter of Mari’s king Zimrî-Lîm, residing in the context described by Polezhaev. In ARM 10 74 Inib-šarri displays her anger over not being accorded first place among women of the palace at Ašlakka, where she expected to be the one to appear publicly alongside her husband when tribute was received.² Inib-šarri does not suffer this heartache (*mu-ru-uš li-ib-bi-ia*) quietly. She writes home to papa protesting her treatment and demanding her father fetch her home—now!

Inib-šarri’s epistolary feistiness and Polezhaev’s poetic fantasy are—by centuries, cultures, and perspectives—worlds apart from one another, yet they come together in the same semantic space: the “harem.” In describing ancient monarchies, “women of the palace” (SAL.MEŠ *ša ekalli*) have traditionally been classified as the “women of the harem.” Abraham Malamat has argued that in Inib-šarri’s complaint about having to sit in a corner, “corner” (*tubqum*) refers to the “harem,” which he describes as “a secluded, well-guarded unit,” “usually located in the nether parts of the palace,” where “it appears that the king passed the night.”³ Polezhaev’s poem suggests how such nights might have passed.

¹ Aleksandr Polezhaev, “The Renegade,” excerpt from the epic poem “The Harem,” in *Stikhotvoreniia i poemy* (Leningrad: Sovetskii pisatel, 1950), pp. 116–19. (Online translation by Gitta Hammarberg: <http://www.maclester.edu/~hammarberg/russ263/Polhare.html>, accessed September 9, 2005.)

² G. Dossin, *Correspondence féminine*, Archives Royales de Mari 10 (Paris: P. Geuthner, 1978).

³ A. Malamat, “Is There a Word for the Royal Harem in the Bible? The Inside Story,” in *Pomegranates and Golden Bells: Studies in Biblical, Jewish, and Near Eastern Ritual, Law, and Literature in Honor of Jacob Milgrom*, edited by David P. Wright, David Noel Freedman, and Avi Hurvitz (Winona Lake: Eisenbrauns, 1995), p. 787.

Of course, no contemporary scholar has Polezhaev's fantasy in mind when classifying women as part of the "harem." Scholars simultaneously laugh and are appalled at the excesses of orientalist projections and do their best to distinguish contemporary references to the "women of the harem" from the fantastical misrepresentations evidenced in Polezhaev's poem. Sadly, stripping away the orientalist deposits that the term "harem" has accumulated does not totally solve the problem either. The fantasies disappear but there remains the challenge of identifying who and what is classified as the "harem."⁴

In her study of the harem of Zimrî-Lîm, Nele Zeigler summarizes various applications of and objections to the term "harem" in classifying the women at Mari. She elects to use the term, designating for her study "harem" as "the space inhabited by the women of the royal palace and more broadly the group of women belonging to the family or in the service of the king, those who might be mother, daughters, or wives of the king, or musicians, servants, or doorkeepers."⁵ In contrast, as part of her proposal for approaches to conceptualizing the role of women in Mesopotamian society, Joan Goodnick Westenholz argues that the term "harem" needs to be completely abandoned because of a "lack of correspondence [between] the model of the harem from the Islamic world" and the available evidence from ancient Mesopotamia.⁶

The widely varying perceptions and associations that crowd into the semantic space of the "harem" make use of this category challenging and sometimes confusing. But before suggesting that the term be abandoned as a classification of women in non-Islamic contexts, let me argue for a closer examination of the "harem" as it has actually functioned within Eastern society. If the "harem" is not the den of desire that Aleksandr Polezhaev fantasizes, what is it? Might the lives of women in "harems" bring insight to and new ways of understanding the data from which the lives of "women of the palace" in ancient Mesopotamia are interpreted?

Joan Goodnick Westenholz argues that the seclusion and segregation of women implied by the term "harem" in Islamic society do not apply to Mesopotamian palace women of whom at least the highest ranking are publicly visible, unveiled, and engaged in economic, cultic, and diplomatic matters.⁷ To illustrate this contrast she points to the conclusions reached by Jean-Marie Durand and Jean Margueron that the queen at Mari was not a "recluse," that "high-ranking officials had access to her," and that "she exercised power."⁸ Westenholz contrasts this portrait of Mari with the observation made by Ruth Francis Woodsmall about Egypt's monarchy at the beginning of the twentieth century. Woodsmall notes, "the Queen, before the King's death, always lived a secluded life, never appearing in any public functions, held receptions for ladies only ... [and] had no part in the life of modern Egypt."⁹ Westenholz's argument about visibility is convincing, but Woodsmall's conclusion that invisibility equals inactivity is not applicable to all Islamic royal "harems." Indeed if one looks at the Ottoman Imperial Harem it is clear that seclusion was not a barrier to the creation of a highly structured and well-connected system of female power that was critical to both the domestic and international affairs of the kingdom.

The most thorough study of the Ottoman Imperial Harem is that by Leslie Peirce. Peirce notes:

From almost the beginning of the reign of Süleyman the Magnificent, who came to the throne in 1520, until the mid-seventeenth century, high-ranking women of the Ottoman dynasty enjoyed a degree of political power and public prominence greater than ever before or after The women of the imperial harem, especially the mother of the reigning sultan and his leading concubines, were considerably more active than their predecessors in the direct exercise of political power: in creating and manipulating domestic political factions, in negotiating with foreign powers, and in acting as regents for their sons. Furthermore, they played a central role in

⁴ Arabic *ḥarīm* is used in a variety of ways to designate "a sacred, inviolable place," a "sanctuary, sacred precinct," and "female members of the family." It is etymologically related to *ḥaram* whose range of meaning extends from what is "forbidden, prohibited" to what is "holy, sacred, sacrosanct." *Ḥaram* may be used in reference to the sacred space of a mosque or the area around the Ka'aba and in designating behaviors that are taboo and foods that are unlawful (in contrast to those that are *ḥalāl*). See *A Dictionary of Modern Written Arabic*, edited by J. M. Cowan, 3rd ed. (Ithaca: Spoken Language Services, 1976), pp. 171–72, 199.

⁵ Nele Zeigler, *La population féminine des palais d'après les archives royales de Mari: Le harem de Zimrî-Lîm*, Florilegium marianum 4, Mémoires de NABU 5 (Paris: Société pour l'Étude du Proche-Orient Ancien, 1999), p. 8 (translation by the author).

⁶ Joan Goodnick Westenholz, "Towards a New Conceptualization of the Female Role in Mesopotamian Society," *Journal of the American Oriental Society* 110 (1990): 515.

⁷ Westenholz, "Towards a New Conceptualization," pp. 515, 514.

⁸ Westenholz, "Towards a New Conceptualization," p. 514, citing Jean-Marie Durand and Jean Margueron, "La question du harem royal dans le palais de Mari," *Journal des Savants* (October–December, 1980): 253–80; synopsis: *La femme dans les sociétés antiques*, Actes des colloques de Strasbourg, mai 1980 et mars 1981, edited by Edmond Lévy (Strasbourg: Association pour l'étude de la civilisation romaine, 1983), pp. 7–8.

⁹ Westenholz, "Towards a New Conceptualization," p. 514, citing Ruth Francis Woodsmall, *Women in the Changing Islamic System* (New Delhi: Bimla Publishing House, 1983) (original title: *Moslem Women Enter a New World*, 1st ed., 1936), p. 85.

what we might call the public culture of sovereignty: public rituals of imperial legitimation and royal patronage of monumental building and artistic production.¹⁰

The change, as Peirce describes it, corresponds to the "gradual transition from a state geared to expansion and led by a warrior sultan to a territorially stable bureaucratic state ruled by a sedentary palace sultan."¹¹ As matters of state became centralized, the palace and its occupants became central in the systems of administration, education, economics, and beneficence, and the networks of communication and loyalty that not only ran the palace but kept the kingdom together and secured it from other nations.¹² This, in spite of the fact that "by the end of the sixteenth century, no member of the royal family—male or female—left the capital, with the exception of the sultan himself."¹³

Centralization, as Peirce notes, brought about a "lapse of the princely governorate" and the creation of "one royal household, over which the senior woman, the sultan's mother, naturally took charge."¹⁴ The royal princes lost their power and became invisible as only the sultan was allowed to build a family and produce offspring.¹⁵ The sultan's mother, the *valide sultan*, was not only the senior member of the dynastic household but also "the link between the dynasty's generations."¹⁶

Though the future of a royal woman was tied to that of her son, Peirce notes that a mother's "power was not exclusively derived from his." She had her own "networks of influence," established before her son's rise to power, over "important inner palace officials" as well as "allies outside the palace" including slaves she had freed and families with whom she had arranged marriages for her daughters.¹⁷ The influence of royal women in diplomatic matters, Peirce suggests, "may have been strategically useful in keeping options open during a period of diplomatic difficulty for the Ottomans."¹⁸ In the final decades of the sixteenth century the *valide sultans* Nurbanu and Safiya each intervened to prevent the Ottoman Empire from going to war against Venice.¹⁹

The "harem" classification, as it functioned at the peak of the Ottoman Empire, compels us to see legitimate power in the invisible. It also reverses Western notions of space that view what is "private" as personal and separate from what is "public." Though public access to the Ottoman Imperial Palace was limited and access to the "harem" off-limits, the structure and activities inside the palace—even in its impenetrable "corners"—were focused on the public work of preserving, promoting, and continuing the rule of the imperial house across the empire and around the world.

Any decision about the appropriateness of employing the Arabic term "harem" as a category for women in non-Islamic contexts must take into account the studies of the Ottoman Imperial Palace. Knowledge of ways "harems" functioned, and how those configurations varied in different historical periods in response to imperial needs and external pressures, may have the added benefit of contributing new insights to the discussion of the "women of the palace" in ancient monarchies.

Additional sources for information on "harem" life include first-person accounts written by women. Such eyewitness accounts depict commonalities and differences in the ways "harem" life was experienced and assessed. The three women whose observations are drawn upon in this paper are:

- Emmeline Lott, a British woman hired to teach the son of Ishmael Pasha, the viceroy of Egypt. Her book is from a journal she kept while living in the "harem" of the Pasha's home. Lott intends to correct the impressions of "harem" life left by Lady Mary Wortley Montagu a century earlier. Lott charges that "her handsome train, Lady Ambassador as she was, swept but across the splendid carpeted floors of those noble Saloons of Audience, all of which had been, as is invariably the custom, well 'swept and garnished' for her reception. The interior of those harems were to her Ladyship a *terra incognita*"²⁰

¹⁰ Leslie P. Peirce, *The Imperial Harem: Women and Sovereignty in the Ottoman Empire*, Studies in Middle Eastern History (New York: Oxford University Press, 1993), p. vii.

¹¹ Peirce, *Imperial Harem*, p. x.

¹² Peirce, *Imperial Harem*, p. x. "This new harem quickly became, in addition to the residence of the royal family, a highly structured and disciplined training institution in which female members of the royal household were prepared through personal service to the sultan and to his mother to take their places in the Ottoman ruling elite, much like the pages trained in the third courtyard [i.e., the Sultan's inner circle]." Peirce, *Imperial Harem*, p. 12.

¹³ Peirce, *Imperial Harem*, p. 119.

¹⁴ Peirce, *Imperial Harem*, p. 24.

¹⁵ Peirce, *Imperial Harem*, p. 21.

¹⁶ Peirce, *Imperial Harem*, p. 17.

¹⁷ Peirce, *Imperial Harem*, p. 241.

¹⁸ Peirce, *Imperial Harem*, p. 222.

¹⁹ Peirce, *Imperial Harem*, pp. 222–23; Alev Lyle Croutier, *Harem: The World Behind the Veil* (New York: Abbeville Press, 1989), p. 106.

²⁰ Emmeline Lott, *The Governess in Egypt: Harem Life in Egypt and Constantinople*, vol. 1 (London: Richard Bentley, 1865), pp. vi–vii.

Lott promises “to disclose to European society ‘Life in the Harems of Egypt and Constantinople,’ which cannot but be considered as secret institutions for the corruption of women.”²¹

- Demetra Vaka was a Greek woman who grew up in Turkey and then moved to the United States. Her book is an account of her return visit to Turkey, as she describes it, with “a mind full of Occidental questioning,” having heard in America “the Turks reviled as despicable, their women as miserable creatures, living in practical slavery for the base desires of men.” She wishes, as she says, “to talk with the women, to ask them their thoughts about their lives and customs.”²²
- Annie van Sommer was a British woman involved in promoting Christian mission work with Muslim women in Turkey, Persia, and Egypt, including the development of schools, a hospital in Egypt, and a publishing house (Nile Mission Press). She was an editor of two volumes of reports of women’s mission work in the region.

Lott, Vaka, and van Sommer were published in the period from 1865 to 1911. Though markedly different in temperament and disposition toward “harem” life, these three witnesses provide views of women in “harems.”

It becomes apparent through the witnesses that to be in a “harem” is to be in a society, not just a space. That society is multi-generational and hierarchical, knitting together women and children of different households and of various levels of social status, including in its very structure all those who keep it functioning. With “slaves and eunuchs included,” the “harem” society in which Emmeline Lott took part she estimated to be “150–200” persons.²³ The population of the “harem” varied and the social arrangements were revised as new people—teachers, cooks, slaves, female relatives, etc.—joined the “harem” and others left, for example, through marriage, emancipation, or when their period of employment was up.²⁴ Leslie Peirce reports that in the Ottoman dynasty only a select number of women and men were continuing residents of the imperial palace.²⁵

In Demetra Vaka’s dreamy-eyed account of her visits in “harems” in her native Turkey, the new arrivals include temporary guests such as herself, as well as girls sold as servants by their impoverished parents, and second wives.²⁶ Similar faces and stories likely lie behind the lists of changes in service and adjustments in rations that Nele Ziegler documents in her study of the palace women at Mari.²⁷ The social adjustments reflected in those lists are reminiscent of Emmeline Lott’s account of sitting down to her first meal in the “harem.” She writes, “I stared again in astonishment, and looking at the [German] maid Clara, I found that she had seated herself at the table, and was prepared to *hobnob* it with me.”²⁸ Lott eats her meal quickly and departs, reflecting later:

I can scarcely describe my feelings when I was alone, being at that time totally ignorant of the apathy and absolute indifference with which the Turks, Arabs, and Egyptians treat all Europeans I was at a loss to conceive why I had been subjected to such an indignity. The position I occupied about the Prince ought most assuredly to have saved me from such an insult.”²⁹

Lott’s anger at this offense to her status expectations recalls Inib-šarri’s outrage at not being accorded first place in the court at Ašlakka.

“Harem” society, as described in the personal accounts, could be quite international. In addition to the German cook and laundry maid and her Turkish family, Lott mentions that among the fifty slaves “Arabs, Abyssinians, Ethiopians and Nubians were all mingled.”³⁰ She bemoans her situation: “Well there I was, among a crowd of nearly a hundred women, without being able to speak a word of their language, or to understand what they said to me. Then did I experience the worst of all loneliness.”³¹

²¹ Lott, *The Governess in Egypt*, pp. viii–ix.

²² Demetra Vaka Brown, *Haremlik: Some Pages from the Life of Turkish Women* (Boston: Houghton Mifflin, 1909), p. 13.

²³ Lott, *The Governess in Egypt*, p. 184.

²⁴ Lott mentions the prince’s wet-nurse who she said “told me that she was married, that her husband lived at Cairo, that she was about to leave the service of the Viceroy to return to her home” (Lott, *The Governess in Egypt*, p. 168).

²⁵ Among the women these included “the talented and lucky few who became the sultan’s concubines or were promoted to senior adminis-

trative positions. Although they rarely crossed the harem boundary to the outside world, these high-ranking women enjoyed considerable prestige and exercised considerable influence in that world” (Peirce, *Imperial Harem*, p. 12).

²⁶ Brown, *Haremlik*, pp. 116–19.

²⁷ Ziegler, *Le harem de Zimrî-Lîm*, p. 218.

²⁸ Lott, *The Governess in Egypt*, p. 137.

²⁹ Lott, *The Governess in Egypt*, p. 138.

³⁰ Lott, *The Governess in Egypt*, p. 94.

³¹ Lott, *The Governess in Egypt*, p. 142.

The international composition of "harem" society could not only lead to loneliness but to intercultural enmity. Lott's disdain for the German cook is only the tip of the hostility iceberg. She was sure everyone hated her because, she says, "as a European lady, I insisted upon receiving, and most assuredly I did receive, so far as H. H. the Viceroy and their H. H. the Princesses, the three wives, were concerned, proper respect."³²

Lott must have been a thorn in the side of her "harem" employers, but probably not as big a problem as the one Liqtum, queen of Burundum, had on her hands. In a letter to her brother Zimrî-Lîm (M.8161) she expresses delight in having been installed in the grand palace by her husband and put in charge of two hundred women. She was startled to discover in that society of women the daughter of Išme-Dagan, as well as the daughter of Mâr-Addu, whom Išme-Dagan had defeated. The daughters of enemies seem to have found common cause in taunting Liqtum, saying that Zimrî-Lîm does quite well for himself but never sends her anything. Liqtum appeals to Zimrî-Lîm to send her a gift that will allow her the satisfaction of humiliating them both.³³ So, in addition to her diplomatic efforts to establish good relations between Mari and Burundum, as documented in ARM 10 140, Liqtum faced a diplomatic challenge within palace society.

The giving of gifts shows up repeatedly in both Vaka's and Lott's accounts of "harem" life, as well as Peirce's study of the Ottoman Imperial Harem. Vaka frequently mentions generous gifts provided to her as part of the hospitality at each home she visited. Lott, on the other hand, is appalled by the gift-giving that she portrays as "that all powerful Sovereign Prince of the Ottoman Empire, 'Baksheesh'."³⁴ Lott is not opposed to receiving gifts herself, but she was offended that when the young crown prince went anywhere he distributed coins to even the lowest ranking servants, and that the viceroy and each of his wives did the same thing, as well as handed out "a supply of both plain and costly attire, to those around them with no sparing hand."³⁵ Puzzling over the wisdom and the prodigality of the distribution of wealth, Lott comments: "I can understand why His Highness displays such liberality to his consorts ... But I could never solve why such valuables were presented to the slaves of all denominations."³⁶

Lott is obviously clueless about the nature of the gift-giving she is observing and how it honors, rewards, and sustains relationships, including those between the powerful and the powerless. In her ignorance, however, Lott draws attention to the extent of personal gift-giving that takes place that is not accounted for in ledgers and by receipts. Her comments also point to the access to wealth within "harem" society. She is astounded by the hoards of coins and the jewelry and gems that even the slaves possessed.

Each of the sources describing "harem" society draw attention to "harem" women's right to own and control wealth and property.³⁷ Ancient Mesopotamian tablets recording grants, deeds, dowries, tributes, offerings, and rations demonstrate that various women of the palace purchased, sold, and exchanged property and persons and made gifts.

The transfer of valuables in "harems" brings to mind Section 5 of the Middle Assyrian Palace Decrees. In that section there is a decree that forbids a woman of the palace (*sinniltu ša ek[alle]*) from giving "gold, silver or precious stones to a palace slave (*urad ekalle*)."³⁸ Ernst Weidner drew a parallel between this decree and the injunction in the Middle Assyrian Laws against a slave "receiving anything from the hand of a married woman."³⁹ In the Middle Assyrian injunction the husband is permitted to decide whether to cut off the nose and ears of the slave and the ears of the wife. The goods are to be restored.⁴⁰ A. K. Grayson concludes, "Besides being a measure dealing with simple theft ... [the law] was ... meant to forestall bribery and treasonous plots."⁴¹

³² Lott, *The Governess in Egypt*, p. 211.

³³ Pierre Marello, "Liqtum, reine du Burundum," in MARI 8 (Paris: Ministère des Affaires Étrangères, 1997), p. 456.

³⁴ Lott, *The Governess in Egypt*, p. v.

³⁵ Lott, *The Governess in Egypt*, p. 184.

³⁶ Lott, *The Governess in Egypt*, p. 263.

³⁷ One of the conference reports included in Annie van Sommer's edited volume makes the observation that women in "harem" society have an "advantage" since "they have the legal right to own and control property" (M. M. Patrick, "Among the Educated Women of Turkey," in *Daylight in the Harem: A New Era for Moslem Women: Papers on Present-Day Reform Movements, Conditions and Methods of Work Among Moslem Women Read at the Lucknow Conference*,

1911, edited by Annie van Sommer and Samuel M. Zwemer [New York: Fleming H. Revell, 1911], pp. 73–74).

³⁸ Martha T. Roth, *Law Collections from Mesopotamia and Asia Minor*, Writings from the Ancient World 6 (Atlanta: Scholars Press, 1995), p. 199.

³⁹ Ernst Weidner, "Hof- und Harems-Erlasse assyrischer Könige aus dem 2. Jahrtausend v. Chr.," *Archiv für Orientforschung* 17 (1954–56): 273.

⁴⁰ G. R. Driver and John C. Miles, *The Assyrian Laws* (Oxford: Clarendon Press, 1935), p. 383, ¶ 4.

⁴¹ Albert Kirk Grayson, *Assyrian Royal Inscriptions*, vol. 1, *From the Beginning to Ashur-Resha-Ishi I*, Records of the Ancient Near East (Wiesbaden: Harrassowitz, 1972), p. 100.

The Palace Decree is not entirely parallel to the law. While the law forbids a married woman to pass along anything (*mimma*) to a slave, the woman of the palace is forbidden from passing along “gold, silver or precious stones.” The slave passes the valuables to a craftsman (*ēpiš šipre*) who produces something (*šipru*).⁴² If the decree is violated, the palace woman is to be detained (*la uššuru*), at least one of the violators is threatened with severe disfigurement, and the one who fails to report the violator to the king they will “douse (with hot oil?).”⁴³ There is no mention of restitution.

It is logical to suggest that the decree is suspicious of a palace slave being in possession of gold, silver, and precious stones. It is not hard to imagine an unscrupulous member of the royal household or suspicion on the part of the reigning monarch. Since “harem” society is actually the hierarchical arrangement of individual female households, within which mistress and staff lived and worked in close contact, loyalty was essential and discipline local. Both the descriptions of “harem” life and the Middle Assyrian Palace Decrees address the at-times severe disciplining of slaves by their mistresses.

Lott’s account of “harem” society depicts household members—including slaves—living in contact with and in possession of valuables. The Palace Decree says nothing about the possession of valuables but forbids the use of a slave in their transfer—to someone presumably not a member of the palace staff. Perhaps suspicion is not directed toward household members but toward the outsider.

Interestingly, in the wealthy “harem” where Emmeline Lott resided there is a discussion of jewelers, including her note that “it is no uncommon occurrence, where valuable ornaments are taken away by such individuals out of the Harems, that some of less value are substituted, or else they are purloined.”⁴⁴ In this regard, Lott reports a lawsuit brought in British Consular Court by a woman of the late viceroy’s harem in an attempt “to recover a valuable ornament ... worth 2,500£ which she had entrusted to the defendants to repair.”⁴⁵ This case apparently was not unique. In reference to jewelry delivered to a bride and her family, Lott was told, “like a great portion of the modern *bijoux* generally sold to the inmates of many of the Harems ... they were perfect rubbish, being neither more nor less than metal covered with a thick plate of gold, and for which the slaves pay almost fabulous sums”⁴⁶ (emphasis added). The Middle Assyrian Palace Decree offers no explanation for the injunction against transfer of valuables through slaves, but its suspicion may focus on those outside the palace and its purpose may be consumer protection.

Lott’s account of deceptive jewelers illustrates an important dimension of “harem” society that is echoed in each of the testimonies: “harem” society is closed to men from the outside but open to women of a variety of occupations, nationalities, religious traditions, and political persuasions. Access is through the women inside—not the guards outside. “Harem” society is also mobile, traveling at times without king, viceroy, or husband to join together with other women for business or pleasure.

The connections drawn in this paper between women’s lives during the Ottoman period and evidence of Mesopotamian palace women are not intended to imply that the two contexts are the same—though the term “harem” is commonly employed to suggest such parallels. The accounts of “harem” life discussed here offer glimpses into the complex social structure and wide-ranging activities of “harem” women. These accounts both challenge the common portrait associated with the “harem” classification of women and invite a second look at how the evidence from ancient Mesopotamia is interpreted.

In common discourse as well as scholarly writings the category “harem” has frequently implied a lattice screen, hiding women’s lives and rendering “harem” women mysterious, powerless, unknowable objects of male desire and control. This paper began with Aleksandr Polezhaev’s poem “The Harem” not to inflame orientalist fantasies but to demonstrate that when Polezhaev takes readers behind the lattice screen he depicts the “harem” as a *man’s* world. This paper has attempted to argue that the “harem” can and should be understood as a *woman’s* world, knowable and negotiable from the inside.

⁴² Roth, *Law Collections*, p. 199.

⁴³ Roth, *Law Collections*, p. 199.

⁴⁴ Lott, *The Governess in Egypt*, p. 172.

⁴⁵ Lott, *The Governess in Egypt*, p. 172.

⁴⁶ Lott, *The Governess in Egypt*, pp. 172–73.

PERSEPOLIS-PASARGADAE FIELD INVESTIGATIONS

Mohammad Hassan Talebian, Parsa-Pasargadae Research Foundation

The aim of this paper is to present an interim report on research and conservation activities in the Parsa-Pasargadae region since 2001. I would like to express our deep sense of gratitude to the Oriental Institute of the University of Chicago. As everyone knows, the Oriental Institute has been instrumental in the inception and progress of Persepolitan studies. The great discoveries of Ernst Herzfeld and Erich F. Schmidt and the significant work of Friedrich Krefter, George Cameron, Richard Hallock, and Raymond A. Bowman are significant and lasting contributions to Achaemenid studies.

The pioneering works of these scholars transformed our knowledge of Persian culture and art; they also enabled Iranian archaeologists, notably Ali Sami, Akbar Tajvidi, and Shapur Shahbazi, to carry out the task of excavating and preserving Persepolitan monuments. At the same time, despite the unavoidable hiatus, the Oriental Institute has continued to be the torch-bearer of Achaemenid studies, thanks to the patronage of William Sumner, Gene Gragg, and Gil Stein, the former and present directors of the Oriental Institute, as well as the sustained academic interest of Charles Jones and the scholarship of such exemplary researchers as Matthew Stolper, Mark Garrison, and Margaret Cool Root. Their work, as well as that of Abbas Alizadeh, has provided valuable contributions which have greatly encouraged Iranian colleagues and students. And so it is indeed fortunate that with the establishment of the Parsa-Pasargadae Research Foundation we are re-establishing our contact after an interruption of two decades.

The following chart provides the hierarchy of research and organization at the Foundation. As the chart indicates, we have tried to work out a structure that would provide a systematic matrix for various types of library and field research (fig. 1).

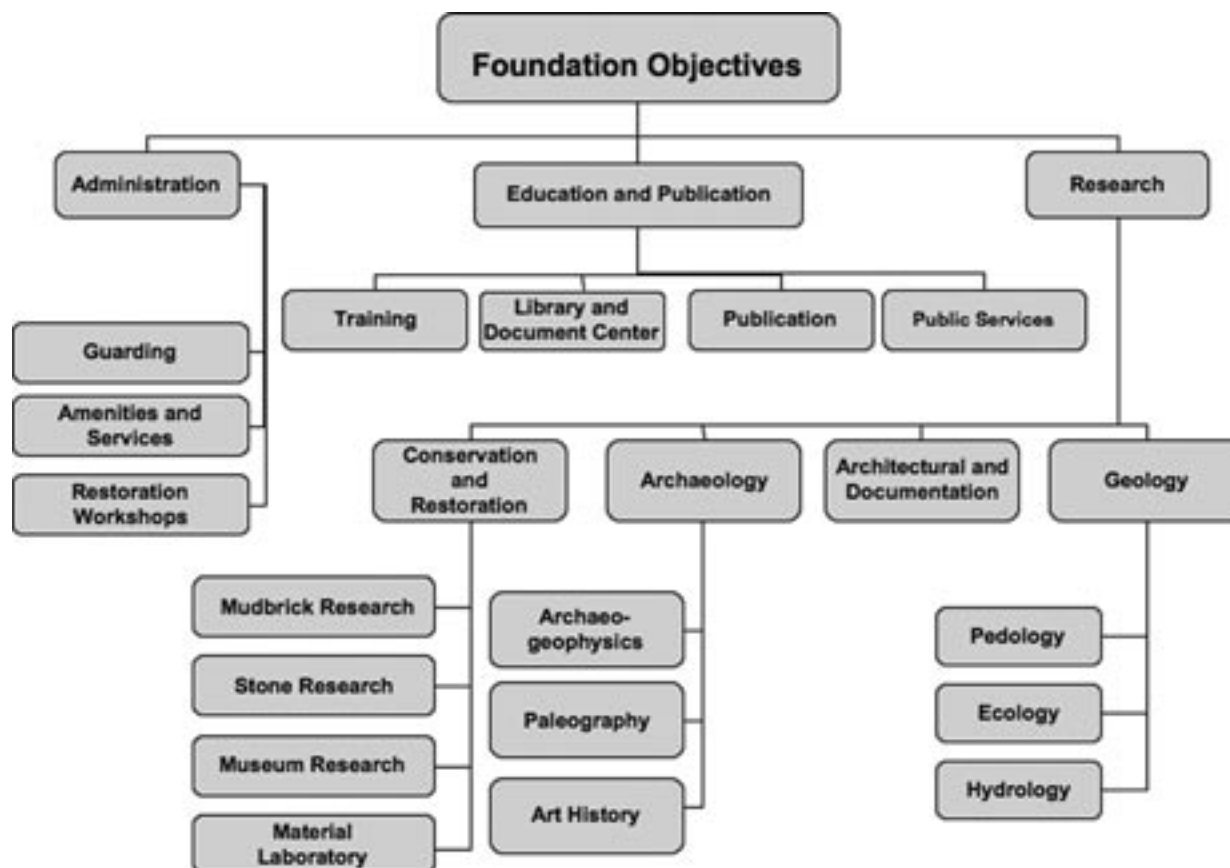

Figure 1. Chart showing hierarchy of research and organization at the Parsa-Pasargadae Research Foundation.

In the initial stages, we concentrated on gathering scientific documentation. We drew up and presented evidence necessary for registering first Persepolis and then Pasargadae as world heritage sites. This designation has increased our responsibility to preserve their authenticity in the contexts of artistic and cultural environment. The area of Persepolis was mapped to the scales of 1:5,000 and 1:2,000 to facilitate clearer understanding of the archaeological sites in the area. This was complemented by aerial photography of the entire area to the scales of 1:3,000 and 1:8,000 (fig. 2).



Figure 2. Aerial photo of the Persepolis area.

At the same time, we began creating a database on Persepolis, Pasargadae, and related sites. We collected records of the previous activities, studies, and visual documentation such as slides, photos, maps, and drawings.

Our staff took great pains to systematize these in order to make them available to interested specialists. Furthermore, the library at Persepolis, which was expanded in the 1970s, has been further enlarged with new acquisitions and equipped with a computerized filing system. We realize, of course, that it is far from adequate, but we hope that it can become so through generous contributions by authors, institutions, and other patrons of Persepolis.

From the start we faced three major problems: how to safeguard the site from urban development and ever increasing tourism; how to stop further deterioration of the monuments; and finally how to improve our investigations through the use of sophisticated methods and technology.

Over the past fifty years, the tiny village of Marvdasht has grown into a large town. As a result, this urban expansion together with transportation and industrial and agricultural activities threaten all the monuments in the region, particularly the remnants of the once flourishing city of Parsa. We have managed to save parts of the site by expanding the buffer zone of Persepolis (fig. 3).

More recently an area of 52.5 hectares (in addition to the buffer zone) has been purchased for the sake of extending the domain of field research. Our current challenge is to extend the area even farther in the future. A similar process was carried out at Pasargadae, where the earlier buffer zone has been enlarged to include a greater part of the site.

To avoid further erosion resulting from site visits by numerous tourists, we have planned a major walkway to the foot of the platform. At the head of the walkway, we have set up an information center in a large tent. Moreover, all the stairways are covered with wood planks (fig. 4). We also have designated a tour path for the entire site of Persepolis where visitors can use Persian/English audio cassettes to self-guide and obtain crucial information about the site (fig. 5).

Much has been done with regard to minimizing the erosion owing to earlier improper restoration methods and material, especially concrete mortar. Even the application of mastic glue or rock-bolt, steel, and bronze pins developed in the 1970s are now considered to be inappropriate methods and harmful to the goal of retaining the historical integrity of the monuments as outlined by the UNESCO charters on authenticity. Our technical team first studied the detrimental effects of such usage and then began dealing with the physical, chemical, and biological agents.

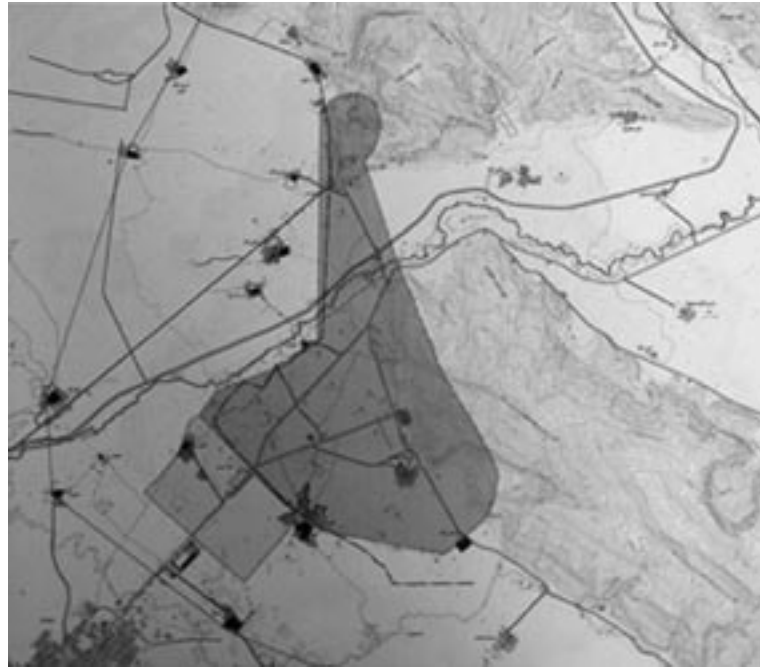

Figure 3. Map showing the buffer zone around Persepolis.



Figure 4. Preparation of the protective staircase at Persepolis.

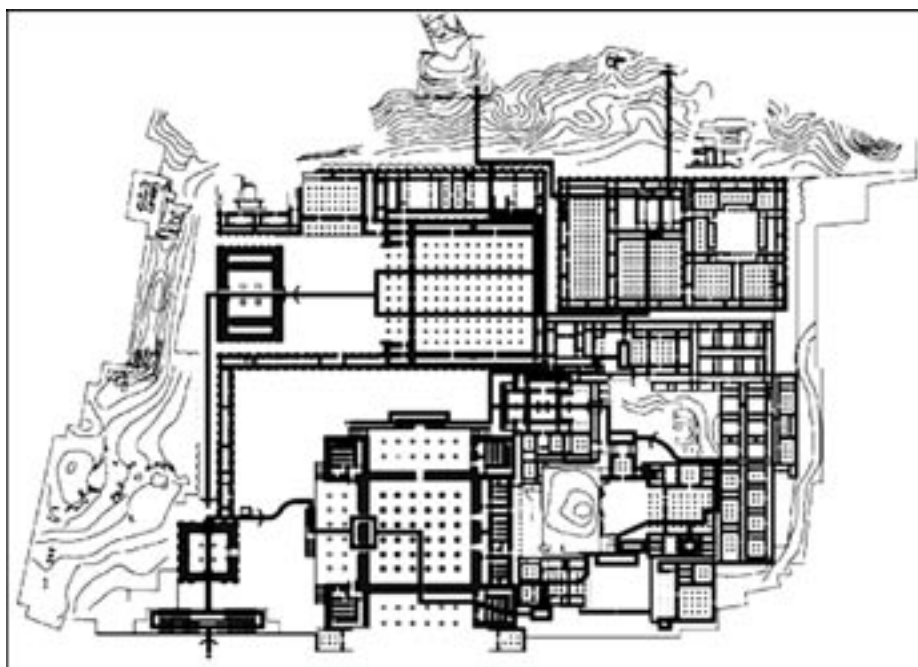

Figure 5. Designed visitor's path (2005).

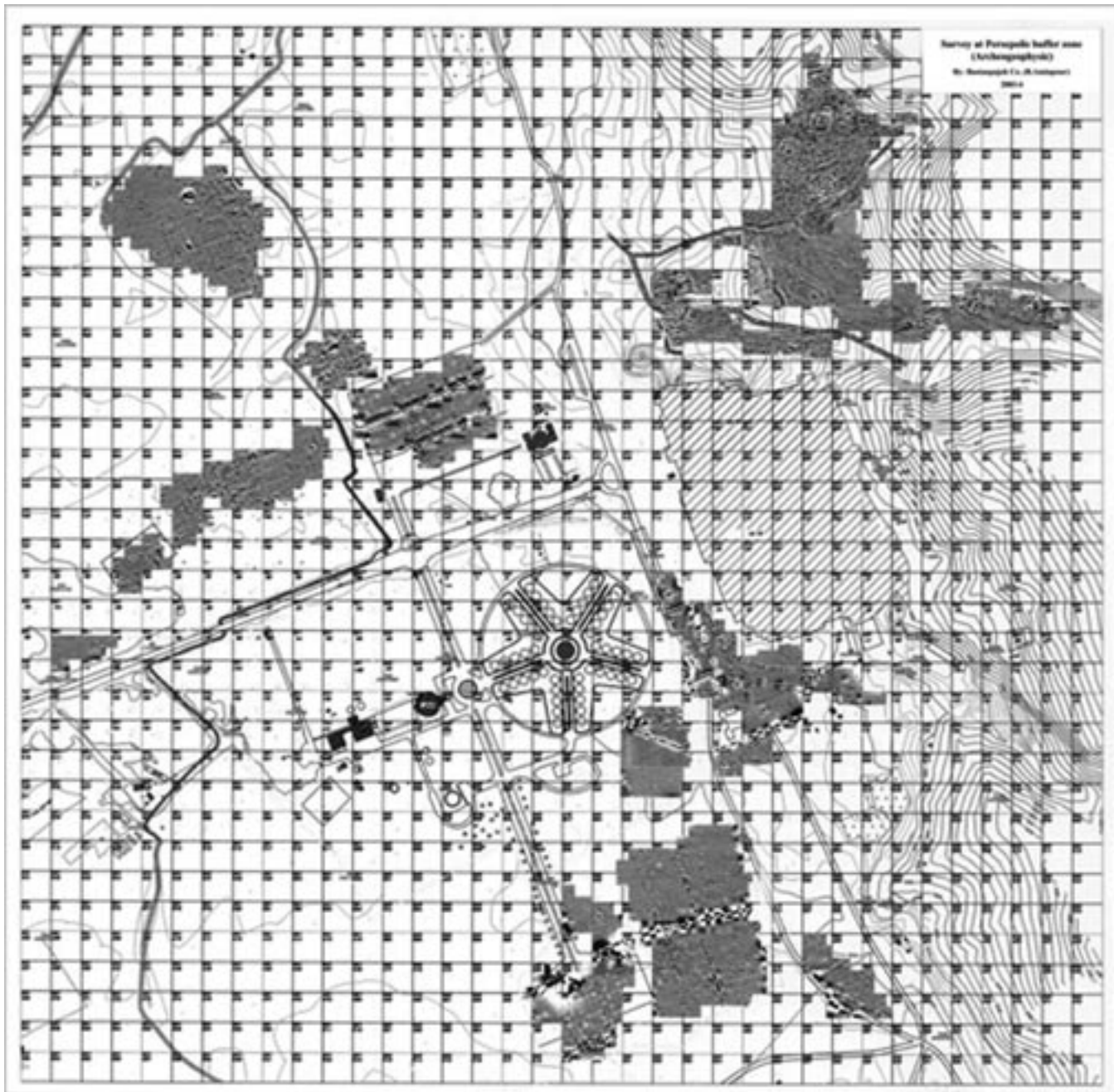

Figure 6. Areas (shaded gray) at Persepolis investigated by archaeogeophysical methods (2005).

Work is in progress to reduce and control the eroding effects of the dissolved salts on the monuments resulting from the deposition of salt in the pores and in the spaces between stone blocks. It is particularly in this field of preservation that we are especially in need of help from scientific communities. Case studies of weathering of limestone on the façade of the tomb of Darius the Great and the erosion resulting from moss, gray lichen, and surface flaking on the tomb of Cyrus the Great have been completed and at Naqsh-e Rostam measures for arresting the erosion have been implemented. The same has been done at Persepolis where decaying agents such as algae, moss, and lichen have accelerated erosion and flaking.

Furthermore, we have used modern methods and technology, such as archaeogeophysics, in a wide range of functions and places. For instance, some 47.3 hectares of the field around the Persepolis Platform have been carefully measured and investigated. In order to do this properly, we are using the matrix method so that we can clarify the relationship of the monuments on the platforms and the historical structures spread out on the plain around the platform (fig. 6).

The measurement was first conducted on the southern side, from north of the Residential Quarters south of the Platform and extending to the south and west along what was formerly known as the Royal Tents. In some places,

modern installations, such as electric cables, water pipes, and power posts hindered a clear understanding of the buried area, a major problem that urgently needs to be solved. However, in the area to the west of the South Residential Quarters and south of the recreation area known as the Pardis Park traces of ancient construction became visible, indicating what appears to have been water canals which presumably once irrigated the gardens on the site. We hope to conduct further excavation in this area to clarify the nature of these elements.

We continued such investigations around the area's historical sites which are constantly threatened by agricultural development. For example, the area to the north of the Fratadara Temple complex revealed architectural elements (fig. 7) and the North Residential Quarters to the north of the Platform showed structural remains and extensive settlements.

Archaeogeophysical methods revealed buried metallurgical kilns as well as stones bonded with iron clips. Furthermore, two parallel walls could be traced running to the north of the Platform and extending up to the mountains (fig. 8). Again, we hope to clarify the fortification around the Platform by conducting excavations in the near future.

A similar geophysical survey of the Pasargadae area was undertaken by our team and by Professor Rémy Boucharlat of the French National Research Center (CNRS). This survey resulted in the identification of previously unknown architectural elements next to the Zendan-e Soleyman and in other places. In addition, the survey revealed

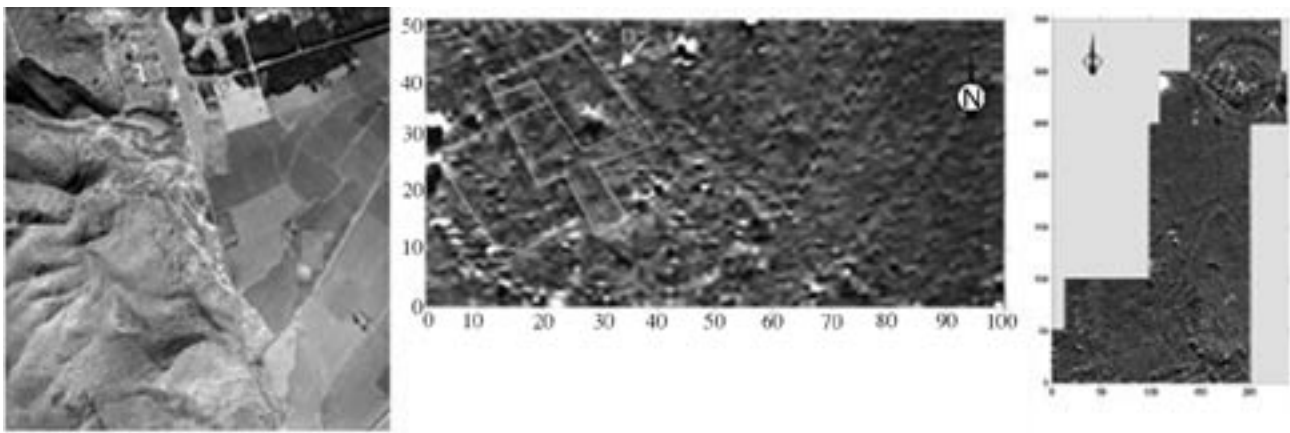

Figure 7. Mound and architectural constructions at the north of the Fratadara Temple complex.

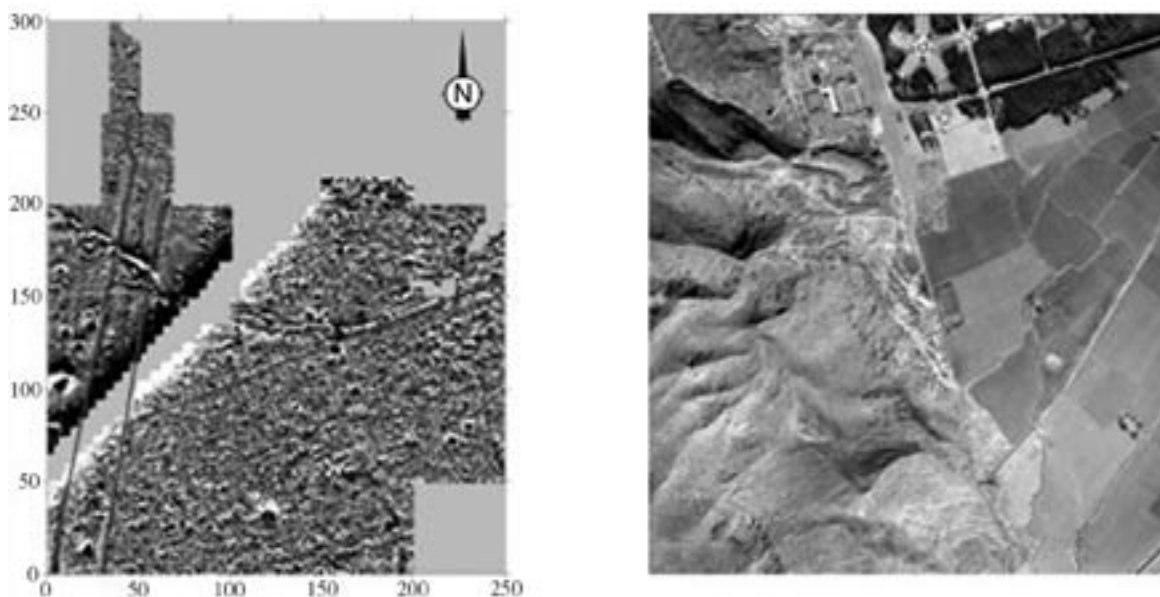

Figure 8. (left) Northern corner of the Platform and (right) northern area beyond region the terrace.

traces of possible irrigation canals that would help in understanding the relationship between the palaces and the garden area (fig. 9). These new methods are helping us to document the limits of Parsa, Pasargadae, and Istakhr.

Apart from these activities, we have cooperated with a number of academic institutions in archaeological investigations. For example, we have collaborated with Dr. Abbas Alizadeh of the Oriental Institute to conduct fieldwork at the prehistoric sites in the Marvdasht plain, such as Tall-e Bakun A and B, Tall-e Mushaki, and Tall-e Jari A and B. Our aim is to document the development of human occupation of this plain since the early Neolithic period.

We also assisted Dr. Kamyar Abdi of Dartmouth College when he revisited Tall-e Malyan. And we have worked closely with the Archaeological Institute of Tehran University to conduct salvage excavations at Tappeh Rahmatābād (fig. 10), a Bakun A-period site. This is a large mound located south of the Sivand Dam and on the road to Isfahan. The construction of a new highway at the foot of the mound will no doubt obliterate much of the site. The salvage excavations that were supervised by Dr. Hasan Fazeli have so far revealed several thousand stone implements, pottery, pottery kilns, clay tokens, and other objects indicating an advanced society. In the northern and western parts of the site, sections of a mudbrick wall some 10 feet thick which seems to be Achaemenid but rests on virgin soil were traced.

Another aspect of our investigation concerned the tracing and cleaning of the clogged underground water canals on the Persepolis Platform (fig. 11a). This was done not only to prevent future flooding of the site but also to understand the entire drainage system. This drainage system consisted of subterranean channels which led the rain and



Figure 9. Pasargadae gardens, courtesy of R. Boucharlat et al., CNRS 2002.



Figure 10. Excavations in progress at Tappeh Rahmatābād.

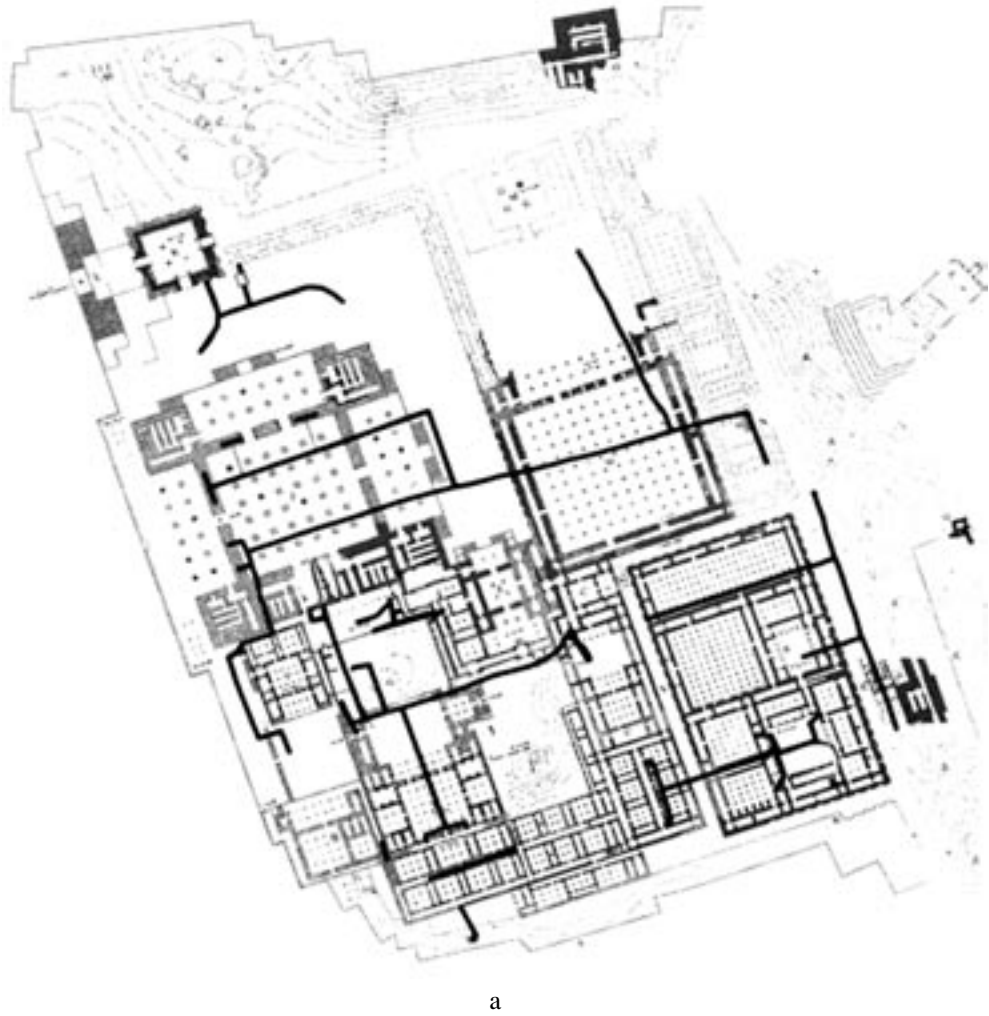

Figure 11. (a) Plan of the drainage system (2003) and (b) main exit canal at the southeastern side of the terrace.

refuse waters on the platform to the outside of the area. Herzfeld, Ali Sami, and Ali Hakemi had already done some excavations of these channels, but the entire system was still not well known.

In 2003, some 600 meters of this system were carefully cleaned by our archaeological team. The cleaning was conducted from the large, stepped tunnel in the area east of the 100-Column Hall to the southeast of the Treasury. All these investigations revealed large numbers of Achaemenid and post-Achaemenid sherds (fig. 11b).

In 2004 cleaning of the water channels continued from the southeast of the Treasury all the way to the south Platform wall. We wanted to use the same Achaemenid system of drainage to solve our own drainage problem. Therefore, it was necessary for us to excavate and clean these channels so that they could help us preserve the site from accumulations of rain and waste water. In the course of our operations in these canals, we discovered a pool-like basin southeast of the area which collected the water; once the sediment settled and the water became clean, the water was let out through an opening. We are still searching for the relation between this system and the platform.

Now, considering the fact that there is a water reservoir in the South Residential Quarters, we can clearly see the relationship between this quarter and the palace area.

We hope to continue our investigation in the southern part of the Platform and to clear out the debris accumulated since the 1930s, revealing the entire south Platform wall and recovering a large number of stone fragments and other features buried under the debris.

Another goal of the Parsa-Pasargadae Research Foundation is to facilitate cooperation between our national and foreign experts and institutions. The salvage operations at Tang-e Bolaghi are the best examples of such cooperation. The gorge of Bolaghi stretches from Pasargadae to Persepolis, some 70 kilometers (fig. 12). This valley is formed by the Pulvar/Sivand River which has cut into the terrain. A dam under construction in the southern sector of the Bolaghi Valley will soon submerge an area some 12 square km. In the northern part of the Bolaghi there are two features resembling canals or roads that probably date to the Achaemenid period (fig. 13).

There are close to 130 sites dating from prehistoric times to the Safavid period. The urgency in rescuing these sites is obvious. So far eight international teams of archaeologists have responded to our call. They include archaeologists from CNRS, the University of Bologna, Warsaw University, the German Archaeological Institute, Tehran University's Institute of Archaeology, New York State University, a Japanese expedition, and the University of Tübingen. We hope the number of salvage expeditions will grow in the near future.

A site containing traces of stone-faced walls was excavated by a joint Irano-Italian team, revealing, among other things, a typical Achaemenid arrowhead. Most recently this team discovered a grave containing a body buried in a crouched position and an associated pottery vessel. This clearly dates from a much earlier period, most probably from the Bakun A period.

Another group, the joint Franco-Iranian team, has investigated the rock-cut canals or roads as well as two cemeteries. One cemetery dating from the Safavid period contained many closely placed graves dug into earlier strata revealing Sasanian walls and a plastered basin as well as fragmentary column bulls and bases of the Achaemenid period. It is clear that this graveyard had destroyed earlier settlements.

The second cemetery contained graves covered with loose stones. Seven were excavated; five had been thoroughly robbed but two retained intact skeletons, one of which was accompanied by grave goods evidently of Sasanian date.

The team also dug five trenches in the "stone road," but so far the results are unclear. The Polish-Iranian team has excavated a site with Sasanian architectural remains and pottery, including large jars, and has investigated a related cemetery which has been totally looted.

The German-Iranian team excavated two sites which produced surface pottery of historic date over cultural remains of prehistoric ages. Most importantly, one site revealed levels of Bakun A, with painted pottery of exceptional workmanship as well as evidence of pottery-making kilns.

All these activities will continue in the coming years. We have many plans and much hope. The Museum at Pasargadae is to be finished as a center for Achaemenid heritage. Miniature models of Persepolis and other sites are to be designed and constructed. Work at Marvdasht sites, especially an investigation of Naqsh-e Rostam and Istakhr, are to be carried out. Reports and surveys as well as general Achaemenid studies must be published. The first book is already out — an authoritative guide to Persepolis in both English and Persian. Others are planned. Persepolis and Pasargadae are World Heritage sites and they deserve whatever help they can receive. Thanks to Professor Gil Stein and his predecessors, the Oriental Institute has been a pioneer in such effect, and I have no doubt that it will return to those sites to continue first-class scholarly work, this time with our earnest cooperation.

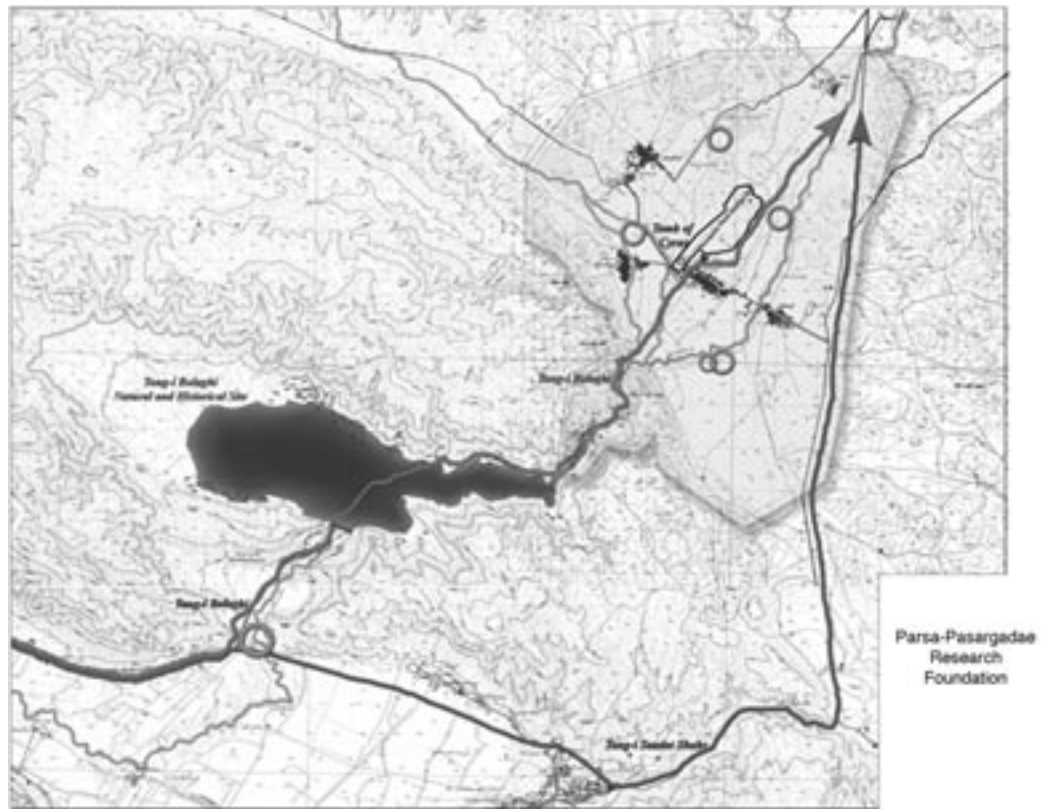

Figure 12. Historical sites along the historical roads and modern highways (Pasargadae and Bolaghi Gorge).



Figure 13. Possible irrigation canal near Bolaghi Gorge.

AFTERWORD

DE BREVITATE VITAE TUPŠARRŪTI:
CARMEN AMOEBAEUM VEL ZAMĀR MIḤRĪ

Presented to the 51st RAI at the closing ceremony by
Walter Farber, The University of Chicago

1.

Maßig langsam.



Gau-de-a- mus *I-gi-tuḥ*, ju-ve-nes An - A- nu;
Gaudeamus igitur, juvenes dum sumus;



post *Ā-sû-tim*, *Ā-ši-pū-tim*, post *Ni-šir-tim* ša *bā-rû-tim*
post jucundam juventutem, post molestam senectutem



nos ha- be - bit *Lā-nu*, nos ha- be - bit *Lā-nu*!
nos habebit humus!

- | | |
|--|---|
| <p>2. Ubi sunt qui <i>Antagal</i>
in <i>Tintir-Babila</i>?
Vadite ad <i>Izbu, Lu</i>,
transite ad <i>Šurpu, *Zû</i>,
ubi iam <i>Šu'ila</i>.</p> | <p>2. Ubi sunt, qui ante nos
in mundo fuere?
Vadite ad superos,
transite ad inferos,
ubi iam fuere.</p> |
| <p>3. Vita nostra <i>Tu-ta-ti</i>,
brevi <i>Šumma ālu</i>.
Venit mors <i>Zikurruda</i>,
rapit nos <i>Uḥburruda</i>,
nemini <i>Su'ālu</i>.</p> | <p>3. Vita nostra brevis est,
brevi finietur;
venit mors velociter,
rapit nos atrociter,
nemini parceretur.</p> |

- | | |
|--|---|
| <p>4. Vivant <i>Udughulameš</i>,
 vivat <i>Kagal, Niga</i>,
 vivat <i>Ana ittišu</i>,
 vivat <i>Šammu šikiššu</i>,
 semper sit <i>Šaziga</i>!</p> | <p>4. Vivat academia,
 vivant professores;
 vivat membrum quodlibet,
 vivant membra quaelibet,
 semper sint in flore!</p> |
| <p>5. Vivant <i>Era, Gilgameš</i>,
 ^d<i>Dim.me, Proto-Izi</i>,
 vivant Lex <i>Ḫammūrabi</i>,
 <i>Namburbi ḫulduabi</i>,
 atque <i>Ḫulbazizi</i>!</p> | <p>5. Vivant omnes virgines
 faciles, formosae;
 vivant et mulieres
 tenerae, amabiles,
 atque laboriosae!</p> |