

# **BOTANY**

**Higher Secondary Second Year**

Untouchability is a sin  
Untouchability is a crime  
Untouchability is inhuman



**TAMIL NADU  
TEXTBOOK CORPORATION  
COLLEGE ROAD, CHENNAI - 600 006.**

© Government of Tamil Nadu

First edition – 2005

Reprint – 2006

**CHAIRPERSON**

**Dr. K. AJITHADOSS**

Reader and Head

Department of Botany

Presidency College (Autonomous)

Chennai 600 005.

**REVIEWERS**

**Dr. Capt. T.T. PANDIAN**

Reader and Head

Department of Plant Biology and

Plant Biotechnology

Government Arts College for Men

(Autonomous), Nandanam

Chennai - 600 035.

**Thiru. S.S. RATHINAKUMAR**

Selection Grade Lecturer in Botany

P.G and Research Department

Presidency College (Autonomous)

Chennai - 600 005

**AUTHORS**

**Dr. Mrs. RENU EDWIN**

Lecturer in Botany

P.G and Research Department

Presidency College (Autonomous)

Chennai 600 005.

**Dr. T. SEKAR**

Lecturer in Botany

P.G. and Research Department

Pachaiyappa's college

Chennai – 600 030.

**Thiru. P. SANKAR**

Selection Grade P.G. Asst. in Botany

Govt. Girls Hr. Sec. School

Chengalpet – 603 001

Kancheepuram District.

**Thiru. S. MUNUSAMY**

Selection Grade P.G. Asst. in Botany

Govt. Girls Hr. Sec. School

Ashok Nagar,

Chennai - 600 083.

*This book has been prepared by the Directorate of School Education  
On behalf of the Government of Tamil Nadu*

This book has been printed on 60 GSM paper

**Price Rs.**

## *Preface*

The most important and crucial stage of school education is the higher secondary level. This is the transition level from the generalised curriculum to a discipline-based curriculum.

In order to pursue their careers in basic sciences and professional courses, students take up Botany as one of the subjects. To provide them sufficient background to meet the challenges of academic and professional streams, the Botany textbook for Std. XII has been reformed, updated and designed to include basic information on all topics.

Each chapter starts with an introduction followed by subject matter. All the topics are presented in clear and concise manner. The chapters end with self-evaluation questions.

Understanding the concept is more important than rote memory. Science may be learnt by rote, but wisdom not. Hence, it is desired to make the students understand the subject thoroughly, so that they can put forth their ideas clearly. In order to make the learning of Botany more interesting and thorough, application of concepts in real life situations is presented in this text.

Due importance has been given to develop skills in experimentation and observation. The learning experience makes them to appreciate the role of botany towards the improvement of our society.

Following are the salient features of this text.

- The data has been systematically updated.
- The line diagrams are neatly presented.
- Self-evaluation questions are included to sharpen the reasoning ability of the students.

*While preparing for the examination, students should not restrict themselves, only to the questions given in the self-evaluation. They must be prepared to answer the questions from the text. Several items of learning materials of biological interests have been put in boxes in the text to arouse curiosity and to add current ideas among students. These are not to be counted as contents for examinations.*

**Dr. K. Ajithadoss**

Chairperson Text book committee.

## **SYLLABUS (140 periods)**

### ***UNIT - 1 Taxonomy of Angiosperms (20 periods)***

Types of classifications - artificial - natural - phylogenetic. Biosystematics - binomial nomenclature - herbarium and its uses. Bentham and Hooker's classification of plants - families - Malvaceae - Fabaceae - Rubiaceae - Asteraceae - Solanaceae - Euphorbiaceae - Musaceae -Arecaceae and their Economic importance.

### ***UNIT – 2 Plant anatomy (15 periods)***

Tissue and tissue systems - anatomy of monocot and dicot roots - anatomy of monocot and dicot stems - anatomy of dicot and monocot leaves- Secondary growth in dicot stem.

### ***UNIT – 3 Cell biology and genetics (25 periods)***

Chromosomes - structure and types - genes and genomes - linkage and crossing over - gene mapping - recombination of chromosomes - mutation - chromosomal aberrations - DNA as genetic material - structure of DNA - replication of DNA - structure of RNA and its types - role of RNA in protein synthesis - Genetic code - transcription - translation.

### ***UNIT – 4 Biotechnology (30 periods)***

Recombinant DNA technology - transgenic plants and microbes - plant tissue culture and its application - protoplasmic fusion - single cell protein.

### ***UNIT – 5 Plant physiology (30 periods)***

Enzymes - classification - properties - mechanism and action. Photosynthesis – significance – site of photosynthesis – photochemical and biosynthetic phases – electron transport system – cyclic and non-cyclic photophosphorylation – C<sub>3</sub> and C<sub>4</sub> pathways – photorespiration – factors affecting photosynthesis – mode of nutrition – autotrophic – heterotrophic – saprophytic – parasitic and insectivorous plants – chemosynthesis – respiration – mechanism of glycolysis – Krebs cycle – pentose phosphate pathway – anaerobic respiration – respiratory quotient – compensation point – fermentation. Plant growth – growth regulators – phytohormones – auxins – gibberellins – cytokinins – ethylene and abscisic acid. Photoperiodism and vernalization.

### ***UNIT – 6 Biology in human welfare (20 periods)***

Food production – breeding experiments – improved varieties and role of biofertilizers. Crop diseases and their control – biopesticides – genetically modified food – biowar – biopiracy – biopatent – sustained agriculture and medicinal plants including microbes. Economic importance – food yielding (rice) – oil yielding (groundnut) – fibre yielding (cotton) and timber yielding (teak) plants.

## **PRACTICALS (30 periods)**

### **1. Taxonomy**

To dissect and describe the floral parts of the given parts in the following families.

- |                       |                          |
|-----------------------|--------------------------|
| i. <i>Malvaceae</i>   | ii. <i>Fabaceae</i>      |
| iii. <i>Rubiaceae</i> | iv. <i>Asteraceae</i>    |
| v. <i>Solanaceae</i>  | vi. <i>Euphorbiaceae</i> |
| vii. <i>Musaceae</i>  | viii. <i>Areaceae</i>    |

### **2. Anatomy**

To identify and write notes on the following slides

- |                           |                          |
|---------------------------|--------------------------|
| i. T.S. of dicot stem     | ii. T.S. of dicot root   |
| iii. T.S. of monocot stem | iv. T.S. of monocot root |
| v. T.S. of dicot leaf.    | vi. T.S. of monocot leaf |

### **3. Cell biology and genetics**

- i. To describe the model of DNA / photograph of DNA.
- ii. To describe the types of RNA as seen in photograph.
- iii. To describe callus / plantlets in tissue culture.  
(real specimens or photographs)

### **4. Plant physiology**

To describe the experimental setup on the following topics.

- |                   |                   |
|-------------------|-------------------|
| i. Photosynthesis | ii. Respiration   |
| iii. Osmosis      | iv. Transpiration |

### **5. Economic importance of plants**

To identify and describe plants as prescribed in the syllabus.

# **BOTANY**

## **CONTENTS**

|                                     | <b>Page no.</b> |
|-------------------------------------|-----------------|
| <b>1. TAXONOMY OF ANGIOSPERMS</b>   | <b>1</b>        |
| <b>2. PLANT ANATOMY</b>             | <b>68</b>       |
| <b>3. CELL BIOLOGY AND GENETICS</b> | <b>110</b>      |
| <b>4. BIOTECHNOLOGY</b>             | <b>144</b>      |
| <b>5. PLANT PHYSIOLOGY</b>          | <b>168</b>      |
| <b>6. BIOLOGY IN HUMAN WELFARE</b>  | <b>230</b>      |

# 1. TAXONOMY OF ANGIOSPERMS

Taxonomy is concerned with the laws governing the classification of plants. The term taxonomy includes two Greek words *taxis* – arrangement and *nomos*– laws. Plant taxonomy is otherwise known as **systematic botany**. Classification, identification, description and naming the plants are the bases of plant taxonomy. The taxonomic knowledge about the plants is based on their form and structure. The knowledge gained through taxonomy is useful in the fields of medicine, agriculture, forestry, etc.

The ultimate aim of classification is to arrange plants in an orderly sequence based upon their similarities. The closely related plants are kept within a group and unrelated plants are kept far apart in separate groups. The other aim of classification is to establish phylogenetic relationships among the different groups of plants. The plants that are closely related show more similarities than differences.

The earliest systems of classification were simple and based on one or few characters. They gave importance to vegetative characters. The later systems of classification gave more importance to floral characters because floral characters are more stable and permanent.

## 1.1. Types of classification

The different types of classification proposed by earlier taxonomists can be broadly categorized into three systems– artificial, natural and phylogenetic.

### *Artificial system*

It was based on one or at most only a few superficial characters. In **1753**, **Carolus Linnaeus** of Sweden published his book “*Species Plantarum*” wherein he described 7,300 species. He divided the plants into 24 classes based on number, union, length and certain other characters of stamens. Hence, this system is also known as **sexual system of classification**. In those days, it was an important over other systems of classification. The importance of floral characters was felt by Linnaeus

and his classification was more important than others. The main defect of this system is that totally unrelated plants are brought together in a single group and those that are closely related plants are placed in widely separated groups. For example, plants belonging to Zingiberaceae of Monocotyledons and that of Anacardiaceae of Dicotyledons had been placed in one group called **Monandria**, as these possess only one stamen. Another defect of this system was that no importance was given to either natural or phylogenetic relationships among different groups of plants.



*Fig. 1.1. Carolus Linnaeus*

#### ***Natural system***

In this system of classification, plants are classified based on their natural affinities. More number of characters are taken into consideration in this system. It is mainly based on all the informations that were available during the time of direct observation of plants. The most important natural system of classification of seed plants was proposed by two British botanists **George Bentham** and **Sir Joseph Dalton Hooker**. It helps to determine the relationships between various groups of plants. However, it does not attempt to bring out evolutionary relationships among different groups of plants.

#### ***Phylogenetic system***

This system is based on evolutionary sequence as well as genetic relationships among different groups of plants. In addition to this, it employs as many taxonomic characters as possible. **Charles Darwin's** concept of *Origin of Species* had given enough stimulus for the creation of phylogenetic system of classification. **Adolf Engler (1844-1930)** and **Karl Prantl (1849-1893)** of Germany published a phylogenetic system in their monograph on "*Die Naturlichen Pflanzen Familien*". In this system, floral characters such as single whorl of perianth or no perianth and unisexual flowers pollinated by wind were considered as primitive characters when



compared to perianth with two whorls, bisexual flowers pollinated by insects. According to them, members of Asteraceae of dicotyledons and Orchidaceae of monocotyledons were highly advanced.

### **1.1.1. Biosystematics**

Taxonomy is mainly concerned with the observation of similarities and differences that exist in the morphology of a vast number of plants. But it has now been accepted that in general, morphological characters alone are not the criteria for distinguishing and classifying plants from one another. One has to take into consideration, the characteristics and differences from other disciplines of science such as cytology, genetics, physiology, ecology, phytogeography, phytochemistry, numerical taxonomy, molecular biology, breeding systems and any other available sources for classification.

Biosystematics may be defined as '**taxonomy of living populations**'. In the present day classification of plants, species is taken as basic unit and it is the local breeding population. Numerous disciplines of science thus provide innumerable number of data of all the characters of the individual or a species. This helps to clear problems concerning those plants that differ in their interrelationship, classification and evolution. It provides sufficient genetic variations that warrants separation so as to recognise them as a separate **taxon** based on their evolutionary progress.

Variations in a species may be due to several factors such as genetic, ecological, physiological, population dynamic study and many other factors. All the evidences provided by the biosystematist are taken for analysis and considered by the classical taxonomist in order to arrive at any controversial problems that may arise during their phylogenetic classification based on their evolution of species under study.

#### ***Aims of biosystematics***

**Camp and Gily** 1943, coined the term 'biosystematics'. The aims of biosystematics are as follows.

- i) To delimit the naturally occurring biotic community of plant species.
- ii) To recognise the various groups as separate biosystematic categories such as ecotypes, ecospecies, cenospecies and comparium.

### ***Methods in the study of biosystematics***

Three important methods are as follows.

i) It involves thorough sampling analysis of the taxonomic species under study. Its population, cultivation, geographical range, cytology, anatomy, palynology, phytochemistry, chromosomal number and behaviour are keenly observed and studied for finding any genetic differences that may arise among different populations.

ii) It includes determination of ability of different populations to interbreed among one another to form a variant species with its vigor and fertility. This will reveal the presence or absence of breeding barriers between taxa at various levels.

iii) It involves the study of similarity of chromosomes in the hybrids during meiosis.

**Ecotype** is the basic unit in biosystematics, adapted to a particular environment but capable of producing fertile hybrids with other ecotypes. Ecotype is regarded as equivalent to subspecies of classical taxonomy.

**Ecospecies** is a group of plants comprising one or more ecotypes within the cenospecies, whose members are able to interchange their genes. Ecospecies is regarded as equivalent to species of classical taxonomy.

**Cenospecies** is a group of plants representing one or more ecospecies of common evolutionary origin. It is regarded as equivalent to subgenus of classical taxonomy. Cenospecies of the same comparium are separated by genetic barriers and all hybrids between them are sterile.

**Comparium** is composed of one or more cenospecies that are not able to intercross. Complete genetic barriers exist between different comparia.

The informations obtained from the above mentioned studies were compared with the data obtained through comparative morphology and geographical distributions resulted in the recognition and identification of

a total variety or species. To conclude, biosystematic study in the contemporary and modern taxonomy plays a vital role in separating and solving some of the problems that may develop in the identification of plants at the level of species. Biosystematist provides all the necessary data in solving the real position of species that was in controversy.

### ***1.1.2. Binomial nomenclature***

The system of naming the plants on a scientific basis is known as **botanical nomenclature**. Naming of the plants is useful in assigning their identity and relationship. Before the middle of the eighteenth century, the names of plants were commonly polynomials i.e. they were composed of several words in series constituting more or less the description of the plant. This can be illustrated with the example of *Caryophyllum*. The name given was *Caryophyllum saxatilis folis gramineus umbellatis corymbis* meaning *Caryophyllum* growing on rocks, having grass like leaves with umbellate corymbose inflorescence.

Since lengthy names are difficult to remember and use, attempts were made to shorten these names. **Carolus Linnaeus** suggested a system of binomial nomenclature. Although the binomial system was introduced by **Gaspard Bauhin** as early as 1623, it had properly been made use by Linnaeus in his book *Species Plantarum*.

In binomial nomenclature, every species is given a name of two words. For example, the binomial nomenclature of mango tree is *Mangifera indica*. Here the first word *Mangifera* refers to the genus and the second word *indica* to the species. The two words in combination comprise the name of the plant. Thus the binomial is a binary name. Hence, from the days of Linnaeus, two different kinds of plants could not have the same generic and specific names.

### ***International Code of Botanical Nomenclature (ICBN)***

In 1930, the fifth International Botanical Congress was held at Cambridge, England to frame rules and regulations for naming plants. The twelfth meeting was held at Leningrad, USSR in July 1975. Based on the resolutions of this meeting, the current system of International Code of Botanical Nomenclature was adapted from 1978.

### *Some of the salient features of ICBN*

1. The generic name is a singular noun. The first letter of generic name is always written in capital. The specific epithet is an adjective and is always written with small letter. It is derived from many sources and may consist of one or two words. eg. *Oryza sativa* and *Oldenlandia albonervia*.

2. The name should be short, precise and easy to pronounce.

3. The binomials are printed in *italics* or underlined. The generic and specific epithets are underlined separately. eg. *Abutilon neilgherrense* or Abutilon neilgherrense

4. When new names are given to any plant, then the herbarium preparation of the same specimen with its original description is preserved in any recognized herbarium. This specimen is denoted as **type specimen**. It is to be preserved on herbarium sheet.

5. The person who publishes the description of any plant for the first time or giving a new name to a plant is considered as author. The name of plant should bear the author's abbreviated name at the end of specific epithet. This is called **author citation**. Abbreviations were made for eminent taxonomists. The name Linnaeus was abbreviated to L. or Linn., **Robert Brown** to R.Br. and **Sir Joseph Dalton Hooker** to Hook. eg. *Malva sylvestris* Linn.

6. The original description of the plant should accompany the latin translation.

7. If naming the plant is from a source of error, it is regarded as **ambiguous name**. It is also called *nomen ambiguum* and is completely ignored from use.

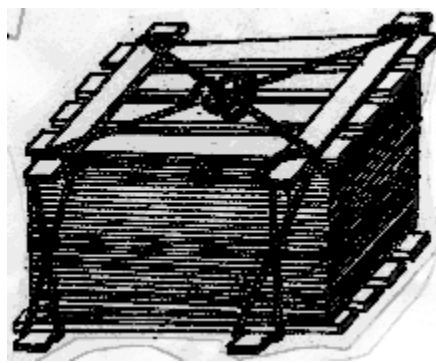
8. If the generic and specific epithets are the same, it is called **tautonym**. eg. *Sassafras sassafras*. Such names are not accepted in the system of nomenclature.

#### **1.1.3. Herbaria and their uses**

**Herbarium** is a collection of pressed, dried plant specimens mounted on specified sheets, identified and arranged in the order of an approved and

well known system of classification. It also refers to the institution where dried plant specimens are maintained and studied. eg. Herbarium of Botanical Survey of India, Coimbatore.

A twig with leaves, inflorescence or flowers is collected from shrubs and trees. In the case of herbs, the collected plant specimens should contain both vegetative and reproductive parts. They are dried by keeping them between the folds of old newspapers. It is necessary to change these papers at regular intervals, until the plants are well dried. The plant specimens along with their parts are dried in a plant press (fig.1.2). It consists of two boards with straps, which help in tightening the newspapers with specimens between the boards.



*Fig. 1.2. Plant press*

The dried specimens are pasted on the herbarium sheets of standard size 41 cm X 29 cm. The process of attaching dried and pressed plant specimens on herbarium sheets is known as **mounting of specimens**. All the mounted specimens are sprayed with fungicide like 0.1% solution of Mercuric chloride. To protect these dried specimens from the attack of the insects, pesticides such as naphthalene and carbon disulphide can be used. The heavy parts of plants such as seeds and

fruits are kept in packets and attached to the sheets.

When a new name for a species is suggested, it is the rule that plant specimens of the same should necessarily be deposited in a recognized herbarium. These specimens are called **type specimens**. The name of the family is always based on type genus. These specimens are most valuable part of herbarium and they are handled with special care. They are stored in fire-proof cabinets.

If the herbarium specimens are handled with special care, they will be in good condition for a long time. Precautions should be taken against attacks of fungi and insects. It is always better to use chemicals, which

can repel the insects from herbarium specimens. The herbarium is always accompanied with a label. It carries the information about the botanical name of the plant, name of the family, habit, place and date of collection and name of the person who collected the specimens.

***Some Important National and International Herbaria***

| S.No. | Name of herbarium   | Total No. of specimens |
|-------|---|------------------------|
| 1.    | Herbarium of Royal Botanical Gardens, Kew, London, England. | More than 60,00,000    |
| 2.    | Herbarium of Indian Botanical Garden, Kolkata, India.       | More than 10,00,000    |
| 3.    | Botanical Survey of India, Coimbatore, Tamil Nadu.          | More than 1,90,000     |
| 4.    | Presidency College Herbarium, Chennai, Tamil Nadu.          | More than 10,000       |
| 5.    | Rapinat Herbarium, Trichy, Tamil Nadu.                      | More than 12,000       |

***Importance of herbarium***

- Herbarium is a source of knowledge about the flora of a region or a locality or a country.
- It is a data store in which the information on plants are available.
- The type specimens help in the correct identification of plants.
- It provides materials for taxonomic and anatomical studies.
- Typical pollen characters have been well emphasized in taxonomy. Morphological characters of the pollen remain unaltered even after storage upto nearly 200 years.
- It is very much useful in the study of cytology, structure of DNA, numerical taxonomy, chaemotaxonomy, etc. It acts as a reservoir of gene pool studies.

Because of its importance, several herbaria have been established at the national and international centres.

## Self Evaluation

### ***I. Choose and write the correct options.***

1. Artificial system of classification of plants was proposed by a  
a. British botanist                      b. Swedish botanist  
c. German botanist                      d. Indian botanist
2. Which of the following classification is a sexual system of classification?  
a. Artificial system                      b. Natural system  
c. Phylogenetic system                d. Natural selection
3. The botanist who introduced binomial system is  
a. Carolus Linnaeus                      b. Gaspard Bauhin  
c. Sir Joseph Dalton Hooker        d. Adolf Engler

### ***II. Answer the following questions in two or three sentences.***

4. What are the defects of artificial system of classification of plants?
5. Define biosystematics.
6. What is Binomial nomenclature?
7. Write the objectives of classification of plants.
8. What are the aims of biosystematics.
9. How is *ICBN* evolved?
10. What is called *nomen ambiguum*?
11. Define tautonym. Give an example.
12. Define Herbarium.
13. Write precautions to be taken in preserving specimens in herbarium.
14. What is called author citation? Give an example.
15. What is a type specimen?

### ***III. Answer the following questions in about 100 words***

16. Write any five salient features of *ICBN*.
17. Bring out the significance of herbarium.
18. Define biosystematics. Briefly write a note on it.
19. What are the types of classification of plants? Add note on each type.

## **1.2. Bentham and Hooker's classification of plants**

It is a natural system of classification and is based on important characters of the plants. Even today this system is being followed in India, United Kingdom and several other Commonwealth countries. It is also used in a number of herbaria and botanical gardens all over the world. It is a well known and widely accepted classification of seeded plants. It was proposed by two English botanists **George Bentham (1800-1884)** and **Sir Joseph Dalton Hooker (1817-1911)**. Their system of classification was published in '*Genera Plantarum*' in three volumes and they had described 97,205 species of seeded plants in 202 orders (now referred to as families). In Bentham and Hooker's classification of plants, the present day 'orders' were referred to as 'cohorts' and 'families' as 'orders'.

The outline of Bentham and Hooker's classification of plants is given in page 12. The seeded plants are divided into three classes – Dicotyledonae, Gymnospermae and Monocotyledonae.

### **Class I Dicotyledonae**

Seeds of dicotyledonous plants contain two cotyledons. Leaves show reticulate venation. Flowers are tetramerous or pentamerous having four or five members in various floral whorls respectively. It includes three sub-classes – Polypetalae, Gamopetalae and Monochlamydeae.

#### **Sub-class I Polypetalae**

Plants having flowers with free petals come under polypetalae. The flowers are with distinct calyx and corolla. It is further divided into three series – Thalamiflorae, Disciflorae and Calyciflorae.

##### **Series (i) Thalamiflorae**

It includes plants having flowers with dome or conical thalamus. Ovary is superior. Thalamiflorae includes 6 orders and 34 families. The family Malvaceae is placed in the order Malvales.

##### **Series (ii) Disciflorae**

It includes flowers having prominent disc shaped thalamus below the ovary. Ovary is superior. Disciflorae is divided into 4 orders and 23 families.



### **Series (iii) Calyciflorae**

It includes plants having flowers with cup shaped thalamus. Ovary is superior or inferior sometimes half inferior. Calyciflorae includes 5 orders and 27 families. The family Fabaceae is placed in the order Rosales.

### **Sub-class 2. Gamopetalae**

Plants having flowers with petals, which are either partially or completely fused to one another are placed under Gamopetalae. The sepals and petals are distinct. Gamopetalae is further divided into three series – Inferae, Heteromerae and Bicarpellatae.

#### **Series (i) Inferae**

The flowers are epigynous and ovary is inferior. Inferae includes 3 orders and 9 families. The family Rubiaceae is placed in the order Rubiales and Astraceae in Astrales.

#### **Series (ii) Heteromerae**

The flowers are hypogynous and ovary is superior with more than two carpels. Heteromerae includes 3 orders and 12 families.

#### **Series (iii) Bicarpellatae**

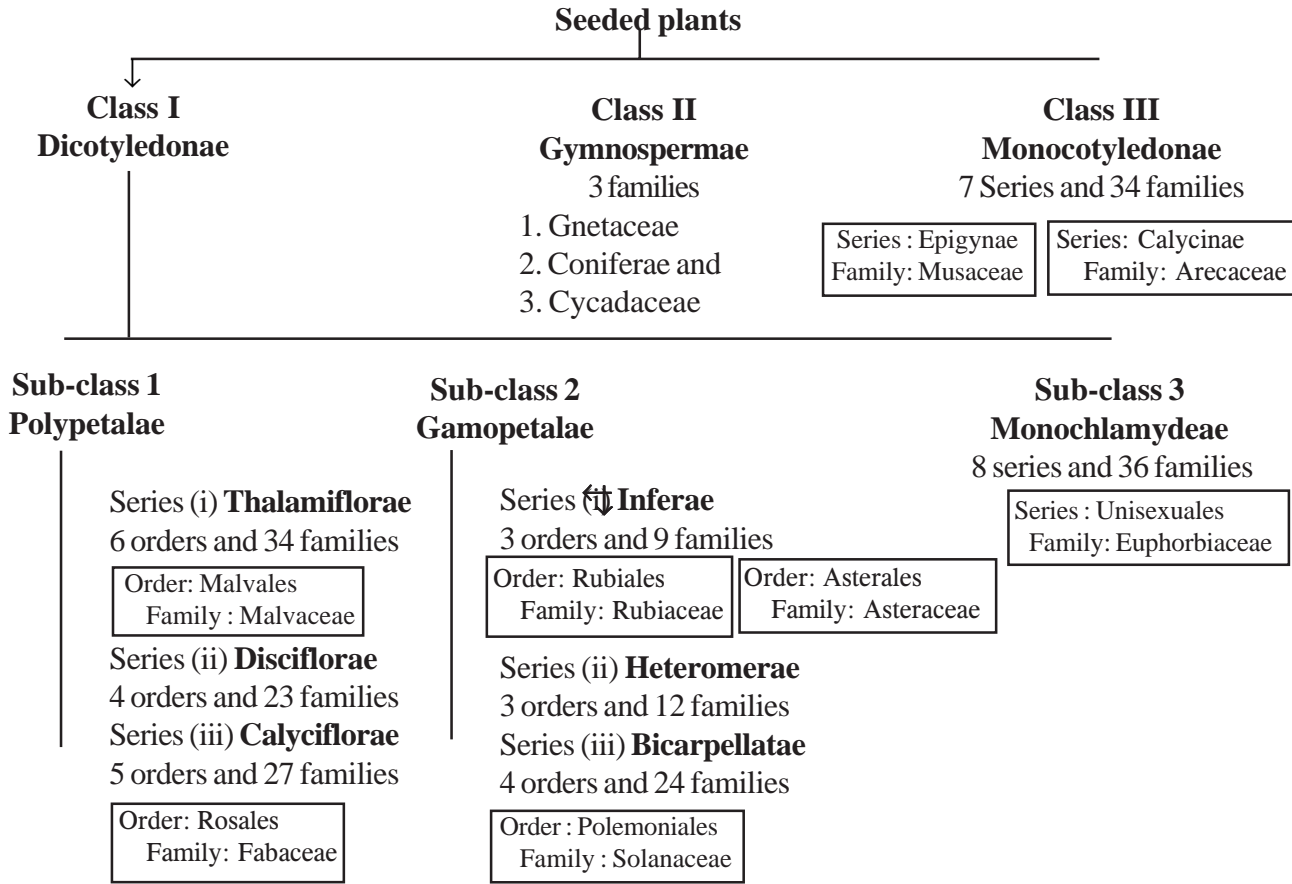
The flowers are hypogynous and ovary is superior with two carpels only. Bicarpellatae includes 4 orders and 24 families. The family Solanaceae is placed in the order Polemoniales.

### **Sub-class 3. Monochlamydeae**

Plants having flowers with single whorl of perianth are placed under Monochlamydeae. Flowers are incomplete. The sepals and petals are not distinguished and they are called perianth. Tepals are present in two whorls. Sometimes both the whorls are absent. Monochlamydeae includes 8 series and 36 families. The family Euphorbiaceae is placed in the series Unisexuales.

### **Class II Gymnospermae**

The members of this class have naked ovules or seeds. Ovary is absent and gymnospermae includes three families – Gnetaceae, Coniferae and Cycadaceae.



*Outline of Bentham and Hooker's classification of plants*

### Class III Monocotyledonae

Seeds of monocotyledonous plants contain only one cotyledon. Leaves show parallel venation. Flowers are trimerous having three members in various floral whorls. The plants have fibrous root system. The Monocotyledonae has 7 series and 34 families. The family Musaceae is placed in the series Epigynae and Arecaceae in Calycinae.

#### *Merits of Bentham and Hooker's classification of plants*

1. Bentham and Hooker's classification is the most natural system, based on actual examination of specimens.
2. The description of plants is quite accurate and reliable.
3. As it is easy to follow, it is used as a key for the identification of plants in Kew herbarium and several other herbaria of the world.
4. Although this system is natural, most of the aspects of this system show affinity to modern concepts of evolution. For example, the

#### *Distribution of taxa in Bentham and Hooker's classification of plants*

| S.No. | Classes and sub-classes | No. of families |
|-------|-------------------------|-----------------|
| 1.    | Dicotyledonae           |                 |
|       | i. Polypetalae          | 84              |
|       | ii. Gamopetalae         | 45              |
|       | iii. Monochlamydeae     | 36              |
| 2.    | Gymnospermae            | 3               |
| 3.    | Monocotyledonae         | 34              |
|       | Total                   | 202             |

order Ranales, which is the first order in the arrangement of plants, has been given a primitive position in this system. Recent taxonomic findings also indicate that the members of Ranales are the most primitive living angiosperms.

5. The placement of monocotyledonae after the dicotyledonae also

appears to be in accordance with the evolutionary trends.

### ***Demerits of Bentham and Hooker's classification of plants***

1. The placement of Gymnospermae in between dicotyledonae and monocotyledonae is an error.
2. Several important floral characters have been neglected in this system.
3. Advanced family Orchidaceae has been considered as primitive among monocotyledons and it is placed in the beginning of the system.
4. In this system, some closely related families have been separated and placed under different groups. For example, all the families of series Curvembryeae of Monochlamydeae are related to Caryophyllaceae of series Thalamiflorae of Polypetalae, but they are separated.
5. Unrelated families have been grouped nearer. For example, Podostemaceae of series *Multiovulatae aquaticae* of *Monochlamydeae* deserves a place in Rosales of the series Calyciflorae of Polypetalae. Similarly Laurineae of series Daphnales of Monochlamydeae deserves a place in Ranales of the series Thalamiflorae of polypetalae. Thus, two unrelated families Podostemaceae and Laurineae are grouped nearer.

### **Self Evaluation**

#### ***I. Choose and write the correct options.***

1. *Genera plantarum* of Bentham and Hooker was published in
  - a. a single volume
  - b. two volumes
  - c. three volumes
  - d. four volumes
2. In Bentham and Hooker classification of plants, the present day 'orders' were referred to by them as
  - a. series
  - b. cohorts
  - c. orders
  - d. families
3. Plants having flowers with free petals are placed under
  - a. Monochlamydeae
  - b. Monocotyledons
  - c. Gamopetalae
  - d. Polypetalae
4. Infraclass includes
  - a. 6 orders and 34 families
  - b. 4 orders and 23 families
  - c. 3 orders and 9 families
  - d. 5 orders and 27 families

5. How many families were described by Bentham and Hooker in their classification?
  - a. 204
  - b. 212
  - c. 202
  - d. 102
6. In Bentham and Hooker's classification of plants, the present by "families" were referred to by them as
  - a. families
  - b. cohorts
  - c. orders
  - d. series
7. Thalamiflorae includes
  - a. 4 orders and 23 families
  - b. 6 orders and 34 families
  - c. 5 orders and 27 families
  - d. 3 orders and 12 families
8. Which one of the following series includes the epigynous flowers?
  - a. Thalamiflorae
  - b. Disciflorae
  - c. Inferae
  - d. Heteromerae
9. The family included under the series Unisexuales is
  - a. Solanaceae
  - b. Euphorbiaceae
  - c. Malvaceae
  - d. Musaceae

**II. Answer the following questions in two or three sentences.**

10. Write the countries which still follow the Bentham and Hooker's classification of plants.
11. What are the three classes of phanerogams?
12. Write the families of gymnospermae as in Bentham and Hooker's classification of plants.
13. What is polypetalae?
14. Write short notes on monochlamydeae.
15. Briefly mention the systematic position of Laurineae.

**III. Answer the following questions in about 100 words.**

16. Bring out the merits of Bentham and Hooker's classification of plants.

**IV. Answer the following questions in about 200 words.**

17. Discuss the outline of Bentham and Hooker's classification of plants.

## DICOT FAMILIES

### 1.3.1 MALVACEAE - the cotton family

#### Systematic position

Class: Dicotyledonae

Sub-class: Polypetalae

Series: Thalamiflorae

Order: Malvales

Family: Malvaceae

#### General characters

#### Distribution

This family includes about 82 genera and more than 1,500 species. The plants are cosmopolitan in distribution, more abundant in tropical and subtropical regions. In India, Malvaceae is represented by 22 genera and 125 species.

#### Habit

Plants may be annual herbs (eg. *Malva sylvestris*) or perennial shrubs (eg. *Hibiscus rosa-sinensis*) or trees (eg. *Thespesia populnea*). The members of this family have mucilagenous substance. Stellate hairs occur on their young parts.

#### Root

Tap root system.

#### Stem

Aerial, erect (eg. *Malva sylvestris*), branched, woody (eg. *Thespesia populnea*), decumbent as in *Malva rotundifolia* (Thirikalamalli) and usually covered with stellate hairs.

#### Leaf

Petiolate, simple, entire (eg. *Thespesia populnea*) or palmately lobed (eg. *Gossypium arboreum*), alternate, stipulate, margins usually toothed (eg. *Hibiscus rosa-sinensis*) and showing reticulate venation.

#### Inflorescence

Solitary, terminal (eg. *Malvastrum coromendelia*) or solitary, axillary (eg. *Thespesia populnea*) or terminal or axillary cyme. eg. *Pavonia odorata* (Peramutti).

## **Flower**

Bracteate or ebracteate, bracteolate or ebracteolate, pedicellate, dichlamydeous, pentamerous, complete, actinomorphic, regular, bisexual and hypogynous.

## **Epicalyx**

Bracteoles forming a whorl outer to calyx is called epicalyx. Bracteoles 3 in *Malva sylvestris*, 5 to 8 in *Hibiscus rosa-sinensis*, 10 to 12 in *Pavonia odorata* and absent in *Abutilon indicum*.

## **Calyx**

Sepals 5, green, gamosepalous showing valvate aestivation.

## **Corolla**

Petals 5, coloured, polypetalous but slightly fused at the base due to adhesion with staminal tube, regular and showing twisted aestivation.

## **Androecium**

Numerous stamens, filaments are fused to form a staminal tube around the style and monadelphous. The staminal tube is fused with the petals at their bases. Anthers are monothealous, reniform, transversely attached to filaments and transversely dehiscent.

## **Gynoecium**

Ovary superior, two to many carpels but usually 5 to 10 carpels and syncarpous. Ovary with two to many locules. Pentacarpellary in *Hibiscus rosa-sinensis*, 10 in *Althaea* and 15 to 20 in *Abutilon indicum*. Number of locules usually corresponds to number of carpels. Each locule contains one to many ovules on axile placentation. Style long, slender and passes through the staminal tube ending in two to many distinct round stigmas.

## **Fruit**

Loculicidal capsule e.g. *Abelmoschus esculentus* or schizocarp as in *Abutilon indicum* and *Sida cordifolia* (Nilathuthi).

## **Seed**

Endosperm is scanty, covered with hairs as in *Gossypium barbadense*.

## **Botanical description of *Hibiscus rosa-sinensis***

### **Habit**

Perennial shrub.

### **Root**

Tap root system.

### **Stem**

Aerial, erect, cylindrical, woody and branched.

### **Leaf**

Simple, Alternate, petiolate, stipulate, serrate, glabrous, apex acuminate with multicostate reticulate venation.

### **Inflorescence**

Solitary cyme and axillary.

### **Flower**

Pediceled, jointed, bracteate, bracteolate, bisexual, large, showy, pentamerous, dichlamydeous, actinomorphic, complete and hypogynous and mucilage is present in floral parts.

### **Epicalyx**

5 to 8 bracteoles outer to the calyx. They are green and free.

### **Calyx**

Sepals 5, green, gamosepalous showing valvate aestivation and odd sepal is posterior in position.

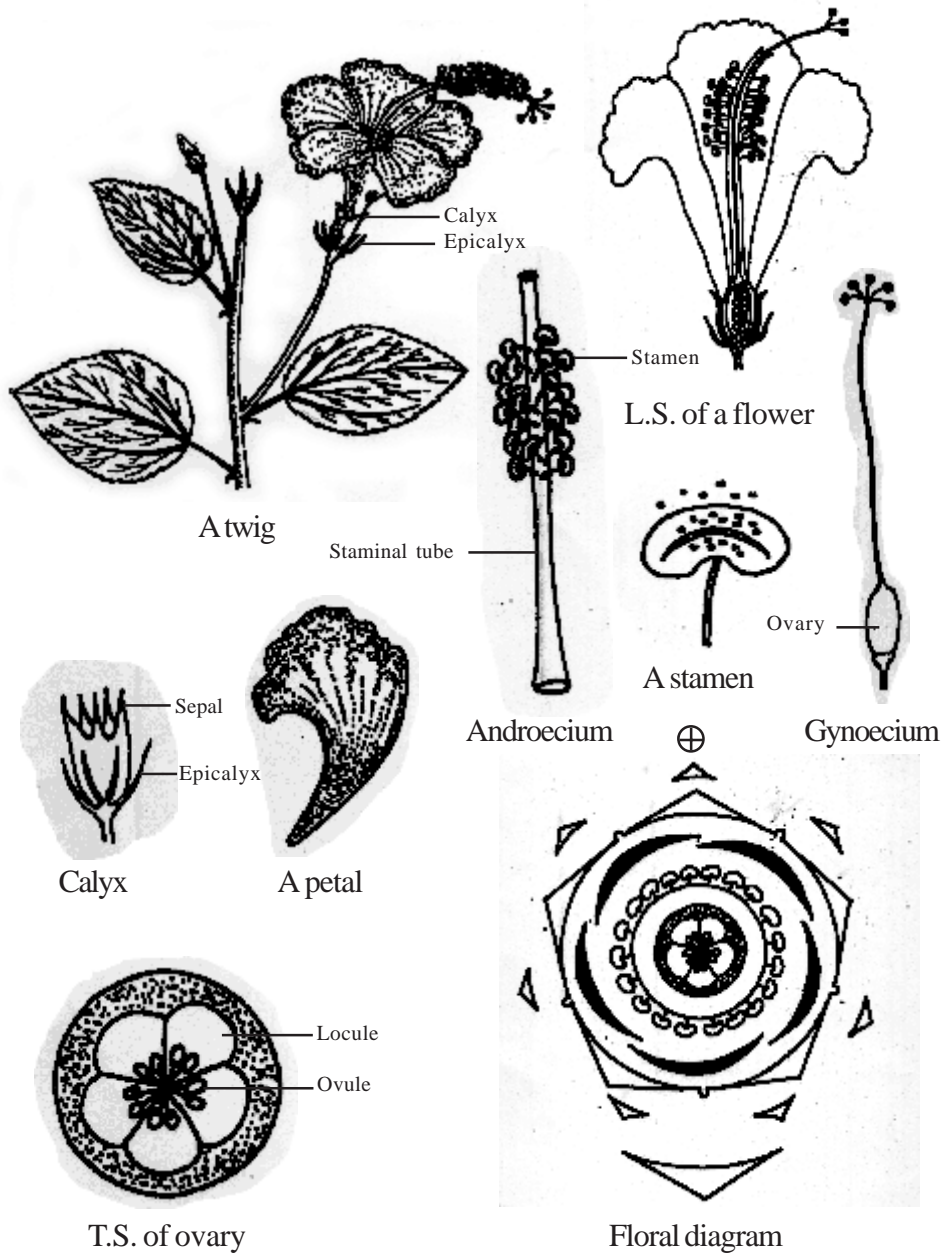
### **Corolla**

Petals 5, variously coloured, polypetalous but fused at the base and showing twisted aestivation.

### **Androecium**

Numerous stamens, monadelphous, filaments are fused to form a staminal tube around the style. Staminal tube is red. Anthers are monothealous, reniform, yellow, transversely attached to the filament, dehisce transversely and extrorse.





Floral formula:  $Br., Brl., \oplus, \square, K_{(5)}, C_5, A_{(\infty)}, \underline{G}_{(5)}$

**Fig. 1.3. Hibiscus rosa-sinensis**

## Gynoecium

Ovary superior, pentacarpellary and syncarpous. Ovary pentalocular with many ovules per locule on axile placentation. Style simple, long, slender and passes through the staminal tube. Stigma 5, capitate and coloured.

## Fruit

Mostly abortive.

## Floral Formula

Br., Brl., ⊕, ☐, ♀, K<sub>(5)</sub>, C<sub>5</sub>, A<sub>(∞)</sub>, G<sub>(5)</sub>

## ECONOMIC IMPORTANCE

### 1. Fibre plants

*Gossypium barbadense* (Egyptian cotton), *G. hirsutum* (American cotton), *G. herbaceum* (Cotton) and several other species of *Gossypium* yield cotton fibres of commercial value. The fibres are obtained from the surface of seeds.

*Hibiscus cannabinus* (Deccan hemp) yields **bast fibres** which are used for making ropes.

### 2. Food plants

The tender fruit of *Abelmoschus esculentus* (lady's finger) is used as vegetable. The leaves and sepals of *Hibiscus sabdariffa* (A kind of 'pulichai') are used for making pickles, jam and jelly. A delicious 'chutney' is prepared from the leaves and sepals of *H. cannabinus* (Pulichai keerai) and *H. sabdariffa*.

### 3. Timber Plants

Timber obtained from *Thespesia populnea* (portia tree) is useful for making boat, furniture and agricultural implements.

### 4. Medicinal plants

Root and leaves of *Abutilon indicum* (Thuthi) and *Malva sylvestris* are used against fever. Roots of *Malva sylvestris* and *Althaea rosea* are used for treating whooping cough and dysentery respectively.

### 5. Ornamental plants

*Althaea rosea* (Hollyhock), *Hibiscus rosa-sinensis* (Shoe flower) *H. schizopetalus* (A kind of shoe flower with dissected petals) are grown in gardens.

## Self evaluation

### I. Choose and write the correct options.

1. *Thespesia populnea* belongs to
  - a. Solanaceae
  - b. Euphorbiaceae
  - c. Malvaceae
  - d. Musaceae
2. Malvaceae is placed in the series
  - a. Thalamiflorae
  - b. Inferae
  - c. Heteromerae
  - d. Disciflorae
3. Anthers are monothealous in
  - a. Solanaceae
  - b. Euphorbiaceae
  - c. Malvaceae
  - d. Musaceae
4. In *Abelmoschus esculentus*, the fruit is
  - a. drupe
  - b. schizocarp
  - c. regma
  - d. loculicidal capsule
5. Binomial of lady's finger is
  - a. *Hibiscus cannabinus*
  - b. *Thespesia populnea*
  - c. *Gossypium barbadense*
  - d. *Abelmoschus esculentus*

### II. Answer the following questions in two or three sentences.

6. Mention the systematic position of Malvaceae.
7. Write a note on androecium of *Hibiscus rosa-sinensis*.
8. Describe the gynoecium of *Hibiscus rosa-sinensis*.
9. Name any three fibre plants of Malvaceae.
10. Mention the binomial of any three medicinal plants of Malvaceae.
11. Write any three binomials of food plants of Malvaceae.
12. Draw the floral diagram and write the floral formula of *Hibiscus rosa-sinensis*.
13. What is epicalyx? It is present in *Abutilon indicum*?

### III. Answer the following questions in 100 words.

14. Give a detailed account on economic importance of Malvaceae.

### IV. Answer the following question in about 200 words.

15. Describe *Hibiscus rosa-sinensis* in botanical terms.
16. List out characteristic features of members of Malvaceae.

### 1.3.2. FABACEAE – the bean family

#### Systematic position

Class: Dicotyledonae  
Sub-class: Polypetalae  
Series: Calyciflorae  
Order: Rosales  
Family: Fabaceae

#### General characters

#### Distribution

Fabaceae includes about 482 genera and more than 7,200 species. The members are cosmopolitan in distribution but abundant in tropical and subtropical regions. In India, this family is represented by about 100 genera and 754 species.

#### Habit

The members of this family exhibit different habits. Prostrate herb eg. *Indigofera enneaphylla* (Seppu nerunji), erect herb (eg. *Crotalaria verrucosa*), twiner eg. *Clitoria ternatea* (Sangupoo), tendril climber eg. *Pisum sativum* (Pea plant), shrub eg. *Cajanus cajan* and trees eg. *Pongamia glabra*. *Aeschynomene aspera* (Pith plant) is a hydrophyte and commonly called pith plant.

#### Root

Branched tap root system having nodules. Nitrogen fixing bacterium *Rhizobium leguminosarum* occurs in the nodules.

#### Stem

Aerial, weak stem (eg. *Clitoria ternatea*) or woody (eg. *Dalbergia latifolia*).

#### Leaf

Simple (eg. *Crotalaria juncea*) or bifoliate (eg. *Zornia diphylla*) or trifoliate (eg. *Lablab purpureus*) or imparipinnately compound (eg. *Clitoria ternatea*), terminal leaflets modified into tendrils in *Pisum sativum*. Leaves are alternate, stipulate, leaflets stipellate, pulvinate showing reticulate venation.

### **Inflorescence**

Usually a raceme eg. *Crotalaria verrucosa* (Kilukiluppai) or a panicle (eg. *Dalbergia latifolia*) or axillary solitary (eg. *Clitoria ternatea*).

### **Flower**

Bracteate, pedicellate, bracteolate, complete, bisexual, pentamerous, dichlamydeous, zygomorphic and hypogynous.

### **Calyx**

Sepals 5, green, gamosepalous showing valvate aestivation. Odd sepal is anterior in position.

### **Corolla**

Petals 5, coloured, polypetalous showing descendingly imbricate or **vexillary aestivation**. The outer most petal is large called standard petal or **vexillum**. Two lateral petals are lanceolate and curved. They are called wing petals or **alae**. Two anterior and partly fused innermost petals are called keel petals or **carina**. The stamens and pistil are enclosed by these keel petals. All the petals have a claw at their bases. This type of irregular corolla is described as **papilionaceous corolla**.

### **Androecium**

Stamens 10, usually diadelphous. Nine stamens are fused to form a bundle and the tenth stamen is free (9) + 1 (eg. *Clitoria ternatea*). The odd stamen is posterior in position. In *Aeschynomene aspera*, the stamens are fused to form two bundles each containing five stamens (5) + (5). In *Crotalaria verrucosa* the stamens are monadelphous and dimorphic i.e. 5 stamens have longer filaments and other 5 stamens have shorter filaments. Thus the stamens are found at two different levels and the shape of anthers also varies. 5 anthers are long and lanceolate. The other 5 anthers are short and blunt. Anthers are ditheous, basifixed and dehiscent longitudinally.

### **Gynoecium**

Ovary superior, monocarpellary, stipitate i.e. ovary has a short stalk at the base. Ovary unilocular with one to many ovules showing marginal placentation. Style simple and bent. Stigma flattened or feathery.

**Fruit**

Typically a legume. In *Arachis hypogea*, the fruits develop underground. After fertilization, the stipe of the ovary becomes meristematic and grows down into the soil. Thus the ovary gets buried into the soil and develops into fruit.

**Seed**

Non-endospermous and kidney shaped.

**Botanical description of *Clitoria ternatea*****Habit**

Twining climber.

**Root**

Branched tap root system having nodules.

**Stem**

Aerial, weak stem and a twiner.

**Leaf**

Imparipinnately compound, alternate, stipulate showing reticulate venation. Leaflets are stipellate. Petiole and stipel are pulvinate.

**Inflorescence**

Axillary and solitary.

**Flower**

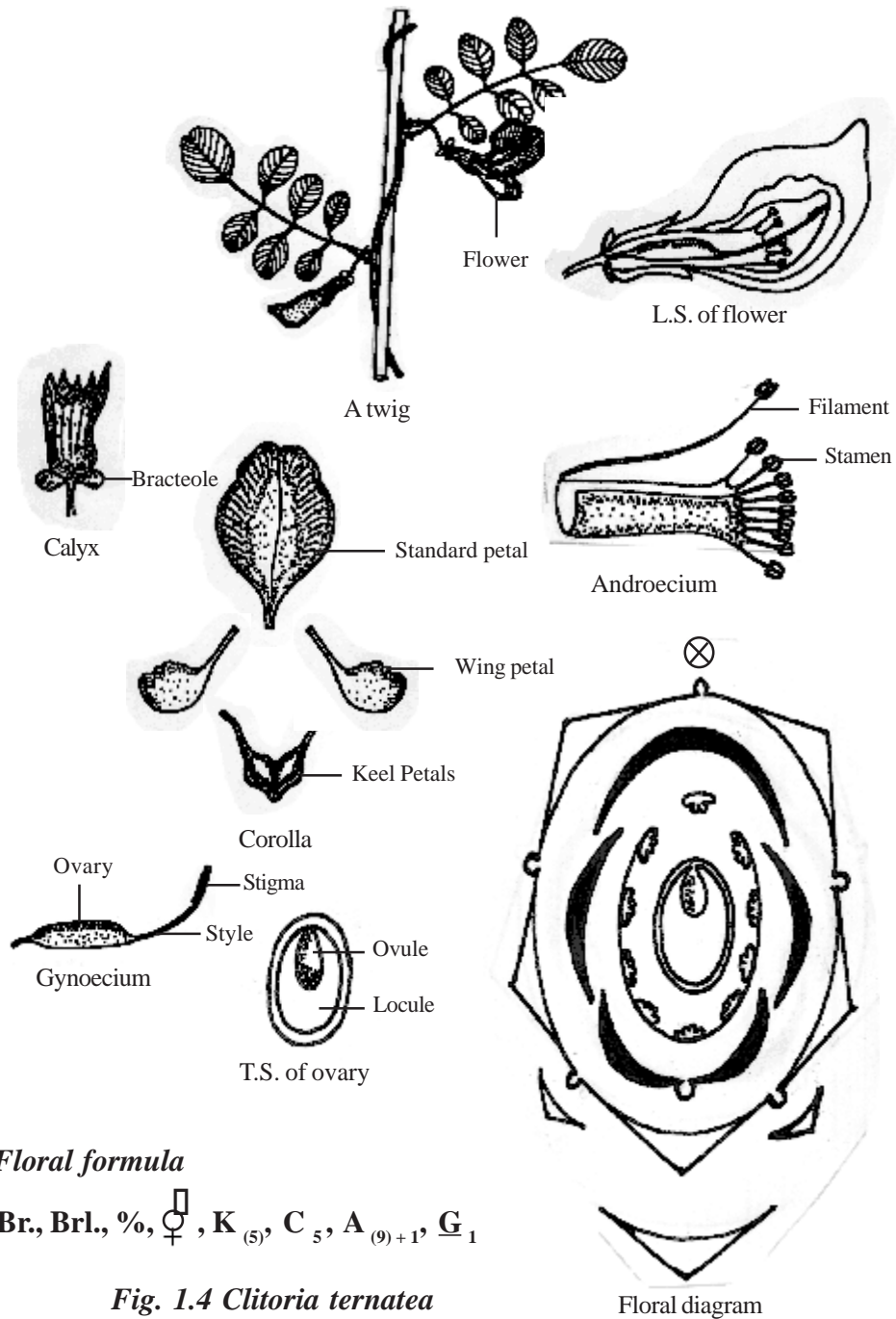
Bracteate, bracteolate, bracteoles usually large, pedicellate, dichlamydeous, complete, bisexual, pentamerous, zygomorphic and hypogynous.

**Calyx**

Sepals 5, green, gamosepalous showing valvate aestivation. Odd sepal is anterior in position.

**Corolla**

Petals 5, blue or white, polypetalous, irregular, papilionaceous corolla showing descendingly imbricate aestivation.



### **Androecium**

Stamens 10, diadelphous (9) + 1, nine stamens fused to form a bundle and the tenth stamen is free, posterior and opposite to the standard petal. Anthers are dithecal, basifixed, introrse and dehiscent by longitudinal slits.

### **Gynoecium**

Ovary superior, stipitate and monocarpellary. Ovary unilocular with many ovules on marginal placentation. Style simple and incurved with feathery stigma.

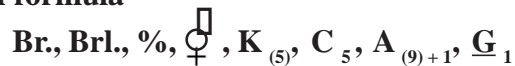
### **Fruit**

A legume.

### **Seed**

Non-endospermous and kidney shaped.

### **Floral formula**



### **Economic importance**

#### **1. Pulses**

The seeds of *Cajanus cajan* (red gram), *Vigna mungo* (black gram), *Vigna radiata* (green gram), *Vigna unguiculata* (horse gram) and *Cicer arietinum* (chick pea) are rich in proteins and used as pulses.

#### **2. Vegetables**

The tender fruits of *Lablab purpureus* (field bean) and leaves of *Sesbania grandiflora* (agathi) are used as vegetables and greens.

#### **3. Oil plants**

Oil extracted from the seeds of *Arachis hypogea* (ground nut) is used for cooking. Seeds are edible. Pongam oil obtained from the seeds of *Pongamia pinnata* (pongam) has medicinal value and is used in the preparation of soap.

#### **4. Timber plants**

Timber is obtained from *Dalbergia latifolia* (rose wood) and *Pterocarpus santalinus* (red sandal wood) is used for making furniture, cabinet articles and other building materials.



## 5. Fibre plants

Fibres obtained from *Crotalaria juncea* (sunhemp) and *Sesbania aegyptiaca* (sesban) are used for making ropes.

## 6. Dye plants

The important blue dye, indigo obtained from *Indigofera tinctoria* (Avuri) is used in the colouring of printing ink and paints. Blue dye is also obtained from the flowers and seeds of *Clitoria ternatea*.

## 7. Ornamental plants

*Butea frondosa* (flame of the forest), *Clitoria ternatea*, *Lathyrus odoratus* (sweet pea) and *Lupinus hirsutus* are grown as ornamental plants.

### Self evaluation

#### I. Choose and write the correct options.

1. *Pongamia glabra* is a
  - a. herb
  - b. shrub
  - c. tree
  - d. climber
2. *Aeschynomene aspera* is a
  - a. xerophyte
  - b. hydrophyte
  - c. mesophyte
  - d. lithophyte
3. The binomial of groundnut plant is
  - a. *Arachis hypogea*
  - b. *Pongamia glabra*
  - c. *Dalbergia latifolia*
  - d. *Vigna mungo*
4. The fruit of the members of Fabaceae is
  - a. berry
  - b. drupe
  - c. legume
  - d. caryopsis.
5. The type of placentation seen in the members of Fabaceae is
  - a. axile
  - b. basal
  - c. parietal
  - d. marginal

**II. Answer the following questions in two or three sentences.**

6. Write the systematic position of Fabaceae.
7. What is papilionaceous corolla?
8. What is vexillum?
9. Describe the gynoecium of *Clitoria ternatea*.
10. What is pulvinus?
11. Write any two binomials of dye plant of Fabaceae.

**III. Answer the following questions in about 100 words.**

12. Add a note on economic importance of Fabaceae.
13. Briefly explain different types of androecium of members of Fabaceae.

**IV. Answer the following questions in about 200 words.**

14. Describe *Clitoria ternatea* in botanical terms.
15. Describe the general characteristic features of Fabaceae.

### 1.3.3. RUBIACEAE – the coffee family

#### Systematic position

Class: Dicotyledonae

Sub-class: Gamopetalae

Series: Inferae

Order: Rubiales

Family: Rubiaceae

#### *General characters*

#### **Distribution**

Rubiaceae is one of the largest families consisting of nearly 500 genera and more than 6,500 species. They are widely distributed in the tropical and sub-tropical regions. In India, this family is represented by 76 genera and more than 274 species.

#### **Habit**

Mostly trees (eg. *Cinchona officinalis*, *Morinda tinctoria*) or shrubs (eg. *Mussaenda*) or herbs (eg. *Rubia*).

#### **Root**

A branched tap root system.

#### **Stem**

Aerial, erect, cylindrical, woody and branched but herbaceous in *Rubia*.

#### **Leaf**

Simple, opposite decussate (eg. *Ixora coccinea*) or whorled (eg. *Galium*), entire and stipulate. The stipules of opposite leaves are fused at the node between the petioles. They are called **interpetiolar stipules** (eg. *Ixora coccinea*). When the stipules of each leaf are fused at the angle between petiole and stem, they are called **intrapetiolar stipules**. (eg. *Gardenia*).

#### **Inflorescence**

Mostly terminal or axillary cymose (eg. *Gardenia*) or corymbose cyme (eg. *Ixora coccinea*) or cymes are aggregated into dense head as in *Anthocephalus indicus* (Kadamba tree).

**Flower**

Bracteate, bracteolate, pedicellate, dichlamydeous, complete, tetra or pentamerous, actinomorphic and epigynous.

**Calyx**

Sepals 4 or 5, gamosepalous rarely polysepalous, showing valvate aestivation. In *Mussaenda*, one of the sepals is brightly coloured. It is called **petaloid sepal**.

**Corolla**

Petals 4 or 5, gamopetalous, hypocrateriform or salver shaped i.e. a long narrow tube consisting of limbs – placed at right angles to the tube (eg. *Ixora coccinea*), showing valvate or twisted or imbricate aestivation.

**Androecium**

Stamens 4 or 5, alternate with petals, epipetalous and inserted at the mouth of corolla tube. Anthers are ditheous, basifixed, introrse and dehiscent longitudinally.

**Gynoecium**

Ovary inferior, bicarpellary and syncarpous. Ovary bilocular with one or numerous ovules in each locule showing axile placentation. Style simple, stigma bilobed or capitate. There are five carpels in *Gardenia*.

**Fruit**

A berry (*Ixora coccinea*) or a capsule (*Cinchona officinalis*) or a multiple fruit (*Morinda tinctoria*).

**Seed**

Endospermous.

**Botanical description of *Ixora coccinea*****Habit**

An evergreen shrub.

**Root**

Branched tap root system

**Stem**

Aerial, erect, branched, cylindrical and woody.

**Leaf**

Simple, opposite decussate, oblong, stipulate with interpetiolar stipules and uncostate reticulate venation.

**Inflorescence**

Terminal or axillary dense corymbose cyme.

**Flower**

Bracteate, bracteolate, dichlamydeous, bisexual, complete, tetramerous, actinomorphic and epigynous.

**Calyx**

Sepals 4, green, gamosepalous showing valvate aestivation, regular and persistent.

**Corolla**

Petals 4, bright red or yellow or white, gamopetalous, showing twisted aestivation, hypocrateriform, corolla tube long and slender.

**Androecium**

Stamens 4, epipetalous, attached at the throat of the corolla tube, filaments short, alternate the petals. Anthers are ditheous, basifixed, introrse and dehiscing longitudinally.

**Gynoecium**

Ovary inferior, bicarpellary and syncarpous. Ovary bilocular with one ovule in each locule showing axile placentation. Style simple and filiform. Stigma bifid.

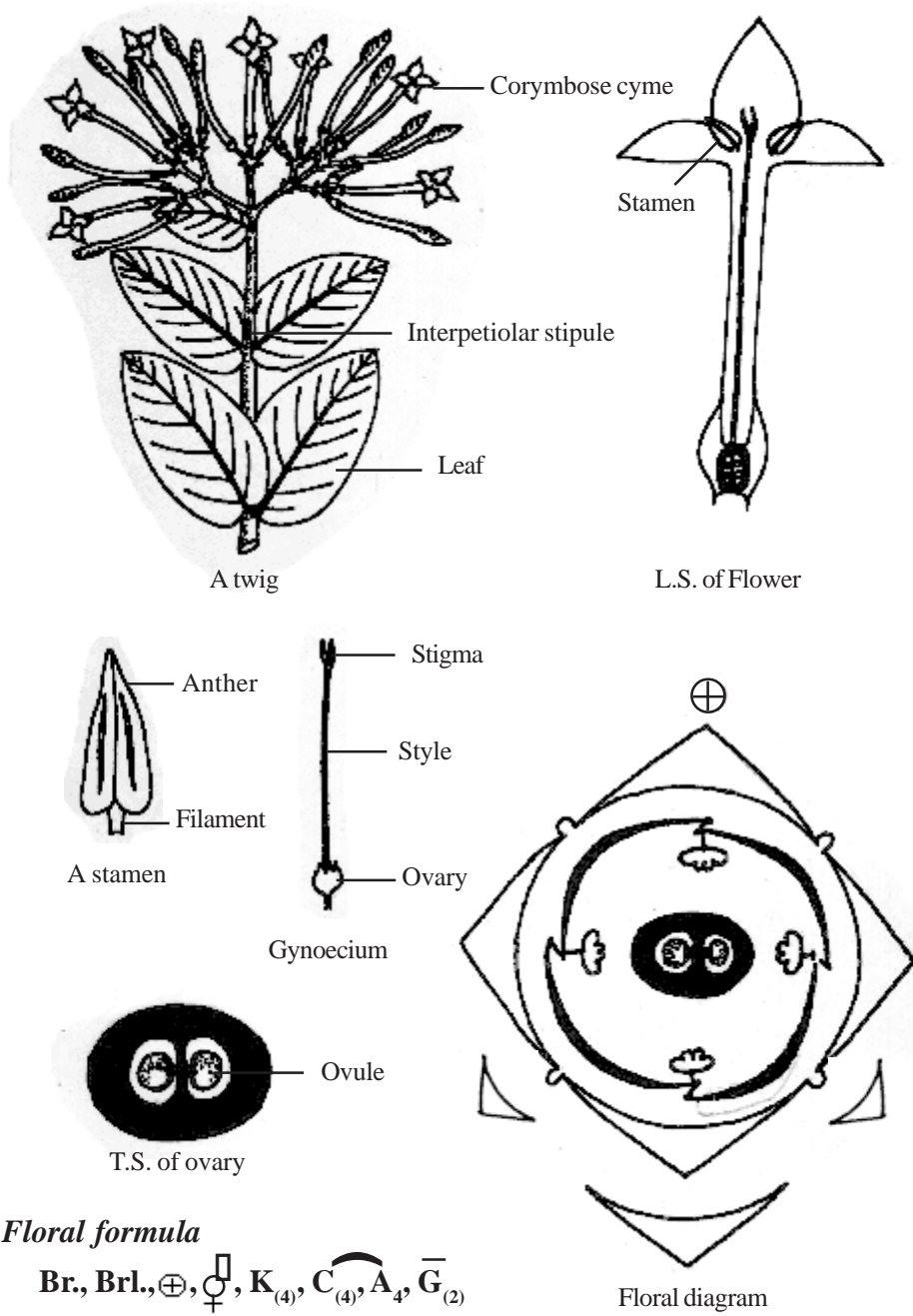
**Fruit**

A berry.

**Seed**

Endospermous.

**Floral formula**



*Floral formula*



*Fig. 1.5. Ixora coccinea*

## ECONOMIC IMPORTANCE

### 1. Beverage plants

The seeds of *Coffea arabica* (Coffee plant) are roasted and powdered for making coffee. The stimulating effect of coffee is due to the presence of alkaloid “caffeine”.

### 2. Medicinal plants

The drug ‘quinine’ obtained from the bark of *Cinchona officinalis* is used throughout the world in the treatment of malarial fever. The extract obtained from the fruits of *Randia tinctoria* possesses insecticidal and insect repellent properties.

### 3. Dye plants

The dyes alizarin and purpurin are obtained from the roots of *Rubia tinctoria* (madder). A red dye is extracted from the root and barks of *Oldenlandia umbellata* (Dye root). A yellow dye is obtained from the barks of *Morinda angustifolia*.

### 4. Timber plants

Timber of commercial value is obtained from *Adina cordifolia* (Manjakkadambu) and *Morinda tinctoria* (Nuna tree).

### 5. Ornamental plants

*Gardenia jasminoides* (cape jasmine), *Ixora coccinea* (Iddlipoo) and *Mussaenda frondosa* (Vellai madandhai) are grown in gardens.

## Self evaluation

### I. Choose and write the correct options.

- Rubiaceae is placed under the series
  - Inferae
  - Heteromerae
  - Bicarpellatae
  - Unisexuales
- The phyllotaxy in *Ixora coccinea* is
  - alternate
  - opposite decussate
  - whorled
  - spiral
- In *Ixora coccinea*, the stamens are
  - monadelphous
  - syngenesious
  - epipetalous
  - diadelphous

**II. Answer the following questions in two or three sentences.**

4. Write a note on epipetalous stamen.
5. Write the binomial of any two dye plants of Rubiaceae.
6. Write the systematic position of Rubiaceae.

**III. Answer the following questions in about 100 words.**

7. Draw floral diagram of *Ixora coccinea* and write floral formula
8. Give a brief account on economic importance of Rubiaceae.
9. Describe the essential components of *Ixora coccinea*.

**IV. Answer the following questions in about 200 words.**

10. Describe *Ixora coccinea* in botanical terms.
11. Write the general characteristic features of Rubiaceae.



### 1.3.4. ASTERACEAE – the sunflower family

#### Systematic position

Class: Dicotyledonae  
Sub-class: Gamopetalae  
Series: Inferae  
Order: Asterales  
Family: Asteraceae

#### General characters

#### Distribution

Asteraceae is the largest family of flowering plants comprising about 900 genera and more than 20,000 species. They are distributed throughout the world. In India, about 138 genera and about 708 species are reported.

#### Habit

Mostly annual or perennial herbs (eg. *Eupatorium odoratum*) or shrubs (eg. *Senecio*) or trees (eg. *Vernonia arborea*). Root and stem commonly contain oil ducts. Many species have colourless latex.

#### Root

Normally a branched tap root system. Root tubers are found in *Dahlia coccinea*.

#### Stem

Aerial, erect or prostrate or decumbent, tuberous (eg. *Helianthus tuberosus*) or sucker eg. *Chrysanthemum indicum* (Akrakaram) or runner (eg. *Launaea pinnatifida*).

#### Leaf

Simple, entire or pinnately or palmately lobed or compound, alternate (eg. *Vernonia arborea*) or opposite (eg. *Tridax procumbens*) or whorled (eg. *Eupatorium odoratum*) or radical (eg. *Launaea pinnatifida*), exstipulate showing reticulate venation, hairy (*Tridax procumbens*) and spinous (eg. *Carthamus tinctorius*).

#### Inflorescence

This family is characterized by the presence of head or capitulum type of inflorescence. The number of florets in a head is variable from a few to several hundreds, but in *Echinops*, the head is reduced to a single flower.

The heads are of two types, heterogamous and homogamous. There are two types of florets in **heterogamous heads** eg. *Helianthus annuus* and *Tridax procumbens* (Vettukkaya plant). The central florets are tubular, bisexual and also known as disc florets. The marginal florets are ligulate, pistillate and also known as ray florets. In homogamous heads, all the florets are **tubular** as in *Vernonia arborea* and *Ageratum mexicanum*. All the florets are **ligulate** as in *Launaea pinnatifida*.

### **Flower**

Very small in size hence referred to as florets, sessile, bracteolate (eg. *Helianthus annuus*) or ebracteolate (eg. *Tridax procumbens*). Pentamerous and epigynous. The disc florets are generally complete, bisexual and actinomorphic, whereas the ray florets are incomplete, pistillate or neutral and zygomorphic.

### **Calyx**

In many species calyx is reduced to numerous hairy appendages called pappus, arranged on top of the ovary. The persistent pappus acts like a parachute and helps in the dispersal of fruit.

### **Corolla**

Petals 5, gamopetalous showing valvate aestivation, regular and tubular in disc florets and irregular and ligulate or bilabiate in ray florets.

### **Androecium**

Stamens 5, epipetalous and alternate the petals. The stamens are **syngenesious** i.e. only anthers are fused into a tube around the style and filaments are free. Anthers are ditheous, basifixed and dehiscing longitudinally.

### **Gynoecium**

Ovary inferior, bicarpellary and syncarpous. Ovary unilocular with a single ovule on basal placentation. Style simple with bifid stigma.

### **Fruit**

Cypsela, single seeded, dry indehiscent fruit developing from an inferior ovary.

### **Seed**

Non-endospermous.

## **Botanical description of *Tridax procumbens***

### **Habit**

A decumbent herb. Stem and leaves are covered by hairs.

### **Root**

Tap root system.

### **Stem**

Herbaceous, cylindrical, decumbent and branched.

### **Leaf**

Simple, opposite, exstipulate and margins dentate showing reticulate venation.

### **Inflorescence**

A terminal heterogamous head and receptacle of the head is convex and surrounded by green involucre. The tubular florets occupy the centre and the ligulate florets are found at the margins.

### **Tubular or disc florets**

Bracteate, ebracteolate, sessile, complete, bisexual, pentamerous, actinomorphic and epigynous.

### **Calyx**

Reduced into numerous hairy outgrowths called pappus arranged on top of ovary and persistent.

### **Corolla**

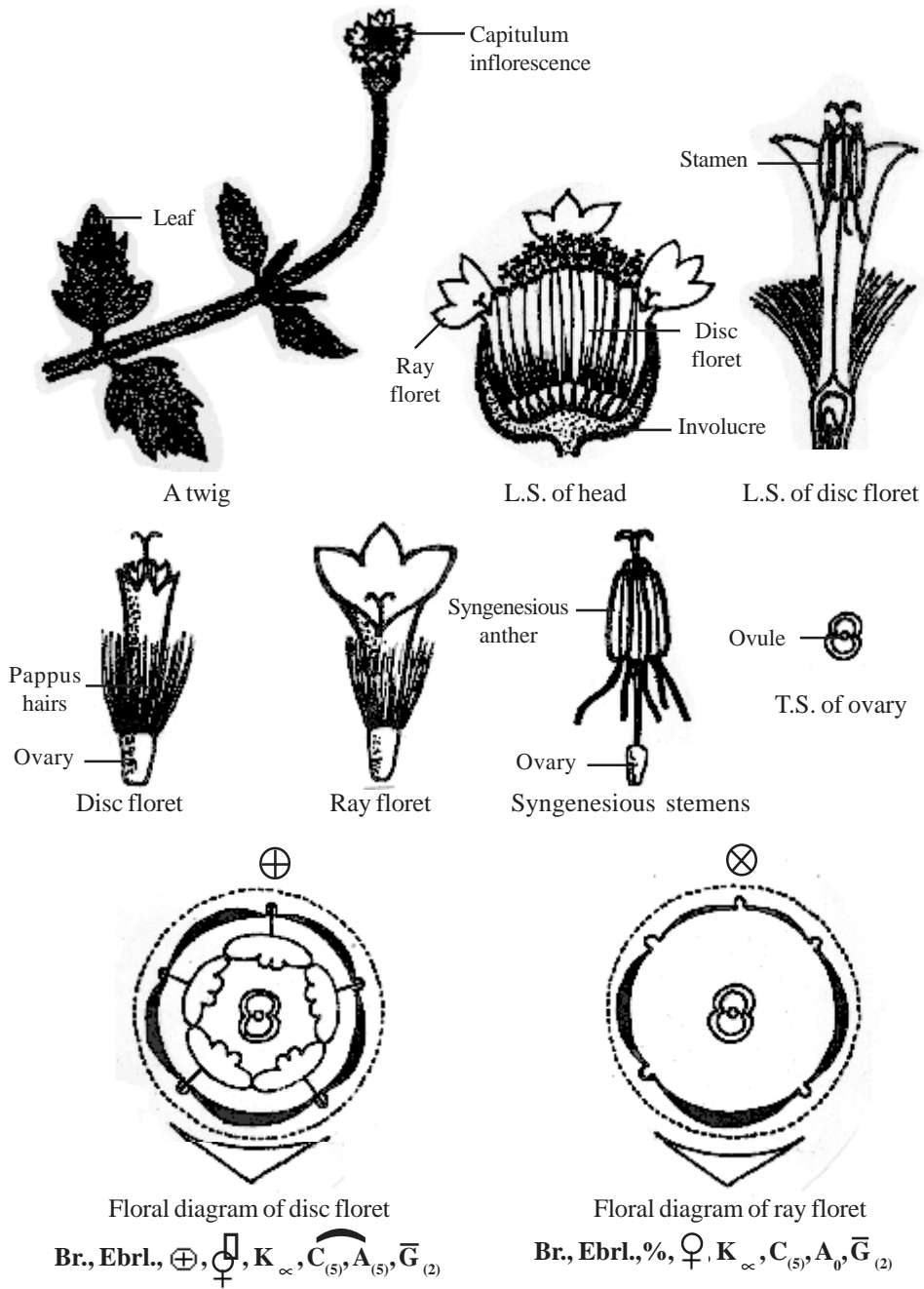
Petals 5, gamopetalous, regular, tubular and showing valvate aestivation.

### **Androecium**

Stamens 5, epipetalous, syngenesious and alternate with petals. Anthers are ditheous, basifixed, introrse and dehiscent longitudinally.

### **Gynoecium**

Ovary inferior, bicarpellary and syncarpous. Ovary unilocular with a single ovule on basal placentation. Style simple with bifid stigma.



**Fig. 1.6. *Tridax procumbens***

**Fruit**

A cypsela.

**Seed**

Non-endospermous.

**Floral formula****Ligulate or ray florets**

Bracteate, ebracteolate, sessile, incomplete, pistillate, zygomorphic and epigynous.

**Calyx**

Reduced into numerous hairy outgrowths called pappus arranged on top of the ovary and persistent.

**Corolla**

Petals 5, gamopetalous, irregular, ligulate or bilabiate, the anterior lip is large and 3 lobed, the posterior one is small in the form of 2 teeth like projections showing valvate aestivation.

**Androecium**

Absent.

**Gynoecium**

Ovary inferior, bicarpellary and syncarpous. Ovary unilocular with a single ovule on basal placentation. Style simple with bifid stigma.

**Fruit**

A cypsela.

**Seed**

Non-endospermous.

**Floral formula**

## **Economic importance**

### **1. Oil plants**

Oil extracted from the seeds of *Helianthus annuus* (sunflower) is edible and used as a cooking medium. Oil extracted from the seeds of *Carthamus tinctorius* (safflower) is edible and also used in the manufacture of soap. It contains less amount of cholesterol and therefore it is recommended for heart patients.

### **2. Medicinal plants**

The entire plant, *Eclipta prostrata* (Karisalankanni) is used in the preparation of bathing oil and also in the treatment of jaundice, spleen and liver disorders. The drug **santonin** obtained from the heads of *Artemesia maritima* is used for expelling intestinal round worms.

### **3. Dye plants**

A natural red dye obtained from *Carthamus tinctorius* is used for dyeing silks. A yellow dye obtained from the flowers of *Tagetes erecta* is used for dyeing cotton.

### **4. Pesticides**

A dried powder called '**Pyrethrum**' obtained from the flower heads of *Chrysanthemum cinerarifolium* and *C. coccineum* is used as mosquito repellent.

### **5. Beverage**

Powder obtained from the seeds of *Cichorium intybus* (chicory/ kasini keerai) is mixed with coffee powder. Leaves are used to treat several diseases and also used as salad.

### **6. Ornamental plants**

*Helianthus annuus* (sunflower), *Tagetes petula* (French marigold), *Calendula officinalis* (pot marigold) and *Zinnia elegans* are grown in gardens for their beautiful flowers.

## Self evaluation

### ***I. Choose and write the correct options.***

1. *Vernonia arborea* is a
  - a. herb
  - b. shrub
  - c. tree
  - d. twiner
2. The head is reduced to single flower in
  - a. *Echinops*
  - b. *Launaea*
  - c. *Chrysanthemum*
  - d. *Dahlia*.
3. Homogamous head inflorescence is found in
  - a. *Echinops*
  - b. *Launaea*
  - c. *Helianthus*
  - d. *Tridax*.

### ***II. Answer the following questions in two or three sentences.***

4. What is syngenesious stamen?
5. Write the floral formulae for ray and disc florets of Asteraceae.
6. What is pappus?
7. What is santonin?
8. What is pyrethrum?
9. Describe the gynoecium of *Tridax procumbens*.
10. Write the systematic position of Asteraceae.

### ***III. Answer the following questions in about 100 words.***

11. Write the differences between ray and disc florest.
12. Give a brief account on the economic importance of Asteraceae.
13. Describe ray florets of *Tridax procumbens*.
14. Give an account on head inflorescence.

### ***IV. Answer the following questions in about 200 words.***

15. Describe *Tridax procumbens* in botanical terms.
16. Write the general characteristic features of Asteraceae.

### 1.3.5. SOLANACEAE – the potato family

#### Systematic position

Class: Dicotyledonae

Sub-class: Gamopetalae

Series: Bicarpellatae

Order: Polemoniales

Family: Solanaceae

#### General characters

#### Distribution

Solanaceae includes about 90 genera and more than 2,800 species. The plants are widely distributed in tropical and subtropical regions. In India, this family is represented by 21 genera and 70 species.

#### Habit

Mostly annual herbs (eg. *Solanum melongena*), a few shrubs eg. *Solanum torvum* (Sundaikaai) and rarely trees (*S. giganteum*).

#### Root

A branched tap root system.

#### Stem

Aerial, erect, spinous eg. *Solanum xanthocarpum* (Kandangkathiri), herbaceous, woody, cylindrical, branched, hairy (eg. *Petunia hybrida* and *Nicotiana glauca*). In *S. tuberosum*, the stem is modified into tuber.

#### Leaf

Petiolate, usually alternate, sometimes opposite, simple, entire (eg. *Petunia hybrida*), exstipulate and showing unicostate reticulate venation. In *S. xanthocarpum*, the midrib and veins are found with yellowish spines.

#### Inflorescence

Solitary, axillary cyme (eg. *Datura stramonium*) or extra axillary scorpioid cyme called rhipidium (fan shaped cyme) as in *S. nigrum* or helicoid cyme as in *S. tuberosum* or umbellate cyme as in *Withania somnifera*.



## **Flower**

Bracteate (eg. *Petunia hybrida*) or ebracteate eg. *S. nigrum* (Manathakkaali), ebracteolate, pedicellate, dichlamydeous, pentamerous, complete, actinomorphic (eg. *Datura stramonium*) or Zygomorphic (eg. *Schizanthus pinnatus*), bisexual and hypogynous.

## **Calyx**

Sepals 5, green, gamosepalous, tubular and showing valvate aestivation eg. *Datura metal* (Oomathai) or imbricate aestivation (eg. *Petunia hybrida*), bell shaped and persistent (*S. melongena*).

## **Corolla**

Petals 5, gamopetalous, funnel shaped, rotate, tubular, usually plicate (folded like a fan blade) showing twisted or valvate or imbricate aestivation.

## **Androecium**

Stamens 5, epipetalous, alternate with the petals, usually not equal in length and filaments are inserted in the middle or basal region of corolla tube and basifixed. Anthers ditheous, introrse, usually basifixed or dorsifixed, dehiscing longitudinally or through apical pores (eg. *S. nigrum*). In *Schizanthus pinnatus*, two stamens are fertile and three stamens are reduced to staminodes.

## **Gynoecium**

Ovary superior, bicarpellary and syncarpous. Ovary bilocular, carpels obliquely placed and ovules on axile placentation. In *Datura* species, bilocule becomes tetralocular by the formation of false septa. Style simple and undivided. Stigma bifid or capitate.

## **Fruit**

A berry or septicidal capsule. In *Lycopersicon esculentum*, the fruit is a berry and in species of *Datura* and *Petunia*, the fruit is a capsule.

## **Seed**

Endospermous.

## **Botanical description of *Datura metal***

### **Habit**

Large, erect and stout herb.

### **Root**

Branched tap root system.

### **Stem**

The stem is hollow, green and herbaceous with strong odour.

### **Leaf**

Simple, alternate, petiolate, entire or deeply lobed, glabrous showing unicostate reticulate venation and exstipulate.

### **Inflorescence**

Solitary and axillary cyme.

### **Flower**

Flowers are large, greenish white, bracteate, ebracteolate, pedicellate, complete, dichlamydeous, pentamerous, regular, actinomorphic, bisexual and hypogynous.

### **Calyx**

Sepals 5, green, gamosepalous showing valvate aestivation. Calyx is mostly persistent and odd sepal is posterior in position.

### **Corolla**

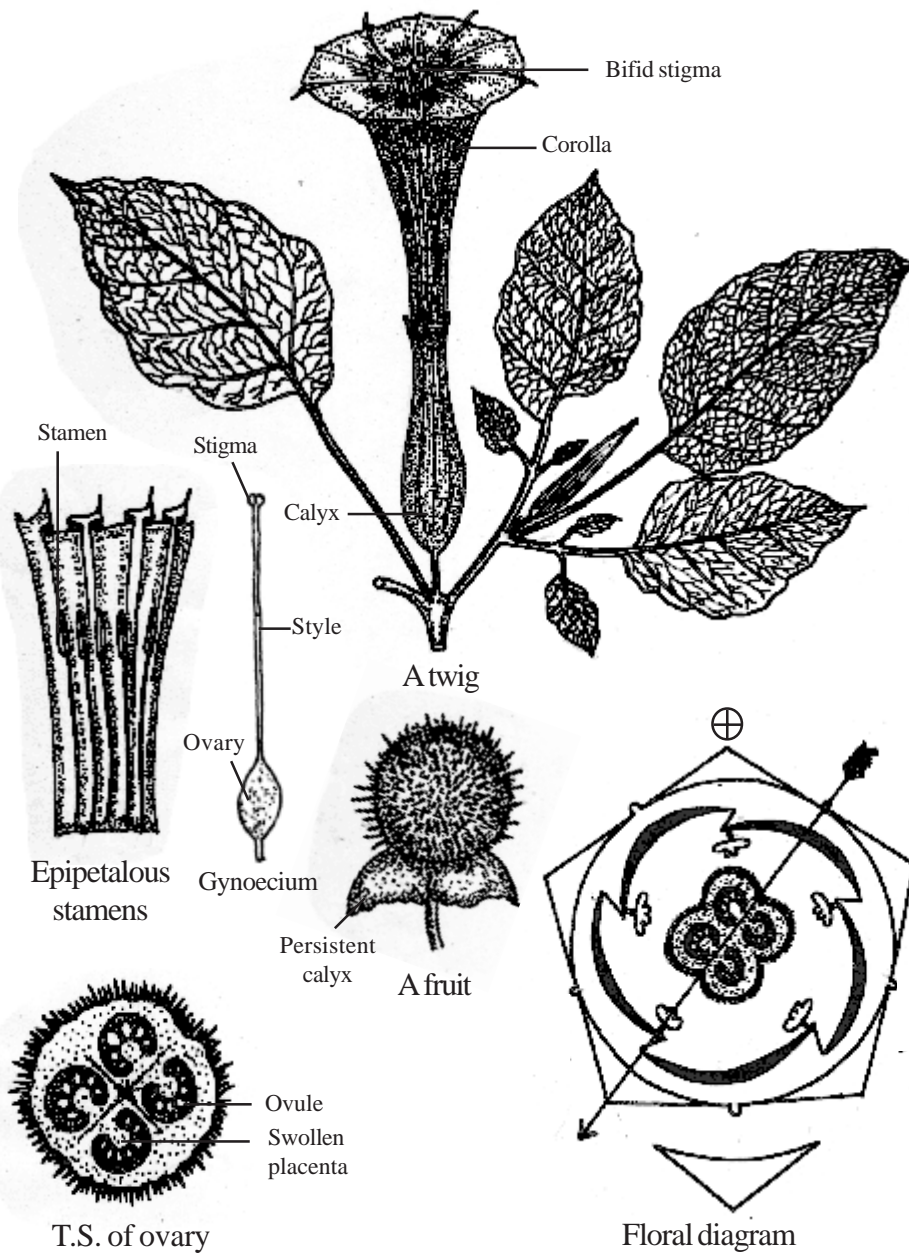
Petals 5, greenish white, gamopetalous, plicate (folded like a fan) showing twisted aestivation, funnel shaped with wide mouth and 10 lobed.

### **Androecium**

Stamens 5, free from one another epipetalous, alternate the petals and are inserted in the middle of the corolla tube. Anthers are basifixed, ditheous with long filament, introrse and longitudinally dehiscent.

### **Gynoecium**

Ovary superior, bicarpellary and syncarpous. Ovary basically bilocular but tetralocular due to the formation of false septa. Carpels are obliquely placed and ovules on swollen axile placenta. Style simple, long and filiform. Stigma two lobed.



Floral formula :  $\text{Br.}, \text{Ebrl.}, \oplus, \ominus, \text{K}_{(5)}, \overline{\text{C}_{(5)}}, \text{A}_5, \underline{\text{G}}_{(2)}$

**Fig.1.7. *Datura metel***

### **Fruit**

Spinescent capsule opening by four apical valves with persistent calyx.

### **Seed**

Endospermous.

### **Floral Formula**



## **ECONOMIC IMPORTANCE**

### **1. Food plants**

Tubers of *Solanum tuberosum* (potato) are used as common vegetable throughout the world. Tender fruits of *S. melongena* (brinjal) and ripened fruits of *Lycopersicon esculentum* (tomato) are used as delicious vegetables.

### **2. Medicinal plants**

Roots of *Atropa belladonna* yield powerful alkaloid 'atropine'. It is used for relieving muscular pain. Leaves and flowers of *Datura stramonium* are the sources of drug 'stramonium' used to treat asthma and whooping cough. Leaves, flowers, berries of *Solanum trilobatum* (thoodhuvalai) are used to treat cough. Roots and leaves of *Withania somnifera* (Amukkara) are used to treat nervous disorder and are diuretic apart from useful tonic.

### **3. Tobacco**

Leaves of *Nicotiana tabacum* (tobacco) contain alkaloids nicotine, nornicotine and anabasine. Nicotine is considered to be the principal alkaloid in commercial tobaccos such as cigarette, bidi, pipes and hukkah as well as chewing and snuffing. It is also used as sedative, antispasmodic and insecticide.

### **4. Ornamental plants**

*Cestrum diurnum* (day jasmine), *C. nocturnum* (night jasmine) and *Petunia hybrida* (pink flower) are grown in gardens for their beautiful flowers.

## Self evaluation

### ***I. Choose and write the correct options.***

1. Solanaceae is placed under
  - a. Malvales
  - b. Polemoniales
  - c. Unisexuales
  - d. Ranales.
2. In which of the following plants the midrib and veins are found with yellowish spines
  - a. *Solanum melongena*
  - b. *Datura metal*
  - c. *Solanum xanthocarpum*
  - d. *Petunia hybrida*.
3. The carpels are obliquely placed in the members of
  - a. Malvaceae
  - b. Solanaceae
  - c. Euphorbiaceae
  - d. Musaceae

### ***II. Answer the following questions in two or three sentences.***

4. What is atropine?
5. Give the systematic position of Solanaceae.
6. Write the binomials of any three medicinally useful plants in Solanaceae
7. Describe the gynoecium of members of Solanaceae.
8. Write the different types of inflorescence found in Solanaceae. Give examples for each.
9. Draw the floral diagram and write the floral formula of *Datura metal*.
10. Write any three binomials of food plants of Solanaceae.
11. Name the alkaloids found in tobacco.

### ***III. Answer the following questions in about 100 words.***

12. Give an account of the economic importance of the family Solanaceae.

### ***IV. Answer the following question in about 200 words.***

13. Describe *Datura metal* in botanical terms.
14. Write the general characteristic features of Solanaceae.

### 1.3.6. EUPHORBIACEAE – the castor family

#### Systematic position

Class: Dicotyledonae

Sub-class: Monochlamydeae

Series: Unisexuales

Family: Euphorbiaceae

#### General characters

#### Distribution

Euphorbiaceae includes more than 300 genera and about 7,500 species. It is world wide in distribution, but particularly well represented in Africa and South America. In India, it is represented by more than 70 genera and about 450 species.

#### Habit

This family includes a large number of annual herbs (eg. *Phyllanthus amarus*) or shrubs (eg. *Ricinus communis*) or trees (eg. *Phyllanthus emblica*). In several species of *Euphorbia*, the stem is modified to perform photosynthesis. This modified stem is called **cladode** and it resembles cactus. eg. *E. tirucalli* and *E. antiquorum* (Sadhurakkalli). This family shows a great range of variation in vegetative and floral characters. Almost all the plants have latex which is either milky or watery.

#### Root

A branched tap root system.

#### Stem

Aerial, erect or prostrate (eg. *E. prostrata*), cylindrical, branched, solid or hollow (eg. *Ricinus communis*), usually contains milky latex (eg. *E. tirucalli*) or watery latex (eg. *Jatropha curcas*).

#### Leaf

Stipulate or exstipulate, petiolate, alternate (eg. *Ricinus communis*), simple, entire or deeply lobed or trifoliately compound (eg. *Hevea brasiliensis*) and with unicostate or multicostate reticulate venation. The stipules are modified into a pair of spines (eg. *E. splendens*) or glandular hairs

(eg. *Jatropha curcas*). In xerophytic species of *Euphorbia*, leaves are reduced or absent. The leaves around the cyathium become beautifully coloured in *E. pulcherrima* (Paalperukki tree).

### **Inflorescence**

The characteristic inflorescence of *Euphorbia* is cyathium. It is a collection of unisexual flowers arranged in cymose manner on a condensed axis and enclosed within a cup-shaped involucre. Each cyathium has a single central female flower surrounded by two to many male flowers. Each male flower is represented by a single stamen. They are arranged in centrifugal manner. The pedicel in female flower is short or long. If it is short, the female flower remains hidden within the involucre. If it is long, the female flower comes out of involucre. Extra floral nectar secreting gland is also located in the cyathium.

Various types of inflorescence are seen in the members of Euphorbiaceae. In *Ricinus communis*, it is a panicle where female and male flowers are arranged in racemose manner. Female flowers are at the top and male flowers below. In *Croton sparsiflorus* (Eli amanakku), the inflorescence is simple raceme, whereas in *Acalypha indica* (Kuppaimeni), it is catkin. In *Phyllanthus amarus*, the male and female flowers are axillary and solitary.

### **Flower**

Bracteate, ebracteolate, pedicellate, unisexual, monoecious or dioecious, incomplete and hypogynous. In *Euphorbia*, the male flower is represented by a single stamen and female flower by a single pistil.

### **Perianth**

In *Croton sparsiflorus*, the male flowers have two whorls of perianth whereas the female flowers have a single whorl of perianth. The male and female flowers of *Euphorbia* are usually devoid of perianth i.e aphyllous. The tepals are polyphyllous in *Phyllanthus amarus* and gamophyllous in *Ricinus communis*.

### **Androecium**

Stamen one to many, free or united. In *Ricinus communis*, the stamen is polyadelphous and the filaments are branched. They are fused into

several bundles. Anthers are ditheous. Rudimentary ovary called pistillode is often present in male flowers.

### **Gynoecium**

Ovary superior, tricarpeal and syncarpous. Ovary trilobular with one or two ovules in each locule on axile placentation. Ovary is distinctly three lobed. Styles three, each ending in a bifid stigma.

### **Fruit**

Most commonly schizocarpic capsule or drupe. It is regma in *Ricinus communis*, dehiscent into three cocci.

### **Seed**

Endospermous.

## **Botanical description of *Ricinus communis***

### **Habit**

Perennial shrub.

### **Root**

Branched tap root system.

### **Stem**

Aerial, erect, herbaceous but woody below, branched and hollow. Young branches are covered with hair like outgrowth. Latex is present.

### **Leaf**

Petiolate, exstipulate, alternate, deeply palmately lobed with 7 or more lobes. Venation is palmately reticulate divergent.

### **Inflorescence**

Compound raceme or panicle and terminal. Male flowers are seen below and female flowers near the apex.

### **Male Flower**

Bracteate, ebracteolate, pedicellate, actinomorphic and incomplete.



**Perianth**

Tepals 5, arranged in single whorl, gamophyllous, valvate aestivation and odd tepal is posterior in position.

**Androecium**

Stamens many, polyadelphous, filaments branched and united to form five branches. Anthers are ditheous, globose, basifixed, introrse and dehiscent by longitudinal slits.

**Gynoecium**

Absent but pistillode is present.

**Floral Formula**

Br., Ebrl.,  $\oplus$ ,  $\sigma^7$ ,  $P_{(5)}$ ,  $A_{\infty}$ ,  $G_0$ .

**Female Flower**

Bracteate, ebracteolate, pedicellate, actinomorphic, incomplete and hypogynous.

**Perianth**

Tepals 3 arranged in single whorl and gamophyllous showing valvate aestivation.

**Androecium**

Absent but staminode is present.

**Gynoecium**

Ovary superior, trilocular and syncarpous. Ovary trilobular with one ovule in each locule on axile placentation. Styles 3, deep red and long. Bifid with feathery stigma.

**Fruit**

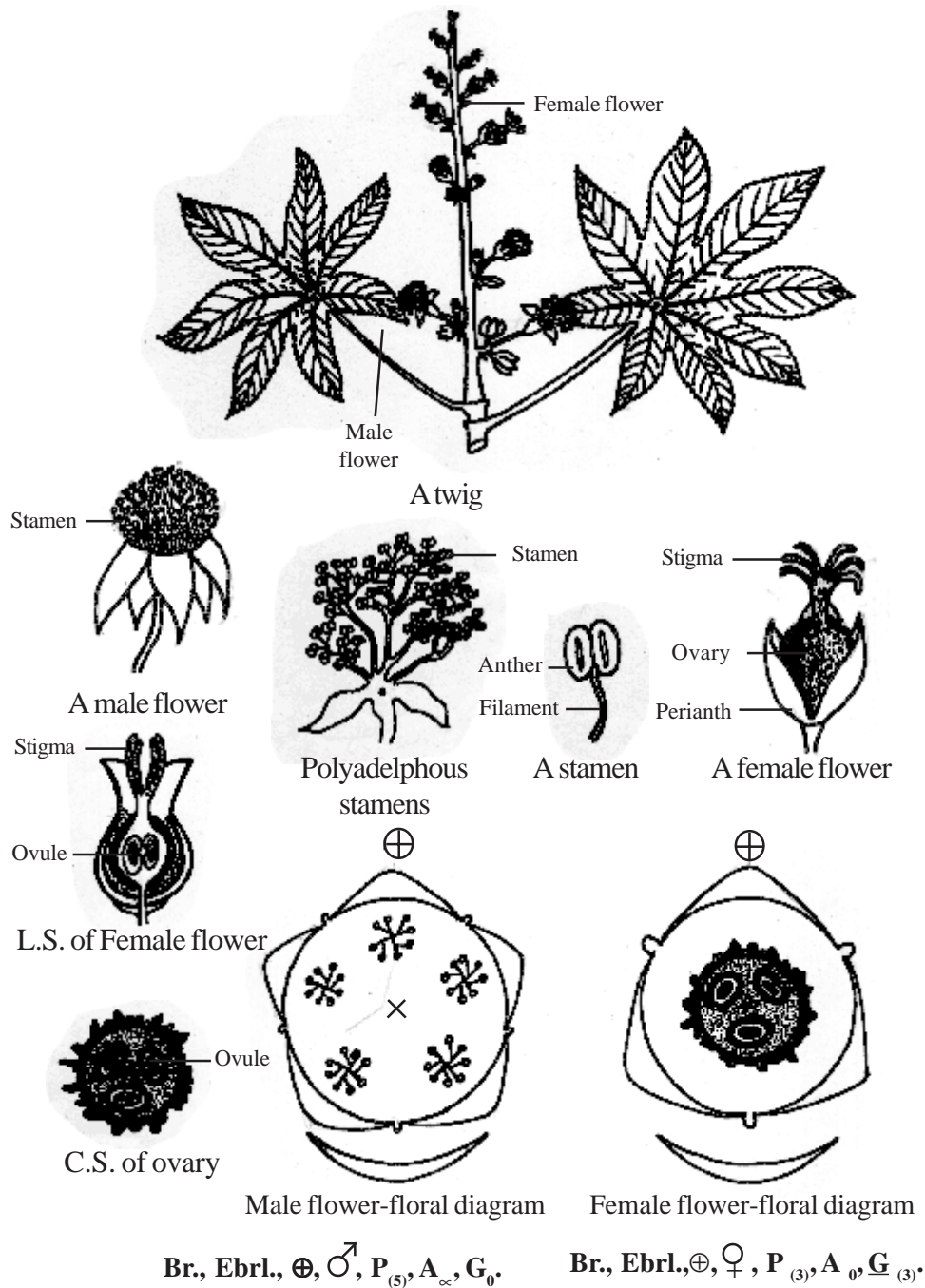
Fruit is called regma. It is covered by spinous outgrowths. The fruit splits into three one seeded cocci.

**Seed**

Endospermous.

**Floral Formula**

Br., Ebrl.,  $\oplus$ ,  $\sigma$ ,  $P_{(3)}$ ,  $A_0$ ,  $\underline{G}_{(3)}$ .



**Fig. 1.8. Ricinus communis**

## ECONOMIC IMPORTANCE

### 1. Food plants

The tuberous root of *Manihot esculenta* (tapioca) is rich in starch and forms valuable food stuff. The fleshy fruits of *Phyllanthus emblica* (Gooseberry) are rich in vitamin C. The fruit is edible and pickled.

### 2. Oil plants

Castor oil extracted from the seeds of *Ricinus communis* (Castor) is used as lubricant, vegetable oil and purgative. Jatropha oil obtained from the seeds of *Jatropha curcas* (Kattamanakku) is used as purgative, to treat skin diseases and to extract bio-diesel.

### 3. Medicinal plants

The entire shoot system of *Phyllanthus amarus* (Keezhanelli) is used to treat jaundice. The leaves and roots of *Jatropha gossypifolia* are used in the treatment of leprosy and snakebite.

### 4. Rubber plants

Over 98% of total natural rubber produced in the world is obtained from the coagulated latex of *Hevea brasiliensis* (para rubber) and *Manihot glaziovii* (manicoba rubber).

### 5. Ornamental plants

*Euphorbia pulcherrima*, *Codiaeum variegatum* (croton of gardens), *E. tirucalli* (milk bush) are examples for ornamental plants.

## Self evaluation

### I. Choose and write the correct options.

1. Euphorbiaceae includes about
  - a. 82 genera.
  - b. 90 genera
  - c. 300 genera
  - d. 254 genera.
2. *Ricinus communis* is a
  - a. herb
  - b. shrub
  - c. tree
  - d. cladode.

3. An example of cladode is
  - a. *Phyllanthus emblica*
  - b. *Ricinus communis*
  - c. *Jatropha curcas*
  - d. *Euphorbia tirucalli*.
4. In *Hevea brasiliensis*, the leaves are
  - a. simple
  - b. trifoliately compound
  - c. sessile
  - d. palmately lobed.

**II. Answer the following questions in two or three sentences.**

5. Write the systematic position of Euphorbiaceae.
6. What is cladode? Give an example.
7. What are different types of inflorescence seen in Euphorbiaceae? Give example for each.
8. Mention the binomials of two rubber plants of Euphorbiaceae
9. Describe the inflorescence of *Ricinus communis*.
10. Describe the cyathium inflorescence.
11. Write different types of inflorescence seen in Euphorbiaceae. Give examples for each.

**III. Answer the following questions in about 100 words.**

12. Describe the male flower of *Ricinus communis*.
13. Describe the female flower of *Ricinus communis*.
14. Write a brief account on different types of inflorescences of Euphorbiaceae.
15. Write a detailed account on the economic importance of Euphorbiaceae.

**IV. Answer the following question in about 200 words.**

16. Describe *Ricinus communis* in botanical terms.
17. Give an account of the general characteristic features of Euphorbiaceae.

## MONOCOT FAMILY

### 1.3.7 MUSACEAE - the banana family

#### Systematic position

Class : Monocotyledonae

Series : Epigynae

Family : Musaceae

#### General characters

#### Distribution

Musaceae includes about 6 genera and about 150 species. The members of this family are widely distributed over tropical regions of the world. In India it is represented by 2 genera and about 25 species.

#### Habit

Mostly perennial herbs attaining considerable height, perennating by means of rhizome (eg. *Musa paradisiaca* - Banana), rarely trees (eg. *Ravenala madagascariensis* - Traveller's palm) and watery sap is present.

#### Root

Generally fibrous adventitious root system is seen.

#### Stem

In *Musa* the real stem is underground called rhizome. The apparent, unbranched, erect and areal pseudostem is formed by the long, stiff and sheathy leaf bases which are rolled around one another to form an aerial **pseudostem**. The central axis that is concealed at the bottom of the pseudostem is called shaft. At the time of flowering, the shaft elongates, pierces through the pseudostem and produces an inflorescence terminally. *Musa* is a monocarpic perennial, because it produces flowers and fruits once during its life time. In *Ravenala*, the stem is aerial and woody.

#### Leaf

Simple with a long and strong petiole. The leaf blade is large and broad with sheathy leaf base. The leaf is extipulate and obtuse. The pinnately parallel venation extends upto the leaf margin. The

phyllotaxy is spiral in *Musa* but in *Ravenala* it is distichous i.e. the leaves are arranged in two rows on the same sides.

### **Inflorescence**

In *Musa*, the inflorescence is branched spadix. The flowers are protected by large, brightly coloured, spirally arranged, boat shaped bracts called spathes. When the flowers open, the spathes roll back and finally fall off. In *Ravenalea*, the inflorescence is a compound cyme. In *Musa*, the flowers are polygamous i.e. staminate flowers, pistillate flowers and bisexual flowers are present in the same plant. The male flowers lie within the upper bracts, the female flowers within the lower bracts and the bisexual flowers within the middle bracts.

### **Flowers**

Bracteate, ebractiolate, sessile, trimerous, unisexual or bisexual, when unisexual, the flowers are monoecious. The flowers are zygomorphic and epigynous.

### **Perianth**

Tepals 6, arranged in two whorls of 3 each, free or united. In *Musa*, the three tepals of the outer whorl and the two lateral tepals of the inner whorl are fused by valvate aestivation to form 5 toothed tube like structure. The inner posterior tepal is alone free. It is distinctly broad and membranous.

### **Androecium**

Basically stamens 6, in two whorls of 3 each, arranged opposite to the tepals. In *Musa* only 5 stamens are fertile and the inner posterior stamen is either absent or represented by a staminode. In *Ravenala*, all the 6 stamens are fertile. Anthers are dithecous and they dehisce by vertical slits. The filament is filiform and rudimentary ovary or pistillode is often present in the male flower.

### **Gynoecium**

Ovary inferior, tricarpeal, syncarpous, trilocular, numerous ovules on axile placentation. The style is simple and filiform. The stigma is three lobed.

### **Fruit**

An elongated fleshy berry without seeds eg. *Musa* and a capsule eg. *Ravenala*.

**Seed:** Non - endospermous

## **Botanical description of *Musa paradisiaca***

### **Habit**

Gignatic monocarpic perennial herb.

### **Root**

Fibrous adventitious root system.

### **Stem**

The real stem is underground called rhizome. The apparent, unbranched, erect and areal pseudostem is formed by the long, stiff and sheathy leaf bases which are rolled around one another to form an **aerial pseudostem**. The central axis that is concealed at the bottom of the pseudostem is called **shaft**. At the time of flowering, the shaft elongates, pierces through the pseudostem and produces an inflorescence terminally.

### **Leaf**

Simple with a long and strong petiole. The leaf blade is large and broad with sheathy leaf base. The leaf is extipulate and obtuse. The pinnately parallel venation extends upto the leaf margin. The phyllotaxy is spiral.

### **Inflorescence**

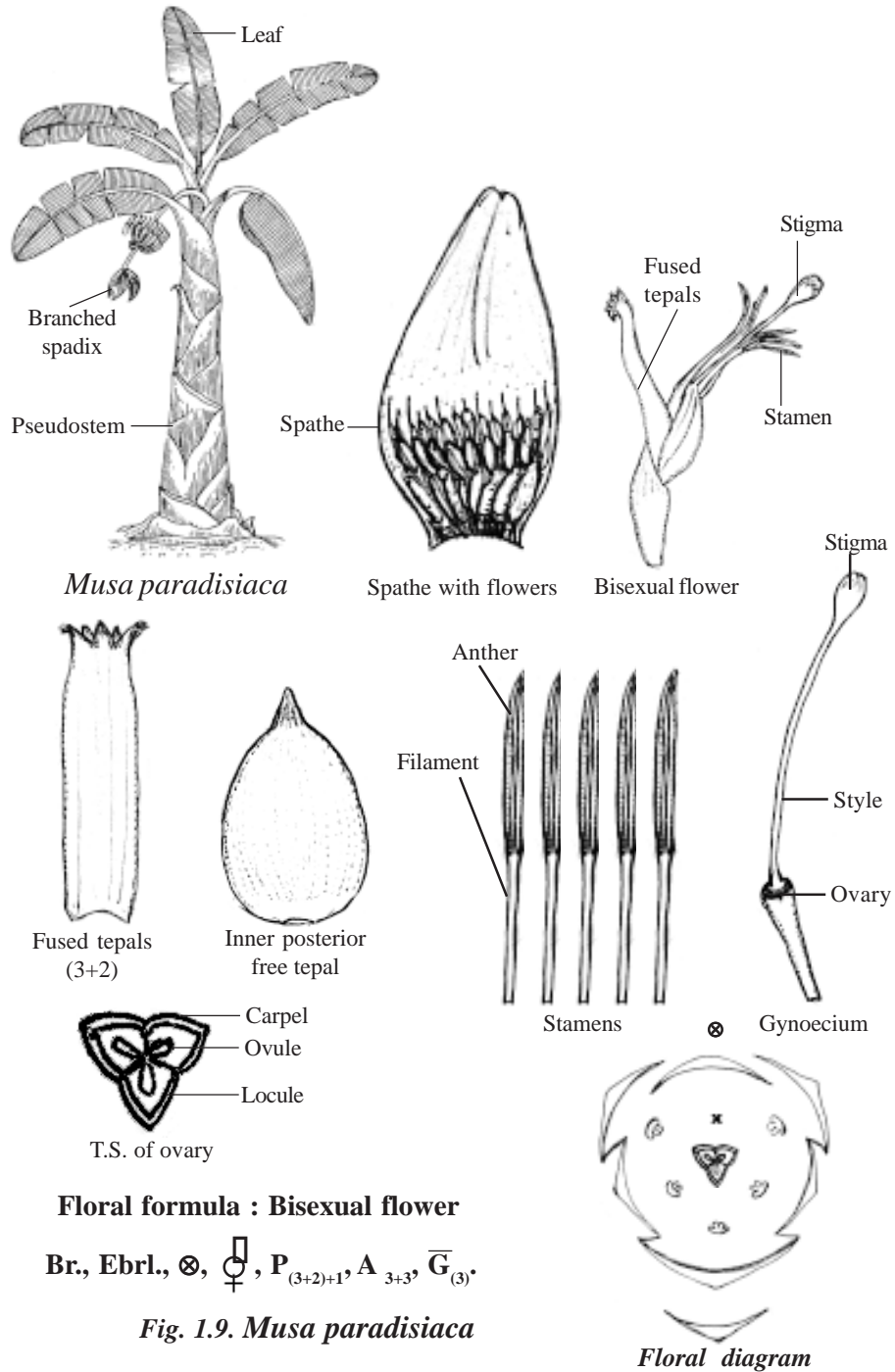
It is branched spadix. The flowers are protected by large, brightly coloured, spirally arranged, boat shaped bracts called spathes. When the flowers open, the spathes roll back and finally fall off.

### **Flowers**

Bracteate, ebractiolate, sessile, trimerous, unisexual or bisexual, when unisexual, the flowers are monoecious. The flowers are zygomorphic and epigynous.

### **Perianth**

Tepals 6, arranged in two whorls of 3 each. The three tepals of the outer whorl and the two lateral tepals of the inner whorl are fused by valvate aestivation to form 5 toothed tube like structure. The inner posterior tepal is alone free. It is distinctly broad and membranous.





### Androecium

Stamens 6, in two whorls of 3 each, arranged opposite to the tepals. Only 5 stamens are fertile and the inner posterior stamen is either absent or represented by a staminode. Anthers are dithecous and they dehisce by vertical slits. The filament is filiform and rudimentary ovary or pistillode is often present in the male flower.

### Gynoecium

Ovary inferior, tricarpeal, syncarpous, trilobular, numerous ovules on axile placentation. The style is simple and filiform. The stigma is three lobed.

### Fruit

An elongated fleshy berry and the seeds are not produced in cultivated varieties.

### Floral formulae

**Male flower** .. Br., Ebrl.,  $\otimes$ ,  $\square$ ,  $P_{(3+2)+1}$ ,  $A_{3+3}$ ,  $G_0$ .

**Female flower** .. Br., Ebrl.,  $\otimes$ ,  $\square$ ,  $P_{(3+2)+1}$ ,  $A_0$ ,  $\overline{G}_{(3)}$ .

**Bisexual flower** .. Br., Ebrl.,  $\otimes$ ,  $\square$ ,  $P_{(3+2)+1}$ ,  $A_{3+3}$ ,  $\overline{G}_{(3)}$ .

## ECONOMIC IMPORTANCE

### 1. Food plants

The fruits of *Musa paradisiaca* (Banana) are edible. The tender green bananas, the shaft and the flowers are cooked and eaten as vegetable. The leaves are commonly used as plates on festive occasions. The sap obtained from the sheathy leaf bases is considered to be an antidote for cobra bite. The small fruits obtained from *Musa chinensis* (Dwarf banana) are sweet and edible.

### 2. Fibre plant

The fibres obtained from sheathy leaf bases of *Musa textilis* (Manila hemp) are woven into **Abaca cloth** and used for cordage. It is also known as **Manila hemp**. This plant is extensively grown in Philippines.

### 3. Ornamental plants

*Ravenala madagascariensis* (Traveller's palm), *Strelitzia reginae* (the bird of paradise flower) and *Heliconia sp.* are grown as ornamentals.

## Self evaluation

### I. Choose and write the correct options.

1. "The bird of paradise flower" refers to
  - a. *Musa paradisiaca*
  - b. *Strelitzia reginae*
  - c. *Ravenala madagascariensis*
  - d. *Heliconia sp.*
2. The phyllotaxy in *Musa* is
  - a. alternate
  - b. opposite
  - c. distichous
  - d. spiral
3. In inflorescence in *Ravenala madagascariensis* is
  - a. compound cyme
  - b. compound raceme
  - c. branched spadix
  - d. simple raceme
4. The number of fertile stamens in *Ravenala madagascariensis* is
  - a. three
  - b. four
  - c. five
  - d. six

### II. Answer the following questions in two or three sentences.

5. What is polygamous ? Give an example.
6. What is monocarpic perennial ? Give an example.
7. Write the systematic position of Musaceae.
8. Explain the gynoecium of *Musa paradisiaca*.
9. Draw the floral diagram of bisexual flower of *Musa paradisiaca* and write floral formula.
10. What is pseudostem? How is it formed in *Musa paradisiaca* ?
11. List out the economic importance of *Musa paradisiaca*.

### III. Answer the following in about 100 words.

12. Write the differences between *Musa* and *Ravenala*.
13. Describe the androecium and gynoecium of *Musa paradisiaca*.
14. Write the economic importance of members of Musaceae.

### IV. Answer the following questions in 200 words.

15. Describe *Musa paradisiaca* in technical terms.
16. Write the general characteristic features of Musaceae.

### 1.3.8. ARECACEAE – the palm family

#### **Systematic position**

Class: Monocotyledonae

Series: Calycinae

Family: Arecaceae

#### ***General characters***

#### **Distribution**

Areaceae is one of the largest families in monocotyledons. It includes about 217 genera and more than 2,500 species. The members of this family are distributed throughout the tropical regions of the world. In India, it is represented by about 25 genera and more than 225 species.

#### **Habit**

Mostly unbranched trees with arborescent stem having prominent scars of leaf bases and a crown of large leaves (eg. *Cocos nucifera*) or shrubs eg. *Nipa fruticans* has no aerial stem and leaves arise directly from the underground rhizome.

#### **Root**

Fibrous and adventitious root system.

#### ***Stem***

Mostly aerial, erect, unbranched and columnar having prominent scars of leaf bases. Stem is short and stumpy in *Phoenix acaulis*. Internodes are usually short.

#### **Leaf**

Exstipulate, petiolate, petiole long and very strong with sheathing leaf base, palmately compound (eg. *Borassus flabellifer*) and usually in terminal clusters. Phyllotaxy is usually alternate spiral but scattered in *Calamus*. Venation is pinnately parallel (eg. *Cocos nucifera*) or palmately parallel divergent (eg. *Borassus flabellifer*).

#### **Inflorescence**

Large, usually lateral arising from the axils of leaves, spadix (eg. *Phoenix sylvestris*) or compound spadix (eg. *Cocos nucifera*) enclosed by

a large woody bract called spathe. In *Corypha umbraculifera* (Kudai panai), the spadix is terminal and it measures about 10 metres. It is a monocarpic plant. The plants are polycarpic and monoecious (eg. *Cocos nucifera*) or dioecious (eg. *Borassus flabellifer*).

### **Flower**

Bracteate, ebracteolate, sessile, usually unisexual and monoecious or dioecious, trimerous, incomplete, actinomorphic and hypogynous. In *Borassus flabellifer*, the male flowers are smaller than female flowers. In *Cocos nucifera* male flowers are densely arranged at the upper portions of the spike and female flowers are at the base of the spike.

### **Perianth**

Tepals 6 arranged in two whorls of three each, persistent, polyphyllous or gamophyllous showing valvate or twisted or imbricate aestivation. In *Phoenix acaulis*, the tepals of outer whorl are united and valvate while that of inner whorl are free and twisted.

### **Androecium**

Stamens 6 arranged in two whorls of three each and opposite to tepals. Anthers are dithecous, basifixed or dorsifixed, introrse and dehiscing longitudinally. Pistillode is usually present in male flowers.

### **Gynoecium**

Ovary superior, tricarpeal and syncarpous. Ovary trilobular with single ovule showing axile placentation. In *Phoenix acaulis*, the placentation is basal. Style extremely short or absent and stigma three. Staminode is present in female flowers. In *Cocos nucifera*, two carpels become abortive out of three.

### **Fruit**

A drupe with fibrous mesocarp.

### **Seed**

Seed with small embryo and abundant endosperm.

## **Botanical description of *Cocos nucifera***

### **Habit**

Unbranched tree with arborescent stem and a crown of large leaves. It grows to a height of 60 to 100 feet.

### **Root**

Fibrous and adventitious root system. As the stem increases in diameter, new roots are added at higher levels from the massive basal cushion and the youngest roots are visible above the soil surface.

### **Stem**

Aerial, erect, unbranched and columnar, having prominent scars of leaf bases. Internodes are usually short.

### **Leaf**

Exstipulate, petiolate, petiole long and very strong with sheathing leaf base, spiral and pinnately compound showing parallel venation.

### **Inflorescence**

Large, lateral arising from the axils of leaves, compound spadix, enclosed by large woody bract called spathe. Each spike in the spadix bears 2 to 3 female flowers at the base and 200 to 300 male flowers at the top. Flowers are protandrous, the female flowers open, after the male flowers have withered.

### **Male flower**

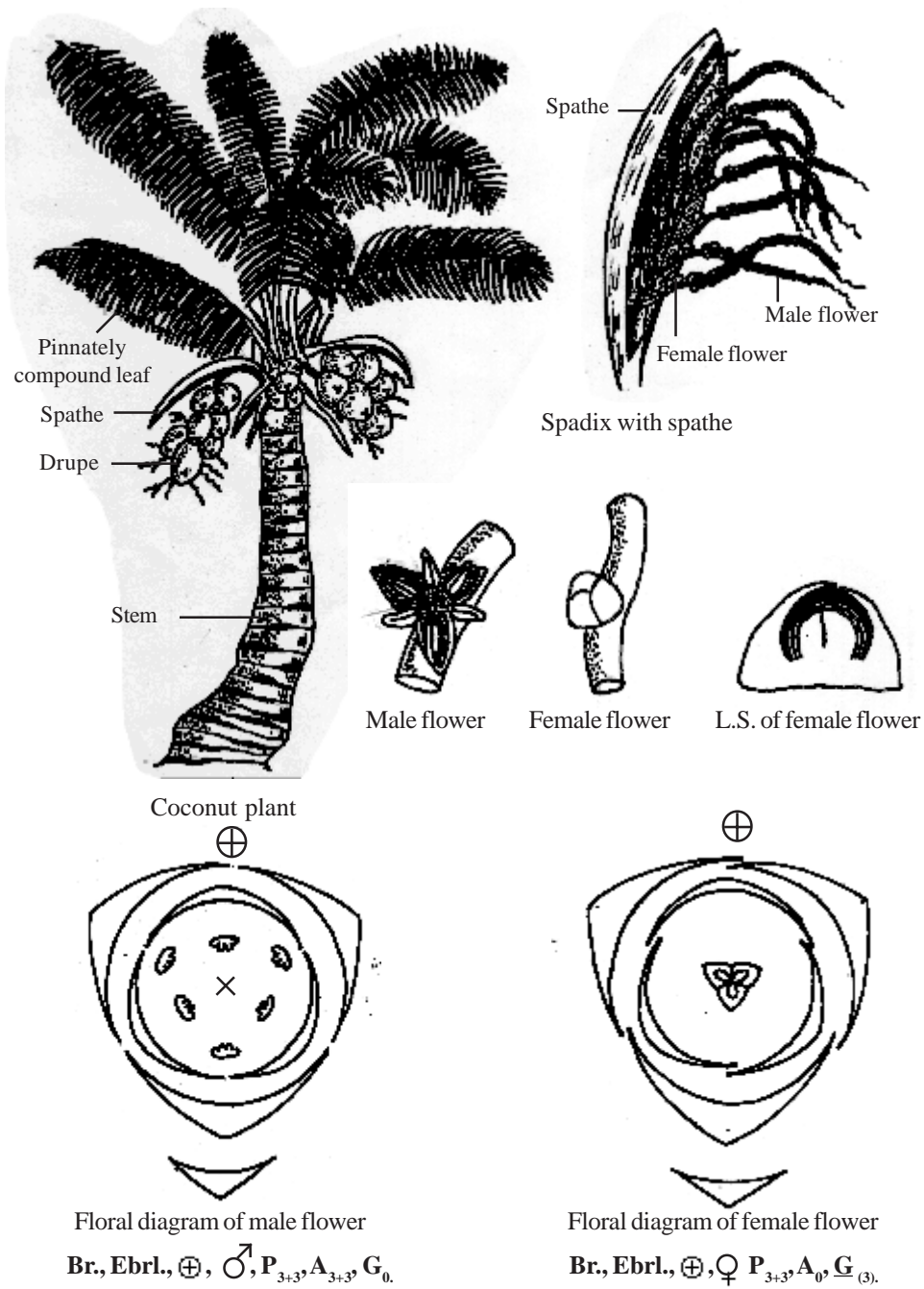
Bracteate, ebracteolate, sessile, staminate, incomplete, trimerous, actinomorphic and pistillodes are present.

### **Perianth**

Tepals 6 arranged in two whorls of three each, persistent and polyphyllous showing valvate aestivation in both the whorls. Inner odd tepal is posterior in position.

### **Androecium**

Stamens 6 arranged in two whorls of three each and antiphyllous. Anthers are ditheous, basifixed, introrse and dehiscing longitudinally.



**Fig. 1.10. *Cocos nucifera***

### **Gynoecium**

Absent but pistillode is present.

### **Floral formula**

**Br.**, **Ebrl.**,  $\oplus$ ,  $\text{♂}$ ,  $\text{P}_{3+3}$ ,  $\text{A}_{3+3}$ ,  $\text{G}_0$ .

### **Female flower**

Bracteate, ebracteolate, sessile, pistillate, incomplete, trimerous, actinomorphic and hypogynous.

### **Perianth**

Tepals 6 arranged in two whorls of three each, persistent, and polyphyllous showing imbricate aestivation in both the whorls. The inner posterior tepal is completely outside.

### **Androecium**

Absent but staminodes are present.

### **Gynoecium**

Ovary superior, tricarpellary and syncarpous. Ovary trilobular with single ovule showing axile placentation. Style is absent and stigmas three. Out of three carpels, two become abortive.

### **Fruit**

Fibrous drupe with stony endocarp.

### **Seed**

With small embryo and abundant endosperm.

### **Floral formula**

**Br.**, **Ebrl.**,  $\oplus$ ,  $\text{♀}$ ,  $\text{P}_{3+3}$ ,  $\text{A}_0$ ,  $\underline{\text{G}}_{(3)}$ .

### ***Economic importance***

#### **1. Edible products**

The fluid of tender fruit of *Cocos nucifera* (kalpa vriksha – coconut palm) is sweet and refreshing drink. The boiled young seedlings of *Borassus flabellifer* (palmyra palm) are edible and its fruits are eaten raw.

## 2. Oil plants

The oil obtained from dried endosperm of *Cocos nucifera* is called coconut oil. It is used for cooking, for the preparation of vegetable fat (ghee) and as hair oil. The oil obtained from fleshy mesocarp of *Elaeis guineensis* is called palm oil. It is mainly used for the manufacture of soap.

## 3. Toddy

A sugary solution obtained by cutting young peduncles of *Cocos nucifera*, *Borassus flabellifer* and *Phoenix sylvestris* (Eechai) is used for manufacturing jaggery. This sugary solution on fermentation yields the beverage called 'toddy'. This sap is also used for manufacturing a number of commercially useful products such as palm sugar, alcohol and vinegar.

## 4. Timber plants

Dense stem wood of *Borassus flabellifer* and *Cocos nucifera* is used as timber.

## 5. Ornamental plants

*Adonidia merilli* (Manila palm) and *Caryota urens* (wine palm).

### Self evaluation

#### I. Choose and write the correct options.

- Arecaceae is placed under the series
  - Unisexuales
  - Polemoniales
  - Multiovulatae aquatica
  - Calycinae
- Arecaceae includes
  - 217 genera
  - 482 genera
  - 500 genera
  - 900 genera.
- Borassus flabellifer* is the binomial of
  - coconut tree
  - wine palm
  - royal palm
  - palmyra palm.
- In *Corypha umbraculifera*, the spadix measures about
  - two metres
  - five metres
  - eight metres
  - ten metres.



**II. Answer the following questions in one or two sentences.**

5. Write the systematic position of Arecaceae.
6. Describe the gynoecium of *Cocos nucifera*.
7. Write the floral formula of male and female flower of *Cocos nucifera*.
8. What is a 'toddy' ? State its uses.

**III. Answer the following questions in about 100 words.**

9. Write a brief account on the economic importance of Arecaceae.
10. Draw the floral diagrams of *Cocos nucifera* and write their floral formulae.

**IV. Answer the following questions in about 200 words.**

11. Describe *Cocos nucifera* in botanical terms.
12. Write the general characteristic features of Arecaceae.

**Reference books**

1. Taxonomy of vascular plants - G.H.M. Lawrence, Indian edn. 1967.
2. Angiosperms by Dr. K.V. Krishnamurthy 1976.
3. Evolution and phylogeny of plants - J. Hutchinson 1969.
4. Taxonomy of angiosperms by P.C. Vasishta 1996.
5. Practical botany volume I and II by B.P. Pandey 2004.
6. Taxonomy of angiosperms by S. Palaniappan – Tamil version.
7. Flora of Tamil Nadu by Dr. K.K. Rammurthy – Tamil version.
8. Modern trends in plant taxonomy - Kasinathan – Tamil version.

## 2. PLANT ANATOMY

Plant anatomy (*Ana* = as under, *tamnein* = to cut) is the study of internal structure and organization of plants, especially of their parts by means of dissection and microscopic examination. The simple type of plant body is unicellular. In such forms, the single cell performs all the vital functions of life. It grows, prepares food, undergoes metabolism, reproduces and completes its span of life. The progressive evolution in plants has resulted in increasing complexity of structures. In higher plants, root, stem, leaves and flowers carry out different functions. Due to these divisions of labour, the cells of the plant are differentiated to form different tissues.

### 2.1. Tissues and tissue systems

The study of internal structure of plants reveals many types of tissues. Morphologically, a tissue is a group of cells, which are similar in origin, form and function. Physiologically, a tissue is composed of dissimilar cells that perform a common function, for example, phloem elements and food conduction respectively. The cells form various kinds of tissues. Two or more types of tissues form tissue systems. Different tissue systems form the organs. Each tissue carries out a specific function. Tissues can be classified into two types – Meristematic tissue and permanent tissue.

#### *Meristematic tissue*

A meristematic tissue (**meristos = divisible**) is a group of identical cells that are in a continuous state of division. Some cells produced by meristematic tissue stop dividing and acquire certain changes to become permanent tissues of the plant. This change from meristematic to permanent tissue is called **differentiation**. The remaining cells in the meristem retain their meristematic activity. Meristematic cells are self-perpetuating.

#### *Characteristics of meristematic cells*

The meristematic cells may be round, oval, polygonal or rectangular in shape. They are closely arranged without intercellular spaces. They have dense cytoplasm with large nucleus. They have smaller vacuoles, which are scattered throughout the cytoplasm. Their cell walls are thin, elastic and made up of cellulose.

### ***Classification of meristem***

Based on its **position**, the meristem is divided into three types – apical meristem, intercalary meristem and lateral meristem.

#### ***Apical meristem***

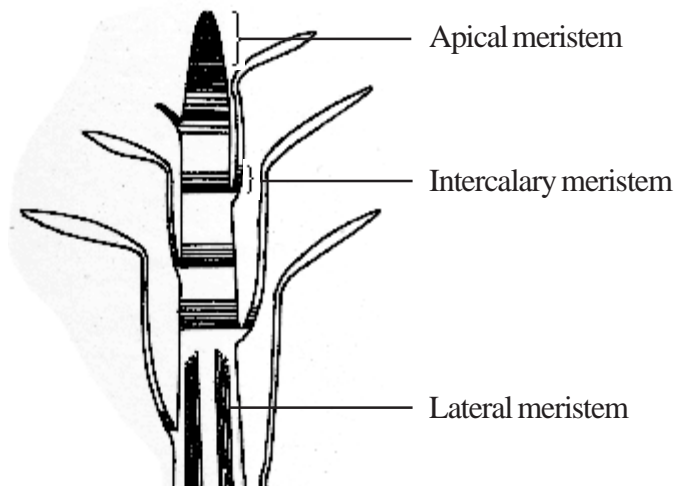
Apical meristem is found at the tips of roots, stem and branches. It is responsible for increase in length of plant. It is divided into three zones – **protoderm, procambium** and **ground meristem**. Protoderm gives rise to epidermal tissue; procambium gives rise to primary vascular tissues and ground meristem gives rise to cortex and pith.

#### ***Intercalary meristem***

It is present in the nodal region and is prominently found in monocotyledons, eg. grasses. As the name indicates, it is present in between the permanent tissues. It is derived from the apical meristem and is responsible for the elongation of internodes.

#### ***Lateral meristem***

The meristem that is present along the longitudinal axis of stem and root is called **lateral meristem**. **Vascular cambium** and **cork cambium** (phellogen) are examples for lateral meristem. It produces secondary permanent tissues, which result in the thickening of stem and root.



***Fig. 2.1. L.S of shoot - showing the positions of meristems***

### *Permanent tissue*

The cells, which are formed by apical meristem, are differentiated into different types of permanent tissues. These tissues have lost the power of dividing either permanently or temporarily.

### *Classification of permanent tissue*

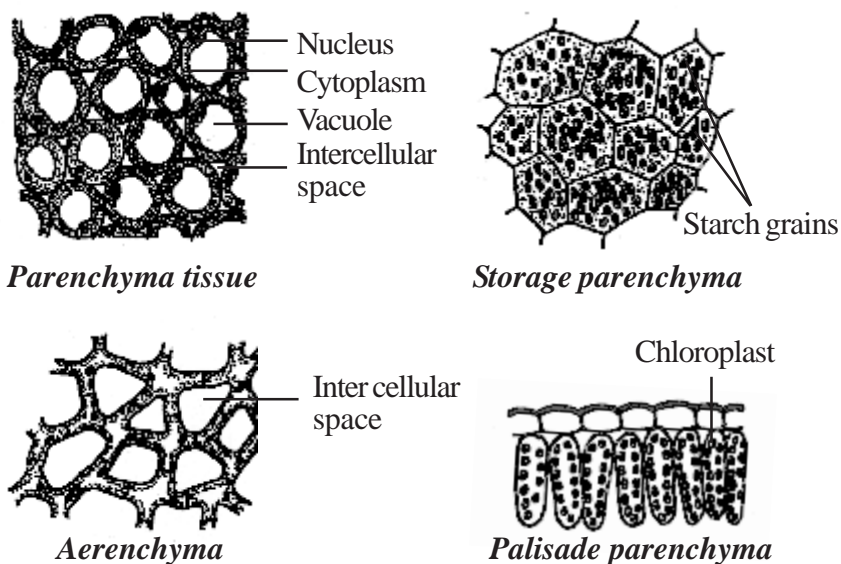
Based on the **constituent cells**, the permanent tissue is classified into two types – simple tissue and complex tissue.

### *Simple tissue*

A tissue with the cells of similar structure and function is called **simple tissue**. It is of three types - parenchyma, collenchyma and sclerenchyma.

### *Parenchyma*

It is generally present in all organs of the plant. It constitutes the ground tissue in a plant. Parenchyma is the precursor of all the other tissues. Parenchyma is a living tissue and made up of thin walled cells. The cell wall is made up of cellulose. Parenchyma cells may be



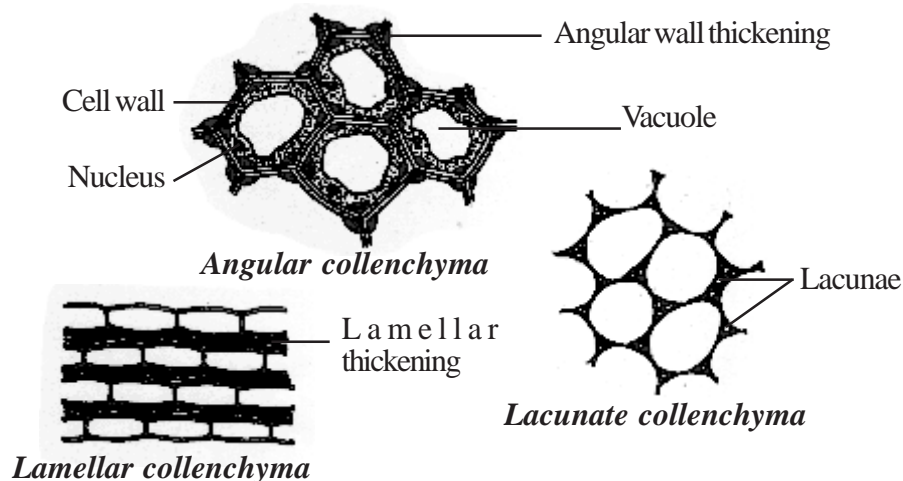
*Fig. 2.2 Types of parenchyma tissues*

oval, spherical, rectangular, cylindrical or stellate. The cells are usually polyhedral with 10 to 12 facets. Parenchyma is of different types and some of them are discussed as follows.

In water plants, the parenchyma found in the cortex region possesses well-developed large intercellular spaces called air spaces. This air filled parenchyma tissue is called **aerenchyma**. It helps the plant to float in water. eg. *Nymphaea* and *Hydrilla*. The parenchyma cells that are stored with starch grains are called **storage parenchyma**. eg. stem and root tubers. In the petioles of banana and *Canna*, star shaped parenchyma cells are found. These cells are called **stellate parenchyma**. In green parts of the plants, the parenchymatous cells have chloroplasts. These cells are called **chlorenchyma**. Its important function is photosynthesis.

### ***Collenchyma***

Collenchyma generally occurs in the dicot stems in two or more layers below the epidermis. These layers constitute the **hypodermis**. It is **absent in the roots** of land plants. It also occurs in **petiole** and **pedicel**. It gives strength to young organs. Collenchyma is a **living tissue**. It consists of more or less **elongated cells**, which are **polygonal** in cross section. The cell wall is unevenly thickened. The thickening is confined to the **corners** of the cells. Besides cellulose, the cell wall contains high amounts of hemicellulose and pectin.



**Fig. 2.3. Types of collenchyma**

Collenchyma may contain chloroplasts and carry out photosynthesis. Collenchyma is divided into three types – lamellar, angular and lacunate collenchyma.

In the hypodermis of *Helianthus*, only the tangential walls of collenchyma are thickened and the radial walls are devoid of thickening. This type of collenchyma is called **lamellar collenchyma**. In the hypodermis of *Datura* and *Nicotiana*, the cell walls of collenchyma are thickened at their angles. This type is called **angular** collenchyma. In the hypodermis of *Ipomoea*, the cell wall thickening materials are deposited on the walls bordering the intercellular spaces. This type is called lacunate collenchyma.

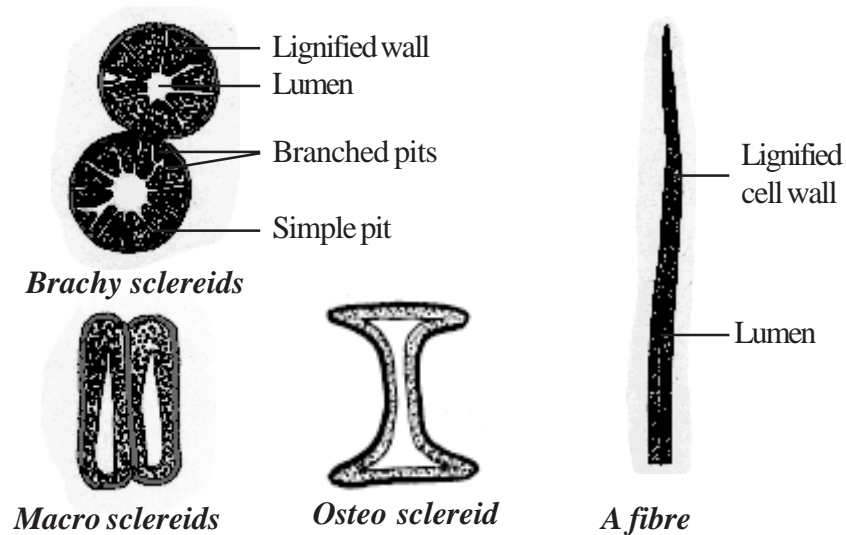
### ***Sclerenchyma***

Sclerenchyma is a **dead tissue**. The cells have lignified secondary walls. They **lack protoplasts**. On the basis of origin, structure and function, sclerenchyma is divided into two types – sclereids and fibres. The sclereids are different from fibres in the following respects. Sclereids are **shorter** whereas fibres are **longer**. Sclereids possess **numerous pits** as compared to the fibres.

### ***Sclereids***

Sclereids are **dead cells**. They vary greatly in shape and thickness. The cell wall is very thick due to **lignification**. Lumen is very much reduced. The pits may be **simple** or **branched**. Usually sclereids are **isodiametric**, but in some plants they are elongated. They are responsible for the rigidity of the seed-coat. The isodiametric sclereids are called **brachy-sclereids** (stone cells). They are found in bark, pith, cortex, hard endocarp and fleshy portions of some fruits. eg. pulp of *Pyrus*.

Elongated rod shaped sclereids are called **macroscleireids** (rod cells). They are found in the outer seed coat. eg. *Crotalaria*. The rod shaped sclereids with dilated ends are called **osteosclereids** (bone cells). eg. seed coat of *Pisum*.



*Fig. 2.4. Types of sclerenchyma*

### *Fibres*

Fibre cells are **dead cells**. They are very **long** and **narrow** with **pointed ends**. In transverse section, the fibres are **polygonal** with **narrow lumen**. The secondary wall is evenly thickened with **lignin**. It possesses **simple pits**. Fibres are **supporting tissues**. They provide **mechanical strength** to the plants and protect them from the strong winds. The fibres that are found in the seed coat of some seeds are called **surface fibres**. eg. cotton.

### *Complex tissue*

A tissue that consists of several kinds of cells but all of them function together as a single unit is called **complex tissue**. It is of two types – **xylem** and **phloem**.

### *Xylem*

Xylem (Greek word ‘**xylos**’ = **wood**) is a complex tissue that is mainly responsible for the conduction of water and mineral salts from roots to other parts of the plant. The xylem, which is derived from **procambium**, is called **primary xylem** and the xylem, which is derived from **vascular cambium**, is called **secondary xylem**. Earlier formed xylem elements are called **protoxylem**, whereas the later formed xylem elements are called

**metaxylem.** Xylem is made up of four kinds of cells - **tracheids, vessels or tracheae, xylem fibres and xylem parenchyma.**

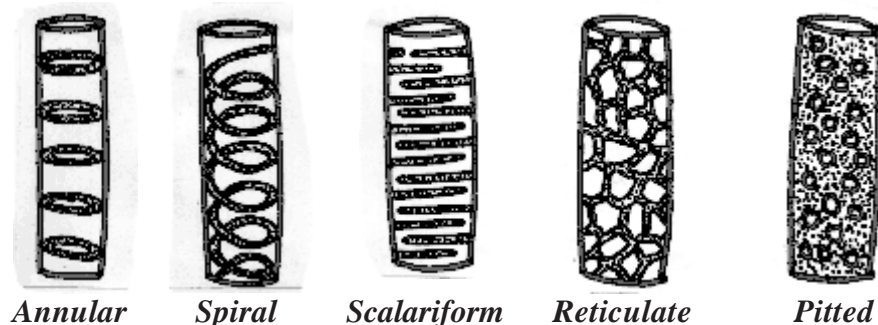
### ***Tracheids***

*Tracheids* are elongated with **blunt ends.** Its lumen is broader than that of fibres. Their secondary wall is **lignified.** In cross section, the tracheids appear **polygonal and thick walled.** The pits are **simple or bordered.** There are different types of cell wall thickening due to deposition of secondary wall substances. They are **annular** (ring like), **spiral** (spring like), **scalariform** (ladder like), **reticulate** (net like) and **pitted** (uniformly thick except at pits). Tracheids are imperforate cells with bordered pits on their end walls. They are arranged one above the other. Tracheids are chief water conducting elements in **gymnosperms and pteridophytes.** Here, the **conduction of water and mineral salts** takes place through the bordered pits. They also offer **mechanical support** to the plants.

### ***Vessels or Tracheae***

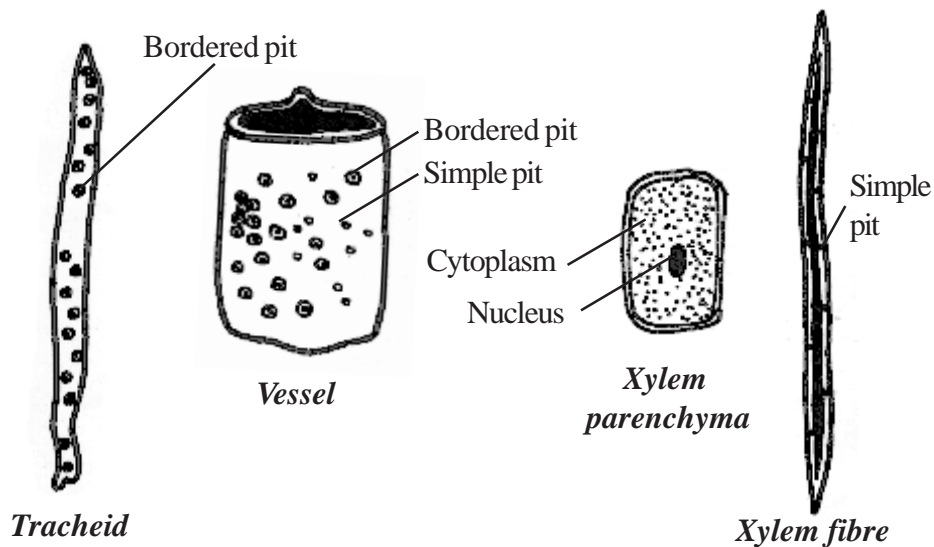
Vessels are **perforated** at the end walls. Its lumen is wider than that of tracheids. The perforated plates at the end wall separate the vessels. They occur parallel to the long axis of the plant body. Due to dissolution of entire end wall, a single pore is formed at the perforation plate. It is called **simple perforation plate** eg. *Mangifera*. If the perforation plate has many pores, then it is called **multiple perforation plate.** eg. *Liriodendron*.

The secondary wall thickenings of vessels are **annular, spiral, scalariform, reticulate, or pitted** as in tracheids. Vessels are chief water



**Fig. 2.5. Types of secondary wall thickenings in tracheids**





*Fig. 2.6. Kinds of xylem cells*

conducting elements in **angiosperms** and they are absent in **pteridophytes and gymnosperms**. However, in *Gnetum* of gymnosperms, vessels occur. The main function of vessel is **conduction of water and minerals**. It also offers **mechanical strength** to the plant.

#### *Xylem fibres*

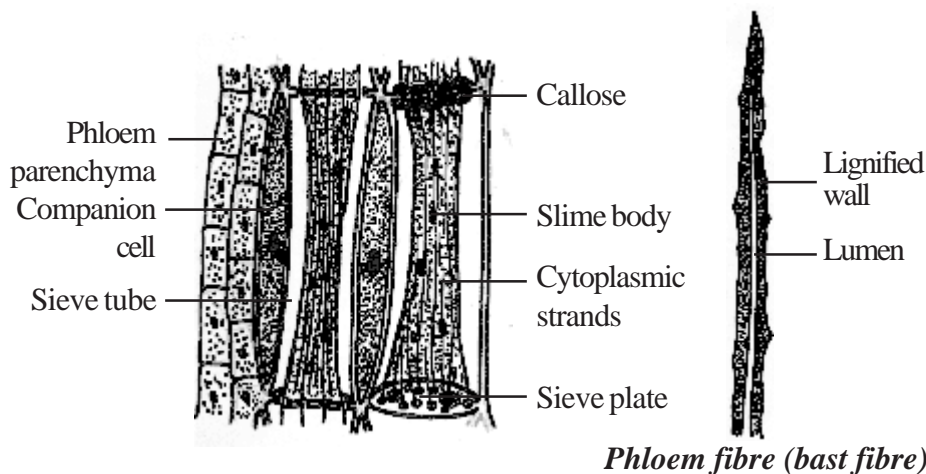
The fibres of sclerenchyma associated with the xylem are known as **xylem fibres**. They give additional **mechanical support** to the plant body. They are present both in primary and secondary xylem. Xylem fibres are **dead cells** and have **lignified walls** with **narrow lumen**. Xylem fibres are also called **libriform fibres**.

#### *Xylem parenchyma*

The parenchyma cells associated with the xylem are known as **xylem parenchyma**. Xylem parenchyma is the only living tissue amongst the constituents of xylem. The cell wall is **thin** and made up of **cellulose**. The xylem parenchyma cells **store food reserves** in the form of **starch** and **fat**. They also assist in **conduction of water**.

## *Phloem*

Like xylem, phloem is also a complex tissue. It **conducts food materials** to various parts of the plant. The phloem elements which are formed from the procambium of apical meristem are called **primary phloem**. The phloem elements which are produced by the vascular cambium are called **secondary phloem**. The primary phloem elements that develop first from the procambium are smaller in size called the **protophloem**, whereas those develop later are larger in size called **metaphloem**. The protophloem is short lived. It is crushed by the developing metaphloem.



*Fig. 2.7. Phloem tissue*

Phloem is composed of four kinds of cells: **sieve elements**, **companion cells**, **phloem parenchyma** and **phloem fibres**. Companion cells are present only in **angiosperms**. Companion cells are absent in pteridophytes and gymnosperms. Phloem fibres are absent in the primary phloem of most of the angiosperms. But they are usually present in the secondary phloem.

### *Sieve elements*

Sieve elements are the conducting elements of the phloem. They have thick primary walls. Their end walls are transverse or oblique. The end wall contains a number of pores and it looks like a sieve. So it is called a **sieve plate**. The sieve elements are arranged one above the other and form vertical sieve tubes. In matured sieve tube, **nucleus is absent**. It contains

a lining layer of cytoplasm. This is an important feature of sieve elements. A special protein called slime body is seen in it. The conduction of food material takes place through cytoplasmic strands. They are distinguished into **sieve cells** and **sieve tubes**. Sieve cells occur in **pteridophytes** and **gymnosperms**, while sieve tubes occur in **angiosperms**.

Sieve cells have sieve areas on their lateral walls only and are not arranged one above the other in linear rows. They are not associated with companion cells. Sieve tubes are arranged one above the other in linear rows and have sieve plates on their end walls. They are associated with the companion cells. In mature sieve elements, sometimes the pores in the sieve plate are blocked by a substance called **callose**.

#### *Companion cells*

The thin-walled, elongated, specialised parenchyma cells, which are associated with the sieve elements, are called **companion cells**. In contrast to sieve elements, the companion cells have cytoplasm and a **prominent nucleus**. They are connected to the sieve tubes through pits found in the lateral walls. The companion cells are present only in angiosperms and absent in gymnosperms and pteridophytes. They assist the sieve tubes in the conduction of food materials.

#### *Phloem parenchyma*

The parenchyma cells associated with the phloem are called **phloem parenchyma**. These are **living cells**. They store **starch** and **fats**. They also contain **resins** and **tannins** in some plants. They are present in all , **pteridophytes**, **gymnosperms** and **dicots**. In **monocots**, usually phloem parenchyma is absent.

#### *Phloem fibres*

The fibres of sclerenchyma associated with phloem are called **phloem fibres** or **bast fibres**. They are narrow, vertically elongated cells with very thick walls and a small lumen (the cell cavity). Among the four kinds of phloem elements, phloem fibres are the only dead tissue. These are the strengthening and supporting cells.

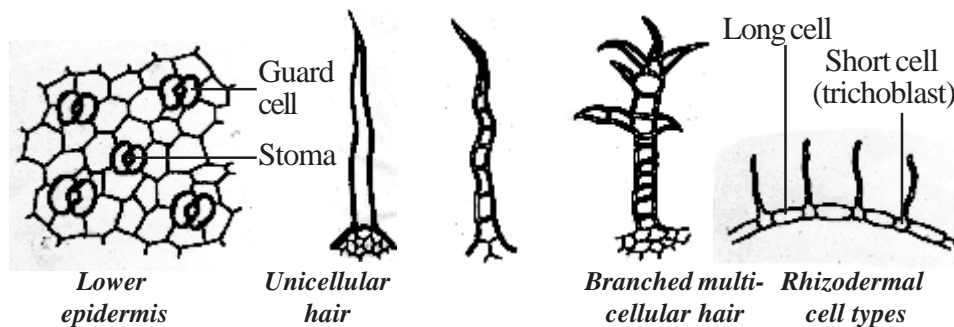
#### *The tissue system*

A group of tissues performing a similar function irrespective of its position in the plant body is called a **tissue system**. In 1875, **Sachs**

recognized three tissue systems in the plants. They are **epidermal tissue system**, **vascular tissue system** and **fundamental tissue system**.

### *Epidermal tissue system*

Epidermal tissue system is the outermost covering of plants. It consists of epidermis, stomata and epidermal outgrowths. **Epidermis** is generally composed of single layer of parenchymatous cells compactly arranged without intercellular spaces. But it is interrupted by stomata. In leaves some specialized cells which surround the stomata are called the guard cells. Chloroplasts are present only in the guard cells of the epidermis. Other epidermal cells usually do not have chloroplasts. The outer wall of epidermis is usually covered by **cuticle**.



*Fig. 2.8. Epidermal tissue system*

**Stoma** is a minute pore surrounded by two guard cells. The stomata occur mainly in the epidermis of leaves. In some plants such as sugarcane, the guard cells are bounded by some special cells. They are distinct from other epidermal cells. These cells are called **subsidiary** or **accessory cells**. Trichomes and root hairs are some **epidermal outgrowths**. The unicellular or multicellular appendages that originate from the epidermal cells are called **trichomes**. Trichomes may be branched or unbranched. Rhizodermis has two types of epidermal cells - long cells and short cells. The short cells are called **trichoblasts**. Root hairs are produced from these trichoblasts.

### *Functions of epidermal tissue system*

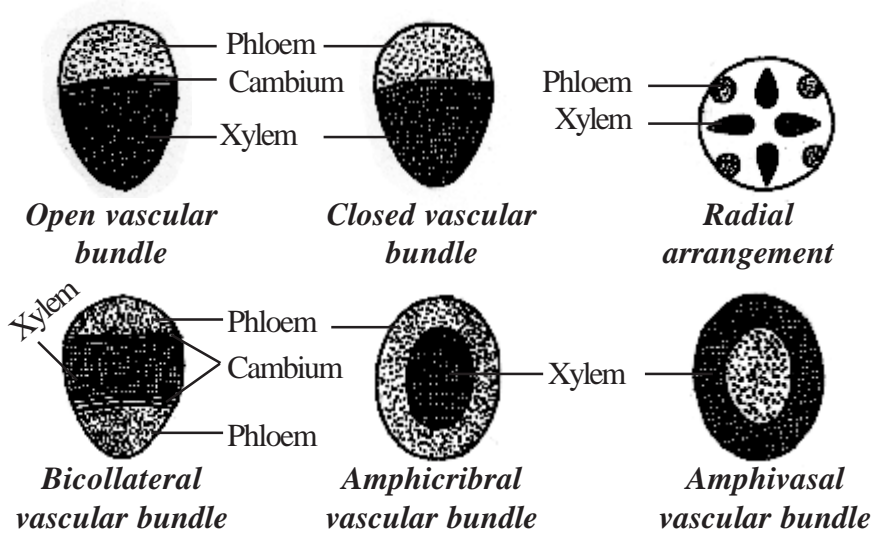
1. This tissue system in the shoot checks excessive loss of water due to the presence of cuticle.

2. Epidermis protects the underlying tissues.
3. Stomata involve in transpiration and gaseous exchange.
4. Trichomes are also helpful in the dispersal of seeds and fruits.
5. Root hairs absorb water and mineral salts from the soil.

### *Vascular tissue system*

The vascular tissue system consists of **xylem** and **phloem**. The elements of xylem and phloem are always organized in groups. They are called **vascular bundles**. In dicot stem, the vascular bundle consists of cambial tissue in between xylem and phloem. Such vascular bundle is called **open** vascular bundle. In monocot stem, cambium is absent in the vascular bundle, hence it is known as **closed** vascular bundle

In roots, xylem and phloem are arranged in an alternate manner on different radii. It is called **radial arrangement**. In stems and leaves, xylem and phloem are arranged at the same radius and form a vascular bundle together. Such vascular bundle is called **conjoint vascular bundle**. Depending upon the **mutual relationship** of xylem and phloem, conjoint vascular bundles are divided into three types. They are collateral, bicollateral and concentric.



**Fig. 2.9. Various types of vascular bundles**

If xylem and phloem in a vascular bundle are arranged along the same radius with phloem towards the outside, such vascular bundle is called **collateral vascular bundle**. If phloem occurs on both the outer and inner sides of xylem, the bundle is called **bicollateral**. Bicollateral vascular bundles are most typically seen in **Cucurbitaceae**.

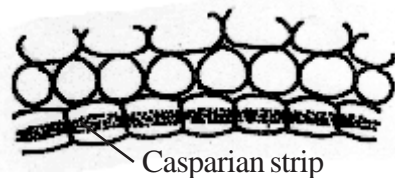
The bundle in which either phloem surrounds the xylem or xylem surrounds the phloem completely is known as **concentric vascular bundle**. This is of two types **amphicribal** and **amphivasal**. In **amphicribal concentric vascular bundles**, the phloem completely surrounds the xylem. eg. *Polypodium*. In **amphivasal concentric vascular bundles**, the xylem completely surrounds the phloem. eg. *Acorus*. In roots, protoxylem vessels are present towards the periphery and the metaxylem vessels towards the centre. This arrangement of xylem is called **exarch**. In stem, protoxylem vessels are towards the centre, while metaxylem towards the periphery. This condition is known as **endarch**.

#### *Ground or fundamental tissue system*

The ground or fundamental tissue system constitutes the main body of the plants. It includes all the tissues except epidermis and vascular bundles. In **monocot stem**, ground tissue system is a continuous mass of parenchymatous tissue in which vascular bundles are found scattered. Here ground tissue is not differentiated into cortex, endodermis, pericycle and pith. Generally in dicot stem, ground tissue system is differentiated into three main zones - **cortex**, **pericycle** and **pith**.

The **cortex** occurs between the epidermis and pericycle. Cortex may be a few to many layers in thickness. In most cases, cortex is made up of parenchyma tissues. Intercellular spaces may or may not be present..

Cortical cells may contain non-living inclusions like **starch grains**, **oils**, **tannins** and **crystal**.



**Fig. 2.10. Endodermal cells with casparian strips**

In the **leaves**, the ground tissue consists of chlorenchyma tissues. This region is called **mesophyll**. The inner most layer of the cortex is called **endodermis**. Generally endodermis is

made up of **barrel shaped** parenchyma cells. These cells are arranged in a **single layer without intercellular spaces**. **Pericycle** occurs between the endodermis and the vascular bundles. It is generally made up of parenchyma cells. **Lateral roots** originate from the pericycle. Thus their origin is **endogenous**. The central part of the ground tissue is known as **pith** or **medulla**. Generally this is made up of thin walled **parenchyma cells** which may be with or without intercellular spaces. The cells in the pith generally store **starch, fatty substances, tannins, phenols, calcium oxalate crystals**, etc.

### Self evaluation

#### I. Choose and write the correct options.

1. The change from meristematic tissue to permanent tissue is called
  - a. differentiation.
  - b. self perpetuating
  - c. photosynthesis.
  - d. cell division.
2. The type of tissue presents in the petioles of banana and *Canna*, is
  - a. stellate parenchyma
  - b. prosenchyma
  - c. aerenchyma
  - d. chlorenchyma.
3. The tissue generally present in all organs of plant is
  - a. parenchyma
  - b. chlorenchyma
  - c. collenchyma
  - d. sclerenchyma
4. The lamellar collenchyma is seen in the hypodermis of
  - a. *Datura*
  - b. *Helianthus*
  - c. *Ipomoea*
  - d. *Nicotiana*
5. The root hairs are produced from
  - a. rhizodermis
  - b. trichomes
  - c. accessory cells
  - d. trichoblasts
6. The osteosclereids are seen in
  - a. seed coat of *Crotalaria*
  - b. seed coat of *Pisum*
  - c. pulp of *Pyrus*
  - d. petioles of banana
7. Bicollateral vascular bundles are seen in the members of
  - a. Malvaceae
  - b. Musaceae
  - c. Solanaceae
  - d. Cucurbitaceae

**II. Answer the following questions in two or three sentences.**

8. Define plant anatomy.
9. Define a tissue.
10. What is differentiation?
11. What is an aerenchyma? State its function.
12. What are called macrosclereids? Give an example.
13. What is called callose?
14. What are called trichoblasts?
15. What are called guard cells?
16. What is a meristematic tissue?
17. What are called lateral meristems?
18. Define a permanent tissue.
19. What are the types of simple tissues and complex tissues?
20. What is a stellate parenchyma?
21. What is a chlorenchyma?
22. Differentiate angular collenchyma from lacunate collenchyma.
23. Differentiate sclereids from fibres.
24. What are brachy sclereids?
25. What are surface fibres?

**III. Answer the following questions in about 100 words.**

26. Bring out the characters of meristematic cells.
27. Explain different types of meristems based on their positions.
28. Write short notes on tracheids.
29. Write short notes on vessels.

**IV. Answer the following questions in about 200 words.**

30. Write an essay on the location, structure and functions of parenchyma.
31. Describe the location, structure and functions of collenchyma.
32. Give an account on sclerenchyma.
33. Write an essay on xylem tissues.
34. Describe the four kinds of cells found in phloem tissues.
35. Write an essay on the epidermal tissue system.
36. Describe the vascular tissue system.
37. Describe ground tissue system.



## 2.2. Anatomy of monocot and dicot roots

The embryo develops into an adult plant with roots, stem and leaves due to the activity of the apical meristem. A mature plant has three kinds of tissue systems - **the dermal, the fundamental and the vascular system.**

The **dermal system** includes the epidermis, which is the primary outer protective covering of the plant body. The **periderm** is another protective tissue that supplants the epidermis in the roots and stems that undergo secondary growth. **The fundamental tissue system** includes tissues that form the ground substance of the plant in which other permanent tissues are found embedded. Parenchyma, collenchyma and sclerenchyma are the main ground tissues. **The vascular system** contains the two conducting tissues, the phloem and xylem. In different parts of the plants, the various tissues are distributed in characteristic patterns. This is best understood by studying their internal structure by cutting sections (transverse or longitudinal or both) of the part to be studied.

### *Primary structure of monocotyledonous root - Maize root*

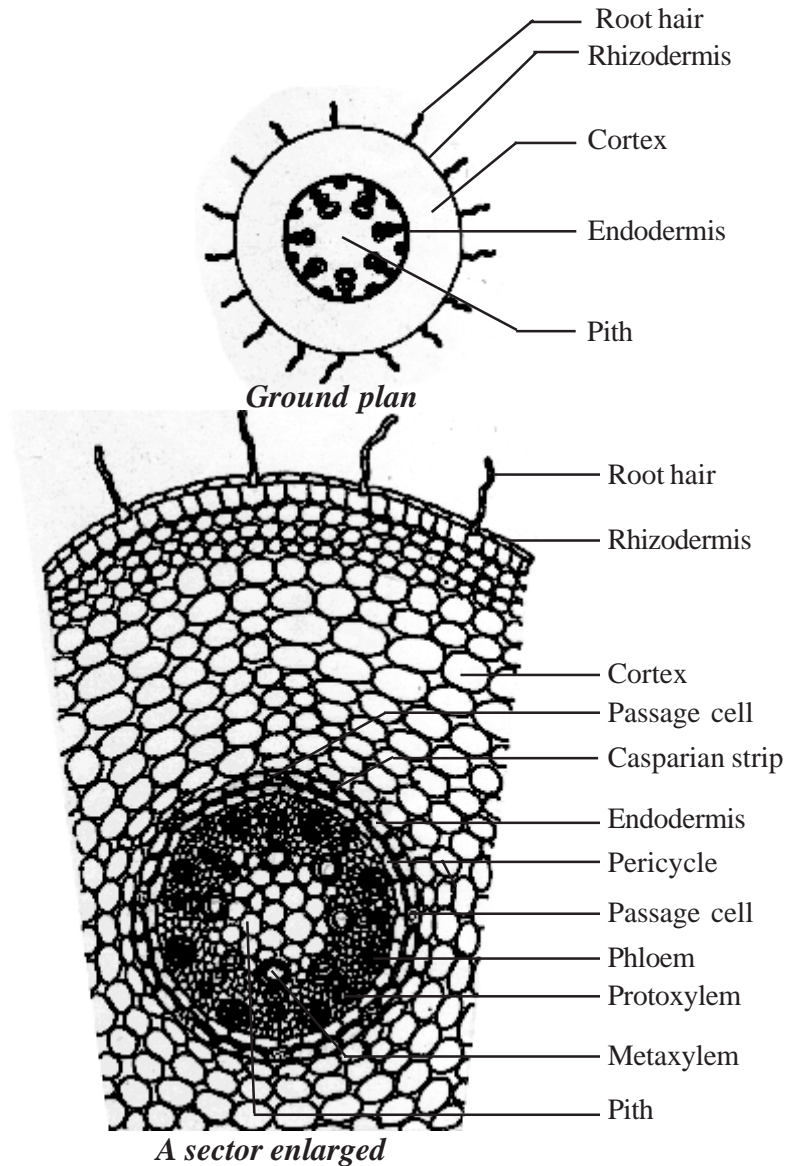
The internal structure of the monocot roots shows the following tissue systems from the periphery to the centre. They are **epiblema or rhizodermis, cortex and stele.**

#### *Rhizodermis or epiblema*

It is the outermost layer of the root. It consists of a single row of thin-walled parenchymatous cells without any intercellular space. **Stomata and cuticle** are absent in the rhizodermis. Root hairs that are found in the rhizodermis are always unicellular. They absorb water and mineral salts from the soil. Root hairs are generally short lived. The main function of rhizodermis is **protection** of the inner tissues.

#### *Cortex*

The cortex is **homogenous**. i.e. the cortex is made up of only one type of tissue called parenchyma. It consists of many layers of thin-walled parenchyma cells with lot of **intercellular spaces**. The function of cortical cells is **storage**. Cortical cells are generally **oval** or **rounded** in shape. Chloroplasts are absent in the cortical cells, but they store starch. The cells are living and possess leucoplasts. The inner most layer of the cortex is **endodermis**. It is composed of single layer of **barrel shaped**



*Fig. 2.11. T.S. of Maize root*

parenchymatous cells. This forms a complete ring around the stele. There is a band like structure made of suberin present in the radial and transverse walls of the endodermal cells. They are called **Casparian strips** named after **Casparay** who first noted the strips.

The endodermal cells, which are opposite to the protoxylem elements, are thin-walled without casparian strips. These cells are called **passage cells**. Their function is to transport water and dissolved salts from the cortex to the xylem. Water cannot pass through other endodermal cells due to casparian strips. The main function of casparian strips in the endodermal cells is to prevent the re-entry of water into the cortex once water entered the xylem tissue.

### *Stele*

All the tissues inside the endodermis comprise the stele. This includes **pericycle, vascular system and pith**.

### *Pericycle*

Pericycle is the outermost layer of the stele and lies inner to the endodermis. It consists of a single layer of parenchymatous cells.

### *Vascular System*

Vascular tissues are seen in **radial arrangement**. The number of protoxylem groups is many. This arrangement of xylem is called **polyarch**. Xylem is in **exarch** condition. The tissue, which is present between the xylem and the phloem, is called **conjunctive tissue**. In maize, the conjunctive tissue is made up of sclerenchymatous tissue.

### *Pith*

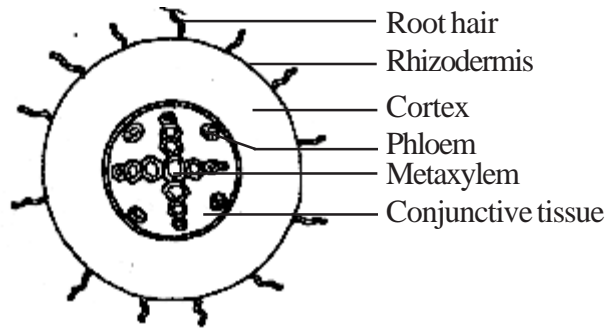
The central portion is occupied by a large pith. It consists of thin-walled parenchyma cells with intercellular spaces. These cells are filled with abundant starch grains.

### *Primary structure of dicotyledonous root - Bean root*

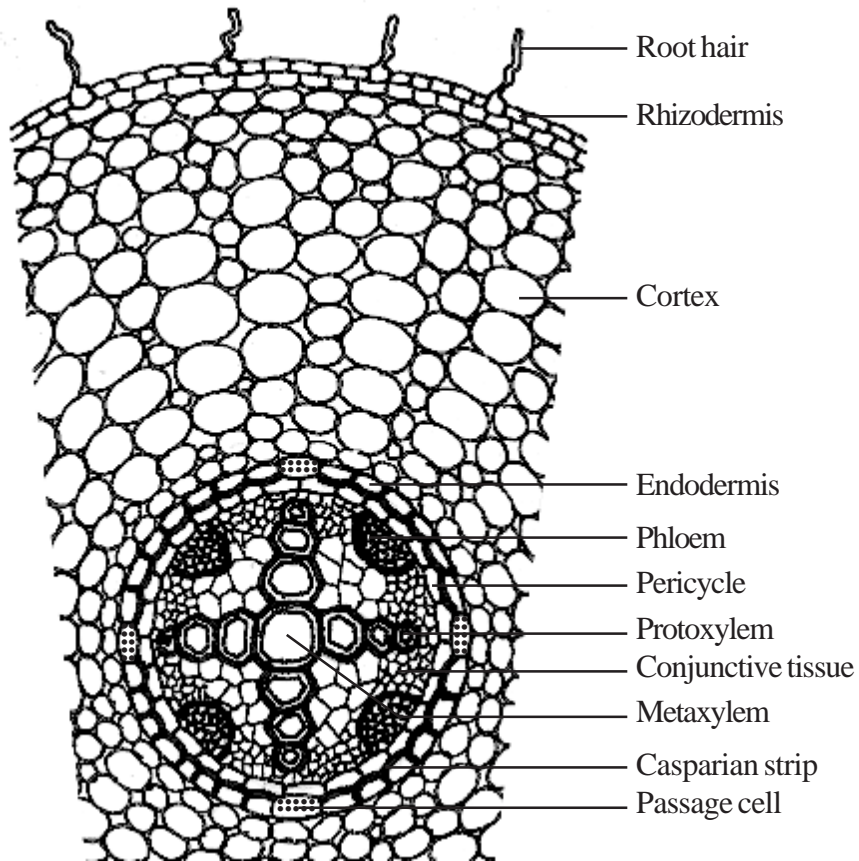
The transverse section of the dicot root (Bean) shows the following plan of arrangement of tissues from the periphery to the centre.

### *Rhizodermis or epiblema*

The outermost layer of the root is known as rhizodermis. It is made up of a single layer of parenchyma cells which are arranged compactly without intercellular spaces. It is devoid of stomata and cuticle. Root hair is always single celled. It absorbs water and mineral salts from the soil. The chief function of rhizodermis is protection.



*Ground plan*



*A sector enlarged*

*Fig. 2.12 T.S. of Bean root*

### *Cortex*

Cortex consists of only parenchyma cells. These cells are loosely arranged with intercellular spaces to make gaseous exchange easier. These cells may store food reserves. The cells are oval or rounded in shape. Sometimes they are polygonal due to mutual pressure. Though chloroplasts are absent in the cortical cells, starch grains are stored in them. The cells also possess leucoplasts.

The inner most layer of the cortex is **endodermis**. Endodermis is made up of single layer of barrel shaped parenchymatous cells. Stele is completely surrounded by the endodermis. The radial and the inner tangential walls of endodermal cells are thickened with suberin. This thickening was first noted by **Casparay**. So these thickenings are called **Casparian strips**. But these casparian strips are absent in the endodermal cells which are located opposite to the protoxylem elements. These thin-walled cells without casparian strips are called **passage cells** through which water and mineral salts are conducted from the cortex to the xylem elements. Water cannot pass through other endodermal cells due to the presence of casparian thickenings.

### *Stele*

All the tissues present inside endodermis comprise the stele. It includes **pericycle and vascular system**.

### *Pericycle*

Pericycle is generally a single layer of parenchymatous cells found inner to the endodermis. It is the outermost layer of the stele. Lateral roots originate from the pericycle. Thus, the lateral roots are **endogenous** in origin.

### *Vascular system*

Vascular tissues are in **radial arrangement**. The tissue by which xylem and phloem are separated is called **conjunctive tissue**. In bean, the conjunctive tissue is composed of parenchymatous tissue. Xylem is in **exarch** condition. The number of protoxylem points is four and so the xylem is called **tetrarch**. Each phloem patch consists of sieve tubes, companion cells and phloem parenchyma. Metaxylem vessels are generally polygonal in shape. But in monocot roots they are circular.

*Difference between monocot and dicot root*

| <b>Monocot roots</b>   | <b>Dicot roots</b>  |
|--|---|
| 1. Xylem is <b>polyarch</b> .  | 1. Xylem is usually <b>tetrarch</b> .                                 |
| 2. Pith is usually large at the centre.                              | 2. Pith is usually absent.  |
| 3. Metaxylem vessels are generally <b>circular</b> in cross section. | 3. Metaxylem vessels are generally <b>polygonal</b> in cross section. |
| 4. Conjunctive tissue is sclerenchymatous in Maize.                  | 4. Conjunctive tissue is usually parenchymatous.                      |
| 5. There is no secondary growth.                                     | 5. Secondary growth is generally present.                             |

**Self evaluation**

*I. Choose and write the correct options.*

1. The root hairs originate from
  - a. trichoblasts
  - b. endodermis
  - c. hypodermis
  - d. pericycle.
2. The Casparian strips are found in the endodermis of
  - a. dicot stem
  - b. dicot root
  - c. monocot stem
  - d. dicot leaf.
3. The passage cells are found in endodermis of
  - a. dicot stem
  - b. monocot stem
  - c. dicot root
  - d. dicot leaf.
4. The polyarch condition is found in
  - a. monocot leaf
  - b. dicot leaf
  - c. dicot stem
  - d. monocot root
5. The inner most layer of the cortex is
  - a. epidermis
  - b. hypodermis
  - c. endodermis
  - d. pericycle

**II. Answer the following questions in two or three sentences.**

6. What are called casparian strips?
7. What are called passage cells?
8. What is a rhizodermis?

**III. Answer the following questions in about 100 words.**

9. Draw and label the parts of transverse section of monocot root.
10. Draw the transverse section of dicot root and label the parts.
11. Distinguish the anatomy of dicot roots from monocot roots.

**IV. Answer the following questions in about 200 words.**

12. Describe the primary structure of a dicot root.
13. Describe the primary structure of a monocot root.

### 2.3. Anatomy of monocot and dicot stems

#### *Primary structure of monocot stem - Maize stem*

The outline of the maize stem in transverse section is more or less circular. Internal structure of monocotyledonous stem reveals epidermis, hypodermis, ground tissue and vascular bundles.

#### *Epidermis*

It is the outermost layer of the stem. It is made up of single layer of tightly packed parenchymatous cells. Their outer walls are covered with thick cuticle. The continuity of this layer may be broken here and there by the presence of a few stomata. There are no epidermal outgrowths.

#### *Hypodermis*

A few layer of sclerenchymatous cells lying below the epidermis constitute the hypodermis.. This layer gives mechanical strength to the plant. It is interrupted here and there by chlorenchyma cells.

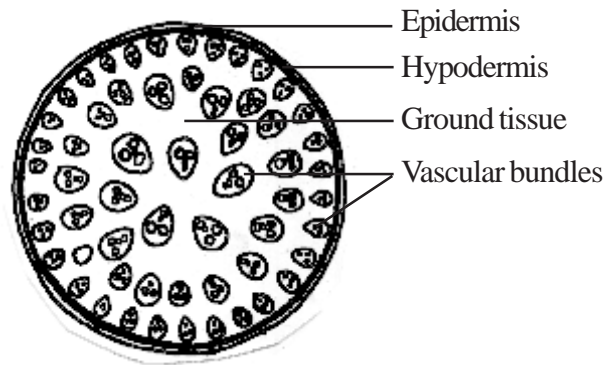
#### *Ground tissue*

There is no distinction into cortex, endodermis, pericycle and pith. The entire mass of parenchymatous cells lying inner to the hypodermis forms the ground tissue. The cell wall is made up of cellulose. The cells contain reserve food material like starch. The cells of the ground tissue next to the hypodermis are smaller in size, polygonal in shape and compactly arranged. Towards the centre, the cells are loosely arranged, rounded in shape and bigger in size. The vascular bundles lie embedded in this tissue. The ground tissue stores food and performs gaseous exchange..

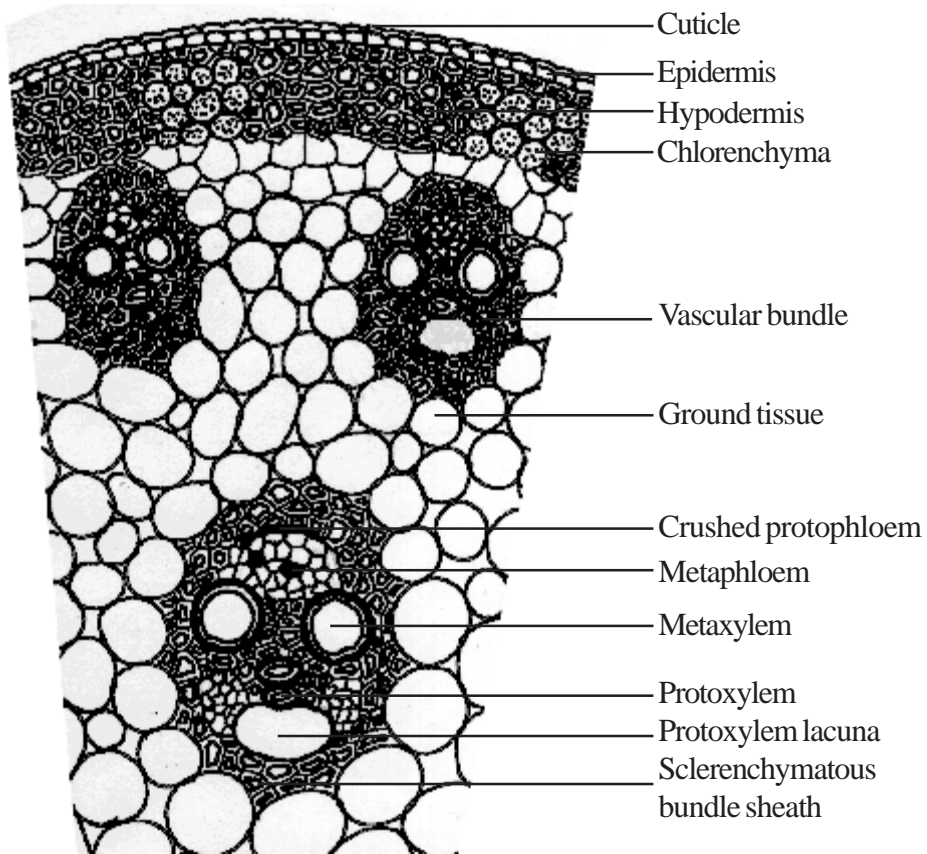
#### *Vascular bundles*

Vascular bundles are scattered in the parenchymatous ground tissue. Each vascular bundle is surrounded by a sheath of sclerenchymatous fibres called bundle sheath. The vascular bundles are **conjoint, collateral, endarch** and **closed**. Vascular bundles are numerous, small and closely arranged in the peripheral portion. Towards the centre, the bundles are comparatively large in size and loosely arranged. Vascular bundles are **skull shaped**.





*Ground plan*



*A sector enlarged*

*Fig. 2.13 T.S. of a Maize stem*

### *Phloem*

The phloem in the monocot stem consists of sieve tubes and companion cells. Phloem parenchyma and phloem fibres are absent. It can be distinguished into an outer crushed protophloem and an inner metaphloem.

### *Xylem*

Xylem vessels are arranged in the form of the letter 'Y'. The two metaxylem vessels are located at the upper two arms and one or two protoxylem vessels at the base. In a mature bundle, the lowest protoxylem disintegrates and forms a cavity known as **protoxylem lacuna**.

### *Primary structure of dicotyledonous stem - Sunflower stem*

Internal structure of dicotyledonous stem reveals **epidermis, cortex and stele**.

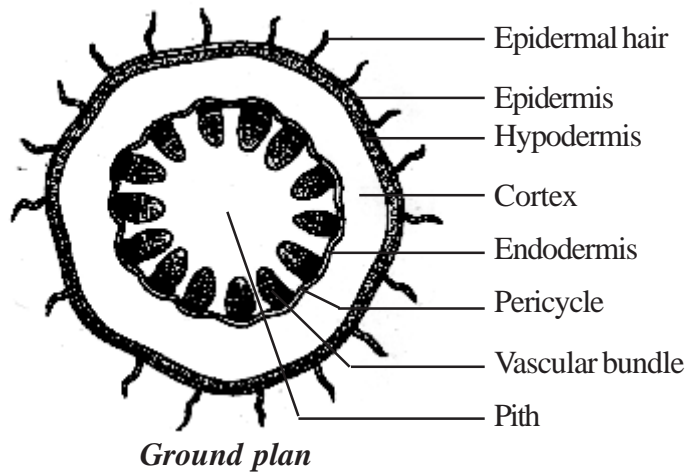
### *Epidermis*

It is protective in function and forms the outermost layer of the stem. It is a single layer of parenchymatous rectangular cells. The cells are compactly arranged without intercellular spaces. The outer walls of the epidermal cells have a layer called cuticle. The cuticle checks the transpiration. The cuticle is made up of a waxy substance known as cutin. Stomata may be present here and there. Epidermal cells are living. Chloroplasts are usually absent. A large number of multicellular hairs occur on the epidermis.

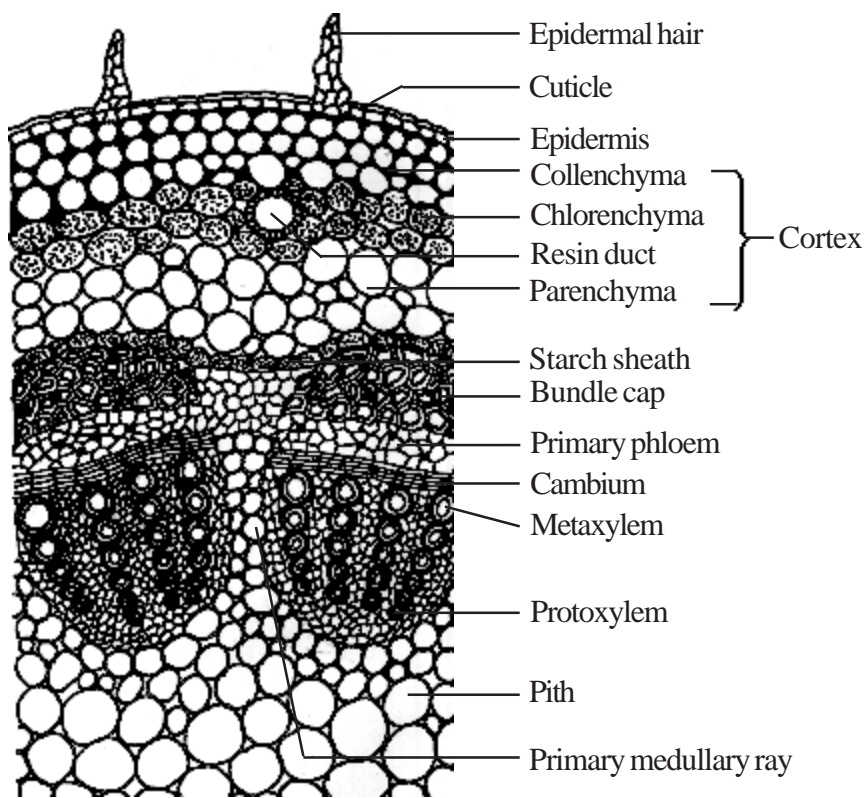
### *Cortex*

Cortex lies below the epidermis. The cortex is differentiated into three zones. Below the epidermis, there are a few layers of collenchyma cells. This zone is called **hypodermis**. It gives mechanical strength to the stem. These cells are living and thickened at the corners. Inner to the hypodermis, a few layers of chlorenchyma cells are present with conspicuous intercellular spaces. This region performs photosynthesis. Some resin ducts also occur here. The third zone is made up of parenchyma cells. These cells store food materials.

The innermost layer of the cortex is called **endodermis**. The cells of this layer are barrel shaped and arranged compactly without intercellular



*Ground plan*



*A sector enlarged*

*Fig. 2.14 T.S. of Sunflower stem*

spaces. Since starch grains are abundant in these cells, this layer is also known as **starch sheath**. This layer is morphologically homologous to the endodermis found in the root. In most of the dicot stems, endodermis with casparian strips is not developed.

### *Stele*

The central part of the stem inner to the endodermis is known as stele. It consists of pericycle, vascular bundles and pith. In dicot stem, vascular bundles are arranged in a ring around the pith. This type of stele is called **eustele**.

### *Pericycle*

Pericycle is the layers of cells that occur between the endodermis and vascular bundles. In the stem of sunflower (*Helianthus*), a few layers of sclerenchyma cells occur in patches outside the phloem in each vascular bundle. This patch of sclerenchyma cells is called **bundle cap** or **hard bast**. The bundle caps and the parenchyma cells between them constitute the pericycle in the stem of sunflower.

### *Vascular bundles*

The vascular bundles consist of xylem, phloem and cambium. Xylem and phloem in the stem occur together and form the vascular bundles. These vascular bundles are **wedge shaped**. They are arranged in the form of a ring. Each vascular bundle is **conjoint, collateral, open** and **endarch**.

### *Phloem*

Primary phloem lies towards the periphery. It consists of protophloem and metaphloem. Phloem consists of sieve tubes, companion cells and phloem parenchyma. Phloem fibres are absent in the primary phloem. Phloem conducts organic food materials from the leaves to other parts of the plant body.

### *Cambium*

Cambium consists of brick shaped and thin walled meristematic cells. It is two to three layers in thickness. These cells are capable of forming new cells during secondary growth.

### *Xylem*

Xylem consists of xylem fibres, xylem parenchyma, vessels and tracheids. Vessels are thick walled and arranged in a few rows. Xylem conducts water and minerals from the root to the other parts of the plant body.

### *Pith*

The large central portion of the stem is called pith. It is composed of parenchyma cells with intercellular spaces. The pith is also known as **medulla**. The pith extends between the vascular bundles. These extensions of the pith between the vascular bundles are called **primary pith rays** or **primary medullary rays**. Function of the pith is storage of food.

#### *Anatomical differences between dicot stem and monocot stem*

| <b>Dicot stem</b>   | <b>Monocot stem</b>  |
|---|--|
| 1. Hypodermis is made up of collenchymatous cells.                              | 1. Hypodermis is made up of sclerenchymatous cells.                                |
| 2. Ground tissue is differentiated into cortex, endodermis, pericycle and pith. | 2. Ground tissue is not differentiated, but it is a continuous mass of parenchyma. |
| 3. Starch sheath is present.  | 3. Starch sheath is absent.  |
| 4. Pith is present.   | 4. Pith is absent.   |
| 5. Pericycle is present.  | 5. Pericycle is absent.  |
| 6. Medullary rays are present.  | 6. Medullary rays are absent.  |
| 7. Vascular bundles are open.   | 7. Vascular bundles are closed.  |
| 8. Vascular bundles are arranged in a ring.                                     | 8. Vascular bundles are scattered in the ground tissue.                            |
| 9. Bundle cap is present.   | 9. Bundle sheath is present.   |
| 10. Protoxylem lacuna is absent.  | 10. Protoxylem lacuna is present.  |
| 11. Phloem parenchyma is present.   | 11. Phloem parenchyma is absent.   |

## Self evaluation

### *I. Choose and write the correct options.*

1. The vascular bundle with protoxylem facing centre of the stem is
  - a. exarch
  - b. endarch
  - c. tetrarch
  - d. polyarch
2. When the xylem and the phloem lie in the same radius, the vascular bundle is called
  - a. conjoint
  - b. radial
  - c. open
  - d. closed.
3. The vascular bundles are skull shaped in
  - a. dicot root
  - b. monocot root
  - c. dicot stem
  - d. monocot stem.
- 4 The protoxylem lacuna is present in the vascular bundles of
  - a. dicot root
  - b. monocot root
  - c. dicot stem
  - d. monocot stem

### *II. Answer the following questions in two or three sentences.*

5. What is a hypodermis?
6. What is a protoxylem lacuna?
7. What is an eustele?

### *III. Answer the following questions in about 100 words.*

8. What is the nature of the vascular bundles in monocot stem?
9. Write short notes on the cortex in dicot stem.
10. Write short notes on the vascular bundles of the dicot stem.
11. Differentiate the vascular bundles of the dicot stem from that of monocot stem.
12. Draw and label the parts of a T.S. of a dicot stem.

### *IV. Answer the following questions in about 200 words.*

13. Write anatomical differences between dicot stem and monocot stem.
14. Describe the primary structure of a monocot stem.
15. Describe the primary structure of a dicot stem.

## 2.4. Anatomy of a dicot and monocot leaves

Leaves are very important vegetative organs because they are mainly concerned with photosynthesis and transpiration. Like stem and roots, leaves also have the three tissue systems - dermal, ground and vascular. The dermal tissue system consists of an upper epidermis and lower epidermis. Stomata occur in both the epidermis but more frequently in the lower epidermis. The ground tissue system that lies between the epidermal layers of leaf is known as mesophyll tissue. Often it is differentiated into palisade parenchyma on the adaxial (upper) side and spongy parenchyma on the abaxial (lower) side.

A leaf showing this differentiation in mesophyll is designated as **dorsiventral**. It is common in dicot leaves. If mesophyll is not differentiated like this in a leaf (i.e., made of only spongy or palisade parenchyma) as in monocots, it is called **isobilateral**. The mesophyll tissue, especially spongy parenchyma cells enclose a lot of air spaces. The presence of air spaces is a special feature of spongy cells. They facilitate the gaseous exchange between the internal photosynthetic tissue (mesophyll) and the external atmosphere through the stomata.

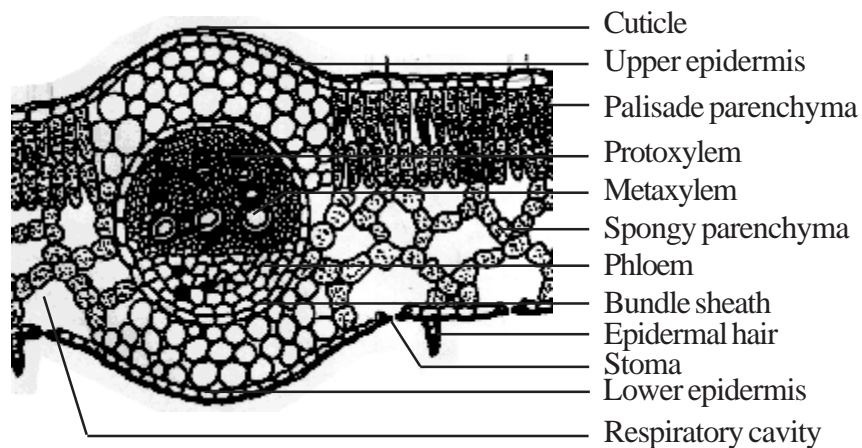
The vascular tissue system is composed of vascular bundles. They are collateral and closed. The vascular tissue forms the skeleton of the leaf and they are known as veins. The veins supply water and minerals to the photosynthetic tissue. Thus the morphological and anatomical features of the leaf help in its physiological functions.

### *Anatomy of a dicot leaf - Sunflower leaf*

Internal structure of dicotyledonous leaves reveals epidermis, mesophyll and vascular tissues.

#### *Epidermis*

A dicotyledonous leaf is generally **dorsiventral**. It has upper and lower epidermis. The epidermis is usually made up of a single layer of cells that are closely packed. The cuticle on the upper epidermis is thicker than that of lower epidermis. The minute openings found on the epidermis are called stomata. Stomata are more in number on the lower epidermis than on the upper epidermis. A stoma is surrounded by a pair of bean shaped cells called guard cells.



*Fig. 2.15 T.S. of sunflower leaf*

Each stoma opens into an air chamber. These guard cells contain chloroplasts, whereas other epidermal cells do not contain chloroplasts. The main function of the epidermis is to give protection to the inner tissue called mesophyll. The cuticle helps to check transpiration. Stomata are used for transpiration and gas exchange.

### ***Mesophyll***

The entire tissue between the upper and lower epidermis is called the mesophyll (*Gk meso* = in the middle; *phyllome* = leaf). There are two regions in the mesophyll. They are palisade parenchyma and spongy parenchyma. Palisade parenchyma cells are seen beneath the upper epidermis. It consists of vertically elongated cylindrical cells in one or more layers. These cells are compactly arranged without intercellular spaces. Palisade parenchyma cells contain more chloroplasts than the spongy parenchyma cells. The function of palisade parenchyma is photosynthesis. Spongy parenchyma lies below the palisade parenchyma. Spongy cells are irregularly shaped. These cells are very loosely arranged with numerous airspaces. As compared to palisade cells, the spongy cells contain lesser number of chloroplasts. Spongy cells facilitate the exchange of gases with the help of air spaces. The air space that is found next to the stoma is called **respiratory cavity** or **sub-stomatal cavity**.



### *Vascular tissues*

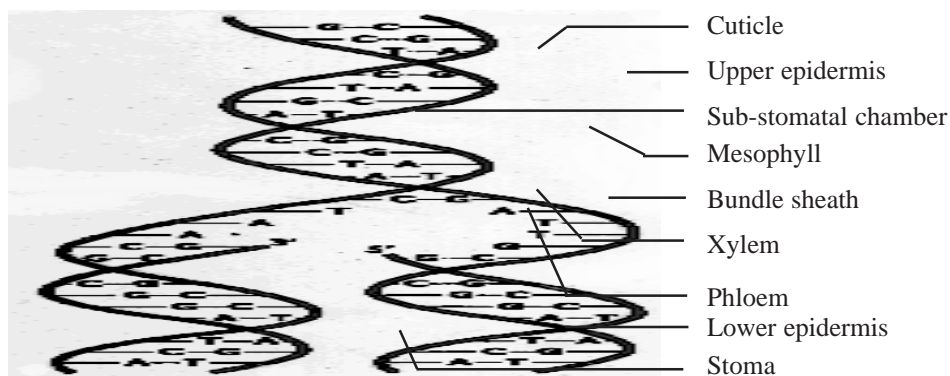
Vascular tissues are present in the veins of leaf. Vascular bundles are **conjoint, collateral and closed**. Xylem is present towards the upper epidermis, while the phloem towards the lower epidermis. Vascular bundles are surrounded by a compact layer of parenchymatous cells called **bundle sheath** or **border parenchyma**. Xylem consists of metaxylem vessels and protoxylem vessels. Protoxylem vessels are present towards the upper epidermis. Phloem consists of sieve tubes, companion cells and phloem parenchyma. Phloem fibres are absent. Xylem consists of vessels and xylem parenchyma. Tracheids and xylem fibres are absent.

### *Anatomy of a monocot leaf - Grass leaf*

A transverse section of a grass leaf reveals the following internal structures.

#### *Epidermis*

The leaf has upper and lower epidermis. They are made up of a single layer of thin walled cells. The outer walls are covered by thick cuticle. The number of stomata is more or less equal on both the epidermis. The stomata are surrounded by **dumb-bell shaped** guard cells. The guard cells contain chloroplasts, whereas the other epidermal cells do not have them. Some special cells bound the guard cells. They are distinct from other epidermal cells. These cells are called **subsidiary cells or accessory cells**. Some cells of upper epidermis are large and thin walled. They are called bulliform



*Fig. 2.16 T.S. of grass leaf*

cells or motor cells. These cells are helpful for the rolling and unrolling of the leaf according to the weather change. Some of the epidermal cells of the grass are filled with silica. They are called **silica cells**.

### ***Mesophyll***

The ground tissue that is present between the upper and lower epidermis of the leaf is called **mesophyll**. Here, the mesophyll is not differentiated into palisade and spongy parenchyma. All the mesophyll cells are nearly isodiametric and thin walled. It is for this reason, the grass leaf is described as **isobilateral**. These cells are compactly arranged with limited intercellular spaces. They contain numerous chloroplasts.

### ***Vascular bundles***

Vascular bundles differ in size. Most of the vascular bundles are smaller in size. Large bundles occur at regular intervals.

Two patches of sclerenchyma are present above and below the large vascular bundles. These sclerenchyma patches give mechanical support to the leaf. The small vascular bundles do not have such sclerenchymatous patches.

Vascular bundles are **conjoint, collateral and closed**. Each vascular bundle is surrounded by a parenchymatous bundle sheath. The cells of the bundle sheath generally contain starch grains. The xylem of the vascular bundle is located towards the upper epidermis and the phloem towards the lower epidermis.

### **Self evaluation**

#### ***I. Choose and write the correct options.***

1. Isobilateral leaf is present in
  - a. grass
  - b. *Cucurbita*
  - c. sunflower
  - d. bean
2. The vascular bundle in the leaf is
  - a. collateral and open
  - b. collateral and closed.
  - c. bicollateral and open
  - d. collateral and exarch

**II. Answer the following questions in two or three sentences.**

3. What is a dorsiventral leaf? Give an example.
4. What is an isobilateral leaf? Give an example.
5. What is a mesophyll?
6. What are stomata?
7. What are guard cells?
8. What are the functions of stomata?
9. Differentiate palisade parenchyma from spongy parenchyma.
10. What is a respiratory cavity or sub-stomatal cavity?
11. What is a bundle sheath or border parenchyma in a leaf?
12. What are the functions of veins in a leaf?
13. What are bulliform cells?
14. What are silica cells?

**III. Answer the following questions in about 100 words.**

15. Write short notes on the epidermis of a dicot leaf.
16. Write short notes on the vascular tissues of a dicot leaf.
17. Write short notes on the mesophyll of a dicot leaf.
18. Draw and label the parts of a T.S. of a dicot leaf.
19. Draw and label the parts of a T.S. of a monocot leaf.

**IV. Answer the following questions in about 200 words.**

20. Describe the internal structure of a dicot leaf.
21. Describe the internal structure of a monocot leaf.

## 2.5. Secondary growth in dicot stem

The primary structure of the plant body is caused by the activity of **apical meristems**. The primary permanent tissues produced by the apical meristems cause the growth in length and to some extent in thickness. This is called **primary growth**. Further thickness is observed mostly in dicot plants. This thickness is caused by the addition of new tissues by the activity of the lateral meristems like **vascular cambium** and **cork cambium**. The new tissues, which are formed by the lateral meristems, are called secondary tissues.

Thus the increase in thickness, due to the addition of secondary tissues by the activity of vascular cambium and phellogen in the stelar and cortical regions is called **secondary growth**. The process and the structures associated with the secondary growth in dicot stems are given below:

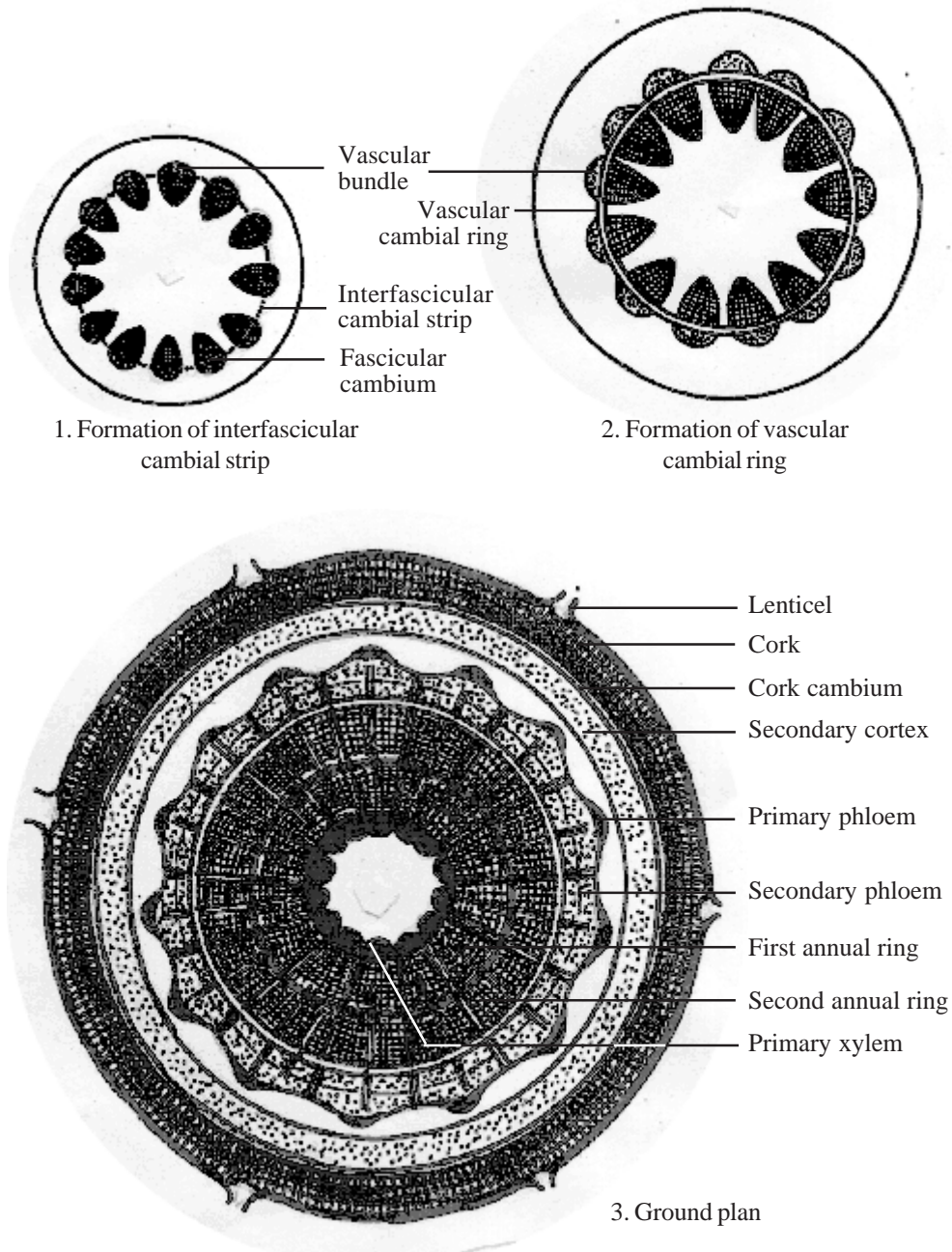
### *Formation of vascular cambial ring*

The cambium occurring between the xylem and the phloem in the vascular bundle, is called fascicular cambium. In between the vascular bundles, a few parenchymatous cells of the medullary rays that are in line with the fascicular cambium become meristematic and form a strip of cambium. It is called interfascicular cambium. This interfascicular cambium joins up with the fascicular cambium on both sides and forms a continuous ring. It is called a **vascular cambial ring**.

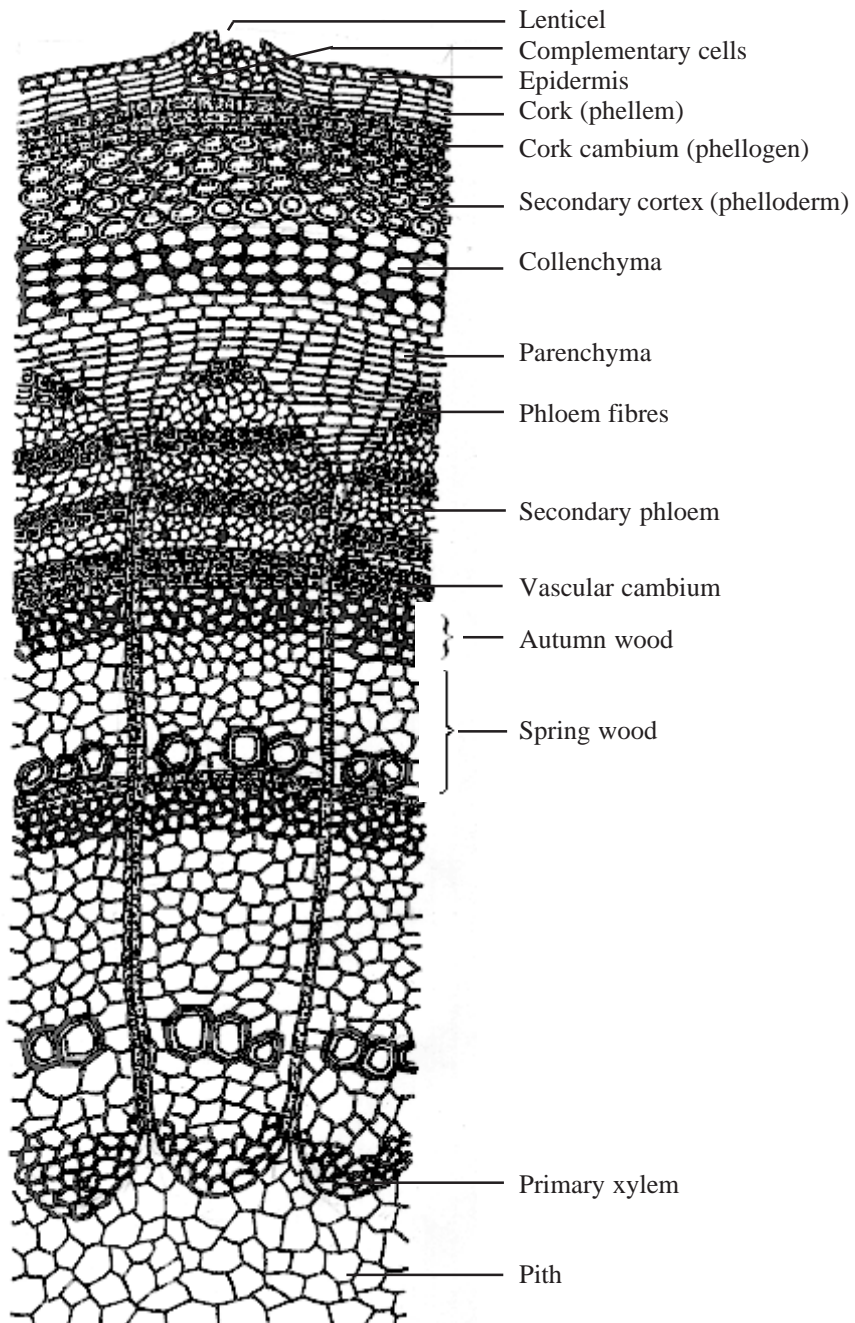
### *Formation of secondary tissues*

The vascular cambial ring becomes active and begins to cut off new cells both towards the inner and outer sides. The cells, which are cut off towards the outside, get differentiated into the secondary phloem, whereas those cut off on the inner side are differentiated into secondary xylem.

Secondary phloem consists of sieve tubes, companion cells, phloem parenchyma and phloem fibres. Secondary xylem occupies the major part of the woody stem. It consists of vessels, tracheids, xylem fibres and xylem parenchyma.



**Fig 2.17 Secondary growth in dicot stem**



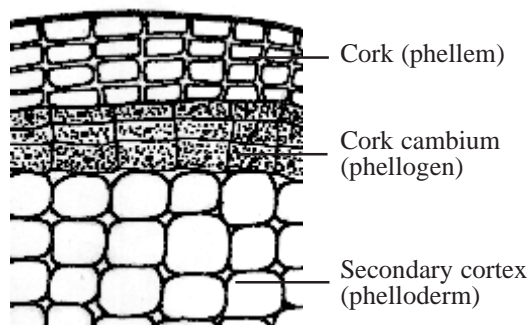
**Fig. 2.18 Secondary growth in a two-year old dicot stem  
A sector enlarged**



### *Formation of periderm*

As secondary vascular tissues are continuously added in the stellar region, pressure is exerted on the cortex and epidermis. So the epidermis gets ruptured and the cortex stretched. Then the secondary protective layer is developed. It is called **periderm**.

During the formation of this periderm, a few layers of meristematic tissue are formed in the cortex. This is called cork cambium or phellogen. The cells of the cork cambium cut off cells on both the sides. Those formed on the outside become suberised. This region is called **cork or phellem**. The cork cells are uniform in size and arranged in radial rows without intercellular spaces. These cells are dead at maturity. The cells that are cut off on the inner side of the cork cambium are parenchymatous.



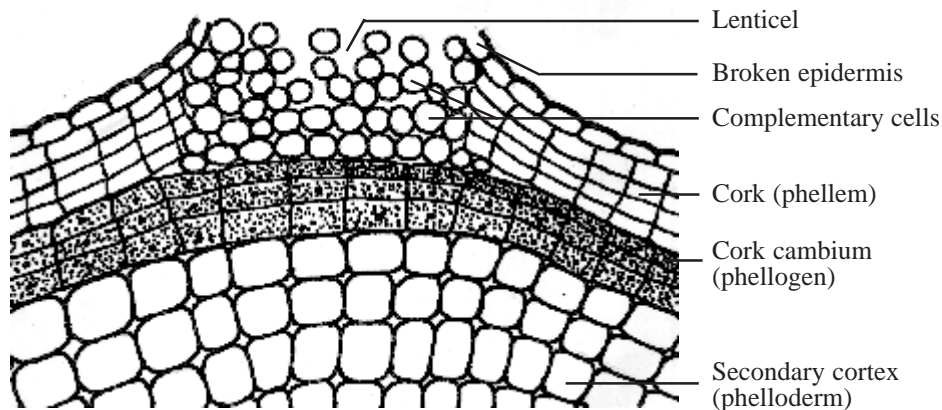
*Fig. 2.19 Structure of Periderm*

This region is called **phelloderm or secondary cortex**. The cells of the phelloderm are **living, isodiametric and radially arranged** with intercellular spaces. As these cells have chloroplasts, they carry out **photosynthesis**. Their cell walls are made up of cellulose.

The cork (phellem), cork cambium (phellogen) and the secondary cortex (phelloderm) are together called **periderm**. All the tissues outside the vascular cambium i.e., secondary phloem, cortex and the periderm are together called **bark**.

### *Lenticels*

Lenticels are the lense shaped openings or breaks in the cork tissue. They are formed due to the rupture in the epidermal layers during the secondary growth in stems. They appear as small protrusions on the stem. Lenticels are usually formed below the stomata or sometimes at any region under the epidermis. Phellogen is more active in the region of lenticels than elsewhere and thus forms a mass of loosely arranged thin walled

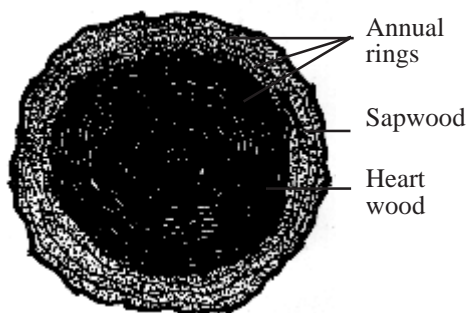


*Fig. 2.20 Structure of a lenticel*

parenchymatous cells called complementary cells. Lenticels are useful in exchange of gases. Lenticels remain scattered or arranged in the longitudinal or vertical rows.

### *Annual rings*

During the spring and the summer seasons vegetative growth of a tree is induced and more leaves are produced. So there is a dire need of efficient transport of water and mineral salts. So the vessels produced during these seasons are larger and wider than those produced in the winter and the autumn seasons. Xylem elements of spring wood are larger, thin-walled and lighter in colour. On the other hand, during the winter and the autumn seasons less amount of xylem elements is produced. These xylem elements



*Fig. 2.21 Annual rings*

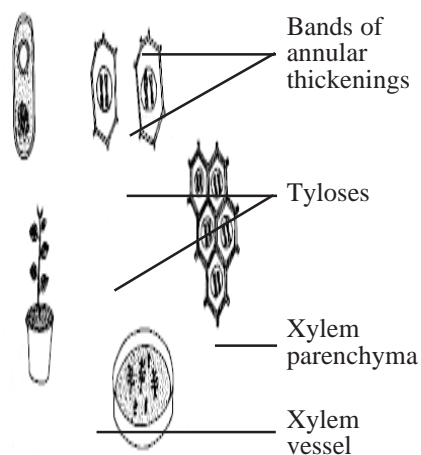
are smaller, thick-walled and darker in colour. The xylem (wood) formed during the spring and the summer is called early wood or spring wood and that produced during the winter and the autumn is called late wood or autumn wood. These two kinds of wood appear together as a concentric ring called **annual ring or growth ring**.



Each annual ring refers to one year's growth. By counting the total number of annual rings, the age of the plant can approximately be calculated. The determination of the age of a tree by counting the annual rings is called **Dendrocronology**. The section taken at the base of the trunk of American *Sequoia dendron* has revealed that the tree is about 3500 years old.

### **Tyloses**

In many dicot plants, the lumens of the xylem vessels are blocked by many balloon like in-growths from the neighbouring parenchymatous cells. These balloon like structures are called **tyloses**.



**Fig. 2.22 Tyloses**

Usually these structures are formed in secondary xylem vessels. In fully developed tyloses starch, crystals, resins, gums, oils, tannins and coloured substances are found.

### **Sap wood and heart wood**

Xylem is also known as wood. When the secondary growth occurs for several years, sapwood and heartwood can be distinguished in the secondary xylem. The outer part of the wood, which is paler in colour, is called **sapwood or**

**alburnum**. The centre part of the wood, which is darker in colour, is called **heartwood or duramen**.

The sapwood is useful in the conduction of water. As vessels of the heartwood is blocked by tyloses, water is not conducted through them. The tyloses contain oils, gums, tannins, resins and other coloured substances. Due to the presence of these substances, the heartwood becomes the hardest part of the wood. From economic point of view the heartwood is more useful than sapwood. The timbers from the heartwood are more durable and more resistant to the attack of microorganisms and insects than those from sapwood.

### Self evaluation

#### *I. Choose and write the correct options.*

1. Vascular cambium is a
  - a. apical meristem
  - b. intercalary meristem
  - c. lateral meristem
  - d. promeristem
2. The cambium which remains between the xylem and the phloem in the vascular bundles is called
  - a. fascicular cambium
  - b. interfascicular cambium
  - c. cork cambium
  - d. phellem
3. The cells of the vascular cambial ring which are cut off towards the outer side get differentiated into
  - a. primary xylem
  - b. primary phloem
  - c. secondary xylem
  - d. secondary phloem
4. The protective layer developed during the secondary growth of the stem is called
  - a. epidermis
  - b. periderm
  - c. rhizodermis
  - d. phellogen

#### *II. Answer the following questions in two or three sentences.*

5. What is called a secondary growth?
6. What is an interfascicular cambium?
7. What tissues are together called a periderm?

8. What are complementary cells?
9. What are tyloses?

**III. Answer the following questions in about 100 words.**

10. Write short notes on lenticels.
11. Write short notes on annual rings.
12. Write short notes on tyloses.
13. Write short notes on sap wood and heart wood.

**IV. Answer the following questions in about 200 words.**

14. Describe the secondary growth in dicot stem. Ground plan or a sector enlarged is to be drawn, no need to draw both the diagrams.

**Reference books**

1. Plant anatomy by P.C. Vasishta
2. An introduction to plant anatomy by Arthur J. Eames, Laurence H. MacDaniels.
3. Plant anatomy by S. Palaniappan.
4. Plant anatomy by Katherine Esau.
5. Plant anatomy by B.P. Pandey, 2003.

### 3. CELL BIOLOGY AND GENETICS

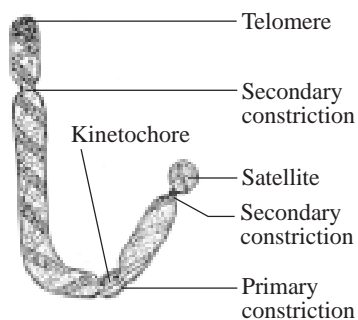
In the previous unit, you have studied several types of cells and their organization to form tissue and tissue systems. Now, we shall study how characters and traits are inherited from one generation to another. Sexual reproduction, besides producing individuals, introduces variability in the offspring by combining traits of parents. How are these traits inherited? Now, we know that the units of heredity are genes that are transmitted from one generation to another. The genes are arranged in a linear manner at specific positions on specific chromosomes. Differences in gene expression are the basis for differentiation of the organisms. This unit will acquaint you with various aspects of genetics.

#### 3.1. Chromosomes

Chromosomes are the physical carriers of genes, which are made up of DNA and associated proteins. The term chromosome was introduced by **Waldeyer** in 1888. Chromosomes occur in all the living organisms. The bacterial chromosomes are circular. It has closed circular DNA. Linear chromosomes are found in eukaryotes. **Bridges** in 1916 was the first to prove that the genes are carried on the chromosome.

##### *Structure of chromosome*

Each chromosome consists of similar structures called chromatids. They are identical and are called sister chromatids. A



**Fig. 3.1 Structure of chromosome** typical chromosome has narrow zones called constrictions. There are two types of constrictions namely primary constriction and secondary constriction.

The primary constriction is made up of centromere and kinetochore. Both the chromatids are joined at centromere, which is essential for the movement of chromosomes at anaphase. If the centromere of the chromosomes is damaged, such chromosome fails to move at anaphase. The number of centromeres varies from chromosome to chromosome. The monocentric

chromosome has one centromere and the polycentric chromosome has many centromeres.

The centromere contains a complex system of fibres called kinetochore. Each centromere has two kinetochores lined with chromosomal arms. The kinetochore is made up of protein fibres and microtubules which assist in the formation of spindles during mitosis and meiosis.

All constrictions other than primary are called secondary constrictions. In a given set of chromosomes only one or two chromosomes have secondary constrictions. The nucleoli develop from secondary constrictions and such secondary constrictions are called **nucleolar organisers**.

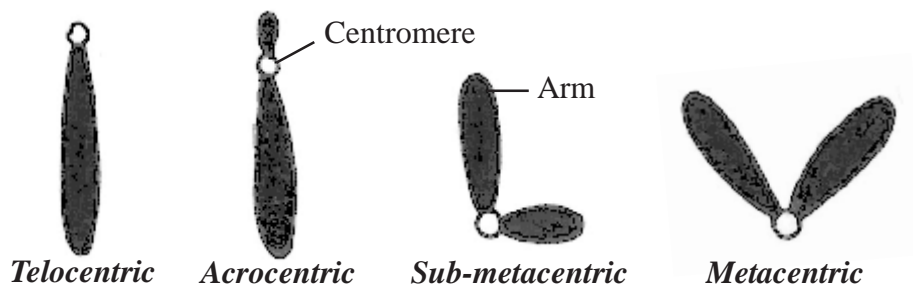
A satellite is a short chromosomal segment and separated from the main chromosome by a relatively elongated secondary constriction. A chromosome with a satellite is called **SAT-chromosome**.

Chromatin is a viscous gelatinous substance that contains DNA, RNA, histone and non-histone proteins. H1, H2A, H2B, H3 and H4 are the five types of histones found in the chromatin. The chromatin is formed by a series of repeated units called nucleosomes. Each nucleosome has a core of eight histone subunits.

Telomere is the terminal part of chromosome. It offers stability to the chromosome. DNA of the telomere has specific sequence of nucleotides. Eukaryotic chromosome has DNA, RNA, histones, non-histone proteins and metallic ions like  $\text{Ca}^{+2}$ ,  $\text{Mg}^{+2}$ , etc.,

### *Types of chromosomes*

The chromosomes are classified into different types based on shape and position of the centromere. According to the position of centromere,



*Fig. 3.2 Four morphogenic types of chromosomes*

the eukaryotic chromosomes may be rod shaped (telocentric and acrocentric), L-shaped (sub-metacentric) and V-shaped (metacentric). There are two types of chromosomes based on their function. They are autosomes and sex chromosomes.

### ***Autosomes***

They are present in all the cells of the organisms. They control the somatic characteristics of an organism. In the human diploid cell, 44 chromosomes are autosomes whereas the rest two are sex chromosomes.

### ***Sex chromosomes***

In the diploid cells of animals and certain plants, one or more special chromosomes are different from the autosomes in their morphological structures and behaviour. These chromosomes are involved in the determination of sex. They are called sex chromosomes. In human being, male has XY and female XX chromosomes.

### ***Unusual chromosomes***

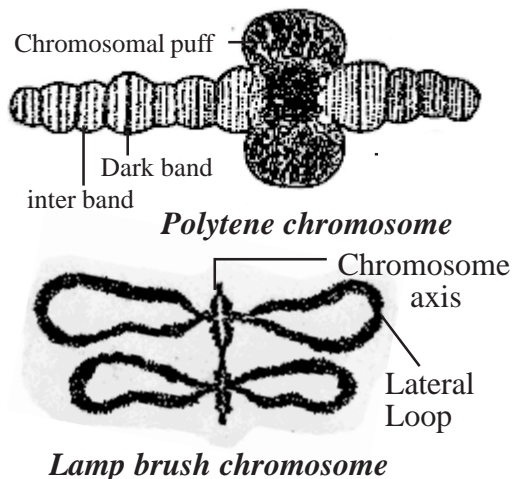
These chromosomes are abnormal chromosomes. They differ from the basic structure of normal chromosomes. Eg. B-chromosomes and Double minutes. B-chromosomes are also called supernumerary and accessory chromosomes. They are additional chromosomes found in some individuals in a population. eg. maize. They are common in plants and they reduce viability.

Double minutes are unstable chromosome like structures. They have no centromere and formal telomeres. They occur in cancer cells which show resistance against drugs.

### ***Special types of chromosomes***

In Eukaryotic organisms certain chromosomes are found only in certain special tissues and are not seen in other tissues. These chromosomes are larger in size and are called giant chromosomes. In certain plants, they are found in the suspensors of the embryo. There are two types of giant chromosomes – polytene chromosome and lamp brush chromosome.

Polytene chromosomes were observed by C.G. Balbiani in 1881 in the salivary glands of *Drosophila*. The characteristic feature of polytene



**Fig. 3.3. Special types of chromosomes**

chromosome is that along the length of the chromosome there is a series of dark bands alternate with clear zones called inter bands. The polytene chromosome has extremely large puff called Balbiani ring. It is also known as chromosomal puff. As this chromosome occurs in the salivary gland it is known as salivary gland chromosomes.

Lamp brush chromosomes were first observed by Flemming in 1882. It looked like brushes. They occur at the diplotene stage of meiotic prophase in oocytes of an animal *Salamander* and in giant nucleus of the unicellular alga *Acetabularia*. The highly condensed chromosome forms the chromosomal axis, from which lateral loops of DNA extend as a result of intense RNA synthesis.

### Self evaluation

#### I. Choose and write the correct options.

1. The term chromosome was introduced by  
a. Bridges b. Waldeyer c. Balbiani d. Flemming
2. Who had first proved that the genes are carried by the chromosome?  
a. Bridges b. Waldeyer c. Balbiani d. Flemming

#### II. Answer the following questions in two or three sentences.

3. What are autosomes?
4. What are sex chromosomes?
5. What are B-chromosomes?
6. What is a polytene chromosome?

#### III. Answer the following questions in about 100 words.

7. Write short notes on the structure of chromosomes.
8. Write short notes on the types of chromosomes.
9. Describe special types of chromosomes.

### 3.2. Gene and genome

The word gene was coined by **W. Johannsen** in 1909. A gene is a physical and functional unit of heredity. It carries information from one generation to the next. Gene is also defined as a nucleotide sequence that is responsible for the production of a specific protein. When a gene undergoes changes due to mutation, it results in biological variations. These variations are important for evolution. Such variations also arise due to recombination of genes on chromosomes.

The relationship between genes and enzymes was discovered by Beadle and Tatum. They conducted bio-chemical research on the fungus *Neurospora* and concluded that the major role of genes was to carry information for the production of enzymes. For their work they were awarded Nobel prize in 1958. Their findings are referred to as '*one gene one enzyme hypothesis*'. Now, the hypothesis has been modified to '*one gene one polypeptide hypothesis*' because the product of gene action is always a polypeptide.

#### **Genome**

Genome may be defined as the totality of the DNA sequences of an organism including DNAs present in mitochondria and chloroplasts. Each species has a characteristic number of chromosomes in the nuclei of its gametes and somatic cells. The gametic chromosome number constitutes a basic set of chromosomes of the organism. In all organisms it is made up of DNA but in viruses, it is made up of either DNA or RNA.

***Table showing the organisms and their haploid set of chromosome***

| Sl.No. | Name of organism            | Haploid set of chromosome |
|--------|-----------------------------|---------------------------|
| 1.     | <i>Arabidopsis thaliana</i> | 5                         |
| 2.     | Garden pea                  | 7                         |
| 3.     | Paddy                       | 12                        |
| 4.     | <i>Triticum aestivum</i>    | 21                        |
| 5.     | <i>Homo sapiens</i>         | 23                        |
| 6.     | Chimpanzee                  | 24                        |
| 7.     | Sugarcane                   | 40                        |
| 8.     | <i>Ophioglossum</i>         | 631                       |



The genome size of an individual is expressed in terms of number of base pairs either in kilobases (1000 bp) or in megabases (one million bp). *Arabidopsis thaliana* is an annual crucifer weed called '**thale cress**'. It has the smallest nuclear genome of 130 mb with five chromosomes ( $2n = 10$ ). The human genome comprises approximately  $3.2 \times 10^9$  nucleotides. The human mitochondrial genome contains 37 genes and has 16,569 basepairs.

**Table showing the genome and approximate number of genes**

| S. No | Name of the organism        | Size of the genome in megabase pairs | Approximate number of genes |
|-------|-----------------------------|--------------------------------------|-----------------------------|
| 1.    | <i>Escherichia coli</i>     | 4.64                                 | 4,400                       |
| 2.    | Yeast                       | 12.10                                | 5,800                       |
| 3.    | <i>Arabidopsis thaliana</i> | 130.00                               | 26,000                      |
| 4.    | <i>Drosophila</i>           | 180.00                               | 13,600                      |
| 5.    | <i>Homo sapiens</i>         | 3,300.00                             | 30,000 - 40,000             |

In human genome, 38.2% of genome is involved in biochemical activities like synthesis of immunological and structural proteins, 23.2% in the maintenance of genome, 21.1% in receiving and giving signals related to cellular activities and remaining 17.5% in the general functions of the cell. The functions of 30,000 to 40,000 human genes are known.

### Self evaluation

**I. Answer the following questions in two or three sentences.**

1. Define a gene.
2. Why has 'one gene one enzyme hypothesis' been modified into 'one gene one polypeptide hypothesis'?
3. Define genome.
4. State the percentage of human genome performing various activities.

**II. Answer the following questions in about 100 words.**

5. Write short notes on genome.

### 3.3. Linkage and crossing over

The tendency of genes or characters to be inherited together because of their location on the same chromosome is called **linkage**. Many hybridization experiments were conducted both on plants and animals based on Mendel's work. The results of certain dihybrid crosses did not confirm the law of independent assortment. It states that the inheritance of genes of each pair in a dihybrid during gamete formation is independent of the other.

|                               |  |               |                                    |              |      |  |  |    |
|-------------------------------|--|---------------|------------------------------------|--------------|------|--|--|----|
| Parent                        | Blue flower<br>long pollen<br>BBLL   |               | Red flower<br>round pollen<br>bbll |              |      |  |  |    |
| Gametes                       | BL   | ×             | bl                                 |              |      |  |  |    |
| F <sub>1</sub> generation     | BbLl (Blue long)   |               |                                    |              |      |  |  |    |
| <b>Dihybrid test cross</b>    | BbLl   | ×             | bbll                               |              |      |  |  |    |
| Gametes                       |  |               |                                    |              |      |  |  |    |
|                               | <table border="1" style="display: inline-table; border-collapse: collapse;"> <tr> <td>BbLl</td> <td>Bbll</td> <td>bbLl</td> <td>bbll</td> </tr> </table> | BbLl          | Bbll                               | bbLl         | bbll |  | <table border="1" style="display: inline-table; border-collapse: collapse;"> <tr> <td>bl</td> </tr> </table> | bl |
| BbLl                          | Bbll   | bbLl          | bbll                               |              |      |  |  |    |
| bl                            |  |               |                                    |              |      |  |  |    |
| Phenotype                     | Blue<br>long   | Blue<br>round | Red<br>long                        | Red<br>round |      |  |  |    |
| Observed percentage frequency | 44   | 6             | 6                                  | 44           |      |  |  |    |
| Observed ratio                | 7  | : 1           | : 1                                | : 7          |      |  |  |    |
| Expected ratio                | 1  | : 1           | : 1                                | : 1          |      |  |  |    |

#### *Mechanism of linkage - coupling in Lathyrus odoratus*

In 1906, William Bateson and Reginald Punnett conducted experiments in sweet pea, *Lathyrus odoratus* to confirm Mendel's dihybrid testcross. They observed an exception to the independent assortment of two genes in this plant. Here, blue flower (B) is dominant over the red flower (b) and long pollen (L) dominant over round pollen (l). They crossed true breeding plants having blue flower with long pollen (BBLL) and red flower with

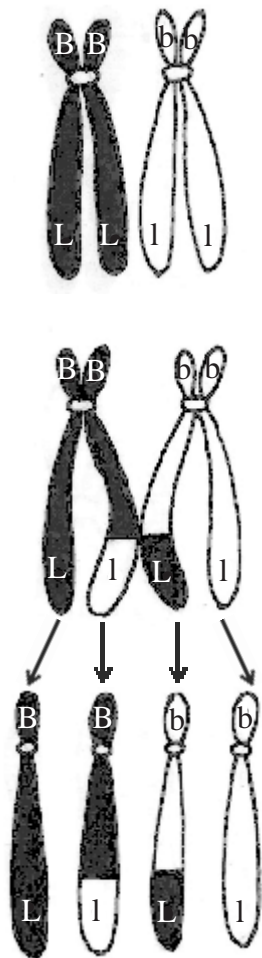
round pollen (bbll). All the F<sub>1</sub> hybrids have blue flowers with long pollen (BbLl). A testcross between heterozygous blue long (BbLl) of F<sub>1</sub> hybrid and double recessive parental stock red round (bbll) did not result in ratio 1:1:1:1 but gave unexpected phenotype frequency as shown below.

Here, blue long and red round are parental forms and show greater frequency 88 per cent. Blue round and red long are recombinant forms and show lesser frequency 12 per cent. The dihybrid test cross ratio obtained is 7:1:1:7 and not 1:1:1:1. This indicates that the genes do not independently assort. From the above test cross, it is clear that if dominant alleles or recessive alleles are present in the same plant, they tend to remain together resulting in increased parental forms. Thus, the two genes which inherit together are called linked genes. This aspect is called **coupling**.

They made another cross between plants having blue flower with round pollen (BBll) and red flower with long pollen (bbLL). A testcross between

|                               |  |            |                                   |      |      |  |  |    |
|-------------------------------|--|------------|-----------------------------------|------|------|--|--|----|
| Parent                        | Blue flower<br>round pollen<br>BBll  | ×          | Red flower<br>long pollen<br>bbLL |      |      |  |  |    |
| Gametes                       | Bl   |            | bL                                |      |      |  |  |    |
| F <sub>1</sub> generation     | BbLl (Blue long)   |            |                                   |      |      |  |  |    |
| <b>Dihybrid test cross</b>    | BbLl   | ×          | bbll                              |      |      |  |  |    |
| Gametes                       |  |            |                                   |      |      |  |  |    |
| Phenotype                     | <table border="1" style="display: inline-table; border-collapse: collapse;"> <tr> <td>BbLl</td> <td>Bbll</td> <td>bbLl</td> <td>bbll</td> </tr> </table> | BbLl       | Bbll                              | bbLl | bbll |  | <table border="1" style="display: inline-table; border-collapse: collapse;"> <tr> <td>bl</td> </tr> </table> | bl |
| BbLl                          | Bbll   | bbLl       | bbll                              |      |      |  |  |    |
| bl                            |  |            |                                   |      |      |  |  |    |
|                               | Blue long  | Blue round | Red long                          |      |      |  |  |    |
| Observed percentage frequency | 6  | 44         | 44                                |      |      |  |  |    |
| Observed ratio                | 1  | : 7        | : 7                               |      |      |  |  |    |
| Expected ratio                | 1  | : 1        | : 1                               |      |      |  |  |    |

***Mechanism of linkage - repulsion in Lathyrus odoratus***



**Fig. 3.4 Crossing over**  
**Crossing over**

heterozygous blue long ( $BbLl$ ) of  $F_1$  hybrid and double recessive red round ( $bbll$ ) did not result in ratio 1:1:1:1 but gave unexpected phenotype frequency as shown below.

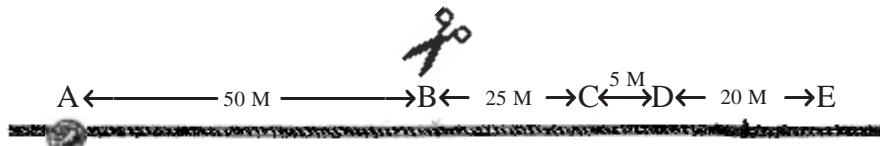
Here, blue round and red long are parental forms and show greater frequency 88 per cent. Blue long and red round are recombinant forms and show lesser frequency 12 per cent. The dihybrid test cross ratio obtained is 1:7:7:1 and not 1:1:1:1. This indicates that the genes do not independently assort. From the above testcross, it is clear that if dominant alleles or recessive alleles are present in the different plants, they tend to remain separate resulting in increased parental forms. This aspect is called **repulsion**.

Coupling and repulsion offered explanation for higher frequency of parental forms. They are two aspects of a single phenomenon called linkage. The genes that are carried on the same chromosome will not assort independently because of their tendency to remain linked together. This is called **linkage**. The genes located on the same chromosomes that are inherited together are known as linked genes. They tried to reconfirm the law of independent assortment. But they could not get expected result because the genes are linked.

The process, which produces recombination of genes by interchanging the corresponding segments between nonsister chromatids of homologous chromosomes, is called **crossing over**. A crossing over between linked genes allows their recombination during meiosis.

Crossing over takes place in pachytene stage of prophase I of meiosis. In pachytene stage, the bivalent chromosome becomes tetrad i.e. with four chromatids. The adjacent nonsister chromatids are joined together at certain

points called chiasmata. Crossing over occurs between the nonsister chromatids of paired chromosomes in the region of chiasma. At each chiasma, the two nonsister chromatids break, exchange their segments and rejoin resulting the crossing over.



*Fig. 3.5 Illustration to explain the probability of crossing over*

Hence, out of four chromatids the two adjacent chromatids are recombinants and other two are original chromatids. Thus four types of gametes are obtained.

#### ***Significance of crossing over***

- Crossing over leads to the production of new combination of genes and provides basis for obtaining new varieties of plants.
- It plays an important role in the process of evolution.
- The crossing over frequency helps in the construction of genetic maps of the chromosomes.
- It gives us the evidence for linear arrangement of linked genes in a chromosome.

#### ***Gene mapping***

Genes are arranged linearly in a chromosome. The point in a chromosome where the gene is located is called **locus**. The diagrammatic representation of location and arrangement of genes and relative distance between linked genes of a chromosome is called **linkage** or **genetic map**.

The unit of genetic map is Morgan or centimorgan. When the percentage of crossing over between two linked genes is 1 per cent, then the map distance between the linked genes is one morgan.

There is a greater probability of occurrence of crossing over, when the two genes are farther apart in a chromatid. The probability of crossing over between two genes is directly proportional to the distance between them.

When two genes are nearer, the probability of occurrence of crossing over between them is limited.

Let A, B, C, D and E be five knots on a string separated by the distances as shown. The probability of making a random cut between two knots is directly proportional to the distance between them. Every cut separates A from E, whereas 5/100<sup>th</sup> cut only separates C from D. If the knots or genes linearly arranged on a chromosome in randoms are the cross overs, then C and D remain linked, whereas A and E will not show linkage in this situation.

### ***Uses of gene mapping***

- It is useful to determine the location, arrangement and linkage of genes in a chromosome.
- It is useful to predict the results of dihybrid and trihybrid crosses.

### **Self evaluation**

#### ***I. Choose and write the correct options.***

1. The coupling test cross ratio is
  - a. 1:7:7:1
  - b. 7:1:1:7
  - c. 1:1:1:1
  - d. 9:3:3:1

#### ***II. Answer the following questions in two or three sentences.***

2. What is linkage?
3. What is coupling?
4. What is repulsion?
5. What is crossing over?
6. What is a genetic map?
7. What are the uses of gene mapping?

#### ***III. Answer the following questions in about 100 words.***

8. Write short notes on crossing over.
9. What is crossing over? Write the significance of crossing over.
10. Write short notes on gene mapping.
11. Explain the coupling aspect in *Lathyrus odoratus*.
12. Explain the replusive aspect in *Lathyrus odoratus*.

### 3.4. Recombination of chromosome

The process, which produces recombinations of gene by interchanging of corresponding segments between nonsister chromatids of homologous chromosomes, is called recombination of chromosomes. It takes place in pachytene stage of prophase I of meiosis. Crossing between the linked genes results in genetic recombination.

According to Bateson and Punnett, in *Lathyrus odoratus* 12 per cent of the test cross progeny were recombinants. Recombination between two genes is expressed in percentage. It is called recombination frequency. Gene pairs that had very low percentage of recombination are known as tightly linked genes. The gene pairs with higher percentage are termed as loosely linked genes. For example, 12 per cent of the test cross progeny were recombinants. They showed a different linkage of alleles than their parents. The percentage recombination is determined by dividing the number of recombinant offspring by the total number of offspring. In the figure 3.4, the linkages of the parents were B with L and b with l. The recombinant offspring are B with l or b with L.

#### Self evaluation

##### *I. Choose and write the correct options.*

1. Recombination of chromosome takes place in \_\_\_\_\_ stage of prophase I of meiosis.
  - a. leptotene
  - b. zygotene
  - c. pachytene
  - d. diplotene

##### *II. Answer the following questions in two or three sentences.*

2. What are tightly linked genes?
3. What are loosely linked genes?

##### *III. Answer the following questions in about 100 words.*

4. Write short notes on Recombination of chromosomes.

### 3.5. Mutation

In a species, variations are caused by changes in the environment or any changes in the innate genetic setup of an organism or by the combination of both. Sudden change in the genetical set up of an organism is defined as mutation. In 1901, Hugo de Vries first used the term mutation based on his observation on *Oenothera lamarckiana*. Charles Darwin termed these sudden change as '**sports**'. According to Bateson, mutation is a discontinuous change. Based on molecular basis of heredity, mutation is defined as sudden change in the sequence of nucleotides of gene. The mutation brings about a change in the organism. The organism which undergoes mutation, is called a mutant. eg. *Oenothera lamarckiana*.

Mutations that affect the biochemical reactions are called biochemical mutations. For example, biochemical mutants of *Neurospora* failed to synthesize certain amino acids. Some mutations drastically influence the genes and cause death to the individual. Such mutation is described as lethal mutation. For example, in the plant *Sorghum*, recessive mutant fails to produce chlorophyll and therefore they die in the seedling stage. Thus, most of the mutations are harmful, because they disturb the genic balance of the organism. Although most of the mutations are useless and even harmful, and some of the mutations play a significant role in the evolution of new species. Many new strains of cultivated crops and new breeds of domesticated animals are the products of gene mutations. Small seeded *Cicer arietinum* (bengal gram) suddenly get mutated to large seeded *Cicer gigas* is the case of gene mutation.

#### *Classification of mutation*

Mutations have been classified in various ways based on different criteria. Depending on the kind of cell in which mutations occur, they are classified into somatic and germinal mutation. They may be **autosomal** or **sex chromosomal** according to their type of chromosome in which they occur. They may be **spontaneous** or **induced** according to their mode of origin. They may be **forward** or **backward** according to their direction. They may be **dominant** or **recessive** according to their phenotypic expression of mutated genes.



### ***Point or gene mutation***

Point mutation is sudden change in small segment of DNA either a single nucleotide or a nucleotide pair. Gross mutation is a change involving more than one or a few nucleotides of a DNA.

The gene mutation may be caused by loss or deletion of a nucleotide pair. This is called **deletion** mutation and reported in some bacteriophages. Addition of one or more nucleotides into a gene results in **addition** mutation. Replacement of certain nitrogen bases by another base in the structure of DNA results in **substitution** mutation. The deletion and addition mutation alter the nucleotide sequence of genes and ultimately result in the production of defective protein and this leads to the death of the organism. The substitution mutations can alter the phenotype of the organism and have great genetic significance.

There are two types of substitution mutations – **transition** and **transversion**. When a purine or a pyrimidine is replaced by another purine or pyrimidine respectively this kind of substitution is called **transition**. When a mutation involves the replacement of a purine for pyrimidine or viceversa this is called **transversion**.

### ***Mutagenic agents***

The chemical substances and environmental conditions which cause mutations in the organisms are called **mutagens** or **mutagenic agents**. There are two kinds of mutagenic agents – physical and chemical mutagenic agents.

#### ***Physical mutagenic agents***

Electromagnetic radiation, radiations like  $\alpha$ ,  $\beta$  and  $\gamma$ , ultraviolet rays, temperature, etc. are some of the examples for physical mutagens. X-rays and gamma rays are ionizing radiations which induce mutation in seeds. UV rays are nonionizing radiations. Pollen can be treated with UV since pollen has germinal nucleus in which mutation can be caused.

#### ***Chemical mutagenic agents***

Chemicals can also be used for inducing mutations in the organisms. Such chemicals are called chemical mutagenic agents. eg. Nitrous acid, Methyl methane sulphonate (MMS) and ethyl methane sulphonate (EMS). Ethyl methane sulphonate

has been extensively used for inducing mutations in microorganisms, higher plants and animals.

### ***Significance of mutation***

- Mutations play an important role in the origin of new species and serves as a tool for evolution.
- Induced mutations are useful in agriculture, animal husbandry and biotechnology to produce new strains. For example, mutant strains of *Penicillium* produces more penicillin.
- It is one of the best approaches for improvement of crops.
- Induced mutants are reported in paddy, wheat, soyabeans, tomatoes, oats, and barley. Mutant varieties of wheat are early maturing, disease resistance and they are enriched with protein. Mutant varieties of paddy produce many tillers with long grains.
- The study of mutant strains of viruses helps us to know the fine structure of gene. The genes are made up of small functional units such as cistron, recon and muton. Cistron is an unit of function, recon is the unit of recombination and muton is the unit of mutation.
- Many types of mutations cause heritable diseases and cancer in human beings.

### **Self evaluation**

#### ***I. Choose and write the correct options.***

1. Hugo de Vries first used the term mutation based on his observation on
  - a. *Sorghum*
  - b. *Neurospora*
  - c. *Oenothera lamarckiana*
  - d. *Cicer gigas*
2. Biochemical mutants of \_\_\_\_\_ failed to synthesize certain amino acids.
  - a. *Sorghum*
  - b. *Neurospora*
  - c. *Cicer arietinum*
  - d. *Cicer gigas*

***II. Answer the following questions in two or three sentences.***

3. What is mutation?
4. What is a biochemical mutation? Give an example.
5. What is a lethal mutation? Give an example.
6. Define a gene mutation
7. What is a transition?

***III. Answer the following questions in about 100 words.***

8. Write short notes on gene mutation.
9. Write short notes on mutagenic agents.
10. What is the significance of mutation?

### 3.6. Chromosomal aberrations

In an organism, any visible abnormality in chromosome number or structure from the diploid set is known as chromosomal aberration. The chromosomal aberrations based on the structure of the chromosome are of four types – deletion, duplication, inversion and transversion.

#### *Structural chromosomal aberrations*

##### *Deletion*

The loss of a segment of the genetic material in a chromosome is called **deletion**. It may be terminal or intercalary. When the deletion occurs near the end of the chromosome, then it is called terminal deletion. Eg. *Drosophila* and Maize. When the deletion occurs in the middle of the chromosome then, it is called intercalary deletion. Most of the deletions lead to death of an organism.

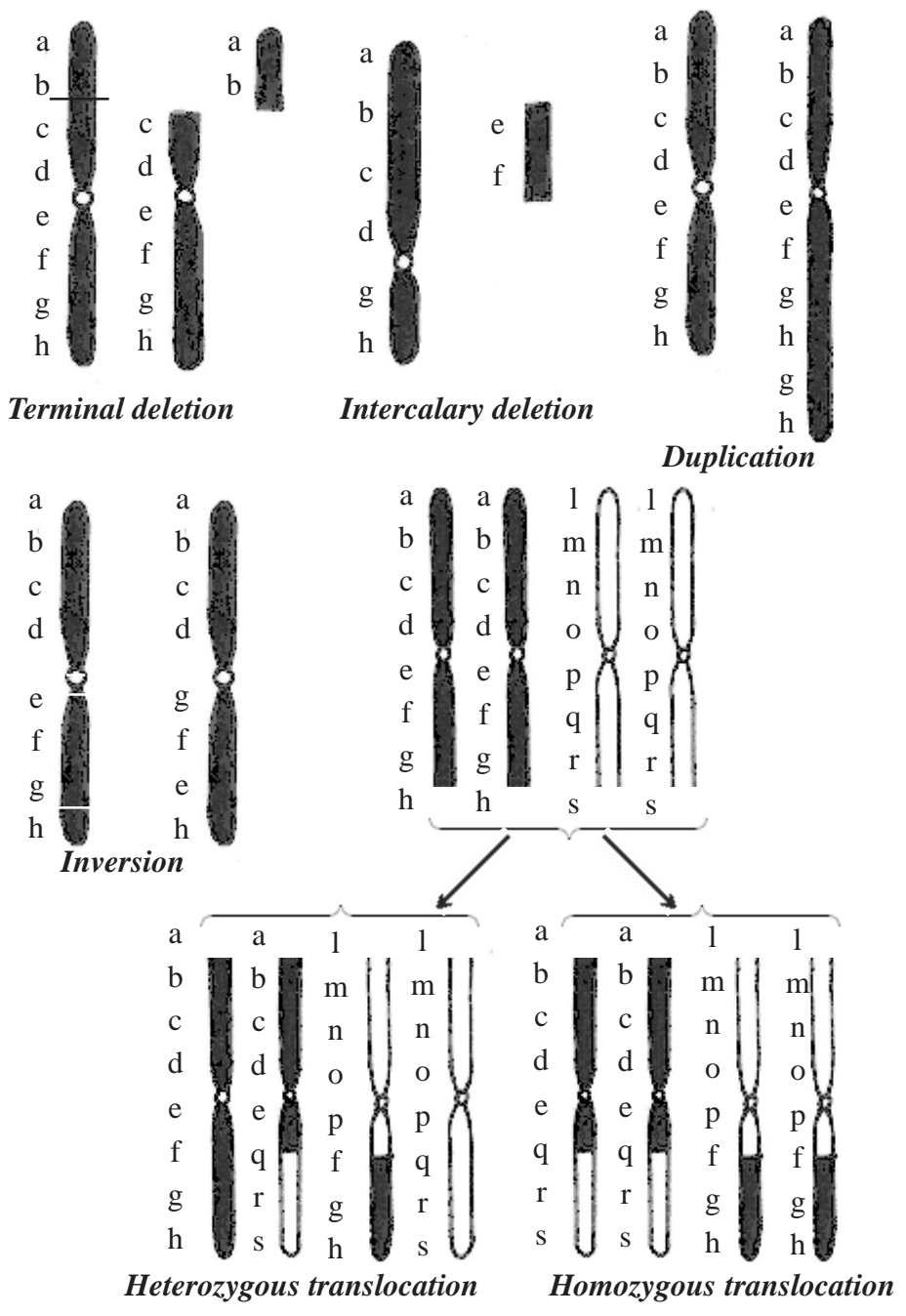
##### *Duplication*

When a segment of a chromosome is present more than once in a chromosome then, it is called **duplication**. For example, the order of genes in a chromosome is **a, b, c, d, e, f, g** and **h**. Due to aberration, the genes 'g' and 'h' are duplicated and the sequence of genes becomes **a, b, c, d, e, f, g, h, g** and **h**. In *Drosophila*, corn and peas a number of duplications are reported. Some duplications are useful in the evolution of the organism.

##### *Inversion*

It is another chromosomal abnormality in which, the order of genes in a chromosomal segment is reversed by an angle of 180°. For example, the order of genes in a chromosome is **a, b, c, d, e, f, g** and **h**. Due to aberration, the sequence of genes becomes, **a, b, c, d, g, f, e** and **h**. There are two types of inversion – pericentric and paracentric inversion.

In pericentric inversion, the inverted segment of the chromosome contains centromere. Sometimes, it is responsible for evolution of the organism. For example the 17<sup>th</sup> human chromosome is acrocentric, while in *Chimpanzee* the corresponding chromosome is metacentric. In paracentric inversion, the inverted segment of the chromosome has no centromere.



**Fig. 3.6 Chromosomal aberrations**

### ***Translocation***

It is a kind of a chromosomal abnormality in which the interchange of the chromosomal segments occurs. When translocation occurs between two non-homologous chromosomes, then it is called **reciprocal translocation** or **illegitimate crossingover**. It is of two kinds - heterozygous translocation and homozygous translocation.

In heterozygous translocation, one member of each pair of chromosomes is normal and the other member is with interchanged segment. But in homozygous translocation, both the members of paired chromosomes have translocated segments.

They play an important role in species differentiation. Translocations causes hereditary disorders.

### ***Numerical chromosomal aberrations***

Each species of an organism has a specific number of chromosomes in its somatic cells. These chromosomes are found in pairs. At the time of formation of gametes the chromosome number is reduced. Hence, the gametes carry haploid set of chromosomes. Alterations in the number of chromosomes from the diploid set is called numerical chromosomal aberration. It is also known as ploidy. There are two types of ploidy – euploidy and aneuploidy.

#### ***Euploidy***

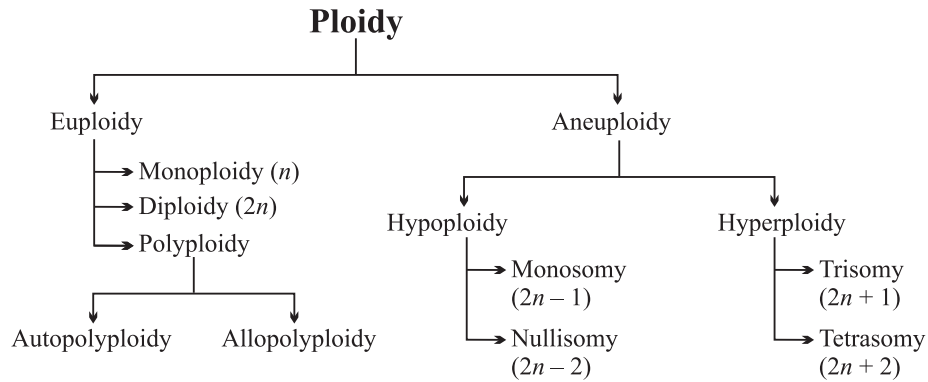
Euploidy is the variation in the chromosome number that occurs due to increase or decrease of full set of chromosomes. Monoploidy, diploidy and polyploidy are the types in euploidy.

#### ***Diploidy***

In most of the plants and animals, the somatic cells contain two sets of chromosome. Diploidy is formed by the union of two gametes during fertilization.

#### ***Polyploidy***

Addition of one or more sets of chromosomes to the diploid set results in polyploidy. It is commonly noticed in plants and rare in animals. They are of two kinds – autopolyploidy and allopolyploidy.



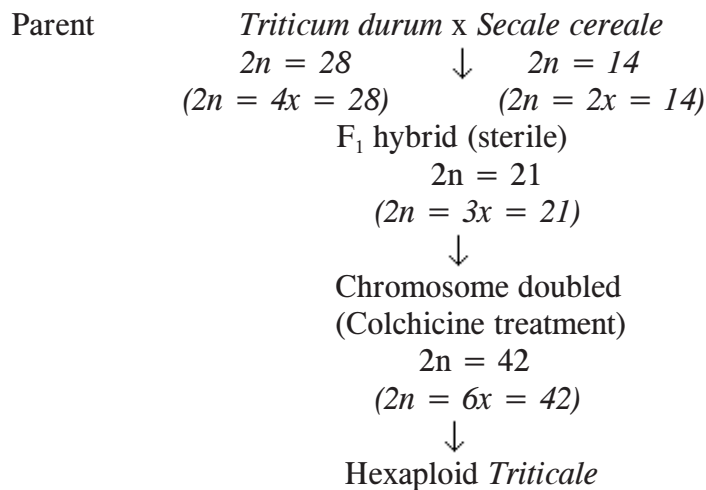
***Ploidy - flow chart***

***Autopolyploidy***

Addition of one or more haploid set of its own genome in an organism results in autopolyploidy. Watermelon, grapes and banana are autotriploids, whereas apple is an autotetraploid.

***Allopolyploidy***

Increase in one or more haploid set of chromosomes from two different species result in allopolyploidy. *Triticale* is the first man made cereal. It is obtained by crossing a wheat *Triticum durum* ( $2n = 4x = 28$ ) and a rye *Secale cereale* ( $2n = 2x = 14$ ). The  $F_1$  hybrid ( $2n = 3x = 21$ ) is sterile. Then the chromosome number is doubled using colchicine and it becomes an hexaploid.



### ***Aneuploidy***

Variation that involves one or two chromosomes within the diploid set of an organism results in aneuploidy. It is of two types – hypoploidy and hyperploidy.

### ***Hypoploidy***

Decrease in one or two chromosomes from the diploid set is described as hypoploidy. There are two types of hypoploidy – monosomy and nullisomy. Monosomy is due to loss of a chromosome from the diploid set i.e.  $2n - 1$ . Nullisomy is the condition in which a pair of homologous chromosomes is lost from the diploid set i.e.  $2n - 2$ .

### ***Hyperploidy***

Addition of one or two chromosomes to the diploid set of chromosome results in hyperploidy. There are two types of hyperploidy – trisomy and tetrasomy. Trisomy results due to the addition of one chromosome to diploid set of chromosomes. It is represented by  $2n + 1$ . Trisomics are observed in *Datura stramonium*. Tetrasomy results due to the addition of two chromosomes to diploid set of chromosome. It is represented by  $2n + 2$ .

### ***Significance of ploidy***

- Polyploidy plays an important role in plant breeding and horticulture.
- Polyploidy has more vigorous effect than the diploids and results in the production of large sized flowers and fruits. Hence, it has economical significance.
- It plays significant role in the evolution of new species.
- Polyploidy results in the changes in the season of flowering and fruiting.
- Polyploids are vigorous invaders of new habitats.
- It leads to the formation of new varieties which show high resistance to disease and increase in yield.
- Tetraploid cabbages and tomatoes contain more ascorbic acid whereas tetraploid corn contains more vitamin A.
- Both euploidy and aneuploidy in man cause congenital diseases.
- Polyploidy varieties like apple, pear, grape and watermelons are cultivated because of their large size.



### Self evaluation

#### ***I. Choose and write the correct options.***

1. The gametes of *Drosophila melanogaster* carry
  - a. three chromosomes
  - b. four chromosomes
  - c. seven chromosomes
  - d. eight chromosomes
2. Nullisomy is represented by
  - a.  $2n - 1$
  - b.  $2n + 1$
  - c.  $2n + 2$
  - d.  $2n - 2$ .

#### ***II. Answer the following questions in two or three sentences.***

3. What is a chromosomal aberration?
4. Write in three sentences about duplication of genes in a chromosome.
5. What is a hypoploidy? State its two types.
6. Write any three significance of ploidy.

#### ***III. Answer the following questions in about 100 words.***

7. Write short notes on inversion.
8. Write the significance of ploidy.
9. Illustrate allopolyploidy with an example.
10. Explain translocation chromosomal aberration with the help of diagrams.
11. Write a detailed account on aneuploidy.
12. Write the flow chart of ploidy.

### 3.7. DNA as a genetic material

It is evident that chromosomes are the carriers of genetic material. Chromosomes contain proteins, DNA and RNA. It is universally accepted that DNA is the genetic material in most of the organisms and higher organisms. In most of the plant viruses, RNA is the genetic material. There are many direct evidences for DNA being the genetic material. Here, we will discuss one of the evidences illustrated by Frederick Griffith.

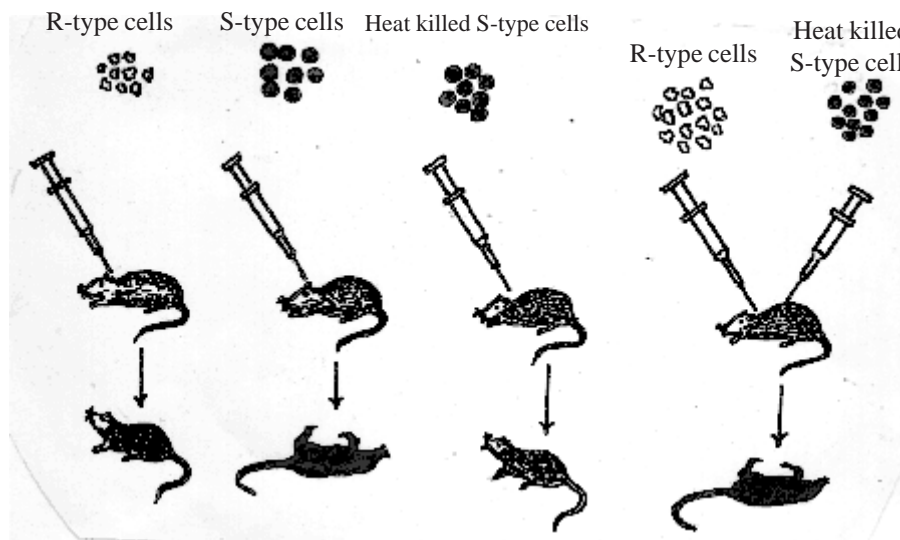


Fig. 3.7 Griffith experiments on mouse

#### *Hereditary role of DNA – Bacterial transformation*

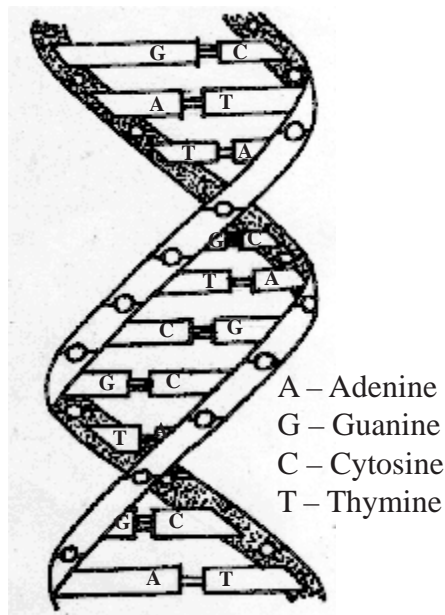
In 1928, the bacteriologist Frederick Griffith conducted an experiment using *Diplococcus pneumoniae*. He studied two strains of virulent *Diplococcus* causing pneumonia. The virulent strain synthesized a smooth polysaccharide coat and produces smooth colonies. This strain was called strain-S. Another strain which lacked the proper polysaccharide coat is harmless and produces rough colonies. This strain was called strain-R.

When Griffith injected S-type of cells into the mouse, the mouse died. When R-type cells were injected into the mouse, the mice did not die. He injected heat killed S-type cells into the mouse. The mouse did not die. Griffith killed some smooth strain bacteria and mixed it with live rough strain bacteria. When the mixture of heat killed S-type cells and R-type

cells was injected into the mouse, the mouse was dead. The living rough strain of *Diplococcus* had been transformed into S-type cells. That is the hereditary material of heat killed S-type cells had transformed R-type cells into virulent smooth strains. Thus the phenomenon of changing the character of one strain by transferring the DNA of another strain into the former is called **transformation**.

### *Structure of DNA*

DNA and RNA are identified in the nucleus. They are complex macro molecules and made up of millions of smaller units called nucleotides. Hence, DNA is a macromolecular substance with double stranded



*Fig. 3.8 Watson and Crick model of DNA*

adenine nucleotide, guanine nucleotide, thymine nucleotide and cytosine nucleotide. Hence, nucleotides are building blocks of DNA.

In 1953, James Watson and Francis Crick proposed double helix DNA model on the basis of x-ray diffraction studies with photographs of DNA taken by Wilkins and Franklin. DNA is a double stranded structure in which the two strands are coiled around each other forming a double helix. The DNA duplex is “**coil of life**”. There are two grooves found in DNA molecule

namely major and minor grooves. The backbone of the helix is formed of sugar and phosphate molecule. The nitrogenous bases are attached to sugar molecules. The two nucleotide strands are held together by unstable hydrogen bonds. Erwin Chargaff in 1949 showed that

- (i) The bases pair in specific manner. Adenine always pairs with thymine and guanine pairs with cytosine.
- (ii) Total amount of purine nucleotides is always equal to the total amount of pyrimidine nucleotides i.e.  $[A] + [G] = [T] + [C]$ .
- (iii) The proportion of adenine is equal to thymine and so also of guanine is equal to cytosine. But the  $[A] + [T]$  need not necessarily be equal to  $[G] + [C]$ .

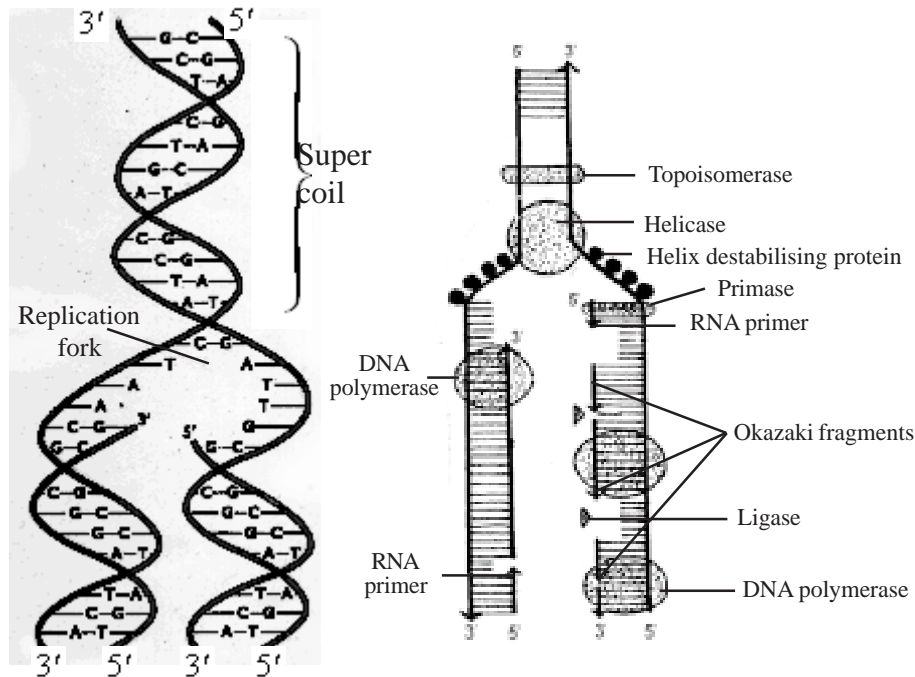
These empirical rules regarding the composition of bases in DNA is collectively known as Chargaff's law or Base pair rules. There are two hydrogen bonds between adenine and thymine ( $A = T$ ) and there are three hydrogen bonds between guanine and cytosine ( $G \equiv C$ ) pairing. The two strand run antiparallely in opposite directions ie. they run in opposite direction 5' to 3' end and 3' to 5' end. The two strands are intertwined in clockwise direction. The width of DNA molecule is 20 Å. The strand completes a turn every 34 Å along its length. There are ten nucleotides per turn. The internucleotide distance is 3.4 Å. Watson and Crick model of DNA is called B-form DNA. The chains in B-form DNA are in right handed orientation.

### ***Functions of DNA***

It controls all the biochemical activities of the cell. It carries genetic information from one generation to other. It controls protein synthesis and synthesizes RNAs.

### ***Replication of DNA***

DNA is the genetic material of almost all the organisms. One of the active functions of DNA is to make its copies which are transmitted to the daughter cells. Replication is the process by which DNA makes exact copies of itself. Replication is the basis of life and takes place during the interphase stage. Watson and Crick suggested the semiconservative method of replication of DNA. This has been proved by Messelson and Stahl's in



**Fig. 3.9 Semiconservative method of replication of DNA**

their experiments on *Escherichia coli* using radioactive isotopes. The replication of chromosome in *E. coli* is completed in 40 minutes.

During replication of DNA, the two complementary strand of DNA uncoil and separate from one end in a zipper like fashion. The enzyme *helicase* unwinds the two strands and as a result replication fork is formed. As the DNA unwinds, the part of the DNA that is found above the replication fork becomes supercoils. These are called **positive supercoils**. An enzyme called *topoisomerase* releases these supercoils. Based on separated DNA strands, new strands grow by the addition of nucleotides. *DNA polymerase I, II and III* are involved in this elongation. However, these enzymes are not capable of initiating DNA synthesis.

For the synthesis of new DNA, two things are required. One is RNA primer and the enzyme *primase*. The *DNA polymerase* moves along the newly formed RNA primer nucleotides, which leads to the elongation of DNA. In the other strand, DNA is synthesized in small fragments called **Okazaki fragments**. These fragments are linked by the enzyme called

*ligase*. In the resulting DNA, one of the strand is parental and the other is the newer strand which is formed discontinuously. Hence, it is called **semidiscontinuous replication**.

### Self evaluation

#### ***I. Choose and write the correct options.***

1. Double helix DNA model was proposed by \_\_\_\_\_
  - a. Watson and Crick
  - b. O.T. Avery et al.
  - c. Griffith
  - d. Stinberg
2. The width of DNA molecule is
  - a. 18 Å
  - b. 20 Å
  - c. 34 Å
  - d. 35 Å

#### ***II. Answer the following questions in two or three sentences.***

3. What is s - strain of *Diplococcus*?
4. What are the empirical rules of Chargaff regarding the composition of bases in DNA?
5. Explain genetic transformation.
6. What are called Okazaki fragments?
7. How is replication fork formed in DNA strand at the time of replication?
8. What is positive supercoil? How is it released?
9. State the functions of DNA.

#### ***III. Answer the following questions in about 100 words.***

10. Explain Frederick Griffith experiment on mouse.
11. Write short notes on replication of DNA.
12. Write an account on the structure of DNA.

### 3.8. Structure of RNA and its types

The Ribonucleic acid is otherwise known as RNA. This is universally present in all organisms except in DNA viruses. It is made up of nucleotides called ribonucleotides. There are four types of nucleotides having four different nitrogenous bases. But sugar and phosphate are common for all nucleotides. The four nucleotides are adenine, cytosine, guanine and uracil. The RNA plays an important role in protein synthesis. Now we will know more about their types and their role in the biology of an organism.

#### *Types of RNA*

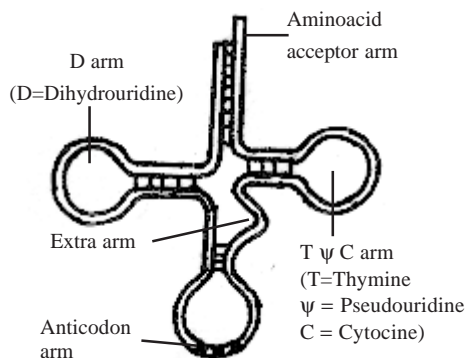
There are three major types of RNA which occur in all organisms. They are messenger RNA (mRNA), transfer RNA (tRNA) and ribosomal RNA (rRNA).

#### *Messenger RNA*

As the name suggests mRNA carries the genetic information from DNA to the ribosomes. Genetic informations on the DNA are transcribed into the mRNA by a process called transcription. Here the “message” is translated into action i.e. based on the genetic information different types of proteins are synthesised. The type of gene that is involved in protein synthesis depends upon their length, kinds and sequence of nucleotides. It is about 3 to 5 per cent of the RNA content of the cell. The mRNA is always single stranded. The mRNA is produced as a complementary copy of the DNA, which is involved in protein synthesis.

#### *Transfer RNA*

Transfer RNA is also known as soluble RNA (sRNA). The tRNA is a small molecule compared with other types of RNAs. It amounts to about 15 per cent of total RNA of the cell. The tRNA molecule performs a number of functions. The most important one is to act as a carrier of aminoacid to the site of protein synthesis. There are about more than 20 types of tRNAs. Each tRNA is



**Fig. 3.10 Structure of tRNA**

specific for a particular amino acid. In bacterial cell, there are more than 70 tRNAs and in eukaryotic cells the number is even greater. There are four or five tRNAs specific for a particular amino acid and these are called isoacceptor tRNAs.

**Structure**

The tRNA has a cloverleaf like structure. It is synthesized in the nucleus on a small part of DNA. In 1965, R.W. Holley suggested the cloverleaf model of tRNA. Though tRNA molecule consists of a single strand, it assumes clover leaf like structure through folding. There are three folds in the clover leaf tRNA. It has four arms namely anticodon arm, D arm, T ψ C arm and aminoacid acceptor arm. The tRNA molecules are made up of 73 to 93 ribonucleotides. The acceptor arm carries an aminoacid. The anticodon arm has three anticodon nucleotides, which will join with the complementary codon in mRNA during protein synthesis i.e. three nucleotides in the tRNA pairs with three nucleotides of mRNA. In certain tRNAs in addition to these four arms an extra arm called variable arm occurs as shown in the figure. The aminoacid acceptor and the anticodon arms are oriented in opposite directions.

**Ribosomal RNA**

This is found in the ribosomes. The rRNA represents about 40 to 60 per cent of the total weight of the ribosomes. Relatively it constitutes about 80 per cent of the total RNA of the cells. They are produced in the nucleus. They are the most stable forms of RNA. They consist of single strand of nucleotides. At some regions, the strand is folded.

**Comparison between DNA and RNA**

| <i>DNA</i>  | <i>RNA</i>  |
|---|---|
| 1. It contains a 5C deoxyribose.                      | 1. It contains five carbon sugar ribose               |
| 2. It contains adenine, guanine, cytosine and thymine | 2. It contains adenine, guanine, cytosine and uracil. |
| 3. It mostly occurs as a double-stranded helix.       | 3. It often occurs as a single stranded.              |
| 4. It is often much longer.                           | 4. It is shorter.                                     |
| 5. It is more stable.                                 | 5. It is less stable.                                 |



### ***Role of RNA in protein synthesis***

There are three types of RNA in the organism namely mRNA, tRNA and rRNA. mRNA brings the message in the form of codons from DNA to the site of protein synthesis i.e. ribosome. The tRNA molecule performs a number of functions. The most important one is to carry specific amino acids to the site of protein synthesis. The rRNA is found in ribosomes. During protein synthesis, rRNA provides the site where amino acids are assembled.

### **3.9. Genetic code**

Amino acids are the basic units of proteins. Different types of proteins are synthesized using 20 different amino acids. But number of amino acids and their arrangements vary in different types of proteins. These features ultimately determined by the nucleotide sequence in the DNA. At the time of protein synthesis, the sequence of information in the form of three successive nucleotide bases in the mRNA, which codes for specific amino acid in a polypeptide is called **genetic code**. It is transferred from DNA to mRNA.

The unit of genetic code is codon, which has three nucleotide bases. Hence, it is also known as triplet. The four-nucleotide bases adenine, guanine, cytosine and uracil combine with each other in different combination to form 64 codons. The mRNA carries number of codons depending upon the type of protein to be synthesized. For example, if a protein consists of 100 amino acids, there will be 300 nucleotide bases in the genetic code (100 codons).

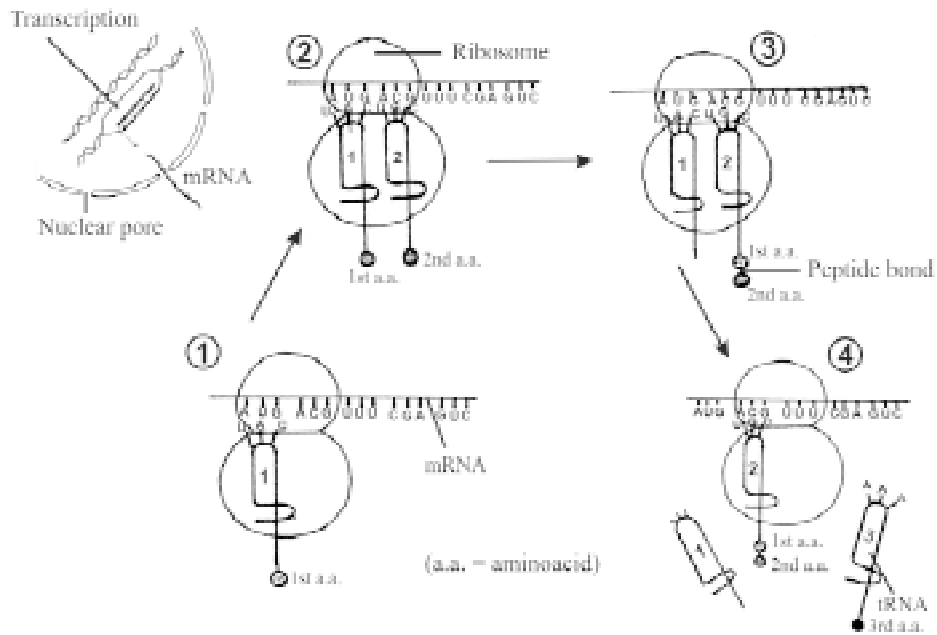
#### ***Characteristics of genetic code***

- Out of 64 codons, three codons are called stop codons UAA, UAG and UGA. Remaining 61 codons code 20 different amino acids. For example, lysine has two codons AAA and AAG. Proline has four codons CCA, CCG, CCC and CCU.
- In the codons of a particular amino acid, the first and the second amino acids remain the same and the third nucleotide only changes.
- The initial or starting codon is AUG, which also code for methionine.
- The genetic code is non-overlapping i.e. adjacent codons do not overlap. The non-overlapping code means that the same letter is not used to code two different amino acids. For example, UUU codes for phenylalanine and CCC for proline.

- There is no signal to indicate the end of one codon and beginning of the next codon i.e. codes are arranged without space. Thus, genetic code is commaless.
- The same codon shall not code for two or more different aminoacids. Thus, the genetic code is **non-ambiguous**.
- The genetic code occurs in all organisms. Thus, the genetic code shows universality.
- The three triplets UAA, UAG and UGA do not code for any aminoacid. These are called non-sense codon. The other 61 codons are called sense codons.

**Central dogma of molecular biology**

Aminoacids are linked by means of peptide bonds to form a protein. A protein may contain thousands of aminoacids. The central dogma of molecular biology is illustrated as below.



**Fig.3.11 Central dogma of molecular biology**

The transfer of message present in the DNA is the initial step and the message is transferred to mRNA. This is known as transcription. Based on the message in the codon, the proteins are synthesized. This stage is called translation.

### ***Transcription***

The process by which an enzyme system transfers the genetic information of DNA into RNA strand is called **transcription**. It is the process of copying of a complementary mRNA strand on a DNA strand. It requires a template DNA, ribonucleotides, triphosphates like ATP and GTP, metal ions  $Mg^{2+}$  and  $Mn^{2+}$  and *RNA polymerase*. The *RNA polymerase* has a sigma factor, which initiates transcription. During transcription, the DNA strands unwind and one of the strands functions as the template for mRNA. The nucleotides of mRNA so formed are complementary to those of DNA strand. However, in mRNA uracil replaces thymine of DNA. The information for protein synthesis present in DNA is now transcribed to mRNA. This process is known as **transcription**.

### ***Translation***

According to genetic information present in the mRNA, specific aminoacids are assembled to form polypeptide chain. The process of translating the nucleotide sequence of mRNA into the aminoacid sequence of a polypeptide is called **translation** i.e. it means decoding the message for protein synthesis. It involves attachment of mRNA to the 30S segment of the ribosomes. The enzymes activate the aminoacids. Specific tRNA picks up the activated aminoacids.

Initially, the tRNA bonds with aminoacid molecules. This reaction is catalysed by *aminoacyl tRNA synthetase*. The tRNAs containing specific aminoacids are now referred to 'charged tRNAs'. The actual process of translation begins, when the initiating aminoacyl tRNA binds to the ribosome and base pairs with mRNA codon AUG. This reaction is promoted by initiating factor. The polypeptide chain increases in length by the linking of successive aminoacids as per the genetic code. Thereby, elongation of polypeptide chain takes place. This reaction is promoted by elongation factor.

Stopping codons UAA, UAG and UGA signal the completion of polypeptide chain. Then, the polypeptide chain is released from the ribosomes with the help of release factors. The proteins become biologically active when they are folded to attain three-dimensional configuration. This is achieved by the attachment of phosphate or any prosthetic group to the protein.

### Self evaluation

#### *I. Choose and write the correct options.*

1. RNA is universally present in all organisms except in \_\_\_\_\_
  - a. TMV
  - b. bacteria
  - c. algae
  - d. DNA viruses
2. mRNA is about \_\_\_\_\_ of the RNA content of the cell
  - a. 10 - 20%
  - b. 5 - 10%
  - c. 3 - 5%
  - d. 20 - 30%
3. In bacterial cell, there are more than \_\_\_\_\_ tRNAs
  - a. 200
  - b. 70
  - c. 300
  - d. 400

#### *II. Answer the following questions in two or three sentences.*

4. What are isoacceptor tRNAs?
5. What are the four arms found in the clover leaf structure of tRNA?

#### *III. Answer the following questions in about 100 words.*

6. Write short notes on the structure of t-RNA.
7. Write the differences between DNA and RNA.

***IV. Answer the following questions in about 200 words.***

8. Write an account on the structure of RNA and its types.
9. What is genetic code? Write its characteristics.
10. Explain the central dogma of molecular biology.

***Reference***

1. Chromosomes by Archana Sharma Oxford and IBH, 1995.
2. Cell structure and function, Loewy and Siekevitz, Oxford and IBH, 1978.
3. Genetics by Winchester Oxford - 1966.
4. DNA synthesis by Arthur Kornberg, - 1974.
5. Principles of genetics by Sinnott, Dunn and Dobzhansky, 1958.

## 4. BIOTECHNOLOGY

In the science of genetics, some sweeping changes are taking place. A lowly bacterium that is found in the bowels of everyone namely *Escherichia coli* is drawing the attention of all scientists and learned people. This bacterium has become one of the potentially most powerful tools known to science in genetic manipulation. In this chapter, you will learn that we now have the ability to find specific genes, to cut them away from chromosomes, to insert them into the chromosomes of other species. Genes have been duplicated countless times to harvest their protein product in large quantities. There are both advantages and disadvantages in doing recombinant research on plants. Several important species such as carrot, cabbage, citrus and potatoes can be grown from single cells. So, once a gene is introduced to a cell, a clone of that cell can produce countless altered progeny. Most plant characteristics that need improvement such as growth rate, size of edible parts and amino acid balance are polygenic – controlled by many genes. Most of the genes responsible for such traits were not yet identified. It is also very difficult to clone five or more genes which control a trait. These inevitable disadvantages are there in recombinant DNA technology.

### 4.1. Recombinant DNA technology

It is a technique where the selected DNA of one organism (Donor) is introduced to combine with the DNA of another organism called recipient organism. As a result, the recipient organism acquires the genetic abilities of the donor. Altering the genome of an organism by introducing genes of interest is known as **gene manipulation** or **DNA recombinant technology**. As this mechanism has the ability to engineer new organisms, it is known as **genetic engineering**.

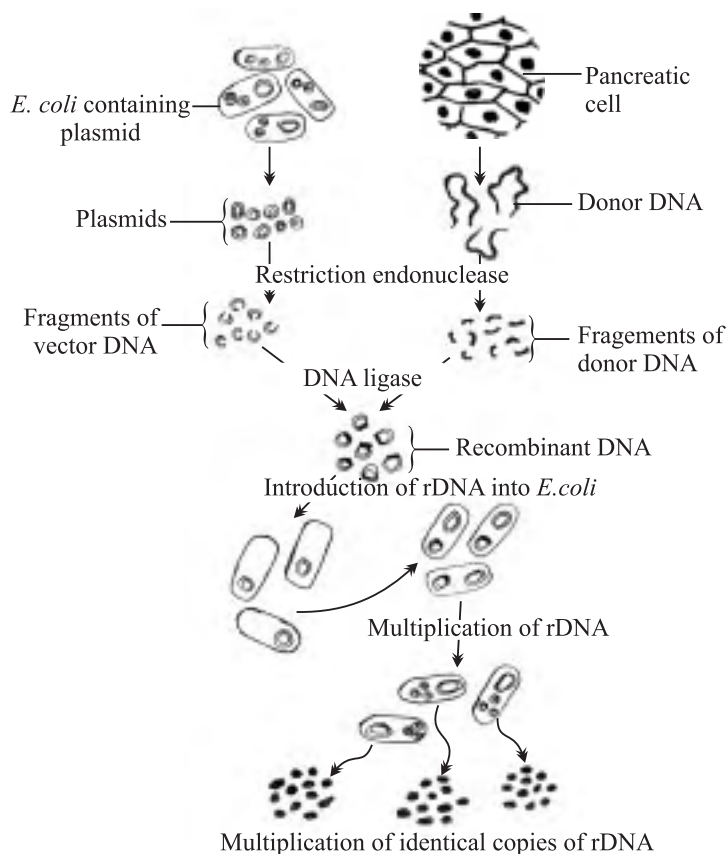
#### Basic techniques of genetic engineering

Bacterial cells have different kinds of enzymes. Some of these can cut DNA into fragments and others can join such fragments. For example, restriction endonucleases discovered in 1970 are involved in cutting DNA at specific sites. Hence they are called **molecular scissors**. The enzyme DNA ligase discovered in 1966 acts like a paste molecule

to join DNA fragments. Thus the restriction endonuclease and the DNA ligase are the basic tools required for genetic engineering.

The events of recombinant DNA technology are as follows.

1. The DNA of donor organism or gene of interest is isolated and cut into fragments using restriction endonucleases.
2. They are attached to a suitable replicon. Such replicon is known as **vector** or **cloning vehicle**, which is nothing but the extra chromosomal circular DNA found in the cytoplasm of *Escherichia coli* is called plasmid. The plasmids are the most suitable vectors.
3. The DNA of the vector is cut into fragments using the same restriction endonucleases. Using the enzyme DNA ligase, the



**Fig.4.1. Various steps involved in production of human insulin**

DNA fragments of donor and vector are joined together. This process is called **splicing**. As a result of splicing hybrid DNA or recombinant DNA (rDNA) is obtained.

4. The rDNA is introduced into the host cells such as *E.coli*, *Bacillus subtilis*, *Streptomyces sp.* etc.,
5. For this the host cells are treated with the enzyme cellulase. So that the cell wall of host becomes permeable to the entry of rDNA.

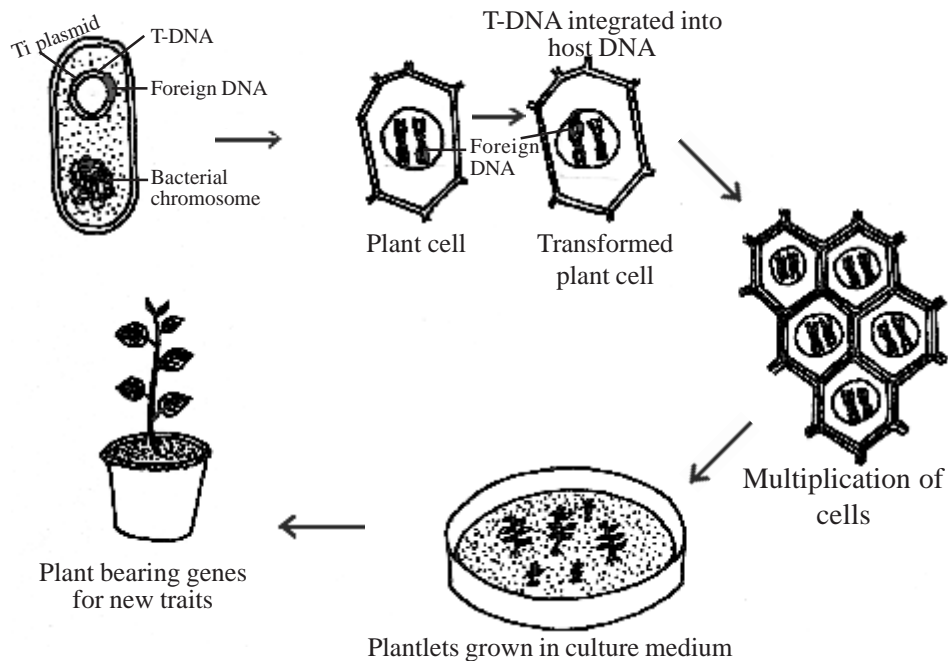
The host organism follows the instructions of “foreign rDNA”. It continues to multiply with the foreign DNA or gene of interest. After a short time, this results in a colony of bacteria having rDNA fragments. Each colony is grown separately to obtain multiplication of rDNA fragments. At the end we get a number of colonies having identical copies of rDNA fragments. This is called **molecular cloning** or **gene cloning**.

Once the gene for the production of human insulin from pancreatic cells is introduced into *E.coli*, the recipient cell produces human insulin. This is the way by which the human insulin is made to be produced by bacterial cell such as *E.coli*.

### ***Gene transfer in plants***

*Agrobacterium tumefaciens* is a soil inhabiting bacterium and has Ti (tumor inducing) plasmid. This bacterium invades crops such as tomato, sunflower, brinjal and cotton and causes crown gall disease which is in the form of tumorous growth. The Ti plasmid carried by the pathogenic bacterium causes tumours. For effective cloning of foreign genes by the plant cells, and for introduction of genes into plant system, *Agrobacterium* strains are modified by the removal of tumour – inducing genes from the bacterium. T-DNA is the part of Ti plasmid transferred into plant cell DNA. The T-DNA which holds the desired foreign gene after splicing is introduced into the plant cell. The bacterial plasmid do not produce tumorous growth since the gene had been deleted. Once the T-DNA along with the spliced gene is introduced, it combines with the chromosome of the donor cell where it produces copies of itself, by migrating from one





**Fig. 4.2. Gene transfer in plants**

chromosomal position to another. Through tissue culture methods, such plant cells are cultured, induced to multiply and differentiate to form into plantlets. The plantlets are transplanted to soil, where they are allowed to express the foreign gene introduced into them when they multiply and grow in larger population.

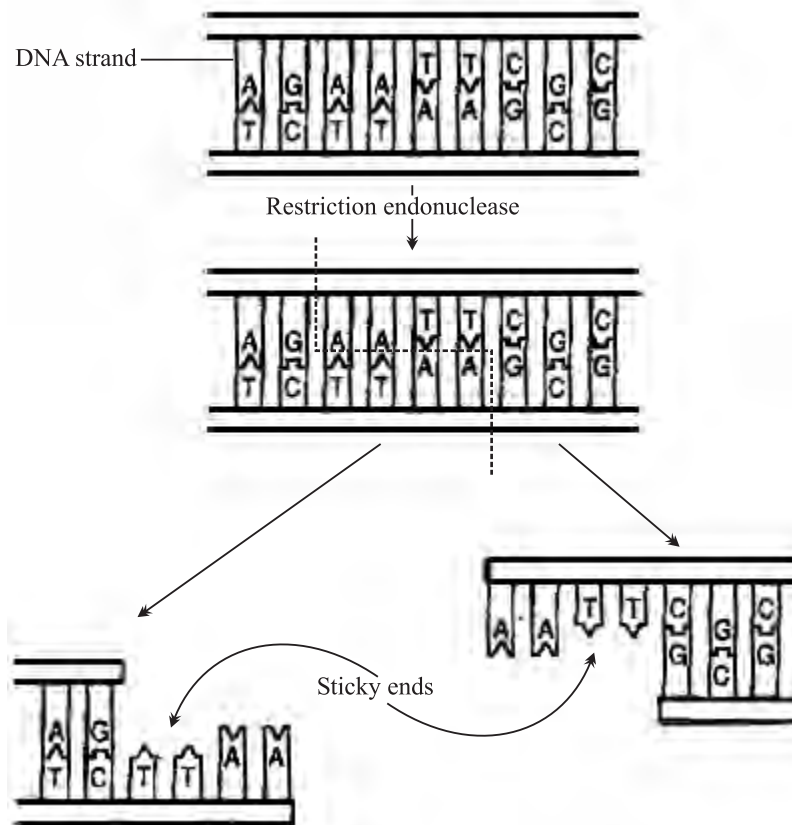
#### **How DNA is cut?**

All bacteria produce atleast one type of restriction enzymes. They are meant to help the recombinant researchers to enable them to cut the DNA but to help in the very survival of the bacterial species against the invading bacterial viruses. The restriction enzymes can chop up and render harmless invading viral DNA. Restriction enzymes cleave DNA at very specific places along its length. The restriction enzyme ECORI (*E. coli* Restriction Enzyme I) produced by the intestinal bacterium *E. coli* recognizes the following sequence.

Two DNA molecules with sticky ends (ends that are staggered or uneven) tend to join with other molecules with a complementary sequence of nucleotides in the ends. With the same enzyme, DNA fragments are cut with the matching sequence of nucleotides which complements with the sticky ends.

***Action of restriction enzyme***

Fragments of DNA from different organisms or even from different species may be joined together at their sticky ends, thereby producing recombinant DNA. This is made possible by the use of an enzyme called ligase. Hence, ligase is used to join the two DNA fragments.



***Fig.4.3. Action of restriction enzyme***

Restriction enzyme and ligase do not care about the source of DNA. Whenever the correct sequence of nucleotides are met with by the specific restriction endonuclease, it cuts it. Similarly whenever the correct sequences of nucleotides at their sticky ends in the two strands are met with, these are ligated (joined) by the enzyme ligase.

***Advantages of recombinant DNA***

A sample of therapeutic drugs presently manufactured through recombinant DNA is found in the table given below.

***Genetically engineered products***

| S.No | Products             | Functions   |
|------|----------------------|---|
| 1.   | Human growth hormone | Promotes growth in children with hypopituitarism                |
| 2.   | Interferon           | Helps the cells resist viruses.                                 |
| 3.   | Interleukin          | Stimulates the proliferation of WBCs that take part in immunity |
| 4.   | Insulin              | Treats diabetes   |
| 5.   | Renin inhibitors     | Decreases blood pressure.                                       |

**Self evaluation**

***I. Choose and write the correct options.***

1. Restriction enzymes are synthesized by
  - a. bacteria only
  - b. yeast and bacteria only
  - c. eukaryotic cells only
  - d. all kinds of cells
2. Each restriction enzyme cleaves a molecule only at
  - a. the ends of genes
  - b. methyl groups
  - c. nucleotide sequence
  - d. the time of DNA replication

**II. Answer the following questions in two or three sentences.**

3. Define recombinant DNA.
4. Name the enzymes involved in the making of a DNA hybrid.
5. What are restriction endonucleases?
6. What is the importance of *Escherichia coli* in biotechnology?
7. What is the role of restriction enzymes in bacteria?
8. Define splicing.

**III. Answer the following questions in about 100 words.**

9. What is a cloning vector? Why are they necessary?
10. Give an illustrated account of gene cloning.
11. What is the role of *Agrobacterium* for gene transfer in plants?
12. How is DNA cut?

**IV. Answer the following questions in about 200 words**

13. Write an essay on DNA recombinant technology.

## 4.2 Transgenic plants

### *Introduction of foreign gene*

In genetically engineered plant cells, a bacterium *Agrobacterium* is mainly involved in transfer of foreign gene. However, *Agrobacterium* cannot infect all plants since it has a narrow range of host specificity. Therefore other techniques have been developed to introduce foreign DNA into plant cells. Novel methods of ensuring DNA uptake into cells include electroporation and mechanical delivery or biolistics.

**Electroporation** is a process of creating temporary pores in the cell membrane by application of electric field. Creation of such pores in a membrane allows introduction of foreign molecules such as DNA, RNA, antibodies, drugs, etc. into cytoplasm. The development of this technique is due to contribution of biophysics, bioengineering, cell and molecular biology. While the technique is now used widely to create transgenic microorganisms, plants and animals, it is used increasingly for application of gene therapy.

**The mechanical particle delivery or gene gun methods** to deliver DNA on microscopic particles into target tissue or cells. The process is increasingly used to introduce new genes into a range of bacterial, fungal plant and mammalian species. It is the main method of choice for genetic engineering of many plant species including rice, corn, wheat, cotton and soyabean.

### *Transgenic (modified) plants*

Presently, more than 50 types of genetically engineered plant species, called transgenic plants have been successfully developed. These plants were made to resist insect pests, viruses or herbicides through incorporation of foreign gene into DNA of host plant cells. Initially transgenic plants were developed more in dicotyledons, but now extended to several monocotyledons like wheat, maize, rice and oats. Transgenic plants have also been developed and are suitable for food industries (delaying ripening in tomato).

Gene pharming, the use of transgenic plants as bioreactors or factories for production of speciality chemicals and pharmaceuticals is being pursued

by a number of firms. Plants have been engineered to produce human proteins, such as hormones, in their seeds. A weed called mouse-eared cress has been engineered to produce a biodegradable plastic (polyhydroxybutyrate, or PHB) in tissue granules.

#### ***Transgenic dicotyledonous plants***

1. *Nicotiana tabacum*
2. *Beta vulgaris*
3. *Glycine max*
4. *Helianthus annuus*
5. *Solanum tuberosum*
6. *Gossypium hirsutum*

#### ***Transgenic monocotyledonous plants***

1. *Asparagus sp.*
2. *Oryza sativa*
3. *Zea mays*
4. *Avena sativa*

#### ***Herbicide resistance in transgenic plants***

Under normal circumstances, herbicides affect photosynthesis or biosynthesis of essential amino acids. Under field conditions, application of herbicides not only kills the unwanted weeds but also greatly affects the field crops. In order to protect the crops against exposure to herbicides, scientists after intensive research isolated a gene from *Streptomyces hygroscopicus* which encodes an enzyme, capable of inactivating the herbicide 'Basta'. Transgenic plants with this gene have been developed, demonstrating effectiveness of this gene for protection against herbicide 'Basta'. Thus, herbicide-tolerant crop plants have now been developed by genetically manipulating plant genomes resistant to specific herbicides.

#### ***Improved resistance to insect pests and microbial diseases***

Genes from *Bacillus thuringiensis* (Bt<sub>2</sub>) have been introduced into several crops, including tomato and cotton, and field-testing has demonstrated impressive results against many pests. Spore preparation of this bacterium is used as a biological insecticide during the last 20 years. Insecticidal activity depends on a toxic protein called **delta endotoxins**. The toxin gene (Bt<sub>2</sub>) from *Bacillus thuringiensis* has been isolated and used for *Agrobacterium*. Ti plasmid mediated transformation of tobacco, cotton and tomato plants. The transgenic plants were resistant to the *Manduca sexta*, a pest of tobacco. India had acquired technology from U.S.A. for

introducing Bt toxin gene in cotton for the development of resistance against pests in this major cash crop of India. Widespread use of insecticides, fungicides and pesticides for crop protection undoubtedly has damaging effects on the environment and hence it is important to improve the control of pests and diseases by genetic means. Genetic modification of plants is an attempt for ecofriendly measures against environmental degradation.

Through genetic modification, the oil-producing soya bean was tailored to produce a wide range of industrial lubricants, cosmetic compounds and detergents that are biodegradable. A whole new area of biotechnology has been opened up and plants are made to synthesize many novel substances including functional human antibody fragments.

#### ***Practical application of genetic transformation***

- By genetic manipulation, it is possible to obtain plants with insecticidal property. Thus, application of chemical pesticides to the crop plants is reduced.
- Genetic manipulation is also carried out in crops for making desirable storage proteins, vitamins, amino acids and for the suppression of antinutritional protein synthesis.
- Plants are made to produce large amount of secondary metabolites having high commercial value.
- Losses during storage and transport of some crops can be as high as 80 per cent. This is mainly due to biological activities - bruising, heat and cold damage in soft fruits and vegetables. In tomato the enzyme *polygalactronase* breaks down cell wall constituents, thus leading to softening of the fruit during ripening. By inhibiting the *polygalactronase* by antisense genes the tomato can remain dormant fresh until mature and be transported in a firm solid state. Antisense RNA is a RNA molecule capable of controlling and expression of particular enzymes which are involved in ripening processes.
- Genetic manipulation of flower and leaf colour, abundance of flowers, perfume and shape are now the major targets for decorative plant industries.

### *Transgenic microbes*

The genetically engineered micro-organisms are being used for the commercial production of some non-microbial products such as insulin, interferon, human growth hormone and viral vaccines.

#### *Use of genetically engineered bacterial strain*

In 1979, for the first time Anand Mohan Chakrabarty, an Indian born American scientist developed a strain of *Pseudomonas putida* that contained a hybrid plasmid derived by combining parts of CAM and OCT. (CAM and OCT are the plasmids which contain the genes responsible for the decomposition of the hydrocarbons like **cam**phor and **oct**ane respectively present in the oil.) This strain could grow rapidly on crude oil because it was capable of metabolizing hydrocarbons more efficiently. The bacterial strain called the superbug was produced on a large scale in laboratory, mixed with straw and dried. When the straw was spread over oil slicks, the straw soaked up the oil and bacteria broke up the oil into non-polluting and harmless products. In this way, pollution of land and water due to the oil slicks can be remedied and the phenomenon is called **bioremediation**. It is defined as the use of living microorganisms to degrade environmental pollutants or prevent pollution. The contaminated sites are restored and future pollution is prevented.

#### *Benefits from release of genetically modified microorganisms into the environment.*

- *Protection of environment - Bioremediation of polluted environment.*
- Microorganisms producing enzymes for food industry.
- Microorganisms with improved efficiency of fermentation.
- Improved microorganisms for milk industry.
- Microorganisms as live attenuated vaccines for health care.
- Increasing efficiency of plant nutrition, pest control (safe biopesticides), protection of plants from climatic stress and protection of plants from tumour formation and disease.

### **Self evaluation**

#### **I. Choose and write the correct options.**

1. One of the following process is employed to introduce a foreign gene into a cell
  - a. electrolysis
  - b. electroporation
  - c. plasmid
  - d. ligation



2. The number of transgenic plants available to-day are approximately
  - a. six
  - b. two
  - c. twelve
  - d. fifty
3. A toxic protein called delta endotoxin is insecticidal and it is produced by
  - a. *Escherichia coli*
  - b. *Streptomyces griseus*
  - c. *Bacillus thuringiensis*
  - d. *Bacillus lactii*
4. *Pseudomonas putida* is a engineered bacterium that can
  - a. produce a hormone
  - b. produce a antibiotic
  - c. digest crude oil slick
  - d. pollute the soil

**II. Answer the following questions in two or three sentences.**

5. Define biopesticides.
6. Define transgenic plants.
7. What is the importance of *Agrobacterium tumefaciens*?
8. What is gene gun method of delivery of DNA?
9. Give the binomials of atleast two dicot transgenic plants.

**III. Answer the following questions in about 100 words.**

10. What is the role of transgenic plants in food industry?
11. Give a brief account of herbicide resistance in transgenic plants.
12. How are foreign genes introduced into the plants?

**IV. Answer the following questions in about 200 words.**

13. What is the role of Bt toxin in crop protection against pest? Explain the action of biopesticide.
14. Write an essay on transgenic plants.

### **4.3. Plant tissue culture and its application**

#### ***Plant tissue culture***

Growing the plant cells, tissues and organs on a artificial, synthetic medium under controlled conditions is called plant tissue culture. Plant tissue culture has become a major thrust area in plant biotechnology.

#### ***Concept***

The basic concept of plant tissue culture is totipotency, differentiation, dedifferentiation and redifferentiation.

#### ***Totipotency***

The inherent potential of any living plant cell to develop into entire organism is called totipotency. This is unique to plant cells.

#### ***Differentiation***

The meristematic tissue is differentiated into simple or complex tissues.

#### ***Dedifferentiation***

Reversion of mature tissue into meristematic state leading to the formation of callus is called dedifferentiation.

#### ***Redifferentiation***

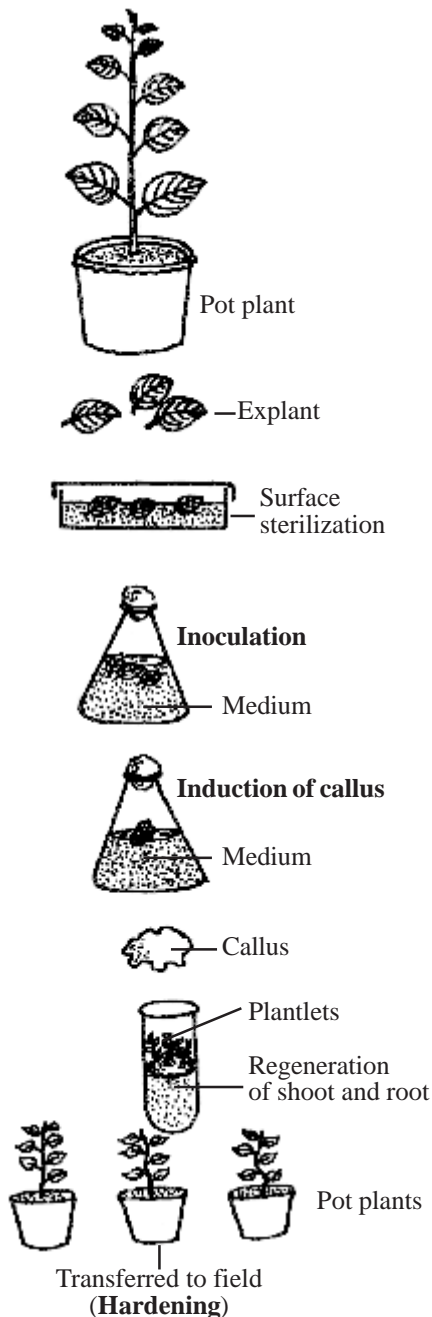
The ability of the callus to develop into shoot or root or embryoid.

#### ***The origin and development of plant tissue culture***

The beginning of plant tissue culture was made as early as 1898, when a German Botanist G. Haberlandt successfully cultured individual plant cells, isolated from different tissues. But only during 1934 to 1939, a foundation of plant tissue culture was laid down by three scientists (Gauthret, White and Nobecourt) due to discovery of plant growth regulators such as auxins and vitamins.

During next twenty years (1940 to 1960) a variety of growth regulator such as cytokinins were identified for their effect on cell division, growth and differentiation.

After 1960, in vitro culture of plant cells, tissues and organs was reasonably well developed. Research in this area was initiated in early



**Fig. 4.4 Techniques of tissue culture**

1960s by Prof. P. Maheshwari and Prof. S. Narayanaswamy at the Department of Botany, University of Delhi in India. Consequently, media and culture techniques for a variety of plant materials became known, which are now extensively utilised in all areas of plant improvement programmes.

**Basic techniques of plant tissue culture**

**1. Culture vessels**

The culture vessels used for plant tissue studies includes Erylenmayer flask (conical flask), petri plates and culture tubes (25 x 150mm).

**2. Culture medium**

The important media used for all purpose experiment are Murashige and Skoog medium (MS medium), Gamborg medium (B5 medium), White medium (W medium) and Nitsch medium. The culture medium is closed with cotton plug/ or aluminium foil sheet. The pH of the medium is adjusted to 5.8 (acidic range).

**3. Sterilization**

Sterilization is the technique employed to get rid of the microbes such as bacteria and fungi in the culture medium and plant tissues. So, it is important to sterilize the culture medium and plant tissue.

The culture medium can be sterilised by keeping it in an autoclave and maintaining the temperature of 121°C for 15 minutes. The plant tissue (inoculum) is to be surface sterilised.

#### ***Chemical sterilization***

By treating the inoculum in any one of the chemical sterilizant such as Sodium hypochlorite, Calcium hypochlorite, Mercury chloride for 15 to 20 minutes followed by repeated washing in sterile water upto 3 to 5 times.

#### **4. *Inoculation***

Transfer of explant (root, stem, leaf, etc.) on to a culture medium is called inoculation. The inoculation is carried out under aseptic condition for which an apparatus called laminar air flow chamber is used. Flamed and cooled forceps are used for transfer of plant materials to different culture media kept in glasswares.

#### **5. *Incubation***

The culture medium with the inoculum is incubated at  $26 \pm 2^{\circ}\text{C}$  with the light intensity at 2000 to 4000 lux (unit of intensity of light) and allowing photoperiod of 16 hour of light and 8 hours of darkness.

#### **6. *Induction of callus***

Due to activity of auxins and cytokinins, the explant is induced to form callus. The callus is an unorganized mass of undifferentiated tissue. The mechanism of callus formation is that auxin induce cell elongation and cytokinin induces cell division as a result of which masses of cells are formed.

#### **7. *Morphogenesis***

Formation of new organs from the callus under the influence of auxin and cytokinin is called morphogenesis. Roots and shoots are differentiated from the callus. Such embryos are called somatic embryos result in the formation of young plantlet.

There are two types of morphogenesis

##### ***a. Organogenesis***

Formation of new organs such as shoot and root is known as organogenesis. The development of shoot from the callus is called caulogenesis and formation of root is called rhizogenesis respectively.

### ***b. Embryogenesis***

Formation of embryos (ie. bipolar structure having shoot and root) from the callus is called embryogenesis. These embryos arise from somatic callus tissue and are called somatic embryos or embryoids or somaclonal embryos.

### ***8. Hardening***

Exposing the plantlets to the natural environment in a stepwise manner is known as hardening. Finally the plantlets are gradually transferred to the soil.

### ***Status of tissue culture technology in India***

India is reported to have one of the largest groups of tissue culture scientists in the world. Most of the research is directed towards the development of improved plants for agriculture, horticulture and forestry using tissue culture methods.

The Department of Biotechnology (DBT), Government of India, New Delhi is playing a vital role in promoting research in the area of plant tissue culture. Several laboratories are being supported by providing funds for development of tissue culture technology for the improvement of crop plants.

The important Biotechnology centres are

- i. *Indian Agricultural Research Institute (IARI)*, New Delhi.
- ii. *Bhaba Atomic Research Centre (BARC)*, Mumbai.
- iii. *Central Institute of Medicinal and Aromatic plants (CIMAP)*, Lucknow.
- iv. *Dr.M.S. Swaminathan Research Institute (MSSRI)*, Chennai.

### ***Applications of plant tissue culture***

- Several commercial establishments now routinely use micropropagation for different foliage and ornamental plants.
- Through tissue culture methods using bud proliferation and multiple shoot formation, ornamental plants are produced in large numbers.
- Virus free germplasm are produced through apical meristem culture eg. banana.
- Artificial synthetic seeds are produced through somatic embryogenesis.

- Plant tissue culture is an important technique for the production of secondary metabolites in large quantities.
- Tissue culture helps in induction of haploidy in anther culture ie. useful for mutation breeding, triploidy through endosperm culture for inducing parthenocarpic fruits and polyploidy for increase in biomass or yield.
- Embryo culture technique is applied to overcome embryo abortion, seed dormancy and self-sterility in seeds.
- In recent years, plant tissue culture methods are employed in plants for the introduction of foreign gene into plant cells through DNA coated microparticles and delivering these particles into a host cell by using a gene gun.
- Protoplasmic fusion encourages genomes of incompatible crops to come together to form somatic hybrids.
- Plant tissue culture is applied in the area of plant physiological and biochemical research to study the cell cycle, metabolism in cells, nutritional, morphogenetical and developmental studies in plants.
- By plant tissue culture techniques, a plant cell of potato and tomato were brought together through protoplasmic fusion and the hybrid cell was made to develop into a pomato plant. In pomato, the stem bears the tubers and the branches produced tomatoes.

### **Self evaluation**

#### ***I. Choose and write the correct options.***

1. The inherent potential of any living plant cell to develop into entire organism is called
 

|                    |                  |
|--------------------|------------------|
| a. differentiation | b. organogenesis |
| c. morphogenesis   | d. totipotency   |
2. The function of cytokinin is to increase
 

|                    |                     |
|--------------------|---------------------|
| a. cell elongation | b. fruit initiation |
| c. cell division   | d. differentiation  |
3. By the application of tissue culture, one important product is formed
 

|                               |                         |
|-------------------------------|-------------------------|
| a. artificial synthetic seeds | b. many seeded fruit    |
| c. triploid endosperm         | d. induction of flowers |

**II. Answer the following questions in two or three sentences.**

4. Define callus.
5. What is a somatic embryo?
6. Write a note on totipotency.
7. What is dedifferentiation?
8. Mention two media of plant tissue culture
9. What is sterilization?
10. Define inoculation.

**III. Answer the following questions in about 100 words.**

11. What are the major procedure for rearing callus growth?
12. Briefly mention the principles involved in plant tissue culture.
13. Write a short account of the origin of tissue culture.

**IV. Answer the following questions in about 200 words.**

14. What are the outcomes of application of plant tissue culture?
15. Write an essay on plant tissue culture.

#### **4.4. Protoplast fusion**

Protoplasts are cells without a cell wall but bound by a plasma membrane. The isolated protoplasts are totipotent. Because of this unique property, plant protoplasts play a vital role in the field of genetic engineering. Protoplast technology includes the isolation, culture and fusion of higher plant protoplasts leading to the production of entire plants. You will be studying the method of isolation and fusion of protoplast in this chapter.

A hybrid produced by fusion of somatic cells of two varieties (or) species is called somatic hybrid. This process of producing somatic hybrids is known as somatic hybridization. The first step in somatic hybridization is the isolation of protoplast.

##### ***Isolation of protoplast***

Protoplast can be isolated from a variety of plant tissues using either mechanical (or) enzymatic methods.

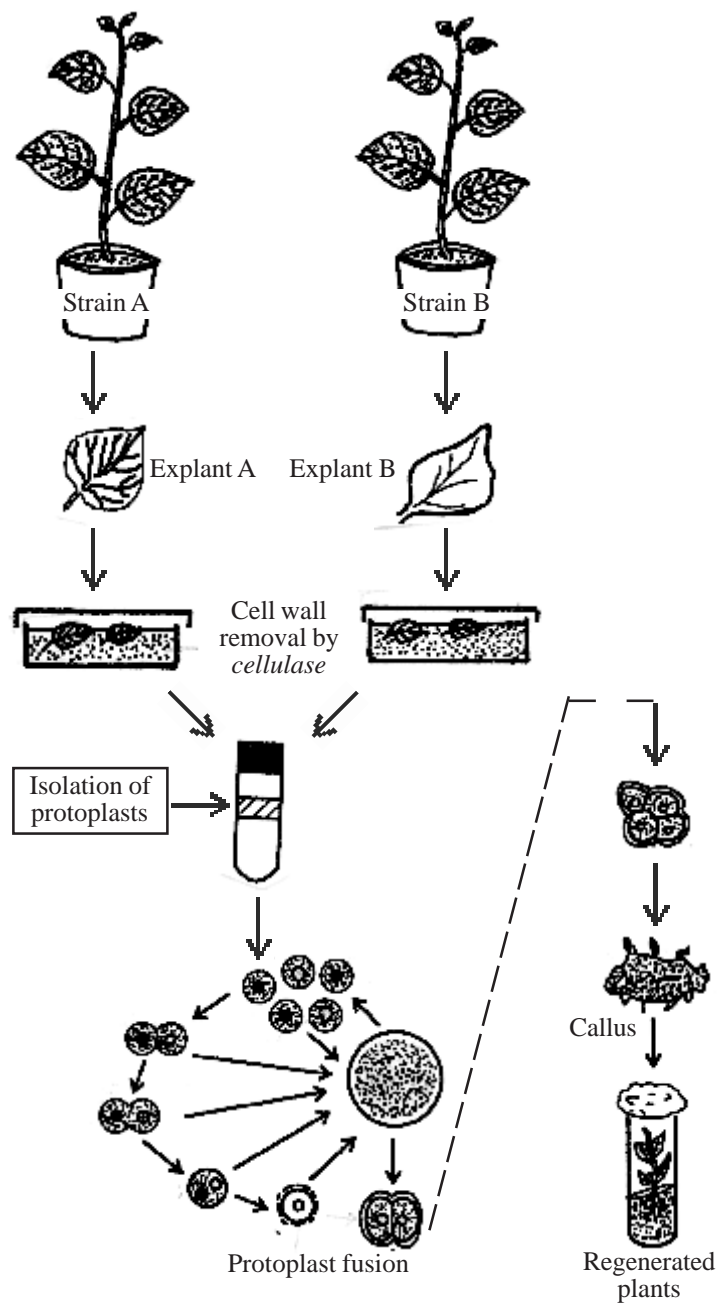
##### ***Mechanical method***

In this method, cells are kept in a suitable plasmolyticum (protoplast shrink away from cell wall in a plasmolysed cell) and cut with a fine knife, so that protoplasts are released from cells through the opening of the cell wall. This method gives poor yield of protoplast and it is being rarely used.

##### ***Enzymatic method***

Leaves from a 10 week old plant are sterilized with 70 per cent alcohol and then treating them with 2 per cent solution of sodium hypochlorite for 20 to 30 minutes. The leaves are then washed with sterile water and subsequent procedures are done under aseptic conditions (using laminar air flow chamber). The lower epidermis of the leaf is peeled off and the leaf is cut into small fragments. From the peeled leaf segments, the protoplasts are isolated. For isolation of protoplast, peeled leaf segments are placed with their lower surface downwards in a petridishes containing the enzyme mixture, which consists of 0.5 per cent macerozyme, 2 per cent *cellulase* in 13 per cent sorbitol or mannitol at pH 5.4. Finally the protoplasts are released and are kept in the isotonic solution.





**Fig.4.5 Protoplasmic fusion**

### ***Protoplasmic fusion***

Protoplast fusion facilitates mixing of two genomes and could be exploited in crosses which are not possible by conventional techniques due to incompatibility. Even though transfer of a single gene from one plant to another is desirable and protoplast fusion facilitates easy monitoring of cell genetic changes. Protoplast fusion could be spontaneous during isolation of protoplast or it can be induced by mechanical, chemical and physical means.

The isolated protoplasts are kept in isotonic solution (mannitol and enzyme mixture) to prevent damage. The isolated parent protoplasts are fused with a fusogenic agent like Polyethylene glycol (PEG). It is followed by nuclear fusion and results in a somatic hybrid. The somatic hybrids are allowed to grow in the same culture medium. The fused protoplast are then induced to regenerate the cell wall by transferring it into a suitable medium. This is followed by callus formation which leads to regeneration and organization of tissues.

### ***Practical applications of protoplasmic fusion***

Due to the existence of incompatibility prevailing between different species, protoplasmic fusion greatly compensates for interspecific hybridization. Somatic hybrids between rice and carrot were produced only through the process of protoplasmic fusion. Somatic hybrids may be used for gene transfer, transfer of cytoplasm and production of useful allopolyploids.

### **4.5. Single cell protein**

Microorganisms have been widely used for preparation of a variety of fermented foods. Eg. cheese, butter, idlis, etc., in addition, some microorganisms have long been used as human food, eg. the blue green alga *Spirulina*, and the fungi commonly known as mushrooms. More recently, efforts have been made to produce microbial biomass using low-cost substrates and use as a supplemental food for human consumption or used as feed for animals. Cells from a variety of micro-organisms, viz., bacteria, yeasts, filamentous fungi and algae used as food or feed are called single cell protein (SCP).

The term 'single cell protein' was coined in 1966. The dried cells of microorganisms used as food or feed for animals and they are collectively known as Microbial proteins. This term was replaced by a new term 'single cell protein'. The isolated protein or the total cell material is called the SCP.

In view of the insufficient world food supply and the high protein content of microbial cells, the use of biomass produced in the fermentor (special sterilized vessel) or bio-reactor would be ideal supplement for conventional food. Single cell protein is of great nutritional value because of its high protein, vitamin and lipid content and for its essential amino acids. In many countries, however people hesitate to use SCP as a major food source because of the following -

- The high nucleic acid content (4 to 6 per cent in algae, 6 to 10 per cent in yeast of SCP) can cause health problems like uric acid formation, kidney stones and rheumatism in human beings.
- Toxic or carcinogenic (cancer causing) substances absorbed from the microbial growth substrate may be present.
- Slow digestion of microbial cell in the digestive tract may cause vomiting, indigestion and allergic reaction.
- High cost of production will also be a deciding factor in determining the ultimate place of SCP in the human or animal diet.
- The following substrates are being studied for SCP production: alkanes, methane, methanol, cellulose, carbohydrates and waste materials.
- Natural sources like wood chips, rice husk, cane and beet molasses, peas and coffee industrial waste from which cellulose is obtained and are used for the production of SCP.
- Large scale cultivation of yeast on molasses is widely used in the manufacture of Baker's yeast containing mycoproteins which is used in the SCP production.
- Domestic sewage is not suitable for large scale SCP production. But it is more important for methane production. The industrial wastewater from cellulose processing, coffee and starch production, and food processing have been used for SCP production.

### ***Organisms used for SCP production***

|                 |  |
|-----------------|--|
| <b>Algae</b>    | <i>Chlorella, Spirulina and Chlamydomonas.</i>                       |
| <b>Fungi</b>    | <i>Saccharomyces cerevisiae, Volvoriella and Agaricus campestris</i> |
| <b>Bacteria</b> | <i>Pseudomonas and Alkaligenes</i>                                   |

### ***Uses of SCP***

1. It is a rich source of protein (60 to 72 per cent), vitamins, amino acids, minerals and crude fibres.
2. It is a popular health food. Nowadays, *Spirulina* tablets are prescribed as enriched vitamin for most people.
3. It provides valuable protein-rich supplement in human diet.
4. It lowers blood sugar level of diabetics due to the presence of gamma-linolenic acid and prevents the accumulation of cholesterol in human body.

### **Self evaluation**

#### ***I. Choose and write the correct options.***

1. The two protoplasts are fused with a fusogen called
  - a. polyethylene glycol (PEG)
  - b. Polyvinyl chloride (PVC)
  - c. Polyethane glycol (PEG)
  - d. Phosphoric ethane
2. Somatic hybrids are produced through
  - a. asexual fusion
  - b. protoplasmic fusion
  - c. vegetative propagation
  - d. grafting
3. One of the following organism is a SCP
  - a. *Nostoc*
  - b. *Rhizobium*
  - c. Mushroom
  - d. *Spirulina*
4. Enriched vitamin tablets are produced from the following organism for human consumption
  - a. *Nostoc*
  - b. yeast
  - c. Mushroom
  - d. *Spirulina*

#### ***II. Answer the following questions in two or three sentences.***

5. Define SCP.
6. What is somatic hybridization?
7. What is a bioreactor or fermenter?

8. What is PEG?
9. How do you remove cell-wall from intact cells?
10. Why is SCP not popular for human consumptions?

***III. Answer the following questions in about 100 words.***

11. Give an account of SCP.
12. Explain the enzymatic method of isolation of protoplast.
13. Mention some of the practical applications of protoplasmic fusion.

***IV. Answer the following questions in about 200 words.***

14. Explain as to how protoplasmic fusion can bring about somatic hybridization in plants.
15. What will be the role of SCP to safeguard against human protein deficiency for the future?

***Reference***

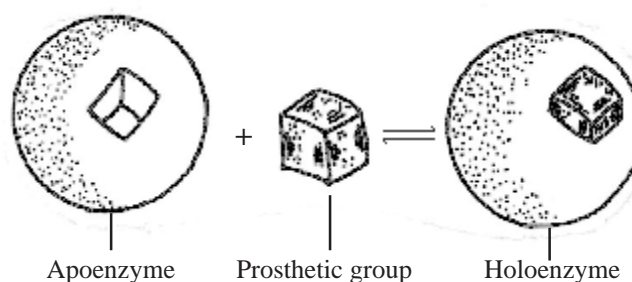
1. Elementary princi. of Plant breeding by Chaudhari Oxford and IBH 1998.
2. Plant biotech. Adrian Slater, Nigel and Mork Powler Oxford Uni. 2003.
3. Plant biotechnology by S.S. Purohit and Agrobios - India 2003.
4. Application of Plant biotechnology by S. Ignacimuthu, 1996
5. Plant cell, tissue and organ culture - fundamental methods by Gamburg and Phillips, 1995.
6. Biotechnology by John E. Smith, Cambridge, 1996

## 5. PLANT PHYSIOLOGY

Plant physiology is the branch of biological science, which deals with the functioning, and interrelationships of cells, tissues and organs of plants. Green plants have the capacity of harvesting light energy for life energy, making use of inorganic raw materials. Most of the living organisms including man depend upon this energy rich compounds of plants. Plants not only provide food but also supply required oxygen for breathing. Besides synthesizing organic compounds, plants carry other natural phenomena of living organisms such as respiration, growth and development. In this chapter, we study these natural phenomena operating in plants. Though the plants do not have respiratory, circulatory and digestive systems like animals, all these functions are carried out at cellular level.

### 5.1. Enzymes

Enzymes are biological catalysts, which activate various biochemical reactions of a living cell in a highly specific and precise manner. Enzymology is the study of enzymes. The name enzyme was coined by Kuhne in 1878. Pasteur recognised that some microorganisms like yeasts have got a capacity to cause fermentation in wine. In 1897, Buchner discovered that yeast extract could bring about fermentation of grape juice, like the living yeast cells. He also observed that the extract has lost its catalytic activity on boiling. He coined the word *zymase* for the active principle involved in the fermentation. The substance on which the enzyme acts is called substrate. Enzymes are essentially proteins but all proteins are not enzymes.



**Fig. 5.1. Protein and nonprotein part of an enzyme**

Many enzymes consists of a protein and non-protein component. They are called **holoenzymes**. The protein component of a holoenzyme is called apoenzyme and the non-protein component may be inorganic ions such as  $Mg^{2+}$  and  $Mn^{2+}$  . They are tightly attached to apoenzyme. They are called activators. The non-protein components may be organic substances such as  $NAD^+$  ,  $NADP^+$  and  $FAD^+$  . They are loosely attached to the apoenzyme. They are called **coenzyme** or **cofactors**. An enzyme will not function without its prosthetic group.

The specific region of the enzyme, which is involved in biochemical reaction, is termed active site. It is at the active site where the enzyme combines with its substrates to bring about biochemical reactions. An enzyme may have more than one active site. They are required only in very small quantities and yet capable of bringing about changes in large number of substrate molecules.

#### ***5.1.1. Classification of enzymes***

Enzymes are classified based on the kinds of reactions they catalyze.

##### **Oxireductase**

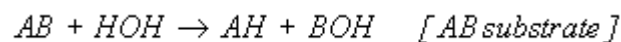
These enzymes catalyze oxidation or reduction of their substrates by removing or adding electrons from or to substrates. eg. *dehydrogenase*, *oxidase* and *reductase*.

##### ***Transferase***

These enzymes transfer a group from one substrate to other. eg. *transaminase*.

##### **Hydrolases**

These enzymes split larger molecules into smaller ones by the hydrolysis of water and breaking of specific covalent bonds. eg. *carbohydrase*.



##### **Lyases**

These enzymes catalyze the cleavage of specific covalent bonds and removal of groups without hydrolysis. eg. *Histidine decarboxylase*.

### ***Isomerases***

The enzymes that catalyze rearrangement of atoms within a molecule to form isomers are called *isomerases*. eg. *phosphohexoisomerase*.

### ***Ligases***

*Ligases* catalyze the formation of C – C, C – S, C – O and C – N bonds. The energy for the reaction is derived by the hydrolysis of ATP. eg. *pyruvate carboxylase*.

#### **5.1.2. Properties of enzymes**

- Like inorganic catalysts, the enzymes are active in very small amounts and remain unchanged on completion of the reaction.
- Enzymes are very specific in their action. i.e. a particular enzyme usually acts on a particular substrate to catalyze a particular type of reaction. But some times, the same reaction may be catalyzed by more than one enzyme. Such enzymes are called isoenzymes.
- Enzymes are very sensitive to heat. The temperature at which an enzyme shows its highest activity is called optimum temperature. The activity of enzyme declines both above and below the optimum temperature. Protein part of the enzyme is the catalytic part. Temperature above 50°C normally denatures the protein and so the enzyme loses its activity.
- The catalytic property of the enzyme is dependent on pH. The specific pH at which the enzyme activity is high is called optimum pH. Different types of enzymes have different optimum pH values. Most intracellular enzymes function well around neutral pH. *Trypsins* are active in alkaline medium, *diastase* in neutral medium while *pepsin* in acidic medium.
- Enzymes are sensitive to inhibitors. The chemical substance that combines with the enzymes and inhibits its catalytic activity is called an inhibitor. eg. Cyanides.
- In most of the cases, the reactions catalyzed by the enzymes are reversible depending upon the requirements of the cell.



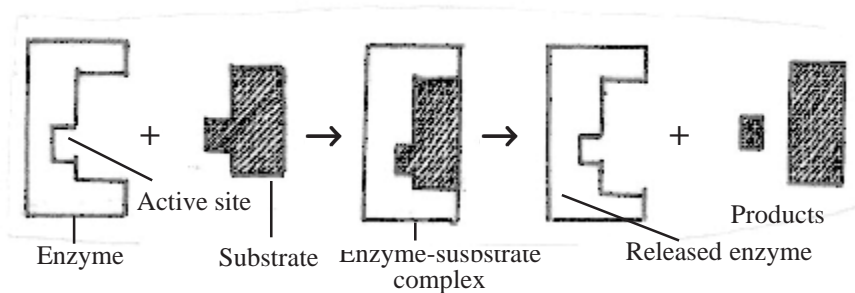


### 5.1.3. Theories explaining the mechanism of enzyme action

Two theories have been proposed to explain the mechanism and enzyme action. They are Fischer's Lock and key theory and Koshland's induced fit theory.

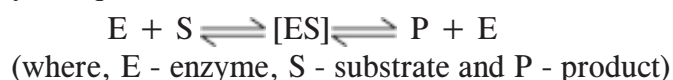
#### *Fischer's Lock and key theory*

Lock and key theory was proposed by Fisher. According to this theory, first a physical contact is made between the enzyme and the substrate. As only a specific key fits in a particular lock to open it, a specific substrate combines with the active site of specific enzyme. This combination leads to the production of **enzyme - substrate complex**. Then the enzyme



**Fig.5.2 Fischer's Lock and key theory of enzyme action**

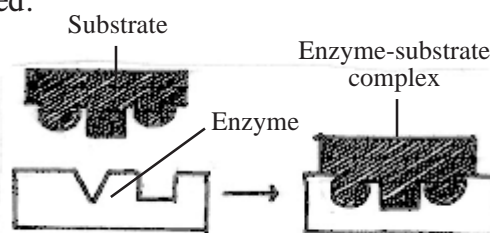
over, enzyme is released from the enzyme - substrate complex and is ready to bind with another molecule of the substrate for further action. The cyclic reaction is summarized by the equation



When a dissimilar substrate approaches the enzyme, it cannot combine with the active site of the enzyme, as a wrong key cannot open the lock. Thus, the enzyme action is inhibited.

#### *Koshland's induced fit theory*

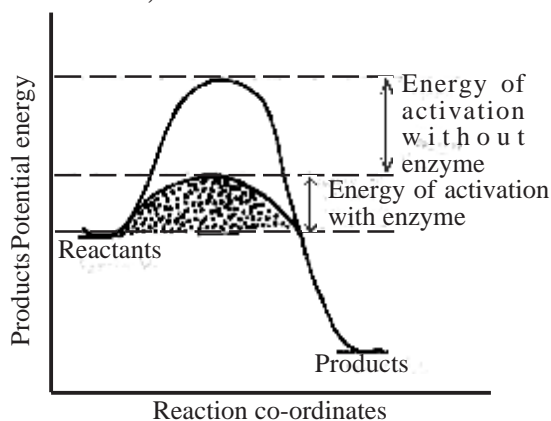
Induced fit theory was proposed by Koshland. Proteins are not rigid. The substrate induces the enzyme to adjust its shape leading to the formation of enzyme substrate complex. Then, the enzyme acts on substrate and forms products. Many enzymes function in this way.



**Fig. 5.3 Induced fit theory**

### ***Mechanism of enzyme action***

In a biochemical reaction, there is an energy barrier between the reactants and the products. Only those molecules which possess a certain amount of excess energy above the average energy of normal molecules are able to react to form products. This excess energy which a normal molecule must acquire in order to react is known as **energy of activation** ( $E_a$ ). This energy of activation determines the rate of reaction. Higher the value of  $E_a$ , lower is the rate of reaction and greater stability. At higher



***Fig. 5.4 Mechanism of enzyme action***

temperature, the rate of chemical reaction becomes faster, because increased temperature brings about increased number of activated molecules. But in the case of enzyme catalyzed reaction, the rate of reaction is optimum at normal body temperature. Because all the molecules either energy-rich or energy-poor combine with the active site of the enzyme to form enzyme substrate complex. The latter breaks into enzyme and product. Thus, the enzyme acts by lowering the energy of activation of the reactions i.e. reducing the energy barrier and increases the rate of reaction.

temperature, the rate of chemical reaction becomes faster, because increased temperature brings about increased number of activated molecules. But in the case of enzyme catalyzed reaction, the rate of reaction is optimum at normal body temperature. Because all the molecules either energy-rich or energy-poor combine with the active site of the enzyme

### **Self evaluation**

#### ***I. Choose and write the correct options.***

1. The term enzyme was coined by
  - a. Kuhne
  - b. Fischer
  - c. Buchner
  - d. Koshland
2. The lock and key theory of enzyme action was proposed by
  - a. Kuhne
  - b. Fischer
  - c. Buchner
  - d. Koshland
3. An example for *transferase* is
  - a. *transaminase*
  - b. *pyruvic carboxylase*
  - c. *histidine decarboxylase*
  - d. *G-3-P dehydrogenase*

**II. Answer the following questions in two or three sentences.**

4. What is holoenzyme?
5. Define energy of activation.
6. What is enzyme-substrate complex?

**III. Answer the following questions in about 100 words.**

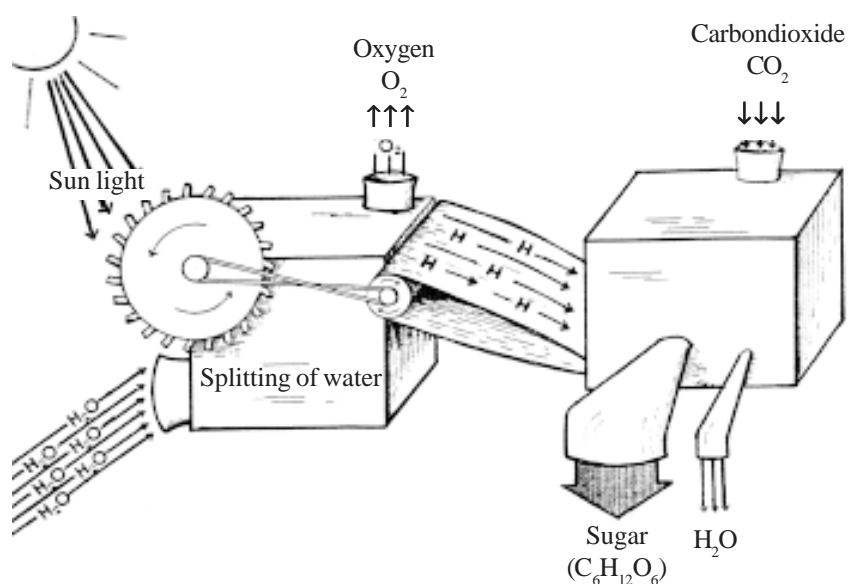
7. Bring out the characteristics of enzymes.
8. How are enzymes classified? Explain.
9. Explain energy of activation with the help of a graph.

**IV. Answer the following questions in about 200 words.**

10. Explain the theories on enzyme action.

## 5.2. Photosynthesis

Photosynthesis literally means 'synthesis with the help of light'. It is the process that gives life to all living beings. The plants convert light energy



**Fig. 5.5 Diagrammatic illustration – photosynthesis.**

into life energy. It is the only biological process that makes use of sun's light energy for driving the life machinery. Hence, photosynthesis is regarded as 'leader' of all processes both biological and abiological. It is the most fundamental of all biochemical reactions by which plants synthesize organic compounds in the chloroplast from carbondioxide and water with the help of sunlight. It is an oxidation–reduction reaction between water and carbondioxide.

### History of photosynthesis

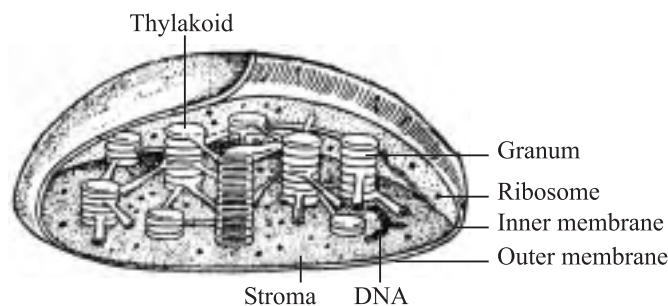
- 320 BC *Ancient Indians believed that plants fed from their feet – Padapa, refers to a plant which drinks from the feet.*
- 1727 *Stephen Hales recognised the importance of light and air in the nourishment of plants.*
- 1779 *Jan Ingen-Housz discovered that the green parts of the plant purify the polluted air in the presence of light.*
- 1782 *Senebier showed that as the concentration of CO<sub>2</sub> increases, the rate of O<sub>2</sub> evolution also increases.*
- 1845 *Von Mayer recognised that green plants convert solar energy into chemical energy of organic matter.*
- 1845 *Liebig pointed out that the organic matter was derived from CO<sub>2</sub> and water.*
- 1920 *Warburg introduced the unicellular green alga Chlorella as a suitable material to study photosynthesis.*
- 1932 *Emerson and Arnold showed that the existence of light and dark reactions in photosynthesis.*
- 1937 *Hill demonstrated photolysis of water by isolated chloroplasts in the presence of suitable electron acceptor.*
- 1941 *Ruben and Kamen used <sup>18</sup>O<sub>2</sub> to show that O<sub>2</sub> comes from water in photosynthesis.*
- 1954 *Arnon, Allen and Whatley used <sup>14</sup>CO<sub>2</sub> to show fixation of CO<sub>2</sub> by isolated chloroplasts.*
- 1954 *Calvin traced the path of carbon in photosynthesis and gave C<sub>3</sub> cycle (Calvin cycle) and was awarded Noble prize in 1960.*
- 1965 *Hatch and Slack reported the C<sub>4</sub> pathway for CO<sub>2</sub> fixation in certain tropical grasses.*

### 5.2.1. Significance of photosynthesis

- Photosynthesis is a source of all our food and fuel. It is the only biological process that acts as the driving vital force for the whole animal kingdom and for the non-photosynthetic organism.
- It drives all other processes of biological and abiological world. It is responsible for the growth and sustenance of our biosphere.
- It provides organic substances, which are used in the production of fats, proteins, nucleoproteins, pigments, enzymes, vitamins, cellulose, organic acids, etc. Some of them become structural parts of the organisms.
- It makes use of simple raw materials such as  $\text{CO}_2$ ,  $\text{H}_2\text{O}$  and inexhaustible light energy for the synthesis of energetic organic compounds.
- It is significant because it provides energy in terms of fossil fuels like coal and petrol obtained from plants, which lived millions and millions of years ago.
- Plants, from great trees to microscopic algae, are engaged in converting light energy into chemical energy, while man with all his knowledge in chemistry and physics cannot imitate them.

### 5.2.2. Site of photosynthesis

Chloroplasts are the actual sites for photosynthesis. All green parts of a plant are involved in photosynthesis. Leaves are the most important organs of photosynthesis. In xerophytes like *Opuntia*, the stem is green and it performs photosynthesis. Over half a million chloroplasts are present in one square millimetre of a leaf. It measures about 4 to 6 micron. A



**Fig. 5.6 Structure of chloroplast**

typical chloroplast of higher plants is discoid shaped. It is a double membrane bound organelle containing chlorophyll, carotenoid, xanthophyll,

cytochrome, DNA, RNA, manganese, etc. Chloroplasts are generally considerably larger than mitochondria.

The space enclosed by the envelope is filled with matrix called stroma. In the stroma, many grana are embedded. In each granum, several disc shaped lamellae are found. These disc shaped structures are called **thylakoids**. They resemble a stack of coins. This structure is known **granum**. Generally a chloroplast contains 40 to 60 grana. The photosynthetic pigments are found in grana. The stroma contains circular DNA, RNA and enzymes for starch synthesis.

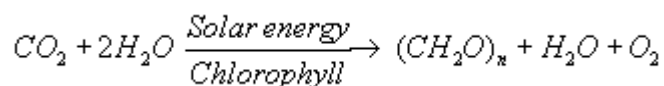
### ***5.2.3. Photochemical and biosynthetic phases***

The pigments involved in photosynthesis are called photosynthetic pigments. They are chlorophyll 'a', chlorophyll 'b', carotenoids, xanthophyll and phycobilins. Magnesium is an essential component for the formation of chlorophyll. Chlorophyll 'a' is a universal pigment present in the plants in which water is one of the raw materials for photosynthesis. Chlorophylls are highly efficient in absorbing solar energy and they are directly linked to photosynthetic electron transport. Photosynthetic pigments other than chlorophyll 'a' are generally called accessory pigments eg. chlorophyll 'b', carotenoids and xanthophyll, whereas chlorophyll 'a' is regarded as primary pigment.

Photosynthetic pigments occur in the granum. They constitute the pigment system called photosystem. About 250 to 400 pigment molecules are present in a photosystem. Two types of photosystems are found in the granum. Photosystem I (PS I) has less accessory pigments and more chlorophyll 'a', while photosystem II (PS II) has more accessory pigments and less chlorophyll 'a'. The primary function of photosystems is to trap light energy and converts it to chemical energy. The energy absorbed by accessory pigments is transferred to the chlorophyll 'a'. The granal lamella where the photosynthetic pigments are aggregated to perform photosynthetic activities is called active centre.

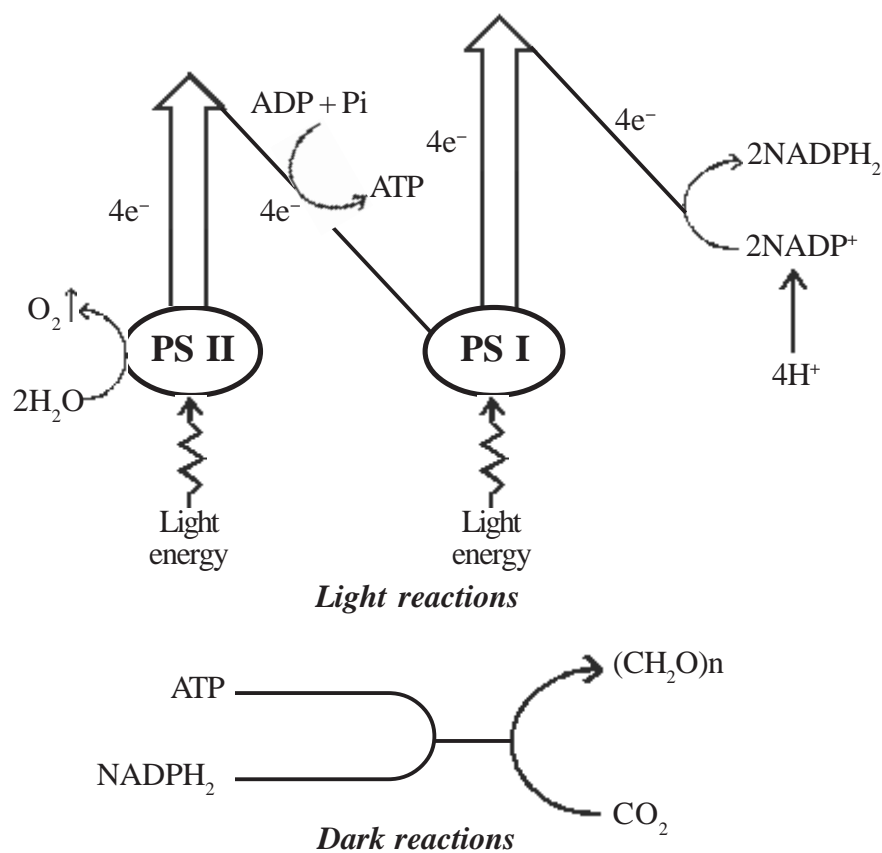
### ***Mechanism of photosynthesis***

The overall reaction of photosynthesis can be written as follows.



The reactions of photosynthesis can be grouped into two – light reactions and dark reactions. The reactions involving pigments, solar energy and water that produce ATP and NADPH<sub>2</sub> are called light reactions. The photosynthetic reactions in which CO<sub>2</sub> is reduced to carbohydrates making use of ATP and NADPH<sub>2</sub> generated by light reactions are collectively called dark reactions.

The overall process of photosynthesis is illustrated in fig. 5.7.



**Fig. 5.7 Overall scheme of photosynthesis**

#### **5.2.4. Electron transport system**

The light driven reactions of photosynthesis are referred to as electron transport chain. When PS II absorbs photons of light, it is excited and the

electrons are transported through electron transport chain of plastoquinone, cytochrome  $b_6$ , cytochrome f and plastocyanin. The electrons released from PS II phosphorylate ADP to ATP. This process of ATP formation from ADP in the presence of light in chloroplast is called **photophosphorylation**.

Now, the PS II is in oxidised state. It creates a potential to split water molecules to protons, electrons and oxygen. This light dependent splitting of water molecules is called **photolysis of water**. Manganese, calcium and chloride ions play prominent roles in the photolysis of water. The electrons thus released are used in the reduction of PS II. Similar to PS II, PS I is excited by absorbing photons of light and gets oxidised. This oxidised state of the PS I draws electrons from PS II and gets reduced. The electrons released to PS I are transported through electron transport chain of ferredoxin reducing substrate, ferredoxin and ferredoxin NADP reductase to reduce  $\text{NADP}^+$  to  $\text{NADPH}_2$ .

#### ***5.2.5. Cyclic and noncyclic photophosphorylation***

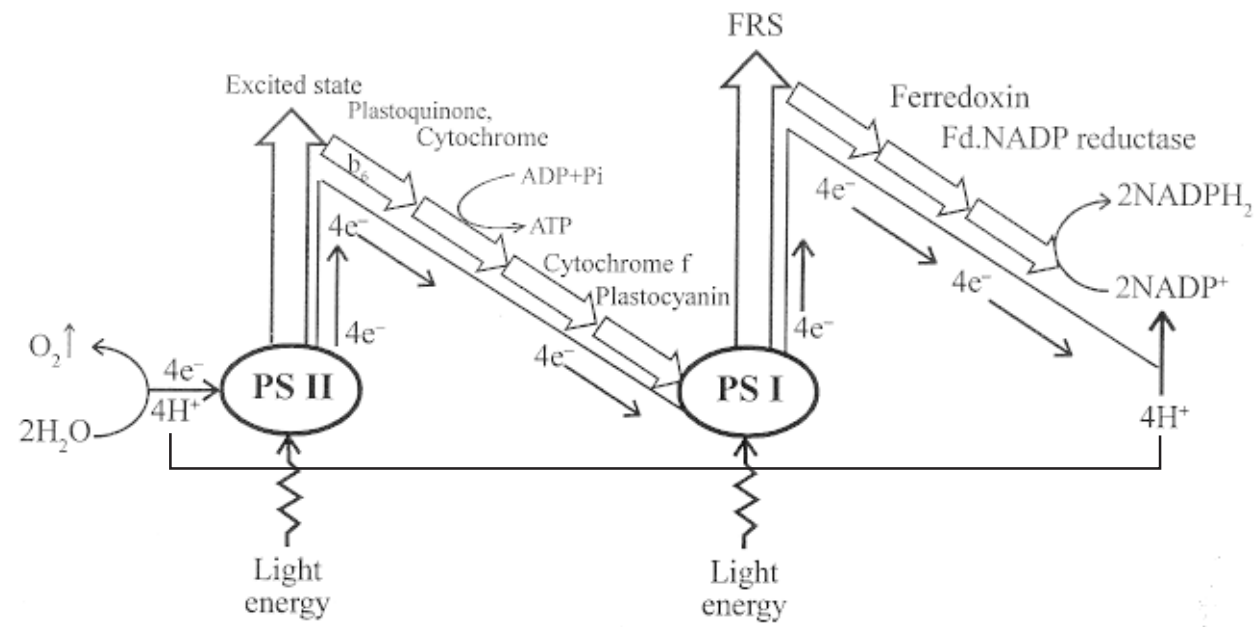
In chloroplasts, phosphorylation occurs in two ways – noncyclic photophosphorylation and cyclic photophosphorylation.

##### ***Noncyclic photophosphorylation***

When the molecules in the PS I are excited the electrons are released. So, an electron deficiency or a hole is made in the PS I. This electron is now transferred to ferredoxin to reduce  $\text{NADP}^+$ . When the molecules in the PS II get excited, electrons are released. They are transferred to fill the hole in PS I through plastoquinone, cytochrome  $b_6$ , cytochrome f and plastocyanin. When the electron is transported between plastoquinone and cytochrome f, ADP is phosphorylated to ATP.

The 'hole' in the PS I has been filled by the electron from PS II. Then the electrons are transferred from PS I to  $\text{NADP}^+$  for reduction. Therefore, this electron transport is called noncyclic electron transport and the accompanying phosphorylation as noncyclic photophosphorylation. The noncyclic electron transport takes place in the form of 'Z'. Hence, it is also called **Z-scheme**.

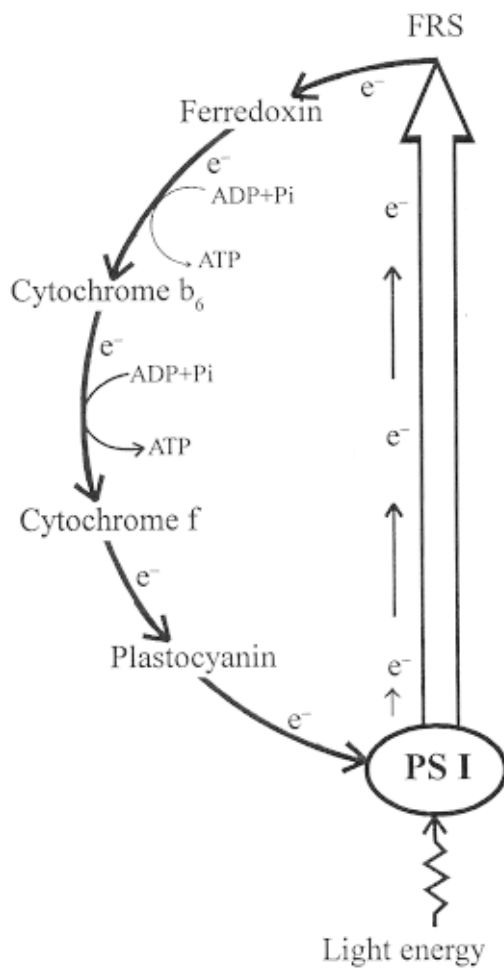




*Fig. 5.8. Non-cyclic photophosphorylation*

### ***Cyclic photophosphorylation***

Under the conditions of (i) PS I only remains active (ii) photolysis of water does not take place (iii) requirement of ATP is more and (iv)



nonavailability of NADP<sup>+</sup> the cyclic photophosphorylation takes place. When the molecule in the PS I is excited, the electrons are released. The electrons are captured by ferredoxin through ferredoxin reducing substrate (FRS). Due to non-availability of NADP<sup>+</sup>, electrons from ferredoxin fall back to the molecules of PS I through the electron carriers - cytochrome b<sub>6</sub>, cytochrome f and plastocyanin. These electron carriers facilitate the down hill transport of electrons from FRS to PS I. During this transport of electrons, two phosphorylations take place - one between ferredoxin and cytochrome b<sub>6</sub> and the other between cytochrome b<sub>6</sub> and cytochrome f. Thus, two ATP molecules are produced in this cycle.

### ***Dark reactions***

***Fig. 5.9 Cyclic photophosphorylation*** The reactions that catalyze the reduction of CO<sub>2</sub> to carbohydrates with the help of the ATP and NADPH<sub>2</sub> generated by the light reactions are called the dark reactions. The enzymatic reduction of CO<sub>2</sub> by these reactions is also known as carbon fixation. These reactions that result in CO<sub>2</sub> fixation take place in a cyclic way and were discovered by Melvin Calvin. Hence, the cycle is called Calvin cycle. Fixation of

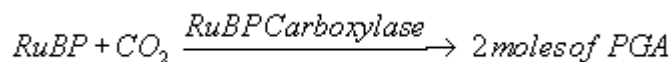
***Difference between cyclic and noncyclic electron transport and photophosphorylation***

| Cyclic photophosphorylation                                       | Noncyclic photophosphorylation  |
|---|---|
| 1. It is associated with PS I                                     | 1. It is associated with both PS I and PS II.   |
| 2. The electron expelled from chlorophyll molecule is cycled back | 2. The electrons are not cycled back but compensated by the electrons from photolysis of water. |
| 3. Photolysis of water and evolution of oxygen do not take place. | 3. Photolysis of water and evolution of oxygen take place.                                      |
| 4. Photophosphorylation takes place at two places.                | 4. Photophosphorylation takes place only at one place.  |
| 5. NADP is not reduced.   | 5. NADP <sup>+</sup> is reduced to NADPH <sub>2</sub> .   |

carbondioxide in plants during photosynthesis occurs in three stages – fixation, reduction and regeneration of RuBP.

***Fixation***

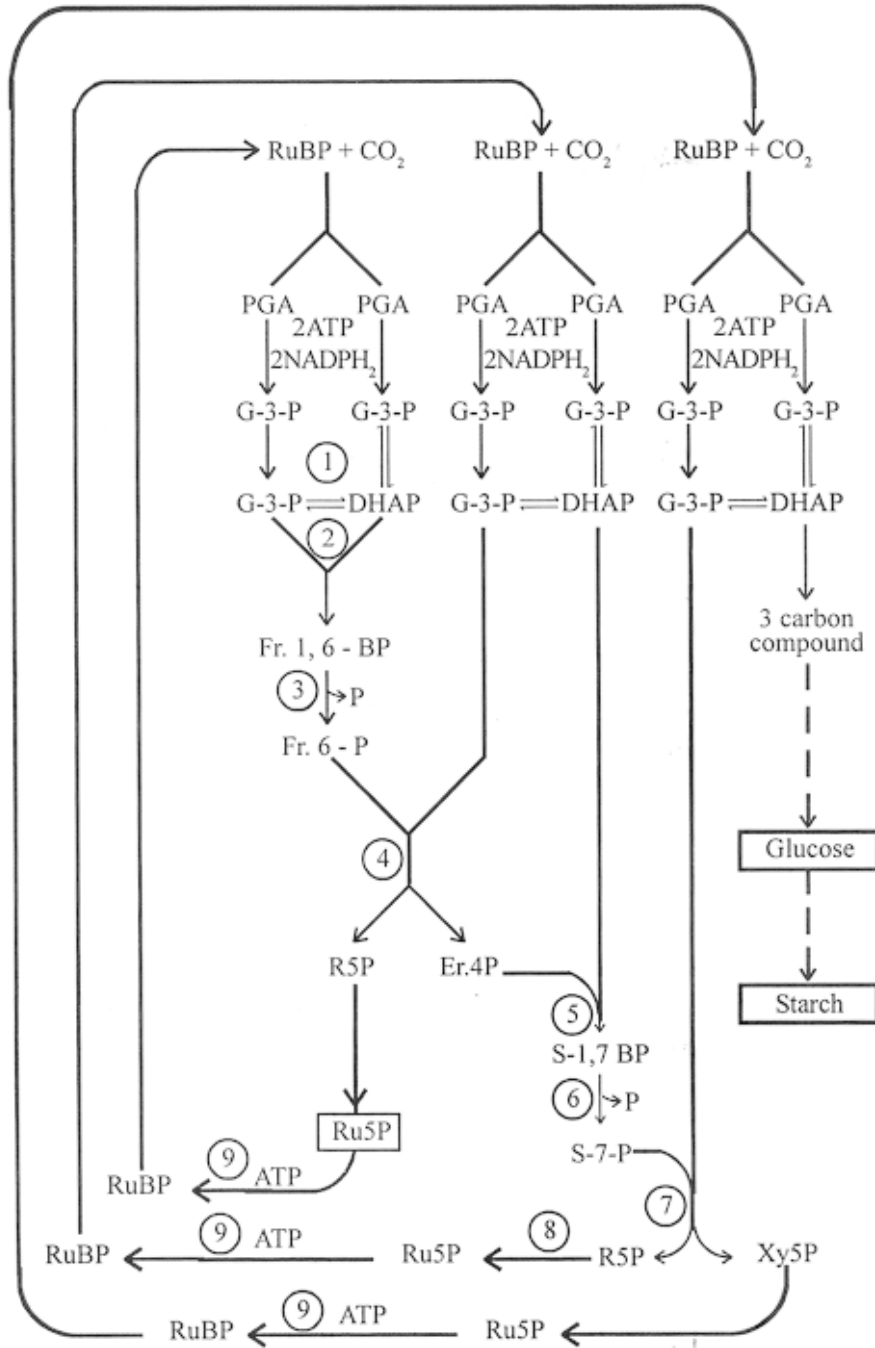
The acceptor molecule of CO<sub>2</sub> is a 5C compound called ribulose-1,5-bisphosphate (RuBP). Fixation of a molecule of CO<sub>2</sub> to RuBP is catalyzed by the enzyme *RuBP carboxylase*. The resulting 6C compound is highly unstable and gets cleaved to form two molecules of 3C compounds called phosphoglyceric acid (PGA).



***Reduction***

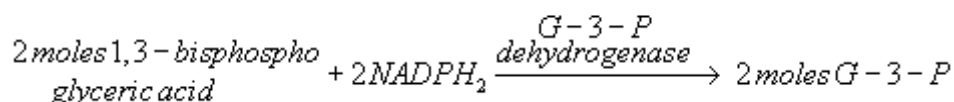
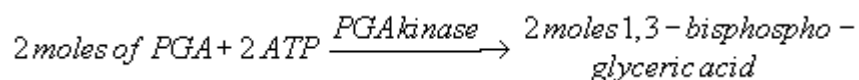
The two molecules of PGA are further reduced to glyceraldehyde-3-phosphates in two steps. First, two PGA molecules are converted to 1,3-bisphosphoglyceric acids by the enzyme *PGA kinase*. This reaction consumes two molecules of ATP in the ratio of one ATP for each molecule of 1,3-bisphosphoglyceric acid formed.

In the second step, the two molecules of 1,3-bisphosphoglyceric acid are reduced to glyceraldehyde-3-phosphates by the enzyme *glyceraldehyde-3-phosphate dehydrogenase* with the help of the light generated reducing



**Fig. 5.10 Calvin cycle**

power  $\text{NADPH}_2$ . So, two molecules of  $\text{NADPH}_2$  will be consumed during this reaction. To reduce one molecule of  $\text{CO}_2$  upto reduction two ATP and two  $\text{NADPH}_2$  are consumed.



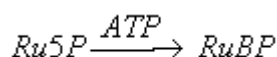
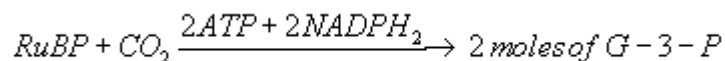
### **Regeneration of RuBP**

The glyceraldehyde 3-phosphate molecules are converted to RuBP through a series of reactions, which generate 4C, 6C and 7C phosphorylated compounds as intermediates. For better and easy understanding of these reactions, a simplified scheme of Calvin cycle considering three  $\text{CO}_2$  molecules fixation reactions is shown below.

The reactions of regeneration of RuBP are as follows.

1. Some of the Glyceraldehyde 3-phosphate molecules are converted to dihydroxy acetone phosphates.
2. Glyceraldehyde 3-phosphate combines with dihydroxy acetone phosphate to form fructose 1,6-bisphosphate.
3. Fructose 1,6-bisphosphate undergoes dephosphorylation to form fructose 6-phosphate.
4. Fructose 6-phosphate combines with glyceraldehyde 3-phosphate obtained from the fixation of second molecule of  $\text{CO}_2$  to form Ribose 5-phosphate (R5P) and Erythrose 4-phosphate (Er4P).
5. Erythrose 4-phosphate combines with DHAP obtained from the second  $\text{CO}_2$  fixation, to form sedoheptulose 1,7-bisphosphate.
6. Sedoheptulose 1,7-bisphosphate undergoes dephosphorylation to form sedoheptulose 7-phosphate.
7. Sedoheptulose 7-phosphate combines with glyceraldehyde 3-phosphate obtained by the third  $\text{CO}_2$  fixation, to form two molecules of 5C compounds – ribose 5-phosphate and xylulose 5-phosphate (Xy5P).

8. Ribose 5-phosphate and xylulose 5-phosphate molecules are transformed to ribulose 5-phosphate (Ru5P).
9. Ru5P molecules are then phosphorylated by ATP to form RuBP molecules, which again enter into the cycle of CO<sub>2</sub> fixation.

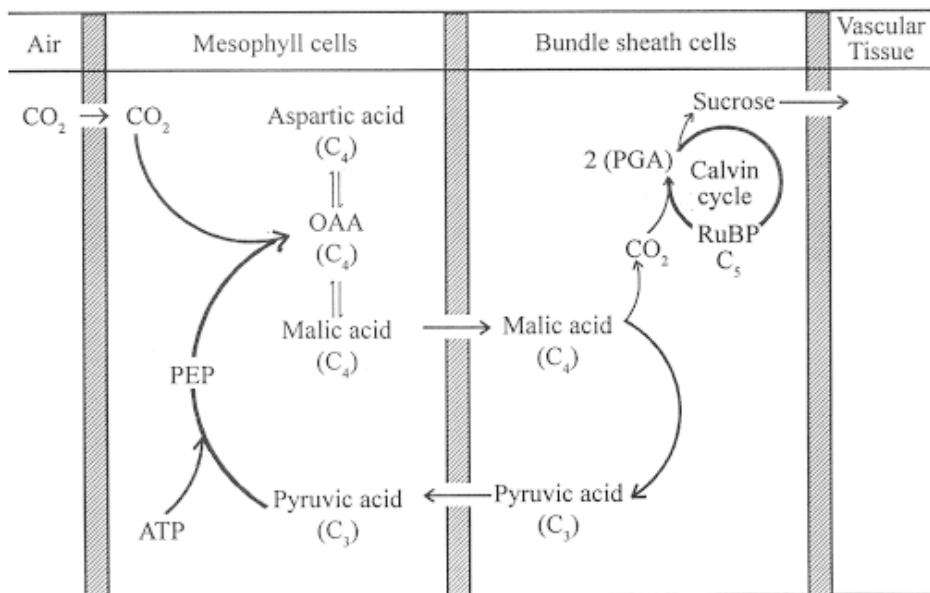


In the above illustration, three CO<sub>2</sub> molecules are fixed and the net gain is a 3C called DHAP. These triose phosphate molecules combine to form hexose phosphates, which are used to form sucrose. For every carbon fixation 3ATP and 2 NADPH<sub>2</sub> are consumed.

#### 5.2.6. C<sub>3</sub> and C<sub>4</sub> pathways

It was once thought that all green plants fix CO<sub>2</sub> through Calvin cycle only. Now, we know that certain plants fix CO<sub>2</sub> in a different photosynthetic mechanism called C<sub>4</sub> pathway. In this chapter, we will know more about this. Hatch and Slack observed that 4C compounds such as oxaloacetic acid, malate and aspartate were the first formed compounds, when the leaves of sugarcane were exposed to <sup>14</sup>CO<sub>2</sub> for one second. So, sugarcane is an example for C<sub>4</sub> plant. When the leaves of rice plant are exposed to <sup>14</sup>CO<sub>2</sub>, 3C compound called phosphoglyceric acid is formed. So, rice plant is an example for C<sub>3</sub> plant.

In C<sub>3</sub> plants, photosynthesis occurs only in mesophyll cells. We already learnt that photosynthesis has two types of reactions – light reactions and dark reactions (Calvin cycle). In light reactions ATP and NADPH<sub>2</sub> are produced and oxygen is released as a byproduct. CO<sub>2</sub> is reduced to carbohydrates by dark reactions. In C<sub>3</sub> plants both light reactions and dark reactions occur in mesophyll cells, whereas in C<sub>4</sub> plants, the mechanism of photosynthesis requires two types of photosynthetic cells – mesophyll cells and bundle sheath cells. The C<sub>4</sub> plants contain dimorphic chloroplasts i.e. chloroplasts in mesophyll cells are granal (with grana) whereas in bundle sheath chloroplasts are agranal (without grana). The presence of two types of cells leads to segregation of photosynthetic work i.e. light reactions and dark reactions separately.

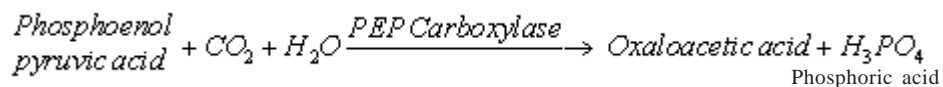


**Fig.5.11 Hatch-Slack pathway of  $CO_2$  fixation**

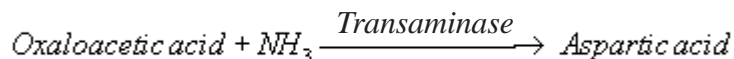
(PEP = Phosphoenol pyruvic acid, OAA = Oxalo acetic acid)

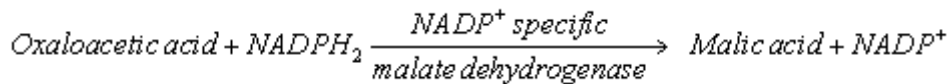
Hatch-Slack pathway involves two carboxylation reactions. One takes place in chloroplasts of mesophyll cells and another in chloroplasts of bundle sheath cells.

1. The first step involves the carboxylation of phosphoenol pyruvic acid in the chloroplasts of mesophyll cells to form a 4C compound, oxaloacetic acid. This reaction is catalysed by the enzyme *phosphoenol pyruvate carboxylase*

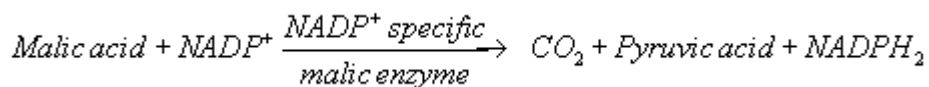


2. Oxaloacetic acid is converted into aspartic acid by the enzyme *transaminase* or it may be reduced to malic acid by *NADP<sup>+</sup> specific malate dehydrogenase*.

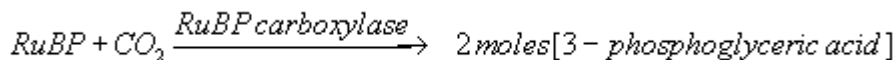




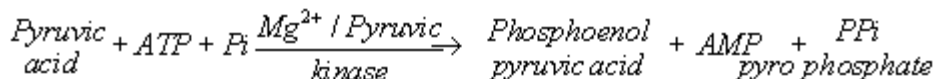
3. Malic acid or aspartic acid formed in chloroplast of mesophyll cells is transferred to the chloroplasts of bundle sheath where it is decarboxylated to form CO<sub>2</sub> and pyruvic acid in the presence of *NADP<sup>+</sup> specific malic enzyme*.



4. Now, second carboxylation occurs in chloroplasts of bundle sheath cells. Ribulose biphosphate accepts CO<sub>2</sub> produced in step (3) in the presence of *RuBP carboxylase* and yields 3-phosphoglyceric acid. Some of the 3-phosphoglyceric acid molecules are utilised to produce sucrose and starch, while remaining PGA molecules are used for the regeneration of RuBP.



5. The pyruvic acid produced in step (3) is transferred to the chloroplasts of mesophyll cells where it is phosphorylated to regenerate phosphoenolpyruvic acid. This reaction is catalysed by *pyruvate kinase* in the presence of Mg<sup>2+</sup>.



The AMP is phosphorylated by ATP in the presence of *adenylate kinase* to form 2 molecules of ADP.

C<sub>4</sub> plants are photosynthetically more efficient than C<sub>3</sub> plants, because the net requirement of ATP and NADPH<sub>2</sub> for the fixation of one molecule of CO<sub>2</sub> is considerably lower in C<sub>4</sub> plants than in C<sub>3</sub> plants.



### *Difference between C<sub>3</sub> and C<sub>4</sub> photosynthetic pathways*

| <b>C<sub>3</sub> pathway</b>  | <b>C<sub>4</sub> pathway</b>   |
|---|--|
| 1. Photosynthesis occurs in meso - phyll cells.   | Photosynthesis occurs in meso - phyll and bundle sheath cells.   |
| 2. The CO <sub>2</sub> molecule acceptor is RuBP.   | The CO <sub>2</sub> acceptor molecule is phosphoenol pyruvate.   |
| 3. The first stable product is a 3C compound called 3 - PGA.  | The first stable product is a 4C compound called OAA.  |
| 4. Photorespiration rate is high and leads to loss of fixed CO <sub>2</sub> . It decreases CO <sub>2</sub> fixation rate. | Photorespiration is negligible and it is almost absent. Hence, it increases CO <sub>2</sub> fixation rate. |
| 5. Optimum temperature is 20 to 25°C.   | Optimum temperature is 30 to 45°C.   |
| 6. Examples of C <sub>3</sub> plants are rice, wheat and potato.  | Examples of C <sub>4</sub> plants are maize, sugarcane, <i>Tribulus</i> and <i>Amaranthus</i>              |

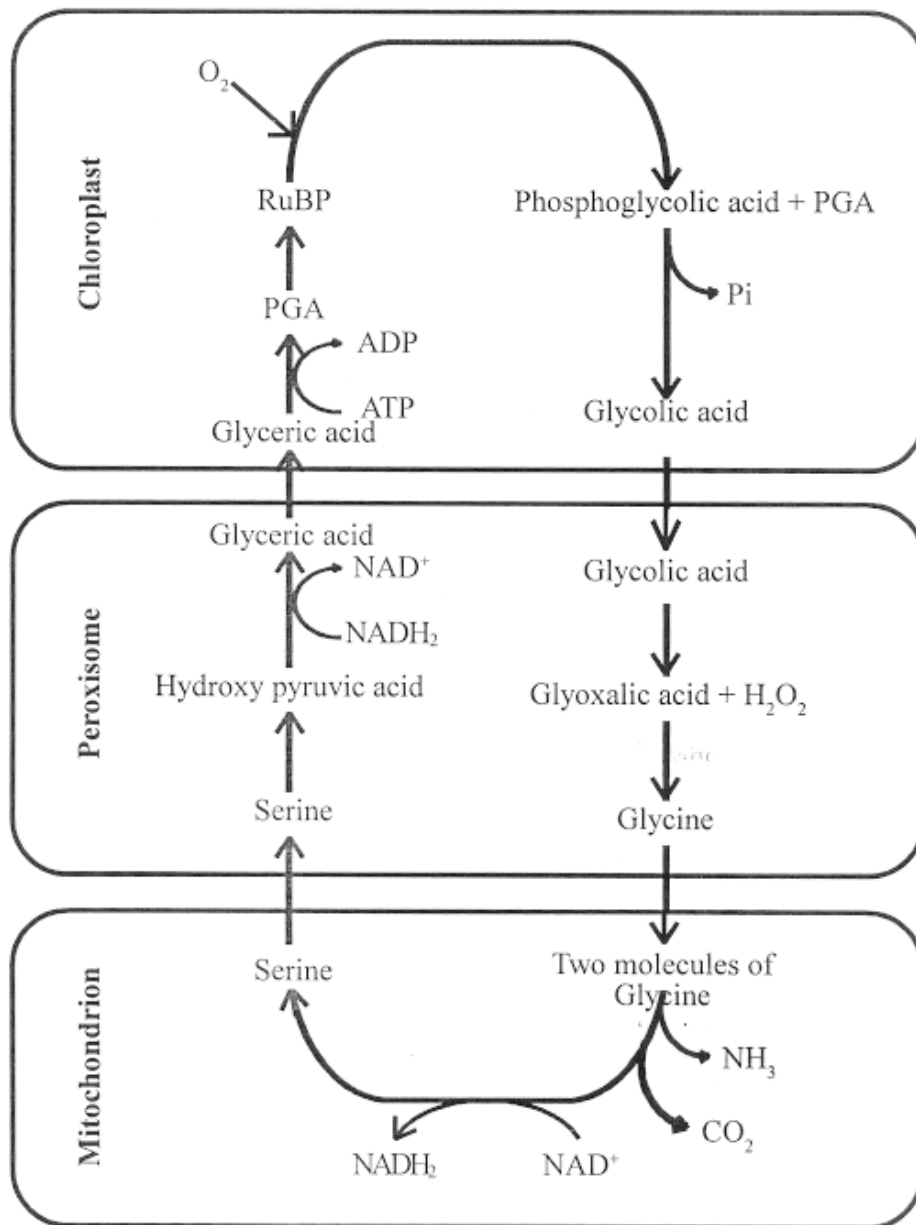
#### **5.2.7 Photorespiration or C<sub>2</sub> cycle**

In animals and bacteria, only one kind of respiration known as dark respiration occurs. This is not affected by the presence or absence of light. But in certain green plants, there are two distinct types of respiration – photorespiration and dark respiration. Respiration that occurs in photosynthetic tissues in the presence of light and results in increased rate of carbondioxide evolution is called photorespiration or light respiration.

Photorespiration involves three organelles – chloroplasts, peroxisomes and mitochondria. Oxidation of RuBP in the presence of high oxygen is the first reaction of photorespiration. This reaction is catalysed by *Rubisco*\* enzyme called *carboxylase*. It leads to the formation of 2C compound – phosphoglycolic acid and 3C compound PGA. When PGA is used up in the Calvin cycle, the phosphoglycolic acid is dephosphorylated to form glycolic acid in the chloroplasts.

From the chloroplast, the glycolic acid diffuses into the peroxisome where it is oxidised to glyoxalic acid and hydrogen peroxide. In peroxisome from glyoxalic acid, glycine is formed.

Note : \* Rubisco = **R**ibulose **b**isphosphate **c**arboxylase



*Fig.5.12 Photorespiratory pathway*

Glycine molecules enter into mitochondria where two molecules of glycine combine to give a molecule of serine,  $\text{NH}_3$  and  $\text{CO}_2$ . During this process,  $\text{NAD}^+$  is reduced to  $\text{NADH}_2$ .

The amino acid serine is taken to peroxisome where, it is converted into hydroxy pyruvic acid. Hydroxy pyruvic acid is reduced by  $\text{NADH}_2$  to form glyceric acid.

The glyceric acid leaves peroxisome and enters chloroplast, where it is phosphorylated to PGA, which enters into Calvin cycle. During the photorespiratory pathway, one  $\text{CO}_2$  molecule released in mitochondria is to be re-fixed.

Photorespiration is also known as **photosynthetic carbon oxidation cycle or  $\text{C}_2$  cycle**. Under the conditions of high light and limited  $\text{CO}_2$  supply, photorespiration protects the plants from photooxidative damage. This means that, if enough  $\text{CO}_2$  is not available to utilize light energy, excess energy causes damage to plant. However, photorespiration utilizes part of the light energy and saves the plant from photooxidative damage. Increased  $\text{O}_2$  level increases photorespiration whereas increased  $\text{CO}_2$  level decreases photorespiration and increases photosynthesis.

***Difference between photorespiration and dark respiration***

| Photorespiration  | Dark respiration  |
|---|---|
| 1. It takes place only in photo-synthetic cells in the presence of light. | It takes place in all living cells in the mitochondria.     |
| 2. It is light dependent  | It takes place in the presence and in the absence of light. |
| 3. It is the function of chloroplast, peroxisomes and mitochondria.       | It is the function of mitochondria alone.                   |

**5.2.8. Factors affecting photosynthesis**

Photosynthesis is influenced by both environmental and genetic factors. The environmental factors include light, availability of  $\text{CO}_2$ , temperature, soil, water and nutrient supply apart from age of leaf, leaf angle and leaf

orientation. Photosynthesis is not affected by all environmental factors at a given time.

According to Blackmann who postulated Law of Limiting factor in 1905, photosynthesis is limited by slowest step of the most limiting factor in the pathway. This means that at a given time, only the factor that is most limiting among all will determine the rate of photosynthesis. For example, if  $\text{CO}_2$  is available in plenty but light is limiting due to cloudy weather, the rate of photosynthesis under such situation is controlled by the light. Further, if both  $\text{CO}_2$  and light are limiting, then the factor which is the most limiting of the two will control the rate of photosynthesis.

Both quality and intensity of light influence photosynthesis. Light between the wavelength of 400nm to 700nm is most effective for photosynthesis and this light is called photosynthetically active radiation. As the intensity of light increases the rate of photosynthesis increases. However, if the light intensifies, the rate of photosynthesis decreases. This is because of higher intensity of light destruction of chlorophyll occurs.

Photochemical reactions and dark reactions of photosynthesis respond differently to temperature. Photochemical reactions in the thylakoid remain unharmed by temperature, whereas the enzymatic dark reactions get influenced adversely. At higher temperature, the enzymes become inactive. Low temperature also inactivates the enzymes.

The current level of  $\text{CO}_2$  is about 0.036 per cent or 360 ppm (parts per million), which is very low as compared to the concentration of other gases in the atmosphere such as  $\text{O}_2$  and  $\text{N}_2$ . The rate of photosynthesis in all plants increases with increase in the concentration of  $\text{CO}_2$  upto 500 ppm, when other factors are not limiting.

Availability of water in soil has a prominent effect on photosynthesis. If the soil water becomes limiting factor, the rate of photosynthesis declines.

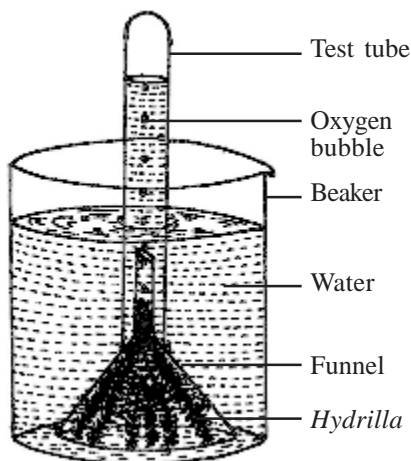
Among various nutrients, nitrogen has a direct relationship with photosynthesis. Since, nitrogen is a basic constituent of chlorophyll and all enzymes involved in dark reactions, any reduction in nitrogen supply to plants has an adverse effect on photosynthesis. In general all essential elements affect the rate of photosynthesis.

Among leaf factors, such as leaf age, leaf angle and leaf orientation, leaf age has the most prominent effect on photosynthesis. If leaf undergoes, senescence, loss of chlorophyll occurs. The photosynthetic enzymes also get inactivated resulting in reduced rate of photosynthesis.

## EXPERIMENTS ON PHOTOSYNTHESIS

### *Test tube and funnel experiment*

The test tube funnel experiment demonstrates that oxygen is evolved during photosynthesis. A few branches of *Hydrilla* are kept in a beaker containing pond water in which a small amount of sodium bicarbonate is dissolved. The branches are covered with a glass funnel and a test tube



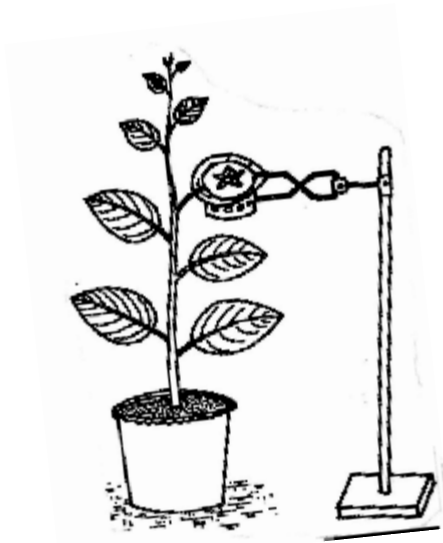
**Fig. 5.13 Test tube funnel experiment**

full of water is kept inverted over the stem of the funnel as shown in the figure.

Now the apparatus is kept in sunlight for 4 to 6 hours. The gas bubbles may be observed from the ends of hydrilla branches kept within the glass funnel. These gas bubbles are collected in the test tube by the downward displacement of water. The gas is tested for oxygen. When a burnt splinter is taken near the mouth of the tube, it glows brightly and proves that the gas is oxygen. The test tube and funnel experiment demonstrates that oxygen evolves during photosynthesis.

### *Ganong's light screen experiment*

Ganong's light screen experiment demonstrates that light is essential for photosynthesis. When a pot plant is kept for 48 hours in dark room, the leaves become free from starch. Thus dark treated plant is called destarched plant. Ganong's light screen is a clip like instrument with a tin foil disc having a star shaped opening through which light can enter. This closes the lower hollow cylindrical box like structure. The advantage of light screen is to allow free ventilation and at the same time it cuts off light. The light screen is fixed to a leaf of the destarched potted plant as shown in the figure. The entire experimental setup is placed in sunlight for 4 to 6 hours.



**Fig. 5.14** Ganong's light screen experiment.

The leaf subjected for experiment is tested for starch. Only the star shaped part of the leaf exposed to the sunlight turns blue. The Ganong's light screen experiment demonstrates that light is essential for photosynthesis.

### **5.2.9. Mode of nutrition**

#### ***Autotrophic nutrition***

Most of the green plants are self-dependent, because they synthesize their own food materials by photosynthesis. Such a mode of nutrition is described as autotrophic. Autotrophic plants are of different types according to their ecological

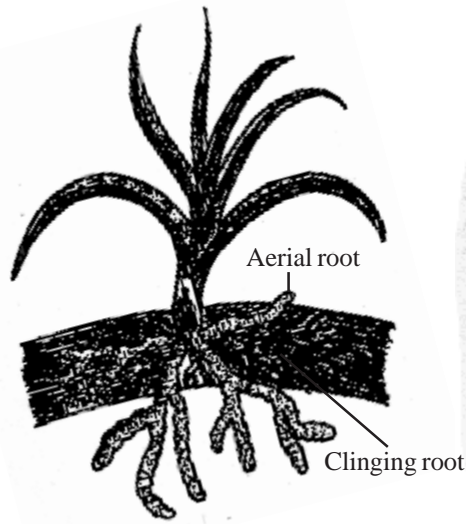
environments. Different environments cause differences in their morphology. Thus, we find special adaptations in aquatic plants, terrestrial plants, xerophytes, mangrove plants etc. Among the autotrophic plants, epiphytes are peculiar. These plants usually grow on the branches of the trees. Epiphytic plants are not parasitic on these trees, but they only make use of the place to grow. They have two types of roots – clinging roots and aerial roots. Clinging roots fix the epiphytes to the bark of the tree and also absorb the little nutrients found in the debris accumulating on the bark. The aerial roots hang about in the air. These roots are usually green and covered by a spongy tissue called velamen which absorbs the moisture in the air as well as rain water. eg. Vanda.

#### ***Heterotrophic nutrition***

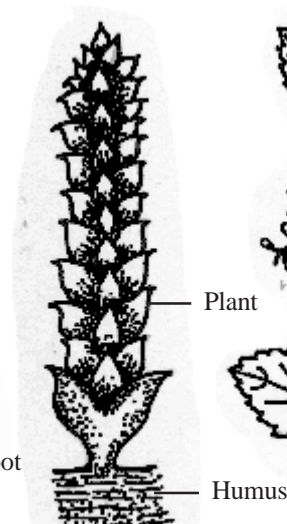
Due to lack of chlorophyll or nitrogen deficiency, some plants have to depend on other plants, insects or dead organic matter for their food. Such type of nutrition is known as heterotrophic. Heterotrophic plants are grouped into saprophytic, parasitic and insectivorous plants.

#### ***Saprophytic plants***

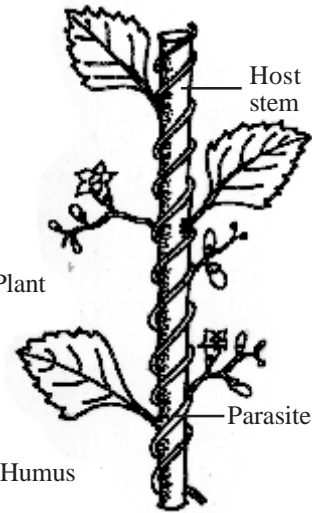
These plants obtain nutrition from non-living organic matter. They are called saprophytic plants. Many fungi and bacteria are saprophytes.



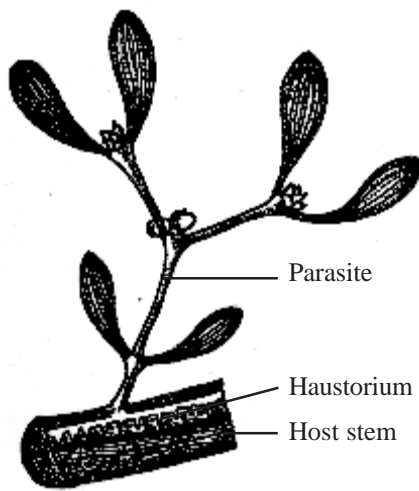
*Epiphyte*  
eg. *Vanda*



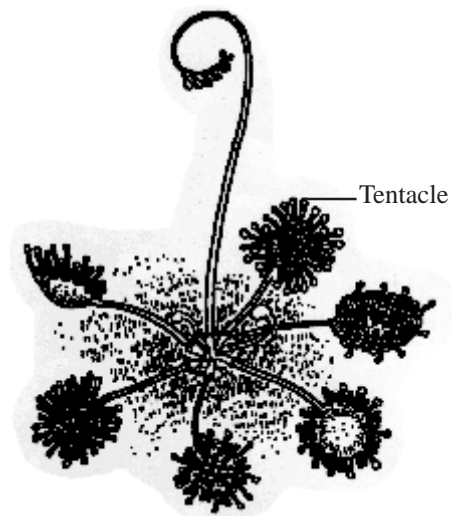
*Saprophyte*  
eg. *Monotropa*



*Total parasite*  
eg. *Cuscuta*



*Partial parasite*  
eg. *Viscum*



*Insectivorous plant*  
eg. *Drosera*

*Fig.5.15 Modes of nutrition*



Certain angiosperms like *Monotropa* lack chlorophyll and have mycorrhizal roots. This plant absorbs nourishments from the humus through their mycorrhizal roots.

### ***Parasitic plants***

Some plants get their nourishments from other living plants or animals. They are called parasitic plants. The plants or animals from which the parasites get their nourishments are called hosts. Parasites have some special roots, which penetrate the host plants and absorb food from the phloem and water and minerals from xylem. These roots are called haustoria.

Parasitic angiosperms are of two types. They are total parasites and partial parasites. Some plants completely lack chlorophyll and do not grow in the soil. Therefore, it is totally dependent on the host stem for organic food materials, water and minerals. They are called total parasites. eg. *Cuscuta*. *Cuscuta* has thin, pale yellow and leafless stem. It twines around the stem of the host and sends haustoria into it to absorb nourishments.

Some plants absorb only water and mineral salts from the stem of host plant. They can manufacture their own food due to the presence of green leaves. The haustoria of these plants have connection only with the xylem of the host to absorb water and mineral salts. These plants are called partial parasites. eg. *Viscum*.

### ***Insectivorous plants***

Though insectivorous plants are capable of manufacturing carbohydrates by photosynthesis, they are not able to synthesize enough proteins due to the deficiency of nitrogen. They overcome this deficiency by catching small insects and digesting them. Their leaves are modified in various ways for this purpose. Such plants are called insectivorous plants. Eg. *Drosera*.

### ***Drosera***

*Drosera* is a small plant growing in marshy places. This plant is also known as sundew plant. The leaves of this plant have numerous hair-like structures called tentacles. Each tentacle has got a gland at the tip. The gland secretes a sticky fluid. This fluid shines in sunlight and appears as dew; hence the plant is called sundew plant.



When an insect is attracted by the shining sticky fluid and tries to sit on the leaf, it is entangled in the sticky fluid. At once, the sensitive tentacles surround the insect and curve inward on it. Then the glands secrete digestive juices which contain proteolytic enzymes. The enzymes digest the proteins of the insect body. The digested food is finally absorbed by the leaves and the tentacles again come in their original straight position.

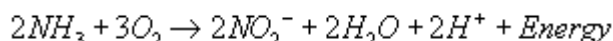
#### **5.2.10. Chemosynthesis**

Chemosynthesis is a process by which certain organisms synthesize carbohydrates by using energy obtained by the oxidation of inorganic substances. Most of the bacteria obtain their food materials from external sources and they cannot synthesize their food by themselves. These are called heterotrophic organisms. Whereas, some bacteria are capable of synthesizing their food either by photosynthesis or chemosynthesis.

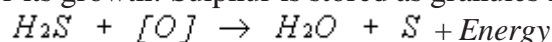
Organisms which use sunlight energy for synthesis of food materials are called photosynthetic organisms or photoautotrophs. Those organisms which use chemical energy for the synthesis of carbon compounds are called chemosynthetic organisms. There are two groups of chemosynthetic organisms namely, chemosynthetic autotrophs and chemosynthetic heterotrophs.

#### **Chemosynthetic autotrophs**

Examples for chemosynthetic autotrophs are *Nitrosomonas*, *Beggiatoa*. *Nitrosomonas* oxidizes ammonia into nitrite. The energy liberated during this process is used for the synthesis of carbohydrates.



*Beggiatoa* oxidises H<sub>2</sub>S to sulphur and water. During this, energy is released and used for its growth. Sulphur is stored as granules inside cell.



#### **Chemosynthetic heterotrophs**

Examples for chemosynthetic heterotrophs are fungi, most bacteria, animals and man. These organisms cannot prepare their food materials, hence they are heterotrophs. They obtain the energy for growth by chemical reactions i.e. by oxidizing the organic compounds. For example, energy is released when glucose is oxidised in the process of respiration. Thus, these organisms are chemosynthetic heterotrophs.

### Self evaluation

#### I. Choose and write the correct options.

1. Photosynthesis takes place in
  - a. mitochondria
  - b. peroxisomes
  - c. chloroplasts
  - d. ribosomes
2. During cyclic electron transport, which one of the following is produced
  - a. NADPH<sub>2</sub> only
  - b. ATP only
  - c. NADH<sub>2</sub> only
  - d. both ATP and NADPH<sub>2</sub>
3. Which one of the following is a five carbon compound?
  - a. fructose
  - b. erythrose
  - c. ribose
  - d. DHAP
4. Which one of the following is a C<sub>4</sub> plant?
  - a. rice
  - b. wheat
  - c. sugarcane
  - d. potato
5. The essential component for the formation of chlorophyll
  - a. Mg
  - b. Fe
  - c. Cl
  - d. Mn
6. The pigment which is highly efficient in absorbing solar energy is
  - a. phycobilins
  - b. chlorophyll
  - c. carotinoids
  - d. xanthophyll
7. Which of the following bacterium oxidizes ammonia to nitrate
  - a. *Nitrosomonas*
  - b. *Rhizobium*
  - c. *Closteridium*
  - d. *E. coli*
8. Which of the following is a total parasite
  - a. *Cuscuta*
  - b. *Viscum*
  - c. *Drosera*
  - d. *Monotropa*
9. Which of the following wavelengths of light is most effective for photosynthesis
  - a. 100 nm to 200 nm
  - b. 200 nm to 300 nm
  - c. 400 nm to 700 nm
  - d. 700 nm to 900 nm
10. Dark respiration is the function of
  - a. peroxisomes
  - b. mitochondria
  - c. chloroplast
  - d. ribosomes

11. The gas evolved during photosynthesis is
  - a. carbondioxide
  - b. nitrogen
  - c. hydrogen
  - d. oxygen
12. Dark reaction is also known as
  - a. Krebs cycle
  - b. Calvin cycle
  - c. pentosephosphate pathway
  - d. photorespiration
13.  $C_4$  pathway is otherwise known as
  - a. EMP pathway
  - b. Hatch-Slack pathway
  - c. photorespiration
  - d. electron transport chain
14. Photorespiration is otherwise called as
  - a.  $C_2$  cycle
  - b.  $C_3$  cycle
  - c.  $C_4$  cycle
  - d.  $C_5$  cycle
15. An example for insectivorous plant is
  - a. *Drosera*
  - b. *Viscum*
  - c. *Monotropa*
  - d. *Vanda*
16. Which of the following is regarded as primary pigment?
  - a. Carotenoid
  - b. Xanthophyll
  - c. Chlorophyll 'a'
  - d. Chlorophyll 'b'
17. The dark reactions of photosynthesis were discovered by
  - a. Embden and Meyer
  - b. Melvin Calvin
  - c. Krebs
  - d. Parnas
18. Which of the following is a 5C compound?
  - a. Glucose
  - b. Fructose
  - c. Phosphoglyceric acid
  - d. RuBP
19. In  $C_3$  plants light reactions and dark reactions occur in
  - a. bundle sheath cells
  - b. mesophyll cells
  - c. epidermal cells
  - d. vascular cells
20. In  $C_3$  pathway acceptor molecule of  $CO_2$  is
  - a. Phosphoenol pyruvate
  - b. RuBP
  - c. PGA
  - d. DHAP
21. Which of the following is not a  $C_4$  plant?
  - a. Maize
  - b. *Tribulus*
  - c. *Amaranthus*
  - d. Wheat

22. Vanda plant is a/an ----
  - a. total parasite
  - b. partial parasite
  - c. epiphyte
  - d. saprophyte
23. The reducing power produced in the light reaction is
  - a. NADP
  - b. ATP
  - c. ADP
  - d. NADPH<sub>2</sub>
24. Which of the following is not accessory pigments?
  - a. Phycobilins
  - b. Chlorophylls
  - c. Carotenoids
  - d. Xanthophylls
25. The photosynthetic pigments are located in
  - a. Cristae
  - b. Cisternae
  - c. Thylakoid
  - d. Stroma

**II. Answer the following questions in two or three sentences.**

26. What are generally called accessory pigments?
27. What is photolysis of water?
28. Define light reaction.
29. Define dark reaction.
30. State the conditions under which cyclic photophosphorylation occurs.
31. Write the overall equation of photosynthesis.
32. Why are chloroplasts in C<sub>4</sub> plants called dimorphic chloroplasts?
33. Define photorespiration.
34. Write any two differences between photorespiration and dark respiration.
35. What are called total parasites?
36. Define chemosynthesis.

**III. Answer the following questions in about 100 words.**

37. Write short notes on site of photosynthesis.
38. Write short notes on photosynthetic electron transport system.
39. What are the differences between C<sub>3</sub> and C<sub>4</sub> pathway?

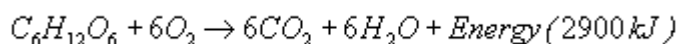
40. Explain the test tube and funnel experiment to demonstrate that oxygen is evolved during photosynthesis.
41. Write short notes on Ganong's light screen experiment.
42. Write short notes on insectivorous plant.
43. Explain the process of chemosynthesis.
44. Bring out the significance of photosynthesis.
45. Describe the structure of chloroplast.

***IV. Answer the following questions in about 200 words.***

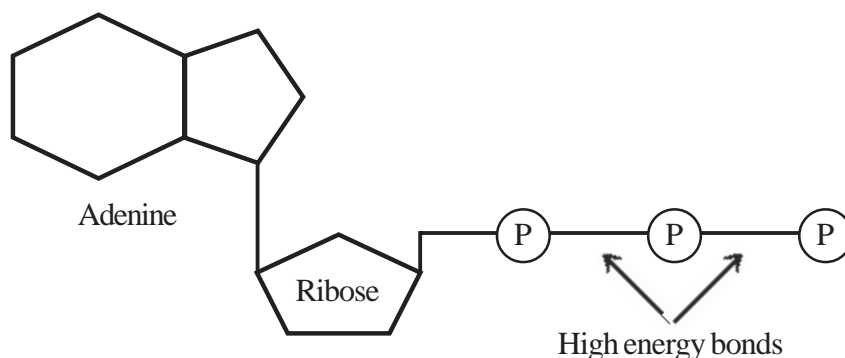
46. Describe the light reactions of photosynthesis (or) Explain cyclic and noncyclic photophosphorylation.
47. Write an account on dark reactions of photosynthesis.
48. Write an essay on C<sub>4</sub> pathway.
49. Write an essay on photorespiration or C<sub>2</sub> cycle.
50. Write an account on the factors affecting photosynthesis.
51. Describe different modes of nutrition in angiosperms.

### 5.3. Respiration

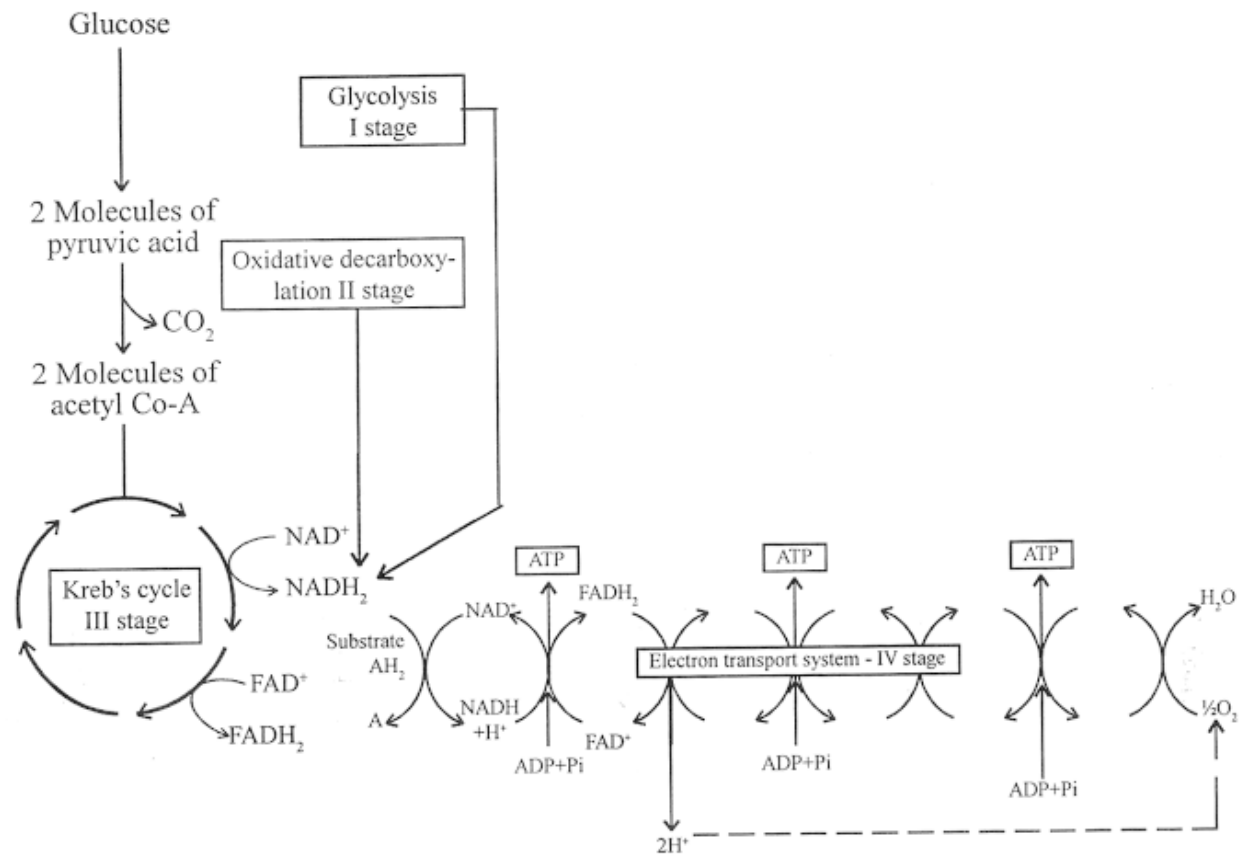
In the previous chapter, you have learnt that light energy is converted into chemical energy and stored in complex organic molecules called carbohydrates – glucose and starch. The breaking of C – C bonds of such compounds through oxidation releases a considerable amount of energy. This energy is utilized for various metabolic activities at cellular level. This phenomenon of release of energy by oxidation of various organic molecules is known as **respiration**. The compounds that are oxidised during this process are known as respiratory substrates. Carbohydrate is the common respiratory substrate. During respiration, the whole energy contained in the respiratory substrate is not released all at once. In respiration, oxygen is utilized and carbondioxide, water and energy are released. Respiration is an exothermic reaction and the oxidation of glucose is given in the following equation.



The energy released during this process is transformed into usable form of energy as adenosine triphosphate (ATP). ATP molecules act as carriers of free energy between energy yielding and energy requiring reactions of the cell. Thus, ATP is described as energy currency of the cell. It is a nucleotide consisting of adenine, ribose sugar and three phosphate groups. It is an energy rich compound and contains two high energy terminal bonds. A large amount of free energy is liberated, when these bonds are broken by hydrolysis.



*Fig. 5.12 Structure of ATP*



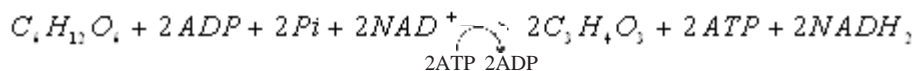
*Fig. 5.17 Overall scheme of respiration*

### 5.3.1. Mechanism of respiration

Oxidation of glucose involves following four distinct stages – glycolysis, oxidative decarboxylation of pyruvic acid, Krebs cycle and Electron transport chain. In the first three stages, the hydrogen acceptor Nicotinamide adenine dinucleotide – oxidized form ( $\text{NAD}^+$ ) and Flavin adenine dinucleotide – oxidized form ( $\text{FAD}^+$ ) are reduced to  $\text{NADH}_2$  and  $\text{FADH}_2$  respectively. Both the coenzymes, ( $\text{NAD}^+$ ) and ( $\text{FAD}^+$ ) act as hydrogen carriers from respiratory substrate to electron transport chain, where  $\text{H}^+$  and electrons are transferred to oxygen to form water. This electron transport results in the release of energy, which is used to phosphorylate ADP to ATP. Hence, the electron transport chain reactions are referred to as **oxidative phosphorylation**.

### 5.3.2. Glycolysis

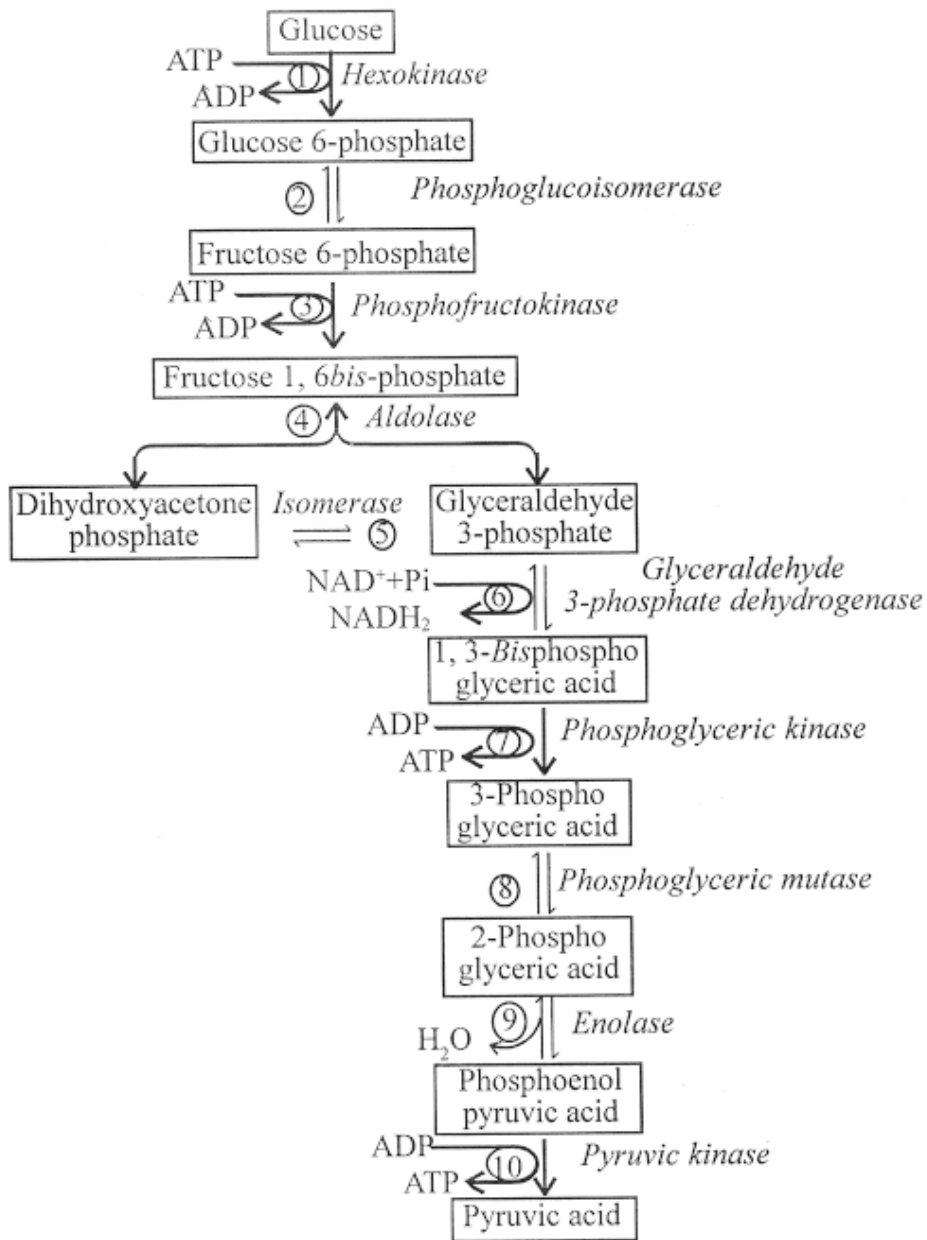
The process by which the glucose (6C compound) is split into two molecules of pyruvic acid (3C compound) is called **glycolysis**. Three German Microbiologists – Embden, Meyerhof and Parnas, first demonstrated this process in yeast cell. Hence, it is otherwise known as EMP pathway. It occurs in cytoplasm. It is common in all organisms. It is divided into two phases – hexose phase and triose phase. Glyceraldehyde 3-phosphate and DHAP are the products of hexose phase and two molecules of pyruvic acid are the products of triose phase. The overall reaction of glycolysis is given in the following equation.



Reactions involved in glycolysis are as follows

1. The glucose is phosphorylated with ATP to form glucose-6-phosphate. The reaction is catalyzed by the enzyme *hexokinase*.
2. Glucose-6-phosphate is isomerized to form fructose-6-phosphate by *phosphoglucosomerase*.
3. Fructose-6-phosphate is then phosphorylated using ATP to form fructose 1,6-bisphosphate. This reaction is catalyzed by *phosphofructokinase*. The ATP is dephosphorylated to ADP.
4. Fructose 1,6-bisphosphate is cleaved by the enzyme *aldolase* to two molecules of 3C compounds – dihydroxy acetone phosphate (DHAP) and glyceraldehyde 3-phosphate. These two trioses are isomers.





**Fig. 5.18 Process of Glycolysis**

5. DHAP and glyceraldehyde-3-phosphate are interconvertible by the action of *triose phosphate isomerase*. These five series of reaction constitute hexose phase and produce two molecules of 3-carbon compound called 3-phosphoglyceraldehyde. In hexose phase two ATP molecules are consumed.

6. A molecule of glyceraldehyde-3-phosphate is phosphorylated and oxidized to 1,3-bisphosphoglyceric acid in the presence of *glyceraldehyde-3-phosphate dehydrogenase*. During this reaction, one  $\text{NADH}_2$  is formed.

7. 1,3-bisphosphoglyceric acid is dephosphorylated to a molecule of 3-phosphoglyceric acid by *phosphoglyceric kinase*. During this reaction one ATP is formed. This type of ATP synthesis is called direct phosphorylation or substrate level phosphorylation.

8. A molecule of 3-phosphoglyceric acid is then converted into a molecule of 2-phosphoglyceric acid by *phosphoglyceric mutase*. In this reaction, phosphate molecule is shifted from third carbon to second carbon.

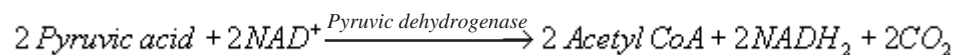
9. A molecule of 2-phosphoglyceric acid is dehydrated to a molecule of 2-phosphoenol pyruvic acid by *enolase*. Removal of water molecule from the substrate is called enolation.

10. A molecule of 2-phosphoenol pyruvic acid is dephosphorylated to pyruvic acid and ADP is phosphorylated to ATP. This reaction is catalyzed by *pyruvic kinase*. Thus, in the triose phase, two molecules of a molecule of 3-phospho glyceraldehyde produce 2 molecules of pyruvic acid.

In glycolysis, 4ATP and 2 $\text{NADH}_2$  molecules are formed and 2ATP molecules are consumed in hexose phase. Hence, the net gain is 2ATP and 2 $\text{NADH}_2$ .

#### ***Oxidative decarboxylation of pyruvic acid***

The two molecules of pyruvic acid formed from a glucose molecule move into mitochondria and are oxidized, decarboxylated to two molecules of acetyl coenzyme A (acetyl Co ~ A). These 2 carbon compounds are formed by



decarboxylation and dehydrogenation. This reaction is catalyzed by *pyruvic dehydrogenase* and two molecules of  $\text{NAD}^+$  are reduced to  $\text{NADH}_2$ . During this reaction two molecules of  $\text{CO}_2$  are released. Oxidative decarboxylation of pyruvic acid occurs only under aerobic condition. Under anaerobic conditions, the pyruvic acid is reduced either to lactic acid or ethyl alcohol depending on the nature of the organism.

### 5.3.3 *Krebs cycle*

In 1937, Sir Hans Adolf Krebs described the catalytic role of pyruvic acid for the production of energy in the cell. The series of cyclic reactions involved in converting pyruvic acid to carbondioxide and water in mitochondria is called Krebs cycle. It is also known as citric acid cycle or tricarboxylic acid cycle – TCA cycle.

1. In the first reaction of citric acid cycle, one molecule of acetyl Co ~ A combines with oxaloacetic acid to form citric acid. This reaction is catalyzed by *citric acid synthetase*. Citric acid contains three carboxylic acid groups.

2. Citric acid is dehydrated to form cis-aconitic acid in the presence of *aconitase*

3. The same enzyme *aconitase* catalyzes the formation of isocitric acid from cis-aconitic acid by the addition of a molecule of water. Citric acid, cis-aconitic acid and isocitric acid contain three carboxylic acid groups.

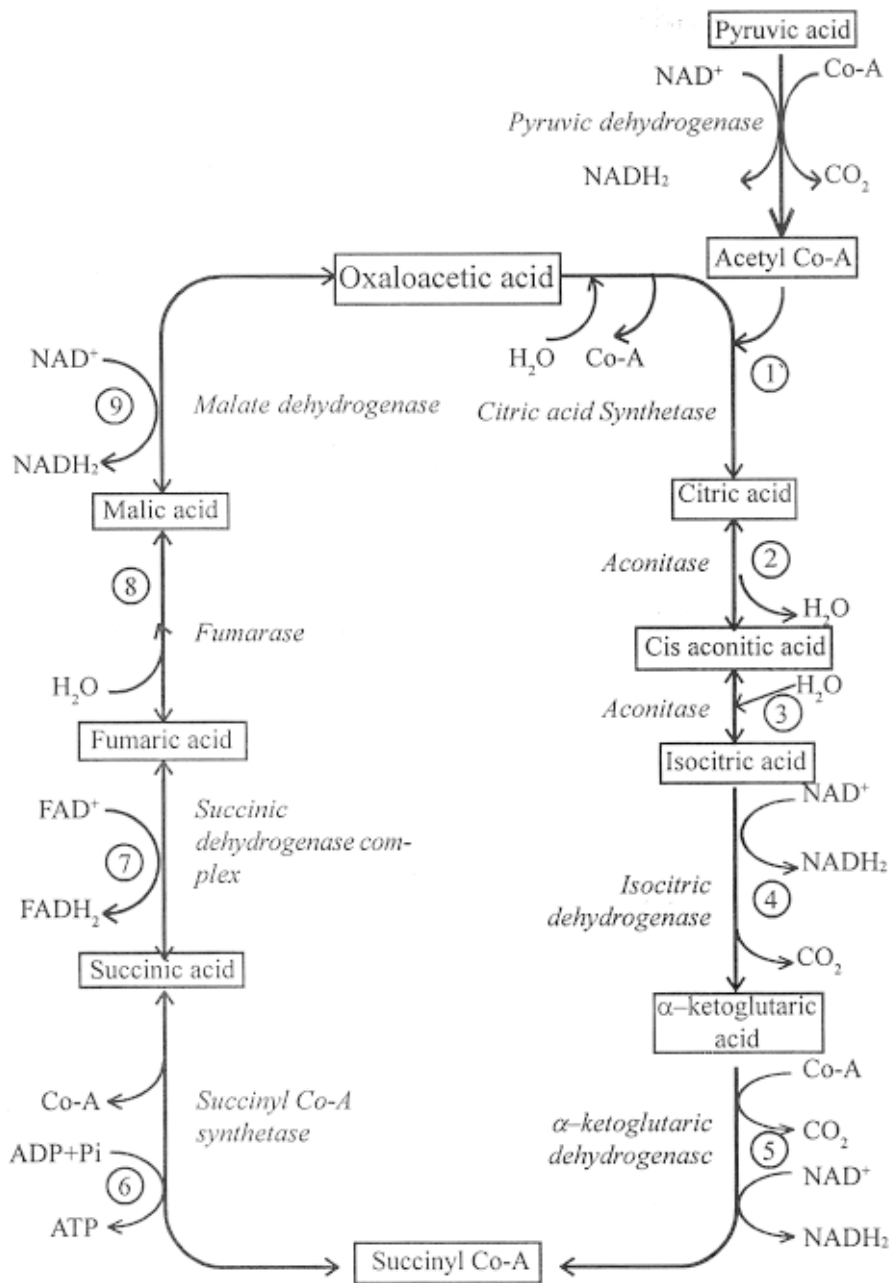
4. The isocitric acid is oxidatively decarboxylated to  $\alpha$ - ketoglutaric acid. This reaction is catalyzed by *isocitric dehydrogenase*. During this reaction, one  $\text{NADH}_2$  is formed.

5. The  $\alpha$ - ketoglutaric acid is oxidatively decarboxylated to form succinyl Co ~ A. This reaction is catalyzed by  *$\alpha$ -ketoglutaric dehydrogenase*. The energy released during this reaction is conserved in  $\text{NADH}_2$ .

6. The succinyl Co ~ A is hydrolysed to succinic acid in the presence of *succinyl Co-A synthetase*. In this reaction, ADP is phosphorylated to ATP. This is called substrate level phosphorylation.

7. The succinic acid is oxidized to form fumaric acid by *succinic dehydrogenase*. Here,  $\text{FAD}^+$  is reduced to  $\text{FADH}_2$ .

8. The fumaric acid is converted to malic acid by the addition of a molecule of water. This reaction is catalyzed by *fumarase*.



**Fig. 5.19** Krebs cycle

9. The malic acid is oxidized to oxaloacetic acid by the enzyme *malic dehydrogenase*. Here,  $\text{NAD}^+$  is reduced to  $\text{NADH}_2$ .

### ***Significance of Krebs cycle***

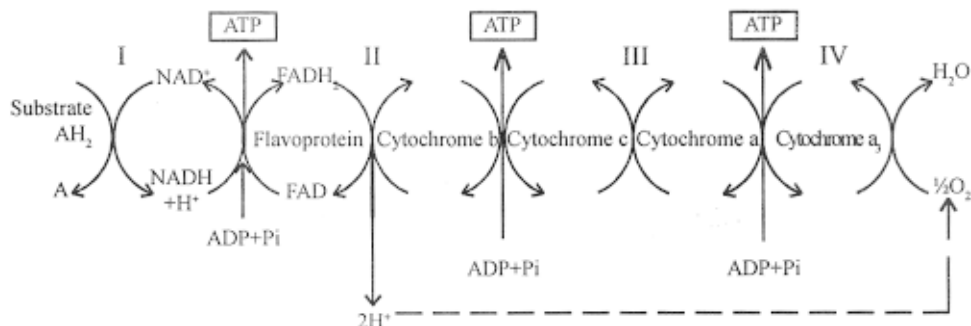
2 molecules of acetyl CoA enter into Krebs cycle which on subsequent oxidation generate  $6\text{NADH}_2$ ,  $2\text{FADH}_2$ . When  $6\text{NADH}_2$ ,  $2\text{FADH}_2$  enter into the electron transport system generate 22ATP molecules. In one step, there is substrate level phosphorylation which directly yield 2ATP molecules. So, during Krebs cycle, every 2 molecules of acetyl CoA enter into Krebs cycle 24 ATP molecules are generated. So, primarily it is a energy producing system. Since, Krebs cycle involves with both anabolic and catabolic processes, it is also described as **amphibolic** process.

### ***Electron transport chain***

Electron transport system (ETS) is a chain of electron carriers consisting of  $\text{NAD}^+$ ,  $\text{FAD}^+$ , CoQ and cytochromes (cyt. b, cyt. c, cyt. a and cyt.  $a_3$ ). The glucose molecule is completely oxidized by the end of the citric acid cycle. But, energy is not released, unless  $\text{NADH}_2$  and  $\text{FADH}_2$  are oxidized through electron transport system. Transfer of electrons and protons from  $\text{NADH}_2$  and  $\text{FADH}_2$  to oxygen through a series of components like flavoprotein, cytochrome is called **electron transport chain**. This process leads to coupling of electrons to form high-energy phosphate bonds in the form of ATP from ADP is called **oxidative phosphorylation**. The electron transport components are arranged in the inner membrane of mitochondria.

According to modern concept, the electron carriers in the electron transport system are arranged in four complexes – complex I, complex II, complex III and complex IV. When  $\text{NAD}^+$  is a primary acceptor of electrons, the electrons are transported from complex I to II, II to III and then to complex IV. When electrons are transported from one complex to next complex, an ATP is produced. Thus, one molecule of  $\text{NADH}_2$  generates three ATPs. When  $\text{FAD}^+$  is a primary acceptor of electrons, the electrons are transported from complex II to III and then to complex IV. Thus, one molecule of  $\text{FADH}_2$  generates two ATPs.

The molecular oxygen forms the terminal constituent of the electron transport system. It is the ultimate recipient of electrons and picks up the protons from the substrate to form water.



**Fig. 5.20 Electron transport system**

### **Energy yield**

Complete oxidation of one glucose molecule yields a net gain of 38ATP. Out of 38ATP molecules, 4ATP are obtained by direct substrate level phosphorylation, 30ATP through oxidation of  $\text{NADH}_2$  and 4ATP through oxidation of  $\text{FADH}_2$ . Since, a large number of ATP molecules are produced in the mitochondria, they are called the ‘**power houses of the cell**’.

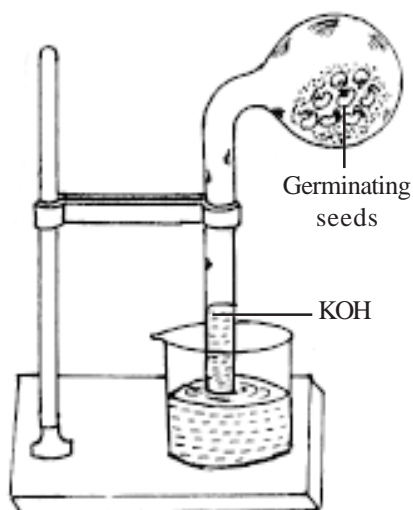
**Table showing details of ATP production in aerobic respiration**

| Sl. No. | Stages of respiration                     | Number of molecules of |                 |                 | Total number of ATP obtained |
|---------|---|------------------------|-----------------|-----------------|------------------------------|
|         |   | ATP                    | $\text{NADH}_2$ | $\text{FADH}_2$ |                              |
| 1.      | Glycolysis                                | 2                      | 2               | –               | 8                            |
| 2.      | Oxidative decarboxylation of pyruvic acid | –                      | 2               | –               | 6                            |
| 3.      | Krebs cycle                               | 2                      | 6               | 2               | 24                           |
|         | Total                                     | 4                      | 30 ATP          | 4 ATP           | 38                           |

### **Demonstration of respiration by Ganong’s respiroscope**

The aim of this experiment is to demonstrate liberation of carbon dioxide during respiration. The respiroscope is a glass apparatus consisting of a bulb like part with a bent neck and vertical tube. Germinating seeds are taken in the bulb and the mouth of the tube is kept immersed in the beaker containing KOH solution as shown in the figure. The respiroscope

is fixed in the vertical position with the help of a stand. Thus, the enclosed air in the bulb is completely cut off from the atmosphere. The apparatus is kept undisturbed for few hours.



*Fig.5.21 Ganong's respiroscope*

fermentation. In 1938, Dickens discovered an alternate pathway for the utilization of glucose by the living cells. This pathway is called **pentose phosphate pathway** or **hexose monophosphate pathway** or **direct oxidation pathway**. This pathway consists of major phases - oxidative and nonoxidative phases. Pentose phosphate pathway takes place in the cytoplasm only.

#### ***Oxidative phase***

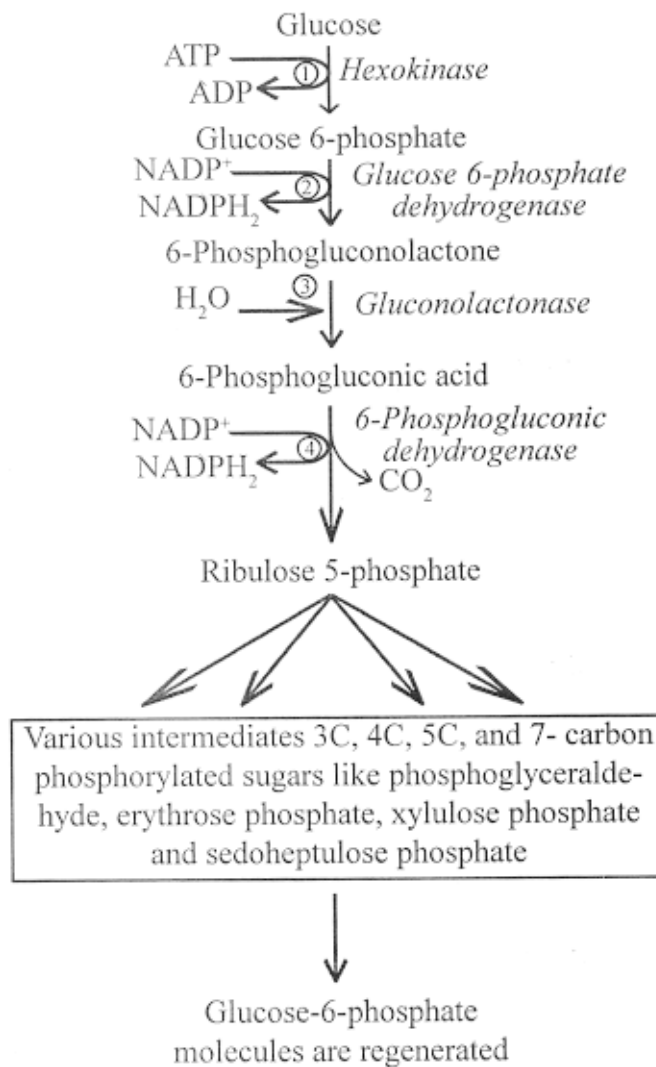
In this phase, glucose is oxidized and decarboxylated with the formation of pentose through phosphogluconic acid as shown in the flow chart. The essential feature of this phase is the production of  $\text{NADPH}_2$ .

1. Glucose is phosphorylated to glucose-6-phosphate by *hexokinase*.
2. The glucose-6-phosphate is oxidized to 6-phospho-gluconolactonate in the presence of  $\text{NADP}^+$  by enzyme *glucose-6-phosphate dehydrogenase*.  $\text{NADP}^+$  is reduced to  $\text{NADPH}_2$ .

It is observed that the level of KOH solution in the limb is raised. The KOH solution absorbs carbon dioxide released by the seeds and a vacuum is created. It results in the raise of KOH level.

#### ***5.3.4. Pentose phosphate pathway***

Generally, majority of living organisms obtain energy for various biochemical activities from glucose. In aerobic organisms, it is degraded in three major phases namely, glycolysis, Krebs cycle and electron transport system. In anaerobes, glucose is partially degraded by glycolysis and



**Fig. 5.22 Pentose phosphate pathway**

3. The 6-phosphogluconolactone is hydrolysed by *gluconolactonase* to form 6-phosphogluconic acid.

4. The 6-phosphogluconic acid undergoes oxidative decarboxylation again in the presence of NADP<sup>+</sup> to form Ru5P. This reaction is catalyzed by *6-phosphogluconic dehydrogenase*. NADP<sup>+</sup> is reduced to NADPH<sub>2</sub>. In this reaction CO<sub>2</sub> is released.



### ***Nonoxidative phase***

In this phase, various intermediates such as 3C, 4C, 5C and 7-carbon phosphorylated sugars are produced. They are phosphoglyceraldehyde (3C), erythrose phosphate (4C), xylulose phosphate (5C) and sedoheptulose phosphate (7C).

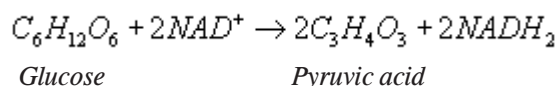
To summarize, six molecules of glucophosphate enter this pathway. After oxidation, six molecules of CO<sub>2</sub> are released as shown in the step 4 and twelve molecules of NADPH<sub>2</sub> are produced as shown in the steps 2 and 4. In other words, after oxidation one molecule of glucose produces six molecules of CO<sub>2</sub> and twelve molecules of NADPH<sub>2</sub>. Out of six glucose molecules one is completely oxidized and other five molecules are involved in the formation of 3C, 4C, 5C, and 7- carbon sugar intermediates. From these intermediates, five molecules of glucose-6-phosphate are regenerated.

### ***Significance of pentose phosphate pathway***

- It provides alternative route for carbohydrate breakdown.
- It generates NADPH<sub>2</sub> molecules which are used as reductants in biosynthetic processes. Production of NADPH<sub>2</sub> is not linked to ATP generation in pentose phosphate pathway.
- It provides ribose sugar for the synthesis of nucleic acids.
- It provides erythrose phosphate required for the synthesis of aromatic compounds.
- It plays an important role in fixation of CO<sub>2</sub> in photosynthesis through Ru5P.

### ***5.3.5. Anaerobic respiration***

Anaerobiosis means life in the absence of oxygen. Certain organisms can survive in the absence of oxygen. The respiration which takes place in the absence of free oxygen molecules is called anaerobic respiration. It occurs in yeast and some bacteria. Hence, they are known as anaerobes. Glycolysis alone occurs in these organisms. The splitting of glucose into two molecules of pyruvic acid is given in the following equation.



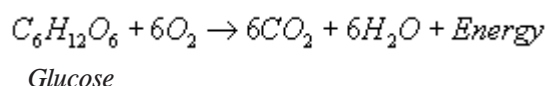
In anaerobic respiration, the respiratory substrate is not completely oxidized to release energy. Glucose is split into two molecules of pyruvic acid. The pyruvic acid is further converted into either ethanol or organic acids like lactic acid. Fermentation is a good example for anaerobic respiration.

### 5.3.6. Respiratory quotient

Respiratory quotient may be defined as “*the ratio between the volume of carbondioxide given out and oxygen consumed during respiration*”. This value depends upon the nature of the respiratory substrate and its rate of oxidation.

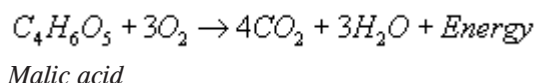
$$\text{Respiratory quotient} = \frac{\text{volume of } CO_2 \text{ evolved}}{\text{volume of } O_2 \text{ consumed}}$$

(i) *Respiratory quotient of a carbohydrate*



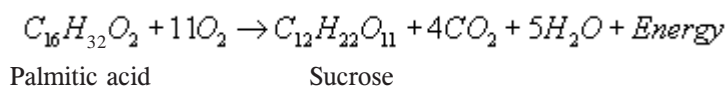
$$\text{Respiratory quotient of glucose} = \frac{6 \text{ moles of } CO_2}{6 \text{ moles of } O_2} = 1$$

(ii) *Respiratory quotient of an organic acid*



$$\text{Respiratory quotient of malic acid} = \frac{4 \text{ moles of } CO_2}{3 \text{ moles of } O_2} = 1.33 \text{ (more than one)}$$

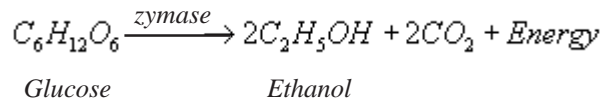
(iii) *Respiratory quotient of fatty acid*



$$\text{Respiratory quotient of palmitic acid} = \frac{4 \text{ moles of } CO_2}{11 \text{ moles of } O_2} = 0.36 \text{ (less than one)}$$

### **Respiratory quotient for anaerobic respiration**

In anaerobic respiration, carbondioxide is evolved but oxygen is not consumed. Therefore, the respiratory quotient in such case is infinity. For example,



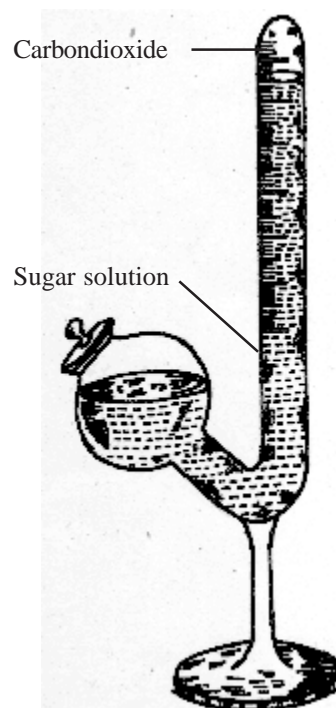
$$\text{Respiratory quotient of glucose in anaerobic respiration} = \frac{2 \text{ moles of } CO_2}{\text{zero moles of } O_2} = \infty \text{ (infinity)}$$

### **5.3.7. Compensation point**

At a given low concentration of carbondioxide and nonlimiting light intensity, the photosynthetic rate of a given plant will be equal to the total amount of respiration, which includes both dark respiration and photorespiration. The concentration of CO<sub>2</sub> at which photosynthesis just compensates the respiration is referred to as carbondioxide compensation point. At carbondioxide compensation point, the amount of CO<sub>2</sub> uptake for photosynthesis is equal to that of CO<sub>2</sub> generated. Through respiration including photorespiration, so the net photosynthesis is zero under these conditions.

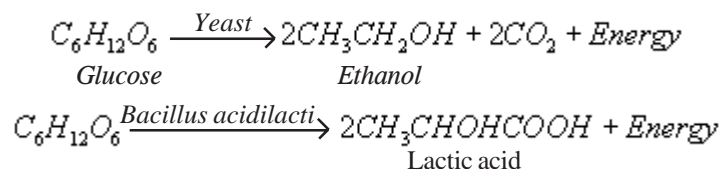
### **5.3.8. Fermentation**

Fermentation literally means a chemical change accompanied by effervescence. The anaerobic breakdown of glucose to carbondioxide and ethanol is a form of respiration referred to **fermentation**. It is normally carried by yeast cells and accounts for the production of alcohol in alcoholic beverages.



**Fig.5.23Kuhne's fermentation experiment**

In fermentation process, if glucose is converted into ethanol then it is called ethanolic fermentation.



When glucose is converted into organic acids such as lactic acid, then this type of fermentation is known as lactic acid fermentation. It is carried out by the bacterium *Bacillus acidilacti*.

### ***Kuhne's fermentation tube experiment***

Kuhne's fermentation tube consists of an upright glass tube and a side tube with a bulb. 10 per cent glucose solution mixed with baker's yeast is taken in the Kuhne's tube and the tube is completely filled. After some time, the glucose solution is fermented and gives out an alcoholic smell. The level in the upright tube will fall due to the accumulation of CO<sub>2</sub> gas. It is because yeast contains the enzyme *zymase* which converts glucose solution into alcohol and CO<sub>2</sub>. When a crystal of KOH is introduced into the tube, the KOH will absorb CO<sub>2</sub> and the level of the solution will rise in the upright tube.

### **Self evaluation**

#### ***I. Choose and write the correct options.***

1. Which of the following is the common respiratory substrate?
 

|                  |             |
|------------------|-------------|
| a. Proteins      | b. Lipids   |
| c. Carbohydrates | d. Vitamins |
2. The number of high energy terminal bonds present in ATP is
 

|          |         |
|----------|---------|
| a. one   | b. two  |
| c. three | d. four |
3. The first step in aerobic respiration is
 

|                       |                                |
|-----------------------|--------------------------------|
| a. glycolysis         | b. Krebs cycle                 |
| c. terminal oxidation | d. cyclic photophosphorylation |
4. Glucose is phosphorylated to glucose-6-phosphate by the enzyme
 

|                          |                      |
|--------------------------|----------------------|
| a. <i>aldolase</i>       | b. <i>enolase</i>    |
| c. <i>pyruvic kinase</i> | d. <i>hexokinase</i> |

5. Fructose 1,6-bisphosphate is cleaved to two molecules of 3 carbon compounds by
  - a. *aldolase*
  - b. *enolase*
  - c. *pyruvic kinase*
  - d. *hexokinase*
6. Cisaconitic acid is converted into isocitric acid by the addition of a molecule of water. This reaction is catalyzed by
  - a. *citric acid synthetase*
  - b. *fumarase*
  - c. *malic dehydrogenase*
  - d. *aconitase*
7. Complete oxidation of one molecule of glucose yields
  - a. 38 ATP
  - b. 36 ATP
  - c. 35 ATP
  - d. 2 ATP
8. Oxidative decarboxylation of pyruvic acid is catalysed by
  - a. *pyruvic dehydrogenase*
  - b. *pyruvic kinase*
  - c. *pyruvic mutase*
  - d. *pyruvic isomerase*
9.  $\alpha$  - ketoglutaric acid is a \_\_\_\_\_ carbon compound
  - a. two
  - b. three
  - c. four
  - d. five
10. Glucose is phosphorylated to glucose-6-phosphate by
  - a. *aldolase*
  - b. *kinase*
  - c. *mutase*
  - d. *hexokinase*
11. Respiratory quotient of glucose is
  - a. zero
  - b. unity
  - c. more than one
  - d. less than one
12. One molecule of  $\text{FADH}_2$  on oxidation yields
  - a. one ATP
  - b. two ATP
  - c. three ATP
  - d. four ATP
13. One molecule of  $\text{NADH}_2$  on oxidation yields
  - a. one ATP
  - b. two ATP
  - c. three ATP
  - d. four ATP

14. Formation of ATP during electron transport chain is known as
  - a. dephosphorylation
  - b. photophosphorylation
  - c. oxidative phosphorylation
  - d. substrate level phosphorylation
15. Which of the following is referred to as EMP pathway?
  - a. Glycolysis
  - b. Krebs cycle
  - c. Electron transport chain
  - d. Pentose phosphate pathway
16. The total amount of energy released from one molecule of glucose on oxidation is about
  - a. 1600 kJ
  - b. 2300 kJ
  - c. 2500 kJ
  - d. 2900 kJ
17. Which of the following is a 5C compound?
  - a. Phosphoglyceraldehyde
  - b. Erythrosephosphate
  - c. Xylulose phosphate
  - d. Sedoheptulose phosphate

**II. Answer the following questions in two or three sentences.**

18. Define respiration.
19. What is glycolysis?
20. Write the overall reaction of glycolysis.
21. What is the function of *aldolase* in the process of glycolysis?
22. What is Krebs cycle?
23. What is the role of *aconitase* in Krebs cycle?
24. What is oxidative phosphorylation?
25. Explain anaerobic respiration?
26. Define respiratory quotient.
27. The respiratory quotient for anaerobic respiration is infinity. Give reasons.
28. What is fermentation?

**III. Answer the following questions in about 100 words.**

29. Write short notes on electron transport chain.
30. Explain Ganong's respiroscope experiment.
31. Write the significance of pentose phosphate pathway.

32. Write short notes on anaerobic respiration.
33. Explain respiratory quotient for carbohydrate, organic acid and fatty acid.
34. What is compensation point? Explain.
35. What is fermentation? Explain.
36. Explain oxidative decarboxylation of pyruvic acid.
37. Draw the overall representation of respiration.
38. Write short notes on energy yield from one molecule of glucose on complete oxidation.

***IV. Answer the following questions in about 200 words.***

39. Write an account on glycolysis.
40. Describe the sequences of reactions of Krebs cycle.
41. Explain pentose phosphate pathway.

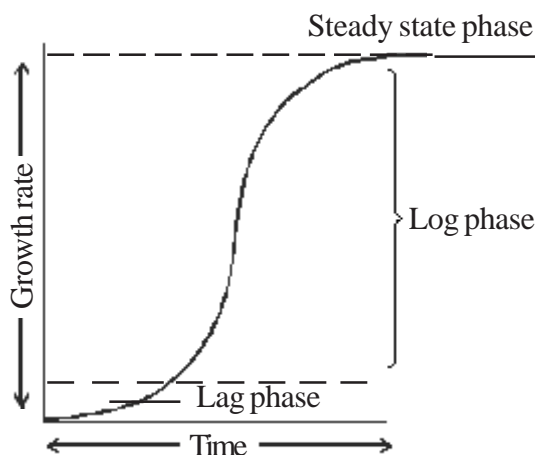
## 5.4. Plant growth

Growth is one of the most fundamental and conspicuous characteristics of living organisms. Growth may be defined as an irreversible increase in mass, weight and size of a living organisms. In most cases, it results in increase in dry weight and the amount of protoplasm. Growth in higher plants includes cell division, enlargement and differentiation. Increase in the number and size of cells by itself cannot account for the development of an organized plant. For example, when a seed is sown, it does not become a larger seed but it grows as a seedling. Thus, growth is always accompanied by differentiation. Differentiation is the transformation of identical cells into different tissues. Depending upon the various structural, functional and physiological needs of the plant the tissues are of different types. Growth and differentiation results in development, which leads to gross form of the plant. Meristematic cells present in the plant body viz., root, shoot apices, and the cambium are responsible for growth in plants.

### *Phases of growth*

The growth in length of the plant is due to the meristematic activity of the apical meristems that takes place in the root and shoot apices. Whereas increase in thickness of stem and root is due to the activity of lateral meristem. You have already learnt in chapter 2 about different types of meristems. The period of growth is generally divided into three phases

viz., formation, elongation and maturation. In the first phase, new cells are continuously formed by the apical meristem. In the second phase known as phase of elongation, the newly formed cells enlarge in size. In the third phase, phase of maturation, cells start maturing to attain permanent size and form. The rate of plant growth is slow in the initial stages and



*Fig. 5.24 Sigmoid curve*

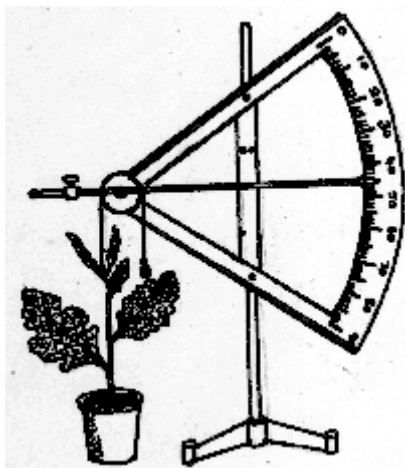


this phase is called **lag phase**. It is followed by a rapid growth phase called **log phase**. In the third and final phases, the growth slows down and the organism maintains the size it has already attained. This phase is known as stationary phase or **steady state phase**. The growth in size or increase in number of cells if plotted against time the graph shows 'S' shaped curve known as sigmoid growth curve as shown in the figure.

In the annual plants the last phase i.e. steady state phase is followed by senescence i.e. arrest of growth and death. However, in the case of large trees each growing season exhibits a sigmoidal pattern of growth.

### **Measurement of growth**

You have already known that the growth in length of the plant is due to the activity of the apical region of shoot and root. So in any plant the growth in length can be measured in ordinary measuring scale at an interval of time. For precise measurement, an instrument called 'Lever Auxanometer' is used. It measures the rate of growth of plant in terms of



*Fig. 5.25 Lever auxanometer*

short length. The auxanometer consists of a movable pointer attached to a pulley and a graduated arc fixed to a stand. A thread passes around the pulley. One end of the thread is tied to the growing tip of the potted plant. The other end is tied to a small weight. As the plant grows in length the pulley rotates and needle attached to the pulley moves down the scale. From this, growth in length of the plant can be measured at a given interval of time.

The actual growth in the length of a plant is measured as follows.

$$\text{Actual growth in length} = \frac{\text{Distance travelled by the pointer} \times \text{Radius of the pulley}}{\text{Length of the pointer}}$$

### ***Plant growth substances***

The growth of a plant is regulated through gene action and environmental conditions. There are substances, which are produced by plants themselves, which regulate their growth and many physiological and biochemical activities. These are called plant growth substances. Regulation of plant growth through chemical mechanisms frequently involves certain molecules known as hormones.

Based on the origin and biological activities plant growth substances are grouped into three - growth regulators, phytohormones and growth inhibitors.

### ***Growth regulator***

It is a hormone like synthetic organic compound. In small amounts, it modifies the growth and development either by promoting or inhibiting the growth. eg. Naphthalene acetic acid (NAA).

### ***Phytohormones***

These are organic substances produced by the plant. They are active in very minute quantities. They are synthesised in one of the parts of the plant and translocated to another part where they influence specific physiological, biochemical and morphological changes. The phytohormones are broadly grouped under five major classes namely auxins, gibberellins, cytokinins, ethylene and abscisic acid.

### ***Auxins***

Auxin was the first plant hormone to be discovered. They were isolated initially from human urine. The term auxin is given to generally IAA and other natural and synthetic compounds having similar structure and growth regulating properties. Generally, auxins are produced in the growing apices of stem and root where from they migrate to the other parts of the plant. Auxins such as IAA and phenyl acetic acid (PAA) are natural auxins. Synthetic auxins are chemicals synthesised in the laboratory. They are considered as plant growth regulators. eg. Naphthalene acetic acid, 2,4 - Dichlorophenoxy acetic acid.

### ***Physiological effects of auxin***

- Auxins are well known to promote elongation of stem and coleoptile. It promotes the growth by cell enlargement in stems, particularly by elongation of cells behind the apical meristem.
- Growth in lateral bud is inhibited when the apical bud of a tall plant remains intact. However, the lateral bud grows rapidly on removal of apical bud.
- Suppression of growth in lateral bud by apical bud due to auxin produced by apical bud is termed as **apical dominance**. The reason for this is due to auxin produced in growing tip and it stimulates growth but as it moves downward, suppresses growth in the stems below.
- Auxin is responsible for initiation and promotion of cell division in cambium, which is responsible for the secondary growth. This property of induction of cell division has been exploited for tissue culture techniques and for the formation of callus.
- Auxin promotes growth of root only at extremely low concentrations. At higher concentrations, it always inhibits growth of root.
- When leaves and fruits mature, they shed from the stem. This is called abscission. Auxin prevents abscission.
- Seedless fruits are produced in tomato and apple, by external application of auxin on flowers. Such seedless fruits are called parthenocarpic fruits.
- 2,4 – Dichlorophenoxy acetic acid, a synthetic auxin is used to eradicate weeds in the field.

### ***Gibberellins***

Gibberellin was first discovered in Japan by Kurusowa. He observed from his field that some of the rice seedlings had grown much taller than the others. On further observation, he found that such taller rice plants had shown unusual internodal elongation. This internodal elongation is known as the '**bakanae**' or '**foolish seedling**' disease of rice. Later, it was discovered that the elongation was due to the action of a substance produced by a fungus, *Gibberella fujikuroi*. This substance was successfully isolated from the fungus and it was named as gibberellic acid.

There are over 90 different gibberellins isolated from fungi and from higher plants. Gibberellins occur in various plant organs. They are named as GA<sub>1</sub>, GA<sub>2</sub>, GA<sub>3</sub>, etc. These phytohormones occur in all groups of plants.

#### ***Physiological effects of gibberellin***

- Gibberellins produce extraordinary elongation of stem. The elongation of stem is caused by the cell division and cell elongation induced by gibberellic acid.
- One of the most striking effects of the gibberellins is the reversal of dwarfism in many genetically dwarf plants. For e.g. 'Rosette' plant of sugar beet, when treated with GA undergoes marked longitudinal growth of axis attaining the normal size.
- Rosette plants usually show reduced internodal growth. These plants exhibit excessive internodal growth when they are treated with gibberellin. This sudden elongation of stem followed by flowering is called **bolting**.
- Many biennials usually flower during the second year of their growth. For flowering to take place, these plants should be exposed to cold season. Such plants could be made to flower without exposure to cold season in the first year itself, when they are treated with gibberellins.
- Formation of seedless fruits without fertilization can also be induced by gibberellin treatment in many plants. eg. Tomatoes, apples, cucumbers, etc.,
- Some of the light sensitive seeds can germinate by the treatment of gibberellic acid even in complete darkness. eg. barley,
- Gibberellin breaks dormancy in potato tubers.

#### ***Cytokinin***

Cytokinin is a plant growth substance, which stimulates cell division. This was isolated by Miller and Skoog in 1954 from Herring fish. Following the discovery of **kinetin** many other compounds showing similar activity were discovered. These are collectively called cytokinins. The cytokinin found in the *zea mays* is called **zeatin**. Cytokinin is also found in the

endosperm of coconut. Cytokinin occurs in various seed plants. They are found particularly in embryos, developing fruits and roots. Varying mixtures of auxin and cytokinin influence plant growth and differentiation.

#### ***Physiological effects of cytokinin***

- The most important function of cytokinin is the promotion of cell division.
- In association with IAA, cytokinin initiates bud and root formation in callus tissue.
- External application of cytokinin promotes the growth of lateral buds even if the apical bud is intact.
- Cytokinin breaks the dormancy of many seeds and also promotes germination.
- Application of cytokinin delays the process of ageing in plants. This is also known as Richmond Lang effect.

#### ***Ethylene***

Ethylene is a simple gaseous hormone. It is usually present in a minute quantity. It is synthesised in large amounts by tissues undergoing ageing and acts as a natural plant growth hormone.

#### ***Physiological effects of ethylene***

- Ethylene prevents elongation of stem and root in longitudinal direction. Simultaneously, the tissue enlarges radially resulting in thickening of plant parts.
- Ethylene promotes positive geotropic growth of roots.
- Ethylene inhibits the growth of lateral buds in pea seedlings.
- Ethylene is involved in the ripening of fruits.
- Ethylene stimulates the formation of abscission zone in leaves, flowers and fruits. This causes leaves, flowers and fruits to shed prematurely.
- Flowering can be induced by application of ethylene in plants like pineapple and mango.
- Ethylene stimulates rooting of cuttings, initiation of lateral roots and growth of root hair.
- Ethylene is responsible for breaking the dormancy of buds and seeds.

### ***Abscisic acid***

Abscisic acid (ABA) was originally discovered for its role in regulating abscission and bud dormancy. Like other plant hormones, it has multiple functions in the growth of plants.

#### ***Physiological effects of abscisic acid***

- Abscisic acid acts as growth inhibitor and induces bud dormancy in a variety of plants.
- ABA is a powerful growth inhibitor. It causes 50 per cent inhibition of growth of oat seedlings.
- As the name suggests abscisic acid is an hormone that stimulates abscission.
- ABA controls geotropic responses of roots. It stimulates positive geotropism in roots.
- Abscisic acid causes closure of stomata.

#### ***Growth inhibitors***

Some organic substances produced in the plant inhibit the plant growth. These substances are called growth inhibitors. They inhibit the elongation in roots, stems and leaves. For example, ethylene is a potent inhibitor of bud growth. ABA inhibits lateral bud growth in tomato.

### **Self evaluation**

#### ***I. Choose and write the correct options.***

1. Which one of the following plant hormones was first discovered?
  - a. Auxin
  - b. Gibberellin
  - c. Cytokinin
  - d. Ethylene
2. An example for synthetic auxin is
  - a. IAA
  - b. PAA
  - c. ABA
  - d. NAA
3. Apical dominance is due to
  - a. ethylene
  - b. auxin
  - c. gibberellin
  - d. cytokinin

4. Bakanae disease in paddy is caused by
  - a. abscissic acid
  - b. phenyl acetic acid
  - c. naphthelene acetic acid
  - d. gibberellic acid
5. In sigmoid curve the rapid growth phase is designated as
  - a. lag phase
  - b. log phase
  - c. dormant phase
  - d. steady state phate
6. Auxin prevents
  - a. apical dominance
  - b. ageing process
  - c. parthinocarpy
  - d. abscission
7. "Foolish seedling" disease of rice is caused by
  - a. auxin
  - b. gibbrellins
  - c. cytokinin
  - d. abscisic acid
8. Closure of stomata is caused by
  - a. auxin
  - b. gibbrellins
  - c. cytokinin
  - d. abscisic acid
9. The chemical used in the field to eradicate weeds is
  - a. 2, 4 - D
  - b. IAA
  - c. ABA
  - d. urea
10. Abscission is prevented by
  - a. Auxin
  - b. Gibberellin
  - c. Cytokinin
  - d. Ethylene
11. Which of the following is a gaseous hormone?
  - a. Kinetin
  - b. Zeatin
  - c. Auxin
  - d. Ethylene
12. Which of the following is natural auxin found in higher plants?
  - a. I.A.A.
  - b. 2, 4-D
  - c. GA
  - d. Zeatin

**II. Answer the following questions in two or three sentences.**

13. What is a growth inhibitor? Give an example.
14. Write any two physiological effects of abscisic acid.
15. What is Richmond Lang effect?
16. Define Bolting.
17. What is apical dominance?

18. Define growth regulator.
19. What are called phytohormones?

**III. Answer the following questions in about 100 words.**

20. Explain the experiment to measure the actual longitudinal growth of plant by lever auxonometer.
21. Bring out the physiological effects of auxin.
22. Write the physiological effects of gibberellin.
23. Write short notes on physiological effects of cytokinin.
24. What are the physiological effects of ethylene.
25. Explain the different phases of growth with sigmoid curve.

**IV. Answer the following questions in about 200 words.**

26. Write an essay on auxins and gibberellins with their physiological effects
27. Write an account on cytokinin, ethylene and abscisic acid with their physiological effects.



### 5.5. Photoperiodism and vernalization

The response of a plant to the relative lengths of light and dark periods is known as **photoperiodism**. In plants, most significant photoperiodic response is the initiation of flowering. It has been first observed in Maryland Mammoth variety of tobacco (*Nicotiana tabacum*).

From the observation of Garner and Allard all the plants do not require the same length of light and dark periods for flowering. Plants require specific period of light and darkness for flowering. It is known as critical period.

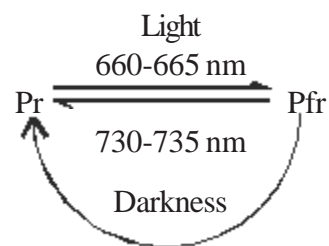
*Plants are classified into three classes*

1. The plants requiring longer exposure to light than their critical period are known as **long day plants** eg. wheat and oats.
2. The plants requiring light for a shorter period than their critical period are known as **short day plants** eg. tobacco and *Chrysanthemum*.
3. The plants in which flowering is unaffected by the photoperiod are known as **day neutral plants** eg. sunflower and maize.

#### *Phytochromes and flowering*

In 1959, Butler et al. were able to discover a photoreceptor flower inducing pigment in plants which they name phytochromes. It is believed to be widely present in all green plants. Chemically, phytochrome is a biliprotein and exists in two forms. One form absorbs red with the wave length of 660 nm called Pr and the other form absorbs far red with the wave length of 730 nm called Pfr. The two forms of phytochrome are interconvertible as shown below:

Based on the absorption spectra, Pr is also called P 660 and Pfr is P 730. In short day plants, Pr promotes flowering while Pfr suppresses it, while it is viceversa in long day plants.



#### *Vernalization*

The term vernalization was first introduced by a Russian scientist T.D. Lysenko in 1920. Many species, especially biennials and perennials are induced to flower at low temperature range of 1°C to 10°C. This is known as vernalization.

The response to the cold temperature stimulus is not uniform in all plants. Plants, which are vernalized, are called inductive types. Those nonvernalized are called noninductive types.

### ***Techniques of vernalization***

The following are the steps to be taken to induce vernalization. Seeds are allowed to germinate and subjected to cold treatment for varying period of time depending on the species. Germinated seeds after this treatment are allowed to dry for sometime and then sown.

### ***Devernalization***

Reversal of the effect of vernalization is called Devernalization. Subjecting the plants to higher temperature after a cold treatment brings about devernalization.

### ***Practical application of vernalization***

Russian scientists have used vernalization to shorten the time of crop maturity by hastening the flowering processes which are brought about by cold treatment.

### ***Advantages***

Crops can be produced earlier by vernalization. They can be cultivated in places where they naturally do not grow. Vernalization helps to accelerate the plant breeding.

## **Self evaluation**

### ***I. Choose and write the correct options.***

1. The response of a plant to the relative lengths of light and dark periods is known as
  - a. vernalization
  - b. photorespiration
  - c. photosynthesis
  - d. photoperiodism
2. Photoperiodic response in flowering was first observed in
  - a. wheat
  - b. Maryland Mammoth
  - c. Oats
  - d. Chrysanthemum
3. Which of the following is a short day plant?
  - a. wheat
  - b. tobacco

- c. sunflower                      d. maize  
4. Which of the following is a long day plant?  
a. tobacco                      b. sunflower  
c. maize                      d. wheat

**II. Answer the following questions in two or three sentences.**

5. Define photoperiodism.
6. What are called long day plants?
7. What is a short day plant?
8. Define vernalization.
9. Write about the techniques of vernalization.
10. What is devernalization?
11. Write any two advantages of vernalization.

**III. Answer the following questions in about 100 words.**

12. Write short notes on phytochromes and flowering.
13. Write short notes on vernalization.

**IV. Answer the following questions in about 200 words.**

14. Write an account on photoperiodism and vernalization.

**Reference**

1. Plant physiology by Devlin and Witham first Indian edition 1986.
2. Modern practicals botany B.P. Pandey vol. II. New print 2003.
3. Plant physiology by V.K. Jain first edition 2003.
4. Fundamentals of biochemistry-JL.Jain, Sanjay jain and Nitin jain 2003.
5. Plant physiology by Noggle and Fritz, Practice hall of India, 1992.
6. Plant physiology by Kochhar and Krishnamoorthy, 1992.

## 6. BIOLOGY IN HUMAN WELFARE

The world's human population, which was only one billion during 1850, had reached 6.1 billion around year 2000. This dramatic increase in population, otherwise called 'population explosion' has created its impact not only on the environment but also on food production.

Half of this 6.1 billion people live in poverty and one fifth of this population suffer due to malnutrition. Increase in population, unplanned industrialization and migration towards cities and urban areas has resulted in the degradation of the environment. The present agricultural practices have polluted cultivable land physically, chemically and biologically. The net productivity is gradually being reduced. These factors lead to the shrinkage of the agricultural lands and a fall in agricultural production.

### 6.1. Food production

In order to fight the menace of hunger and malnutrition, we need crops with greater yield and better nutritive value. The quantity and quality of crops can be improved by modern scientific methods through genetic manipulation called genetic engineering. However, the time old concept of breeding plants either interspecific or intraspecific to bring out the best hybrid plant in plant breeding programmes still remains in vogue even today. Efforts are being made by ICAR – Indian Council of Agricultural Research and other related organisations in our country to increase food production.

A plant breeder strives to get a group of plants or a variety with suitable combination of genes that gives better yield and improved quality under a particular set of environmental conditions. A single species is a group of assemblage of innumerable number of genetic types such as lines, strains, etc. The strains are tested in various climatic conditions, successful ones are named, multiplied and distributed as a variety or cultivar eg. *Oryza sativa* Co.15, ADT. 16.

#### ***Breeding experiments***

Increase in population has forced us to carry out continuous scientific experiments for the following reasons *viz.*

1. To develop more food crops
2. To increase quality in food crops and
3. To have sustainable food quality in food crops and assured food supply.

By introducing specialized technology, plant breeders are now able to develop more crops, which they multiply and supply them to the growers. Improvement in the genetic make up of plants is called plant breeding.

*Major aspects of plant breeding include*

1. creation of useful variation in the cultivable crops.
2. selection of better crops.
3. conducting / carrying out breeding experiments to assess the quality of the crop and
4. release of a variety after their extensive multiplication.

*Aims of plant breeding*

The first and foremost aim in plant breeding is to create useful variation in the crop plant. This can be achieved by the following measures.

1. Bringing wild food crops to cultivation. (wheat, oats and many cereal crops were once wild plants which had now been domesticated).
2. Obtaining genes from desirable plants or related species (eg. as seeds from various parts of the world).
3. Introduction of plants from nearby regions or even from other countries for improvement of the crop. (eg. cauliflower, tomato, potato and soyabeans).
4. By employing certain plant breeding techniques, new varieties are developed. eg. maize, sorghum, cotton and sunflower.
5. Auto and Allopolyploid breeding.
6. By inducing mutations using physical and chemical mutagens.
7. Production of haploids by the application of plant tissue culture of anther and ovary.
8. Improvement of nutritional quality by genetic engineering (eg. Fortified rice - iron rich rice and carotene rich rice).
9. Development of disease, drought and environmental stress resistant varieties.

### ***Aspects of plant breeding***

Present day crop plants are from wild species reared by careful domestication, cultivation and management. We have several wild varieties existing in nature just as in the case of salinity tolerant wild rice. Through gene manipulation, the gene for salinity tolerance could be cloned in a rice variety. In such of those areas where shortage of fresh water exists, rice can be cultivated using seawater and can even be grown in extreme saline soil. Similarly, we need many more such wild plants showing increased capacity to extremes of climatic conditions and disease resistance for plant breeding programmes. In order to safeguard the biodiversity and certain important valuable crops from going into extinction, scientists are protecting these crops by establishing gene or germplasm banks by preserving their seeds.

### ***Selection***

It is one of the oldest procedures in which individual plants or group of plants are sorted out from mixed population, thus eliminating undesirable ones. Selection methods are of two types - mass selection and pure line selection.

### ***Mass selection***

In this method, plants are selected based on their desirable morphological characters (phenotype). Their seeds are composite or mixed and the progenies are grown in masses. They are not individually tested. After repeated selection for about five to six years, selected seeds are multiplied and distributed to farmers. The only disadvantage of mass selection is that it is difficult to distinguish hereditary variation from environmental variation.

### ***Pure line selection***

A pure line is a collection of plants obtained as a result of repeated self-pollination from a single homozygous individual. Hence, a variety formed by this method shows more homozygosity with respect to all genes. One disadvantage is that new genotypes are never created by this method. Genetic variability is essential for adaptations in different environmental and seasonal conditions.

### ***Clonal selection***

Crops like sugarcane, potato, tea, banana and certain species of grasses are asexually propagated and produce very poor seeds. Based on their phenotypic appearance, the method of clonal selection is employed to select improved variety from a mixed population (clones). Selected plants are multiplied through vegetative propagation to give rise to a clone. The genotype of a clone remains unchanged for a long period of time.

### ***Introduction***

India has several varieties of crops such as maize, tobacco, tomato, potato and brinjal which were introduced from countries such as America, China and Australia. Introduced varieties sometimes do not get adjusted easily with our local environment. It takes some time for these introduced crops to settle. Sometimes, it is essential to select suitable and desirable variety from the introduced plants. For example, a mung *Phaseolus mungo* variety was introduced from China but was not giving good yield and produced dull coloured seeds. From amongst the introduced mung crop, a plant suddenly produced large and bright coloured seeds. This aspect may be due to sudden mutation. This variant plant was selected and further subjected to inter or intra specific crosses with our native crop. In this way, new varieties were produced and released as newly developed mung variety. Such a mung No.1 variety is now being cultivated in Punjab.

### ***Hybridization***

Hybridization is a method in plant breeding to improve the native crops by obtaining diverse genotypes that can be used as a source material for collection of crop with desirable characters and genes obtained from many parts of the world. It involves crossing of two varieties or species or genera having desirable genes and breeding them together of the desirable traits into one progeny, which is called the hybrid. Hybrids are the products of first generation obtained by crossing genetically unrelated parents.

When two individuals of the same species are crossed, it is called inbreeding or selfing or self-pollination. This results in the increase of homozygosity. Particularly homozygous recessive alleles develop loss of vigor in plants. By careful observation of morphological features, we can remove these deleterious and harmful alleles by selection.

### ***Protoplasmic fusion or somatic hybridization***

A hybrid produced from fusion of protoplasts of two different species is called somatic hybridization. Naked protoplasts are obtained through dissolution of their cell walls by the macerating enzymes such as *pectinase* and *cellulase*. Fusion of protoplasts from two different varieties can be enhanced by treatment with the chemical called polyethylene glycol (PEG) in the presence of high voltage electric current on a suitable medium. By this method somatic hybrid plants with desirable changes can be obtained. This method in plant breeding is called protoplasmic fusion. This concept had been studied by you already in the chapter four.

### ***Heterosis***

The superiority of the F<sub>1</sub> hybrid in performance over its parents is called heterosis or hybrid vigour. Vigour refers to increase in growth, yield, resistance to diseases, pests and drought. F<sub>1</sub> hybrids of maize show 25% increase in yield when compared to their own parent crop. Vegetative propagation is the best suited measure for maintaining hybrid vigour, since the desired characters are not lost and can persist over a period of time.

### ***Polyploid breeding***

The source for plant breeding is variations in plants.. Heritable and desirable variations occur in nature by mutation, polyploidy, recombination and chromosomal aberrations. A diploid plant has two sets of chromosomes but any organism in which the number of sets of chromosome is doubled is called a polyploid.

When chromosome number is doubled by itself in the same plant, it is called autopolyploidy. For example, three sets of chromosomes i.e. a triploid condition in sugar beats, apples and pear has resulted in the increase in vigour and fruit size, large root size, large leaves, flower, more seeds and sugar content in them. Seedless tomato, apple, watermelon and orange are autopolyploids.

Polyploidy can be induced by the use of colchicine to double the chromosome number. Allopolyploids are produced by multiplication of chromosome sets that are initially derived from two different species. eg. *Triticum* × *Secale* gives *Triticale*.



The haploid individual plant will have only one set of chromosome. Through the technique of anther and ovary culture, haploid plants can be modified to diploid ones by doubling their chromosomes. Variations that are brought forth through plant tissue culture are called somoclonal variation. eg. disease resistant potato and rust resistant wheat. Varieties of short duration sugarcanes are produced by polyploid breeding.

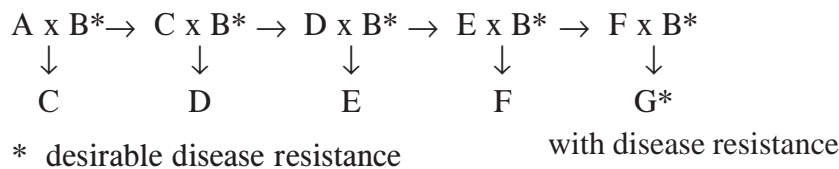
***Mutation breeding***

Radiation induces mutation to develop new variety of crops. Now with newer and more powerful sources of radiations (UV shortwave, X-ray, Alpha, Beta, Gamma waves) and many chemicals (mutagens) eg. Caesium, ethyl methane sulfonate, nitromethyl urea), we can increase the rates of mutation eg. Triple gene dwarf wheat with increase in yield and height. Atomita 2-rice with saline tolerance and pest resistance, groundnuts with thick shells are products of breeding methods through induced mutation.

***Breeding for disease resistance***

Many crop plants suffer from several diseases caused by pathogens such as bacteria, fungi, viruses, nematodes, protozoa and mycoplasma. In vegetatively propagated plants like potato, cassava, sugarcane and dahlia, viral pathogens are transmitted through their roots, tubers, bulbs and rhizomes. Disease free plants are obtained by shoot apical meristem culture technique. Plants raised through tissue culture are free from pathogens, which are widely cultivated.

Whenever, a trait that shows disease resistance in a plant is observed, the best way to transfer that trait to other useful crop is by the method of backcross. Repeated back crosses are attempted with the parent crop with more desirable characters and such a crop is known as recurrent parent. For example, A is a non-recurrent parent and B\* is a recurrent parent with desirable trait.



### ***Genetic engineering***

Genetic engineering will enable the plant or animal breeder to select the particular gene from one plant and then place the same gene into another plant for it to express its desired character. Today, genetic engineering is widely employed as a tool in modern crop improvements. Recombinant DNA technology, popularly termed 'gene cloning' or 'genetic engineering' offer unlimited opportunities for creating new combination of genes that at the moment do not exist under natural conditions. Genetic engineering can be defined as the formation of new combinations of heritable material by the insertion of foreign nucleic acid molecule from other sources.

The foreign genes are generally incorporated into a host organism either through a bacterial plasmid or a virus, which acts as vectors (vehicular traffic). Genes are compared to biological software and are the programs that drive the growth development and functioning of an organism. By changing the software in a precise and controlled manner, it becomes possible to produce desired changes in the characteristics of the organisms. eg. *E. coli* is made to produce human insulin by introduction of human insulin producing gene into bacterial plasmid.

Genetic engineering is a tool used in modern crop improvement programs. Its objective is to isolate and introduce a gene or genes into a crop plant that normally does not possess them. Addition of genes or DNA (foreign genes) from one plant or a microbe to another plant is called transgenic plant. Herbicide resistance, saline resistance, altered flower colour, improved protein quality and protection against viral infection are few examples of recently formed transgenic higher plants by using this technology eg. tobacco, tomato, potato, sunflower and apple.

### ***Improved varieties***

Improvement of a crop lies in its genetic make up and the environment in which it grows and interacts. An improved variety is one that is superior to other existing varieties in one or few characters. It may show high yield than other varieties, early maturity, disease and pest resistance. A new improved variety is developed by continuous breeding experiments as described above under various methods. By making use of modern technologies, like biotechnology, tissue culture and conventional breeding

methods new improved crops are obtained with desirable characters that suits well to the existing environment without polluting or altering it in any way. In order to release a newly created variety it takes nearly 12 years involving extensive field trials, naming and multiplication.

### ***Role of biofertilizers***

Extensive use of fertilizers and chemical pesticides had resulted in soil and water pollution. Fossil fuels such as petrol and coal are used in the manufacture of fertilizers and pesticides. To reduce pollution and over usage of our non-renewable resources like coal, petroleum, etc., an alternative method has been successfully developed to safeguard natural resources. To maintain soil fertility and soil improvement, fertilizers of biological origin called biofertilizers have been developed.

Artificial inoculation of rice and other crop fields with cyanobacteria (*Anabaena*, *Calothrix*, *Gleocapsa*, *Lyngbya*, *Nostoc*, *Oscillatoria*, *Scytonema*) has attracted much attention to increase fertility in several countries. The term 'biofertilizer' denotes all the nutrient inputs of biological origin for plant growth. Biological origin refers to microbes producing nitrogen compounds. Bacteria and cyanobacteria are known to fix atmospheric nitrogen and are known as biofertilizers. Nitrogen fixing bacteria like *Azotobacter*, *Bacillus* and *Rhizobium* increased the crop yield to 20%. *Pseudomonas striata* are used as seed inoculants as biofertilizer coats for cereals.

### ***Green manuring***

Various leguminous plants like *Crotalaria juncea*, *Cassia mimusoides*, *Glycine max*, *Indigofera linifolia*, *Sesbania rostrata*, *Acacia nilotica*, *Leucena*, *Lathyrus* and *Mucuna* are used as green manures. They accumulate more than 80 Kg of nitrogen per hectare in the soil when grown as green manures.

*Azolla* is an aquatic fern, which contains an endophytic cyanobacterium *Anabaena azollae* in its leaves. It is used as a biofertilizer in rice field. Out of six species of *Azolla*, *A. pinnata* is widely employed as a successful biofertilizer in Indian rice fields. It adds 30 Kg of nitrogen per hectare where the yield is equivalent to that of urea or ammonium phosphate.

### ***Mycorrhiza as biofertilizer***

Mycorrhiza is a root inhabiting fungus found around or inside the roots of many plants. It increases growth and yield and also provides protection to the roots against edaphic (soil) stresses, pathogen and pests. It helps in the increased uptake of soil and mineral water solution by the plant root system. It provides many uses for the host plants eg. VAM (Vesicular Arbuscular Mycorrhiza) fungi. Mycorrhiza is of two types.

- a. Ectotrophic mycorrhiza, which are found only outside the surface of roots of plants. eg. Basidiomycetous fungi.
- b. Endotrophic mycorrhiza, which are found inside the roots, in the intercellular spaces and even inside the cell (intra and intercellular) eg. VAM fungi.

### ***Benefits from biofertilizers***

1. Biofertilizers are easy to produce in abundance and are available at low cost to the marginal farmers.
2. It increases soil fertility without causing any damage to the soil.
3. Application of biofertilizers increases yield upto 45 per cent and the left over biofertilizers in the soil increases yield as long as the biofertilizer remains in the soil up to 3 to 4 years.
4. *Azolla*, which is a biofertilizer amends the soil with organic matter. Cyanobacteria in particular secrete growth promoting hormones like indole 3-acetic acid, indole butyric acid, naphthalene acetic acid, aminoacids, protein and vitamins to soil.
5. Cyanobacteria grow well both in acidic as well as in alkaline soils. Since, cyanobacteria are potent neutralizers, they help in the neutralization of soil. The process of converting untenable, fallow land to cultivable soil is termed as soil reclamation. Blue green algae play a vital role in this conversion.
6. Symbiotic nitrogen fixing *Rhizobium* is a biofertilizer. It adds 50 to 150 Kg of nitrogen to soil per hectare. *Azotobacter* and *Azospirillum* secrete antibiotics which act as biopesticides.
7. Ectotrophic mycorrhiza, which acts as a biofertilizer, increases the surface area of the roots of host plants, so that more absorption of nutrients by the roots is made possible.

## 6.2. Crop diseases and their control

The diseases in crop plants result in a heavy loss of crop yields and cause considerable damage to crops year after year. To check the plant diseases, it becomes necessary to know about the cause of the diseases, of the life history of the causal organism and of the meteorological conditions which influence the host and parasite interaction.

Control measures may be divided into two main groups – prophylaxis and disease resistance. **Prophylaxis** includes the protection of the host from exposure to the pathogen, from infection or from environmental factors favourable to disease development. **Disease – resistance** implies the improvement of resistance of the host to infection and to disease development.

### SPECIFIC DISEASES

#### Rice - *Oryza sativa*

*Pathogen* Disease incited by a fungus, *Pyricularia oryzae*.  
*Name of the disease* Blast disease of rice.  
*Systematic position* The fungus belongs to class: Deuteromycetes.

#### *Symptoms*

The symptoms are found on the leaf blades, leaf sheaths and rachis. Characteristic isolated, bluish – green necrotic lesions with a water – soaked appearance are formed on the leaf – blades. The lesions are broad in the centre and possess narrow elongations on its top and bottom. The lesion – formation leads to ultimate drying of the leaves, and the seedlings wither and die.

After transplantation, the symptoms appear in the form of necrotic lesions both on the leaf lamina and the leaf sheaths. The necrotic lesion is spindle shaped grey in the centre and remain surrounded by brown and yellowish zones. The leaves ultimately dry up.

#### *The pathogen*

The fungus *Pyricularia oryzae* when young possesses hyaline and septate mycelium. On maturity, the colour of mycelium changes to olive brown. Conidia are produced terminally. Each conidium is obpyriform septate with a small basal appendage.

### ***Control measures***

The most economic method of control is the cultivation of resistant, high yielding varieties.

### ***Seed treatment***

Immersion of the seeds in 0.2 per cent solution of Kalimat B for 24 hours controlled the disease and promoted the growth of seedlings. The seed protectants such as agrosan, cerasan and spergon have been proved responsible for the control of disease.

### ***Sanitation***

Plant debris should be collected and destroyed. The secondary host plants such as *Digitaria marginata* should be collected from paddy fields and destroyed.

### ***Spraying and dusting***

Blast disease can be controlled effectively by spraying the fungicide, Bordeaux mixture at least 4 times before and after flowering of the crop. Bordeaux mixture formula is as follows:

|                 |             |
|-----------------|-------------|
| Copper sulphate | 9 Kgs.      |
| Quick lime      | 9 Kgs.      |
| Water           | 250 litres. |

The dusting of organomercuric compounds has been suggested for controlling blast.

## **Groundnut or peanut - *Arachis hypogea***

### **Tikka disease of groundnut**

*Pathogen* Disease incited by a fungus *Cercospora personata*.

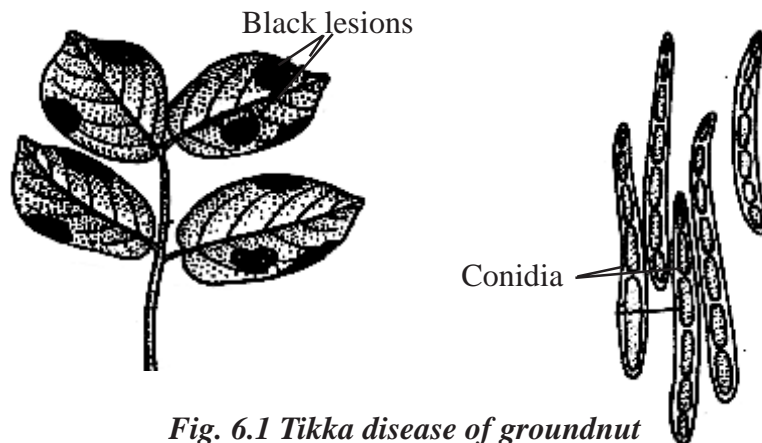
*Systematic position* The fungus belongs to class Deuteromycetes.

### ***Symptoms***

Lesions appear on the leaves, when the plants are atleast two months old. The symptoms appear in July and continue upto maturity of the plant. The lesions on the leaves are rounded and 1 to 6 mm in diameter. These spots are dark brown or black and found on both surfaces of the leaf. Yellow border develops around each such leaf spot.

### ***Pathogen***

The mycelium of *Cercospora personata* is brown, septate branched and slender. Branched haustoria are produced to absorb food materials from the host tissue. The conidia are long and septate. Each conidiophore produces single conidium at its tip. The spread of the disease takes place by means of conidia which are dispersed by wind.



**Fig. 6.1** Tikka disease of groundnut

### ***Control***

The disease can be controlled by sanitation and crop rotation. The use of phosphatic and potassic manures reduce the disease. Sulphur dusting is quite effective. Resistant variety should be sown.

### **Citrus canker**

#### ***Pathogen***

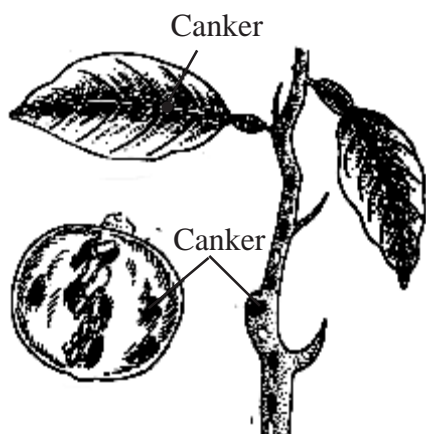
Disease due to a bacterium *Xanthomonas citri*. This bacterium is of bacillus and gram negative type. In India, this is the most commonly prevalent disease during the rains.

#### ***Symptoms***

The disease affects the leaves, twigs, thorns and fruits. All green parts and maturing fruits become more or less covered with brown scabby spots surrounded by dark – brown glossy margins. The lesions may enlarge to a diameter of 3 or 4 mm become raised and rough and turn brown. The bacteria enter through the stomata and wounds and multiply in the cortex to which they are confined.

### **Control**

The infection can be largely prevented by removing the infected branches and spraying the plants with Bordeaux mixture or spraying 3 to 4 times in a season with antibiotic the streptomycin at the rate of 1 gm in 45 liters of water.



*Fig. 6.2 Citrus canker*

Plant shows stunted growth and symptoms appear on the lower leaves. They turn yellow orange, bend downwards and possess dark brown spots.

### **Transmission of virus**

The leafhopper retains infectivity for a short period only and transmits the virus to another plant immediately after feeding on an infected plant.

### **Biopesticides**

Biological agents that are used for control of insects, weeds and pathogens produced from living organisms are called biopesticides. Micro-organisms such as viruses, bacteria, fungi, protozoa and mites may be used as biopesticides.

### **Biocontrol of insect pests**

1. The manufacture of methyl isocyanate (MIC) was started in 1980 in India to make Serin (carbaryl), a powerful pesticide that can kill more than 100 types of insects attacking 100 different crops.

2. Many of the chemical pesticides, which are used to control several crop pests also affects the beneficial organisms.

### **Tungro disease of rice**

*Pathogen* Disease incited by a virus Rice Tungro virus. The virus is transmitted by a leafhopper.

### **Symptoms**

The symptoms appear first on the emerging leaf. They are mild interveinal chlorosis (loss of chlorophyll), mild mottling and



3. They also bring about considerable damages to living organisms because of their hazardous effects in the environment. There was an *enmasse* killing of more than 4,000 people, many animals and plants, when methyl isocyanate (MIC) gas leaked out in the night of 2nd and 3rd December, 1984 from the underground reservoir of Union Carbide Factory at Bhopal. This is mentioned as Bhopal Tragedy. Many of the people exposed to this poisonous gas are suffering even today.

4. Majority of microorganisms such as viruses, bacteria, fungi, protozoa and mycoplasma are known to kill insect pests. The suitable preparations of such microorganisms for control of insects are called as 'microbial insecticides'. These are non-hazardous, non-phytotoxic and are selective in their action. They are eco-friendly not responsible for environmental degradation. The most frequently used bio-control agent is *Bacillus thuringiensis* and Pyrethrum extracted from the inflorescence of *Chrysanthemum* belonging to Asteraceae.

#### ***Bacterial pesticides***

*B. thuringiensis* is a widely distributed bacterium. It is a saprophytic bacterium and can be isolated from soils, litters and dead insects. It is a spore-forming bacterium and produces several toxins such as exotoxins and endotoxins in crystallized forms. The bacterium is harmful to lepidoptera insects. After infection of spore, larvae are damaged due to the secretion of a single large crystal in the cell. This crystal (toxin) is proteinaceous in nature.

### **6.3. Genetically modified food**

The greater concern in food biotechnology is the integration of both modern biological knowledge and techniques and current bioengineering principles in food processing and preservation. Modern biotechnological techniques will have considerable importance in influencing trends in the food market, namely cost, preservation, taste, consistency, colour and above all, health aspects.

Every year more than a million children die and another 3,50,000 go blind from the effects of vitamin A deficiency. Employing genetic engineering techniques, Potrykus of Switzerland and Peter Beyer of Germany transferred genes that make carotene in daffodils into *Oryza sativa*. Ordinary

techniques of plant breeding do not offer a way to enrich the crop. Extracting carotene genes from daffodils, Potrykus and Beyer had introduced these genes into the soil bacterium. *Agrobacterium tumefaciens*, the transgenic agrobacteria were then incubated with rice embryos in plant tissue culture medium. As the bacterium infects the rice cells, they also transfer the genes for making beta carotene.

A number of examples are available where transgenic plants suitable for food processing have been developed.

- (i) Tomatoes with elevated sucrose and reduced starch could also be produced using *sucrose phosphate synthase* gene.
- (ii) Starch content in potatoes could be increased by 20 to 40 per cent by using a bacterial *ADP glucose pyrophosphorylase* gene (*ADP GPPase*).
- (iii) Vaccines, antibodies and interferons can be consumed directly along with tomato, banana and cucumber.

#### **Edible vaccine**

Acute watery diarrhoea is caused by *Escherichia coli* and *Vibrio cholerae* that colonize the small intestine and produce **enterotoxin**. Attempts were made to produce transgenic potato tubers that they could still retain vaccines in their tubers, even after the tubers had become 5 per cent soft after boiling. 50 per cent of vaccine was still present in the tubers.

#### **Edible antibodies**

Transgenic plants are being looked upon as a source of antibodies. They can also provide passive immunization by direct application.

#### **Edible interferons**

Interferons are the substances made of proteins and are anti-viral in nature. Scientists have successfully produced transgenic tobacco and maize plants that secrete human interferons. Today, rice crops have been enriched with vitamin A through gene manipulation. Similarly, pulse crop have been tampered with to produce lysine-rich pulse seeds. Such genetically modified food (GMF) are now becoming components of human staple food.

It is hoped that one day genetically engineered plants will have one or more of these attributes:

- i. They will show tolerance against heat, cold, drought or salt.
- ii. They are more nutritious.
- iii. They can be stored and transported without fear of damage.
- iv. They require less fertilizer.
- v. They produce chemicals and drugs that are of interest to humans.

#### **6.4. Bio-war**

Nowadays, microbes are misused as biological weapons. For instance, a single gram of the most virulent strains of weaponized smallpox or anthrax could contain 250 million infectious doses. Under ideal dispersal conditions, about half the people of the entire world when exposed to these germs could become ill and one-third might die.

##### ***Deadly organisms***

Even from a very long period, pathogens causing some of the deadliest diseases in men are being used as biological weapons. More than 2,000 years ago, Scythian archers used their arrow heads which were dipped in rotting corpses in order to cause panic amongst people. The tips of arrowhead caused infections. During World war II, paper bags filled with plague infested fleas were employed as biological weapons to kill thousands of people. At that time, well equipped and expensive laboratories were established to mass produce biological weapons. At present, each and every nation is facing the threat from biological weapons. People affected by the biological war have to suffer throughout their life.

##### ***Genetically Modified Organisms (GMO) in biological warfare***

Using Molecular biology techniques, new combinations of genes were attempted to create genetically modified organisms (GMO). Some of the most lethal agents known to have been tested in biological warfare are anthrax, plague, smallpox and Ebola viruses with viral diseases.

People were aware of the reality that a small group of fanatical terrorists could easily contaminate the country's air, water and food with lethal pathogens or biological toxins.

## **Biological warfare**

Thus biological warfare introduces issues of pathogenicity, toxicity, routes of exposure, safety measures and the movement, distribution and persistence of dangerous biological materials in our environment. In biological warfare strategies, the genetically engineered microorganisms are made to spread into the enemy's territorial environment, with unpredictable and perhaps catastrophic consequences. The released dangerous microorganisms '**upset the balance of nature**'.

### **6.5. Bio-piracy**

Countries like America, Japan, United Kingdom, France and Germany are industrialised nations. These nations are advanced in technology with financial resources but compared with the Indian sub-continent are poor in biodiversity and traditional knowledge related to utilisation of flora and fauna that constitute the bioresources. The clandestine exploitation and utilisation of bioresources from a country by several organisations and multinational companies without proper authorisation is known as **Biopiracy**. Although the developing nations are not so financially sound, they are however rich in traditional knowledge and biodiversity.

For a very long period, the tribal people in the remote areas of jungles as also the people of rural areas have been using certain important herbal plants for treating certain diseases. Since, the habitations of the tribal people are surrounded by a variety of plants and animals, they have acquired a sound knowledge of their uses particularly of their medicinal values. This knowledge can be exploited to develop commercially important drugs from the plants. Traditional knowledge has greater utility value as it saves time, effort and expenditure for their commercialisation. Multinational companies of the rich nations are collecting and exploiting the bioresources without any authorization in the following ways:

1. Plants like *Catharanthus roseus* (*Vinca rosea*) are exported to countries as medicinal plants since they possess anticancerous properties. The companies of the rich nations are interested in the biomolecules present in the plant. These compounds produced by living organisms are patented and used for commercial activities. As a result of this, the farmers who cultivate the crop are being deprived of their rightful claims and compensations.

2. The genetic resources of the developing nations are over exploited by the rich nations. For instance, Basmati rice is a crop grown indigenously in India from a very long time. In U.S.A the Government had granted a patent to cover the entire 'basmati' rice plant so that other countries or institutions cannot undertake any other research programmes pertaining to Basmati plant. In U.S.A, such patents are given for 17 long years.

3. *Pentadiplandra brazzeana*, a native plant of West Africa, produces a protein called brazzein. It is several 100 times as sweet as sugar. Local people use it as a low-calorie sweetener. This development could have serious implications for sugar exporting countries.

Richer nations are over exploiting the commercial resources of the developing countries without adequate compensation. With advances in scientific equipments, instruments and techniques, the biodiversity of the poor and developing nations of the tropics are overused and exploited by the rich nations. There is a growing awareness of this over exploitation and hence the developing countries are enacting legislative laws to prevent this over exploitation by the rich nations.

#### **6.6. Bio-patent**

The emergence of modern biotechnology has brought forth many legal characterizations and treatment of trade related biotechnological processes and produces, popularly described as Intellectual Property. **Intellectual Property Protection (IPP)** and **Intellectual Property Rights (IPR)** are the two unique facets of any Bio-patency. Intellectual property includes 'patents', 'trade secrets', 'copy rights' and 'trade marks' obtained for processes and products created through one's own knowledge and research. The right to protect this property prohibits others from making copying using or selling these processes and products. In this era of biotechnology, one of the most important examples of intellectual property is the creation of organisms containing new recombinant DNA. Another example of Intellectual property is the new crop varieties, which are protected through '**Plant Breeder's Rights**' or **PBR's**. The plant breeder who developed this new variety enjoys the exclusive right for marketing the variety.

Patenting of important crops and animal breeds may bring down a shortfall in genetic resources. One of the major negative aspects of bio-

patency is that it may lead to scarcity of genetic resources. In addition, majority of the people may not have access to certain rare genetic resources protected by Bio-patency laws.

People argue that giving patent rights to transgenic plants and transgenic animals is a wrongful idea as these patents will work as impediments in free exchange of genetic materials for improvement of crops and livestock.

Intellectual Property Rights may also adversely affect the following:

Food security, use of evolved agricultural practices, biological diversity and ecological balance and livelihood of the poor in developing countries.

### ***Patents***

The Indian Patent Act of 1970 allows process patents, but no product patents for foods, chemicals drugs and pharmaceuticals. Duration of patent in India is 5 years. Under USA law, a patent means grant of “right to exclude others from making, using or selling” an invention for a 17 year period. To day, many favour the patenting of inventions arising from basic research. Patents are granted as per the law of the State and are also disputed in the court of Law whenever complaints of infringement of the patents are violated by the people. In 1980, the discovery of an oil eating bacterium (*Pseudomonas*) by a non-resident Indian Scientist (Dr. Chakrabarty) was patented in USA by a multinational Corporation. Similarly, an ‘oncomouse’ was also patented. All this means that life forms could be patented.

### **6.7. Sustained agriculture**

Increased food production in India was made possible by the employment of modern technology in agriculture. The increase in the productivity is mainly due to rapid rise in overall area under cultivation of cereals. To maintain the crops and productivity, we have to expand irrigation facilities and use large amounts of fertilizers and pesticides. This overexploitation had resulted in the degradation of soils and their erosion. Due to degeneration in soil fertility, the traditional varieties of crop plants as cultivated in earlier periods got disappeared or are on the brink of extinction. Our agriculture is slowly being converted into an unsustainable system in the years to come, as the cost of chemicals and fertilizers, labour, cost of seeds are going to make the agricultural products costlier.

This will affect millions of uneducated farmers. Hence, to remedy this situation, we will have to find alternative permanent arrangements in sustainable agriculture.

To protect the interest of the farmers on their agricultural lands and capital investments, sustainable agriculture which is the best source of alternative method should be compulsorily taken up and practiced by the traditional farmers. Sustainable agriculture can be carried on without any threat to our soils, environment, plants and animal communities. Excessive drainage of our energy and material resources can be considerably saved and protected when sustainable agriculture is intensively taken up by the farmers and practiced. This can be achieved by

1. Maintaining a healthy soil community which can automatically regenerate soil fertility by providing organic manures, increasing fallow periods, avoiding excessive use of chemical fertilizers and pesticides.
2. Infusing bio-diversity in agriculture by sowing mixed crops, crop rotation etc.
3. The use of alternative food sources which may reduce overdependence to certain crops.

Men are exploiting only few species of crop plants as food and cultivate only about 15 species of plants as food crops to feed 90 per cent of the world's population. There are thousands of species of plants with useful and edible parts which can serve as a food source for the mankind. This will widen our resource base on food crops and add sustainability to supplies by reducing the dependence on a few species. eg. Winged bean which has high protein and oil. Leaves of *Ilex paraguriensis*, which can be a substitute for tea and powdered seeds of *Cola nitida* instead of coffee.

Farmers should practice 'organic farming' so that it will not disturb the ecosystem of the cultivable area and leads to sustainable yields at low costs, both to the farmer and to nature. Chemicals, minerals, pesticides and insecticides are now categorised under non-renewable resource materials. Therefore, in the long-term strategy, these materials will make farming non-sustainable and non-productive. Shifting to original and excessive use of organic manure, rotation of leguminous or nitrogen fixing crops, use of VAM fungi, transgenic crop and application of biofertilizer are being encouraged and practiced.



Sustainable agriculture includes scientific methods of farming that utilise renewable resources, increase in yield, avoidance of manmade complex substances known as Xenobiotics which are used as insecticides and pesticides that cause pollution to soil and environment. Plant tissue culture and biotechnology also play a major role in this. 50 varieties of rice and 20 varieties in wheat have been developed in China by using these new techniques without damaging the environment. New disease resistant virus free plants and stress resistant plants, are successfully produced. Similarly, transfer of *nif* (nitrogen fixing) gene to non-leguminous crops will improve higher yield. Biotechnology and tissue culture contributed more to sustainable agriculture by providing biofertilizer, biopesticides, disease and insect resistant varieties through creation of transgenic crops, single cell protein, production of valuable pharmaceutical products and herbal drugs (*Ginseng Vinca*, Emetine from *Cephalis*) by using micropropagation technique.

To conclude Sustainable agriculture is an eco-friendly farming system associated with production of food while maintaining on biophysical resources including soil, water, biota with no adverse impacts on the environment. So it should

1. maintain or improve the production of clean food.
2. maintain or improve the quality of landscape which includes soil, water, biota and aesthetics
3. have minimal impact on the environment.
4. be economically viable and
5. be acceptable to society.

Sustainable farming uses ecofriendly fertilizers, and pesticides and modern technologies, such as improved seed, modern equipments for low-tillage practices, pest control using biological control principles and weed control that depends on crop rotations. Sustainable farms try to use wind or solar energy instead of purchased energy and use organic manure and nitrogen fixing legumes as green manures to maintain soil fertility thereby reducing supply from outside farms. The emphasis is on maintaining the environment without causing any pollution.

Organic farming is defined as production systems which avoids the use of synthetic fertilizers, pesticides, growth regulators and livestock feed



additives. It depends upon crop rotation, crop residues, animal manures, legumes, green manures, off-farm organic wastes using mechanical cultivation, biological pest control (biopesticides) to maintain soil productivity and to supply plant nutrients and to control insects, weeds and pests.

### Self evaluation

#### ***I. Choose and write the correct options.***

1. Which pathogen causes the blast disease of rice?  
a. *Cercospora personata*    b. *Pyricularia oryzae*  
c. *Xanthomonas citri*        d. *Tungro virus*
2. What is the collateral host plant of *Pyricularia oryzae*?  
a. *Oryza sativa*                b. *Digitaria marginata*  
c. *Arachis hypogea*         d. *Citrus plant*
3. Which pathogen causes Tikka disease of groundnut?  
a. *Cercospora personata*    b. *Pyricularia oryzae*  
c. *Xanthomonas citri*        d. *Tungro virus*

#### ***II. Answer the following questions in two or three sentences.***

4. What are mutagens?
5. What is genetic engineering?
6. Define biofertilizer.
7. What is bioinsecticide?

#### ***III. Answer the following questions in about 100 words.***

8. Explain somatic hybridization.
9. What is disease resistance and disease resistant varieties?
10. Add a note on Plant introduction.
11. Explain polyploid breeding.
12. Give an account of Mycorrhiza.
13. Write the aims of plant breeding.
14. How is genetic engineering employed as a tool in modern crop improvements?
15. How are crops improved through selection, polyploid breeding and mutation breeding?
16. Write detailed account on biofertilizers.
17. 'Sustainable agriculture is an eco-friendly farming system' - Discuss.

## 6.8. Medicinal plants including microbes

India is endowed with a rich wealth of medicinal plants. From earliest times mankind has used hundreds of medicinal plants in an attempt to cure diseases and relieve physical sufferings. They derived this knowledge as a result of trial and error. Medicinal properties of plants have been mentioned even in the oldest “*Rig Veda*”. Medicinal plants are becoming popular throughout the developed world, as people want to treat illness.

It is estimated that around 70,000 plant species, from lichens to tall trees, have been used as medicinal plants. 500 plants have been studied in detail. According to WHO about 25 per cent of prescribed human medicines are derived from plants. India accounts for nearly 1,100 species used in different systems of medicines like Ayurveda, Siddha, Unani, etc. Out of these, 600 to 700 species are used much in the country. But 95 per cent of medicinal plants are obtained from wild sources and they are not cultivated now.

Now, efforts are being made to introduce many of these useful plants to farmers. Agronomic practices have been developed for growing poppy, isobgol, cincona, belladonna, ergot, etc. Medicinal plants have curative properties due to presence of various complex chemical substances in different composition like alkaloids, glycosides, corticosteroids, essential oils, etc. Nowadays, these medicinally valuable compounds obtained from the medicinal plants are called “**biomedicines**”.

*Some of the important medicinal plants and their products are*

- **Morphine**, the strongest pain killer obtained from Opium poppy - *Papaver somniferum*.
- **Quinine**, antimalarial drug which controls malarial fever is derived from *Cinchona calisaya* and *C. officinalis*.
- **Digoxin**, used to treat heart diseases is obtained from the plant *Digitalis*.
- **Ephedrine**, used to treat cough is extracted from the plant *Ephedra sinica*.
- Mental and physical stress relaxing drug is obtained from the plant **ginseng** – *Panax ginseng*.

## COMMONLY AVAILABLE MEDICINAL PLANTS

### 1. *Acalypha indica*

It belongs to Euphorbiaceae. The vernacular name of *A. indica* in tamil is kuppaimeni, poonamayakki and its trade name is Indian Acalypha. It is a common herb growing upto 75 cm tall with ovate leaves. Flowers are green, unisexual found in catkin inflorescence.

The paste obtained from the leaves of this plant is applied to burns. The juice extracted from the leaves, mixed with lime and applied on skin to cure diseases caused by ringworms. Fresh juice of leaves mixed with oil and salt is used for Rheumatoid arthritis and to cure scabies. Powdered leaves are used to cure bedsores and infected wounds. The active medicinal compounds like Acalyphine and Triacetoneamine are extracted from this plant. They contain cyanogenic glucoside and alkaloids.

### 2. *Aegle marmelos*

It belongs to Rutaceae. The vernacular name of *A. marmelos* in tamil, is vilvam. It's trade name is baer fruit. It is an aromatic tree growing 6 to 7.5 metres tall with long branches. Bark is grey with peeling type. Leaves are trifoliate or pentafoliate. Leaflets are ovate. Flowers are sweet scented with greenish white in colour and are borne on axillary panicles. Marmelosin, coumarin and triterpenoids are responsible for medicinal activity.

The unripe fruit is used to treat problems of stomach indigestion. It kills intestinal parasites. It is used also to cure chronic diarrhoea and dysentery. It is used as a tonic for the betterment of heart and brain.

### 3. *Cissus quadrangularis*

It belongs to Vitaceae. The vernacular name of *C. quadrangularis* in tamil is as pirandai and its trade name is 'Hadjor' – bone joiner. It is a common shrub with tendrils. Its stem is angular, winged and contracted at nodes. Leaves are simple, ovate or kidney shaped and thick leathery. Coiled tendrils are found opposite to the leaves. Steroids like prescene and tetracyclic triterpenoids are the active chemicals present in this plant.

The paste obtained from the powdered stem and root of this plant is used in bone fractures. Whole plant is useful to treat asthma and stomach

troubles. Stem is useful in the treatment of piles and its juice is used to treat bleeding of nose.

#### 4. *Mimosa pudica*

It belongs to Mimosaceae. The vernacular name of *M. pudica* in tamil is 'Thottal chinungi or Thottal surungi'. Its common english name is Touch-Me-Not plant. It is a small herb with prickles which are erect or curved. Leaflets are arranged in two rows containing 15 to 20 pairs. Leaves are sensitive to touch. Flowers are pink and found in axillary heads.

A decoction of the root obtained from this plant is used to relieve asthma and diarrhoea. This plant is also useful for curing piles, minor skin wounds and whooping cough. Mimosine, an alkaloid is extracted from this plant.

#### 5. *Solanum nigrum*

It belongs to Solanaceae. The vernacular name of *S. nigrum* in tamil is manithakkali or manathakkali. Its trade name is black night shade. It is an annual, erect, much branched and unarmed herb growing upto one metre tall. Leaves are ovate without hairs. Flowers white borne on extra axillary cymes. Fruits are globose and black coloured berry.

The extract of this herb is effective in the treatment of liver disorders like cirrhosis of liver. This plant also cures fever, dysentery and promotes urination. Active medicinal compounds like solanin and saponin are extracted from this plant.

#### *Microbes in medicine*

Microbes like bacteria and fungi produce antibiotics. The substance produced by a living organism, which inhibits the growth and metabolic activities of pathogenic organisms (mostly bacteria) without affecting the metabolism of host is called an antibiotic. Penicillin, streptomycin, aureomycin and chloromycetin are some of the examples for antibiotics.

**Penicillin** is a well known antibiotic obtained from the blue green mold called *Penicillium notatum*. When it is grown in culture medium, the mycelium excretes an antibiotic substance called penicillin. The crude penicillin is recovered, purified and dehydrated. It is effective against gram-positive bacteria like *Pneumonia* bacteria. **Streptomycin** is obtained from the filamentous bacterium, *Streptomyces griseus*, an actinomycetes. It cures

urinary infections, tuberculosis, meningitis and pneumonia. **Aureomycin** is obtained from actinomycetes, *Streptomyces aureofaciens*. It is used as a medicine in the osteomyelitis, whooping cough and eye infections. **Chloromycetin** is obtained from the actinomycete, *Streptomyces venezuelae*. It kills bacillus form of bacteria and cures typhoid fever. *Aspergillus fumigatus* produces antibiotic which is used against typhoid and dysentery. Other group of microorganism like bacteria is also known to produce many antibiotics. *Bacillus subtilis* produces 60 different antibiotics. Bacitracin is an antibiotic obtained from *Bacillus licheniformis* and it is used to treat syphilis. It is useful in the control of sugar for persons suffering from diabetes. Through genetic manipulation, and introduction of human gene for insulin production, the bacterium *E. coli* is articulated to produce human insulin called “humulin”.

#### **6.9. Economic importance**

Many plants are economically important and useful to mankind in several ways. Based on their utility, they are broadly classified as food plants, fibre plants, oil plants and timber plants. Now, we will discuss some of the economically important plants for each category.

##### ***Food plant – Rice***

Its binomial is *Oryza sativa*. It belongs to Poaceae. It is the most important cereal of tropical climate. This plant is an annual grass. The inflorescence is panicle containing a number of branches, each terminating in a single grain. IR – 8, ponni, kannagi, kavary, ganga, etc. are some of the recent varieties cultivated in India.

Rice is the chief source of carbohydrates. Polished rice is less nutritive. Straw is used as livestock feed. In Japan, alcoholic beverages are also distilled from the grains of rice. Recently, from the husk of paddy, a cooking (rice bran oil) oil is extracted. Now, bio-diesel is obtained from rice bran oil.

Rice is the major food of half of the world’s population. Particularly in the eastern hemisphere it is the staple food. Rice cultivation is the only source of income for majority of people in our country. The uses of rice are many.

### ***Economic importance***

- Parched rice (pori) is crisp to eat. It is sold either salted or unsalted.
- The flattened parboiled rice is known as flaked rice. Like corn flakes, it is a very good break fast food. Flaked rice is also used for preparing different kinds of food items.
- Sake is an important alcoholic beverage in Japan. Sake is prepared by the fermentation of rice.
- Bran is an important by-product of rice milling industry. It is used as a cattle feed.
- Bran oil is extracted either by expression in a hydraulic press or extra-ction with solvents. Bran oil is used as edible oil and for preparation of vanaspathi, making soaps. It is also used in the textile industry, leather industry.
- Bran wax is a by-product in bran-oil extraction. It is used in chocolate industry and in the manufacture of lip-sticks.
- Paddy husk is used as fuel, in brick kilns. It is also used in brick making.
- Straw is used as cattle feed, in the manufacture of straw-boards and for making hats, ropes, mats, etc.

### ***Oil plant – Groundnut***

Its binomial is *Arachis hypogea*. It belongs to Fabaceae. It is an annual. The word groundnut derives its name from the fact that its fruits ripe beneath the ground.

The roasted seeds are edible. Oil is extracted from the seeds and used as fine cooking medium. Vegetable ghee (peanut butter) is also prepared from this oil. The oil cake is fed to the livestock. It is rich in fatty acids and proteins.

### ***Economic importance***

- Groundnut oil is one of the important edible oils. It is extensively used in cookery as a salad oil. It is used for the manufacture of vanaspathi.
- Groundnut kernel is rich and cheap source of vegetable protein. Kernels are eaten, fried and salted and added to a number of dishes.
- Peanut butter is prepared by grinding roasted and blanched kernels. It is nutritious.

- Groundnut oil is used to a limited extent in soap making.
- Oil is used as illuminant, lubricant.
- Oil cake is used as animal feed and organic manure.
- Groundnut shell is used in the manufacture of activated carbon.
- The groundnut cake is a good cattle feed. The plant after removing the pod, both dried and fresh is a good cattle feed.

#### ***Fibre plant - Cotton***

Many members of Malvaceae yield fibres. *Gossypium barbadense* (Egyptian cotton) and *G. hirsutum* are some examples for fibre plants. The seed coat of cotton seeds produce fibres on their external surface. So, it is called as surface fibre.

Almost the entire textile industry depends on this fibre. Cotton is used in stuffing the pillows and cushions. It is also used in making rubber tyres, carpets, blankets and cordages are made from cotton.

#### ***Economic importance***

- It is a cash crop.
- It gives three important products: fibre, food and cattle feed.
- Lint fibre is for clothing which is very much useful in the textile industries.
- Seed is used for extracting oil. This is also used as vanaspathi.
- Cotton flour prepared from the seed is used for bread and biscuit making.
- Cotton seed cake is used as a good organic manure.
- Fatty acids obtained from oil is used in the preparation of insecticide, fungicides and plastics, etc.

#### ***Timber yielding plant - Teak***

Its binomial is *Tectona grandis*. It belongs to Verbenaceae. It is large deciduous tree and shows resistance to termites. Sap wood is white and heart wood is green emitting fragrance. The timber retains its fragrance for a long time. It is hard, durable and strong and also takes up good polishing.

In India, it is used for making furnitures, buildings, cardboards, railway sleepers, etc. Ships and bridges are also made from this timber.

### ***Economic importance***

- Teak wood is durable and it is an important timber in the tropics. As the seasoned teak, timber does not shrink, crack or alter its shape, it is extensively used in making household furnitures.
- It is also used in ship building, boats, etc.
- It is used for interior decoration.
- It is used for the manufacture of boards.

### **Self evaluation**

#### ***I. Choose and write the correct options.***

1. Acalyphine is extracted from
  - a. *Acalypha indica*
  - b. *Aegle marmelos*
  - c. *Cissus quadrangularis*
  - d. *Mimosa pudica*
2. Binomial of 'vilvum' is
  - a. *Acalypha indica*
  - b. *Aegle marmelos*
  - c. *Cissus quadrangularis*
  - d. *Mimosa pudica*

#### ***II. Answer the following questions in two or three sentences.***

3. Define biomedicine.
4. Write the medicinal value of *Aegle marmelos*.
5. Write the medicinal uses of *Solanum nigrum*.
6. What is humulin?

#### ***III. Answer the following questions in about 100 words.***

7. Write short notes on microbes in medicine.
8. Bring out the economic importance of teak.
9. Write a brief account on groundnut.
10. Write the economic importance of rice.

### ***Reference***

1. Diseases of crop plants of India by G. Rangaswami, Practice Hall of India, 1966.
2. A Textbook of economic botany by Sambamoorthy and Subramaniam, 1989.
3. Economic botany - Plants in the world by Sompson, Conner and Ogorzaly, 1986.