



Adding an Electronic Self Destruct Mode to the M230 Fuze



Shala M. Strickland
US Army TACOM-ARDEC
CCAC - Fuze Division
Advanced Concepts Fuze Team
Picatinny Arsenal, NJ

47th Annual Fuze Conference
April 8-10, 2003

Contributors:
Olivier Nguyen – Electronic Design
Jintae Kim – Mechanical Design



Briefing Outline



- Program Objective
- Background on existing M230 Ground Impact Fuze and M261 Hydra Rocket
- Design of M230 Fuze with electronic self-destruct
- Future plans



Project Objective



- As part of the D862 Fuze Technology Integration program to upgrade existing fuze designs, the Fuze Division initiated an in-house design effort to incorporate an electronic self-destruct mode into the M230 rocket submunition fuze.
- Program Goals
 - Improved reliability of training ammo - Reduced Duds
 - Existing fuze reliability 95% (5% dud rate)
 - Goal of SD fuze - meet OSD policy of <1% unexploded ordinance on the battlefield



M261 HE MPSM Warhead



- Part of the Hydra 2.75 rocket system
 - Fired by Apache and Cobra Helicopters
- Effective against Light Armor, Materiel, and Personnel.
- Main Fuze - M439 Remote Set Time Fuze
- Contains 9 M73 submunitions
- Each submunition fuzed by a M230 fuze





Basic M230 Fuze Operation

- The M230 fuze combines a Ram Air Decelerator (RAD) and a bore rider/slider combination

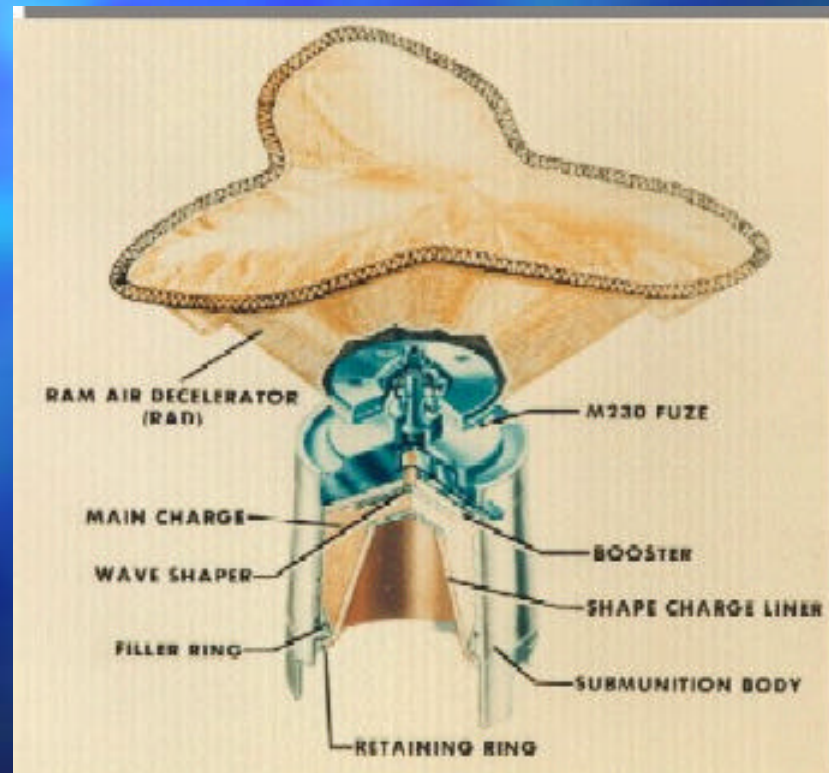



Basic M230 fuze Sequence of Operation



- Upon expulsion from the warhead the bore rider safety is removed.
- The air stream forces deployment of the RAD, breaking the shear wire and retracting the arming pin. Retraction of the arming pin unlocks the slider.
- The arming spring pushes the slider to the armed position with the escapement providing safe separation.
- When the slider is in the fully armed position the trigger is unlocked.
- Upon impact the trigger releases the detent ball. The firing pin is now free to move.
- The spring force of the firing pin causes the firing pin to impinge upon the M55 detonator initiating the explosive train.

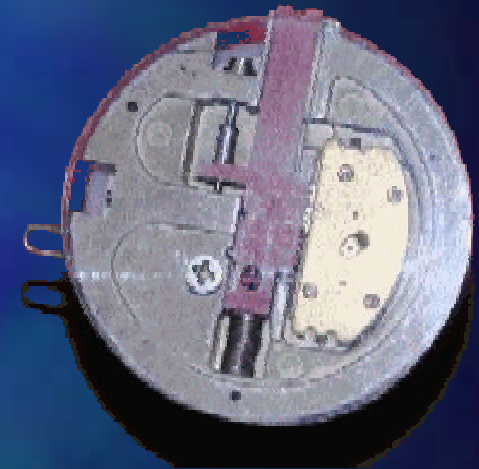



M230 fuze with self-destruct

- Two independent functioning modes
 - **Primary mode** – Operates in the same manner as the existing M230 fuze - same safe and arm mechanism and impact mode switch. The fuze arms after expulsion and the M55 detonator initiates the explosive train & grenade at impact.
If the primary mode fails, then
 - **Secondary SD mode** - Operates independent from arming. The electronic circuit & power source fire an electric detonator at a fixed time after expulsion. The electric detonator output initiates the primary mode's M55 detonator. If the fuze is armed the warhead functions (*self destruct*) – if the fuze is not armed the sensitive detonators are eliminated (*self neutralization*).



M230 SD Sequence of Operation

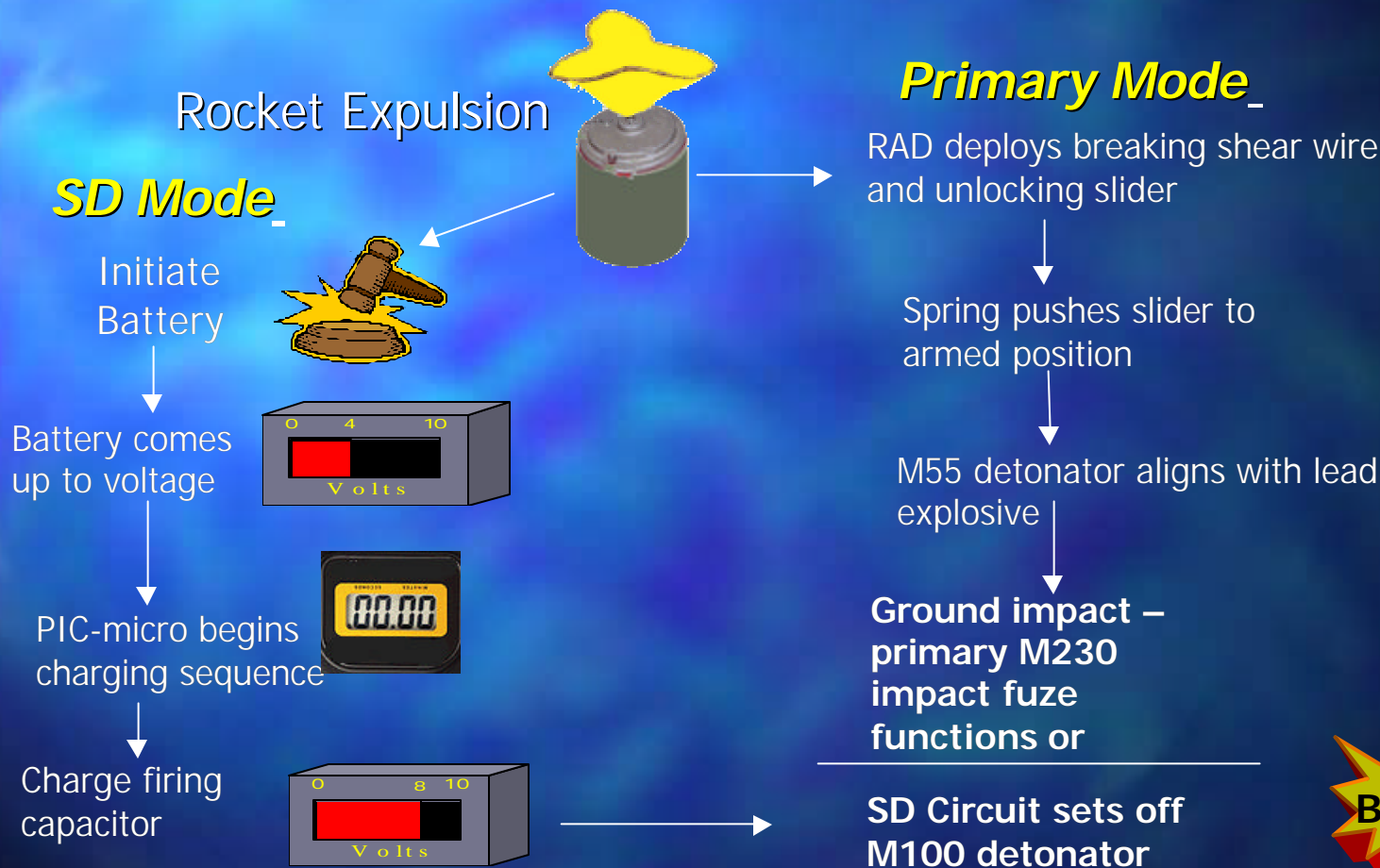

IF SD and primary modes fail, timer turns off and bleed down circuit discharges electrical power



Concept for M230 Fuze with Electronic Self-Destruct Feature



Battery &
Activation
Mechanism

*Incorporates a
reserve battery,
timer circuit, and
M100 detonator into
basic M230 fuze*

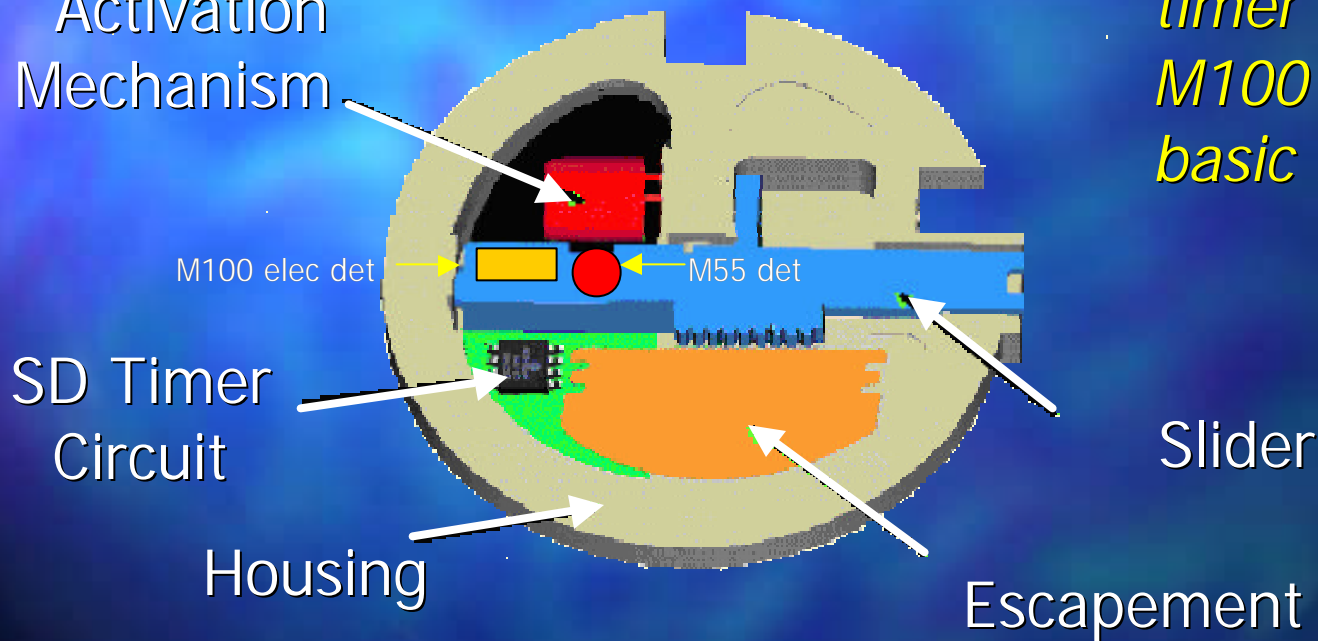

Adds a totally independent self destruct mode



Modifications to the M230 Fuze to Incorporate the Self-Destruct Mode



- Modified the housing to move the gear train and make volume for electronics
- Modified the slider to add an M100 detonator for SD functioning and relocated the gear teeth
- No changes to the impact switch, RAD, firing pin, or the fuze booster plate
- Minor modifications to the bottom plate of the gear train assembly



Housing with slider and gear train



M230 Fuze

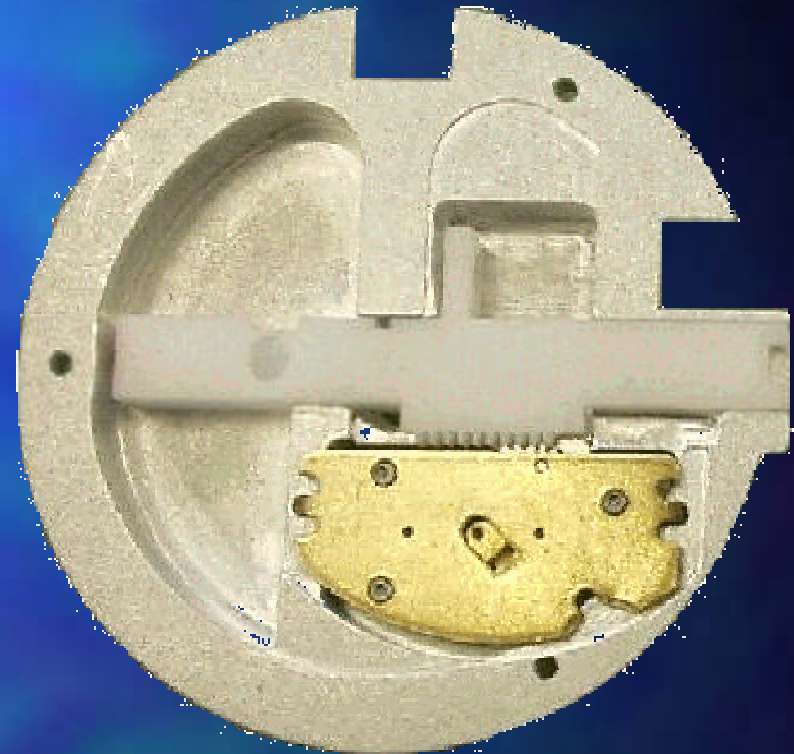

M230 Fuze w/ SD



Relocation of Gear Teeth

M230 fuze

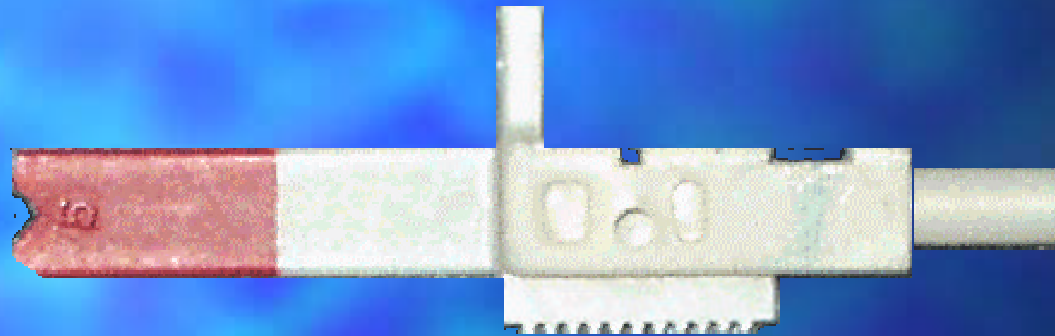

M230 SD fuze





Location of SD electronics

Cavity for reserve battery and activation mechanism

Impact switch parts not shown

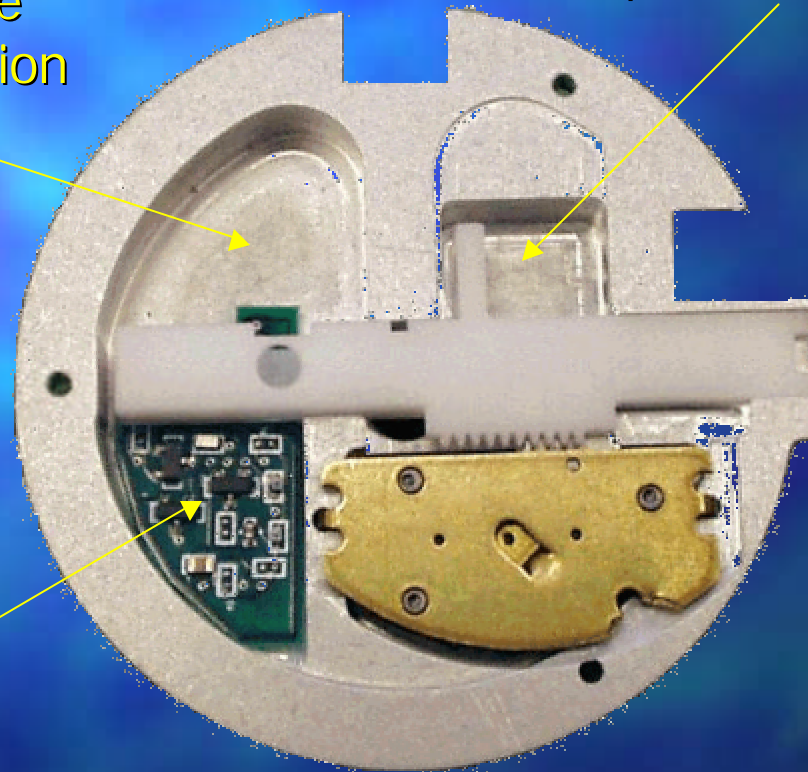

Self-destruct circuitry

M230 Fuze w/ SD Circuitry



Electronic Design



- Utilizes PIC micro-controller to perform timing functions, and operate 2x charge pump
 - Low power consumption
 - On board nonvolatile memory
 - Small size - 8 pin SOIC package
 - On board flash memory can be used to "tag" ckt & prevent multiple power ups from operating the circuit in dud fuzes
- Battery bleed circuit in case M100 detonator fails to function

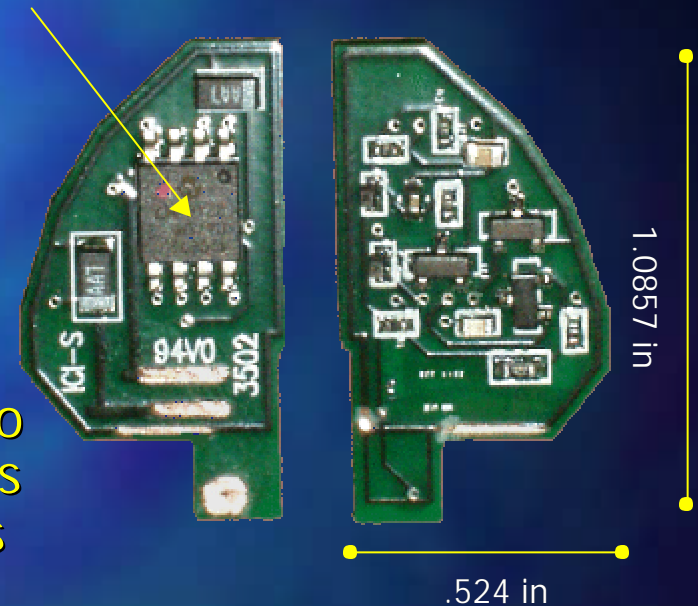



Electronic Circuit Schematic

PIC-micro

Bleed down

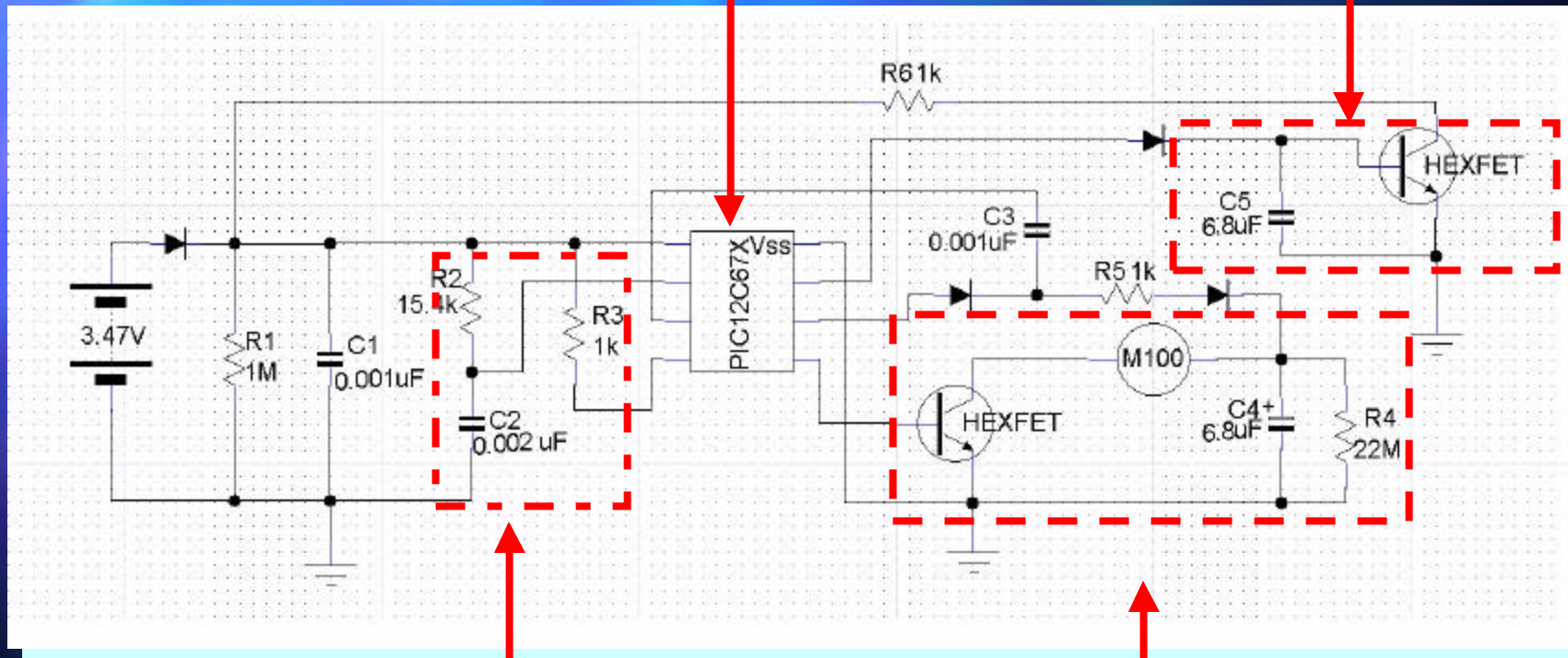

RC Oscillator

Frequency = 30KHz

Firing Circuit



Software Flowchart

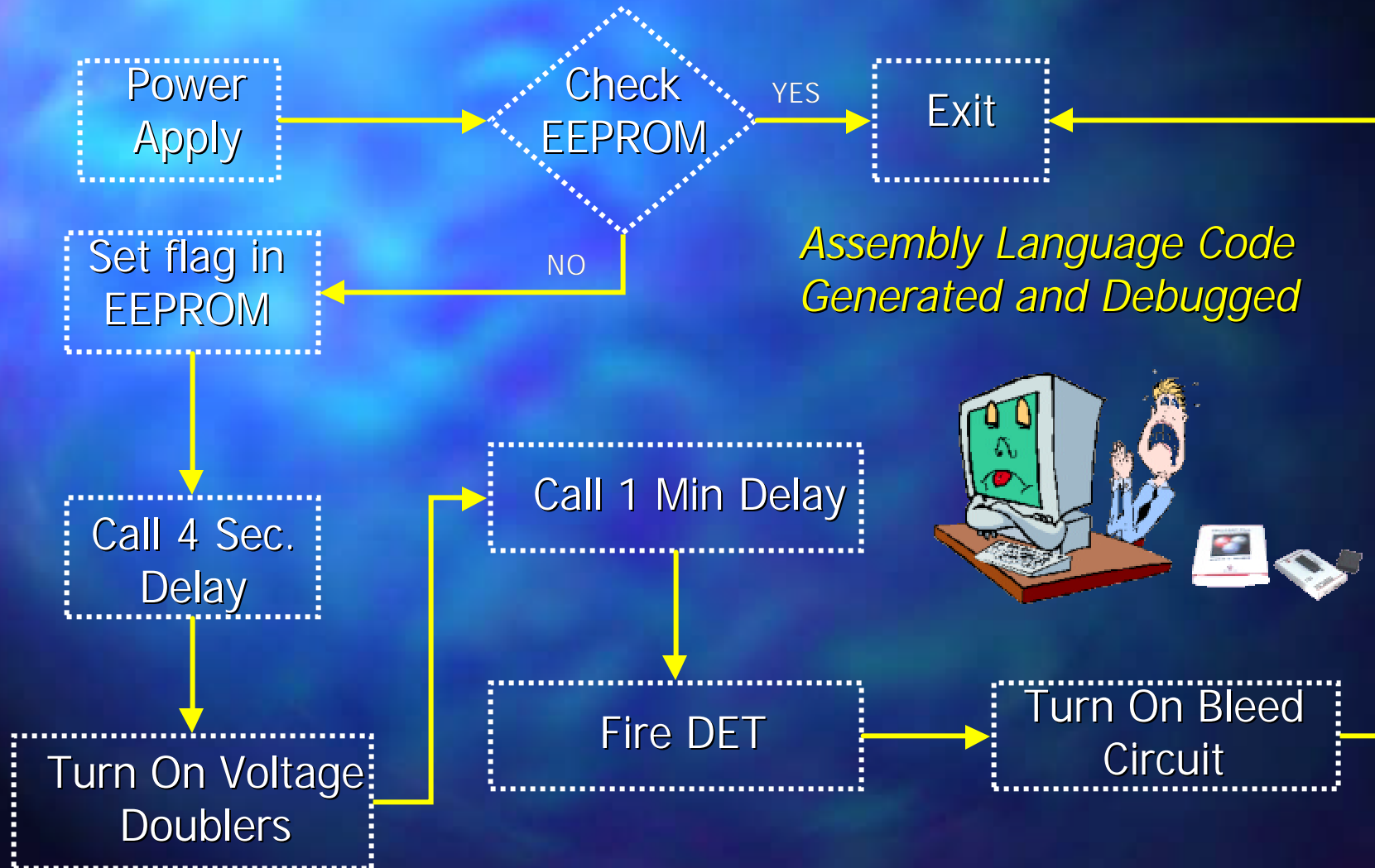



Power Source Options



- Reserve battery to activate on expulsion
- Key Requirements:
 - Electrical: 3-5 volts @ 150 mA Typical
 - Active life Less than 2 minutes required
 - Storage life : 10 years min
- Candidates examined
 - Reserve battery in M234 fuze
 - Miniature size, performed well in lab tests with the circuit production line being setup
 - Prototype OICW battery supplied by ATK
 - Larger size may enhance producibility
 - Can fit into M230 design but smaller size desirable
 - Lab Tests planned





Lab Tests – Circuit Output

$V_{max} = 7.469 \text{ V}$

Produces
3700
Ergs

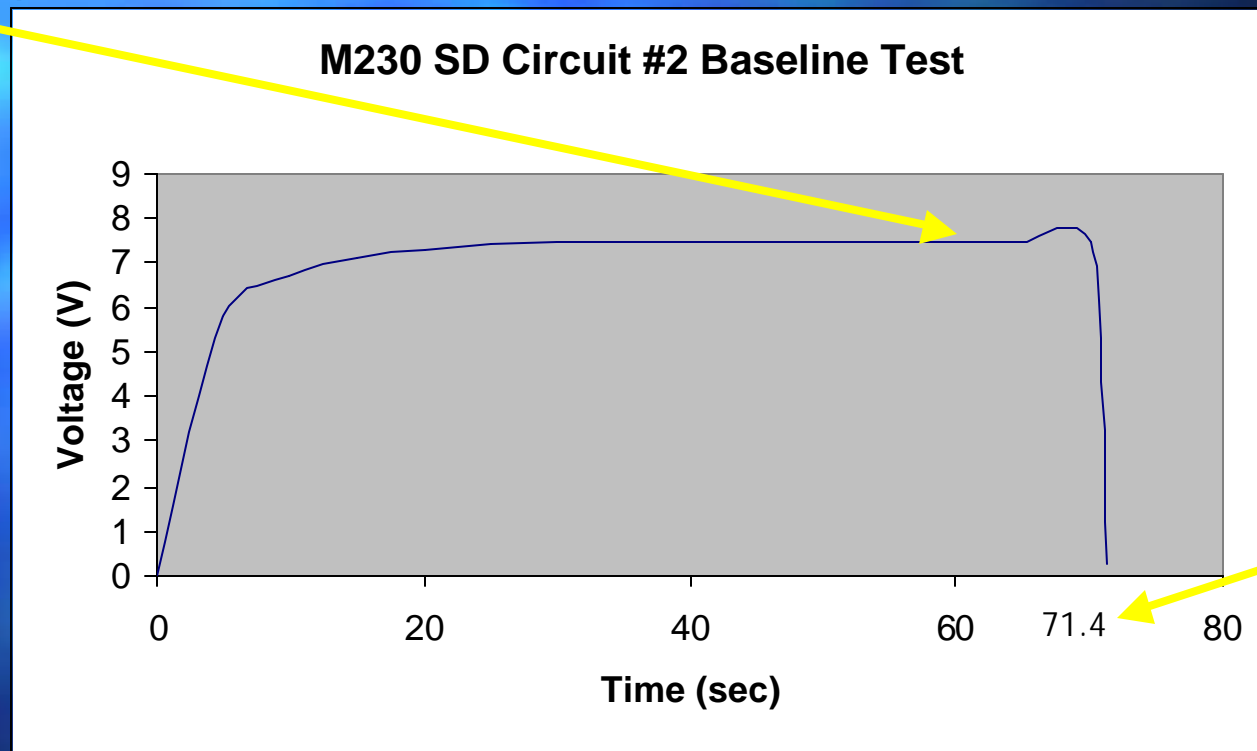

Draws
less than
 $100\mu\text{A}$
Time to
detonation

Typical Charging Chart of
Circuit Output



M100 Firing Voltage Test



Used the Langlie Method to test 35 M100
detonators to determine "All-fire" and "No-fire" Voltages

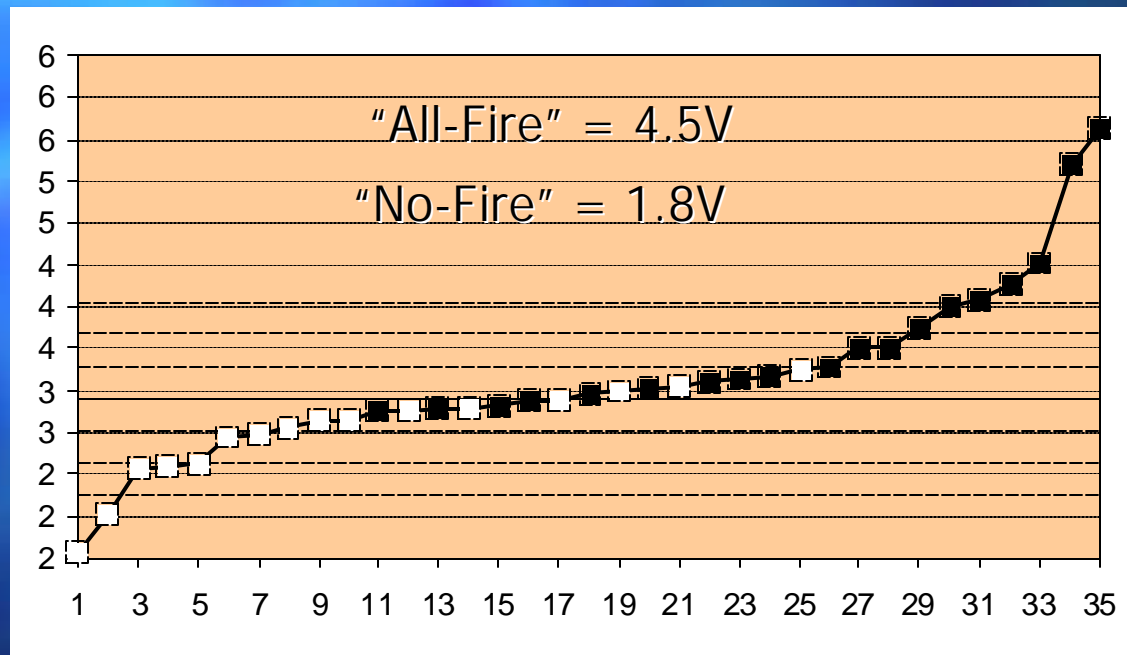

*SD Circuit produces > 6 volts and exceeds detonator
all-fire voltage by a large margin!*



Lab Tests with M234 Battery

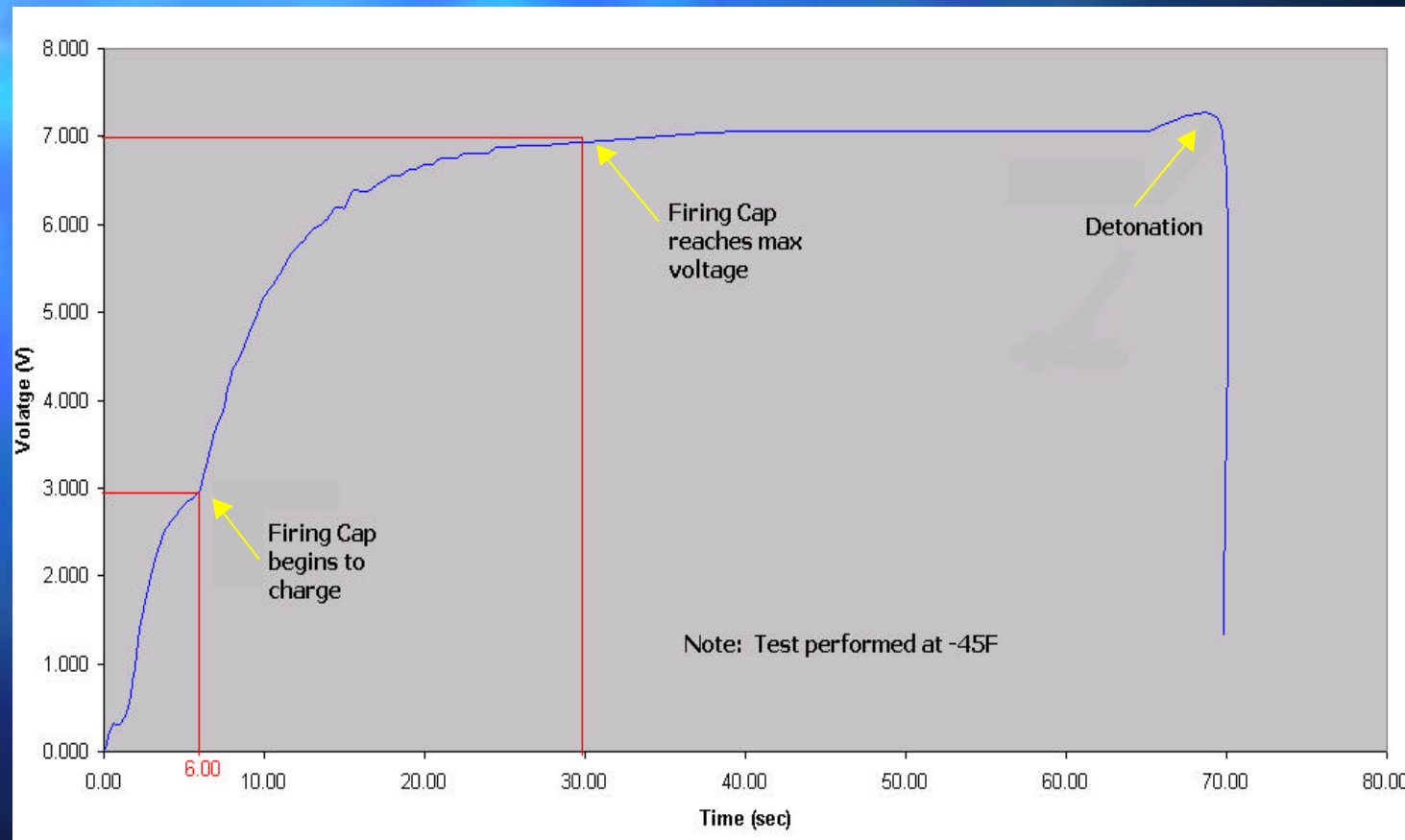

Charging Curve of SD circuit with M234 reserve battery



Future Plans



- Complete design
- Fabricate prototypes
- Perform rocket tests with prototypes