

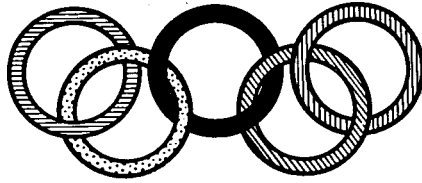

III Olympic
Winter Games

Lake Placid 1932



Citius Altius Fortius

OFFICIAL REPORT

III Olympic Winter Games

LAKE PLACID 1932

Issued by

III Olympic Winter Games Committee

LAKE PLACID, N Y, U S A

Compiled by

GEORGE M LATTIMER

Copyright 1932

III Olympic Winter Games Committee

PRINTED IN U S A

Contents

	PAGE
Foreword	7
Official congratulations.	8, 9
List of officers and committees.	11-16
Olympic regulations and protocol and general rules.	23-34
Brief history of Olympic Winter Games.	35, 36
History of winter sports at Lake Placid.	37-42
How III Olympic Winter Games were awarded to Lake Placid.	43-52
Organization following award of Games to Lake Placid.	53-72
General organization.	73-78
Finance.	79-92
Publicity	93-108
Local Arrangements	
Housing.	103-115
Transportation.	115
Health and safety.	115, 116
Special sections	
Office lay-out	117
Entry forms	117-122
Tickets.	122-123
Attendance.	123, 125
Diplomas, medals, and badges.	126, 127
International secretary.	128
Souvenir book.	129
Concessions	130
Ushers and information.	130
Feeding.	131
Music.	131
Decorations.	131, 132
Medical attention.	132
Social affairs.	132, 137-139
Olympic facilities	
Summary of seating capacities.	141

	PAGE
Intervales ski-hill.....	141-144
Ski trails.....	145, 146
Stadium.....	147-150
Arena.....	150-157
Bob-run.....	157-166
Olympic Winter Games	
Opening day.....	167, 168, 173-180
Official competitions	
Skiing.....	181-203
Speed-skating.....	204-212
Figure-skating.....	213-223
Hockey.....	224-239
Bobsleigh.....	240-249
Demonstrations	
Sled-dog racing.....	250-254
Curling.....	255-258
Women's speed-skating.....	258-262
Closing ceremony.....	263
Point scoring.....	264, 265
Tables of honor	
Chamonix.....	266
St Moritz.....	267
Lake Placid.....	268
Lake Placid demonstrations.....	269
Table of participation.....	270
III Olympic Winter Games program.....	272, 273
Alphabetic list of entries.....	274-276
Xth Olympiad Summer Games.....	277, 278
Conclusion.....	279
Index.....	281-287
List of illustrations.....	288-290



—G Cleveland

Jack Shea of Lake Placid, subsequent winner of the 500 and 1500-meter speed-scating races, takes Olympic oath for American team on opening day of Games

A Word of Explanation

This book, "Official Report of the III Olympic Winter Games," is intended to serve a dual purpose. It tells the complete story of the Lake Placid Games and the plans for staging them, and it gives a detailed history of the development of the winter-sports movement in Lake Placid, the pioneer winter resort of the North American continent.

These two motifs underlying the plan of the book are closely intertwined. The Games could never have been awarded to Lake Placid if it had not been for the international standing that this resort had attained as a winter-sports center. So the history of the Games in reality goes back to that day, over a quarter of a century ago, when organized enjoyment of the sports of snow and ice and cold began where the highest peaks of the Adirondack mountains cast their shadows on the village by the two lakes.

Progress, was steady from that day to the morning of February 4, 1932, when Winter's sons and daughters from 17 nations of the earth paraded past the reviewing stand in the stadium at Lake Placid in the impressive opening ceremonies of the III Olympic Winter Games.

The Lake Placid Games have given a tremendous impetus to winter sports in the United States. Other communities are finding that snow and ice are among their greatest assets for sport and recreation. It is hoped that this book will help these same communities to develop their organized enjoyment of winter still further. For this reason facts and figures of Lake Placid's experience and the story of this experience are given in great detail. May they prove helpful.

For much that the Organizing Committee did there was no pattern. If it can leave one for others it will be glad.

All those concerned with the plans for the celebration of the III Olympic Winter Games feel only the utmost confidence that the Winter Games of the quadrennial Olympiad are destined to reach greater heights and more enduring fame with the passing years. This book attempts to tell the story of the part that Lake Placid played in making this achievement predictable and possible.

III Olympic Winter Games Committee

Lake Placid, N Y

June 1, 1932



Baron Pierre de Coubertin, Honorary President of the
Olympic Games

“I congratulate you and your co-workers
most sincerely on the success of these Winter
Games of the Xth Olympiad.”

Pierre de Coubertin

Statement by Count de Baillet-Latour

Washington, D C
March 11, 1932

Dear Dr Dewey

Before leaving America I wish to congratulate you on the success of the III Olympic Winter Games. Altho weather conditions and the extraordinary economic situation rendered your task extremely difficult, 17 nations represented by 364 athletes took part in the Games—a showing that reflects only the highest credit upon the countries represented on the International Olympic Committee and your own Organizing Committee.

I feel that I may say, and speak conservatively when I say it, that European nations that participated in the III Olympic Winter Games were more than pleased at the plans made for staging the Games in Lake Placid, facilities for the conduct of the sports, and other arrangements such as housing, feeding, and transportation that made the stay of your international visitors one that they will long remember.

The Games themselves brought out the most spirited competition in all the events on the Olympic program. This made the Games that much more enjoyable for both spectators and participants. All who attended took home with them, I am sure, a better idea than they ever had before of just what international sports competition means in its highest sense. Beyond a doubt the athletes taking part went back to their native lands imbued with the same idea.

The thanks of the International Olympic Committee are due the community of Lake Placid for taking on in the III Olympic Winter Games of 1932 a greater burden in proportion to its size than any community ever assumed in staging Olympic contests. You know how I feel about the exceptional manner in which this obligation was discharged. It is something that Lake Placid and the Lake Placid Olympic organization can always look back on with pride, as a great task masterfully handled.



Count de Baillet-Latour, President, International Olympic Committee

I feel certain that you would not be satisfied if the success of the competitions should be the only reward for the work you and your competent staff did in staging the III Olympic Winter Games of 1932. You were working for an ideal—to increase the love for winter sports in the United States with the view of augmenting the ranks of, the Olympic family and of making Lake Placid the best-equipped resort for these sports. You have reached these two goals.

Very sincerely yours,

A handwritten signature in cursive script, reading "Baillet-Latour".

President of the
International Olympic Committee



Ready for the Games. A general view of the stadium
in the heart of the principal Adirondack mountain range just south of Lake Placid

—Ranger L. Moore

List of Officers and Committees

International Olympic Committee

Founder

Baron Pierre de Coubertin

Honorary President of the Olympic Games

Headquarters

Lausanne, Switzerland

President

Count de Baillet-Latour

Members

Argentine Republic

His Excellency M de Alvear, Former President
of the Argentine Republic, Paris
R C Aldao, Buenos Aires

Australia

R Coombes, Sydney
James Taylor, Sydney

Austria

Dr Theodore Schmidt, Vienna

Belgium

Count de Baillet-Latour, Brussels
Baron de Laveleye, Jette-Saint-Pierre

Brazil

His Excellency R de Rio Branco, Minister of
Brazil, Berne
Arnoldo Guinle, Rio de Janeiro
Dr Ferreira Santos, Sao Paulo

Bulgaria

His Excellency Stephan G Tchaprachikov, Berlin

Canada

J G Merrick, Toronto
Sir George McLaren Brown, London

Central America

P J de Matheu, Paris

Chile

His Excellency Don Alfredo Ewing, Santiago

China

His Excellency Dr C T Wang, Shanghai

Cuba

Porfirio Franca, Havana

Czechoslovakia

Counselor Jiri Guth-Jarkovsky, Prague

Denmark

His Royal Highness Prince Axel of Denmark,
Gentofte

Egypt

Angelo C Bolanachi, Alexandria and Paris

Esthonia

His Excellency Dr F Akel, Minister of Esthonia
in Stockholm

Finland

Ernst Krogius, Helsingfors

France

Albert Glandaz, Paris
Marquis de Polignac, Rheims and Paris
Count Clary, Paris

Germany

His Excellency Secretary of State Dr Theodore
Lewald, Berlin
His Excellency Duke Adolphe Frederic de
Mecklenburg-Schwerin, Bad Doberan, Schwerin
Dr Carl Ritter von Halt, Munich

Great Britain

General Kentish, British Olympic Association,
London
Lord Rochdale, London
Lord Aberdare, London

Greece

His Excellency M Politis, Minister of Greece
in Paris, Greek Legation, Paris

Holland

Commander P W Scharroo, Amersfoort
Baron A Schimmelpenninck van der Oye,
Doorn

Hungary

Count Geza Andrassy, Budapest
Senator Jules de Muzsa, Budapest

India

G D Sondhi, Lahore

Ireland

J J Keane, Dublin

Italy

Hon Carlo Montu, Bellagio
Count Bonacossa, Milan

Japan

Senator Jigoro Kano, Tokio
Dr S Kishi, Tokio

Jugoslavia

General S S Djoukitch, Sarajevo
Professor F Bucar, Zagreb

Latvia

J Dikmanis, Riga

Mexico

Dr M Saenz, Minister of Physical Education,
Mexico City

Monaco

Count Gautier-Vignal, Beaulieu s/M Alpes
Maritimes

New Zealand

C J Wray, London

Norway

Thos Fearnley, Oslo

Peru

Alfredo Benavides, Miraflores, Lima

Poland

His Excellency M Ignace Matuszewski, Min-
ister of Poland in Budapest
General Dr Rouppert, Warsaw

Portugal

Count de Penha-Garcia, Lisbon

Roumania

Georges A Plagino, Bucharest

Russia

Prince Leon Ouroussoff, Paris

South Africa

Henry Nourse, Johannesburg, Transvaal

Spain

Baron de Guell, Barcelona
Count de Vallellano, Madrid

Sweden

Count Clarence de Rosen, Julita
J S Edström, Vesteras

Switzerland

Baron Godefroy de Blonay, Grandson

Turkey

His Excellency Kemaleddin Sami Pacha,
Ambassador of Turkey in Berlin

United States of America

William M Garland, Los Angeles
General Charles H Sherrill, New York
Commodore Ernest Lee Jahncke, New Orleans

Uruguay

Dr F Ghigliani, Montevideo

Executive Committee

Count de Baillet-Latour, President

Baron Godefroy de Blonay, *Vice-president*

J S Edström

Lord Aberdare

Marquis de Polignac

General Charles H Sherrill

Dr Theodore Lewald

Secretary

Lieut-Col A G Berdez, Mon Repos, Lausanne

American Olympic Association

Honorary Officers

Honorary President—Herbert Hoover, The President of the United States
Honorary Vice-president—Henry L Stimson, Secretary of State
Honorary Vice-president—Patrick J Hurley, Secretary of War
Honorary Vice-president—Charles F Adams, Secretary of Navy
President Emeritus—Dr Graeme M Hammond

Officers

President.....Avery Brundage, Chicago, Ill
Vice-president..... Dr Charles W Kennedy, Princeton, N J
Secretary..... Frederick W Rubien, New York City
Treasurer.....George W Graves, Detroit, Mich

Executive Committee

Romeyn Berry, Ithaca, N Y
William J Bingham, Cambridge, Mass
Avery Brundage, Chicago, Ill
Henry Penn Burke, Philadelphia, Pa
Lieut George C Calnan, Lakehurst, N J
Major Eley P Denson, Washington, D C
L di Benedetto, New Orleans, La
Dr R S Elmer, Bellows Falls, Vt
J Frank Facey, Cambridge, Mass
Daniel J Ferris, New York City
Captain Karl T Frederick, New York City
A C Gilbert, New Haven, Conn
George W Graves, Detroit Mich
Henry Kirk Greer, New York City
Dr Graeme M Hammond, New York City
Major-General Guy V Henry, Washington D C
Leslie A Henry, Los Angeles, Calif
Murray Hulbert, New York City
William F Humphrey, San Francisco, Calif
Dr Charles W Kennedy, Princeton, N J
Gustavus T Kirby, New York City
Frank L Kramer, Newark, N J
Fred W Luehring, Minneapolis, Minn
General Douglas MacArthur, Washington, D C
Clifford D Mallory, New York City
Dr G Randolph Manning, New York City
Charles L Ornstein, New York City
Dr Joseph E Raycroft, Princeton, N J
Brig-General M A Reckord, Washington, D C
Commander L F Reifsnider, Washington, D C
Major William C Rose, Washington, D C
Frederick W Rubien, New York City
Professor L W St John, Columbus, Ohio
Joseph K Savage, New York City
Alonzo A Stagg, Chicago, Ill
Fred L Steers, Chicago, Ill
Major Patrick J Walsh, New York City

American Olympic Committee

The American Olympic Committee consists of the executive committee of the American Olympic Association, listed herewith, and the following:

Sherwin C Badger, New York City
Frank W Blankley, Chicago, Ill
Dr I R Calkins, Springfield, Mass
Joseph T England, Baltimore, Md
Emile E Fraysse, Ridgefield Park, N J
William Carroll Hill, Boston, Mass
William P Kenney, Roxbury, Mass
Roy E Moore, New York City
Jay O'Brien, New York City
Armstrong Patterson, Detroit, Mich
Prof Charles A Proctor, Hanover, N H
Dr Albert Soiland, Los Angeles, Calif
Leon M Schoonmaker, Long Island City, N Y
Paul A Spitler, New York City
Rufus J Trimble, New York City
Henry Wiener IV, Philadelphia, Pa
Dietrich Wortmann, New York City

International Olympic Committee

Members for United States

William M Garland
General Charles H Sherrill
Commodore Ernest Lee Jahncke

Officers and Active Members of III Olympic Winter Games Committee

Honorary Officers

Honorary President—Hon Franklin D Roosevelt, Governor, State of New York, Albany, N Y

Honorary Vice-presidents

Hon Herbert H Lehman, Lieut-governor, State of New York, Albany, N Y

Gustavus T-Kirby, Past President, American Olympic Committee New York City

General Douglas MacArthur, Past President, American Olympic Committee, Washington, D C

Dr Graeme M Hammond, President Emeritus, American Olympic Association, New York City

Active Officers

President..... Dr Godfrey Dewey, Lake Placid Club, N Y

Vice-president..... Willis Wells, Lake Placid, N Y

Secretary..... Ernest Gamache, Leominster, Mass

Treasurer..... William J O'Hare, Lake Placid, N Y

Board of Directors

Avery Brundage, President, American Olympic Association and Amateur Athletic Union, Chicago, Ill

Dr Godfrey Dewey, Vice-president, Lake Placid Co, Lake Placid Club, N Y

A C Gilbert, Executive Committee, American Olympic Association, New Haven, Conn

Lewis G Graeves, Past President, Saranac Lake Chamber of Commerce, Saranac Lake, N Y

Forrest B Guild, President, Bank of Lake Placid, Lake Placid, N Y

Harry Wade Hicks, Secretary, Lake Placid Club, Lake Placid Club, N Y

James B Hurley, Vice-president, Bank of Lake Placid, Lake Placid, N Y

Dr Charles W Kennedy, Athletic Director, Princeton University and President, National Collegiate Athletic Association, Princeton, N J

Rollie J Kennedy, Chairman, North Elba Park Commission, Lake Placid, N Y

Gustavus T Kirby, Past President, Intercollegiate Amateur Athletic Association of America and American Olympic Committee, New York City

Judge Thomas A Leahy, President, Lake Placid Chamber of Commerce, Lake Placid, N Y

Martin T Ryan, Mayor, Lake Placid Village, Lake Placid, N Y

Charles Waite, Chairman, Essex County Park Commission, Crown Point, N Y

Howard L Weaver, Past President, Lake Placid Board of Education, Lake Placid, N Y

Willis Wells, Supervisor, Town of North Elba, Lake Placid, N Y

Active Members

The Executive Committee of the A O A (See page 13)

and

H Sargent Appleton, New York City

Sherwin C Badger, New York City

Jerome D Barnum, Syracuse, N Y

Paul L Boyce, Glens Falls, N Y

Henry E H Brereton, Lake George, N Y

Irving Brokaw, New York City

Sir George McLaren Brown, London, England

Harold A Bruce, Schenectady, N Y

R R M Carpenter, Wilmington, Delaware

Walter Cluett, Troy, N Y

Lewis Crane, Utica, N Y

Dr Godfrey Dewey, Lake Placid Club, N Y

*Dr Melvil Dewey, Lake Placid Club, N Y

Charles Wesley Dunn, New York City

Mark Eisner, New York City

George R Fearon, Syracuse, N Y

William E Feek, Lake Placid, N Y

Abraham W Feinberg, New York City

T Harvey Ferris, Utica, N Y

Judge Rufus E Foster, New Orleans, La

William May Garland, Los Angeles, Calif

Lewis Graeves, Saranac Lake, N Y

Irving H Griswold, Plattsburg, N Y

Forrest B Guild, Lake Placid, N Y

Basil Harris, New York City

Fred Harris, Brattleboro, Vt

Merwin K Hart, Utica, N Y

Harry Wade Hicks, Lake Placid Club, N Y

* Deceast

Joseph T Higgins, New York City
 John W Hornor, New York City
 William G Howard, Albany, N Y
 James B Hurley, Lake Placid, N Y
 Commodore Ernest Lee Jahncke, New Orleans, La
 Commander Herbert A Jones, Washington, D C
 Frederick T Kelsey, New York City
 Rollie J Kennedy, Lake Placid, N Y
 Peter D Kiernan, Albany, N Y
 judge Thomas A Leahy, Lake Placid, N Y
 A Jocelyn H Magrath, New York City
 Alexander Macdonald, Albany, N Y
 Henry Morgenthau, Jr, Albany, N Y
 John Caldwell Myers, New York City
 John P Myers, Plattsburg, N Y
 Julian S Myrick, New York City
 James F Newcomb, New York City
 William J O'Hare, Lake Placid, N Y
 George Foster Peabody, Saratoga Springs, N Y
 Fred L Porter, Crown Point, N Y
 Raymond C Prime, Lake Placid, N Y
 John J Raskob, New -York City
 Philip E Rice, Schroon Lake, N Y
 Martin T Ryan, Lake Placid, N Y
 General Charles H Sherrill, New York City
 Warren T Thayer, Chateaugay, N Y
 *Harold R Thompson, Lake Placid, N Y
 Ralph J Ury, Schenectady, N Y
 Charles Waite, Crown Point, N Y
 Howard L Weaver, Lake Placid, N Y
 Willis Wells, Lake Placid, N Y

**New York State Olympic Winter
 Games Commission**

Chairman.....Warren T Thayer, Chateaugay, N Y
Vice-chairman....Fred L Porter, Crown Point, N Y
Secretary.....T Harvey Ferris, Utica, N Y
 Dr Godfrey Dewey, Lake Placid Club, N Y
 Frank A Frost, Watkins Glen, N Y
 George Foster Peabody, Saratoga Springs, N Y
 Edwin W Wallace, Rockville Center, N Y
 Rollie J Kennedy, Lake Placid, N Y
 William G Howard, Albany, N Y

Ex-Officio Members

George R Fearon, Syracuse, N Y
 Joseph A McGinnies, Ripley, N Y

Executive Secretary

Ernest F Gamache, Leominster, Mass

* Decast

Counsel

Wallace E Pierce, Plattsburg, N Y

III O W G Standing Committees

Housing Committee

Judge T A Leahy, *Chairman*, Benjamin R Bull,
 Edward Hart, James B Hurley, Dura Jenney,
 William Lamb, C J Ortloff, Martin T Ryan,
 William Ryan, Hubert Stevens

Transportation Committee

Lewis Crane, *Chairman*, Arthur W Brandt, C K
 Brodhead, Sir George McLaren Brown, Edward
 English, Russell Golder, Earle McDevitt, Wil-
 liam Wallace, Howard Weaver

Health and Safety Committee

Martin T Ryan, *Chairman*, Dr F J d'Avignon,
 Dr J A Geis, Major John A Warner, H J Wood

Finance Committee

Willis Wells, *Chairman*, T Harvey Ferris, Irving
 H Griswold, F B Guild, Basil Harris

Publicity Committee

F B Guild, *Chairman*, J B Hurley, E E MacCon-
 nell, E C Paarman, Thomas P Faherty

III O W G Sports Committees

Skiing

Dr R S Elmer, *Chairman*, Bellows Falls, Vt; Fred
 H Harris, Brattleboro, Vt; Charles A Proctor,
 Hanover, N H; O Smith Johannsen, New York
 City; George W Martin, Lake Placid Club, NY

Speed Skating

Joseph K Savage, *Chairman*, New York City; Ed-
 mund Horton, Saranac Lake, N Y; Clarence
 Eccleston, Lake Placid, N Y

Figure Skating

Sherwin C Badger, *Chairman*, New York City;
 David T Layman, Jr, New York City; Henry
 W Howe, New York City; Bedell H Harned,
 New York City

Hockey

Rufus J Trimble, *Chairman*, New York City; Wil-
 liam Eggens, Lake Placid, N Y; Harold A
 Bruce, Schenectady, N Y; W F Duquette, Sara-
 nac Lake, N Y

Bobsleigh

Major Philip Fleming, Chairman, West Point, N Y; Jay O'Brien, New York City; H L Garren, Lake Placid, N Y

Sled-dog Racing

Walter Channing, Chairman, Boston, Mass; Moseley Taylor, Boston, Mass; Louis D Hudon, Quebec, Canada; Capt C A Billings, Chateau Laurier, Ottawa, Canada; Henry Stetson, Hotel Biltmore, New York City; Hubert Stevens, Lake Placid, N Y

Curling

John Calder, Chairman, Utica, N Y; Dr Sidney F Blanchet, Saranac Lake, N Y; William G Distin, Saranac Lake, N Y; Peter Lyall, Montreal, Canada

Co-operating Bodies

Essex County Park Commission

Charles Waite, Crown Point, N Y, Chairman
Albert J McCoy, Minerva, N Y, Secretary
*Albert Call, Keene, N Y

Merton I Thrall, Lewis, N Y
Willis Wells, Lake Placid, N Y

North Elba Town Board

Willis Wells, Supervisor
Ethel M Wells, Clerk
T A Leahy, Justice of the Peace
W R Wikoff, Justice of the Peace
George A Putnam, Justice of the Peace
Rollie Torrance, Justice of the Peace

North Elba Park Commission

R J Kennedy, Chairman
Deo B Colburn, Secretary
B R Bull
William Lamb
James Shea

Lake Placid Village Board

Martin T Ryan, Mayor
E C Herb, Clerk
Deo B Colburn, Trustee
Frank S Leonard, Trustee
S J Volpert, Trustee
Rufus Walton, Trustee

* Deceast



AVERY BRUNDAGE
Chicago
President



—Champlain Studio

Dr CHARLES W KENNEDY
Princeton, N J
Vice-president



—Underwood
& Underwood

HERBERT HOOVER
The President of the United States
Honorary President



FREDERICK W RUBIEN
New York City
Secretary



GEORGE W GRAVES
Detroit
Treasurer



Dr GRAEME M HAMMOND
New York City
President Emeritus

Officers of the American Olympic Association



DR GODFREY DEWEY
Lake Placid Club, N Y
President



—Pierson Studio

WILLIS WELLS
Lake Placid, N Y
Vice-president



—New York Times Studio

FRANKLIN D ROOSEVELT
Governor, State of New York
Honorary President



—Roger L. Moore

ERNEST F GAMACHE
Leominster, Mass
Secretary



—Roger L. Moore

WILLIAM J O'HARE
Lake Placid, N Y
Treasurer

Officers and Directors of the III Olympic Winter Games Committee



THOMAS A LEAHY
Lake Placid, N Y



FORREST B GUILD
Lake Placid, N Y



JAMES B HURLEY
Lake Placid, N Y



HARRY WADE HICKS
Lake Placid Club, N Y



LEWIS G GRAEVES
Saranac Lake, N Y



MARTIN T RYAN
Lake Placid, N Y

—Roger L. Moore

Officers and Directors of the III Olympic Winter Games Committee



—Pierson Studio

HOWARD L WEAVER
Lake Placid, N Y

GUSTAVUS T KIRBY
New York City
—Underwood & Underwood



CHARLES WAITE
Crown Point, N Y



A C GILBERT
New Haven, Conn



—Roger L Moore

JOHN F WHITE
Lake Placid, N Y



—Blank-Stoller

FREDERICK T KELSEY
New York City

In addition to those pictured here the following were members of the III Olympic Winter Games Board of Directors: Avery Brundage, Dr Charles W Kennedy and Dr Graeme M Hammond (photographs with A O A page 17), and Rollie J Kennedy (photograph with N Y State O W G Commission page 21)

Officers and Directors of the III Olympic Winter Games Committee



—Gustave Lorey
FRED L PORTER
Crown Point, N Y
Vice-chairman



T HARVEY FERRIS
Utica, N Y
Secretary



—Gustave Lore
WARREN T THAYER
Chateaugay, N Y
Chairman



—Blank-Stoller
ROLLIE J KENNEDY
Lake Placid, N Y



WILLIAM G HOWARD
Albany, N Y

New York State Olympic Winter Games Commission



FRANK A FROST
Watkins Glen, N Y



EDWIN W WALLACE
Rockville Center, N Y



WALLACE E PIERCE
Plattsburg, N Y
Counsel



—Underwood & Underwood
GEORGE FOSTER PEABODY
Saratoga Springs, N Y



GEORGE R FEARON
Syracuse, N Y

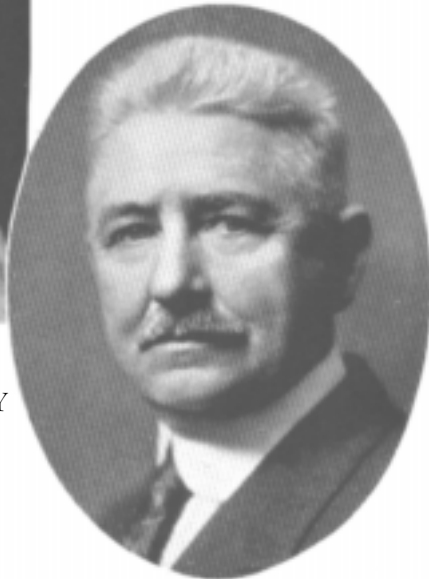

JOSEPH A MCGINNIES
Ripley, N Y

New York State Olympic Winter Games Commission

In addition to those pictured here Dr Godfrey Dewey (photograph with III O W G Committee page 18) was a member. E F Gamache (photograph with III O W G Committee page 18) was executive secretary

International Olympic Committee

Rules of Procedure

Regulations and Protocol for the Celebration of the Modern Olympiads and of the Quadrennial Olympic Games

The International Olympic Committee in accordance with its constitutional rights having previously fixed the time and place for the celebration of the next Olympiad (the fixing of which, except in exceptional circumstances, must take place at least three years beforehand) entrusts the organization to the National Olympic Committee of the country in which the chosen town is situated. This country can delegate the duties with which it has been entrusted to a Special Organizing Committee chosen by itself and whose officials shall thenceforth correspond directly with the International Olympic Committee. The powers of this special committee expire with the period of the Games in such a case.

Time and Duration of the Olympic Games

The Olympic Games must take place during the first year of the Olympiad which they are to celebrate (thus in 1924 for the VIIIth, 1928 for the IXth, 1932 for the Xth, etc.). Under no pretext whatsoever can they be adjourned to another year. Their non-celebration during the year chosen is equal to the non-celebration of the Olympiad and involves the annulment of the rights of the town chosen and the country to which this town belongs. These rights cannot in any case be carried forward to the next Olympiad.

The time of year at which the Olympic Games are to be held is not permanently fixed, but depends on the Organizing Committee who shall conform, as far as possible: to the wishes of the countries participating.

The period of the Games shall not exceed 16 days including the opening day.

Olympic City

The events must all take place in the town chosen, either at the Stadium or in its neigh-

borhood. The only exception which can be made is in the case of nautical sports when geographical conditions shall make it necessary. The town chosen cannot share its privilege with another any more than it can add or allow to be added anything not in accordance with the Olympic ideal.

Privileges and Duties of the Organizing Committee

For all the technical arrangements of the Games, the Organizing Committee must consult, as far as agreements in this respect allow, the National Olympic Committees and the International Federations. The Organizing Committee is bound to observe the said agreements; it alone is responsible for their observation. It must see that all the different branches of sport (athletics, gymnastics, equestrian sports, nautical sports, combative sports . . .) are placed on the same footing and that one is not favored before another. It must at the same time supervise the five art competitions (architecture, painting, sculpture, music, and literature) which form an integral part of the Olympic Games.

Invitations and Forms

The invitations to take part in the Games are sent out by the Organizing Committee to all countries in general and in the first place to those who have established National Olympic Committees. The invitations are drawn up in these terms:

“The International Olympic Committee having chosen the town of . . . as the place for the celebration of the . . . Olympiad, the Organizing Committee of the Olympic Games of 19 . . . has the honour to invite you to take part in the competitions and celebrations which will take place on this occasion at . . . from . . . to . . . ”

All documents (invitations, fixture lists, entrance tickets, programs, etc.) printed during the Games, as well as the badges distributed, must bear the number of the Olympiad as well as the name of the town where it is celebrated (e. g. Vth Olympiad, Stockholm, 1912—VIIth Olympiad, Antwerp, 1920).

Flags

Both in the Stadium and in its neighborhood the Olympic Flag must be freely flown with the flags of the competing nations (*). A large Olympic Flag must fly in the Stadium during the Games from a central flag-staff where it is hoisted at the moment the Games are declared open and taken down when they are declared closed.

Each victory is recorded by the hoisting of the national flag of the winner. The national anthem of this nation is then played during which time the spectators remain standing.

Opening Ceremony of the Olympic Games

The King or President who opens the Olympic Games is received at the entrance of the Stadium by the President of the International Olympic Committee, who presents his colleagues, and by the President of the Organizing Committee, who also presents his colleagues. The two Presidents conduct the King or President and the persons accompanying him to the tribune of honour where he is greeted with the national Anthem of the country either played or sung. Soon after the march past of the athletes takes place. Each contingent dressed to take part in the Games must be preceded by a banner bearing the name of its country and accompanied by its national flag (the countries will be in alphabetical order). Only those participating in the games can take part in the march past, all others being excluded. Each contingent having completed its march round the Stadium lines up on the

centre of the ground in a deep column behind its ensign and flag facing the Tribune of Honour. The International Olympic Committee and the Organizing Committee then form themselves up in the arena in a semi-circle and the President of the Organizing Committee advancing takes the oath and reads a brief speech, at the end of which he asks the King or President to proclaim the Games open.

The latter rises and says: "*I proclaim open the Olympic Games of . . . celebrating the . . . Olympiad of the modern era.*" Immediately a fanfare of trumpets is heard and a salute is fired whilst the Olympic flag is hoisted on the central mast, this being a signal for the freeing of pigeons (each pigeon having round its neck a ribbon with the colours of the nations participating), after which the choirs sing an anthem. If there is to be a religious ceremony, this now takes place*. If not, there immediately follows the taking of the oath by the athletes. A representative of the country where the Games are taking place advances to the foot of the Tribune of Honour bearing in his hand the flag of his country and surrounded by bearers of flags of all the other countries arranged in a semi-circle in the place formerly occupied by the Committees. He then pronounces in a loud voice the following oath, all the other athletes, with their right arms raised, joining in: "*We swear that we will take part in the Olympic Games in loyal competition, respecting the regulations which govern them and desirous of participating in them in the true spirit of sportsmanship for the honour of our country and for the glory of sport.*" The choirs sing once more, and the march past of the athletes takes place, in reverse order, to the exit of the Stadium. The ceremony thus comes to an end and the competitions may begin, unless the afternoon has been set aside for a gymnastic display or some such appropriate demonstration.

*The Olympic Flag has a white background with no border; in the centre it has five interlaced rings (blue, yellow, black, green, red). The blue ring is high on the left. The flag used at Antwerp is the regulation model.

*This was the case at the Vth Olympiad, Stockholm 1912, and at the IXth Olympiad (Amsterdam 1928). At the IVth (London 1908) the ceremony was held the next day but one at St. Paul's. At the VIIth Olympiad it took place on the morning of the opening at the cathedral and was conducted. by His Excellency Cardinal Mercier.

Distribution of Prizes

The Organizing Committee arranges this in the best way possible. It can be divided into as many sections as necessary but above all things it is desirable that the winners shall themselves receive their prizes in their sports dress.

Closing Ceremony of the Olympic Games

This ceremony must take place in the Stadium after the last event. The closing is pronounced from the Tribune of Honour by the President of the International Olympic Committee (or one of his colleagues) in these words: "*In the name of the International Olympic Committee, after having offered to the . . . and to the people . . . (names of the President and the country), to the authorities of the town of . . . and to the organizers of the Games, our deepest gratitude, we proclaim the closing of the . . . Olympiad and, in accordance with tradition, we call upon the Youth of every country to assemble in four years at . . . * (name of town chosen) there to celebrate with us the Games of the . . . Olympiad. May they display cheerfulness and concord so that the Olympiad torch may be carried on with ever greater eagerness, courage and honour for the good of humanity throughout the ages,*" Then the trumpets sound, the Olympic flag is lowered from the central mast accompanied by a salute of five guns and the choirs sing the final cantata.

General Rules Applicable to the Celebration of the Olympic Games

I Definition of an Amateur

The definition of an amateur as drawn up by the respective International Federations of Sport is recognized for the admission of athletes taking part in the Olympic Games.

Where there is no International Federation governing a sport, the definition shall be drawn up by the Organizing Committee, in agreement with the I O C. The National Association, which in each country governs each particular sport, must certify on the special form that each competitor is an amateur in accordance with the rules of the International Federation governing that sport.

This declaration must also be countersigned by

*In case the town has not yet been chosen the name of the town is replaced by the words "at the place which will ultimately be chosen."

At the same time the President of the International Olympic Committee in the Tribune of Honour hands over to the Mayor of the town the Olympic flag of embroidered satin, presented in 1920 by the Belgian Olympic Committee, which had been given to him by a representative of the town where the previous Olympic Games had been held. This flag must be kept in the municipal building until the following Olympiad.

Precedence

No special embassy can be accepted by the Organizing country on the occasion of the Games. For the duration of the Games precedence belongs to the members of the International Olympic Committee, the members of the Organizing Committee, the Presidents of the National Olympic Committees and the Presidents of the International Federations. They form the Olympic senate which takes first place after the King or President of the country and his attendants.

Arts and Letters

Art and literary exhibitions which may be organized during the Games and in connection with them are not fixed. It is desirable that they should be numerous and especially that public lectures should take place and also that the work submitted for art competitions and accepted by the Jury should be exhibited in the Stadium or in its neighborhood.

the National Olympic Committee of that country. This committee must also declare that it considers the competitor an amateur according to the definition of the International Federation in question.

II Necessary Conditions for Representing a Country

Only those, who are Nationals or naturalized subjects of a country or of a state which is part of that country, are able to represent that country in the Olympic Games.

Those who have already competed in the Olympic Games cannot compete in future Olympic Games for another nation even if they have become naturalized subjects of that nation, except in the case of conquest or the creation of a new state ratified by treaty. In the case of naturalization, the

naturalized subject must give proof that he was an amateur in his native country at the time of changing his nationality.

An Athlete taking part in the Olympic Games must satisfy the following conditions:

- 1 Must not be, or knowingly have become, a professional in the Sport for which he is entered or in any other sport.
- 2 Must not have received reimbursement or compensation for loss of salary.

A holiday given under the normal conditions of a business or profession or a holiday accorded under the same conditions on the occasion of the Olympic Games, and provided that it does not lead to a reimbursement for lost salary, direct or indirect, does not come within the provision of § 2.

Finally each athlete must sign the following declaration on his honor:

I, the undersigned, declare on my honor that I am an Amateur according to the Olympic Rules of Amateuism.

III Age Limit

There is no age limit for competitors in the Olympic Games.

IV Participation by Women

Women are allowed to compete in certain events at the Olympic Games. The program sets forth the events in which they may take part.

V Program

The official program is laid down in accordance with the classification agreed to by the I O C. It comprises:

Athletic Sports
Gymnastics
Sports of Defence (Boxing, Fencing, Wrestling, Shooting)
Water Sports (Rowing, Swimming)
Riding

All round competitions (Modern Pentathlon)
Cycling, Weight Lifting, Yachting.
Art Competitions (Architecture, Literature, Music, Painting and Sculpture), and the following Athletic Games: Football (Association and Rugby), Lawn Tennis, Polo, Water Polo, Hockey, Handball, Basket Ball and Pelota from which the Organizing Committee may select those which it can organize provided that the finals are competed during the official period of the Games.

Each International Federation must decide in agreement with the Executive Committee of the I O C the events which shall be included in each sport.

The I O C reserves to itself the right not to include in the program any sport in which the definition of the amateur does not fall within the prin-

VI Demonstrations

The Organizing Committee of the Games can organize demonstrations of two sports not included in the program:

- 1 A national sport
- 2 A sport foreign to the Organizing Country

VII Winter Games

The program for the Winter Games includes the following events: Skiing, Skating, Ice Hockey, Bobsleigh and Tobogganing.

Winter Sports not governed by an International Federation can only be included in the Winter Games under the title of "Demonstrations."

In each sport the events are governed by the technical rules of the International Federations concerned.

However, a special military ski competition may be organized. The number of entries in each sport and each event shall be fixed by the International Olympic Committee after consultation with the International Federations.

The prizes, medals and diplomas must be different from those used for the current Olympic Games.

The Winter Games are governed by all the general rules applicable to the Olympic Games as well as the rules of the Olympic protocol:

VIII Organization

The Organizing Committee of the country chosen for the celebration of the Olympic Games is responsible for the Games and must make all the necessary arrangements. It must carry on all correspondence relating to its work and send out the official invitations to the different nations after agreement with the Executive Committee of the I O C.

IX Entries

Entries for all events are received by the National Olympic Committee of each country who alone can forward them to the Organizing Committee of the Games.

The Organizing Committee must acknowledge them.

If there is no National Olympic Committee in a country, this country must form such a Committee before it is admitted to take part in the Olympic Games.

The address of this Committee must immediately be transmitted to the Executive Committee of the I O C as well as to the Organizing Committee.

If a National Olympic Committee considers that any entry does not conform to the Olympic requirements or the definitions of the International Federations this entry will be sent on without being countersigned.



Powerful flood lights make Olympic stadium track as light as day

—GE Illuminating Engineering Laborat



Taking a look up the Mt Van Hoevenberg Olympic bob-run from the air

—Roger L. Moore



—H Armstrong Roberts



a) Six weeks before the date of the opening of the Games the list of the sports and of the events in which a nation will participate must be in the possession of the Organizing Committee. This list can be telegraphed.

b) The *names of the competitors* must be received by the Organizing Committee at least a *fortnight* before the date of the first event in each sport, and no variation from this can be permitted.

The Organizing Committee must be in possession of the entries and names of the competitors by midnight of the last day fixed by the present article. All entries have to be written on a special form and in duplicate. The names of the athletes must be printed or typewritten.

In order to guarantee that telegraphic communications are genuine, all National Olympic Committees who use this means of correspondence must communicate to the Organizing Committee some *special word or words* to be used in all telegrams sent by them.

Entries are not valid unless the above rules are observed.

To permit and to promote during the Olympic Games such displays as are calculated to exhibit the value of different systems of gymnastic instruction, the I O C will themselves receive entries directly from groups qualified to offer such displays and transmit them to the Committee organizing the Games for its use.

No entrance fee can be demanded from the competitors.

X *Number of Entries*

The maximum number of entries from each nation in each event is fixed by the International Federation.

However, the following numbers cannot be exceeded :

- a) For individual events, three competitors from each nation (without reserves).
- b) For team events, one team per nation, the number of reserves to be fixed by the International Federations concerned.

The last rule does not apply to Lawn Tennis Doubles or the Tandem Cycle Race.

In cases where there is no International Federation for a sport the Organizing Committee of the Olympic Games fixes the number of entries for this sport in accordance with the above rules.

N B These rules do not apply to the Winter Games.

XI *Non-Acceptance of Entries*

The Organizing Committee has the right to refuse any entry without being obliged to disclose the reason for its decision.

Nevertheless the reason will be communicated confidentially to the National Olympic Committee concerned.

XII *Organization of the Different Sports*

The sole responsibility and control of the Games shall rest with that National Committee to whom the Organization of the Games has been entrusted, such organization to be carried out in accordance with the regulations and protocol of the Olympic Games.

The Organizing Committee shall make all necessary arrangements for the celebration of the Olympic Games in accordance with the general regulations adopted by the various Congresses and the protocol of the International Olympic Committee.

The technical celebration of the Games is governed by the rules established by the Congresses of Paris (1914), Lausanne (1921), Prague (1925) and Berlin (1930) which determined the functions of the National Olympic Committees and the International Federations under the direction of the International Olympic Committee.

The Organizing Committee must enforce the strictest observance of the technical rules of the International Federations, these Federations having the right in each sport to choose the Juries and have the control of the athletic equipment and the technical direction of the events.

The International Federations shall choose a maximum of three technical delegates who must be present 15 clear days before the start of their sport, to get into touch with the Organizing Committee and prepare the work of the Juries.

The expenses of these three delegates during the 15 days before the start of their sport will be charged to the Organizing Committee of the Games at the rate of 5 dollars a day. The International Federations may make a further inspection but the above-mentioned allowance may not be exceeded.

XIII *Judging the Events*

A Jury of Appeal and a Ground Jury (Judges) shall be appointed for each sport. The choice of them is left to the International Federations.

One delegate of each International Federation must be present at least five days before the first event of its sport in order to check the entries.

The members of these juries and the officials must all be amateurs.

Where a jury has not been formed by the time it should have started to function, the Organizing Committee will advise and decide how to form one.

The Juries of Appeal for the sports not governed by an International Federation shall be formed by the Organizing Committee of the Olympic Games and must be composed of five members of different nationalities, who shall elect their own president.

XIV *Jury Of Honor*

During the Games the Executive Committee of the International Olympic Committee is constituted a Jury of Honor.

The duty of this Jury is to intervene in all questions of a non-technical nature outside the jurisdiction of the Juries of the International Federations. They must do this when asked by the Organizing Committee, or at the request of an authorized representative of one of the parties, or themselves spontaneously in case of absolute necessity.

XV *Claims*

Claims made to the Judges concerning matters of fact are decided by them without appeal.

Appeals against other decisions of the Judges or with regard to any other matters must be addressed to the President of the Juries of Appeal by a member selected by the Olympic Committee of the country making the appeal or by a person who takes his place.

Unless the International Federation concerned decides upon an extension of time these claims must be made within one hour of the decision giving rise to the claim. The Jury shall then give a decision after an enquiry and this decision shall be irrevocable.

No claim can be considered unless it is accompanied by a deposit of 50 gold francs.

This sum will not be returned if the claim is made upon frivolous grounds.

XVI *Claims Against the Qualification of a Competitor*

In case of a claim dealing with the amateur status of a competitor, the International Federation concerned shall decide upon the claim.

If the claim is made before the beginning of the events, it must be submitted to the delegate of the International Federation qualified to give judgment on the sport in question according to Article XIII. This delegate has to decide immediately and without appeal on a matter that concerns participation in accordance with the terms of Article XVII.

Any claims made after the beginning of the Games must be submitted to the Jury of Appeal on the spot and in writing within a quarter of an hour after the end of the event.

Claims made after the end of the Games against the qualification of one of the competitors must be received by the International Federation concerned within 30 days of the distribution of prizes. The Federation shall give its decision after an enquiry. Its decision will be irrevocable and must be communicated to the Organizing Committee.

XVII *Penalties in Case of Fraud*

They are as follows:

- a) An athlete convicted of having fraudulently taken the status of an amateur shall be disqualified and lose any position he may have gained.
- b) If this athlete's Federation is convicted of being a party to this fraud, the country to which he belongs shall be disqualified in the sport or sports in which this athlete was taking part.

XVIII *Prizes*

The prizes at the Olympic Games consist of Olympic medals and diplomas. Each medal is accompanied by a diploma. A diploma is also given to the winning team in team competitions.

The Organizing Committee may, upon the suggestion of the International Federation, give a diploma of merit to a competitor whose performance has been brilliant but who has not won a prize.

All those participating in the Games shall receive a commemorative medal.

To sum up, three medals will be given for each event:

a) Individual events:

- 1 First prize, a silver-gilt medal and a diploma.
- 2 Second prize, a silver medal and a diploma.
- 3 Third prize, a bronze medal and a diploma.

b) Team events:

- 1 To the winning team, a diploma and to each member of the team a silver-gilt medal and a diploma.
- 2 To the second, a diploma to the team and to each of the team a silver medal and a diploma.
- 3 To the third, a diploma to the team and to each member of the team a bronze medal and a diploma.

In the team events all those who have actually taken part in an event shall have a right to the medal and diploma corresponding to the prize gained by the team.

The names of the winners shall be inscribed upon the walls of the Stadium where the Games have been opened and closed.

XIX *Classification*

In the Olympic Games there is no classification according to points.

A Roll of Honor, in alphabetical order, shall be set up bearing the names of the first six competitors in each event as soon as this classification has been made.

This document shall be drawn up and kept under the control of the International Olympic Committee.

XX Booklets and Programs

A special booklet containing the program and general rules shall be issued for each particular sport.

The booklets and programs of the Olympic Games shall have no advertising matter in them.

XXI International Federations

At the Olympic Games the Competition Rules enforced are those of the recognized International Federations as defined at Lausanne in 1921. They are as follows:

International Amateur Athletic Federation
International Rowing Federation
International Bobsleigh and Tobogganing Federation
International Amateur Boxing Federation
International Cyclists' Union
International Horse Riding Federation
International Fencing Federation
International Association Football Federation
International Gymnastic Federation
International Amateur Handball Federation
International Ice Hockey League
International Hockey Federation
International Amateur Wrestling Federation, Greco-Roman and Free
International Amateur Swimming Federation
International Skating Union
International Pelota Federation
International Weight Lifting Federation
International Ski Federation
International Shooting Union
International Yacht Racing Union

XXII Sports Not Governed by an International Federation

If a sport included in the Olympic Games is not governed by an International Federation, or is governed by an International Federation which has been dissolved, the necessary arrangements must be made by the Organizing Committee.

XXIII Traveling Expenses

The Organizing Committee has nothing to do with the traveling expenses of competitors and officials, except as in Article XII of these regulations. It is however their duty to take all necessary steps to reduce them to a minimum and it must put itself at the disposal of those concerned to furnish them with all information which may be of use.

XXIV Housing

The Organizing Committee of the Olympic Games must provide the athletes with furnished quarters and food at an inclusive price per head per day which must be previously fixed. All expenses must be borne by the countries taking part

who also must be responsible for any damage done by their teams.

XXV Attachés

In order to facilitate arrangements between the Organizing Committee and the representatives of each nation the Organizing Committee shall appoint an "Attaché" to each country. This attaché must know the language of the country to which he is attached.

This attaché should be appointed by agreement between the Organizing Committee and the country concerned.

The attaché thus chosen must get in touch with the Organizing Committee at least six months before the opening of the Games.

The duties of each attaché under the control of the Organizing Committee are as follows:

- a) To see to the proper organization of traveling arrangements for the teams.
- b) To help to arrange the voyage of the teams.
- c) To help in the housing arrangements.
- d) To act as intermediary between the Organizing Committee and the country to which he is attached in any claim or request, whether individual or collective, of an administrative nature.
- e) To examine these requests and claims and, if they are recognized as being well-founded, to pass them on to the Organizing Committee.
- f) To distribute cards and invitations given out by the Organizing Committee and to transmit to this Committee all applications relative to this subject.
- g) To act as intermediary for the Organizing Committee in all cases having to do with the housing and feeding of the officials and competitors.

XXVI Reserved Seats

Apart from the big stand reserved for the Press, invitation cards must be sent out by the Organizing Committee and places reserved in the Stadium as follows:

- Stand A For Members of the International Olympic Committee and their families.
- Stand B For the Presidents of the National Olympic Committees and the Presidents of the International Federations and their families.
- Stand C For Members of the National Olympic Committees and their guests—one ticket to be allotted for every ten athletes competing with a maximum of twenty and a minimum of four. For the official delegate of each sport in which a country is represented.

For Secretaries of International Federations.

For Members of Committees of the Organizing Country.

Stand D For Members of the various Juries.

Also 1500 places for athletes near the winning posts.

In the other stadia:

Places for the Press and occupants of Stands A and B. One stand to which shall be admitted, so far as the places will allow, the occupants of Stands C and D. Places for the Competitors in the sport which is then taking place, but not for other Competitors.

N B—Requests must be made thru the attache of each country. Requests for special invitations must be made in the same way.

XXVII *The Taking of Photographs and Cinematograph-Pictures*

The organizing Committee must make the necessary arrangements for making the record of the Games by means of photography and moving pictures, but must organize and limit these services in such a way they do not interfere with the conduct of the Games.

XXVIII *Special Cases*

Any cases not provided for by the existing rules must be dealt with by the Organizing Committee.

XXIX *Official Text*

In case of divergence in the interpretation of the general rules, the French text only is official.*

*The English version printed in this report is the official I O C translation of the French original.



III Olympic Winter Games display at the transportation exhibit, Grand Central station, New York city

History of Olympic Winter Games

The modern Olympic Games are the revival of an ancient and honored tradition—in fact, one so ancient that it goes back to the days of Greece's glittering glory, when the Greeks, beginning in 776 B C, were wont to assemble every four years at Olympia and, with religious and athletic ceremonies, render homage to their great god Zeus.

In the Golden Age of Greece the Games continued for seven days and comprised not merely the athletic games which we celebrate today, but also a religious festival, one of the greatest national gatherings of the Greeks and one of the rare periods when a universal truce reigned.

The ancient Olympic Games have been justly called "The single greatest unifying force in the essentially Greek period of world history."

With the coming of medieval civilization to Europe the Games were abandoned in 293 A D, but the classic competitions were eventually revived at Athens in 1896. These modern Games owe their existence to Baron Pierre de Coubertin, a Frenchman, now living at Lausanne, who was fundamentally interested in sport for its moral, physical, and social benefits to the individual, the nation, and the world at large.

The Summer Olympic Games, centering about the track and field events, date from the First Olympiad, celebrated at Athens in 1896. Except in 1916 during the World War, the Games have been held every four years since that date.

The year and place of holding the Summer Olympic Games follow:

I	Athens	1896
II	Paris	1900
III	St Louis	1904
IV	London	1908
V	Stockholm	1912
*VI	Berlin	1916
VII	Antwerp	1920
VIII	Paris	1924
IX	Amsterdam	1928
X	Los Angeles	1932
XI	Berlin	1936

* Not held on account of the World War.

Organization of Olympic Games

A word now as to the threefold organization of the Olympic Games. The supreme authority is the International Olympic Committee, a self-perpetuating autocratic body with from one to three members for each country. This body determines when the Games shall be held, where they shall be held, and which sports (but not which individual events) shall be included in the program, as well as the general non-technical rules under which the Games are conducted.

The International Federation governing each field of sport determines the technical rules and conduct of that sport and the individual events to be held. A sport which is not yet governed by an international federation may appear on the Olympic program only as a demonstration. In the winter sports program four international federations covered the major fields of winter sports—skiing, skating, hockey, and bobsleighting.

The national Olympic committees forming the third side of the triangle are responsible in each Olympiad for all details of the participation of their own country in the Olympic Games. Once in a generation or in a lifetime they may be responsible, either directly or thru organizing committees, for the organization and conduct of an Olympiad held in their own country. The national Olympic committee of the United States is the American Olympic Association, whose executive committee constitutes the American Olympic Committee.

The Olympic Games, summer or winter, are awarded directly to a particular community by the International Olympic Committee and must be held in their entirety in or near that community. The country receiving the Summer Games which are generally awarded first, has a preference in the award of the Winter Games if qualified by climate, terrain, and experience to hold them successfully.

Winter Sports on Olympic Program

Following continued agitation on the part of prominent European sportsmen for the inclusion of winter sports in the Olympic program, Olympic Winter Games were first held under the auspices of the International Olympic Committee at Chamonix, France, in the winter of 1924. They were so successful that in the following year they were designated as the I Olympic Winter Games. The Olympic Winter Games are now an integral part of the Olympic program, under the supervision of the International Olympic Committee.

The II Olympic Winter Games were staged at St Moritz, Switzerland, in 1928 and showed a continued development along the lines of the pattern so successfully laid down at Chamonix.

At the Chamonix Games domination of the Scandinavian nations was practically complete, altho Charles Jewtraw of Lake Placid, U S A, took first place in the 500-meter speed-skating race, Miss Beatrix Loughran, U S A, placed second in the

women's figure-skating, and the United States team took second-place honors in the hockey competition.

At St Moritz, Irving Jaffee, U S A, was the winner of the uncompleted 10,000-meter speed-skating race, J Heaton and J R Heaton, U S A, took first and second in the skeleton races, and William Fiske and J R Heaton won first and second in the bobsleigh competitions.

Winter sports progress rapidly in the United States during the four-year period following the St Moritz Games. At Lake Placid in 1932 the United States as host nation and with the largest team entered took six out of 14 first places on the table of honor. It is interesting to note, incidentally, that three of these six firsts were won by residents of Lake Placid, a resort of less than 4,000 permanent population. The United States is still well behind European nations in the ski events.

The 1932 Summer Games of the Xth Olympiad will be held in Los Angeles, California, July 30 to August 14.



Cars parkt at the entrance to the Mt Van Hoevenberg bob-run

—Pierson Studio

History of Winter Sports at Lake Placid

Back of the III Olympic Winter Games, which crowned Lake Placid as the winter-sports capital of America, lies over a quarter century of successful experience in promoting and staging the sports of snow and ice.

While winter sports have been the accepted thing in Europe for about fifty years, it was not until shortly after the turn of the century that Americans in any number began to realize that snow was good for something besides snowballs for the children. Lake Placid was the pioneer American resort in popularizing snow and in presenting its winter attractions to the public. Today Lake Placid suggests winter sports, and winter sports suggest Lake Placid. The two are synonymous.

Altho favored by Nature with a climate and terrain ideally suited for winter diversion, it was several decades after Lake Placid had won world renown as a summer resort that any one so much as thought of finding sport or recreation in its mountain fastnesses in winter. Outdoor sports from Christmas to March were unheard of.

Lake Placid is situated in Essex county, New York state, in the heart of the famous Adirondack forest preserve at an altitude of 2,000 feet above the sea. The village itself lies along the shores of two of the gems among Adirondack waters, Lakes Mirror and Placid. Surrounding the village and towering into the sky like great spires are the highest mountain peaks in the state, Tahawus (Mt Marcy), McIntyre, Haystack, Colden, and Whiteface.

Lake Placid's winter season normally lasts from early December until late March. Zero temperatures are common. The air is clear and dry. Bright sunshine is plentiful. Snow and ice abound. Scenic effects surpass anything seen in summer. Couple all this to a peculiar tonic atmosphere and the fact that Lake Placid is only an overnight journey from New York and the other great cities of the Atlantic seaboard and you have an ideal setting for a winter-sports development. It is on this ideal natural setting that

Lake Placid has built its international reputation as a winter rendezvous for young and old, for the wealthy and those of lesser means.

How It All Came About

The beginning was modest. 27 years ago, in 1905, officials of the Lake Placid Club decided to keep one small club-house open all winter. A few hardy souls tried the Adirondack snow and found it good. They even found it enjoyable and hastened to tell their friends of their discovery. More came the next year—still more the year after. And so the annual winter hegira to the snow-covered peaks and forest trails of the Adirondacks began. Today the community of Lake Placid plays host each winter to thousands. At the peak of the winter season many Lake Placid clubs and hotels have as large house counts as at any time during the summer.

Organized effort was necessary, however, in order to provide winter guests with things to do and things to watch. People had almost literally to be taught how to enjoy winter, and they had to be given facilities with which to make that enjoyment complete. Therefore the development of winter-sports facilities at Lake Placid paralleled the development of Lake Placid as a resort.

But it was a far cry from what was available 27 years ago to the physical lay-out in use during the III Olympic Winter Games—facilities that represent an investment of practically three-quarters of a million dollars—and all this in 27 years. In the early days Lake Placid Club guests cleaned and scraped their own skating rinks after horse-drawn plows had pushed aside the heaviest snow. Now tractor plows and scrapers do the job. Certainly the American winter-sports infant proved to be a lusty youngster.

Skating a Pioneer Sport

With two lakes in the village door-yard it was but natural that ice sports should have found favor with Lake Placid residents in the early days. Skating on Mirror lake and

Lake Placid was indulged in until the deep snows of winter made it impracticable. Later, rinks were cleared. The youngsters played "shinny" and skated, and the older folk skated. Yet few people then came to Lake Placid to skate. Local residents were practically the only ones to enjoy the sport.

But the interest in speed-skating grew rapidly. Lake Placid boys entered in the eastern meets gave signs of becoming ice stars. Finally a group of local sports enthusiasts formed the Lake Placid Skating Association, staged several informal races, and, a few years later, in 1918, held the Eastern Skating Championships on an eight-lap track on Mirror lake. This was the first sanctioned speed-skating meet ever held in Lake Placid.

Championships a Success

The Eastern Championships proved a distinct success, and the Lake Placid Skating Association went on to promote other meets, and during the ensuing years staged at Lake Placid the North American Championships (originally called the International Championships), the National Championships, and Diamond Trophy meets. The Skating Association also promoted a series of match races in Lake Placid and Saranac Lake in February, 1926, between Charles Jewtraw of Lake Placid, U S A, and Clas Thunberg of Finland. Both Jewtraw and Thunberg were Olympic winners at Chamonix in 1924.

The following were the North American distances for speed skating: 220-yard, one-sixth mile, 44-yard, half-mile, three-quarter mile, one-mile, two-mile, three-mile, and five-mile. Ice fans from all over the United States and Canada came to Lake Placid to watch these races. Eventually all race meets were staged on an official six-lap track. Races were held on Mirror lake until the winter of 1930-31, when they were transferred to the new Olympic stadium.

In tracing the history of speed-skating at Lake Placid it is interesting to note that a majority of the present amateur speed-skating records at the North American championship distances were made on the Lake Placid tracks.

Their enthusiasm fired by the deeds of Edmund Lamy, famous Saranac Lake star of those days, "Bobby" McLean, and others, Lake Placid boys took to the ice in droves.

Out of this group were developed two North American champions, Charles Jewtraw, and John Amos (Jack) Shea. Jewtraw was the first winner of an Olympic Winter Games event. He defeated the greatest skaters of the world to take the 500-meter race in the I Olympic Winter Games at Chamonix, France, in 1924. Jewtraw's international fame as a speed-skater did much to bring Lake Placid's winter reputation to the fore.

The present generation of Lake Placid ice fliers has not lagged behind the earlier, for Jack Shea, the other Lake Placid boy, who learned to skate on Mirror lake and who was twice North American title-holder, broke all Olympic records by taking both the 500 and 1500-meter speed-skating events in the III Olympic Winter Games at Lake Placid in February, 1932.

Today speed-skating is firmly established as one of the favorite winter sports at Lake Placid.

Figure-skating has been indulged in for many years by Lake Placid Club guests on flooded tennis courts in the rear of the main winter club-house. It was, however, the building of the Olympic arena on Main street of the village this year that stirred interest in this sport, or art, as it might better be called, to the highest pitch. Some of the greatest crowds of the Olympics thronged the arena to see such champions as Sonja Henie of Norway, Karl Schäfer of Austria, and the Brunets of France in action.

Figure-skating is now an essential part of the winter recreational program at Lake Placid. Its popularity will increase with the years. Facilities for its enjoyment are unsurpassed.

Skiing Appeals to Thousands

In the early years at Lake Placid snowshoes were the accepted means of travel in the woods in winter, a heritage from the Indians who for centuries roamed the surrounding mountains. Then winter guests

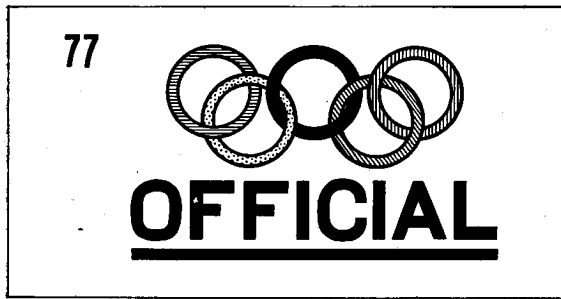

Automobile windshield sticker

soon found that it was good sport to get out on the forest trails on the webbed shoes of ash and rawhide. Skis became popular later, and now have almost entirely supplanted the snowshoe. The Lake Placid terrain is excellent for ski-running. Today practically every one in Lake Placid who can walk, whether guest or permanent resident, owns a pair of skis.

Organized ski competitions in Lake Placid began February 21, 1921, when the Lake Placid Club held its first jumping meet on the original Intervales hill southeast of the village. Ski-jumping, even in those days, appealed mightily to the winter-sports enthusiast. 3,000 people attended this first meet. The most blasé found a new thrill in seeing man play bird and disport himself far aloft in a strange element.

The original Intervales hill, completed in 1921, was about a 35-meter jump. It was built at a cost of \$1,700.

Intervales in 1927 was made into a 60-meter jump, generally recognized as one of the technically perfect hills of the world. Many of the outstanding ski meets of the United States are held at Intervales. Thousands of spectators attend. Ski-jumping is now accepted as a prime factor in Lake Placid's annual winter-sports schedule.

While ski-running had been enjoyed for several years, organized cross-country ski-racing was started February 22, 1921, with the Club sponsoring the first ski race ever held in the Adirondacks. The distance was four miles or approximately 6½ kilometers. Now 18 and 50-kilometer races are held annually, with star performers from the United States and abroad competing.

Hockey to the Fore

While for two decades or more the crack of stick against puck resounded over the frozen surface of Mirror lake, it has been only during the past six or seven years that this great winter game has come to have the wide appeal that it enjoys today. Until the completion of the Olympic stadium during the winter of 1930-31, all hockey games were played on Mirror lake. Now most of the winter schedule is played in the Olympic arena, where excellent ice is assured regardless of weather conditions, and the spectators can watch the action in comfort.

The Lake Placid Athletic Club, which was organized during the winter of 1926-27, began to promote hockey in earnest the following year. It brings each winter the leading amateur sextets of the United States and Canada to Lake Placid. This village is annually represented by a powerful team which has won both state and Adirondack championships, and which in 1932 was runner-up for the National A A U crown. The youngsters, even in the grades and in high school, play hockey, and the oldsters watch it. Hockey in Lake Placid is proving as popular as in other parts of this country and in Europe. As a winter team sport it today stands alone.

During the Lake Placid Games last February, for the first time in Winter Olympic history, hockey contests were played indoors, the new Olympic arena making the games on the program independent of variable weather.

Bobsledding the Newest Sport

Bobsledding is America's newest and most thrilling winter sport. The largest crowd of the III Olympic Winter Games, 14,000, watched the four-man racing on one morning at the Mt Van Hoevenberg bob-run.

Here is another winter sport imported from Europe and started on its way to American fame by Lake Placid. Officers of Lake Placid Club, when the idea of staging the III Olympic Winter Games in Lake Placid was first broached, recognized that because of litigation the proposed Olympic run could not be completed two years in advance of

the Games and impressed by the popularity of such 'foreign bob-runs as those at St Moritz, Davos, and Schreiberhau, saw the necessity of building a run at once. They pointed out that it was an American team piloted by William (Billy) Fiske, a resident of Europe for several years, that won first place for the United States at the II Olympic Winter Games at St Moritz in 1928, even though at the time there was not a single bob-run on the entire North American continent. They pointed out, too, the necessity of training American workmen in the difficult and wholly unfamiliar technique of maintaining a bob-run under Adirondack winter weather conditions, testing the design of American-built bobs, and training additional drivers if the United States could hope to compete with European teams.

As a result, during the fall of 1929 down a steep hill near Intervales ski-jump the Club built the first technically-engineered bob-run in the western hemisphere. The winner of the Olympic two-man title and second-place winner in the four-man bob, with their crews, received their initial training on the Intervales slide. Compared with the great Olympic slide on Mt Van Hoevenberg this first run today does not seem so thrilling, but when it was opened huge crowds were aghast at the speed with which the sleds shot round the dangerous curves. And these same curves were dangerous at racing speeds. During the first and only season of the run's operation, the slide had its quota of accidents. In fact one team was prevented from competing in the finals of an international race because in hitting the last curve, the sled turned turtle, throwing the entire team down into the middle of the track and sending two members to the hospital.

From the time the first sled went down the Intervales slide, interest in the bob sport among Lake Placid residents and visitors began to develop. Crowds waited to ride, and crowds thronged the vantage points along the run to watch others ride. The judgment of those who built the run and prophesied its popularity was vindicated many times over.

How swift was the development of the

sport of bobbing in Lake Placid! The next year a Saranac Lake team on the Mt Van Hoevenberg slide set up a world's speed record for a recognized major bob-run of 77 kilometers an hour. The second year following, a Lake Placid team won the Olympic two-man championship, while the same record-holding Saranac Lake team finished second in the Olympic four-man event.

Data concerning this first bob-run in Lake Placid will be of interest to those tracing the development of organized winter sports in the United States. Intervales bob-run, as it was called, was designed by the same engineer who later laid out the Mt Van Hoevenberg Olympic slide, Stanislaus Zentzytzki of Berlin. It was approximately a half mile in length, had an average grade of from seven to eight per cent, was laid out with seven curves, and cost \$6,600. Although engineered as carefully as a major run, the construction was of the simplest, sand and wood being used to build the curves, which were covered with snow and ice for sliding.

The first bobsled race ever held in the United States was staged at the Intervales run on January 22, 1930. Competing teams represented Lake Placid Club and Lake Placid Athletic Club from the village. On February 8, 1930, the first international bobsled competition in the western hemisphere was run off, teams from Canada and the United States taking part.

Construction of Olympic Run Begins

With the award of the III Olympic Winter Games in April, 1929, necessitating the construction of a championship slide, work on the great Mt Van Hoevenberg Olympic run was begun August 4, 1930.

On Christmas Day, that same year, the run was opened to the public. It was in constant use all that winter and exceeded in popularity the most sanguine hopes of its sponsors. Between Christmas Day and March 1, 1931, when the run was closed for the season, 1,974 different persons rode the slide, and 4,680 individual rides were taken.

Two major racing competitions were held on the Mt Van Hoevenberg run during the



Sticker stamps printed in English, French, German, and Spanish

winter of 1930-31, the North American and A A U championships on February 6 and 7, 1931, and the Lake Placid A C Novice Invitation tournament on February 23. There was a large attendance at both events and good entry lists.

So bobsledding was established as the American winter sport supreme, with its only headquarters at Lake Placid. The rest of the story is Olympic history and is treated in detail in the section devoted to that sport in the III Olympic Winter Games.

Organization Necessary

While the history of winter sports at Lake Placid may make easy reading and give the impression that the task of promoting them was easy, it must be pointed out here with the greatest emphasis that only untiring work and effective organization made possible the steady growth of these activities in Lake Placid—a growth which reached its culmination in the III Olympic Winter Games of this year.

Four organizations played a major part in this winter-sports development at Lake Placid: the Lake Placid Club, the Lake Placid Skating Association; its successor, the Lake Placid Athletic Club; and the Sno Birds of Lake Placid Club.

The true pioneer in winter-sports promotion in Lake Placid was Lake Placid Club. As has been pointed out organized winter sports were initiated at the Club in 1905 when one of the Club's houses was kept open all winter, and a few adventurous souls remained thru the season to see just what an Adirondack winter was like. Each winter the group increased in size. In 1920 it was felt that still further organization would

help the cause, and the Sno Birds' group was formed. The first formal winter-sports event sponsored by this group was staged at Lake Placid Club on December 25, 1920. On December 24, 1921, the Sno Birds further perfected their organization by incorporation. The Sno Birds have continued to function with increasing effectiveness each year since that time. Beginning in 1920-21, sports directors have been employed each winter to organize and supervise the various outdoor activities. The first ski instructor was engaged for the winter of 1921-22, and one has been on duty each winter since that time. A figure-skating instructor has been on duty every winter, starting in 1920. The Sno Birds have been active in ski-running and jumping, sled-dog racing, figure-skating and bobsledding.

They also actively support such winter activities as tobogganing, mountaineering on skis, and winter camping. Nowadays, due in large measure to their vision and indefatigable efforts, camping trips and mountain climbs are as popular in winter in Lake Placid as in summer, with resulting benefits to the health of all participating.

College Week, a sports carnival in which leading universities and colleges of the United States and Canada take part annually between Christmas and New Year's, was started at Lake Placid Club in 1921 and has been held each year since. This week is now generally looked upon in this country as marking the opening of the winter-sports season. This arousal of interest in winter sports in the colleges has been the means of spreading the gospel of winter far and wide.

As has been pointed out organization was necessary, or winter sports at Lake Placid

would probably have died at birth. The Lake Placid Skating Association was the first winter-sports body in Lake Placid village and devoted most of its efforts to the promotion of speed-skating competitions, in which this resort soon became a leader. In the winter of 1926-27, this organization was succeeded by the Lake Placid Athletic Club, which continued to promote skating, but in addition began to organize the ski activities and launched the L P A C hockey team.

While several enthusiasts had been enjoying skiing along Lake Placid forest trails for years, while other more hardy souls had even gone off the great Intervales ski-jump, it was the organization of cross-country ski parties by the Lake Placid Athletic Club, the building of 30 and 15-meter jumps in the village, the engagement of a paid winter-sports director, and the promotion of ski running and jumping among the children that finally brought the long boards to their present position as the major part of a Lake Placid winter devotee's sports equipment.

Sled-dog races for juniors and seniors have also been an important part of the Athletic Club's winter-sports activity.

Under the direction of this club visitors to the village in winter have been assured at all times of a comprehensive sports program ready for their participation and enjoyment. Speed-skating competitions, both senior and junior, have been promoted regularly by this body, and many of the blue-ribbon ice events of the North American continent have been staged in Lake Placid. In fact, more major championships have been held in Lake Placid or its neighboring village, Saranac Lake, or in the two combined than in the rest of the United States and all Canada together. The success which the Athletic Club had in the promotion of hockey and in raising it to its present position as one of the leading Adirondack winter sports, drawing its attendance from a wide Adirondack area, is told elsewhere in this section. The Lake Placid Athletic Club has 250 members.

Benefit to the health of men, women, and children from their participation in snow sports and recreation is after all the prime

reason for such participation. For too long in the United States winter meant a cessation of outdoor activity and the undoing of most of the benefits gained from an outdoor life in the summer. Today, largely because of the efforts of Lake Placid, winter in the snow belt of this country is permitted to play its beneficent part in building stronger minds in stronger bodies for all who embrace what it so lavishly offers.

Facilities for Other Sports Offered

While the major winter sports at Lake Placid have been ski running and jumping, speed-skating, figure-skating, hockey, and bobsledding, they by no means complete the list of what this resort can today offer those who revel in the sting of snow on cheeks made rosy by a clean, cold Adirondack wind.

Sled-dog racing has many devotees. Several of the leading race drivers of the country maintain their kennels in the village, from which their teams have gone out to win major prizes.

Excellent toboggan slides are numerous. Curlers find ideal provision for the ancient Scotch game in the Olympic arena. And the ski trails call to the hiker, the amateur skier, and the cross-country racer with equal insistence.

A Resultful History

This brief look backward over the quarter century immediately preceding the III Olympic Winter Games may serve to show in some small measure just what Lake Placid has accomplished in the field of winter sports and recreation.

Only this accomplishment, in which so many took part, made possible the award of the III Olympic Winter Games to Lake Placid. Without this background of successful experience and without the sports facilities already in actual operation, the invitation of this Adirondack resort community to the nations of the world to assemble here in February, 1932, for the celebration of the III Olympic Winter Games would not have been extended or could not have been accepted.

How III Olympic Winter Games Were Awarded to Lake Placid

Late in 1927, the year before the II Olympic Winter Games were staged at St Moritz, Switzerland, members of the American Olympic Committee inquired unofficially as to whether Lake Placid would be in a position to hold the III Olympic Winter Games if they were awarded to the United States.

Local sports leaders naturally were pleased at the implied compliment to Lake Placid's standing as a winter resort but replied without hesitation that they would not even consider holding the Games unless thoroughly convinced that they could meet the highest standards set abroad for Winter Olympic competitions.

Early in 1928, Dr Godfrey Dewey of Lake Placid Club, himself an ardent and capable winter sportsman, made a special trip abroad for the express purpose of studying the conditions at prominent European winter resorts, including Chamonix in France; Caux and Gstaad in the Vaud Alps; Grindelwald and Mürren in the Bernese Oberland; Engelberg and Arosa in central Switzerland; and Davos and St Moritz in the Engadine.

He went to St Moritz that same year as leader of the United States ski team at the II Olympic Winter Games. In addition to performing his official duties, Dr Dewey made a careful study of the entire Games program at the Swiss resort. This included an analysis of the nations represented and the sports in which they took part; housing accommodations; the financial budget; Olympic facilities; the Games organization, including the various committees; health and safety measures; policing; and supervision of the Olympic sports—in fact everything that would enable him to project an accurate picture of a Winter Olympic program to report to Lake Placid on his return.

Dr Dewey's conclusions were that in those essential factors which money could not buy, such as winter climate, terrain, and especially long and successful experience in the conduct

of winter sports, Lake Placid could not only hold the Games but could match the highest standards set abroad. Additional facilities and other things necessary for the conduct of the Olympics he felt certain could be provided by money and organization.

Enthusiasm Stirs Community

Returning to Lake Placid fired with enthusiasm as to the opportunity that would be Lake Placid's if this resort could secure the III Olympic Winter Games, Dr Dewey immediately set about convincing the community that it could bid for the great international winter-sports classic. He had already worked out a preliminary plan for staging the Games in Lake Placid.

At first, and naturally, too, many residents were aghast that there was even a possibility of this little mountain resort of less than 4,000 population entertaining the winter-sports world in 1932. The responsibility seemed too heavy; the task too great. But there were those who saw the vision at once, even as Dr Dewey did, and immediately set about helping him to convince others. To hear him tell of what St Moritz had done and what Lake Placid could do was to be anxious to start doing it.

Dr Dewey delivered his first public address on the III Olympic Winter Games before the Lake Placid Kiwanis Club on March 21, 1928.

Two days later a joint meeting of the directors of the Lake Placid Chamber of Commerce, the Kiwanis Club, and the Village Board was called, to consider initial steps to be taken in bidding for the Games.

"Housing is the biggest question for Lake Placid to settle," said Dr Dewey in speaking to the Kiwanis Club, "the matter of sports facilities being practically satisfactory now." He then went on to say that Lake Placid had one of the finest ski-jumps in the world and an excellent system of ski trails, together with plenty of natural ice for speed-skating,

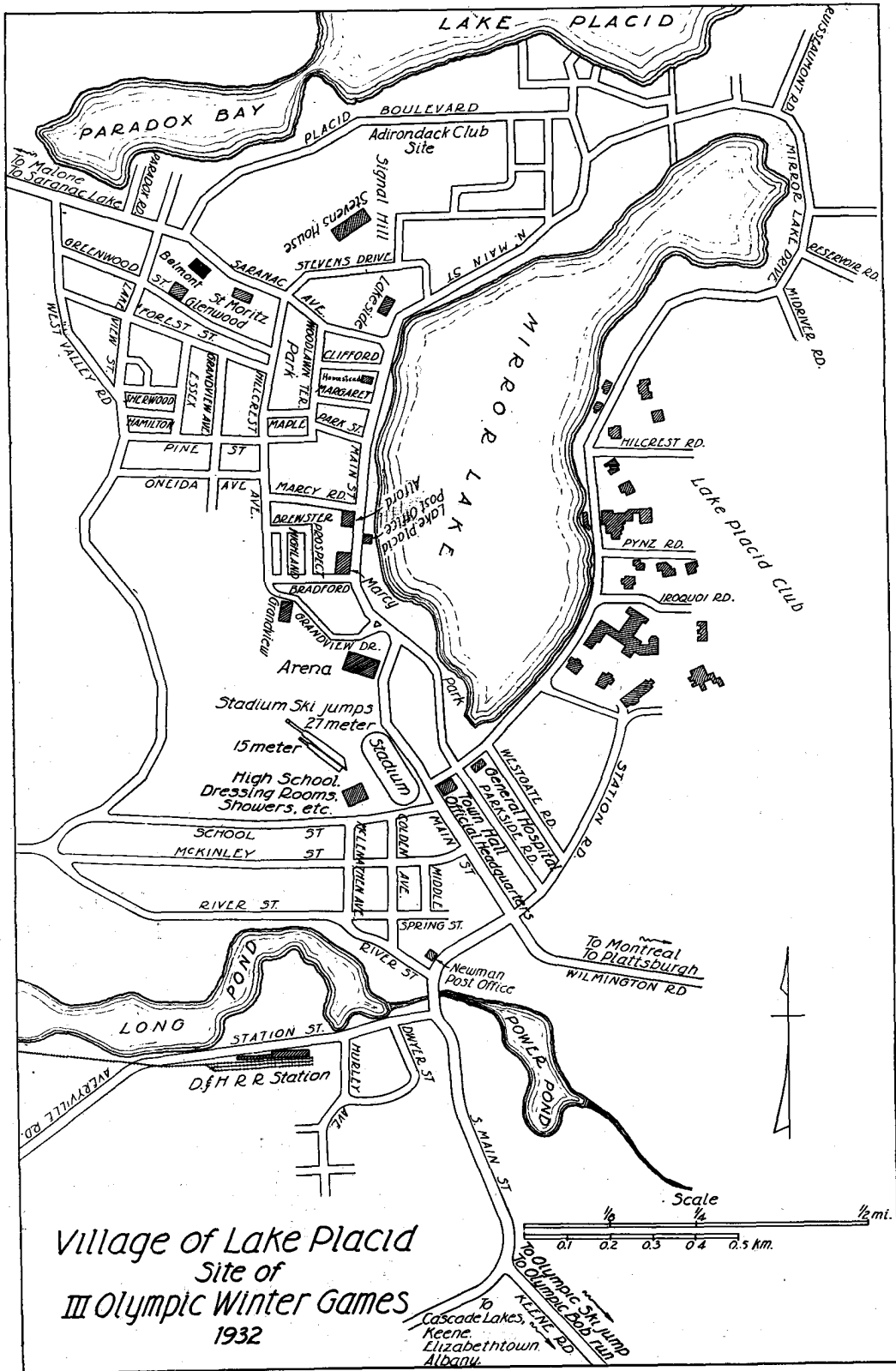

Map of Lake Placid village

hockey, and figure-skating. He pointed out, however, that facilities for bobsledding would have to be developed in order to put Lake Placid on a par with European winter resorts.

“Lake Placid’s quarter century of successful experience in promoting winter sports is its greatest asset in bidding for the Games,” Dr Dewey said.

Temporary Committee Named

At the joint meeting of village civic groups a temporary Olympic committee was formed, to consider initial steps in preparing a bid for the III Olympic Winter Games of 1932. Members of this original Olympic body were Julian J Reiss, then president of the Chamber of Commerce; Godfrey Dewey of Lake Placid Club; Willis Wells, supervisor of the Town of North Elba; F B Guild, president of the Bank of Lake Placid; and William Burdet, prominent Lake Placid business man and a sportsman who had spent many years at leading European winter resorts.

Voted to Bid for Games

At a meeting of the Lake Placid Chamber of Commerce held at the Hotel Marcy on the evening of April 3, 1928, the chamber voted to pledge its efforts and resources to securing the III Olympic Winter Games of 1932 for Lake Placid. This meeting was marked by a record attendance, which indicated the interest the Games had already aroused.

Dr Dewey in his address to the chamber that evening contrasted Lake Placid with European winter resorts and pointed out that the possibilities for the further promotion of winter sports here were unsurpassed. He expressed the conviction that it was entirely feasible to develop at least a six to eight-weeks winter season in Lake Placid comparable to that enjoyed by leading French and Swiss resorts.

Preliminary Report Made

At this Chamber of Commerce meeting on April 3, 1928, the original Olympic committee presented its report on what it con-

sidered to be the amount of money necessary to finance the Olympic program. The necessity of a bob-run in order to have Lake Placid’s bid for the Games receive serious consideration from ‘the International Olympic Committee was pointed out. Further study of the initial financial picture was urged. Various pledges of co-operation were given by visitors from Saranac Lake and representative hotel and business men of Lake Placid. The Olympic movement was now fairly launched, backed by the Chamber of Commerce, with other local bodies co-operating.

During this period Dr Dewey explained the Olympic project to such organizations as the North Elba Town Board, the Lake Placid Village Board, the Woman’s Club, the Board of Education, the Kiwanis Club, and the Lake Placid Athletic Club. These quickly followed the chamber’s lead, endorsed the project, and voted support.

It was the feeling in Lake Placid that what St Moritz could do Lake Placid could do. This was the start, but it was a long and frequently discouraging journey to February 4, 1932, nearly four years later, when the Games actually opened in the Olympic stadium in Lake Placid.

During the late spring and early summer of 1928 Dr Dewey outlined before Lake Placid civic and fraternal organizations and in various Adirondack communities the preliminary plans for securing the Games. Support for the Olympic project was evinced wherever he spoke. The problem at this time appeared to be this—how to translate this vision of Dr Dewey’s into stern reality, a reality fitted to the community’s pocket-book and general resources.

Not alone was it necessary to “sell” the Games project, that is the idea that Lake Placid could actually stage these international competitions, to the entire community of Lake Placid; surrounding communities had to be brought into the Olympic picture. The Town of North Elba in which Lake Placid is situated, the County of Essex, and even the State of New York all had to be persuaded to do their part. The burden was

far too heavy for the village of Lake Placid acting alone.

So Dr Dewey spread the Winter Olympic gospel far and wide, speaking before northern New York Kiwanis Clubs, Rotary Clubs, Chambers of Commerce and similar organizations. He discussed the Games with Governor Roosevelt, with prominent New York business men, and with Adirondack civic leaders; and he initiated negotiations with legislative leaders at Albany, seeking the support of New York state in Lake Placid's proposal to bid for the III Olympic Winter Games.

In July, 1928, directors of the Lake Placid Chamber of Commerce appointed a committee to solicit a guarantee fund of \$50,000 to accompany Lake Placid's bid for the III Olympic Winter Games. This committee consisted of Willis Wells, town supervisor, and the following Lake Placid business men: Julian J Reiss, Rollie J Kennedy, William E Hovey, William McDonald, John F White, and Frank S Leonard. The guarantee fund was quickly subscribed.

Preliminary work continued during the summer and fall of 1928.

Housing Problem Studied

On Wednesday, January 2, 1929, a special committee was appointed by John F White, then president of the Kiwanis Club, to look into the matter of the housing of visitors and contestants at the time of the Games. At this period the housing problem loomed large on the horizon. Appointed on this special Kiwanis committee were Judge T A Leahy, Judge W R Wikoff, Dr George C Owens, Supervisor Willis Wells, C A Thornton, and J Hubert Stevens.

Agitation for the building of a bob-sled run in Lake Placid was renewed with increasing force.

Much joy was brought to Lake Placid by the announcement that on Monday, January 14, 1929, both houses of the New York legislature passed by unanimous consent a concurrent resolution inviting the International Olympic Committee to designate Lake Placid in New York State as the place for holding

the III Olympic Winter Games of 1932, and pledging support to Lake Placid in its ambitious project. From this time on the burden was to be not Lake Placid's alone. The State of New York was to share in the great responsibility that the Games might entail.

The concurrent legislative resolution was passed following conferences arranged by Dr Dewey with Governor Roosevelt and leading state legislators.

At this time it was learned that California, which had already been awarded the Summer Games of the Xth Olympiad, was anxious to secure the award of the 1932 Winter Games as well and that state funds totalling \$1,000,000 had been voted for the 1932 Olympic Games. The report of California's desire to stage the III Olympic Winter Games of 1932 doubtless helped spur New York State legislators into further activity in behalf of the state and Lake Placid.

The text of the concurrent resolution, the first Olympic legislation passed at Albany, follows:

"Whereas the Olympic Games to be held in the summer of 1932 have been awarded to the city of Los Angeles, California, and the Olympic Winter Games of 1932 are shortly to be awarded by the International Olympic Committee, and

"Whereas Lake Placid in the Adirondacks offers more complete and adequate facilities and longer and more successful experience in the holding of winter sports than any other community in the United States, and

"Whereas the Olympic winter sports are an inspiration and encouragement to the most wholesome and invigorating type of outdoor winter recreation for the whole people, now therefore,

"Be it resolved, (if the Senate concur) that the Legislature of the State of New York approves the efforts of Lake Placid to secure the award of the Olympic Winter Games of 1932 and commends to the favorable consideration of the International Olympic Committee the invitation of Lake Placid to hold these games and assures the International Olympic Committee of the co-operation of the State of New York to make the Olympic Winter Games of 1932 an inspiring success,

"Be it further resolved that a copy of this resolution be transmitted forthwith to the President and Secretary of the International Olympic Committee."

Many Olympic Bills Past

During the 1929 session of the New York legislature several bills dealing with the Olympic project at Lake Placid were introduced and past. Notable among these were two having to do with the construction of a bob-sled run by the State of New York either on state-owned land in the Adirondack park or on private lands over which the state might be given an easement. One of these bills contemplated an appropriation of \$75,000 for the construction of the bob-run and return road on state land on the western slope of the Sentinel range, a short distance from Lake Placid village.

This act never became operative, since subsequent court decisions made it impossible to build the bob-run on state-owned lands in the Adirondack park.

This, however, was not known at the time, and the entire community of Lake Placid was greatly heartened by the pledges of concrete co-operation given by the State of New York. It now became evident that Lake Placid would not have to bear alone the huge financial burden of staging the international sports classic in 1932 in case the award should be made to this resort.

As a matter of fact, legislation much more favorable to the conduct of the Games was past in 1930.

Saranac Lake Votes \$10,000

On January 29, 1929, Dr Dewey address the weekly meeting of the Saranac Lake Rotary Club and explained the project to secure the III Olympic Winter Games of 1932 for Lake Placid. He stated that Saranac Lake as one of the communities to benefit greatly from the Games should help Lake Placid in housing contestants and spectators and in every other way possible. So enthusiastic were his hearers that the meeting voted to pledge \$10,000 as Saranac Lake's contribution toward Olympic expenses. The actual pledges were quickly secured by a special committee appointed for the purpose.

Almost immediately a preliminary survey of the housing facilities in Saranac Lake and

adjoining communities was made, and it was found that ample accommodations could be provided there for both contestants and spectators.

Rumors persisted during February, 1929, that California would also stage the III Olympic Winter Games of 1932. These rumors of course were without foundation but did occasion considerable comment on the part of those who were working so hard to secure the contests for Lake Placid.

All during the early part of the winter of 1929 data were being collected to support to the limit Lake Placid's bid for the 1932 Olympic Winter Games, to be presented to the meeting of the International Olympic Committee which was at that time scheduled for Alexandria, Egypt, in April.

On February 22, 1929, Lake Placid's formal proposal was sent to members of the executive committee of the International Olympic Committee and to the presidents of the International Sports Federations. The proposal outlined Lake Placid's standing as a winter resort, its advantages in terrain, climate, and equipment, and formally invited the International Committee to name Lake Placid as the place for staging the III Olympic Winter Games of 1932.

Dewey Sails for Lausanne Meeting

In a last-minute shift the meeting of the International Olympic Committee was transferred to Lausanne, Switzerland.

At the urgent request and at the expense of the Lake Placid Chamber of Commerce, which had voted to send him to the meeting, Dr Dewey sailed from New York on March 29, to present Lake Placid's proposal in person to the International Olympic Committee.

Games Awarded to Lake Placid

At the Lausanne meeting seven proposals were presented by United States resorts, and two others, one by Canada and one by Norway, awaited only the elimination of the United States proposals to be presented.

The list of the places bidding for the Games follows:

Lake Placid, New York
Yosemite Valley, California
Lake Tahoe, California
Bear Mountain, New York
Duluth, Minnesota
Minneapolis, Minnesota
Denver, Colorado

Awaited elimination of U S to bid:
Montreal, Canada
Oslo, Norway.

It is significant of the value placed on the award of the III Olympic Winter Games by other resorts that one of the most aggressively presented proposals, that from northern California, consisted essentially of the statement that they had the requisite climate and terrain and were prepared to spend anything up to \$3,000,000 to provide whatever facilities might be necessary.

On April 10, 1929, the International Olympic Committee unanimously awarded the III Olympic Winter Games of 1932 to Lake Placid.

The award was made to Lake Placid because of its pre-eminent standing as a winter sports resort, its climate and terrain, its existing sports facilities, its experience in staging winter sports, and its guarantee that the additional facilities necessary for the conduct of the Games would be provided.

Lake Placid already had one of the finest ski-jumps in the world, miles of cross-country ski trails, and excellent facilities for speed-skating, figure-skating, and hockey. Lake Placid was known as one of the outstanding speed-

skating and skiing centers of America. It was necessary to guarantee a bobsled run, and, if the International Federation of Bobsleigh and Tobogganing insisted, a separate skeleton run as well. The bob-run was assured by the action of the State of New York in voting funds for its construction while Dr Dewey was at the Lausanne meeting.

The news of the award was received at Lake Placid the next day with great enthusiasm, and the community eagerly awaited Dr Dewey's return for a detailed report of the meeting and the beginning of actual work on the stupendous project.



Pretty model poses by III Olympic Winter Games poster

**Proposal of Lake Placid in the
Adirondacks, New York, U S A
for the III Olympic Winter Games 1932**

To MM the International Olympic Committee

Lake Placid in the Adirondacks, represented by its mayor and trustees, with the co-operation of Lake Placid Club, represented by Godfrey Dewey, has the honor to submit the following proposal for the holding of the Third Olympic Winter Games in 1932.

Basis We are informed by various members of the International Olympic Committee that there is a recognized precedent that the Winter Games shall be awarded to the same country receiving the Summer Games provided that that country is qualified to handle them successfully. We assume that in awarding the Olympic Winter Games in accord with this precedent the I O C is primarily concerned to select the community best qualified to hold these games most successfully in accord with the high standard of the Olympic Games. We submit, therefore, a brief statement of the superior qualifications of Lake Placid for holding the Olympic Winter Games, beginning with those factors such as location, climate, and terrain, which money cannot buy; continuing with those factors such as winter sports facilities and organization, which can be successfully developed only by long experience in addition to the expenditure of ample funds; and including those factors such as housing, and financing, which are least difficult for the average community to provide.

Location Lake Placid is located in the northeastern United States, in the heart of the Adirondack mountains, only twelve hours from New York city. The railroad service is of the best, with direct thru trains both by night and by day. The regular round trip fare from New York to Lake Placid and return is only \$24.56, and still lower rates can undoubtedly be secured for the Olympic Games.

Climate The winter climate of the Lake Placid region is unusually dependable. Rarely is it necessary to postpone a major winter sports event even for a day. Repeatedly Lake Placid has been able to continue its snow and ice sports successfully while leading Canadian resorts such as Quebec or Montreal, 150 kilometers farther north but at a much lower altitude, have been compelled to curtail or abandon their winter sports program. Exhibit A herewith shows the mean maximum, and mean minimum temperatures, and snowfall for

the winter months, December, January, February, March for the past ten years.

Terrain Lake Placid lies at an elevation of 568 meters above sea level. The lowest points in the Lake Placid valley are above 500 meters a. s. l., the highest peaks surrounding the valley are above 1600 meters a. s. l. Exhibit B herewith shows by government maps the terrain surrounding Lake Placid for about 25 kilometers in every direction.

Winter Sports Facilities

Ski-jumping The Lake Placid Club ski-jumping hill offered for the Olympic Winter Games is the product of years of careful engineering study, proved by repeated practical use for major competitions, and perfected in every possible detail regardless of expense. It has been specially designed for championship competitions, in accord with the belief held by leading members of the International Ski Association that hills of excessive length should not be used for championship competition, but that an average jump of about 50 meters is most desirable. This requires of course a hill that shall be as perfect as possible for all jumps of from 40 meters to 60 meters, since it would seem impossible to predict in advance more closely than within 10 meters the length of jump to be expected in any particular competition.. To adapt this hill readily to varying snow conditions or different classes of competition, the take-off can be quickly extended about 3 meters which tends to lengthen the average jump about 10 meters, and there is also a junior starting platform about 6 meters below the summit which tends to shorten the average jump about 10 meters. Leading jumpers who have competed both here and abroad regard this hill as the most perfect of which they have knowledge for a jump of from 40 to 60 meters. As compared with the Olympic jump at St Moritz in 1928, this hill has an easier landing slope, especially for jumps of more than 50 meters; the jumper follows the hill more closely in his flight; and the relation of the upper hill to the lower hill is such as practically to preclude the danger of overjumping the lower hill. The hill slopes to the northeast, which in this climate is the most desirable exposure. Exhibit C herewith shows all essential details of construction both in profile and plan.

The stands already built on this hill are of a unique design accommodating 1,000 people, and so planned that 100 on either side can see the entire hill almost as well as from the usual judges' stand, while 400 on either side can see the entire,

lower hill from the most comfortable and advantageous location. In addition to these stands there is ample room along the sides and end of the out-run to construct for the Olympic Winter Games stands accommodating at least 2,000 more people with a complete view of the whole hill.

Ski-racing The surrounding country shown on Exhibit B is more wooded than open, with many kilometers of excellent ski trails which have been used for short and long ski races as well as for cross-country ski touring for many years. Differences of elevation of from 100 to 300 meters are readily obtainable along these trails, and if a *down-hill race* is desired there is at least one excellent trail giving a drop of 1,000 meters. Lake Placid Club is perhaps the only place in this country which has held regularly over a series of years long ski races of 40 kilometers or more. This means that there is ample opportunity to select proved courses of any desired length for the *Lung-lauf* or *Dauerlauf* or the *military patrol race*, and that the Club is thoroly experienst in the many details essential to the successful organization and conduct of such races. This year's program includes specifically both 18-kilometer and 50-kilometer races. See Exhibit Cc herewith.

Skijoring Skijoring has been an important winter sports feature here for many years. If it be desired to organize skijoring races, either as a demonstration or otherwise, in connection with the Third Olympic Winter Games, there is excellent opportunity to lay out a skijoring race course of any desired length on Mirror lake in full view of thousands of spectators.

Speed-skating Lake Placid has had more successful experience with outdoor speed-skating than any place on the American continent. A large majority of all the international (United States and Canada) outdoor speed-skating championships of the last twenty years have been held either at Lake Placid or the neighboring community of Saranac Lake or by the two communities jointly. The Olympic ice stadium hereafter described will provide an ice surface of not less than the dimensions of the *St Moritz* ice stadium, that is 70 x 180 meters, and the Lake Placid Club rink, hereafter referred to, also has ample space for a 400-meter track.

Figure-skating Figure-skating has long been an important feature at Lake Placid Club where sanctioned tournaments are held each year. The Club rink with an ice surface of 60 x 210 meters has every possible facility for producing the most perfect outdoor ice, including in addition to 'the usual cold water supply and hand brushes and

scrapers, hot water and steam, and power driven brushes, ice planers, snow plows, etc. The Olympic ice stadium will also, of course, provide excellent ice for any part of the figure-skating events which it may be desired to hold there.

Ice Hockey Ice hockey is an important and successful feature here. Leading college teams come annually to Lake Placid Club for pre-season practice during the Christmas holidays, and the Adirondack Hockey Association maintains a regular schedule of games on the Lake Placid rink thruout the winter. The Olympic ice stadium will provide one, two, or even three hockey boxes, as may be desired; and in addition either two or three hockey boxes are regularly maintained on the Lake Placid Club skating rink.

Curling If it be desired to add to the Third Olympic Winter Games the sport of curling which was a feature of the First Olympic Winter Games at Chamonix, 4 or more sheets or rinks will be provided, either in the Olympic ice stadium, or on the Lake Placid Club rink, or both, as may be desired.

Bobsleigh Coasting Lake Placid Club has maintained for many years straightaway iced slides for Canadian toboggans, similar to but longer and faster than the most famous Canadian toboggan slides of Montreal and Quebec. It is assumed, however, that such straightaway simple slides offer no basis for Olympic competition. So far as can be ascertained, no place either in the United States or Canada now possesses any bobsleigh run which is comparable with the leading European bob-runs. Lake Placid has, however, made a thoro engineering study last winter of the leading European bob runs at Chamonix and St Moritz, at Grindelwald, Mürren, Engelberg, and Davos, and several other places, and in the light of that study has selected an ideal location in the Lake Placid valley for building a bob-run based on the most successful European experience, with a vertical drop of about 200 meters as compared with 156 meters at Chamonix, or 130 meters at St Moritz; and at the request of the American Olympic Association the New York State Legislature has just authorized the construction, equipment, and maintenance of such a bob-run, at an estimated cost of \$75,000 in the event that the Third Olympic Winter Games are awarded to Lake Placid. See Exhibit D herewith.

Single-sled Coasting Single-sled coasting, whether skeleton or toboggan, was not a feature of the First Olympic Winter Games at Chamonix. The Cresta run at St Moritz built' especially for

skeletons is probably unique, so that contestants of other nations thruout the world have no opportunity to practise this sport save at that one spot. Single-sled coasting of various forms is, however, a feature on most bob-runs, and would seem to be an interesting and appropriate feature for the Olympic Winter Games. It is suggested, therefore, that if single-sled coasting be desired as a feature of the Third Olympic Winter Games, it be held on the Olympic bob-run, without restriction as to the exact form of sled. If the International Federation of Bobsleigh and Tobogganing desires a smoother, faster ice surface for the single-sled event, this can readily be provided by holding the single-sled event at the beginning of the Olympic period and re-icing the surface for the bobsleigh event to be held toward the close of the Olympic period.

The coasting events are the only ones for which Lake Placid is not already provided with facilities of the highest class, developed and tested by long and successful experience, and for these events no other community on the North American continent is better equipped, while Lake Placid has the advantages of a thorough study of the best European facilities, a favorable site, and the assurance that the New York State Legislature will co-operate to provide suitable and adequate facilities.

Dog-sled Racing The sport of dog-sled racing has become immensely popular both in the United States and Canada during recent years. If it be desired to add this sport to the Olympic program as a demonstration, like skijoring, Lake Placid Club which holds an annual dog-sled derby has most excellent facilities for the convenience of contestants and their teams and the conduct of the races, and can assure a representative entry list from the United States and Canada.

Ice Stadium For the Olympic ice stadium, for the opening and closing ceremonies and the principal ice sports, the parks and playgrounds of Lake Placid offer a uniquely favorable situation in the very heart of the community, immediately adjacent to the central school on the west and to the town hall on the east. The ice surface will be not less than the 70 x 180 meters which proved satisfactory at St Moritz. A terrace along the west side provides an ideal location for grandstand seats for 3,000 or more spectators, and additional thousands of standing spectators may be accommodated along the east side and on a steep natural slope which rises twenty meters high on the north-west.

The large, modern, central-school building with complete athletic facilities, separated from the ice

surface only by the width of the grandstand, will be utilized to provide warm dressing-rooms with hot and cold showers and toilet facilities for the maximum number of competitors, on a more comfortable and convenient scale than would be possible in the temporary structures usually provided.

Other Special Facilities Headquarters for the various officials and committees, and offices and increase telephone and telegraph facilities for the press, as well as meeting places for any Congresses of the International Sports Federations which may be held at the same time, will be provided in the town hall and central school, both of which are large modern buildings centrally located and immediately adjacent to the ice stadium. With regard to the various other facilities which must be provided specially for the Olympic Winter Games, such as organization of special police service, housing bureau, information bureaus, etc, Lake Placid is familiar with the nature and extent of the facilities provided by St Moritz for the Second Olympic Winter Games, and is prepared to provide all requisite similar facilities equally complete and well adapted to their purposes.

Housing The permanent population of Lake Placid is about the same as that of St Moritz, that is about 3,000 persons. The winter resort housing facilities of Lake Placid are less than St Moritz but greater than Chamonix. Lake Placid Club alone can house in winter 1,500. The hotels and boarding houses of Lake Placid can house in winter between 1,000 and 2,000, and private homes can house from 1,000 to 1,500 more. The neighboring village of Saranac Lake (permanent population 7,000; twenty minutes distant by train, with excellent railroad and motor bus facilities), can house in winter in addition to its normally occupied capacity from 1,000 to 1,500 additional. This means an available winter resort capacity for the Olympic Winter Games of from 4,500 to 6,500 beds, dependent on the extent to which summer facilities are winterized between now and 1932, plus a local resident population of 10,000.

Financing Lake Placid is familiar both with the estimated budget and with the actual expenses incurred and income received by St Moritz in connection with the Second Olympic Winter Games, and is prepared to finance the Third Olympic Winter Games on an equally sound basis, in accord with the general precedents governing the preceding games. To meet preliminary expenses or final deficits, and to assure the most successful holding of the games, the citizens and business interests of the local communities have already sub-

scribed a guarantee fund of \$50,000 for the use of the local Olympic Committee. As most of the Olympic sports facilities, including the Olympic ski-jump on which St Moritz was compelled to spend \$50,000, are already provided, and the Olympic bob-run, which is the only important facility lacking, will be provided by the State of New York at state expense, this guarantee fund should be even more ample and adequate than was the similar sum (250,000 gold francs) subscribed at St Moritz. In addition to all local organization and support Lake Placid offers also assurance of the co-operation of the State of New York as witness by Exhibit E herewith.

Experience Lake Placid Club has conducted an active winter-sports program for 24 years, including in later years an increasing number of major winter-sports competitions. Exhibit F herewith, a winter booklet distributed by the Club to its members, will help to suggest something of the nature and extent of these organized winter activities. In consequence, as cited by the New York State Legislature, "Lake Placid in the Adirondacks offers' more complete and adequate facilities, and longer and more successful experience in the hold-

ing of winter sports than any other community in the United States."

On the basis of the foregoing proposal, Lake Placid in the Adirondacks has the honor to solicit the award of the Third Olympic Winter Games in 1932, and pledges its good faith and full co-operation to make these games an inspiring success, in keeping with the highest standards and traditions of the Olympic Games.

In witness whereof, we, the Mayor and Trustees of the Village of Lake Placid, New York, U S A, and the Executive Vice-president of Lake Placid Co, representing Lake Placid Club, have hereunto set our hand this 22nd day of February, nineteen hundred and twenty-nine.

William E Feek
Mayor

Martin T Ryan
J Chester Jubin
Rufus Walton
Walter Kennedy

Trustees

Godfrey Dewey
*Executive Vice-president
Lake Placid Co*



—Pierson Studio

Front view of North Elba town hall. Headquarters of the III Olympic Winter Games Committee occupied the entire second floor of this building

Organization Following the Award of the Games to Lake Placid

Things began to move rapidly following Dr Dewey's return from the Lausanne meeting early in May, 1929.

On Tuesday evening, May 7, at Lake Placid Club, 400 prominent residents of the Adirondack section tendered him a testimonial dinner in recognition of his success in securing the award of the III Olympic Winter Games. It was the largest gathering of its kind in the history of Lake Placid.

The dinner was sponsored by the Lake Placid Athletic Club, the Lake Placid Chamber of Commerce, the Kiwanis Club of Lake Placid, and the Saranac Lake Sports Association. Hon James Shea was chairman of the committee in charge. Supervisor Willis Wells presided at the dinner and at the general meeting immediately following.

At this meeting Dr Dewey presented a detailed report of his work at Lausanne and outlined the next steps to be followed by Lake Placid in preparing for the Games.

To quote, from the *Lake Placid News* of Friday, May 10:

"From Lake Placid, from Saranac Lake, from Bloomingdale, Albany, St Regis Falls, Wilmington, Plattsburg, and the Valley towns, men and women gathered to show by their presence their appreciation of the efforts of Dr Dewey extending over a period of 16 months, often in the face of great difficulties, which finally resulted last month at Lausanne, Switzerland, in the International Olympic Committee naming Lake Placid as the scene of the next Olympic Winter Games."

Immediate steps were now taken to perfect the Olympic organization.

The tentative executive committee of the Lake Placid Organizing Committee was chosen, made up of representatives of the seven leading civic bodies of the community. Those chosen were:

Dr Godfrey Dewey, Lake Placid Club
Judge Thomas A Leahy, President,
Chamber of Commerce
Willis Wells, Supervisor, Town of
North Elba

Howard L Weaver, President, Lake
Placid Board of Education

Martin T Ryan, Mayor, Lake Placid Village

John F White, President, Kiwanis Club
William J O'Hare, President, Lake Placid
Athletic Club

As will be noted later it eventually became necessary to enlarge the executive body and to choose a general Organizing Committee for the Games, all with the approval of the American Olympic Association.

Site Favored for Stadium

On Monday, May 6, 1929, at a general meeting of civic groups, held in the North Elba town hall, the construction of the Olympic stadium on the high-school campus was favored, the stadium to be the scene of the opening and closing ceremonies of the Games, speed-skating races, hockey games, and the start and finish of other events on the Olympic program. This site for the stadium was considered excellent because of its location in front of the high-school building across from the town hall. It was planned to utilize space in the high school for dressing-rooms and headquarters for the Olympic athletes, while the principal Olympic executive offices, press rooms, and meeting rooms were to be in the town hall.

There was also considerable discussion as to the best means of raising the funds necessary for the construction of this Olympic stadium and for meeting various other expenses in the Olympic budget. It was the general feeling that funds for the Olympic budget should be raised by means of a bond issue of the North Elba park district, and that, prior to the submission of this bond issue to the voters, the executive committee should be asked to prepare a budget covering Olympic expenses.

On May 15, 1929, it was voted to recommend to the Town Board that the proposition

of raising \$200,000 by a bond issue for the Olympic stadium and other necessary Olympic expenses be put before the voters at an early date.

This recommendation was subsequently acted upon by the Town Board, and the election was called for June 4.

At this same meeting Dr Godfrey Dewey, the man who first conceived the idea of holding the Olympic Winter Games in Lake Placid and who worked literally night and day for the project, was chosen president of the III Olympic Winter Games Committee, and Willis Wells, supervisor of the Town of North Elba, was named vice-president.

\$200,000 Bond Issue Past

At the election, taxpayers of the North Elba parks and playgrounds district past the Olympic bond issue of \$200,000 by a vote in excess of five to one. This sign of such united support for the Olympic project on the part of the voters of the community was most encouraging to Olympic officials.

In the meantime Stanislaus Zentzytzki, famous European bob-run engineer, had arrived in Lake Placid to make preliminary surveys of sites for the Olympic bob-run, which under legislation past in March, would be built by the State of New York.

Up to this time Dr Dewey and others who had worked with him in studying possible sites for the bob-run felt that the most suitable was on state land on the west slope of the Sentinel range. Because of impending litigation an alternative site on Mt Jo on privately-owned land was also considered. A bit later, residents of Saranac Lake suggested building the run on Scarface mountain, midway between Lake Placid and Saranac Lake villages. Subsequent study and careful examination proved this to be the best site of the three, but it, too, was on state land, and, therefore, had one disadvantage of the Sentinel range location,

Late in June the Town Board named members of the North Elba Parks and Playgrounds Commission to supervise various Olympic activities in the park district. The members were:

R J Kennedy, chairman
Deo B Colburn, secretary
James Shea
B R Bull
William Lamb

Tentative approval of the III O W G committee and organization was given at a special meeting of the executive committee of the American Olympic Association, held in New York city on June 6, 1929. Final approval of the Lake Placid Organizing Committee as the responsible body in staging the III Olympic Winter Games was given at the quadrennial meeting of the American Olympic Association, held in Washington, D C, on November 19, 1930.

During the summer of 1929 Olympic activity continued on many fronts. No actual construction work was begun, however, because of litigation tying up bob-run construction and because of unavoidable delays in legalizing and in disposing of the \$200,000 bond issue.

In November, 1929, the original dates for holding the III Olympic Winter Games were set—January 28 to February 6, 1932. These dates were subsequently shifted at the Olympic Congress in May, 1930, to February 4 to 13, where they remained.

At a meeting on December 3, 1929, it was voted to increase the size of the executive committee, and three names were added. The number on this committee, which eventually became the board of directors, was finally set at 15, while the III Olympic Winter Games Committee, under the by-laws subsequently adopted, could be made up of 100 members: Those added to the original executive committee at the December 3 meeting were R J Kennedy, chairman of the North Elba Park Commission; H W Hicks, secretary of Lake Placid Club; and one member from Saranac Lake, who was not named at that time. Lewis G Graeves was eventually chosen to represent Saranac Lake on the executive committee. Five members of the board of directors, including President Avery Brundage and other officials of the American Olympic Association, were subsequently selected from outside the immediate Lake Placid area, to bring the



Ready for the Games. A general view of the stadium



Looking down part of the Mt. Van Hoevenberg bobsled run

number up to the required 15. Places made vacant by resignations from the original committee were filled, and the board of 15, with the local members meeting most frequently, served until the conclusion of the Games. The list of committee members and directors is given on pages 14 and 15.

Olympic Construction Begins

The first construction for the III Olympic Winter Games began early in December when the contractor started work on the culvert to run across the high-school campus underneath the Olympic stadium.

Early in January, 1930, workmen began tearing down the seven buildings on the plot of ground to the north of the high-school campus in order to make room for the stadium.

The necessity of further perfecting the Olympic organization by employment of a paid secretary was frequently stressed, and several candidates for this position were considered.

Thomas P Faherty, secretary of the Chamber of Commerce, acted as secretary of the Olympic Committee until a paid executive was chosen.

Invitations Sent to 65 Nations

In February, 1930, formal invitations to participate in the III Olympic Winter Games at Lake Placid were sent to 65 nations. By custom, invitations are sent to the entire list of separate countries recognized by the International Olympic Committee. The list of those nations invited to take part in the Lake Placid Games follows:

- | | | | |
|---|-----------|----|----------------|
| 1 | Albania | 9 | Canada |
| 2 | Argentina | 10 | Chile |
| 3 | Australia | 11 | China |
| 4 | Austria | 12 | Colombia |
| 5 | Belgium | 13 | Costa Rica |
| 6 | Bolivia | 14 | Cuba |
| 7 | Brazil | 15 | Czechoslovakia |
| 8 | Bulgaria | 16 | Denmark |

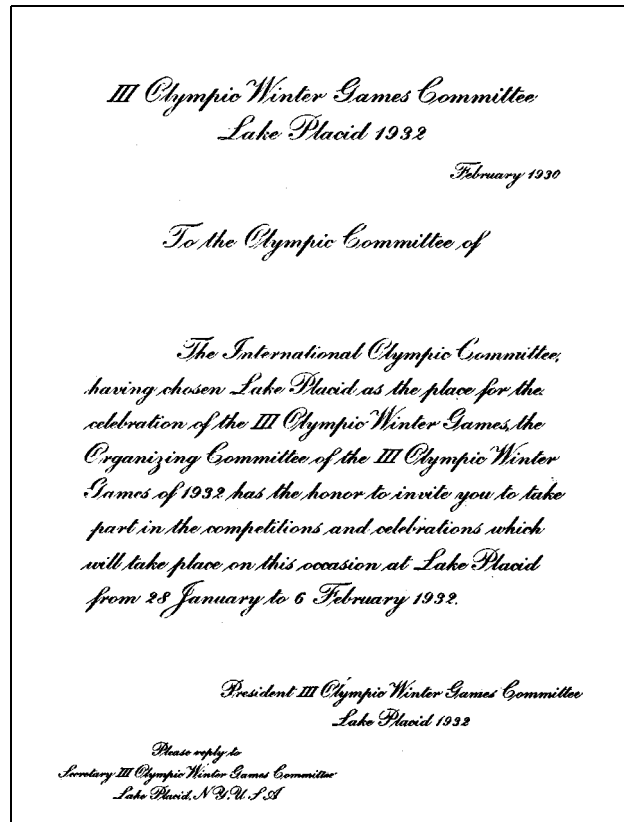

Invitation to National Olympic committees

- 17 Dominican Republic
- 18 Equador
- 19 Egypt
- 20 Esthonia
- 21 Finland
- 22 France
- 23 Germany
- 24 Great Britain
- 25 Greece
- 26 Guatemala
- 27 Haiti
- 28 Holland
- 29 Honduras
- 30 Hungary
- 31 Iceland
- 32 India
- 33 Ireland
- 34 Italy
- 35 Japan
- 36 Jugoslavia
- 37 Latvia
- 38 Lithuania
- 39 Luxembourg
- 40 Mexico
- 41 Malta
- 42 Monaco
- 43 Newfoundland
- 44 New Zealand
- 45 Nicaragua
- 46 Norway
- 47 Panama
- 48 Paraguay
- 49 Persia
- 50 Peru
- 51 Philippines
- 52 Poland
- 53 Portugal
- 54 Rhodesia
- 55 Roumania
- 56 San Salvador
- 57 Siam
- 58 South Africa
- 59 Spain
- 60 Sweden
- 61 Switzerland
- 62 Turkey
- 63 United States
- 64 Uruguay
- 65 Venezuela

When the invitations were sent out it was hoped that at least 25 nations, represented

by approximately 600 athletes, would take part in the III O W G, and it was on this basis that preliminary plans were developed. Because of unprecedented economic conditions obtaining throughout the world this estimate was a bit too sanguine, as will appear later.

Early in March, Governor Franklin D Roosevelt signed the bill legalizing the sale of \$200,000 worth of park district bonds, and the last obstacle to beginning actual construction of the Olympic stadium was removed.

Another bill introduced in the legislature at this time provided for the creation of an Essex County Park Commission from the Board of Supervisors which would eventually co-operate with the Olympic Committee in many ways. The Essex County Board of Supervisors had shown much interest in the Games from the time they were awarded to Lake Placid and co-operation, which, it was indicated, would come in large measure from this board, promised much for the success of the project.

Ask Dewey to Attend to Berlin Congress

Decision to send Dr Dewey to represent the III Olympic Winter Games Committee at the Olympic Congress in Berlin May 25-30 was reached at a meeting held March 15.

It was thought advisable to have Dr Dewey attend the Berlin Congress in order to explain and perfect details of the III Olympic Winter Games program and secure additional co-operation from the delegates to the Congress. Dr Dewey also planned, while abroad, to confer with officials of the International Skating Union in regard to securing permission to have the speed-skating at the Games contested under North American rules.

Early that month Graeme M Hammond, president of the American Olympic Association, and Frederick W Rubien, secretary, inspected Olympic preparations at Lake Placid. They were much pleased with the plans for staging the Games but were somewhat concerned about the housing situation. The plan to house visitors was explained to



Ted Husing, sports announcer of the Columbia Broadcasting System, at his microphone during the bob races at Mt Van Hoevenberg run

—Wide World



Members of New York State police on duty during Games and Olympic officials

—Stedman

them in detail. They were satisfied with the arrangement and stated that they were anxious to co-operate in every way possible to insure the success of the Games.

Executive Secretary Engaged

On March 22, 1930, Ernest F Gamache of Leominster, Mass, a graduate of Harvard College and the Harvard Graduate School of Business Administration, was engaged as secretary of the III Olympic Winter Games Committee. He assumed his duties on April 1 and immediately established executive headquarters in the North Elba town hall. He came to the committee highly recommended as a man thoroly familiar with sports and sports promotion from his experience as a football and lacrosse player and as an athletic coach.

Stanislaus Zentzytzki, German bob-run engineer, was askt to come to Lake Placid a second time to survey the site, finally chosen on private land, for the building of the Olympic bob-run.

The run could not be built on state land because of adverse court decisions, and the Mt Jo site on private land, previously considered, was found to be unsatisfactory. Finally another site on what was then called South Meadow mountain was chosen after much study and investigation for the building of the Olympic bob-run. This latter site was on privately-owned land.

On April 3, 1930, the executive committee of the III Olympic Winter Games was named as follows: President Dewey, Vice-president Willis Wells, and Judge T A Leahy.

Work Begins on Stadium

On April 7, the contract having been previously awarded, the first shovelful of earth on the Olympic stadium construction job was turned in the presence of a large crowd. Work on the excavation and the grading necessary to insure a level site for the erection of the stands and the building of the speed-skating track went forward in the spring with all possible speed, and the work was finisht on schedule.

State Commission Named and Funds Appropriated

Both houses of the State legislature, early in April past the Porter-Brereton bill appropriating \$125,000 for the construction of a bobsled run and for other expenses incident to the conduct of the Games and creating a New York State Olympic Winter Games Commission of nine members. This act became a law April 22, 1930 and is known as Chapter 677 of the Laws of 1930. To quote from the law:

“Section 2 The object and purpose of the Commission shall be to co-operate in preparing for, organizing, providing facilities for, and conducting the III Olympic Winter Games at Lake Placid in the year 1932 and to promote the success of such Games and any winter sports in the program thereof

“Section 3 For the use of the public in connection with such Games and to carry out the purpose of this act the Commission is hereby specifically authorized to construct and equip and to maintain and operate during the winter seasons of 1930, 1931, and 1932 a bobsleigh run or slide including a way. for returning such sleighs to the top on a site in the Town of North Elba, Essex County, to be selected by the Commission on lands in which it obtains the necessary easement

“Section 5 The sum of \$125,000 or so much thereof as may be needed is hereby appropriated from any money in the treasury not otherwise appropriated for or toward the construction, equipment, and maintenance of such bobsleigh run or slide”

Of the nine members of the State Commission five were to be appointed by the governor, two to be named by the majority leader of the senate, and two by the speaker of the assembly.

The original commission was constituted as follows:

Appointed by the governor:

T Harvey Ferris, Utica, N Y

Godfrey Dewey, Lake Placid Club,
N Y

George Foster Peabody, Saratoga
Springs, N Y

Rollie J Kennedy, Lake Placid, N Y

William G Howard, Albany, N Y

Appointed by the majority leader of the senate:

Warren T Thayer, Chateaugay, N Y
Henry E H Brereton, Lake George,
N Y

Appointed by speaker of assembly:

Fred L Porter, Crown Point, N Y
Paul Boyce, Glens Falls, N Y

Ex-officio members:

John Knight, Arcade, N Y
Joseph A McGinnies, Ripley, N Y

Later Mr Boyce was succeeded by Edwin W Wallace, Rockville Center, N Y; Mr Brereton by Frank A Frost, Watkins Glen, N Y; and Mr Knight by George R Fearon, Syracuse, N Y.

The commission held its first meeting on July 23, 1930, and organized as follows: Warren T Thayer, chairman; Fred L Porter, vice-chairman; T Harvey Ferris, secretary. Ernest F Gamache was appointed as executive secretary, and Wallace E Pierce of Plattsburg, N Y, was named counsel.

The State Commission, thus organized, was one of the most active bodies in promoting and in staging the III Olympic Winter Games. Without its support and that of the State of New York the Games could never have been held in Lake Placid.

On April 21, 1930, the Olympic Committee met and adopted a set of by-laws by unanimous vote. These by-laws, with subsequent slight amendments, follow:



III O W G Committee letter-head

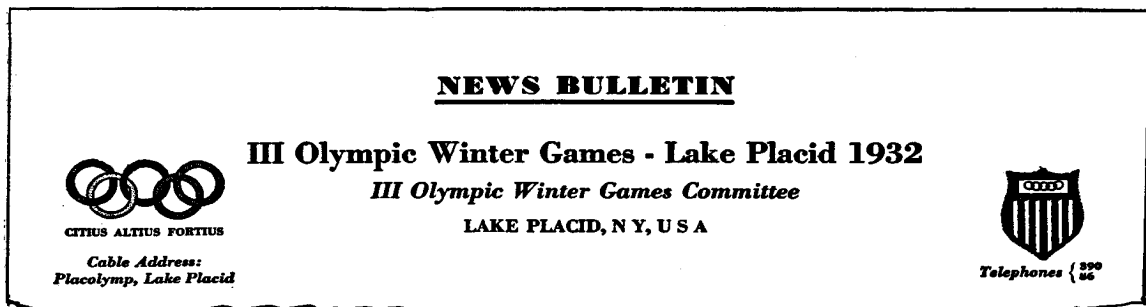

News bulletin letter-head

**III Olympic Winter Games Committee
Lake Placid 1932
By-Laws**

1 Name

The name of this organization shall be III Olympic Winter Games Committee.

2 Purpose

The purpose of the III Olympic Winter Games Committee shall be to organize and conduct the III Olympic Winter Games at Lake Placid, Essex County, New York, in 1932, and to do all things deemed necessary or proper in preparation for and in carrying on said games and to settle the affairs of the organization at the conclusion thereof.

3 Location

The principal office of the Committee shall be located in the North Elba town hall, at Lake Placid, Essex County, New York.

4 Membership

The members of this Committee shall be of three classes, designated respectively as active members, honorary members, and co-operating members.

(a) *Active Members* The active members of the Committee shall not exceed 100 in number, and shall consist of the 15 directors and such other persons as may from time to time be elected by two-thirds vote of the directors. Each active member shall have one vote at all meetings of members of the Committee and one equal share in the property and assets of the Committee. Only active members shall have the right to vote or to hold active office.

(b) *Honorary Members* The honorary members of the Committee shall not exceed 25 in number, and shall consist of such persons as may from time to time be elected honorary members by two-thirds vote of the directors. Honorary members shall not be required to pay any dues or other charges, shall not be under obligation to perform any duties or services, and shall not be entitled to vote or to share in the assets of the Committee or to hold any office other than honorary office.

(c) *Co-operating Members* The co-operating members of this Committee shall be without limit in number, and shall consist of such persons as may be elected co-operating members by two-thirds vote of the directors, with or without dues or other charges as may be determined by the directors. It is intended that co-operating members shall aid, support, encourage, and co-operate in any work or project undertaken by the Committee. They shall be entitled to attend all meetings of members of the Committee, but shall not be entitled to vote or to share in the assets of the Committee.

5 Meetings

Regular meetings of the members of the Committee shall be held semi-annually, on the second

Monday of April and October, at 10 a m at the Town Hall at Lake Placid, N Y, unless another time and place shall be specified by the directors, by written notice mailed at least 30 days in advance of the meeting.

The regular October meeting shall be the annual meeting for the election of directors.

Special meetings may be called by the President or by vote of the directors on not less than 10 days' written notice.

Those present at a regular or special meeting duly called shall constitute a quorum.

6 Directors

Between meetings of the members, the full powers of the Committee shall be exercised by a board of 15 directors who shall be elected by the active members at the annual meeting and shall hold office until the close of the meeting at which their successors are elected. Not less than three-fifths of the directors shall be residents of the public parks and playground district of the town of North Elba, N Y.

Vacancies shall be filled by the Board for the unexpired term.

7 Directors' Meetings

Regular meetings of directors shall be held on the second Monday of each month, at 8 p m at the Town Hall, unless another time or place is specified by written notice, mailed at least one week in advance of meeting. Seven shall be a quorum.

Special meetings of directors may be called on not less than 48 hours' notice, by the President or the Executive Committee.

8 Executive Committee

The directors shall appoint an executive committee of three of their number, who, when the directors are not in session, shall have power to act for the directors on any matter on which the executive committee is unanimous, provided that such action is not in direct conflict with any by-law or rule or vote of the directors.

At each directors' meeting, the minutes of all meetings of the executive committee since the preceding directors' meeting, shall be read and approved and sent to each absent director, with the minutes of that meeting.

9 Standing Committees

The directors may, from time to time, establish standing committees and define their duties. Such committees shall consist of active or co-operating members, appointed by the president with the approval of the directors, with power to add to their number persons who need not be members of the III Olympic Winter Games Committee. The chairman of any such standing committee shall be ex-officio an active member.

(a) *Housing Committee* The Housing Committee shall be responsible for all efforts to increase or improve facilities for housing and feeding contestants, officials, and spectators; for approving and publishing minimum and maximum rates for all housing facilities, and assuring adherence to published rates; for establishing and enforcing equitable rules for the distribution of contestants, officials, and spectators among available housing facilities; and for specific assignment of housing facilities, so far as available, to all those who apply to the committee for such assignment.

(b) *Transportation Committee* The Transportation Committee shall be responsible for all arrangements for transportation of contestants, officials, spectators, and equipment, including negotiations with railway and steamship companies for special rates or service, and with bus lines and others for regional transportation; and organization of local transportation for arrival, departure, and all events during the Games.

(c) *Health and Safety Committee* The Health and Safety Committee shall be responsible for all arrangements for health and safety, including special sanitary facilities, regulations, or organization, policing, and provisions for waivers and/or liability insurance in connection with the special hazards of the Games.

(d) *Finance Committee* The Finance Committee shall be responsible for preparing the budget of the III Olympic Winter Games, and for raising of funds other than those provided by the Town of North Elba and by the State of New York. They shall audit the accounts of the committee before each semi-annual meeting, or oftener if required by the directors, and shall report to said semi-annual meeting.

(e) *Publicity Committee* The Publicity Committee shall be responsible for all publicity arrangements not otherwise assigned, including preparation and distribution of booklets, posters, and signs, news releases and special articles, use of paid space, radio, movie, and similar special sources, and in general all relations with press or public designed to encourage participation or attendance at the Games and establish throughout the world the reputation of Lake Placid as a winter and summer resort.

10 *Officers*

The directors shall elect annually a president, vice-president, treasurer, and assistant treasurer from their own number, and a secretary and any other needed officers, who need not be directors. The directors shall fill any vacancy for the unexpired term and may remove any officer or employee.

The directors may, by two-thirds vote, elect one or more honorary officers.

11 *President*

The president shall be the official representative of the Committee. He shall preside at all meetings of members or directors, and shall be ex-officio a member of all committees. Subject to these by-laws and to directors' rules or votes, he shall be the executive officer in charge of all Committee business not otherwise specifically assigned.

12 *Vice-president*

The vice-president shall, in the president's absence or incapacity to act, have such of his duties and exercise such of his powers as may be necessary for the transaction of Committee business.

13 *Treasurer*

The treasurer shall have custody of all moneys, securities, and accounts. He shall deposit in banks designated by the directors all money received, and shall keep full and accurate accounts, open always to directors' inspection. He shall pay out money or incur liability for the Committee only as authorized by directors by budget appropriation, general rule, or specific vote.

14 *Assistant Treasurer*

The assistant treasurer shall, in the treasurer's absence or incapacity to act, have such of his duties and exercise such of his powers as may be necessary for the transaction of Committee business.

15 *Secretary-General*

The secretary-general shall be the general executive officer of the Committee, to perform all duties required of him by the president or board of directors, in carrying out the plans and policies determined by the directors. He shall be responsible for all executive routine of correspondence, filing, and reports. He shall send all notices of meetings and keep accurate records of all meetings of members or directors or executive committee. On request of any standing committee, he shall act as secretary of that committee.

Unless otherwise provided by the directors, he shall receive all money paid to the Committee, receipt for and record the same, and forthwith pay over and deposit the same with the treasurer.

16 *Other Executive Officers*

The directors may from time to time appoint other executive officers and define their duties.

(a) *International Secretary* The international secretary shall be responsible for all direct contacts with the national Olympic committees of the various countries invited to participate in the III Olympic Winter Games, and for such other duties in the preparation and conduct of the Games as may be determined by the board of directors.

17 *Checks and Notes*

Checks, notes, and other negotiable instruments shall be signed by the treasurer or assistant treas-

urer, and countersigned by the president or vice-president.

18 *Votes by Mail*

By vote of the directors or executive committee, any questions may be submitted to a vote of the active members by mail. Ballots, with any authorized explanation or discussion, shall be mailed to all active members and, to be recorded, shall be return by a designated date, not less than 10 days nor more than 15 days after mailing.

19 *Amendments*

These by-laws may be amended by two-thirds vote of active members, at any regular or special meeting or by mail, provided that amendment, in substantially the exact form adopted, shall have been submitted to all active members, with notice of the meeting at which such amendment is voted on or with ballot for vote by mail.

With the adoption of the by-laws and the appointment of additional directors and committee members, the Olympic organization was complete. It functioned from this time under the regulations set up in these by-laws until it was discontinued following the Games.

Standing committees were as follows:

Housing, Judge T A Leahy, chairman
Transportation, Lewis Crane, chairman
Health and Safety, Martin T Ryan, chairman
Finance, Willis Wells, chairman
Publicity, F B Guild, chairman

Skeleton Run Eliminated

Decision to build a bobsled run on South mountain, later named Mt Van Hoevenberg, was reached early in May following Mr Zentzytzki's study of the site. It was thought at this time that it would be necessary to build a skeleton or single-sled run for the Games, and it was decided to lay out this skeleton run also on South mountain.

Dr Dewey sailed from New York on May 13 to attend the meeting of the International Olympic Congress in Berlin.

Word was received in Lake Placid from Dr Dewey in Berlin that the skeleton racing had been eliminated from the III O W G program. This was welcome news to the local committee. It was estimated that elimination of the skeleton run would save

the committee approximately \$25,000. Dr Dewey also cabled that officials attending the Berlin Congress were much pleased with the work being done at Lake Placid in preparing for the Games.

At a meeting of the board of directors on July 9, Dr Dewey reported on his attendance at the Berlin Congress and the many things accomplished favorable to the conduct of the III O W G. In the course of his trip abroad Dr Dewey interviewed winter-sports leader in Switzerland, France, Norway, Sweden, and England.

The organization of Olympic Winter Games publicity, generally considered to be, one of the most important problems, came in for considerable discussion at this meeting. While preliminary steps had already been taken it was not until September 15, 1930, that this program was actually set up in all its details.

The publicity committee was appointed July 24, 1930, and consisted of F B Guild, chairman, J B Hurley and E E MacConnell. Later E C Paarman and Thomas P Faherty were added.

Bob-run Construction Begins

Following the clearing away of all legal obstacles and the letting of contracts, work on the construction of the Olympic bob-run on Mt Van Hoevenberg began August 4, 1930, with Henry Homburger of Saranac Lake supervising engineering details and working from the plans drawn by Mr Zentzytzki. Fair weather was of great assistance in making it possible to complete the bob run and open it for actual use on Christmas Day that same year.

As a result of several meetings of the transportation committee and officials of the New York Central and Delaware & Hudson railroads, the latter decided to enlarge their yards at the local station to take care of the increased traffic at the time of the Games. This additional construction was to include two new switches at Lyons' crossing to house Pullmans and special cars during the Games.



Course for 18-kilometer ski race

Johan Grøttumsbraaten, Norway, winner of 1



—Stedman

Whiteface Mountain draped in snow

Publicity Organization Chosen

Following weeks of discussion and the investigation of well-known publicity firms and individuals, a contract to direct III O W G publicity was made with James F Newcomb & Co, Inc, of New York city, late in August. Professional experience of the highest type and world-wide contacts were deemed absolutely essential to the proper development of this phase of the work.

The Newcomb organization immediately began setting up the publicity program, which originally was to entail an expenditure of \$50,000. On September 15, Otis Peabody Swift, a member of the Newcomb staff, established his headquarters in Lake Placid and began sending out news releases to newspapers and magazines and the preparation of the first pieces of Olympic publicity literature. A full report of Olympic publicity will be found in the section entitled *Publicity*.

Late in August the highway leading from the Cascade road to the start of the Mt Van Hoevenberg bob-run was completed, and all during the fall many motored to the run daily to watch the progress of construction.

That same month, Count de Baillet-Latour, president of the International Olympic Committee, arrived in Lake Placid, and spent two days inspecting Olympic facilities. Count de Baillet-Latour was much pleased with the progress made in getting ready for the Games. From his years of experience in Olympic matters he was able to give the committee much helpful advice, which was of material assistance in prosecuting the various projects. Count de Baillet-Latour's experience was always at the disposal of the Lake Placid organization and was uniformly helpful.

Major developments in the Olympic picture during the fall of 1930 included continued agitation for the building of an indoor ice arena; the preparation of posters, booklets, and other printed matter in the publicity program; and a house-to-house survey of hotel and cottage accommodations in Lake Placid, conducted by former Mayor William E. Feek.

The necessity for hotel and cottage owners to "winterize" summer accommodations in preparation for the Games was frequently pointed out, and many began this work at this time. The housing survey disclosed the fact that a certain amount of "winterizing" and special efforts in persuading hotel and cottage owners to keep their places open would put the community in a position to house its full quota of Games visitors. Thus one of the most perplexing problems confronting the committee was rapidly approaching solution.

Because of unsettled business conditions throughout the world and because the countries that would take part in the III O W G were so far distant from Lake Placid, it was thought advisable to have a representative of the Organizing Committee tour Europe in the interests of the Games. Accordingly Bjorn Blix sailed for Europe as international secretary on December 2. His trip was originally planned to take about three months, but various departures from his prearranged schedule extended this time to about six months.

On December 10, 1930, H L Garren of Lake Placid, who had acted as foreman for the contractor in the excavation for the Olympic stadium, was named as outside superintendent for the III O W G Committee.

State Appropriates \$375,000

On December 12, 1930, it was announced that the New York State Olympic Winter Games Commission would ask the legislature at its next session to appropriate additional funds, amounting to \$375,000, for the conduct of the Games. The funds were subsequently made available when the governor signed the appropriation item in the executive budget on February 26, 1931. The total amount of state aid for the III O W G prior to the Games was, therefore, \$500,000.

Funds necessary to build the indoor ice arena were not included in this second appropriation, so that it was necessary for a committee to seek other means of financing the arena project.

In December, several additions were made

to the executive staff as the work increased, and more office space was arranged on the second floor of the North Elba town hall.

Annual Committee Meeting Held

On January 3 and 4, 1931, the annual meeting of the III Olympic Winter Games Committee was held. Major business transacted at the meeting included limiting the number of active members to 100, consideration of all committee reports, and discussion of the budget. It was evident at this time that it would soon be necessary for the committee to conduct a money-raising campaign in the eastern part of the United States in order to balance its budget.

On January 10, 1931, the directors voted that plans be developed for the conduct of a restricted fund-raising campaign. Shortly after this a contract was signed with H H Railey & Company, Inc, of New York city to conduct this campaign. In view of extraordinary economic conditions the goal in this campaign was never reached, although a considerable sum over and above expenses was realized. Further details are found in the section of this book entitled *Finance*.

William J O'Hare of Lake Placid was appointed auditor and housing director for the committee on February 20.

Change in Publicity Department

On March 1, Otis Peabody Swift, who had been directing Olympic publicity in Lake Placid, returned to New York, and his duties were taken over by George M Lattimer of Lake Placid, who had joined the Olympic executive staff the preceding December. Mr Lattimer continued to direct publicity in Lake Placid until the conclusion of the Olympic program.

Vote to Send Dewey to Vienna

At a meeting of the directors held on March 16, it was voted to send Dr Dewey to the Congress of the International Skating Union in Vienna on May 20, in order to try to secure approval of the rules of the Amateur Skating Union of the United States for the speed-skating races at the III O W G.

It was felt that these races would have a much wider appeal if skated under American rules, with skaters racing directly against each other in heats, instead of in pairs against time as under the European system. Dr Dewey was successful in his quest, and American skating rules prevailed at the Games.

Charles Waite, chairman of the Essex County Park Commission, on April 3 was elected to the board of directors to succeed Frederick T Kelsey of New York, resigned. The Essex County Board of Supervisors had voted to appropriate \$50,000 for the Games, to be expended through the County Park Commission. Vacancies created on the board of directors by the resignations of Graeme M Hammond, John F White and William J, O'Hare had been previously filled by the election of A C Gilbert, Forrest B Guild and James B Hurley.

Ice Arena Made Certain

Agitation for the building of an indoor ice arena continued, and leaders of civic groups, at a meeting April 22, voted to erect such a structure and favored utilizing a site owned by the Grand View hotel on Main street, directly across from the village fire-house. It was on this site that the arena was finally built, following the voting of a \$150,000 bond issue by the North Elba park district on July 30, 1931.

Publicity work abroad during the preceding fall and winter, coupled with the work of Bjorn Blix, international secretary, resulted at this time in the receipt of helpful preliminary information from foreign countries as to whether or not they would be represented at the Games and as to the size of the teams that they would send.

President Hoover Invited to Open Games

On May 16, 1931, a formal invitation was extended to President Herbert Hoover to come to Lake Placid on February 4, 1932, and, in accordance with international custom, open the III Olympic Winter Games. President Hoover subsequently found it im-

possible to attend, and Governor Franklin D Roosevelt of New York state officially welcomed the participating nations on the opening day.

At the Vienna Congress Dr Dewey assisted the Polish representative in his successful efforts to have women's speed-skating records officially recognized. This recognition on the part of the congress made possible a special demonstration of women's speed-skating at distances of 500, 1000, and 1500 meters at the III O W G. The two official demonstrations were curling and sled-dog racing.

On July 1, 1931, Walter G Wallace of Ticonderoga was named assistant auditor, and later that month E C Paarman of Lake Placid was added to the staff to do special work in the publicity department and to supervise the handling of tickets, entries, and programs.

Developments during the late summer of 1931 included the favorable vote on July 30

on a town bond issue of \$150,000 for the building of an indoor ice arena, rushing of work on the arena, erection of stands at the stadium, construction of a club-house at the bob-run, and the visits of several officials from European nations to make preliminary arrangements for housing their national groups. Included among these were representatives from Finland, Norway, Sweden, and Japan.

Rumors of Games Shift Unfounded

During October, 1931, press dispatches from abroad indicated that unusually bad economic conditions in many foreign countries might force those countries to withdraw from competition in the III Olympic Winter Games. There were even rumors that some nations favored a postponement of the Games altho under the terms of the international protocol the Games cannot be postponed or their schedule altered.

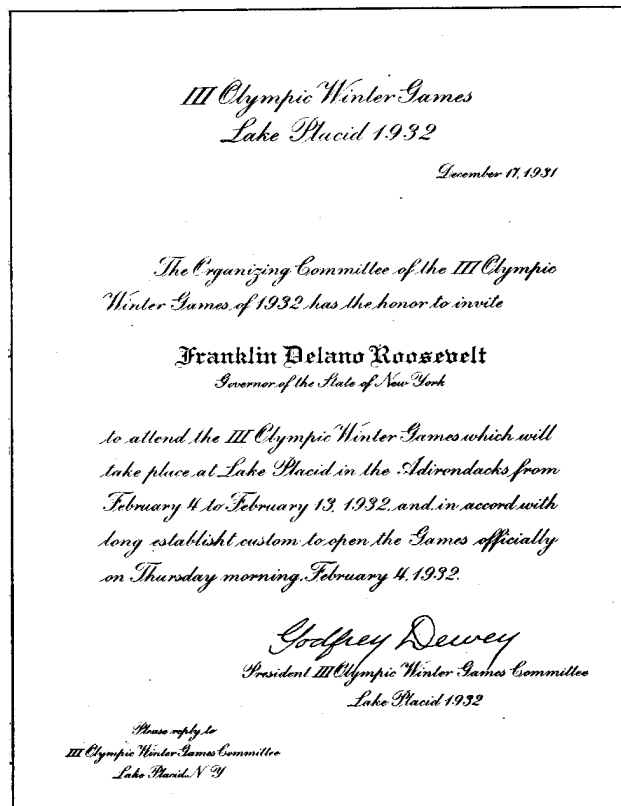

Invitation to Governor Roosevelt to open Games

In a short time these rumors died down, and nations pushed forward vigorously their plans to participate in the Lake Placid Games. It must, however, be definitely borne in mind that these same exceptional economic conditions and the great distance to Lake Placid did cut down the number of European nations participating and the size of some of the teams, although the quality of the competition was never higher.

Concessions Are Granted Contestants

In an effort to insure the largest possible European participation in the Games the committee was able to secure many concessions for visiting athletes, officials of international federations, I O C and national Olympic committee members.

Steamship lines, members of the North-Atlantic conference, granted a 20% reduction from off-season rates on one-way or round-trip tickets.

The New York Central railroad granted a special rate of \$15 from New York to Lake Placid and return.

Congress eventually passed, on recommendation of President Hoover, a resolution exempting foreign contestants and officials from the usual passport and visa requirements upon the presentation of official identity cards which were visaed without charge; waiving the tax of \$8 imposed under the immigration law; and granting free entry for personal baggage and equipment.

The steamship companies above and the New York Central railroad also granted free transportation for sports equipment brought to Lake Placid by foreign contestants for use in the Games.

The committee also voted in October, 1931, because of unusual economic conditions and the resulting depreciation in European currency, to cut the cost of housing foreign contestants and officials \$1 a day per individual. The rates finally agreed upon after this cut were \$2, \$3; and \$4 a day per person depending upon the type of accommodations desired.

It is certain that these concessions aided

materially an increasing international representation at the III Olympic Winter Games.

Material Sent National Committees

In November, 1931, shipments of the following forms and booklets were made to 57 nations:

- Entry forms
- Steamship blanks
- Railroad blanks
- Identity cards for officials
- Identity cards for contestants
- General Rules Book and Program Booklet, "III Olympic Winter Games"
- Official Information Booklets
- Supplementary information sheets

Unusual Weather Conditions Hinder

Winter sports being dependent upon plenty of snow and ice, Lake Placid residents in the fall of 1931 watched eagerly for the usual signs of winter. A heavy snowfall on November 7 seemed to indicate a long winter season, but the prophecy proved false, and those promoting the Games were forced to contend with the most unusual weather conditions in Adirondack history. Lack of snow in December and January, an unprecedented situation, made the task doubly difficult. In spite of all these handicaps every event on the Olympic program was staged, with only a few shifts being necessary.

Proof of these extraordinary weather conditions is found in a statement received from the director of the New York state weather bureau at Albany, N Y, which said that the winter of 1931-32 was the most unusual in the 147 years of the weather bureau's history. For example, the Hudson river up until late in February, when the letter was written, had not frozen over, the first time this had occurred since the bureau was established.

17 Nations Enter Games

The closing date for national entries in the III Olympic Winter Games was December 24, 1931. When entries closed on midnight that day it was found that 17 nations would take part as follows:

COMITE INTERNATIONAL OLYMPIQUE

Nous soussignés certifions que M
This is to certify that Mr.

est un
is a

voyageant pour se rendre aux III Olympic Winter Games
travelling to attend the

qui auront lieu à Lake Placid, N. Y., U. S. A. en Feb. 4-13, 1932
to be held at

Président du Comité National	Président du Comité International Olympique
Chairman of the National Committee	Chairman of the International Olympic Committee

Délivré à
Issued at

Date

Ce certificat sera remis à la Compagnie de Navigation.
This certificate will be surrendered to the Steamship Company.

(1) Inscrivez ici si le porteur est:
Insert here whether holder is:

- (a) Participant — Competitor.
- (b) Officiel d'une Fédération Internationale
Official of one of the International Federations.
- (c) Membre du Comité International Olympique.
Member of the International Olympic Committee.
- (d) Membre d'un Comité Olympique National.
Member of a National Olympic Committee.

Le titulaire de cette carte a droit a une réduction de 20% pour un voyage simple ou un voyage circulaire, à
The bearer is entitled to a reduction of 20% on one way or round trip rates, provided he travels within the
condition qu'il voyage durant les périodes prescrites, par l'une des Compagnies suivantes:
prescribed periods, by one of the following Companies:

Anchor Line	Hamburg Amerika Line
Anchor-Donaldson Line	Holland Amerika Line
Atlantic Transport Line	Norddeutscher Lloyd
Canadian Pacific	Norwegian America Line
Cie Générale Transatlantique.	Red Star Line
Cosulich Line	Scandinavian American Line
Cunard Line	Swedish American Line
Furness Line	United States Lines
Gdynia's America Line	White Star Line

Steamship form used by contestants and officials to secure special rates on trans-Atlantic lines

INTERNATIONAL OLYMPIC COMMITTEE

Nous soussignés certifions que M
This is to certify that Mr.

est un
is a

voyageant pour se rendre aux III Olympic Winter Games
travelling to attend the

qui auront lieu à Lake Placid, N. Y., U. S. A. en Feb. 4-13, 1932
to be held at

Président du Comité National	Président du Comité International Olympique
President of the National Committee	President of the International Olympic Committee

Délivré à
Issued at

Date

Secretary General, III O. W. G. Committee

Ce certificat sera remis aux bureaux de la compagnie du New York Central.
This certificate will be surrendered to the proper representative of the New York Central Lines.

(1) Inscrivez ici si le porteur est:
Insert here whether holder is:

- (a) Participant — Competitor.
- (b) Officiel d'une Fédération Internationale.
Official of one of the International Federations.
- (c) Membre du Comité International Olympique.
Member of the International Olympic Committee.
- (d) Membre d'un Comité Olympique National.
Member of a National Olympic Committee

Le titulaire de cette carte a droit au tarif special de \$15 pour un billet aller et retour de New York a Lake Placid sur
The bearer is entitled to a special rate of \$15 from New York to Lake Placid and return via New York Central
les lignes de chemin de fer du New York Central, à condition qu'il voyage durant les périodes prescrites.
Lines, provided he travels within the prescribed periods.

Railroad form used by contestants and officials from abroad to secure special rate concessions on New York Central Lines

- | | |
|-------------------|-----------------|
| 1. Austria | 9. Hungary |
| 2. Belgium | 10. Italy |
| 3. Canada | 11. Japan |
| 4. Czechoslovakia | 12. Norway |
| 5. Finland | 13. Poland |
| 6. France | 14. Roumania |
| 7. Germany | 15. Sweden |
| 8. Great Britain | 16. Switzerland |
| 17. United States | |

January was a busy month. The arrival of Olympic teams and the handling of necessary last-minute details kept the Olympic staff busy almost literally night and day.

The first large European group to arrive was that from Norway. The Norwegian contingent reached Lake Placid on January 6, and immediately established headquarters in the cottage which had already been reserved. The rest of the visiting teams continued to arrive in Lake Placid during the ensuing four weeks.

The total number of individual athletes entered in the Games was 364.

Unseasonable weather conditions continued thru January, and the lack of snow and ice made pre-Olympic training for many of the athletes extremely difficult.

Arena Helps Athletes

The indoor arena was officially opened January 16, and from that time on afforded ideal practice conditions, regardless of weather, for the figure-skaters and hockey players. Even the speed-skaters were able to utilize the arena ice for practice purposes.

Weather wrought the greatest hardship on the skiers, bobsledders, sled-dog teams, and speed-skaters, altho the latter were practically always able to practice either on the stadium track, the Mirror lake track, or in the Olympic arena.

The United States teams were handicapt, since warm weather in Lake Placid and in other parts of the country prevented try-outs for the bob teams, ski-jumping and cross-country ski teams, and the speed-skating team. Committees were, therefore, first for the most part to pick these contestants without formal pre-Olympic trials.

The Mt Van Hoevenberg Olympic bob-

run was entirely washed out by rain once and considerably damaged by warm weather at other times. As a result, bob-crews were unable to get in the amount of practice desired.

To add to the difficulties of the athletes, the same unseasonable weather abroad had prevented most of them from doing much training in their native countries before sailing for the United States.

With all these discouragements, good spirit was shown by every one, and indefatigable efforts on the part of the Lake Placid committee, coupled with a change for the better in the weather, resulted in the Games opening as scheduled on Thursday morning, February 4.

During January, the Olympic office staff was increased materially, and the entire organization, both indoors and outdoors, was geared up to a point where it could handle properly the thousand and one details that arose during the period of the Games.



—Pierson Studio
Scene on Lake Placid ski trail March 29, 1932

General Organization

Reference to the organization chart of the III Olympic Winter Games will show the different governing bodies concerned with the promotion of the Games and the flow of authority down thru the various officials, committees, and department heads. A list of standing committees and advisory sports committees will be found on pages 15 and 16.

Full authority for the organization and conduct of the Games was vested in the III Olympic Winter Games Committee (Organizing Committee) by the American Olympic Association in accordance with the rules of the International Olympic Committee. The executive officer of the III O W G Committee was the secretary, Ernest Gamache. He was in daily touch with all the department heads and the president, Dr Godfrey Dewey, or vice-president, Willis Wells.

As the work increased in volume and intricacy during the fall and winter immediately preceding the Games, frequent meetings of department heads were held in order that all might keep fully abreast of the Olympic picture as it was developing. Department heads also attended most of the meetings of the executive committee and the board of directors.

All Olympic correspondence, including that of the president and secretary, was routed to the different department heads for their information prior to being placed in the general file.

The closest and most interested co-operation of the various Olympic organizations made the huge task of planning for and staging the Games much easier than would have been the case if such co-operation had not been forthcoming. The job was a big one--the biggest that had ever been even dreamed for Lake Placid--but each committee, commission, board, and individual concerned with the Games project rendered such unselfish and helpful service that all difficulties were surmounted, and the work went steadily forward step by step.

Space here does not permit the mention of all whose help made the Games possible

and successful. There was not an individual whose aid was invoked but who gave such aid to the limit of his ability. Many sacrificed their personal interests almost entirely during the years between the award of the Games to Lake Placid and the staging of the contests themselves. The Games truly are a monument to all those who worked with but one aim--to make the III Olympic Winter Games of 1932 a landmark in Olympic history.

A brief description of the powers and duties of the various Olympic bodies follows.

III Olympic Winter Games Committee The committee was given full authority by the American Olympic Association to organize and conduct the Games, to do all things deemed proper and necessary in preparation for and in carrying on the Games, and to settle all affairs at the conclusion of the Games. The active members of the committee were not to exceed 100 in number.

Board of Directors Full powers of the committee were exercised by the board of directors, which met frequently at the call of the president or executive committee. The board consisted of 15 members. Nine members were residents of Lake Placid; one lived in Saranac Lake; one in Crown Point; while the other four lived at some distance from Lake Placid.

Executive Committee This was a small committee of three members, who, when the directors were not in session, had power to act for them on any matter on which they, the executive committee, were unanimous. During the period immediately preceding the Games when major matters needed immediate decision, daily, or even more frequent, meetings of the executive committee were held. Obviously it would have been impossible to get the full board of directors together that often. It is readily seen how essential the executive committee was to effective operation by the Olympic staff.

Standing Committees: Housing, Transportation, Health and Safety, Finance, and

Publicity. Each committee dealt with matters within its own province subject to approval of the board of directors.

The *Housing Committee* made all arrangements for housing and feeding contestants and officials, including the establishment of an agreed minimum rate, and was responsible for the general plan of housing and feeding spectators. It also made specific assignment of housing facilities to those who applied to it for assistance.

The *Transportation Committee* made all arrangements for the transportation of contestants, officials, spectators, and equipment, including negotiations with railway and steamship companies for special rates. Organization of local transportation during the Games was also entrusted to this committee.

The *Health and Safety Committee* planned and was in charge of health and safety measures, including special sanitary facilities and policing.

The *Finance Committee* had charge of all financial matters, prepared the budget for the Games, audited all accounts, and devised ways and means of securing funds necessary for the staging of the Games.

The *Publicity Committee* was responsible for all publicity matters and relations with the press. Its duties included supervising the preparation of the vast amount of printed material necessitated by the Games.

Sports Committees: Skiing, Speed-skating, Figure-skating, Hockey, Bobsleigh, Sled-dog, and Curling. These committees were appointed to co-operate in the preparation of various sports facilities for the Games up to the time the international delegates arrived and took charge. They were under the jurisdiction of the III O W G board of directors.

New York State Olympic Winter Games Commission This state commission appointed by the governor and state officials had jurisdiction over all matters involving the expenditure of funds appropriated by the state and also worked with the board of directors on many executive problems. Outside matters dealing directly with the ex-

penditure of state funds and the administration of state property, the decisions of this commission were subject to final review by the board of directors.

Other Co-operating Bodies

Essex County Park Commission
North Elba Town Board
North Elba Park Commission
Lake Placid Village Board

These boards and commissions, together with the Lake Placid Board of Education, cooperated closely and most helpfully with the III O W G Committee in its work of organizing and staging the Games.

Executive Personnel

Ernest Gamache, secretary of III O W G Committee and executive secretary of New York State O W G Commission

George M Lattimer, director of publicity
William J O'Hare, auditor and housing director

H L Garren, superintendent of construction

E C Paarman, in charge of entries and records

Walter O'Connor, head of ticket department

Henry Homburger, consulting engineer
William G Distin, consulting architect

All department heads reported thru the secretary to their committee chairmen and thence to the board of directors. In case there was no committee chairman, report was made thru the secretary directly to the board.

III O W G Office Staff at Time of Games

Executive

Ernest Gamache
Hazel Wharton
Charles Lee
Eleanor Vogelsang
Mary Landon
Lila Duclos
Helen Mitchell



—Roger L. Moore

Executive and Office Staff. Back row, left to right: Charles Lee, assistant to secretary; E C Paarman, in charge of entries and records; William J O'Hare, auditor and housing director; Ernest F Gamache, secretary; H L Garren, superintendent of construction; George M Lattimer, director of publicity; Walter Wallace, assistant to auditor. Front row, *left to right*: Marcellyn Donovan, auditing department; Eleanor Vogelsang, executive department; Laura Munson, publicity department; Gladys Douglass, publicity department; Mary Landon, executive department; Lila Duclos, executive department; Rae Feather, construction department; Hazel K Wharton, executive department; Florence Potter, entries and records; Frances Pomeroy, publicity department



Olympic Stadium during a hockey game

—G Cleveland



Olympic arena

—G Cleveland

Accounting and Housing

William J O'Hare
Marcellyn Donivan
Walter G Wallace
Fred Dennin
Frances Eaton

Entries and Records

E C Paarman
E H Ford
Florence Potter
Marion Kimball

Construction

H L Garren
Rae Feather

Publicity

George M Lattimer
Howard Acton
Laura Munson
Frances Pomeroy
Lucy Faherty
Florence Eagan
Gladys Douglass
Marian Rowan
Gertrud Thoma

Tickets

Walter O'Connor
Thomas Haynes
Florence Pitcher



A Lake Placid ski trail

—Pierson Studio

Organization Chart
III Olympic Winter Games

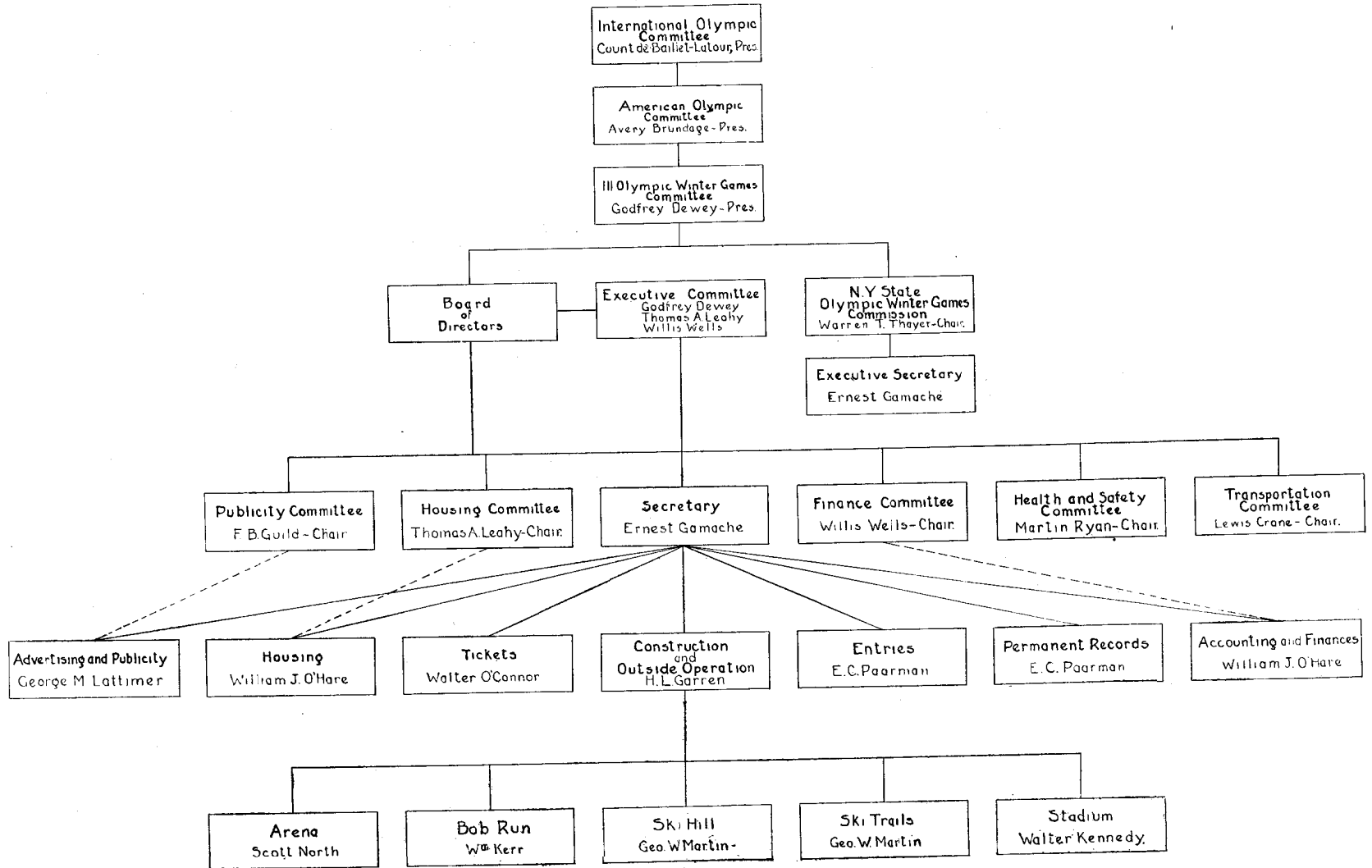

78

Chart of Organization—III Olympic Winter Games

Finance

From the beginning it was recognized that assurance of a sound financial basis for the conduct of the III Olympic Winter Games was absolutely indispensable. Before Lake Placid's proposal to the International Olympic Committee (pages 49-52) was formulated, a careful study had been made of the history of past awards, and the budget of the II Olympic Winter Games at St Moritz, together with preliminary estimates of the probable gate receipts and the minimum essential expenditures.

It was recognized that a valid proposal to receive serious consideration must be accompanied by a substantial cash guarantee. On the assumptions that the indoor ice arena would not be regarded as an essential obligation, that Lake Placid Club would provide the Intervales ski-hill, requiring only added stands for Olympic use, that New York state would co-operate at least to the extent of providing the necessary bob-run, and if necessary a separate skeleton run, and that the gate receipts would approximate \$100,000, an initial guarantee or underwriting of \$50,000 was deemed sufficient for the proposal to the International Olympic Committee-a judgment which the event proved correct. A preliminary canvass to assure this amount was undertaken late in 1928 by a voluntary committee working chiefly in Lake Placid, and early in 1929 committees in Lake Placid and Saranac Lake secured signed pledges for \$40,000 and \$10,000, respectively, making up the required guarantee.

First Bond Issue

Immediately following the award of the Games to Lake Placid, the provisional Olympic committee, elsewhere described, made a thoro study of the essential expenditures devolving upon the community, and the most practicable means of meeting them; having in mind not only the immediate needs but the eventual necessity for spending the gate receipts before they were received. The outcome of this study was the first budget of \$200,000, reproduced herewith, sub-

mitted May 9, 1929, which was based, like the original proposal, on the pledge of state co-operation to the extent at least of the bob-run, and the assumption that the indoor ice arena would not be required.

FIRST BUDGET, MAY 9, 1929

<i>Stadium</i>	
Stadium land & options.....	\$43,500
Grading	30,000
Stands	10,000
	\$ 83,500
<i>Ski-bill</i>	
Stands & other improvements for 3,000 people.....	3,000
<i>Other Local Facilities</i>	5,000
<i>Organization</i>	
Printing & publicity.....	\$25,000
Office expenses.....	25,000
Travel	5,000
Entertainment	5,000
	60,000
<i>General</i>	
Medals, diplomas & badges	\$10,000
I O C payments	5,000
Music	5,000
Decorations	10,000
Other local expenses.....	10,000
	40,000
	\$191,500
Reserve for contingencies	8,500
	\$200,000

\$200,000 Bond Issue Voted

After careful consideration it was voted unanimously to ask the taxpayers of the Town of North Elba to authorize an immediate bond issue of \$200,000 to meet this budget, on the pledge that the entire gate receipts of the III Olympic Winter Games, then estimated at \$100,000, should be turned over to the town to be applied toward reducing this bonded indebtedness; with the further statement that the consequent increase in local taxation would not exceed the amount of the current health district tax (a tax rate of about 2 mils, or an annual amount of about \$10,000). This proposition was submitted to the voters on June 4, 1929, and

carried by a vote of over five to one, an unprecedented majority.

Legal technicalities delayed the issue of these bonds until March, 1930, following an enabling act by the state legislature, thereby compelling the committee to borrow locally to meet its most immediate needs. These consisted primarily of completing the options on the land for the stadium, and employing the German engineer, Stanislaus Zentzytzki, to make surveys and plans for the bob-run; for no regular paid organization was *set* up until April, 1930, and legal obstacles to the use of state land precluded any possibility of building the Olympic bob-run in time for the winter of 1929-30, as had been first hoped.

First State Appropriation

In fulfillment of the pledge of co-operation contained in the concurrent resolution of Jan 14, 1929, and superseding the further tentative action taken in 1929 in support of Lake Placid's proposal to the I O C, the legislature past and the governor signed on April 22 an act (Chapter 677, Laws of 1930) creating a temporary state commission, "To co-operate in preparing for, organizing, providing facilities for, and conducting the III Olympic Winter Games at Lake Placid, in the year 1932," and appropriating for that commission \$125,000. This appropriation was intended primarily to cover the Olympic bob-run and if necessary the separate skeleton run, which was not eliminated from the official requirements till the month following. Meantime, however, in March, 1930, the final Court of Appeals decision had eliminated all possibility of locating the Olympic bob-run on the most favorable site, on state land, with the result of increasing largely the cost of construction on the alternative site finally selected on Mt Van Hoevenberg.

Relations With American Olympic Association

It was recognized from the beginning as not merely appropriate and desirable but absolutely essential to appeal to the general public, especially in the northeastern United States, to bear a substantial portion of the

financial burden of organizing and conducting the III Olympic Winter Games. The attitude of the Organizing Committee toward this undertaking was express to the quadrennial meeting of the American Olympic Association, held November 19, 1930, as follows:

"While it would be possible to secure such support by an independent national subscription, our Committee feels strongly that an independent national organized effort is hardly warranted by the amount involved, and chiefly that to canvass the country independently of the A O A in support of any Olympic purpose would be an unwarrantable interference with the customary quadrennial subscription of the A O A. The most reasonable solution would seem to be that first suggested by President Hammond last winter and since discussed informally with several members of the executive committee: for the A O A to budget an appropriate amount for the national support of the III Olympic Winter Games, to be raised as a part of the one general national Olympic subscription under the general powers of the A O A. This would be no more difficult a task than the usual American Olympic subscription, for the holding of the Olympic Games both winter and summer in the United States reduces very largely the amount required to finance the American participation only."

As the Organizing Committee is in principle the creation of the National Olympic Committee, in those cases in which the National Olympic Committee does not itself directly organize and conduct the Olympic Games, and, as such, had always in previous Olympiads enjoyed the full support of the parent organization, it was assumed that co-operation to mutual advantage could be relied upon. Much to the disappointment of the III Olympic Winter Games Committee, however, the American Olympic Association and its executive body, the 1932 American Olympic Committee, adopted a policy of complete non-co-operation financially. The quadrennial meeting was noncommittal; the executive committee meeting on December 29, 1930, chiefly concerned with its primary task of financing the American participation in the 1932 Olympic Games, definitely disapproved of any financial co-operation or assistance; and at the annual meeting of the III Olympic Winter Games Committee, held at Lake Placid January 3 and 4, 1931,

the principal officers and leading members of the American Olympic Association, who had been made either directors or active members of the III OWG Committee for the purpose of securing full understanding and close co-operation on mutual problems, used their influence to pass a restrictive resolution which sought to limit the fund-raising efforts of the Organizing Committee outside of New York state to "a selective canvass . . . approaching directly without general publicity a limited number of carefully selected names."

General Fund Canvass

It had been determined from the beginning to concentrate the principal effort to secure funds from the general public during the winter season a year before the Games. Had the Games been scheduled for 1930, such a canvass would have presented little difficulty, but even if changed economic conditions could have been foreseen, it was clearly out of the question to arouse the active interest necessary to such a campaign more than a year ahead of the event. Definite plans for this canvass, which should have been fully worked out in the fall of 1930, were held back at least two months beyond the latest desirable date in the hope of effecting co-operation with the American Olympic Committee. The moment that this possibility was definitely eliminated, tentative plans held in abeyance were pushed to completion as rapidly as possible.

It seemed evident to the Organizing Committee that the need for immediate and intensive effort under extraordinarily difficult conditions required the assistance of an experienced professional organization, and after careful consideration H H Railey & Co of New York city were selected. In line with the restrictive resolution adopted to meet the views of the American Olympic Association, it was determined to concentrate on an

appeal for substantial amounts from a limited number of carefully selected names, chiefly in and about New York state, commencing with New York city, Philadelphia, and Boston, and extending to the larger cities of upstate New York as circumstances might warrant or permit. The campaign was thoroughly organized on a high plane, emphasizing the obligations of international hospitality and the social values of aroused interest in winter sports, and vigorously conducted, with a total objective of \$250,000 as the contribution of the general public toward a total budget of \$1,050,000 (reproduced on pages 82-83) ; but while the efforts of the committee met with general good-will and good wishes, the total of funds actually secured was extremely disappointing, being but little more than 15% of the original objective.

Analyzed regionally, the returns from the general fund canvass were:

New York city and vicinity.	\$18,939.93
Philadelphia and vicinity..	12,825.00
Boston and vicinity	3,712.00
All other territory.....	<u>3,100.00</u>

Total \$38,576.93

Analyzed by amounts given, these same returns were:

1 contributor of \$5,000..	\$ 5,000.00
22 contributors of \$1,000	22,000.00
4 contributors of \$500 . .	2,000.00
142 contributors of lesser amounts	<u>9,476.93</u>

Total..... \$38,576.93

These figures include the returns from a continuation of this canvass in the fall of 1931, but do not include the so-called regional subscriptions, which eventually yielded \$7,678.13 from Saranac Lake's pledge of \$10,000, and \$500 from Plattsburg.

**III Olympic Winter Games
INTERMEDIATE BUDGET
Revised to January 15, 1931
EXPENDITURES**

Construction & Equipment

<i>Stadium</i>			
Land	\$50,000		
Grading & sodding..	71,500		
Culvert & retaining walls..	15,500		
Stands for 5,000.....	10,000		
Equipment	8,000		
		\$155,000	
<i>Bob-run</i>			
Access road..	\$ 9,500		
Earthwork	95,000		
Engineering	20,000		
Water supply..	18,000		
Electric equipment..	5,000		
Bus & trucks..	22,000		
Tractors, trailers & tools.....	6,000		
Shelters	25,000		
Bobs	14,500		
		215,000	
<i>Indoor Ice Arena</i>			
Construction		210,000	
<i>Ski-bill</i>			
Grading, tower & stands..	\$25,000		
Additional stands for 4,000 & grading..	10,000		
		35,000	
<i>Other Local Facilities</i>			
Ski trails..	\$ 1,500		
Housing & feeding..	30,000		
Locker rooms, etc.....	25,000		
Sanitary & other facilities..	3,500		
		60,000	\$ 675,000
<i>Maintenance</i>			
Stadium 1930-31	\$ 3,000		
Stadium 1931-32.....	4,000		
Bob-run 1930-31	12,000		
Bob-run 1931-32..	10,000		
Arena 1931-32..	6,000		
Other athletic facilities 1931-32..	5,000		
Housing & feeding subsidies..	20,000		
		60,000	60,000
<i>Organization</i>			
Printing & publicity..	\$80,000		
Office expenses.....	60,000		
Travel	17,500		
Entertainment	12,500		
		170,000	170,000
<i>General</i>			
Medals, diplomas & badges..	\$10,000		
I O C official payments..	5,000		
Local transportation..	5,000		
Health & safety..	5,000		
Music	5,000		
Decorations	5,000		
Other local expenses..	10,000		
		45,000	15,000
<i>Reserve for Contingencies</i>			100,000
Total expense.....			\$1,050,000

RECEIPTS

<i>Town of North Elba</i> bond issue, underwriting		
Gate receipts, estimated	\$100,000	
Deficit, estimated	100,000	
		\$200,000
<i>County of Essex</i> (anticipated)		50,000
<i>New York State</i> OWG Commission Chapter 677, Laws of 1930		125,000
<i>New -York State</i> 1931 (anticipated)		375,000
<i>Lake Placid Club</i> (Ski-hill)		25,000
<i>Regional subscriptions</i>		
Saranac Lake	\$ 10,000	
Other	15,000	
		25,000
<i>General Fund</i>		
To be secured by public canvass		250,000
Total		\$1,050,000

Intermediate Budget

Unlike the first budget which confined itself to the probable expenditure of the funds to be raised by the Town of North Elba, the revised budget, reproduced above, which formed the basis of the general fund canvass and of the commission's request to the 1931 state legislature, sought to include the entire anticipated cost of carrying thru the III Olympic Winter Games on a high standard. This added to the original budget the entire cost of building and maintaining the Olympic bob-run, as increased by the first change of location, the entire cost of the projected indoor ice arena, now recognized as being of very great importance, together with a reserve of about 10% for contingencies. The arena was considered of primary importance as insurance against untoward weather conditions, to maintain uniformly high standards of ice conditions, especially for figure-skating and curling, and as the only possible means of arranging the ten - day program without double - header events, by utilizing every evening as well as the mornings and afternoons. The budget also included such increased costs of construction and organization expenses as could by this time be foreseen, together with an item of \$25,000 on both the income and outgo sides, recording the co-operation of Lake Placid Club in providing the Olympic ski-hill, which saved the Organizing Committee at least that amount-the Olympic ski-hill at

St Moritz having cost their organizing committee over \$50,000. It is interesting to note that altho certain expenditures inevitably increased beyond the estimate budgeted at this time, the Organizing Committee was able by constant and careful retrenchment to hold the final budget down to slightly below the same total, which the final expenditures exceeded by less than 3%.

Thru the efforts of the New York State Olympic Winter Games Commission, with the whole-hearted support of the legislative leaders and the co-operation of Governor Roosevelt, the state, recognizing the unprecedented per capita burden already assumed by Lake Placid, appropriated as of February 26, 1931, the full \$375,000 called for by the revised budget. At this time it was the expectation of all concerned that this would be the final contribution which the state would be asked to make.

Budget Control

By reason of the number of organizations co-operating directly in the undertaking, including the III Olympic Winter Games Committee, the New York State Olympic Winter Games Commission, and the Town of North Elba, as well as other related or subsidiary boards or committees, it gradually became increasingly difficult to exercise a rigid check on all expenditures to assure that the combined total should remain within the consolidated budget. Accordingly on February 5,

1931, the Organizing Committee appointed an audit committee, consisting of F B Guild, president of the Bank of Lake Placid, Martin Ryan, mayor of the Village of Lake Placid, and J B Hurley, an influential business man and former mayor, who should pass on all bills before they were approved for payment by Olympic funds, from whatever source. At the same time, they appointed Mr Guild as controller, and appealed to all the co-operating organizations to subject themselves to this unified control by incurring no obligation of whatever nature till approved in writing by the controller. In the absence of Mr Guild from the community, Mr Hurley acted as assistant controller. All organizations concerned responded affirmatively, and a rigid system of requisitions was set up, which provided effective check.

A finance committee, consisting of Willis Wells, chairman, Irving Griswold, and F B Guild, had been set up on April 21, 1930, to study and report on the major financial aspects of the task, but for about a year thereafter direct supervision of expenditures was retained by the directors and the executive committee. On April 18, 1931, this finance committee was increased by adding T Harvey Ferris and Basil Harris, and thereafter functioned much more actively in co-operation with the audit committee.

Second Bond Issue

The failure of the general fund canvass to produce anywhere near the required amount resulted in a critical situation which was finally faced in mid-June, 1931, immediately on Dr Dewey's return from attending the Congress of the International Skating Union in Vienna. The latest date for commencing construction on the Olympic arena, if it was to be completed before 1932, was at hand, and unless immediately available funds could be secured to offset this deficiency, the Olympic arena must be wholly abandoned. A careful re-study of the budget, eliminating all items deemed less important than the Olympic arena, indicated that at least \$150,000 more would be required. The community had already obligated itself for \$200,000, of

which it expected to get back from the gate receipts only about 50%. The next legislative session was more than six months away, and the general fund canvass had already exhausted all sources of appeal for private funds. Time was too short for any but community action. In this dilemma it was determined to ask the community to furnish the immediate funds by authorizing a further bond issue of \$150,000, provided that assurance could be obtained from the legislative leaders and the governor that in this event they would support at the next session a deficiency appropriation to relieve the community of at least a part of this added burden. The promise of the legislative leaders of both parties in both houses, and of Governor Roosevelt, to support such a deficiency appropriation of \$100,000 was obtained late in July. The appeal was made to the community stressing the permanent local benefits of the arena as a recreational center for resort visitors and the 'community, a place of assembly for the surrounding region, and a headquarters for larger conventions than could be elsewhere accommodated between New York and Montreal, and on July 30, the taxpayers of the park district of the Town of North Elba voted to authorize a bond issue of \$150,000 for this purpose.

In order to make even this last-resort solution feasible, it was necessary for the Olympic Committee to buy and to grade the site finally determined upon by the majority, in advance of the vote which was to decide whether the arena could be built at all, and this was done as a venture of faith, the site being bought in June and graded during July to the point where its level surface would have provided valuable parking space for the community in the event that the arena had not been built.

Under the financial plan adopted it was hoped to issue instead of the 30-year bonds authorized, temporary certificates of indebtedness to run for six months, and to retire these before maturity with the aid of the state deficiency appropriation and a part of the gate receipts. Unfortunately, however, the increased expenditures resulting from the uniquely unfavorable weather conditions be-

fore and during the Games, together with the substantially reduced income due to this unseasonable weather, even more than to the unprecedented economic conditions, compelled the use of all funds from all sources, and altho the state leaders provided in due course the full deficiency appropriation of \$100,000 which had been promised, the severe demands on the state budget made it impossible for them to assume at that time any share of the additional burden, which was thus placed on the community.

Essex County Co-operation

As early as the fall of 1930 the supervisors of Essex county initiated plans looking toward recognizing the great and lasting benefits to the whole surrounding region resulting from the holding of the III Olympic Winter Games at Lake Placid, in Essex county, by contributing \$50,000 to the Olympic budget; and this prospective contribution was taken into account in determining the amount of the second bond issue. It became available finally on October 31, 1931, just when it was most needed to continue the arena construction, and was thus of invaluable assistance in meeting one of the most critical and important situations in the whole project.

Final Budget

As soon as the principal contracts for the construction of the Olympic arena had been

awarded, the finance committee and directors made a final re-study of the whole Olympic program of income and expenditures, resulting in the final budget, reproduced on pages 86-87, which was approved by the directors on September 11, 1931. As compared with the intermediate budget of eight months before, the chief changes are in the reduction of returns from the general fund canvass and regional subscriptions by \$230,000, in part made good by the additional \$150,000 provided by town and state, and by a reduction of \$50,000 in the reserve for contingencies, justified by the closer estimates made possible by the near approach of the Games. It will be noted that this budget shows a deficit of \$75,000 unprovided for. This situation called for the most careful study and control of all expenditures prior to the Games, for the final \$100,000 from the state would not be available till after the Games, so that the full \$150,000 provided by the town was already absorbed. The shortage was thus a real one, and not merely a bookkeeping figure. The situation was met by arranging to defer payment of as many last-minute obligations as possible till after the Games, taking full advantage of all legitimate minor sources of unbudgeted income, such as pre-Olympic events at the bob-run, ski-jump, and arena, and arranging with the Town of North Elba to make temporary use of the advance gate receipts pledged to them against the original bond issue.



—International Newsreel

Olympic skaters make beautiful silhouette rounding the first turn in one of the heats of the 10,000-meter speed-skating race

Final Statement
Receipts and Expenditures

The final consolidated statement of receipts and expenditures from all sources is arranged substantially in the order of the final budget and placed after it for convenient comparison. It will be noted that in spite of the extraordinary difficulties encountered during the final weeks of the task, the total expenditures exceed the budget es-

timate by less than 3%—an achievement on which the Organizing Committee may well congratulate itself. On the other hand, as compared with the reasonable expectations of the committee at the time that the final large commitments were made, the Town of North Elba, as the final underwriter of the whole project, finds itself with a deficiency of about \$235,000, which is \$110,000 larger than the \$125,000 which it anticipated and faced.

III Olympic Winter Games
FINAL BUDGET
Revised September 11, 1931
EXPENDITURES

Stadium

Land	\$ 48,750	
Grading & sodding	77,500	
Culverts & walls	10,750	
Stands & waxing rooms.....	11,000	
Equipment	9,000	
		\$ 157,000

Bob-run

Access road.....	\$ 10,500	
Earthwork	107,500	
Engineering	24,000	
Water supply.....	22,500	
Electric equipment	7,000	
Bus & trucks.....	12,000	
Tractors & trailers.....	15,500	
Shelters, control stations, safety rails and stands	28,000	
Bobs	20,000	
		247,000

<i>Ice Arena</i>		225,000
------------------------	--	---------

Ski-hills

60-meter ski-hill (construction & equipment)	\$ 25,000	
30-meter practice hill.....	2,500	
Stands and necessary grading.. ..	8,500	
		36,000

Other Local Facilities

Ski trails.....	\$ 3,500	
Housing & feeding.....	5,000	
Locker rooms.....	4,000	
Sanitary facilities.....	2,000	
	<hr/>	14,500

Maintenance

Stadium 1930-31-32.....	\$ 9,000	
Bob-run 1930-31-32.....	45,000	
Arena 1931-32.....	8,000	
Other facilities 1931-32.....	5,000	
Housing & feeding subsidies.....	2,000	
	<hr/>	69,000

Organization

Printing & publicity (including ticket distribution).....	\$ 87,500	
Office administration.....	70,000	
Travel & entertainment.....	45,000	
	<hr/>	202,500

General

Medals, diplomas, & badges.....	\$ 4,500	
IOC payments.....	3,000	
Local transportation.....	5,000	
Health & safety.....	5,000	
Music	5,000	
Decorations	5,000	
Other local expenses.....	16,500	
	<hr/>	44,000

Reserve for Contingencies 50,000

Total

 \$1,045,000

RECEIPTS

Town of North Elba bond issue (1929) underwriting		
gate receipts, estimated.....	\$125,000	
Town deficit, estimated.....	75,000	
	<hr/>	\$ 200,000
Town of North Elba (1931).....		50,000
County of Essex.....		50,000
NY State appropriation (1930-31).....		500,000
NY State deficiency appropriation (1932, anticipated)		100,000
Lake Placid Club (ski hill)		25,000
Regional subscriptions (Saranac Lake)		10,000
General Fund-secured by public canvass.....		35,000
		<hr/>
Total.....		\$ 970,000
Budget deficit.....		75,000
		<hr/>

\$1,045,000

STATEMENT OF RECEIPTS AND EXPENDITURES
III Olympic Winter Games Committee
EXPENDITURES

Stadium

Land	\$ 48,555.88	
Culverts & walls	10,685.39	
Grading & sodding	76,155.01	
Stands, bleachers, and waxing rooms	18,392.55	
Equipment	2,090.94	
	<hr/>	\$ 155,879.77

Bob-run

Access road	\$ 11,159.99	
Earthwork	105,273.40	
Engineering	22,319.91	
Water supply.....	23,477.38	
Electrical equipment.....	4,727.30	
Bus and trucks.....	11,590.55	
Tractor, trailers and tools.....	15,645.16	
Shelters, stands, safety rails, etc.		
Club-house	16,500.00	
Bob garage.....	5,000.00	
Other construction.....	9,570.12	
Bobs and equipment.....	18,420.47	
	<hr/>	243,684.28

Ice Arena

Land and preparation.. ..	\$ 46,992.74	
Construction of building.....	208,335.46	
Refrigerating plant.....	29,325.79	
Equipment	9,428.69	
	<hr/>	294,082.68

Ski-hills

Lake Placid Club hill.....	\$ 25,000.00	
30-meter practice hill.....	4,210.12	
Additional stands & necessary grading.....	8,510.80	
	<hr/>	37,720.92

Other Facilities

Ski trails.....	\$ 3,142.63	
Housing & feeding.....	495.41	
Locker rooms.....	2,968.48	
Sanitary facilities.....	807.65	
Public-address system.....	3,856.82	
	<hr/>	11,270.99

Maintenance

Stadium 1930-31.....	\$ 3,579.50	
Stadium 1931-32.....	7,275.17	
Bob-run 1930-31.....	19,582.86	
Bob-run 1931-32.....	31,164.44	
Arena 1931-32.....	17,518.29	
Other facilities, including materials and wages.....	5,010.73	
Gas and oil.....	1,440.91	
Housing subsidy.....	3,068.90	
	<hr/>	88,640.80

<i>Printing & Publicity</i>		
Publicity posters.....	\$ 5,709.09	
Publicity and General Rules Books.....	21,806.24	
Publicity service and salaries.....	22,009.99	
General printing.....	8,156.10	
Printing tickets and advance sale.....	2,756.65	
Official report.....	7,371.61	
Local publicity & photos.....	3,645.90	
Printing daily programs.....	2,114.45	
Stickers in 4 languages.....	1,872.42	
Art work.....	2,409.91	
News releases.....	1,057.30	
Clipping service.....	1,077.19	
Other expenditures.....	9,053.71	
	<hr/>	89,040.56
<i>Office</i>		
Salaries (General Administrative).....	\$ 49,121.62	
Salaries (General Fund Canvass)	15,575.00	
Stationery & stamps.....	2,687.14	
Telephone, telegraph & cable.....	5,176.08	
Office partitioning & alterations.....	2,343.98	
Office equipment.....	2,669.48	
Other office expenses.....	1,822.14	
	<hr/>	79,395.44
<i>Travel and Entertainment</i>		
N Y State Commission hotel and travel.....	\$ 12,536.99	
III OWG Committee travel by officers, directors and executive staff	13,069.58	
Entertainment visiting officials and athletes.....	2,712.26	
Living expenses officials and official guests during Games		
III OWG Committee-technical delegates.....	1,279.60	
N Y State OWG Commission.....	3,330.24	
Essex County Park Commission.....	2,449.30	
	<hr/>	35,377.97
<i>General Expenses</i>		
Medals and diplomas.....	\$ 3,187.70	
IOC payments.....	2,400.00	
Local transportation.....	3,835.01	
Health and safety.....	783.18	
Music	3,193.00	
Decorations	2,540.88	
Legal fees.....	9,094.30	
Ticket distribution during Games.....	6,177.43	
Exhibitions, hockey games, and demonstrations.....	2,740.78	
Other expenses.....	4,978.56	
	<hr/>	38,930.84
Total Expenditures.....		\$1,074,024.25
Cash and Fund Balance, May 31, 1932.....	\$145,203.95	
Less reserve for contracts and accounts payable.....	33,506.54	
	<hr/>	\$111,697.41
Add Accounts receivable, including estimated salvage.....	3,914.23	
Total Balance.....	<hr/>	115,611.64
		<hr/>
		\$1,189,635.89

RECEIPTS

Town of North Elba bond issue, June 4, 1929 (underwriting gate receipts)	\$200,000.00	
Town of North Elba bond issue, July 30, 1931.....	\$150,000	
<i>Less</i> anticipated N Y State deficiency appropriation.....	100,000	
	50,000.00	
County of Essex appropriation, Oct 31, 1931.....	50,000.00	
N Y State appropriation, April 22, 1930 (Bob-run).....	125,000.00	
N Y State appropriation, Feb 26, 1931 (General).....	375,000.00	
N Y State appropriation, Jan. 12, 1932 (Deficiency) (not available till March, 1932).....	100,000.00	
Lake Placid Club ski-hill.....	25,000.00	
Regional contributions.....	8,178.13	
General Fund Canvass.....	38,576.93	
	\$ 971,755.06	
<i>Total income from budgeted sources.....</i>		
<i>Other Income</i>		
Incidental gate receipts (other than III Olympic Winter Games)		
Arena	\$ 8,897.79	
Bob-run	2,453.60	
Other	520.70	
Concessions		
9581 daily programs @ 25 cents.....	\$2,395.25	
5476 souvenir books @ 50 cents..	2,738.00	
	\$5,133.25	
<i>Less</i> 20% sales commission & adjustments..	1,035.60	
	\$ 4,097.65	
Restaurants at town hall, stadium, arena, bob-run.....	1,582.55	
Miscellaneous sources		
Sales of dirt from grading..	2,032.88	
Estimated revenue from salvage of minor equipment & supplies.....	2,500.00	
Other	2,380.06	
	24,465.23	
Balance of 1931 Town of North Elba bond issue.....	100,000.00	
Net gate receipts III Olympic Winter Games.....	93,415.60	
	\$1,189,635.89	
<i>Grand Total from all sources..</i>		

Audited and certified correct by III Olympic Winter Games Committee:

F B Guild }
 J B Hurley } *Audit Committee*
 Martin Ryan }

Godfrey Dewey, *President*
 Willis Wells, *Vice-president*
 Ernest F Gamache, *Secretary*
 Wm J O'Hare, *Treasurer*

Liquidation-The Final Problem

The Organizing Committee, any Olympic Organizing Committee, is not a permanent organization. Its powers expire with the period of the Games. Assets and liabilities remain, however, and must be so liquidated as to fulfill its obligations and protect its members from personal liability before the committee can safely be dissolved.

In the case of the III Olympic Winter Games Committee, because of the methods of financing adopted, the procedure to be adopted was evident from the start, and has been adhered to as closely as the available resources made possible, with the following results.

The Olympic bob-run, built, equipt, and maintained wholly by state funds on land conveyed thru the town to the state by perpetual easement, reverted on May 15, 1932, to the control of the state, as contemplated in the act creating the State Commission and making the first appropriation, which provided that "After the winter season of 1931-32 such run or slide, if provision be made by appropriation for its maintenance, shall be maintained for the use of the public, under the direction of the Conservation Department, and subject to its rules."

The Olympic arena, built and equipt chiefly by town and county funds, on land bought for the purpose by the town, was transferred on May 31, 1932, to the Town of North Elba.

The site of the stadium, owned or least by the town, reverted, of course, to the town, the temporary stands and enclosures being removed and salvaged by the committee. The Lake Placid Club ski-hill, merely placed at the disposal of the committee for the Olympic season, remained, of course, the property of the Club following the Games. Other minor equipment and supplies were either salvaged and the proceeds included in the final funds of the committee, or, where such procedure seemed more advantageous, turned over directly to the Town of North Elba.

Disposal of Funds

The procedure to be followed in disposing of the funds remaining in the hands of the committee was equally predetermined, but the results, in spite of the utmost efforts of the committee, fell far short of the promises made in full good faith to the community which underwrote their task. The original bond issue of \$200,000 less the estimated gate receipts of \$100,000, which was intended to be the total financial contribution of this little community of slightly less than 4,000 inhabitants, involved the assuming of a net bonded indebtedness of over \$25 per capita -an enormously greater per capita burden than ever before assumed by any community, large or small, on behalf of the Olympic Games, summer or winter. By contrast, the \$1,250,000 first provided by Los Angeles for the Xth Olympic Games would represent, even tho none of it came back thru gate receipts, only about \$1 per capita.

The second bond issue of \$150,000, voted by the community on the assumption that the gate receipts would thereby be increast about \$25,000 and that the state would later relieve the community of an additional \$100,000 of other Olympic burdens, represented the voluntary increase of this net

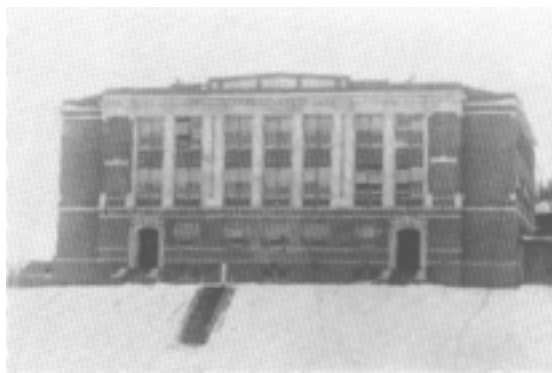

Lake Placid high school, where dressing-rooms and other facilities for the athletes were provided. This building also contained the press and telegraph rooms, as well as several offices used for conference purposes

bonded indebtedness to about \$31.25 per capita — certainly under present economic conditions a striking evidence of gameness and whole-hearted support of a task once undertaken.

Thus, thru a combination of circumstances largely outside the control of the Organizing Committee—chiefly the most unseasonable Adirondack winter weather in the whole 147 years' history of the United States weather bureau—the community received, to apply against its obligations, instead of the \$225,000 anticipated, about \$115,000. If this figure stands as the final settlement, it will raise the net bonded indebtedness of the community assumed on account of the III Olympic Winter Games to the staggering figure of \$58.75 per capita. If only half of the final deficiency of \$110,000 could be met from any other source it would leave the final net bonded indebtedness at \$45 per capita instead of the \$25 originally assumed.

The disposal of the net fund balance remaining in the hands of the Committee is shown herewith.

LIQUIDATION OF FUNDS

Fund Balance, May 31, 1932, as above.....	\$115,611.64
Net Gate Receipts III Olympic Winter Games.	
Paid Town of North Elba May 31, 1932, against \$200,000 bond issue underwriting.....	93,415.60
	<hr/>
Balance to be paid Town of North Elba against \$150,000 bond issue	\$ 22,196.04
Paid Town of North Elba May 31, 1932, on account to meet immediate interest payments.. . .	11,922.53
	<hr/>
Balance held in treasury until final settlement of pending obligations.....	\$10,273.51

In closing their financial report, the Organizing Committee wish to bear witness to the high courage, perseverance, and loyal support with which the citizens of Lake Placid have shouldered and' carried, not merely the normal burdens voluntarily assumed by the community, but also those added burdens which highly abnormal circumstances seem to have forst upon them.



Lakes Mirror and Placid with Whiteface Mountain in the background

Publicity

Organized publicity for the III Olympic Winter Games, naturally one of the most important and ambitious parts of the entire Games program, began on September 15, 1930, when Otis Peabody Swift, a representative of James F Newcomb & Co of New York city, established his headquarters in Lake Placid. Considerable preliminary publicity, however, had been done during the preceding year.

Prior to September 15, 1930, a contract was signed between the Organizing Committee and the Newcomb Company whereby the latter would handle Olympic publicity from that time until the conclusion of the Games in 1932. The Newcomb Company was chosen for this work after months of investigation on the part of the Organizing Committee of firms competent to handle Olympic publicity in all its ramifications.

The plan as originally projected and eventually carried out entailed having two publicity offices, one in Lake Placid at the headquarters of the Organizing Committee and the other in New York in the Newcomb offices, where close contact could be established and continually maintained with newspapers, magazines, and the major avenues of distribution for O W G publicity material.

Charles E Prins, vice-president of James F Newcomb & Co, was in charge of the Olympic Winter Games account for his organization. He supervised the production of various pieces of printed matter and originated many of the plans subsequently developed for "merchandising" the Games to the public of both Europe and North America.

Personal contacts with newspapers and magazines and the release of "spot" news in New York were handled by Howard Acton of the Newcomb organization. An experienced newspaper man, Mr Acton greatly facilitated the smooth flow of Olympic publicity from the Organizing Committee to the public.

Mr Swift directed the publicity program from Lake Placid, which included getting

out "spot" news stories and the preparation of considerable publicity matter, until he was transferred to New York on March 1, 1931, and was succeeded by George M Lattimer. All Olympic booklets and printed matter were prepared in Lake Placid under the general supervision of the publicity committee, F B Guild, chairman, and were distributed from both New York and Lake Placid.

This system of dual publicity headquarters worked out with entire satisfaction to the committee and to the public. It made possible the generation of news where it occurred in Lake Placid and its release at the best point of contact with publicity media in New York city.

The Publicity Plan

The publicity plan for the III Olympic Winter Games was divided into three major divisions:

- I Foreign Publicity — September, 1930, to March, 1931
- II Domestic Publicity—September, 1930, to February, 1932
- III Publicity during the Games—February 4-13, 1932

I Foreign Publicity

The work done abroad in publicizing the Lake Placid Games will be considered first. It was thought best to centralize the bulk of this effort during the latter part of 1930 and the first part of 1931 in order to have it well under way and working approximately a year prior to the beginning of the Games.

Foreign publicity had two main objects:

- 1 To arouse such interest in the Games abroad that all countries would send teams of maximum size to Lake Placid and to arouse such popular enthusiasm that the task of raising funds to finance teams to enter the Lake Placid Games would be vastly simplified.

III Olympic Winter Games

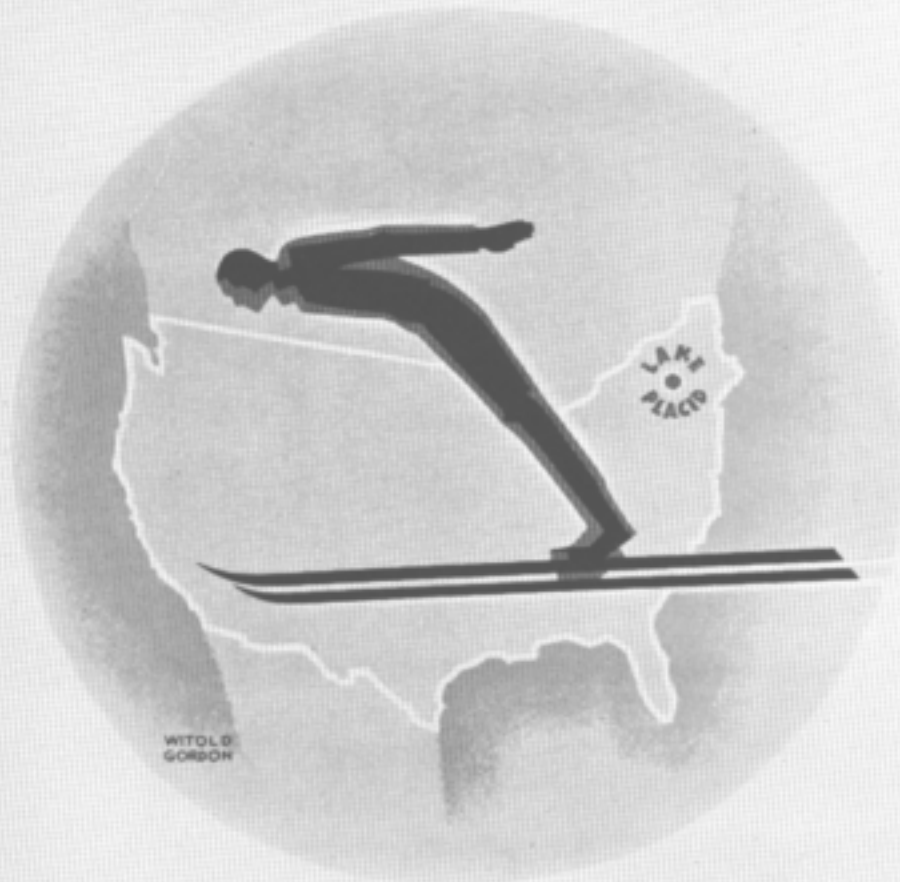

Lake Placid, USA
February 4-13, 1932

First Games poster

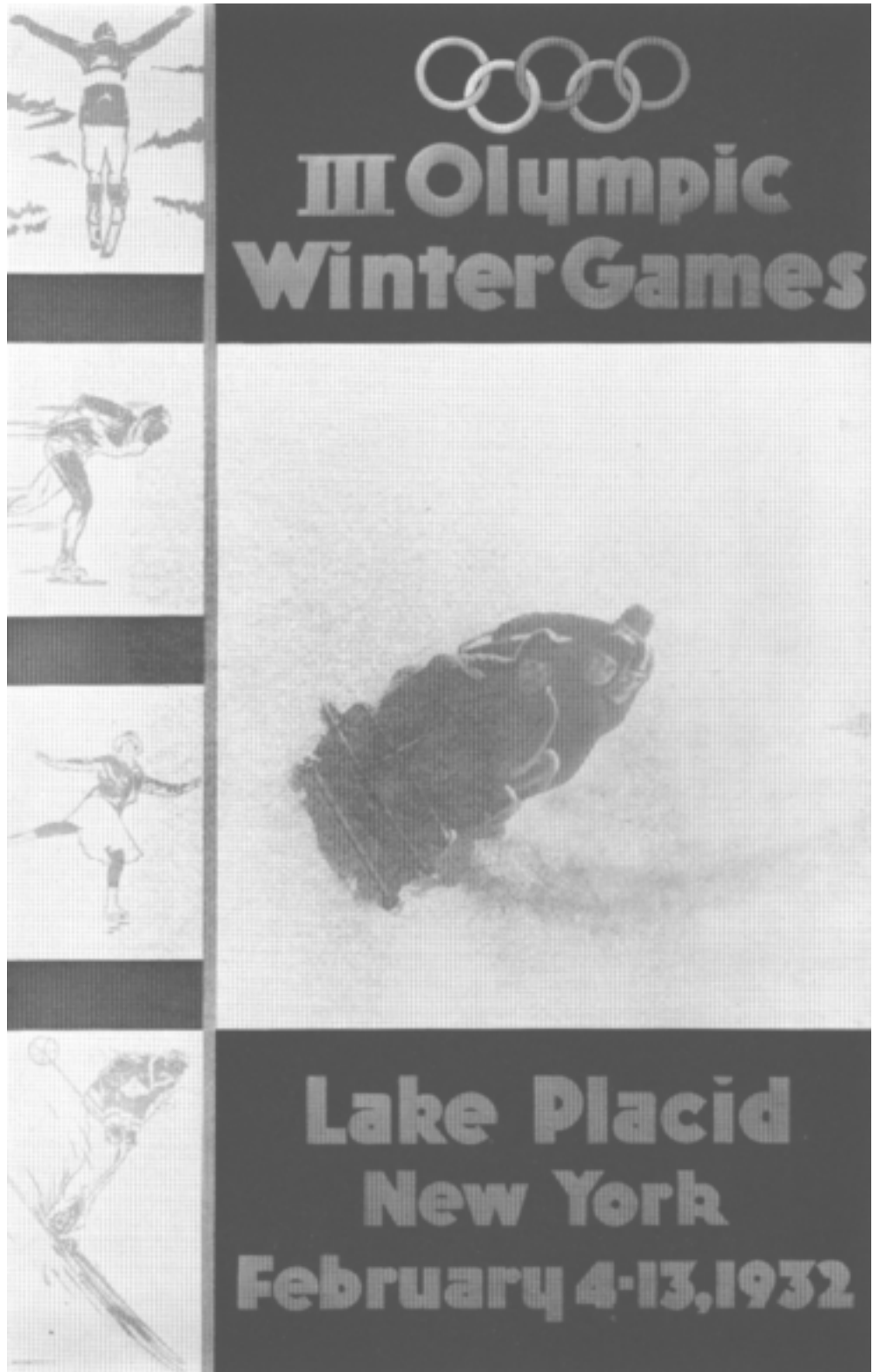

Second Games poster

- 2 To induce as many individuals as possible to come to the United States and to Lake Placid to attend the Games.

The first step in carrying out this program was the employment of Bjorn Blix as international secretary to travel in Europe establishing contacts with various Olympic and winter-sports organizations, as well as national and international sports bodies and co-operating organizations, during the period when the general publicity program abroad was at its height. Mr. Blix's work is discussed in detail in the section of this book entitled international Secretary.

Immediately upon the beginning of the publicity program in 1930 a carefully selected list of European newspapers and magazines was made up. To these were sent at frequent intervals news stories dealing with the progress being made at Lake Placid in preparation for the Games. These releases were printed in English, French, and German, and were distributed according to the language preferred in the particular countries to which they were sent. This part of the foreign publicity continued up to the beginning of the Games. Much space was given in European periodicals to Winter Olympic news. Interest was aroused and maintained at high pitch even in spite of the exceptionally bad economic conditions prevailing throughout the world. Clippings sent to the Lake Placid office from foreign newspapers and magazines indicated the scope and effectiveness of this publicity.

Photographs of Lake Placid winter scenes and sports facilities being made ready for the Games were in great demand abroad, particularly in the nations that planned to send large teams to the Games. Quantities of these photographs were taken in Lake Placid during the winter of 1930-31 and were sent abroad. Magazines, newspapers, and clippings coming to Lake Placid proved how widely this photographic material was used, and subsequent conversations with officials, competitors, and European spectators at the Games indicated how productive this publicity was in achieving the ends desired.

Distribution of Printed Matter Abroad

Publicity material prepared in the fall of 1930 primarily for use abroad was as follows:

- 1 Preliminary Program
- 2 Preliminary Information Booklet
- 3 First Games Poster
- 4 First Publicity Booklet
- 5 Sticker Stamps

Specific information with respect to the distribution of these pieces of material is given in the chart "Distribution of III O W G Publicity Material," included in this section. World-wide distribution of posters, booklets, and stickers began in December, 1930. The first poster (3) and first publicity booklet (4) were printed in English, French, and German, while the sticker stamps were produced in English, French, German, and Spanish. Booklets 1 and 2 were printed in English only. Booklet 4 carried full information as to the arrangements for the Games perfected up to that time.

Approximately 15,000 posters, 200,000 booklets and a quarter of a million sticker stamps were distributed throughout the world before the spring of 1931. The distribution naturally centered in Europe and was carried out according to a systematic plan developed prior to the beginning of the work. Effective assistance was rendered in the distribution of this material by the American Express Company, Thomas Cook & Son, Olympic committees, sports federations, steamship and railroad lines, and travel bureaus. Many booklets carried on their back covers the imprints of the travel agencies distributing them. The fact that this distribution was accomplished approximately a year in advance of the Games made it possible for European nations to plan on full representation and for sports enthusiasts to make their plans to attend the Games in person.

Reports coming to Lake Placid from such far-away points as Japan, China, Australia, and South Africa indicated that the publicity program was truly world-wide in its appeal and in its effect.

II *Domestic Publicity*

The domestic publicity program-publicity thruout the United States and Canada-as has been noted, began in September, 1930, and continued until the opening of the Games on February 4, 1932. Naturally the main abject of this part of the program was to arouse the maximum interest in the Games and insure as a result maximum attendance at the various events.

Below are listed the major means used to achieve this result:

- 1 Frequent releases to newspapers and magazines
- 2 "Request" stories to newspapers and magazines
- 3 Photographs
- 4 Distribution of printed matter
 - a Sticker stamps
 - b Second Games poster
 - c Second publicity booklet
 - d Essex County O W G booklet
 - e Bob-run booklet
 - f First Games poster
 - g First publicity booklet
- 5 Merchandising and advertising tie-ups
- 6 Motion-picture news reels
- 7 Special motion-picture reels
- 8 Radio
 - a Special broadcasts on O W G
 - b Frequent mention of O W G in regular broadcasts
- 9 United States O W G postage stamp
- 10 Meetings of newspaper publishers

Specific information with respect to quantities and distribution of major publicity material may be obtained by referring to the chart "Distribution of III O W G Publicity Material" (page 108) .

No Advertising Space Purchast

One of the first decisions made by the Organizing Committee and its publicity counsel was that no advertising space for the Games would be purchast in any media.



—G Cleveland

George Hicks, National Broadcasting Company, ready to broadcast the Games to a waiting world

Two major considerations caused this decision. The committee's funds were too limited to enable it to reach effectively any great part of the public by means of paid advertising, and it was felt that there would be more than enough legitimate news of the Games to spread the story far and wide. This decision once made was adhered to strictly, and its wisdom was at all times obvious to those concerned with the promotion of the Games.

The first step in the publicity program was to build up a file of foreign and domestic newspapers and magazines that would utilize regularly the Games news releases that were to be sent out. To this end a questionnaire and return card were sent to a list of 1200 newspapers and magazines thruout the world, the bulk of this list being in the United States and Europe. From replies to the questionnaire and subsequent additions, this file was built up to 872 names.

Between October, 1930, and January, 1932, 69 general releases were sent to this list. This figure does not include special releases, request stories, or feature stories with

local angles sent frequently to newspapers in the North Country section of New York state. No general releases were sent out after early January, 1932, since news writers then began to gather in Lake Placid in large numbers to cover preparations for the Games for their own periodicals, and it was not necessary for the publicity office to send out any further material of its own.

Neither does the figure above include "spot" news stories that were given to the larger daily papers and the three major news services, Associated Press, United Press, and International News.

The publicity office subscribed to three clipping services from November, 1930, to December, 1931, two American and one European. After December, 1931, all clipping services were discontinued, as the volume of clippings became so great that the expense of purchasing, mounting, and filing them did not appear to be warranted.

While the number of clippings was so large that no attempt was made to secure figures on the exact lineage devoted to the Games, it may be stated here with the utmost conservatism that the III Olympic Winter Games received millions of agate lines of publicity.

Some figures on the distribution of Olympic publicity, compiled on June 1, 1931, may be of interest. After that date the volume of clippings became so large that they were no longer classified. Up to June 1, 1931, domestic Olympic publicity had appeared in 46 states and in 739 different cities. On the same date foreign publicity had appeared in 25 countries and in 87 cities. All clippings received at the Olympic publicity office including both news stories and pictures were mounted or filed.

Stories Sent on Request

Following the initial distribution of publicity material abroad and in the United States, requests for special stories on the Games began to reach the publicity office, most of them coming from magazines and asking for photographs as well as stories. Hundreds of newspapers and magazines carried these special stories and pictures.

Photographs

Probably no method of publicity carried the story of the Games as effectively to so many readers as did the photographs that were sent in huge quantities all over the world. Release of these photographs was made on request by particular periodicals and also thru the four major American news picture services, Wide World Photos, Associated Press Photo Service, International News Photos, and Acme News Pictures. International photographic coverage was secured in this way.

Distribution of Printed Matter

Games printed matter was distributed in two ways, to those making request for it by letter or otherwise and thru larger channels developed by the publicity organization.

As noted above, sticker stamps, the second poster, the second publicity booklet, containing ticket, housing, and other important Games information, Essex County O W G Booklet, and a special booklet dealing with the Mt Van Hoevenberg bob-run were the major pieces of printed matter used in the domestic publicity program. Quantities of the first poster and the first booklet were also distributed in the United States thruout the winter of 1930-31. As will be noted from the chart, major avenues of distribution for all this material included National Olympic Committees, American Express Company, sports organizations, transportation companies, tourist agents, clubs, hotels and resorts, chambers of commerce, business organizations, and newspaper and magazine resort bureaus.

During December, 1930, and January and February, 1931, posters and booklets were distributed to large department stores thruout the country, in order that they might arrange window displays simultaneously with pre-Olympic activities at Lake Placid. This distribution was practically finished in March, 1931. But during the spring and summer a continuous stream of posters, booklets and stickers-the latter for use on letterheads and envelopes-was sent out to organizations that had exhausted their initial supply.

Many of the posters, both first and second edition, were mounted in inexpensive frames and were prominently displayed in hotels, clubs, tourist agencies, and railroad stations thruout the Lake Placid "trading area."

The second phase of distribution began in September, 1931, when the second poster and second publicity booklet were received from the printer. Most of this material was distributed thruout Canada and the United States, with smaller shipments to the larger European centers.

Signs and Road Markers

As a means of stimulating additional interest in the Games on the part of the thousands of motorists using North Country highways during the summer, fall, and winter of 1931, four large signs urging travelers to stop at Lake Placid and inspect Olympic facilities were placed at strategic points on main trunk-line highways leading into Lake Placid. These signs were of metal in wooden frames, each sign measuring 12 feet (height) by 6½ feet (width).

Several smaller signs and markers calling attention to the Games were placed along highways leading into Lake Placid. Attractive signs were also placed at each Olympic facility.

The general color scheme employed on all signs and road markers was blue lettering on a white background.

Merchandising and Advertising Tie-ups

During November and December, 1931, and January, 1932, publicity efforts were concentrated on business organizations that could give the Games resultful merchandising and advertising tie-ups with their own products. In order to do this a four-page broadside was prepared, listing the publicity material available, with suggestions as to how it could be used. 10,000 of these broadsides were mailed to transportation companies, department stores, national advertisers, sporting goods stores, and manufacturers of winter-sports wear and equipment. As a result of this mailing more than 500 requests for Olympic publicity material were received.

Railroads were the principal users of this material. The New York Central Lines alone distributed more than 20,000 booklets over their entire system; displayed over 2,000 posters on their station billboards; and used more than 90,000 stickers on their correspondence. The New York Central also advertised the Games on dining-car and restaurant menus, in time-tables, and on blotters used in their club cars and station offices.

Included among other railroads using large quantities of publicity material were the Delaware & Hudson, New York, New Haven & Hartford, Pennsylvania, Great Northern, Southern Pacific, Canadian National, and Canadian Pacific.

Motor bus companies along the Atlantic seaboard also received and used booklets and posters.

Department stores in New York, Newark, Philadelphia, Hartford, Rochester, Syracuse, Buffalo, Chicago, Cleveland, Boston, and Montreal rendered excellent co-operation in publicizing the Games. All the larger department stores in New York, for example, had at least one or two windows displaying Olympic posters and photographs. Publicity booklets were distributed in their sports-wear and travel departments. Many stores featured the Olympic Winter Games in their newspaper advertising. In addition, representatives of the Organizing Committee gave talks on the Games in the stores themselves at the request of leading department stores and specialty shops. In many cases these talks were illustrated with motion pictures. In the John Wanamaker store in New York an audience of 2,500 heard the secretary of the III O W G Committee speak.

Many national advertisers used the Games as a basis for their 1931-32 winter advertising. Olympic booklets and posters were distributed to their dealers. Many Olympic photographs were used in house organs that also contained feature stories on the Games.

It may safely be said that advertisements of national advertisers featuring the Games and appearing in magazines of country-wide circulation were among the most important

factors in making the Games publicity so successful. This publicity was secured at practically no cost to the Organizing Committee.

Motion Picture Publicity

The Organizing Committee was able to reap the full benefits of motion-picture publicity. During the winter of 1930-31, news-reel companies had their crews and sound trucks in Lake Placid for an extended period, photographing winter-sports scenes and general pre-Olympic activities, particularly at the Mt Van Hoevenberg bob-run, where the first races ever held on a slide of international specifications on the North American continent were being staged. These news reels went all over the world and aroused market interest in what was going on at Lake Placid.

Representatives of the major news-reel companies of the United States were in Lake Placid during the winter of 1931-32, practically all the time from Christmas until the conclusion of the Games in February. Thousands of feet of film were "shot" and immediately releast thruout the United States and Europe. Footage taken included Olympic athletes training in Lake Placid for the Games, general winter scenes, and competitions and practice sessions at the various Olympic facilities. This thoro news-reel coverage was a powerful factor in stimulating interest in the Games during the few weeks immediately preceding the opening day.

Two reels of 35-mm film, one sound and one silent, were made up by the publicity department during the spring of 1931. These reels showed Lake Placid winter scenes, Olympic facilities, and preparations being made for the Games. They were used in talks on the Games given by members of the executive staff. Dr Godfrey Dewey, president of the III O W G Committee, took them abroad with him in May and showed them on the boat going over and coming back.

Radio

Millions of radio listeners learned of the III Olympic Winter Games by means of a series of special broadcasts. Excellent co-operation was given the Organizing Committee

by the two major American broadcasting organizations, National Broadcasting Company and Columbia Broadcasting System. The broadcasts listed below were devoted exclusively to the III Olympic Winter Games, and the time was donated by the broadcasting companies. There was no charge to the committee for this coast-to-coast radio publicity.

The schedule of special broadcasts follows :

October 15, 1930 Station WEA F National Broadcasting Company

Dr Godfrey Dewey, president III O W G Committee

November 29, 1931 Station WABC Columbia Broadcasting System

Dr Godfrey Dewey

Avery Brundage, president American Olympic Committee

Rufus J Trimble, chairman A O C Hockey Committee

Jay O'Brien, chairman A O C Bobsleigh Committee

December 16, 1931 Station WEA F National Broadcasting Company

Dr Godfrey Dewey

January 16, 1932 Station WABC Columbia Broadcasting System

Gustavus T Kirby, past president A O C

January 22, 1932 Station WABC Columbia Broadcasting System

Dr Godfrey Dewey interviewed by Ted Husing

January 27, 1932 Station WEA F National Broadcasting Company

Gustavus T Kirby interviewed by Grantland Rice

A series of ten fifteen-minute broadcasts in the form of interviews with prominent American Olympic officials and prospective members of the American Winter Olympic team was given from station WABC, New York City. One broadcast a week was put on the air during the ten weeks immediately preceding the Games.

In addition to all this special radio publicity the Games were mentioned frequently in many station and commercial programs during the winter of 1931-32. Radio pub-

Grouped below are various suggestions on how III Olympic Winter Games publicity material can be used in your specific field of business

Additional cooperative publicity projects not mentioned below should be placed before the III Olympic Winter Games Committee for consideration and approval.



FOR SPORTING GOODS STORES:

1. Window displays with III Olympic Winter Games Posters with photographs of well known local or national winter-sports stars of Europe and North America.
2. Feature "III Olympic Winter Games" as a copy theme for advertising.
3. Distribute III Olympic Winter Games Booklets to customers.
4. Use Olympic stickers on correspondence.

FOR MANUFACTURERS OF WINTER SPORTSWEAR AND SPORTING GOODS:

1. Distribute Olympic Posters and Booklets to your dealers.
2. Use "III Olympic Winter Games" as copy theme in advertising. If photographs are desired notify James F. Newcomb & Co., 330 Seventh Avenue, New York City.
3. Supply your salesmen with III Olympic Winter Games Booklets and information.
4. Use Olympic stickers on firm correspondence.

FOR NATIONAL ADVERTISERS:

1. The "III Olympic Winter Games" and the Lake Placid scene can be used as a winter background theme in your advertising.
2. Use photographs for advertising. Committee will supply photographs of your product in use at Lake Placid.
3. Booklets and Posters will be supplied to your advertising department and sales staffs.
4. Use Olympic stickers on firm correspondence.
5. Committee will be glad to consider cooperative publicity promotion arrangements.



FOR DEPARTMENT STORES:

1. Window displays of winter sportswear and sporting goods with a background of III Olympic Winter Games Posters and photographs.
2. Use "III Olympic Winter Games" as a copy theme in newspaper advertising on winter sportswear.
3. Build up winter-sports fashion shows in Women's Wear Departments, Winter Sportswear Departments or Winter Sporting Goods Departments.
4. Supply III Olympic Winter Games Booklets in all departments where information on winter sports is required.
5. Use Olympic stickers on firm correspondence.

FOR TRANSPORTATION COMPANIES:

1. Display III Olympic Winter Games Posters at all points of public contact.
2. Distribute Olympic Booklets to passenger and tourist agents.
3. Feature III Olympic Winter Games in advertising winter vacation trips.
4. Use Olympic stickers on firm correspondence.

FOR PUBLICATIONS:

1. Use the "III Olympic Winter Games" as a basis for feature articles on travel, sports, health, or adventure.
2. Use photographs for pictorial display.
3. Use Olympic Posters and Booklets in your Resort and Travel Information Bureaus.



III OLYMPIC WINTER GAMES PUBLICITY MATERIAL AVAILABLE

1 Official Posters—size 25" x 40"—blue and gold

2 Descriptive Booklets—24 pages—illustrated

3 Action Photographs taken at Lake Placid

4 Stickers—size 1½" x 2"



This is how a national advertiser has identified his product with the III Olympic Winter Games.



A typical store window display of winter sportswear built around the III Olympic Winter Games.



"Olympian"

The First New York Appearance of the Knitted Sports Ought Everybody's Been Hoping For!

A large department store realizes what the III Olympic Winter Games mean to its Winter Sportswear department.

Reverse of broadside sent to national advertisers and others



Metropolitan window display with Olympic Winter Games motif

licity during the Games themselves is not included in any of the preceding sections.

United States O W G Postage Stamp

To mark the III Olympic Winter Games the United States Post-office Department issued a special III O W G two-cent postage stamp. The edition totalled 25,000,000. 400,000 of these stamps were placed on sale in the Lake Placid post-office on January 25, 1932. They went on sale thruout the country on the next day. So great was the demand for these stamps in Lake Placid that the entire 400,000 allotment was exhausted on the first day, and an additional 400,000 were ordered and disposed of shortly afterward.



U S postage stamp to commemorate III Olympic Winter Games

The central design of the stamp, which was printed in red, showed a ski-jumper in full flight against a background of snow-covered mountains. The stamps carried the legend "United States Postage-III Olympic Winter Games-Lake Placid, New York, February 4-13, 1932-2 Cents 2."

Meetings of Newspaper Publishers

Much valuable publicity was given the Games as a result of annual meetings of the New York State Publishers Association held in Lake Placid in January, 1931, and in January, 1932. The delegates were afforded every opportunity to inspect Olympic facilities and learn about the Games. Their interest was further increased by round-table discussions and personal conferences. The co-operation of the publishers was willingly given; the results of this co-operation were far reaching.

III Publicity During the Games

Publicity during the Games themselves will be considered under the following headings:

- | | |
|---------|--------------------|
| 1 Press | 3 Motion Pictures |
| 2 Radio | 4 "Still" Pictures |

Press

While every effort was made prior to the Games to find out the exact number of press representatives who would attend, informa-

tion a few days before the opening was still meager. But on the first day it was seen that the number in Lake Placid to cover the sports was far in excess of the most optimistic estimates of the publicity organization. Arrangements, however, were so elastic that all were taken care of. Sections for the working press, with tables for typewriters, were set aside at the various facilities, and, in addition, other press representatives were allocated bleacher and grandstand space. Each press representative filing regular stories was given a press ticket admitting him to the press box at all events.

Press and wire rooms were on the main floor of the Lake Placid high school directly in the rear of the press box in the stadium grandstand. A separate section of the publicity department was set up in one of these rooms with Howard Acton in charge, assisted by several young ladies. This section tabulated all results as fast as the various events were run off and maintained a complete file of information in regard to Olympic officials and contestants, immediately available to press representatives and others working in adjoining offices. By having this clearing house for Games information much time and work on the part of the correspondents were saved, and accuracy of facts was assured. Tables and typewriters for the use of correspondents were available in the press room. Two large offices immediately adjoining this publicity section were utilized by the correspondents and the two telegraph companies, Postal and Western Union, which had their own direct wires (23) into the building and a large force of operators constantly on hand to flash the news of the Games to a waiting world.

In addition to providing special telegraph arrangements in the high school, both companies enlarged the facilities of their regular village and Lake Placid Club offices.

An idea of the vast amount of publicity sent out during the Games will be gained by noting the fact that the two companies handled a total of 1,250,000 words of domestic press and 85,000 words of foreign cable press. In addition, a substantial proportion

of this material was syndicated, and on arrival at the various syndicate headquarters was re-transmitted to the various member newspapers, thus frequently multiplying the distribution several hundred-fold. The two companies had on duty at Lake Placid during the Games a total of 88 men, including supervisors, operators, engineers, clerks, and messengers. An instance of the means taken to have Olympic pictures in newspapers of the far corners of the earth as promptly as possible is seen in the fact that Games pictures for the Japanese newspapers were sent by airplane from Lake Placid to New York, flasht by telephoto service from New York to San Francisco, taken from there to Seattle by train, and rusht to Japan by boat.

The public-address system, which was used to announce the progress of each event on the program to the crowd, was connected with loud speakers in the main press room at the high school, so that correspondents there could follow the progress of the events at each facility, such as the Mt Van Hoevenberg bob-run and Intervales ski-jump. This saved considerable time in filing. The telegraph companies also had wires run into the arena and operators on duty there to take the files of correspondents during the late evening events.

Press headquarters during the Games were established at the Hotel Belmont. Here most of the correspondents, telegraph executives, motion picture and radio men, and still photographers were quartered.

Radio

Practically every event on the III O W G program was broadcast from Lake Placid by announcers for the National Broadcasting Company and the Columbia Broadcasting System.

A large booth at the top of the stadium grandstand was set aside for the use of each company. Other events on the program were broadcast from the various facilities where every possible convenience was provided to enable the announcer to view the sports, get the results immediately, and thus paint a word picture of the Games for his radio pub-

lic. Both companies had their best-known sports announcers, together with a full corps of executives, engineers, and assistants at Lake Placid during the Games.

Many of the events were broadcast by short wave to European and other countries.

Information coming back from those who listened to the III O W G broadcasts indicated how much this part of the Olympic publicity was appreciated. The broadcasts of the bob races proved particularly successful in conveying a vivid picture of this thrilling sport, and aroused great enthusiasm everywhere they were heard. As far south as Georgia and out to the Middle West radio listeners thrilled to the reports of the announcers.

"The German team is approaching Zig-zag—they're taking the curve—riding high—they're through," and the rest of the bob jargon became as familiar to thousands who had never seen a bob-run as to the other thousands who thronged the course at Mt Van Hoevenberg as the riders sped by on their great sleds of wood and steel.

Last-minute changes in the day-by-day program and weather conditions for the day were broadcast every morning from Station CKAC in Montreal at 7:30 and from Station WGY in Schenectady at 7:15.

Motion Pictures

Prior to the opening of the Games arrangements were concluded thru the office of Motion Picture Producers and Distributors of America, Inc, with the four major news-reel companies of the country whereby they would be given exclusive motion-picture rights at the Games in return for supplying the committee with a complete film record of the Games for its archives. These companies were Movietone, Paramount, Pathé and Universal.

A plan was also set up whereby all 35-mm footage was made available for reproduction by the Eastman Kodak Company into 16-mm size for home and club use.

This arrangement, which restricted the news-reel companies working at the Games to four, made it easy to provide excellent

working facilities for all the operators and eliminated the possibility of duplication of effort and interference with the Games. Each company was allocated a stand or stands at each facility from which to take its pictures. Thru their international affiliations the four news-reel companies distributed the Games pictures thruout the world.

"Still" Pictures

Arrangements similar to those made with the four news-reel companies were concluded with the four major news-photo services: Associated Press Photo Service, Wide World Photos, International News Photos, and Acme News Pictures. In addition, Lake Placid professional photographers and a limited number of newspaper and magazine staff photographers were permitted inside the various facilities, where stands and locations were arranged. The news-photo companies and Lake Placid photographers, for these privileges granted them, agreed to supply the Organizing Committee with photographs for its permanent files and for its official report.

All radio, telegraph, motion-picture, and still-picture men were provided, in addition to tickets, with designating arm bands which gave them easy access to any Olympic facility.

As a result of these various plans the motion-picture and photographic coverage at the Games was all that could be desired, and the Games were run off with smoothness and dispatch. There was no prohibition as to the use of portable 16-mm motion-picture cameras or other cameras from seats in the stands. But for obvious reasons the general public was not permitted to crowd around the finish lines or other places where such crowding could easily become a nuisance.

General Printed Matter

Reference to the summary chart accompanying this section will show a list of the major pieces of printed matter put out by the III O W G Committee.

Report of III O W G Committee to A O A The report of the Organizing Committee in booklet form as given to members of the American Olympic Association at the meet-

ing in Washington, D C, on November 19, 1930.

General Fund Canvass Booklet Used in the solicitation of funds for the committee during the spring and summer of 1931.

Official O W G Rules Book Sent in accordance with usual Olympic practice to all Olympic committees, sports federations, and I O C officials several months in advance of the Games. Also distributed in large numbers to contestants, officials, and others during the Games. This booklet contained official Olympic rules, lists of committees and governing sports bodies, charts of facilities, the official program, and other pertinent information.

Official Information Folder Sent in the fall of 1931 to all countries likely to take part in the Games. Contained full information with respect to travel arrangements, entry into the United States, rate concessions by transportation companies, hotel headquarters in New York City, living arrangements for athletes at Lake Placid, and other data necessary for competitors and officials.

Identity Cards Sent with the official information folder. Issued in co-operation with the United States government. Used by Olympic officials and contestants instead of the ordinary passport and to secure special courtesies accorded by United States customs and immigration authorities.

Steamship Transportation Forms Sent to officials and contestants coming from abroad to enable them to secure rate concessions granted on steamship lines of the North-Atlantic conference.

Railroad Transportation Forms Sent to officials and contestants coming from abroad to enable them to secure rate concessions granted by the New York Central Lines.

Entry Forms Printed in three languages, English, French, and German, and sent to Olympic committees of all nations, members of the I O C. For full information see section of this book, *Entry Forms*.

Automobile Windshield Stickers Used on windshields of cars driven by Olympic officials, contestants, radio and motion picture men, and news correspondents during the Games, so that police officers would afford them special courtesies in the way of parking and passing thru police lines. Stickers were printed in three colors: red, green, and yellow, red stickers being given first preference; green, second; and yellow, third. Stickers were numbered consecutively and a record kept by number of those given out, to avoid transfer to others by holders.

Ticket Application Blanks Forms sent with letters and mailings of booklets to be returned filled out with information indicating number and type of tickets desired.

Souvenir Book On sale during the Games. Contained program and interesting information about the Olympic sports and individual athletes competing. Also contained advertising. See section *Souvenir Book* for further details.

Daily Programs Put on sale each morning during Games. Contained results of the competitions to date, detailed results of the preceding day, detailed program for the day, general program for the remainder of the Games period, the table of honor to date, and general information concerning the Games.

Since the results of such evening competitions as hockey and figure-skating were not known until a late hour, these daily programs had to be printed at night. General information on the Games on the inside front and inside back covers was printed in three languages, English, French, and German, while the body of the program, except for the headings of some of the sports summaries, was printed in English only. Programs were sold at the Olympic office, and by boys on the streets and at the different Olympic facilities. The price was 25 cents each.

Summary O W G Results Published shortly after the close of the Games. Contained table of honor and summary of all results.

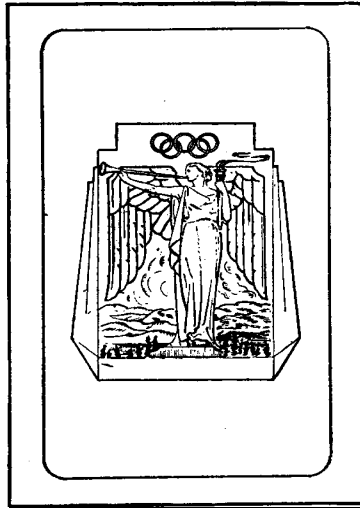

Reverse of press ticket

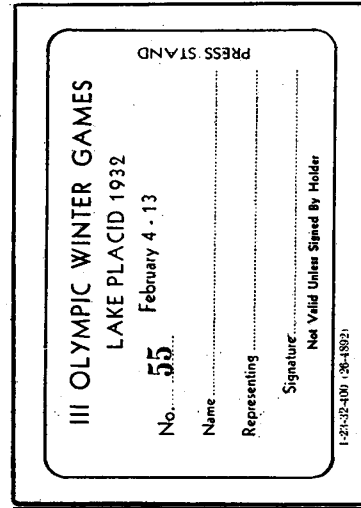

Obverse of press ticket

III O W G GENERAL PRINTED MATTER

Name	NUMBER PRINTED			Total
	English	French	German	
Report of III O W G Committee to America Olympic Association.	2,000	2,000
General Fund Canvass Booklet.	1,250	1,250
Official O W G Rules Book.	6,000	1,500	2,500	10,000
Official Information Folder.	5,000	1,500	2,500	9,000
Identity Cards.	600	400	500	1,500
Steamship Transportation Forms.	*2,250	2,250
Railroad Transportation Forms.	*2,250	2,250
Entry Forms.	†21,000	†21,000	†21,000	63,000
Automobile Windshield Stickers.	375	375
Ticket Application Blanks.	35,000	35,000
Souvenir Book.	6,000	6,000
Daily Programs.	26,750	26,750
Summary O W G Results.	3,000	3,000

*English and French on each form. Printed in triplicate, 750 each.

†Printed in triplicate, 7,000 each.

DISTRIBUTION OF I I I O W G PUBLICITY MATERIAL

MATERIAL	Preliminary Program	Preliminary Information Folder	FIRST POSTER			FIRST BOOKLET			STICKER STAMPS				Second Poster	Second Booklet	Essex Co O W G Booklet	Bob-run Booklet
			English	French	German	English	French	German	English	French	German	Spanish				
AVENUES OF DISTRIBUTION.....	English	English	English	French	German	English	French	German	English	French	German	Spanish	English	English	English	English
National Olympic Committees.....	1,000	1,000	400	118	115	6,550	1,925	1,505	2,000	8,000	8,000	7,000	1,145	1,550
American Express Company.....	1,425	395	580	57,010	21,100	36,500	60,000	5,000	5,000	45,000	678	4,560
Thomas Cook & Son.....	1,043	200	122	6,540	730	610	40,000	20,000	200	1,725
Sports Organizations.....	1,602	110	150	12,887	96,050	1,600	8,100	475
Transportation Companies.....	3,516	162	128	23,507	880	2,350	125,000	39,500	35,000	65,000	6,715	68,970	5,500	4,000
Tourist Agents.....	1,423	129	100	2,500	1,500	575	27,200	3,750	9,900	25,000	815	5,785	1,200
Miscellaneous from New York.....	850	102	104	21,420	1,250	52,000	2,500	1,500	1,939	21,905	500
Clubs.....	1,383	2,500	112,500	576	10,615	6,300	225
Hotels and Resorts.....	250	875	125,250	794	5,650	2,500	1,250
Chambers of Commerce.....	190	1,500	15,000	204	2,375	1,600
Business Organizations.....	250	75	54	3,000	340	50,000	5,000	5,000	55,000	984	11,900	3,150
Miscellaneous from Lake Placid.....	1,000	1,000	750	250	200	5,299	350	125	65,000	1,250	600	8,000	2,250	40,000	6,350	10,000
Distribution from Lake Placid During Games.....	20,000	1,500	5,670	550
Publication Resort Bureaus.....	600	6,195
Selected Lists.....	30,000	8,400	800
Distribution at Bob-run.....	7,200
	13,082	1,541	1,553	143,588	28,075	41,665	790,000	65,000	65,000	225,000
GRAND TOTAL	2,000	2,000	16,176			213,328			1,145,000				20,000	225,000	35,000	25,000

Local Arrangements

Housing

Housing and Finance were the two most difficult problems facing the community of Lake Placid in its ambitious plan to stage the III Olympic Winter Games of 1932. While Lake Placid has been known for generations the world over as a summer resort of unrivalled excellence, its development as a winter resort goes back only about a quarter of a century. As a result, while in summer it could easily house all the visitors expected at the III Olympic Winter Games, doing the same thing in winter presented a problem to the community that only careful investigation and organization succeeded in solving. Fortunately, it may be said here without fear of contradiction, a solution was reached satisfactory to all concerned, both visitors and competing athletes.

Lake Placid with a permanent population of something less than 4,000 has a housing capacity in summer roughly estimated at 10,000. Many of the larger hotels and cottages, however, are not suitable for winter occupancy. One of the first problems of the Organizing Committee was to devise ways and means of housing the 10,000 visitors expected to attend the most important events of the Games.

It was necessary that definite assurance be given the International Olympic Committee that Lake Placid was capable of properly housing and feeding athletes and spectators before it was possible for the committee to consider awarding the Games to this resort.

Preliminary Problems and Surveys

In the summer of 1928, about nine months prior to the award of the Games to Lake Placid, winter capacity of the village was determined at approximately 2,415. This original survey was made by a temporary housing committee, headed by Judge T A Leahy, and consisting of J Hubert Stevens, Benjamin Bull, J B Hurley, Edward Hart, Dura Jenney, William Lamb, C J Ortloff, and John F White.

Following the award of the Games to Lake Placid on April 10, 1929, immediate steps were taken to perfect the organization of the Olympic Housing Committee, to make a survey of Lake Placid and adjacent communities, and to establish fixed rates for contestants and officials.

At a meeting of the III Olympic Winter Games Committee on May 9, 1929, President Dewey read a letter from Count de Baillet-Latour stating that it was essential that special rates for accommodations for contestants and officials relatively as low as those charged at St Moritz in 1928 be immediately established. It was agreed at this time that rates per person of not more than \$4-5-6 a day should be fixed for contestants and officials.

Following the plan successfully used at the St Moritz Games, hotels and boarding houses were requested to reserve 20 per cent of their capacity for these groups.

Second Survey Made

In the spring of 1929, the same housing committee made a second survey of Lake Placid and also included Saranac Lake and Montreal in its investigation. Because of plans that had been made in the meantime by property owners to "winterize" hotels and cottages, the capacity was somewhat increased over the preliminary survey with results as follows:

Lake Placid	3,347
Saranac Lake	1,500
Montreal	2,000
	<hr/>
	6,847

Between the time of this survey and the spring of 1930 plans for winterizing properties in this village and adjoining communities went forward steadily. Further co-operation by means of additional winterizing was urged by the Organizing Committee at a meeting of the board of directors April 17, 1930. At a meeting of the executive committee on the same date, decision was reached to organize a

Please print all information

Survey of

.....193
Date

III Olympic Winter Games --- Lake Placid 1932 Olympic Housing Survey

Interviewed by.....
Name of Committeeman

Name..... Total sleeping accommodations now in house

Address..... Total baths now in house

Telephone No..... Rates per day for room and meals
Maximum \$.....
Minimum \$.....

Name of hotel.....

Boarding house.....

Private cottage.....

Garage (Yes) (No) Capacity.....

A	Rooms			Rates	Heat		To be ready for Olympics
	Now Ready	To be ready for Olympics	By steam (Hot water)		Hot air		
Rooms with private bath:							
Single.....							
Double with double beds.....							
Double with twin beds.....							
Total beds.....							
B	Public baths:				Stoves.....		
					Fireplaces.....		
					Meals.....		
					Rates per day.....		
C	Rooms with running water.....				Number persons now served.....\$.....		
Single.....					Probable number for Olympics.....\$.....		
Double with double beds.....							
Double with twin beds.....							
Total beds.....							
D	Rooms without running water:						
Single.....							
Double with double beds.....							
Double with twin beds.....							
Total beds.....							

Remarks

Total accommodations available in 1932..... Signature.....

Total baths available in 1932.....

.....193
III Olympic Winter Games Committee --- Lake Placid 1932

Agreement Between III Olympic Winter Games Committee And

.....
Name of Owner

I,, owner or lessee of property
at.....St.,
No. Name

in consideration of the following valuable services to be rendered me **free of charge** by the III Olympic Winter Games Committee, namely:

- A. Listing my property in booklets which will be distributed throuot the world during 1930-1932,
- B. Repeatedly circulating information thru publicity articles released from the Olympic News Office about available rooming and boarding accommodations,
- C. Aiding me to rent my property for the period of the games at rates as stipulated,

do hereby agree

- A. To rent my property, in connection with the holding of the III Olympic Winter Games, at rates **not to exceed** those recorded on the reverse of this card, which in turn, do not exceed the highest rates regularly charged by me during the summer rental periods.
- B. To forfeit to the III Olympic Winter Games Committee, in the instance that I charge any person rates per day in excess of those itemized on the reverse of this card, the **entire amount** that said person has paid me.
- C. Except as provided below, to house..... officials and contestants, or approximately 25% of my total housing capacity, at the **guaranteed rate not to exceed** \$..... per day per person for room and meals, knowing that rates of \$3, \$4, or \$5 are established for such accommodations by the III Olympic Winter Games Committee, in concurrence with the International Olympic Committee. I fully understand that these guaranteed rates **must be maintained**, regardless of whether I rent directly, thru a lessee, or thru the III Olympic Winter Games committee.

In the event that, with the approval of the III Olympic Winter Games Committee, I do not accommodate as many such persons as stipulated, at the indicated guaranteed rate, I obligate myself to pay to the III Olympic Winter Games Committee, on or before February 14, 1932, the sum of \$3.00 per person per day for the total number less than my quota for each of the eleven days of February 4 thru 14, 1932.

In the event that I choose to accommodate more such persons than are stipulated, at the guaranteed rate indicated, I shall be reimbursed by the III Olympic Winter Games Committee, on or before February 14, 1932 at the rate of \$..... per day per person for the total number in excess of my quota.

- D. That the signatures of the Secretary-General of the III Olympic Winter Games Committee and of myself, the undersigned property owner, make this agreement legally binding on both parties.

.....
Property owner or lessee

.....
Secretary-General

permanent Olympic Housing Committee and to incorporate in the general housing plan neighboring communities within a radius of 100 miles of Lake Placid by asking them to appoint their own housing committee chairmen to co-operate with the Lake Placid Housing Committee.

April 21, 1930, the board of directors approved the following as members of the Olympic Housing Committee which served until the conclusion of the Games:

Judge T A Leahy, Chairman
 Benjamin R Bull
 Edward Hart
 James B Hurley
 Dura Jenney
 William Lamb
 C J Ortloff
 Martin T Ryan
 William Ryan
 J Hubert Stevens

Cities and villages in the Lake Placid territory got squarely behind the movement to provide housing facilities for the Olympic visitors and began at this time the close co-operation with the Lake Placid housing authorities which was so essential to the latter in the project which they had undertaken. By means of the co-operation of the chambers of commerce in these communities, the following agreed to serve as chairmen of the housing committees in their own cities and villages:

Ausable Valley. Fred C Torrance
 Saranac Lake. Francis H Leggett
 Malone. Dr John E White
 Montreal. J C Owen
 Tupper Lake. P J Hickey
 Plattsburg. HL Booth
 Wilmington. James C Wolfe

Pullman Housing Plan

Officials of the New York Central Lines met with Dr Dewey and other members of the N Y State O W G Commission in New York city on May 7, 1930, to discuss transportation and housing problems. It was suggested at this meeting that the railroad might provide sidings for Pullman cars to be used as sleeping quarters during the Games. Sub-

sequent study brought out the fact that the cost of housing any considerable number of visitors in Pullmans would be out of proportion to the quality of accommodations provided.

Third Housing Survey

Early in May, 1930, members of the housing committee made a third survey of the village and adjacent communities in order to prepare data for Dr Dewey's report before the Olympic Congress in Berlin later that month.

The report as submitted by Dr Dewey at that time follows, figures showing capacities of the different communities:

Lake Placid Club.	1500
Hotels and boarding cottages . .	1000
Private homes	1000
Pullman cars	1000
Montreal	1000
Saranac Lake	1000
Regional towns, including Ma- lone, Keene, Elizabethtown, Jay, Wilmington, Ausable Forks	1000
Total.	7500

At a meeting of the housing committee on September 23, 1930, it was decided, in view of the low rates to be charged contestants and officials at the Los Angeles Games and the rates charged at St Moritz in 1928, to reduce the agreed daily rate per person of \$4-5-6 to \$3-4-5, and that, if necessary, means of reimbursing hotel proprietors for the difference be provided by some sort of subsidy in the budget of the III O W G Committee.

At this meeting it was also decided to draw up a contract between the III O W G Committee and hotel and cottage owners that would be legally binding on the latter, in order to give the housing director more specific information concerning the maximum and minimum rates to be charged, to assure the proper distribution of contestants, and to do away with the possibility of profiteering.

Because of the amount of time necessary to make the next housing survey, it was de-

cided by the housing committee on September 29, 1930, to engage a temporary paid worker on a full-time basis to complete the survey which had been started by the committee a short time before. William E Feek, a Lake Placid business man and former mayor of the village, was chosen for this work. Mr Feek conducted an extensive survey of the housing and feeding facilities in Lake Placid, prepared a detailed summary, and reported to the committee that by 1932 Lake Placid should be able to accommodate approximately 3,898 visitors. This completed Mr Feek's work for the committee.

O'Hare Named Housing Director

In February, 1931, the Organizing Committee found it necessary to add to the Olympic executive staff some one to have charge of housing arrangements under the general direction of the committee. Accordingly, at a meeting of the board of directors, February 16, 1931, William J O'Hare of Lake Placid was named housing director and began his duties on February 20th.

Mr O'Hare's first task was to bring all housing information up to date for inclusion in the second Games publicity booklet which was then being prepared. It was decided that all hotels and boarding cottages able to accommodate 10 or more people for rooms and board be listed in the second publicity booklet. At a meeting on February 26, all hotel and boarding-house proprietors agreed to care for contestants up to 25 per cent of their capacity if necessary.

Temporary Real Estate Board Formed

A temporary real estate board was organized under the direction of Mr O'Hare on March 20, 1931, to care for the rental of cottages. Members of this temporary board included all the real estate agents in Lake Placid, with Mrs Jennie M Isham as chairman. The commissions charged owners for rentals thru this board or thru the office of the housing director were to be divided among the members of the board.

In the spring and summer of 1931 the housing director made a final survey of the accommodations in nearby towns and vil-

lages, which served as a basis for the allocation of Olympic guests up thru the Games. In addition to accommodations personally investigated in North Country cities and villages, listed further on in this section, space was available and utilized to some extent in the following places:

Peru, NY
Harkness, NY
Paul Smith's, NY
Rainbow Lake, NY
Vermontville, NY
Cranberry Lake, NY
Mt Arab, NY
Bloomingdale, NY
Ticonderoga, NY
Middlebury, Vt

Arrangements were made at this time to house at least 1000 visitors in Montreal, which, under the special railroad schedule planned during the Games, would be only 3½ hours distant from Lake Placid.

On October 7, 1931, the board of directors, in an effort to extend the fullest cooperation to participating nations in overcoming the extraordinary economic conditions obtaining all over the world including a pronounst difference in exchange, announst a final reduction in rates for board and lodging to \$2-3-4 daily per person for contestants and officials. The rates of \$3-4-5 establisht following the Berlin Congress were the lowest at which suitable accommodations could be provided. The difference between the two rates was to be taken care of by a \$1 per day per person subsidy payment by the committee.

As a matter of fact, the housing subsidy never assumed any large proportions, as the housing director was able to lodge practically all the contestants in places where the regular rate corresponded to the rates agreed upon for contestants and officials by the III O W G Committee, and less than 50 per cent of the amount allotted for subsidy was used.

During the summer and fall of 1931 plans for housing visitors, contestants, and officials were further perfected in the office of the housing director, and machinery was defi-

nately set up so that every request, whether from a nation or an individual, could be handled with dispatch and to the satisfaction of the applicant. As early as May, 1931, representatives of nations expecting to participate in the Games began to come to Lake Placid to inspect accommodations for their teams and to conclude the necessary arrangements.

Office Procedure

As soon as the first specific requests for accommodations began to reach the office of the housing director, a definite procedure was established to operate up thru the Games, altho naturally during the period immediately preceding the Games and during the Games themselves certain short-cuts had to be resorted to, in order to handle the great number of requests that poured into the office.

As a result of the several surveys made, all the specific information concerning each hotel, cottage, and rooming house was tabulated on a card $8\frac{1}{2} \times 12$, containing such data as name of hotel or boarding house, rooms with and without bath, rooms with single and double beds, whether or not meals were served, rates per day with and without meals, total accommodations, and telephone number. These cards were filed by towns and villages and were arranged according to capacity and according to whether or not meals were served.

The housing of all contestants and officials was handled by the Olympic housing director. Visitors to the Games either made their reservations directly with the hotels and boarding houses or thru the housing office.

As early as the winter of

1930 inquiries regarding housing accommodations were received at the Olympic office. Each inquiry was handled individually, and all possible information was given the prospective guest. It was the aim of the housing office to make it possible for every person to secure accommodations in accordance with his desires.

Late in December, 1931, it was found necessary to increase the housing staff to 4 persons, and a short time later to 5, in order to take care of the mass of correspondence and other details incident to the task. About two weeks prior to the Games all correspondence had to be eliminated because of the huge number of reservations being made, and all requests were answered either by day telegrams or night letters. Beginning February 1, 1932, practically all reservations were made by long-distance telephone. Calls came in daily from all parts of the United



—Pierson Studio

Young lady members of the staff in corner of main executive office.
Standing left to right: Laura Munson, Rae Feather, Marcellyn Donivan, Mary Landon. *Seated:* Hazel K Wharton

States, including Philadelphia, New York city, Cleveland, Buffalo,, Rochester, Milwaukee, St Paul, Chicago, Detroit, Springfield, Boston, St Louis, and Charleston, South Carolina.

The housing office was open from eight o'clock in the morning until midnight, and during the last week of the Games when special trains were coming into Lake Placid at all hours, the housing director and his staff were on duty 18 hours a day, taking care of those who had made no reservations. In spite of the fact that crowds on several days of the Games exceeded all expectations, many coming without any advance reservations, it may be said here that all were satisfactorily taken care of.

*Actual Housing Arrangements
Officials*

All officials and officers of various Olympic bodies, members of the International Olympic Committee, international sports federations, members of the American Olympic Committee, the New York State Olympic Winter Games Commission, the Essex County Park Commission, and the III Olympic Winter Games Committee were housed at the Lake Placid Club and various hotels, arrangements for all these groups being made thru the housing office.

Contestants, Managers, and Coaches

Most of the nations entered in the Games reserved entire hotels or cottages for their use. Most nations made their arrangements for these accommodations well in advance of the beginning of the Games. The following nations occupied separate cottages or hotels by themselves:

Czechoslovakia	Norway
Finland	Poland
France	Sweden
Italy	Switzerland
Japan	United States

The other nations were quartered either in clubs, hotels, or boarding houses, but did not occupy the accommodations exclusively.

Austria	Great Britain
Belgium	Hungary
Canada	Roumania
Germany	

Many of the larger delegations quartered in cottages brought their own food, their own cooks, and their own servants, in order that their pre-Games training might be done under conditions closely approximating those obtaining in their own countries. This plan was of great advantage in conditioning the groups of athletes affected by it.

Press

Thru special arrangements made by the Organizing Committee, the Belmont hotel on Saranac avenue was set aside for use by press representatives, telephone and telegraph officials, radio announcers and engineers, and motion picture and "still" photographers. From February 1 to February 15, 1932, the Belmont was filled to capacity with these groups, totalling approximately 100 persons, and no other guests were accommodated.

Band

The 21 members of Adams's Empire State band, which furnished music for the Games, were housed by themselves in a cottage on South Main street from February 3 to 14.

State Troopers

The 53 state troopers stationed in Lake Placid during the Games were given accommodations in a house on Main street near the town hall.

Summary of Accommodations

Below is given a summary of the highest house count of Lake Placid clubs, hotels, and boarding houses during the Games, together with the maximum accommodations available in nearby communities.

Lake Placid hotels and boarding houses (capacity of 10 or more) . .	1638
Boarding houses, capacity less than 10, with meals served	213
Rooms only, with meals at restaurants, located in village proper. . . .	1133
Suburban districts	263
Private homes	486
Lake Placid Club	1604

Total for Lake Placid 5337

Accommodations in nearby villages Ausable Forks, Elizabethtown, Jay, Keene, Keene Valley, Keeseville, Malone, Platts- burg, Saranac Lake, Tupper Lake, Upper Jay, Wilmington..4650	
Total	9987

Praise for Housing Arrangements

Attaches of Olympic teams, visitors, press representatives, and others stated that one of their happiest recollections of the Games was the fact that hotel proprietors in Lake Placid adhered strictly to their published rates and made no attempt to profiteer or to charge anything other than what was fair or specifically agreed upon. Widely-syndicated stories appeared in the press of the United States commenting in the most favorable terms on the accommodations provided the press and the fair rates charged for rooms and board.

Naturally these comments were a source of much gratification to the housing director and his co-workers who had striven so hard to make certain that all who came to Lake Placid for the Games should be fairly treated during their stay.

Transportation

Transportation matters in connection with the III Olympic Winter Games were handled by Lewis Crane of Utica, district freight and passenger agent for the New York Central railroad and also general chairman of the III O W G transportation committee; Earle McDevitt of Lake Placid, local chairman; and Ernest Gamache, secretary of the Organizing Committee.

Transportation to Lake Placid

Thru the efforts of Sir George McLaren Brown of London, member of the I O C for Canada and European general manager for the Canadian Pacific Railway, a 20% reduction from off-season rates was secured from the steamship lines of the North-Atlantic conference for accredited officials and contestants coming to the Lake Placid Games.

A special rate of \$15 for the trip from New York to Lake Placid and return was secured for the same group (foreign officials

and contestants) from the New York Central Lines.

During the Games, trains were run on a special 3½-hour schedule between Montreal and Lake Placid. These trains were run to Lake Placid in the morning, arriving before the first event on the program, and returned that same night.

Arrangements were also concluded whereby all personal baggage of officials and contestants and sports equipment for use at the Games were transported free of charge by the steamship companies and the New York Central.

The New York Central railroad built a special siding at Lake Placid to accommodate Pullmans and coaches at the time of the Games, with a 25-car capacity, and also enlarged the regular railroad yard so that it could accommodate eight full trains, at a total expenditure of approximately \$92,000.

Transportation at Lake Placid

Transportation details at Lake Placid were under the supervision of Earle McDevitt and Secretary Gamache.

A central headquarters was established on Main street, thru which all calls for taxicab and bus transportation cleared. This office was open 24 hours daily.

Bus transportation about the village and between the village and the bob-run and ski-jump was handled by Adirondack Stages, Inc, which had 20 buses in operation during the Games period. Bus fares were as follows: ski-jump, round trip \$1; bob-run, round trip \$1.50.

The transportation system set up in Lake Placid worked with the utmost smoothness in spite of the fact that the bob-run was 8 miles from the village and the ski-jump 2 miles, and the roads were covered with snow and ice. The huge crowds were moved quickly, comfortably, and on time. There were no traffic accidents of any sort.

Health and Safety

Health and safety measures at the Games were in charge of a special committee, of which Martin T Ryan, mayor of Lake Placid village, was chairman.

After a thoro study of conditions that it was felt would obtain during the Games, the co-operation of the New York State department of health was secured. This department undertook the responsibility of approving and overseeing health conditions at the various Olympic facilities and thruout the vil-
lage during the Games period. Many tempo-
rary comfort stations were installed for the
convenience of the thousands of visitors.

Three weeks before the Games, Dr Eliot H Luther, Dr William L Munson, and Dr Charles A Holmquist, officials of the state health department, came to Lake Placid and surveyed all the Olympic facilities and the entire village. Their recommendations to the Organizing Committee with respect to changes in arrangements and new construction needed were carried out promptly.

Dr Luther was assigned to Lake Placid for the period of the Games. Several minor changes were made at various facilities at his recommendation just before the Games began. Dr Luther approved health conditions in the village and commended the Organizing Committee on the work it had done.

Safety Measures

After a conference with Major John A Warner, head of the New York state police and a member of the III O W G health and safety committee, Mayor Ryan secured Major Warner's complete co-operation in special safety measures to be instituted. It was decided at this conference that the state would send a large detail of troopers to Lake Placid to care for traffic and other conditions that might arise.

Lieut H C Herrick of Troop B, state police, Malone, with a detail of 53 troopers, 3 automobiles, and 4 horses, was assigned to Lake Placid. 15 of this detail came on January 20, and the remainder on February 1. The entire detail stayed in Lake Placid until February 22.

The detail of 53 troopers was made up as follows:

Troop B, Malone.....	23
Troop G, Troy.....	10
Troop C, Sidney.....	12
Troop D, Oneida.....	8

A central office was establish for the troopers adjoining the Olympic executive offices on the second floor of the North Elba town hall. The office was completely equipt with telephones, maps, teletype, and necessary state records, and was open 24 hours daily.

During the period of the Games the troopers supervised all police activities in the vil-
lage and at the Olympic facilities. It was because of their efforts that an unprecedented volume of traffic was handled without delay and congestion, and confusion at the different sports events reduced to the minimum. One-way traffic was maintained on many village streets and stringent parking regulations rigidly enforced.

As a token of appreciation to the state officers for the excellent job they did, the Organizing Committee tendered them a banquet at the Lakeside Inn, Monday evening, February 15, 1932. Supervisor Willis Wells acted as toastmaster. Other speakers included Dr Godfrey Dewey, Lieut H C Herrick, J B Hurley, F B Guild, and Ernest Gamache.

The Organizing Committee committed itself early to the policy of a clean town during the Games. This policy was rigidly adhered to, and results completely bore out its soundness. The decision was good policy and good business as well, as shown by the absence of vice and crime. Few arrests were made by the troopers during the Games. There were no accidents and no major disturbances at any time. The troopers' object was to prevent criminal acts just so far as possible. Their record shows that they were more than successful.

Special Sections

Office Lay-out

All executive offices of the III O W G Committee were on the second floor of the North Elba town hall which is located at the village civic center directly across from the Olympic stadium. All offices were connected by an inter-communicating telephone system and were also connected thru the switch-board with all Olympic facilities, bob-run, ski-jump, stadium, arena, and rooms in high school.

All necessary office equipment was either purchast or rented on advantageous terms.

A brief description of the various executive offices follows:

Ernest Gamache Private office 12 x 13. 1 desk, table, and chairs. Outer office and reception room, 15 x 17. Telephone switch-board, desks for 3 secretaries, filing cabinets.

George M Lattimer Office 16 x 17. 2 desks, filing cabinets, racks and tables for display of publicity material.

William J O'Hare Office 14 x 18. 2 desks, bookkeeper's table, filing cabinets.

H L Garren Office 12 x 16. 2 desks, filing cabinets, and draftsman's table.

E C Paarman Office 11 x 18. 1 desk, tables, and filing cabinet.

Walter O'Connor Ticket office 14 x 18. 2 desks, files, ticket storage racks, safe, and table.

Mimeograph room 12 x 15. Mimeograph machine and necessary supplies. This room also used as an emergency store-room.

Small board room 12 x 14. Long table with chairs. Used for meetings of small committees.

Board room 11 x 16. Large oak table with matching chairs. Used for directors' and other meetings.

Storage room 10 x 15. Large table and racks for storage of entry blanks, booklets, and other material.

Small storage room 4 x 13. All office supplies and blueprints.

State troopers' room 15 x 33. Tables, chairs, teletype, and other special equipment.

Large lobby 28 x 45. Tables and chairs.

Telephone Service

During the Games there were ten trunk lines coming into the central Olympic office switch-board and 38 extensions connecting with all Olympic facilities and branch offices.

An idea of the immense volume of telephone traffic clearing thru the Lake Placid village central office during the Games period is gained from the figures which follow:

Peak Day, Feb 12

Local calls 16,502

Toll calls 1,402

Games Period, Feb 4-13

Local calls 104,895

Toll calls 7,945

The telephone switch-board in the Olympic office was covered by experienst operators from seven in the morning until two the following morning during the period of the Games.

February 12, 1932, according to officials of the Northern New York Telephone Corporation, was the biggest day from the point of view of telephone traffic ever experienst in the Lake Placid office.

65 public telephones were maintained by the Northern New York Telephone Corporation at strategic points thruout the village and at Olympic facilities.

Entry Forms

The entry forms for the five official and three demonstration sports on the program of the III Olympic Winter Games were divided into three classes: individual, team, and national. There were 19 individual, 5 team, and 7 national entry forms, each printed in three languages: English, French, and German. The sled-dog entry form, used only in the United States and Canada, was printed in English only.

Each of the 31 English, 30 French, and 30 German entry forms was printed in three units, original, duplicate, and triplicate. All three forms were sent to member nations of the I O C. The original and duplicate forms when filled out and signed by the proper officials were returned to the Organizing Committee. The triplicate copy was retained by the nation making the entry.

Entry forms were 8½ by 14 inches in size. A distinctive color of paper stock was used for each sport in order to facilitate identifying and handling.

The sports and the color of paper stock used for each follow:

Ski Canary Yellow
 Speed-skating Green
 Figure-skating Cherry
 Hockey Blue
 Bobsleigh Salmon
 Dog Derby Buff
 Curling Grey
 Women's Speed-
 skating Pink

As a further aid to the easy and proper handling of the entry forms each sport was designated by a letter and the several events of each sport were numbered.

Below is given the complete system of numbering the entry blanks:

Ski A

50-km race A-1
 18-km race A-2
 Combined event A-3
 Jumping A-4

Speed-skating B

500-m race B-1
 1500-m race B-2
 5000-m race B-3
 10,000-m race B-4

Figure-skating C

Men C-1
 Women C-2
 Pairs C-3

Ice hockey D

Bobsleigh E

4-man bobs E-1
 2-man bobs E-2

**Sled-dog racing* F

**Curling* G

**Women's speed-skating* H

500-m race H-1
 1000-m race H-2
 1500-m race H-3

* Demonstrations



Secretary Ernest F Gamache at desk

—Pierson Studio.

Sent	_____
Rec'd	_____
Ack.	_____
Indv.	_____
Nation	_____
Sport	_____
Event	_____
Nicht auszufüllen	

**III. Olympische
Winterspiele
Lake Placid 1932
4.-13. Februar 1932**

Eis-
Hockey
—
D

Nationales Anmeldungs-Formular

(In doppelter Ausfertigung zurückzusenden)

Auszug aus den Allgemeinen Bestimmungen für die Olympischen Spiele—(§ 9, Nennungen) "Sechs Wochen vor dem Beginn der Spiele müssen die Listen der Sportarten und der Wettbewerbe, an denen eine Nation teilnimmt, in Händen des Organisationsausschusses sein. Diese Angaben können auch telegraphisch übermittelt werden."

Das Komitee der III. Olympischen Winterspiele

Lake Placid, N Y, Vereinigte Staaten

muss dieses Formular in Duplo

vor dem 24. DEZEMBER 1931, Mitternacht im Besitze haben.

Telegramm Adresse: "Placolymp"

Diese Anmeldungsformulare müssen in Druckschrift oder Schreibmaschinenschrift ausgefüllt werden.

D

Eis-Hockey

Teilnehmendes Land:

Namen des massgebenden Nationalen Verbandes:

*Unterszeichnung des Vertreters des massgebenden
Nationalen Verbandes:*

_____ Name und Stand

_____ Verband

*Unterszeichnung des Vertreters des Nationalen
Olympischen Komitees oder des Vertreters des
Internationalen Olympischen Komitees:*

_____ Name und Stand

_____ Komitee

Versendungstag _____ 193_____

ORIGINAL (zurückzusenden)

Printed in U. S. A.

National entry form

Sent
Rec'd
Ack.
Indv.
Nation
Sport
Event
Ne remplissez rien ici

**III^{mes} Jeux
Olympiques d'Hiver
Lake Placid 1932
du 4 au 13 Février 1932**

Bobsleigh**E-1**Bobsleighs
à 4 places**Feuille d'Engagement par équipes**

(A retourner en double exemplaire)

Extraits des Règles générales applicables à la célébration des Jeux Olympiques.— (§ IX. Engagements)—Les noms des concurrents devront parvenir au Comité Organisateur au moins quinze jours avant la date de la première épreuve de chaque sport, sans que des modifications puissent encore être apportées.

Cette feuille doit être en possession du

Comité des III^{mes} Jeux Olympiques d'Hiver

Lake Placid, N Y, Etats-Unis

avant le 21 JANVIER 1932, dernier délai.

Adresse Télégraphique: "Placolymp"

E-1 Bobsleigh Bobsleighs à 4 places

(Nombre d'engagés maximum: 3 équipes de 5 personnes chaque par nation)

Ces feuilles d'engagement doivent être remplies en Caractères imprimés ou dactylographiés

Nation représentée:

Titre de la Fédération
Sportive Nationale:

Nombre d'équipiers engagés:

Liste des équipiers

No.	Noms	Prenoms	No.	Noms	Prenoms
1			9		
2			10		
3			11		
4			12		
5			13		
6			14		
7			15		
8					

AVIS IMPORTANT: Une feuille d'engagement nominative pour chaque équipier devra accompagner la présente feuille d'engagement par équipes.

Visa du représentant de la Fédération
Sportive Nationale:

Visa du représentant du Comité Olympique National
ou du représentant du Comité International
Olympique:

Nom et Titre

Nom et Titre

Fédération

Comité

Date d'expédition.....193.....

ORIGINAL (à retourner)

Printed in U. S. A.

Team entry form

Sent	_____
Rec'd	_____
Ack.	_____
Indv.	_____
Nation	_____
Sport	_____
Event	_____
Do not write in space above	

III Olympic Winter Games

Lake Placid 1932

February 4-13, 1932

Ski

A-1
50-km Race

Individual Entry Form

(Original and Duplicate to be returned)

Extract from the General Rules applicable to the celebration of the Olympic Games (§ IX Entries): "b) The names of the competitors must be received by the Organizing Committee at least a fortnight before the date of the first event in each sport and no variation from this can be permitted."

This entry form (in duplicate) must be in possession of

III Olympic Winter Games Committee

Lake Placid, N Y, U S A

Before JANUARY 21, 1932, Midnight

Cable Address: "Placolymp"

A-1 **Ski** **50-kilometer Race**

This entry form must be either printed or typewritten

Participating Country:	
Name of the Governing National Association:	
Name of the Athlete:	
Christian Name:	
Birthday:	
Birthplace:	
*Date of Naturalization:	
<small>*In case of naturalization, the naturalized subject must give proof that he was an amateur in his native country at the time of changing his nationality.</small>	

DECLARATION: According to the laws applicable to the celebration of the Olympic Games, we declare that the information given above is correct and certify that the athlete is an amateur according to the definition drawn up by the Governing International Federation and meets the minimum requirements set forth in the amateur regulations of the I O C.

Signature of the representative of the Governing National Association:

Signature of the representative of the National Olympic Committee or of the representative of the International Olympic Committee:

_____	_____
Name and Title	Name and Title
_____	_____
Association	Committee
Date of mailing: _____ 193_____	

DUPLICATE (to be returned)

Printed in U. S. A.

Individual entry form

A set of entry forms in one language sufficient to enable a nation to enter the maximum number of contestants including reserves in all the events of the five official Olympic sports contained 145 forms in triplicate. This complete set, additional copies to allow for spoilage, and entry forms for the demonstration sports were sent to each of the countries that could possibly be represented at the III Olympic Winter Games. Other nations, members of the International Olympic Committee but not included in this list, were sent a complete set of national entry blanks.

Each country received the entry forms and other printed material (see page 70 for list) in the official language of that country with the exception of the Spanish speaking nations to which either English or French-language material was sent.

National entries closed at midnight, December 24, 1931, and individual entries at midnight, January 21, 1932.

364 Enter Games

Following receipt of the completed entry forms in duplicate of the 17 nations declaring their intention to participate and nominating 364 entrants for the Games, the original and duplicate forms were separated. Originals were filed according to events and sports for ready reference and subsequent inspection by the technical delegates for each one of the Olympic sports. Duplicates were filed according to countries.

After the classification of the entry blanks, a file of 4 x 6 cards was set up, divided into three sections. Each entry received was recorded on a card of the same color as the entry form for that sport. These cards were filed according to the alphabetic order of the contestant's name. Each one of these cards carried the contestant's full name, country represented, and events in which the contestant was entered. In a second file, cards containing the same information were grouped according to the nations represented, and in a third file according to sports.

As will be noted by referring to the III O W G organization chart, a separate depart-

ment was set up for the handling of all Games entries, in order that needed information with respect to national and individual participation might be at all times at the disposal of the Organizing Committee and all others to whom this information was important and necessary. The entry office was of great assistance to the publicity department and press representatives at the Games in making instantly available facts and figures with respect to Olympic participation.

All entry files were kept "up to the minute" so that when individual entries closed at midnight, January 21, 1932, the Organizing Committee was in a position to and did announce to the world a complete list of those men and women participating in the events of the III Olympic Winter Games.

Tickets

The chart below lists the prices charged for tickets at the 28 events comprising the III O W G program.

It will be noted from this chart that standing-room tickets were \$1 each, and grandstand seats \$3 each, except at the opening and closing ceremonies and the 2 ski-jumps; bleacher seats \$2 each, with the same exceptions.

FEBRUARY 1932	MORNING		AFTERNOON		EVENING	
	G	B St-rm	G	B St-rm	G	B St-rm
Thursday, 4th	\$5	3 2	\$3	2 1	\$3	2 1
Friday, 5th	\$3	2 1	\$3	2 1	\$3	2 1
Saturday, 6th	\$3	2 1	\$3	2 1	\$3	2 1
Sunday, 7th		\$3	2 1	\$3	2 1
Monday, 8th	\$3	3 1	\$3	2 1	\$3	2 1
Tuesday, 9th	\$3	3 1	\$3	2 1	\$3	2 1
Wednesday, 10th . .	\$3	2 1	\$3	2 1	\$3	2 1
Thursday, 11th . . .	\$3	3 1	\$5	3 2	\$3	2 1
Friday, 12th	\$3	3 1	\$5	3 2	\$3	2 1
Saturday, 13th	\$3	2 1	\$5	3 2	
Season tickets, admitting to all events.....						\$45 30 15

EXPLANATION OF SYMBOLS
G—Grandstand B—Bleachers St-rm—Standing-room

As indicated, season tickets admitting to all events were priced as follows: grandstand \$45; bleacher \$30; standing-room \$15. A saving of over 50 per cent was effected by buying season tickets as contrasted with buying separate tickets for all the events.

Tickets for children under 16 years of age were sold at $\frac{1}{2}$ of regular adult prices in all classes.

School children in groups of 20 or more, accompanied by an adult leader, were sold tickets at $\frac{1}{4}$ the adult price in each class for the period from February 5 to 10 inclusive.

After a thoro study of the lay-out and requirements at the various facilities, the contract for printing the single-session tickets was awarded. The number of single-session tickets printed was 279,440.

Season tickets were printed on celluloid so that they would be of lasting quality and could be retained by the holder and used at the different sessions. 2500 season tickets were printed.

Tickets were sold in advance-sale booths at the stadium entrance, in the main ticket office at Olympic headquarters, and in booths at the different facilities.

Attendance

Attendance at the III Olympic Winter Games was adversely affected, not only by the unfavorable weather conditions at various times during the Games themselves, but also by the continued bad weather during the month preceding the Games, which convinced thousands of prospective visitors that it would be impossible to hold the Games successfully. In addition, the unsettled weather conditions during the Games, involving postponement of several events and transfer of others to different locations, especially from the stadium to the arena, made impossible any accurate analysis of attendance or gate receipts for each individual event, as tickets issued in advance for a given time or place had naturally to be honored for the postponed or transferred event along with those sold at the new time or place. The total figures are, however, accurate, and approximate analysis for the more important events will be of interest.

The net total paid attendance for the whole period of the Games, assuming that all holders of the 491 paid season tickets attended each event, was 58,343. The grand



—Pierson Studio

Ticket department. Walter O'Connor, Thomas Haynes



Standing-room season ticket

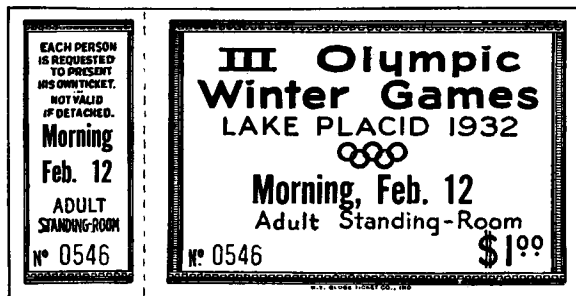

Standing-room single-session ticket



Bleacher season ticket

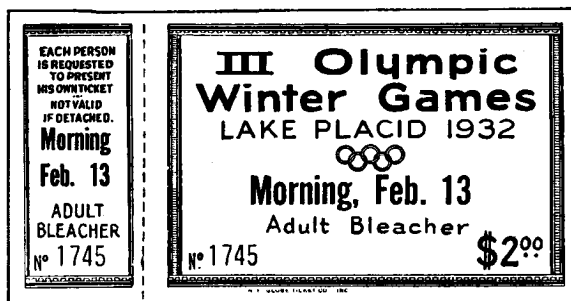

Bleacher single-session ticket

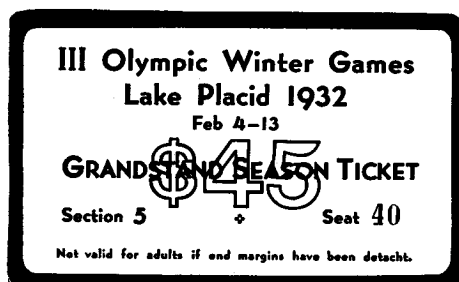

Grand-stand season ticket



Grand-stand single-session ticket



Reverse of season ticket

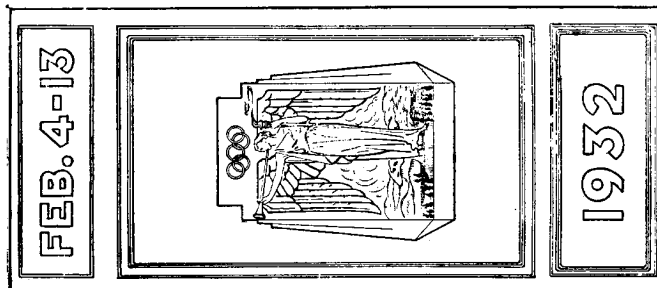

Reverse of single-session ticket

total recorded attendance, not including athletes or active officials admitted by badge, on whom no check was practicable, was about 80,000. This larger figure includes, in addition to the press, radio and telegraph representatives and official photographers, the members and official guests of the III Olympic Winter Games Committee, the State Commission, the County Commission, and the local governing bodies; members of the International Olympic Committee, the American Olympic Committee, and the winter-sports governing bodies; the National Host Committee, made up of the larger contributors to the general fund canvass, each of whom received two complimentary tickets; those members of the executive staff not actively engaged with their duties; and about 1900 miscellaneous complimentary admissions. Adding to this recorded total the unrecorded attendance of the many officials and contestants admitted by badge, and the very substantial number who evaded payment at the two ski-jumping events by remaining on the new state highway as described below, it is certain that the total attendance figure for the III Olympic Winter Games was well in excess of 100,000.

To this figure must, of course, be added the vast invisible audience running into the millions who followed the progress of the Games in newspapers, motion-picture newsreels and in radio broadcasts, as explained in detail in the section of this book devoted to *Publicity*.

The largest single attendance was at the first two heats of the four-man bob race, postponed to the morning of February 14, which totalled over 14,000. The next largest was unquestionably at the two ski-jumping events on the afternoons of February 11 and 12, but the unfortunate re-location of a state highway within plain view of the ski-hill made it possible for thousands to witness the jumps from a distance without payment, so that the net admissions were only about 6,000 and 6,500 respectively, altho the total number of actual spectators undoubtedly approximated double these figures.

Of all the Olympic facilities, the invaluable arena carried the heaviest load. On four

successive evenings, for the men's and women's free figure-skating, February 9 and 10, the exhibition hockey game between the combined Canadian and United States teams and the Lake Placid Athletic Club, February 11, and the pair figure skating, February 12, the arena was filled to its estimated capacity of 3,200, including standing-room. For the final hockey game between Canada and the United States on the afternoon of February 13, 4,200 people, 1,000 more than the total estimated capacity, jammed every available foot of space, 500 more to whom tickets had been sold before the game was transferred from the stadium to the arena had to be refused admission, and at least 1,000 more who wished to buy tickets were turned away.

The stadium was used more often than any other of the Olympic facilities, but because of weather conditions, the crowds except for the opening and closing ceremonies, were far below its capacity. If, however, it had been possible to hold the final hockey game between Canada and the United States in the stadium, as originally scheduled, its full capacity would unquestionably have been overtax.

Gate Receipts

For reasons already explained above, no accurate segregation of gate receipts to each event is possible. Accurate figures are, however, available for the receipts from season tickets and at each of the four principal locations, as follows:

Season tickets.....	\$17,625.00
Stadium	* 3,764.00
Arena	25,147.00
Ski-jump	24,708.00
Bob-run	23,835.50
	<hr/>
Gross total gate receipts.....	\$95,079.50
Refunds and adjustments.....	1,663.90
Net total gate receipts	\$93,415.60
	<hr/> <hr/>

* This extraordinarily low figure is due to the transfer of 7 events from the stadium to the arena and elsewhere because of weather conditions.

Diplomas, Medals, and Badges

Place medals were given the winners of the first three places in each event.

Diplomas were given to senior officials and to contestants winning the first six places in each event.

Commemorative medals were given to all contestants and all officials.

In addition, a large number of badges were given to groups and individuals taking part in or helping to conduct the Games.

The names of the 14 first-place winners in the Olympic events are inscribed on a tablet on the walls of the Olympic arena.

The summary below is self explanatory.

Diplomas

Given to contestants winning first six places and to senior officials. Number ordered, 500.

Place Medals

<i>To Whom Given</i>	<i>Number Ordered</i>	<i>Description</i>
First-place winners	35	Silver-gilt
Second-place winners	35	Silver
Third-place-winners	*45	Bronze

* Additional supply ordered to insure samples for the official archives of the I O C and the Organizing Committee.

Commemorative Medals (Bronze)

Given to all contestants, officials, and others who aided in the conduct of the Games. Number ordered, 700.

Official Badges without Ribbons (Bronze)

<i>To Whom Given</i>	<i>Number Ordered</i>	<i>Inscription</i>
Contestants	450	“Contestant” on red enamel background
Officials	250	“Official” on green enamel background
I O C Members	20	“I O C” on black enamel background

Courtesy Badges with Ribbons (Bronze)

<i>To Whom Given</i>	<i>Number Ordered</i>	<i>Inscription on red, white, and blue ribbon</i>
Members		
III O W G Committee	100	“III O W G Committee”
N Y State O W G Commission	15	“N Y State O W G Comm”
National Hosts Contributing \$1000 each to general Games fund	45	“National Host”
Honor Guests	25	“Honor Guest”
Officials	140	“Official”



Obverse and reverse of commemorative medal



III O W G Diploma

International Secretary

During the summer of 1930, following the Olympic Congress at Berlin, it became evident to the Organizing Committee that in the absence of extraordinary measures the severe world-wide economic depression was likely to discourage many nations from making necessary preparations for adequate representation at Lake Placid. In view of this apparent situation, plus the added difficulties of furnishing accurate information promptly by trans-Atlantic correspondence, the committee determined on the unprecedented step of sending a personal representative to



III O W G badge without ribbon, "Official"

place before the Olympic committees and sports governing bodies of the principal winter sports countries the facts concerning living costs in Lake Placid, expenses en route, facilities for training and for the Olympic competitions, and similar matters—in short, to help them to solve their real difficulties and to dismiss the imaginary ones. The committee selected for this service Bjorn



III O W G badge without ribbon, "I O C"



III O W G badge without ribbon, "Contestant"

Blix, a native of Norway, who had previously spent two winters in Lake Placid in the promotion of winter sports, and who as an ardent and active winter sportsman seemed well qualified for this position of international secretary.

Mr Blix sailed early in December, 1930. His visits carried him to Norway, Sweden, Denmark, Germany, Holland, England, France, Italy, Yugoslavia, Bulgaria, Roumania, Poland, Lithuania, Latvia, Esthonia, Czechoslovakia, Austria, Hungary, Switzerland, and Finland. In these countries, he distributed photographs, gave talks to interested groups, information to sports organizations, newspapers, and magazines, and generally spread the gospel of the III Olympic Winter Games.

While the rules of the I O C expressly require each nation to finance fully its own participation in the Olympic Games, the Organizing Committee recognized that under the prevailing economic conditions some of these countries would wish to call on their nationals living in the United States for financial assistance. Before and after his European trip, Mr Blix was delegated by the Organizing Committee to co-operate with these national groups, chiefly in and around New York city, in organizing their efforts to raise funds, but it was clearly recognized on both sides that this service was rendered as a courtesy and not as an obligation.

Because of the contacts which he had formed while in their service abroad, Mr Blix was also selected by the Organizing Committee to act for them in receiving the vari-

ous national delegations on their arrival in New York city, and aiding in their housing and travel arrangements en route to Lake Placid.

Souvenir Book

Since by rule no advertising space could be sold in the official day-by-day program and since it was desired to develop an attractive publication to serve as a souvenir of the Games, the Organizing Committee entered into negotiations with several firms and individuals interested in producing such a book, with the idea that the book could be sold at no cost to the committee and some profit. It was planned that the book should carry the complete program for the Games, in addition to other material, and should also contain advertisements. The committee's decision to have this book produced by an outside firm was influenced by the fact that its funds were limited, that no income from advertising space in the daily program could be secured, and that a similar book, containing advertising, had been sold at previous Games. Under the arrangement subsequently entered into, the committee did not have the control over the solicitation of advertisements that might have been desired.

After extended consideration of various propositions, Clayton E Brooke of New York city was designated as the publisher of the Souvenir Book of the III Olympic Winter Games. Mr Brooke agreed to produce and turn over to the committee 6,000 copies of the book and, in addition, to pay a fee of \$500; the books to be the property of the

committee and Mr Brooke to retain all the receipts from advertising space sold.

The souvenir book was an attractive publication, measuring $9\frac{3}{4} \times 12\frac{1}{2}$ inches and containing 60 pages and cover. An excellent quality of coated stock was used which reproduced most effectively the half-tone cuts with which the book was profusely illustrated. The illustrations included photographs of Olympic officials and contestants and Lake Placid winter-sports scenes.

The cover was of unique design in four colors showing a ski-runner with a display of the flags of the 17 nations competing in the Games against a mountain background of white. The book contained statements on the Games by President Herbert Hoover and Governor Franklin D Roosevelt, together with their photographs.

Sections were devoted to the various sports on the Games program and the list of nations and individuals entered.

5,565 copies of the book were sold during the Games at 50 cents each. Sales were handled by boys on the streets and at the various facilities, as well as thru local stores and hotels.

More books could have easily been sold, but negotiations with Mr Brooke were concluded too late to insure delivery by the printer much before the opening date of the Games. Certainly if the book could have been available for sale as early as the Christmas holiday season many more copies could have been disposed of.

After the Games, a copy of the book was sent to each member of the New York State legislature.

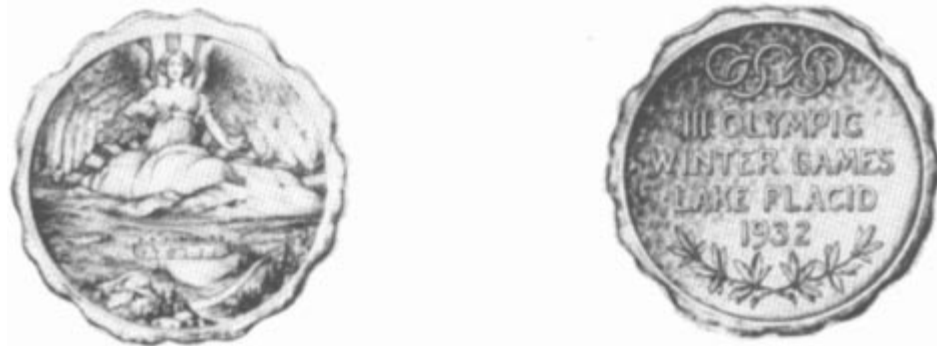

Obverse and reverse of place medal

Concessions

To handle the granting of concessions for such activities as the Organizing Committee did not wish to handle itself, a special concession committee was organized as follows: James B Hurley, chairman, Judge Thomas A Leahy, F S Leonard.

Following the advertising for bids, those received were sent to the secretary who obtained all possible information on the bidders and details of their bids before submitting the information to the concession committee. After studying each bid the committee formulated its recommendations and placed them before either the directors or the executive committee, who made the final decision.

Concessions were sold in each instance to the highest bidder after his qualifications were found to be satisfactory to the committee.

Concessions granted by the committee follow:

- 1 Operation of restaurant in bob-run club house.
- 2 Sale of food at stadium.
- 3 Sale of athletic equipment in arena.
- 4 Sale of Olympic flags.
- 5 Production and sale of souvenir book.
- 6 Operation of central shop for display and sale of photographs taken by local photographers at Games.

Ushers and Information Service

All ushering at the Games was done by boy scouts, members of the Adirondack Council, Boy Scouts of America, under the supervision of scout leaders from Lake Placid and Saranac Lake. The boys were given instruction for several days prior to the opening of the Games on the handling of tickets, seating lay-out of each facility, the various entrances, and the proper way to direct the crowds to their seats. A crew of from 25 to 50 boys was used daily during the Games.

The Organizing Committee furnished transportation from Saranac Lake to Lake Placid and return for scouts living in the former village and purchased the noon meal each day. Scout leaders were paid a nominal sum for their services. In accordance with the scout law the boys themselves were not paid.

Two information booths were set up outside the town hall and one at the arena. Two girls were on duty each day and evening, and one German interpreter was employed on a part-time basis. Information was supplied in English, French, and German as needed. Quantities of posters, booklets, stickers, maps, and other Games publicity material were distributed without charge.

Naturally Games information was also available at many other places in the village,



—Pierson Studio

Huge tractor plow clears Lake Placid highway on March 29, 1932, following heaviest snowfall of winter

including Olympic facilities, hotels, restaurants, transportation headquarters, and stores, but most of the information was given out at the information booths above mentioned and at the executive offices of the Organizing Committee in the town hall.

Feeding

One of the greatest problems confronting the committee was that of providing the facilities necessary for feeding the thousands who would come to the Games, particularly those who would attend daily sessions, returning to their homes at night. To accommodate these latter it was necessary to provide facilities far in excess of those supplied by the village's hotels, clubs, boarding houses, and restaurants.

Following a thoro survey made by the housing director, it was found that the total capacity of the village for meals, including double tables, was approximately 6,650.

Local church and other organizations were encouraged by the Organizing Committee to enlarge their existing dining arrangements or to make plans to provide dining facilities. As a result, the following organizations made provision to serve 2 meals daily—dinner and supper—during the period of the Games as indicated:

- Woman's Club
- Lake Placid Grange
- Catholic Church
- Episcopal Church
- Community Church
- Masonic Lodge

The Organizing Committee also opened restaurants in the basement of the town hall and in the Olympic arena, where large numbers were fed.

The restaurant concession at the Mt Van Hoevenberg bob-run clubhouse was sold. Refreshments of all kinds were provided here by the concessionaire, including regular meals, both table d'hote and a la carte, and lunches at all hours. It was here that the luncheon to Governor Roosevelt and officials present at the opening ceremony was given at noon on February 4. From 12,000 to 14,000 people were fed at the bob-run clubhouse during the winter season.

As a result of these various arrangements, either those made by the Organizing Committee or by other groups at their suggestion, the feeding problem was satisfactorily solved. On the morning of February 12, when an unusually large crowd was augmented by several thousand day excursionists from New York, the feeding arrangements received their severest test. At that time many restaurants were forced to close their doors temporarily while those inside were eating their breakfast. When they finished, another group was admitted, and so on throughout the morning. This was done to avoid jamming the restaurants and to give the waitresses room in which to serve their patrons.

On February 12, which was the high day of the Games from the standpoint of attendance, 9,842 noon-day meals were served. This takes no account of the thousands attending the Games from Lake Placid and nearby places who ate at home or carried their lunches.

Music

It was decided to secure a band of from 20 to 25 pieces to play at all events on the Games program including the opening and closing ceremonies.

Following receipt of specifications, 5 bands submitted bids, which were gone over carefully by the board of directors. Adams's Empire State Band of Albany was finally awarded the contract. This band consisted of 21 members including the leader.

At the stadium and arena, special stands were built, from which the band played during the competitions. At the bob-run and the ski-jump, space was set aside for the band in the regular stands.

When wanted, additional music was supplied at the arena by means of phonograph records reproduced thru the loud speakers of the public-address system.

Decorations

The special committee in charge of decorations consisted of Mayor Martin T Ryan, chairman, J B Hurley, and William Lamb. Secretary Gamache worked closely with the committee. J B Hurley was in charge of

flag decorations, and William Lamb of the ice decorations.

Plans developed by the committee included the stringing of flags across all principal streets at distances of approximately 50 feet between strings; decoration of business houses and private homes in the village and the town hall and all Olympic facilities.

Frank S Leonard was granted the exclusive concession to sell to the O W G Committee and to individuals and business houses flags and bunting to be used in decorating for the Games.

Village in Gala Dress

Lake Placid village did its own decorating, using flags, colored lights, ice, and strings of evergreen. The Organizing Committee supplied all the flags and paid the village for decorating the Olympic facilities. Ice archways were built at the entrance of the arena, stadium, bob-run, and ski-jump and other places across village streets. In the general decorative scheme flags of all nations represented at the Games were interspersed with Olympic flags at about every third place. Sizes were 4 x 6 and 9 x 15, while a few larger flags were also used.

In the stadium the large Olympic flag—18 x 25—used in the II Olympic Winter Games at St Moritz in 1928, flew from the center pole, while the prize award flags were run up on three other poles on the eastern side of the stadium. Flags of the nations also flew all during the Games from poles surrounding the stadium.

The arena was attractively decorated inside and out with national and Olympic flags and bunting.

The general decorative scheme was developed to emphasize the international character of the Games by means of the flags of the nations and to bring out an Adirondack mountain effect by means of ice and evergreens.

Residents of the village co-operated wholeheartedly in the move to have all homes and business blocks in gala dress. Lake Placid was a riot of color during the day, and at night was a mountain fairyland of sparkling snow, glittering ice, and soft lights twink-

ling in the darkness from home, business block, and street.

All decorations were put up between January 10 and January 20, so that everything was in readiness when the Games opened on February 4.

Medical Attention

Arena A doctor was constantly on call at the arena during the Games. A first-aid kit was kept in the office.

Ski-jump A doctor was in attendance at all ski-jumping competitions, and a first-aid kit was kept on hand.

Bob-run A doctor, nurse, and two ambulances were in attendance at all competitions. A nurse and one ambulance were in attendance at practice sessions. Medical equipment at the bob-run included stretchers, first-aid equipment and appliances, medicines, and an ambulance bob to bring any injured riders quickly to the bottom.

Cross-country ski races A physician examined all contestants for heart condition and blood pressure prior to each race. First-aid kits were available.

Sled-dog races All dogs were examined by a veterinary surgeon before the competition started.

Social Affairs

Four social affairs were given during the Games period.

- 1 Luncheon for Governor Roosevelt and his party at the bob-run clubhouse, noon, February 4.
- 2 Dinner for official groups to meet Governor Roosevelt and Mrs Roosevelt at Lake Placid Club, evening, February 4.
- 3 Reception following dinner at Lake Placid Club Agora, evening, February 4.
- 4 Tea in Lake Placid Club Agora, afternoon, February 7, given by Dr and Mrs Dewey for officials, contestants, and visiting dignitaries.

Thirty attended the luncheon for Governor Roosevelt and his party at the bob-run clubhouse, February 4. These included Mrs Roosevelt, members of the governor's staff,



DINNER FOR GOVERNOR ROOSEVELT AND OFFICIALS AT LAKE PLACID CLUB

— Steadman

Governor Roosevelt directly below the Olympic circles. On the governor's right: Lady Fearnley of Oslo; Dr Godfrey Dewey, president, III O W G Committee; Mrs Roosevelt; Count de Baillet-Latour, president, International Olympic Committee; Mme Thenault, wife of Major Georges Thenault, of the French Embassy, Washington; William May Garland, president, Organizing Committee, Games of the Xth Olympiad, member of the International Olympic Committee for the United States. On the governor's left: Mrs Garland, Sir Thomas Fearnley of Oslo, member of the International Olympic Committee for Norway; Mrs Dewey; Avery Brundage, president, American Olympic Committee; Mrs Gustavus T Kirby of New York



—Roger L. Moore

State's chief executive bares head as "Star Spangled Banner" is played at opening of Games. Front row, *left to right*: Dr Godfrey Dewey, president of III Olympic Winter Games Committee; Count de Baillet-Latour, president of the International Olympic Committee; Governor Franklin D. Roosevelt; Guernsey Cross, secretary to the governor; Ernest F Gamache, secretary of the III Olympic Winter Games Committee





The southern range of mountains. *Left to right* the highest peaks are Tahawus (Marcy), the highest in the state, Colden, and MacIntyre

—Stedman

and members and officials of the International Olympic Committee, III O W G Committee, and New York State O W G Commission. There were no speeches at this luncheon, and the whole affair was marked by an informality in keeping with the Adirondack mountain background at the bob-run. The distinguished guests were given an opportunity to inspect the bob-run before and after the luncheon.

Governor Honored at Dinner

96 attended the dinner in honor of Governor Roosevelt at Lake Placid Club on the evening of February 4. Included among those attending, in addition to the Governor and Mrs Roosevelt and members of his staff, were members of the International Olympic Committee, delegates from international sports federations, heads of national Olympic delegations, III O W G directors, members of the New York State O W G Commission, officers of the American Olympic Association, and members of the National Hosts' Committee. Many of these officials were accompanied by their wives.

Immediately following the banquet a reception was held in Lake Placid Club Agora to which various other officials, committee chairmen, and members were invited.

Dr Godfrey Dewey, president of the III O W G Committee, and Mrs Dewey entertained all Olympic officials, contestants, their wives and friends at tea in Lake Placid Club Agora, Sunday, February 7.

Dr Dewey Speaks

Remarks by Dr Godfrey Dewey, president of III Olympic Winter Games Committee, at dinner for Governor Roosevelt, Thursday evening, February 4, 1932:

"As chairman of the Organizing Committee of the III Olympic Winter Games, it is my duty, as well as a privilege and a pleasure, to speak to you briefly at this time. Merely to acknowledge my indebtedness to those both present and absent who have co-operated so splendidly in our common task would take more than the allotted period. May I be pardoned, therefore, for confining myself to just one thought—the significance, as I see it, of the III Olympic Winter Games of Lake Placid.

"Forty years before the first Olympic Winter Games at Chamonix, the Swiss began that progressive development of winter sports which has made Switzerland one of the great winter play grounds of the world.

"Twenty years before the Chamonix Games, Lake Placid Club pioneered the development of winter sports in the Adirondacks, and laid the broad foundation of facilities and experience, added to climate and terrain, which made the present occasion possible. Today, eight years after the I Olympic Winter Games in Chamonix, four years after the II Olympic Winter Games at St Moritz, the III Olympic Winter Games are being held at Lake Placid.

"What does this event signify? What has been accomplished?

"First, of course, comes service to the Olympic ideal, the inspiration to a sound mind in a sound body, leadership in friendly rivalry, and international fellowship and good will.

"Next should be placed the raising of the standard of winter-sports athletic achievement throughout the world by the inspiration and the example of the Olympic Games as the supreme goal of international amateur athletic competition.

"Scarcely less important is the influence in developing the physical facilities for winter sports, especially where the Games themselves are to be held. Thanks to this influence, Lake Placid has today the most complete and perfect facilities for winter sports ever before brought together in one place in the whole world.

"Fundamentally important, also, is the effect of the Olympic Winter Games in changing the psychological attitude of the general public of the United States toward winter sports. Until very recently, the term winter sports in the metropolitan press of this country has meant chiefly indoor sports—basketball, boxing, and wrestling, indoor track and swimming, handball and squash. Even hockey has followed the crowds indoors. No less unfortunately, the term winter resort in this country quite generally implies the assumption of escape from winter rather than a welcoming of its unique and delightful opportunities; a flight to the Mediterranean or West Indies instead of a joyous journey to the realms of ice and snow; the comparatively enervating relaxation of Florida and Palm Beach, rather than the stimulating activities of the Adirondacks and Lake Placid. Surely the term winter sports should stand first of all for the sports which only winter makes possible, including especially the invigorating major sports of the Olympic program—ski racing and jumping, speed and

figure skating, hockey and bobbing-and the term winter resort should be broad enough to cover first of all those resorts offering the distinctive opportunities of winter.

“It is our hope that thru the holding of the III Olympic Winter Games in the United States the general interest and participation in winter sports on this side of the Atlantic, especially thruout the northeastern United States, may be set forward by at least a decade, if not a generation.

“To all these purposes, we dedicate our united efforts to make the III Olympic Winter Games at Lake Placid worthy of the highest traditions of the modern Olympic Games.”

Address by Count de Baillet-Latour

Speech by Count de Baillet-Latour, president of the International Olympic Committee, at dinner for Governor Roosevelt:

“Mr Chairman, Mr Governor, dear colleagues, ladies and gentlemen:

“I feel rather uneasy in deciding who deserves to be congratulated more, Lake Placid for having organized the III Olympic Winter Games, or those countries who have so keenly responded to the invitation of the United States of America. But one thing is certain, neither of them would have been able to carry on if, on both sides of the Atlantic, a gigantic effort had not been made to provide, under very difficult circumstances, the necessary funds. The generosity shown is due to the fact that in the whole world enthusiasm and faith in Olympic ideals are increasing every day. The competitors in winter sports, newcomers in 1924, have joined with heart and soul the athletes of those other sports which have been part of the Olympic program since the early days of the revival of the Games in 1896. They have been conquered by the same ideals and we rejoice, especially in these days when it is obvious that a free trade of blows in sporting contests is one of the best ways of bringing in closer touch the youth of every nation, that those who will be rulers of the morrow understand that competition does not mean death for the opponent, and that the goal of peace has to be reached between the countries in international affairs as in competing teams, by co-operation and not by strength-and, above all, by fair play.

“I have met very often with the opportunity of expressing to our American friends, when they were over in Europe, the gratitude of the International Olympic Committee towards the American Olympic Association for the way in which it has spread all over America the Olympic ideals;

but it gives me still greater pleasure to repeat it again tonight at this meeting where so many more members of that Committee are present, and to tell them the price at which we value the splendid participation of the American Olympic teams in the Olympic games held every four years. It has been the best propaganda, and both factors have undoubtedly largely contributed to the success of the Games of 1932 in Lake Placid and Los Angeles. The interest in those Games will, by no means, have to suffer if, for reasons of economy, the teams will be smaller in number than antici-



III O W G badge with ribbon

pated. Anyhow, they will not lack in quality because in every event the best men of every country will be present and will put up a hard fight.

"My duty tonight is not an easy one to fulfill. I have to convey to all concerned the thanks of the International Olympic Committee, and I feel sure that if I only attempted to quote the names of those whom I have personally seen at work, I would overstep the time the Chairman has given me, and these are a very small portion of those who have devoted their time and energy for the same purpose. Therefore, I beg you all to understand that if I only refer individually to a few, my gratitude goes nevertheless from the president of the III Olympic Winter Games Committee to the last workman who, under heavy pressure, did his bit to make sure that the Arena would be ready on time.

"Our thanks to you Franklin Roosevelt, Governor of the State of New York, and to the legislature of the state, who have seconded the efforts of Senator Warren Thayer and Assemblyman Fred Porter, chairman and vice-chairman of the New York State Olympic Winter Games Commission.

Could we, Sir, expect anything else from you who bear the name of the man who was at the same time a great statesman as well as a great sportsman?

"Our thanks to the National Hosts who contributed by generous gifts.

"Our thanks to you Dr Godfrey Dewey who, after leaving no stone unturned before this town had been selected by the International Olympic Committee, have given the best of your time and of your ability to face the obligations you had so gamely taken on. You shared this hard task with members of the Olympic staff, who all found useful help from the board of directors, selected amongst the best men available in Lake Placid and in the whole country.

"Our thanks also to the Lake Placid community which has taken a greater burden than any other community of its size, and proved itself to be, in every sense of the word, really sporting and devoted to that Olympic cause so dear to the heart of Pierre de Coubertin, who revived the Games and whose name must be remembered and worshipped forever."

*The Organizing Committee of the
III Olympic Winter Games
Lake Placid 1932
requests the pleasure of*

*company at dinner
on Thursday evening, February 4th
at 7 o'clock
at the Lake Placid Club
to meet the Governor of the State of New York
The Honorable Franklin D. Roosevelt
and Mrs. Roosevelt*

*Please reply promptly to
III Olympic Winter Games Committee
Lake Placid, New York*

Formal or informal dress

Invitation to dinner in honor of Governor Roosevelt

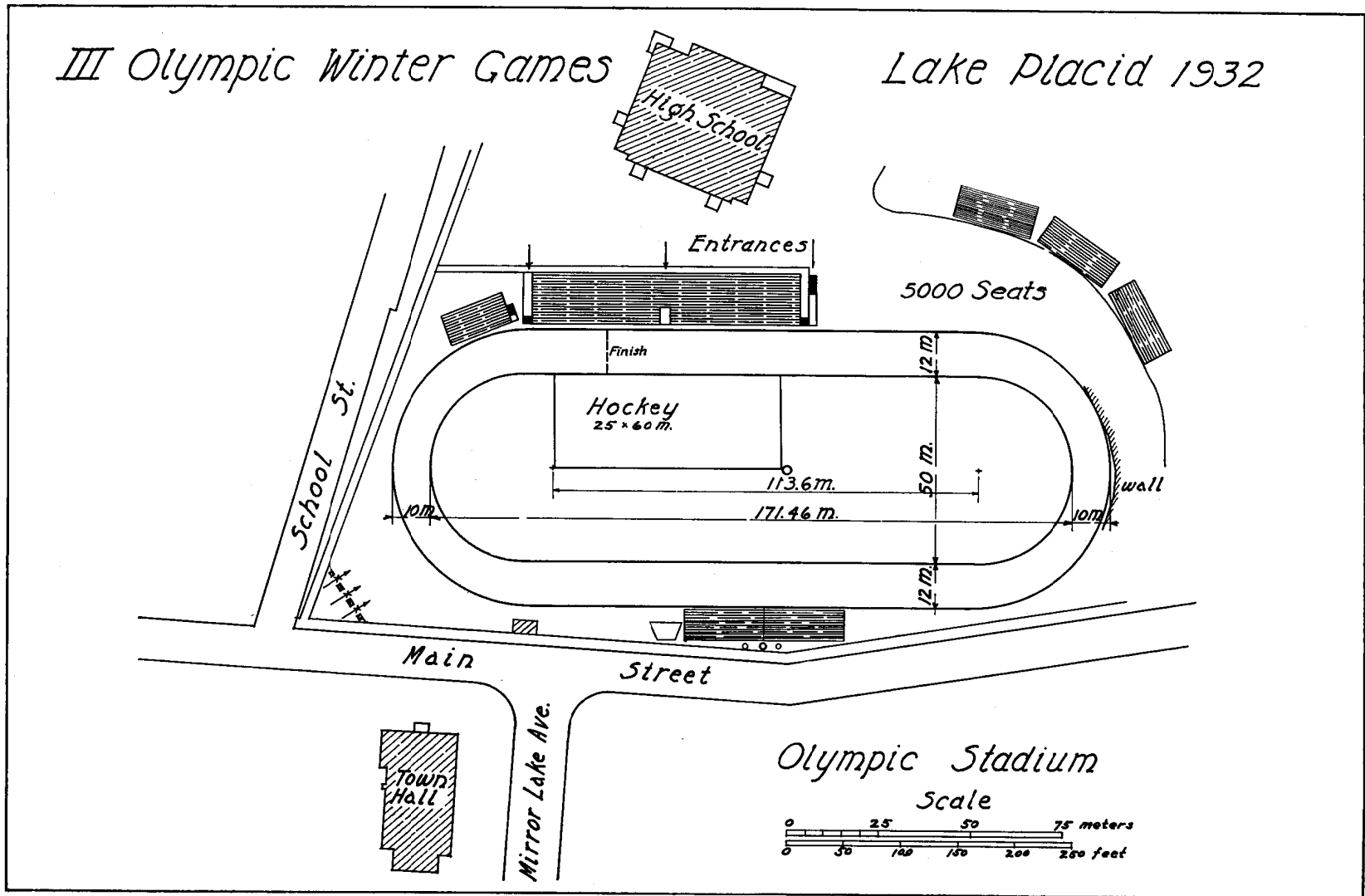

The ice surface of the Olympic stadium was 74 meters by 101.46 meters. The speed skating track was 400 meters long and 12 meters wide, with two 180-degree turns of 25 meters radius.

The Olympic Facilities at Lake Placid

Summary Chart of Seating Capacities at Olympic Facilities				
<i>Places</i>	<i>Ski-hill</i>	<i>Stadium</i>	<i>Arena</i>	<i>Bob-run</i>
Grandstand	2,600	2,875	1,360	
Bleachers	3,600	3,600	1,000	2,500
Standing-room	3,000	1,000	1,000	10,000
	9,200	7,475	3,360	12,500

Intervales Ski-hill

When its invitation to hold the III Olympic Winter Games of 1932 in Lake Placid was presented to the International Olympic Committee, Lake Placid was fortunate in possessing as part of its winter-sports equipment one of the outstanding ski-jumps of the world. This was the Intervales 60-meter jump, owned by Lake Placid Club, and made available to the community in bidding for the Games.

Intervales had for years been the scene of many of the best-known ski-jumping competitions in the United States.

Refined and perfected over a long period, with no effort to build a jump of record-breaking length but with every effort to build the best possible hill for championship competitions, Intervales is today as nearly perfect a hill for jumps of from 40 to 60 meters as it is possible to build.

It is interesting to trace the history of Intervales hill and ski-jumping at Lake Placid to the time when both were so well known that they played an important part in the decision of the International Committee to award the III O W G to this community.

Lake Placid Club as early as the winter of 1904-05 began to foster winter sports among its members, and, to encourage ski-jumping proficiency, a series of hills of varying requirements in skill was built. From the proverbial "soap-box" take-off upward, it was decided that hills to be known as 5, 10, 20, 30, and 50-meter jumps were desirable. A series like this made possible steady progress of each skier, as greater skill was developed.

It was soon learned, however, that a beginner could practice on a 10-meter as well as on a 5-meter hill, so the smallest hill was abandoned. As noted later, the 50-meter hill was subsequently converted into a 60-meter jump.

A 20-meter jump, originally built in 1917, still stands on Golf hill near the main buildings of Lake Placid Club.

In addition to the two smaller jumps, the 10 and 20-meter, on Golf hill, the Club also maintains a 30-meter jump at Intervales, while the Lake Placid Athletic Club has both a 15 and a 30-meter jump overlooking the Olympic stadium in Lake Placid village.

It is with the development of the 60-meter jump, now known as Intervales Olympic ski-hill, however, that we are primarily concerned. This hill is about two miles south-east of Lake Placid village.

Original Intervales Hill Built in 1920

The first design was made in 1920 as tournament ski-jumping began to prove popular, and construction was finished in time for the winter of 1920-21, with the first tournament held on February 21, 1921. Ten amateur and three professional jumpers competed. The longest standing jump was 118 feet, made by G Michelson, Nansen Ski Club, amateur class; and 124 feet by Antony Maurer, professional class.

As built in 1920, the hill, known as a 35-meter jump, had the following dimensions: length of upper slope above take-off 142 feet; lower hill 280 feet; grade of upper hill 28 degrees 50'; lower hill, 31 degrees 30'; length

of take-off 15 feet; slope 6 degrees. Cost of building this hill was \$1736.

After prolonged study of profiles in North America and Europe, Intervales was rebuilt in 1923, and by this reconstruction became a 50-meter hill with the following dimensions: total vertical elevation from top of tower to level at foot of lower hill, 254 feet; horizontal dimension from point directly under top of tower to level ground at foot of lower hill, 660 feet; length of upper slope including tower, 267 feet; length of lower slope from take-off to level ground at foot of hill, 440 feet, or a total of 707 feet from top to bottom. The run-out on the flat was 300 feet in length. In this reconstruction the take-off was lengthened, the grade of the upper hill decrease and lengthened, and the 10-foot tower lengthened to 30 feet. On this hill the longest jump recorded was 40 meters (131 feet) by Rolf Monsen on February 22, 1927.

Becomes 60-meter Hill

Finally in 1927 the present Intervales 60-meter jump was develop. The grade of the

lower hill was increast to 39 degrees at the 170-foot mark. The upper hill was lengthened and the tower rebuilt in steel, 12 feet wide and 66 feet high, with two starting platforms. In 1928 the tower was lengthened by a new section increasing its vertical height to 75 feet. The take-off as now designed was also completed in 1928. Vertical height of the upper hill from the take-off to the tower was thus made 36.5 meters or 120 feet.

The total investment in the present 60-meter hill is approximately \$35,000.

Two stands at Intervales hill, one on each side of the take-off, are of unique design, built on a slant to give the maximum number of spectators (approximately 100 on each side) an unobstructed view of the entire hill from the top of the tower to the end of the run-out at the bottom. From all other seats an unobstructed view of the entire lower hill is obtained. Total seating capacity of the stands on either side of the take-off and landing hill is 1,022. Total seating capacity at the time of the III O W G was 6,200, made possible by new horseshoe stands at the end

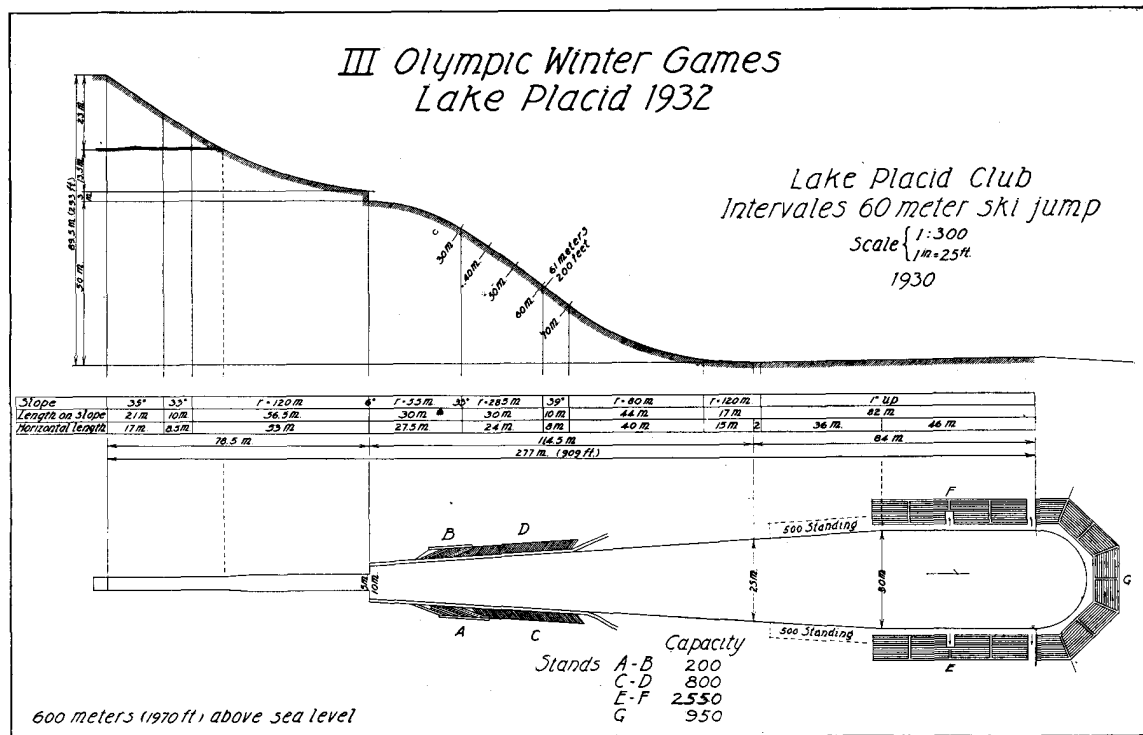

Olympic ski-hill plan and elevation

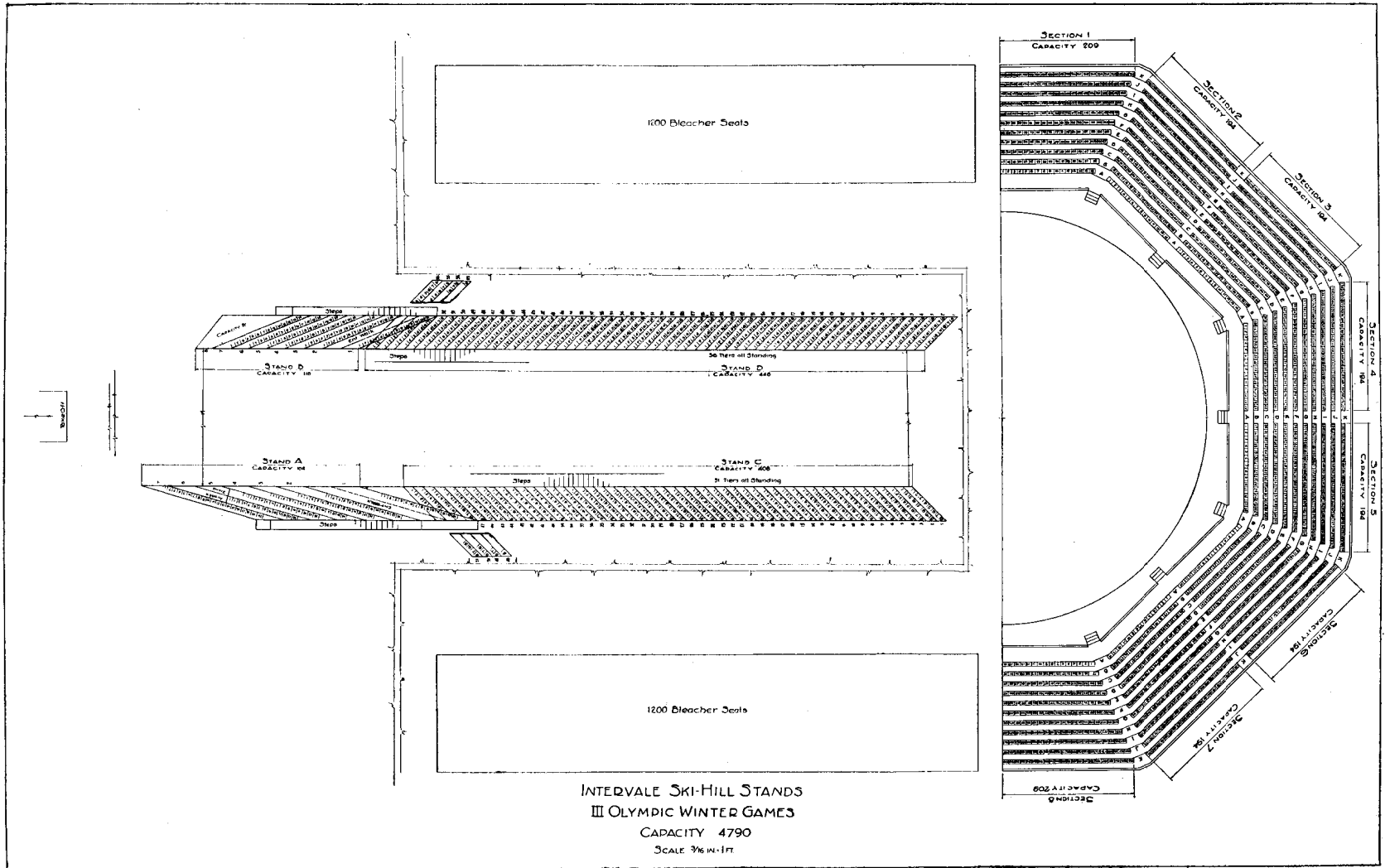

Seating plan at Olympic ski-hill

of the run-out and additional bleacher seats along either side. Ample standing-room is available. About 10,000 spectators stood and watched the Olympic ski-jumping competitions on the afternoon of February 12, 1932. Wooden stairs running up at a gradual incline extend from the foot of the lower hill to the take-off on both sides, and from the take-off to the summit on one side.

No Tangent before Take-off

The most distinctive feature of Intervales hill, contrasted with the majority of other slides, is the elimination of the tangent preceding the actual take-off. It was felt by the designer that a carefully-graded curve of uniform and ample radius extending from far up the hill all the way to the actual take-off would enable each jumper to time his spring by eye exactly as he might wish, with no disturbing shock. Loss of velocity is minimized, and every jumper has the advantage of a slight but constant and steadying sense of pressure all the way to his actual spring.

This feature is not original or untried. It has been used with great success, among other places, at the Chamonix 1924 Olympic jump and the Bernina jump at Pontresina, which held the world's record for distance in 1928.

Not more than three or four hills in North America or in Europe have a lower slope with 39 degrees maximum grade or more. Hills with records of longer jumps differ from Intervales chiefly in lengths of upper and lower slopes and grade of the lower slope with suitable adjustment of the take-off.

Speed, grade and length of lower hill, together with adjusted grade of take-off, are the primary factors determining distance. In designing Intervales it was aimed to secure a maximum distance of 200 feet under normal snow conditions, with take-off about 14 inches lower and at least 2 degrees steeper than used in the official Olympic events. Illustration of the correct engineering design of the hill is found in the fact that when the take-off was raised 14 inches the lower hill was outjumped when skiers started at the top of the tower. For this reason contestants in the main Olympic jump were started about 12 feet below the

top and, with the added factor of unusual skill, the record standing jump was 71.5 meters (235 feet), made by Hans Beck of Norway on February 12, 1932.

Intervales hill was designed by Dr Godfrey Dewey, president of the III O W G Committee.

It slopes to the northeast, which in the Adirondack winter climate has been found to be the most desirable exposure.

Parking space for thousands of automobiles is provided in the rear of the horseshoe stands at Intervales and in a large plot almost directly across the highway from the main entrance.

During the Games bus and taxi service was provided to and from the jump.

Announcements of the results during the III Olympic Winter Games were carried over a "public-address" system to the main press room in the high-school building in the village, and the same results were also broadcast to the crowds at the jumps thru loud speakers located at strategic points in the stands.

Ski-jumping Has Rapid Growth

From the time the first ski-jumping competition was held at Intervales February 21, 1921, with 3,000 attending, the sport has had an almost mushroom-like growth in popularity. Formal organization of the Sno Birds at Lake Placid Club in 1921 had a great deal to do with that growth. This group cooperated with Club officers in planning winter programs and tournaments. Annual tournaments, open to all skiers belonging to member clubs of the National Ski Association of America and the Canadian Ski Association, have been held annually on Washington's birthday from 1921 until the present time. In the period between Christmas and New Year's of each winter, beginning in 1921, a College Week tournament has been staged. This College Week program has been the means of developing interest in winter sports among the colleges of the United States and Canada and has also brought to the fore many college jumpers who have given good accounts of themselves in the larger tournaments and even in Olympic competition.

Cross Country Ski Trails

Cross-country skiing has been enjoyed in Lake Placid for 30 years or more. Most of the skiing is thru wooded trails, many miles of which have been prepared and built especially for this sport. Altho several miles of suitable trails are maintained by private organizations, the largest part of the system is supervised by the New York State Conservation Department. There is afforded a large variety of terrain. Some of the trails are suited to the novice, some to touring, while still others are built particularly for the expert competitive skier.

Trail maintenance in the Lake Placid section of the Adirondacks was first started by the New York State Conservation Department on public land areas in the summer of 1920. These paths were prepared mainly for summer hiking and camping. It was not until 1929 that the Conservation Department, recognizing the need of trails suitable for the cross-country ski races in the III Olympic Winter Games, co-operated with the III Olympic Winter Games Committee in an extensive trail-building program which included the construction of 70 miles of new trails as well as the widening for skiing use of many miles of existing trails.

It can be stated conservatively that within a radius of 10 miles of Lake Placid, 250 miles of good ski trails are now available. Some of these trails are particularly suited for inclusion in 18 and 50-kilometer races of Olympic standards, while others furnish excellent touring for the rank and file of skiers.

Trails Radiate from Lake Placid

Suitable ski trails extend in all directions from Lake Placid, altho construction of new trails has been mostly to the north, east and south. While there are several good ski runs to the west of Lake Placid, they are not as popular as the trails in the other directions.

After the award of the III Olympic Winter Games to Lake Placid, the president of the Organizing Committee appointed George W Martin the official trail supervisor to plan

suitable trails for the Olympic 18 and 50-kilometer races. In co-operation with the Conservation Department of New York state, and especially W G Howard, superintendent of lands and forests, J H Hopkins, district forest ranger, and Abe Fuller, the local ranger, 70 miles of trails were scouted and eventually built, adapted particularly to ski touring and racing. The work involved 31 days of preliminary scouting and marking, while two months were spent by a crew of 10 to 14 men in actually building the trails. Wherever possible they were constructed in such a fashion as to furnish comparatively easy running in one direction for the less experienst skier, while affording a severe test of ski technique if taken in the opposite direction.

In order to furnish the necessary climbing height for the 18-kilometer race in the Mt Whitney section a number of smaller connecting trail links were built so that several suitable combinations could be made, offering a varied choice of Olympic ski race courses.

A 30-mile trail was built around Whiteface mountain. This without doubt represents the hardest single 50-kilometer race course, and in respect to terrain approaches the ideal test of skiing for the long race.

Of distinct value to the ski-tourer, as well as furnishing excellent ski race terrain, is the loop known as the Hart lake loop, another addition to the system.

The trails on the Sentinels, improved and increast in length, comprise valuable additions to the net-work.

Trails Measured with Steel Tape

The 70 miles of new trails built and also the other existing trails which were planned as part of the Olympic race courses were accurately measured by steel tape. Both the 18 and the 50-kilometer race courses submitted to the International Ski Federation for use during the Olympic Games were thus measured within a fraction of a kilometer.

All the new trails as well as many of those already in existence for a number of years are fully described in New York State Conservation Circular No 10, issued in the spring of 1931. This circular includes a map of the complete trail system.

The New York State Conservation Department, recognizing the growing need of ski trails, has built several purely for touring purposes. The outstanding ones include an excellent ascent of Whiteface mountain from the north side, known as the Franklin Falls trail. The path to the top of Tahawus (Marcy), which is the highest peak in New York state, has also been greatly improved for ski use.

Four different 18-kilometer ski race courses, fully described and mapped, were submitted to the Jury of Terrain of the International Ski Federation prior to the Olympic competitions. Although poor snow conditions necessitated special preparation of trails for this race, it was possible to use the course selected by the committee, and the race was satisfactorily held as scheduled.

The total rise of these 18-kilometer courses varied from 460 to 500 meters. The course selected is known as the Mt Whitney route. The start and finish were at the Olympic stadium. From the stadium the route went over the Lake Placid Club golf course to Cherry Patch pond, thence to Mud pond, to Connery pond, and to East Bay of Lake Placid. From there Mt Whitney was ascended, the highest point being reached at 13 kilometers. The descent led past the Lake Placid village reservoir to Mirror lake, and followed a winding route over the lake to the Olympic stadium. The exact distance of the course was 18.214 kilometers.

Five 50-km Courses Submitted

Five 50-kilometer ski race courses, each over terrain different from the others, were submitted to the Jury of Terrain of the International Ski Federation for the selection of one Olympic course.

The total rises in these courses ranged from 1375 meters to 1800 meters. The

course selected was the Clifford Falls route, the exact length of which was 49.947 kilometers.

This course went from the Olympic stadium to the AuSable river, over the North Notch Sentinel trail to Clifford Falls, near which an auxiliary feeding station was placed. It continued running thru the South Sentinel notch to the ski jump, where the main feeding station was located at 31.6 kilometers. From there the course went over Tablelands farm on the lower Hart lake loop, cutting across to the upper Hart lake loop, to the Bear Cub, where the second auxiliary feeding station was located. The route led from there over "Top of Heaven" to the Olympic stadium.

All preparations were made to hold the Olympic 50-km race on this course, but the severe thaw which set in 2 days before the race made it necessary to give up the route as planned. Instead, a 23.77-kilometer loop was run twice with a .685 extension at the finish, which made the exact distance 48.239 kilometers. The loop was part of the originally-selected 50-kilometer course and extended from the AuSable river thru the North Notch trail to Clifford Falls, returning by way of South Notch trail. The start was at the junction of South Notch trail and the River road, where the main feeding station was also located. After running this loop twice, the contestants continued along the River road to the finish.

In spite of bad weather and snow conditions, especially for the 50-kilometer test, the cross-country ski-runners at the III Olympic Winter Games turned in excellent times.



Stanislaus Zentzytzki, designer of Mt Van Hoevenberg Bob-run

The Olympic Stadium

When it was decided that Lake Placid would ask the International Olympic Committee for the award of the III Olympic Winter Games, it was realized that one of the first facilities that the local committee would have to provide would be a stadium for the speed-skating, opening and closing ceremonies, and other events on the official program.

Fortunately Lake Placid possess a site almost perfect for the purpose, the high-school campus, directly across from the North Elba town hall, where it was planned to establish Olympic headquarters. In addition to an ideal natural location, the campus adjoined the high-school building, in which it was decided to utilize class-rooms and other facilities as dressing-rooms for the athletes and for a variety of other Olympic purposes. In this tentative plan the Lake Placid Board of Education express a willingness to co-operate to the fullest extent. The north and northwestern ends of the campus ran into sloping ground which, when properly excavated and graded, would help to form a natural amphitheatre.

As soon as the award of the Games was made to Lake Placid on April 10, 1929, immediate steps were taken to proceed with plans for the stadium.

At a general meeting of Lake Placid civic groups, held on May 6, 1929, official sentiment favored the construction of the stadium on the site described above. The next step had to do with the raising of the necessary funds.

At a meeting on May 15 it was voted to recommend to the North Elba Town Board that a proposition to raise \$200,000 by a bond issue for the stadium and other Olympic expenses be put before the voters of the North Elba parks and playgrounds district at an early date. Incidentally, this district includes all that portion of the Town of North Elba not lying within the corporate limits of the village of Saranac Lake.

The special election on this \$200,000 bond issue was called for June 4, 1929, when tax-

payors, by a vote in excess of five to one, past the measure.

Additional Property Purchase

In order to secure the acreage essential for the construction of the stadium and in order to centralize control and ownership, it was found that it would be necessary to purchase four adjoining pieces of property totalling 435 acres. The high-school campus itself contained 2.8 acres. This was eventually leased by the North Elba Park Commission from the Lake Placid Board of Education for a period of 99 years. Thus the site of the stadium contained in all 7.3 acres.

Following the favorable vote on the bond issue, plans were initiated for acquiring the necessary acreage. This was all finally secured.

First Construction for Games Begins

Early in December, 1929, the first construction in preparation for the III Olympic Winter Games began-work on the drainage culvert to run diagonally across the campus under the stadium.

Shortly after New Year's Day, 1930, workmen began tearing down the seven buildings that stood on the property to the north of the high-school campus. These buildings included two old hotels, one of them unused, dwelling-houses, and a garage. None of these buildings were modern, and tearing them down and utilizing the land as part of the stadium site added greatly to the attractiveness of the village civic center, where the Olympic stadium was to stand. Thus building the stadium served a dual purpose-it provided an essential Olympic facility and it improved markedly the appearance of the heart of the village.

After Governor Roosevelt, early in March, signed the bill legalizing the \$200,000 bond issue, the issue was quickly disposed of, contracts were let, and work on the excavation for the stadium site began on April 7, when the first shovelful of earth was turned in the presence of a large crowd. Work went forward on schedule all thru the summer, and

both grading and excavation were completed in November of that year.

The general plan of getting the stadium site ready for the erection of the stands and other facilities included excavation on the property acquired at the northern end, the necessary removal of dirt, raising the southern end of the site, and leveling the stadium floor. In this way much of the dirt dug from one end of the stadium was hauled to the other for grading and leveling, an ideal arrangement.

In all, 151,840 cubic yards of dirt and rock were excavated. 75,964 cubic yards were used for a fill around the western shore of Mirror lake in the village, where it was planned to build a walk or promenade. The rest of the dirt was moved to the other end of the stadium or was utilized for grading in various parts of the village.

Stadium Track Is Built

As soon as the excavation job was finished and before cold weather set in, a quarter-mile (440-yard or 1320 feet) track was laid out on the stadium floor for the use of the high-school students, and everything was put in readiness for flooding and icing this track, which was to be made an official 400-meter (1312 feet) speed-skating course in the winter. The track was built of cinders and gravel and was carefully under-drained.

As soon as permanent winter set in and the track was flooded and iced, a hockey box was built inside the skating course. In this box all the hockey games of that season in Lake Placid were played. The stadium, even with the stands not yet built, was used during the winter of 1930-31 for general skating, for the North American speed-skating

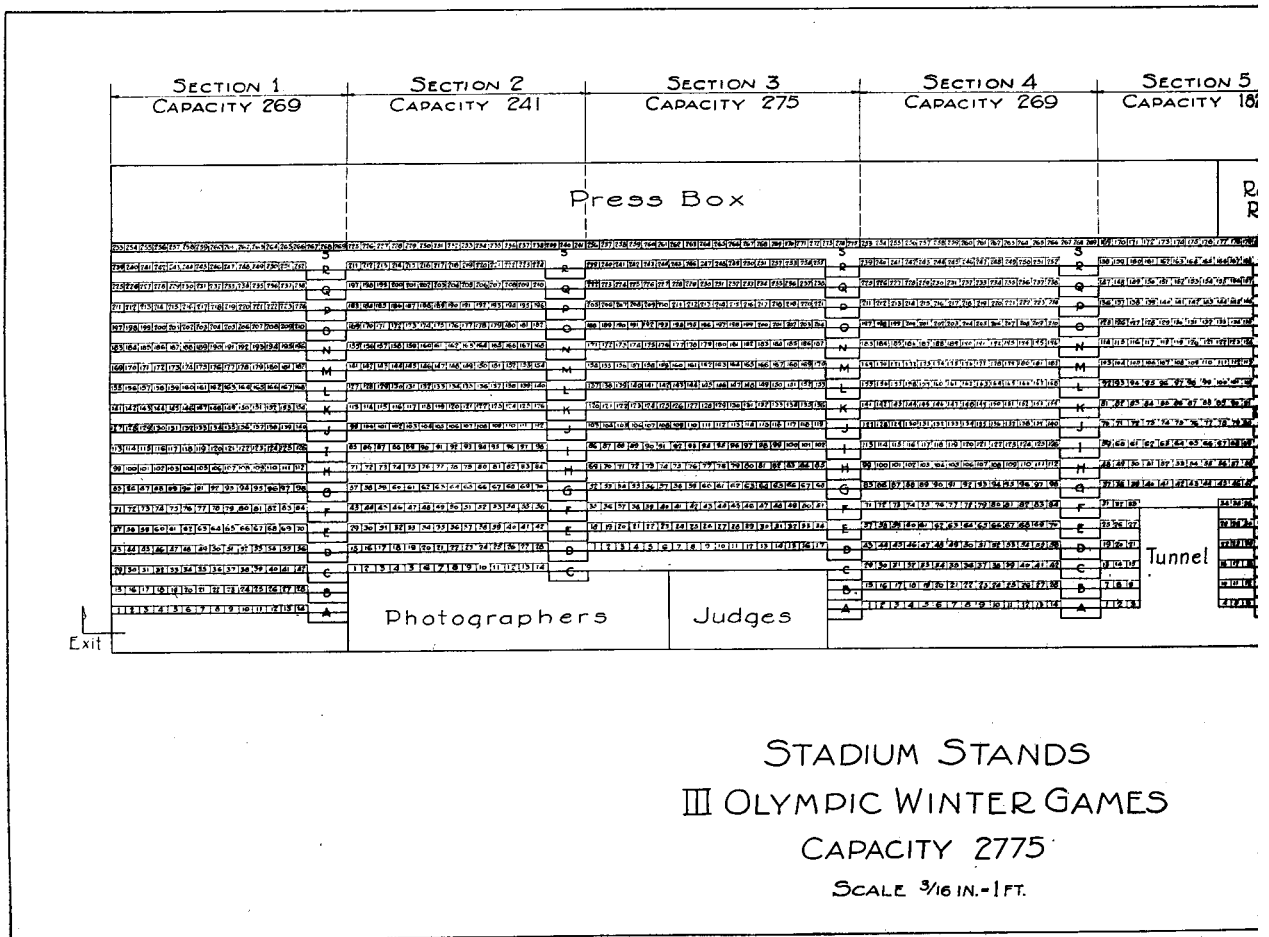

championships, and for the semi-final try-outs for the United States Olympic speed-skating team.

The following spring, 1931, sodding of the entire stadium floor, with the exception of the cinder track, was finished, and the whole area was seeded.

Begin Work on Stand

Work on the grandstand began September 15, 1931, and was finished on November 26. This stand was at the western side of the stadium at the point nearest to the high-school in order to have it convenient for spectators, newspaper men, and competitors who used rooms in the high school for a variety of purposes during the Games.

After a careful study of the most desirable wood for the stand, Douglas fir was chosen. 105,000 board feet of this fir were

shipped from the State of Washington via Panama Canal to Lake Placid.

Seating accommodations for 2,875 spectators were provided in the grandstand. The southern half of the two top rows was used by newspaper men as a press-box. At the northern end of the press-box were built three booths for the radio broadcasting companies and the announcer on the stadium public-address system. Both the press-box and the radio booths had a direct, private stairway down to the rear of the stadium. The press and telegraph rooms in the high school were only a few yards distant.

Underneath the grandstand were toilets, a large store-room, public telephone room, and two skating and ski waxing rooms, all heated by oil stoves. Ten dressing-rooms for the Olympic athletes and four committee-rooms were provided in the high school.

SECTION 6 CAPACITY 291	SECTION 7 CAPACITY 297	SECTION 8 CAPACITY 297	SECTION 9 CAPACITY 297	SECTION 10 CAPACITY 357
U	U	U	U	U
T	T	T	T	T
S	S	S	S	S
R	R	R	R	R
Q	Q	Q	Q	Q
P	P	P	P	P
O	O	O	O	O
N	N	N	N	N
M	M	M	M	M
L	L	L	L	L
K	K	K	K	K
J	J	J	J	J
I	I	I	I	I
H	H	H	H	H
G	G	G	G	G
F	F	F	F	F
E	E	E	E	E
D	D	D	D	D
C	C	C	C	C
B	B	B	B	B
A	A	A	A	A

Exit

Stands for motion picture operators and still cameramen were built at the top of the grandstand above the press-box, while others were located at strategic points around the stadium. In the grandstand were also sections set aside for the judges and other officials.

Total seating capacity of the stadium, including, in addition to the grandstand several sections of portable bleachers, was 6,475. Standing-room for 1,000 spectators was also provided, making total capacity of the stadium 7,475. Portable bleachers were put up at either end of the grandstand and along the eastern margin of the skating track, and were moved to the ski-jump on the days of the two Olympic competitions there.

During the Games the stadium was enclosed with canvas, eight feet high, attached to poles, from the top of which flew the flags of the competing nations.

The table of honor was near the main entrance facing the street.

Cost of the Olympic stadium, including

property purchase, excavation and grading, stands, and equipment was \$155,879.77.

Following the Games the grandstand was taken down and the wood salvaged. The portable bleachers were stored away and will be used for such community functions as swimming meets, horse-shows, carnivals, and the like.

The stadium was the scene of the opening and closing ceremonies of the Games, all speed-skating events, start and finish of the 18-kilometer cross-country ski race and the sled-dog competitions, and part of the hockey schedule. The site remains as a permanent addition to Lake Placid's sports facilities. It is a beautiful athletic field in spring, summer, and fall, for use by the high school and the entire community. In winter it will be utilized for speed-skating, outdoor hockey, and other sports.

For a detailed description of the Olympic stadium as it appeared on the morning of the opening day of the Games, see section of this book entitled *The Opening Day*.

The Olympic Arena

During the III Olympic Winter Games of 1932, for the first time in Winter Olympic history, the figure-skating competitions, the curling demonstration, and part of the hockey schedule were held indoors, where inclement weather could not interrupt the program. This was because Lake Placid provided a huge indoor ice arena for the Games. No resort in the world, outside the larger cities, can boast of such a building. Never before had any part of a Winter Olympic program been held under a roof.

Dr Godfrey Dewey, president of the III Olympic Winter Games Committee, first proposed an indoor arena for Lake Placid and it was his vision, his faith, and his tenacity of purpose in the face of obstacles that would have discouraged most men that finally made the arena possible. Dr Dewey pointed out that the program of the II Olympic Winter Games at St Moritz was suspended for a consecutive day and a half, and interfered with before and after that time, by an un-

precedented thaw, while the Olympic program at Chamonix in 1924 was immediately preceded and followed by severe thaws. Lake Placid could not afford to take these chances on unusual weather conditions, he emphasized again and again.

While the arena was mentioned by Dr Dewey in several of his public addresses prior to the award of the Games to Lake Placid, and while its necessity was frequently stressed in subsequent statements, it was not until work was actually begun on the Olympic bob-run late in the summer of 1930, and other Olympic construction projects were moving along speedily that plans to erect this structure were given serious consideration. An indoor ice arena was not promised by Lake Placid as one of the facilities that it would supply for the III Olympic Winter Games, altho its advantages were frequently pointed out.

During a visit to Lake Placid in September, 1930, Count de Baillet-Latour of Brussels,

Belgium, president of the International Olympic Committee, said:

“On a matter of real local interest may I suggest that when the Games are over something tangible and physical must remain in Lake Placid as a sort of memorial to the Games.

“Therefore, I venture to suggest that it would be a great utility should an indoor rink be built in the village of Lake Placid.

“Whether or not this may be possible, I know that the existence of such a rink would be a source of comfort and great encouragement to contestants coming here. They would know that in case of inclement weather there would still be a place where figure-skating and ice hockey could be undertaken.”

By this time sufficient interest had been aroused in the arena project to warrant a public meeting of local citizens to consider it further. Accordingly on Monday evening,

September 29, 1930, a mass meeting was held in the town hall under the auspices of the Lake Placid Chamber of Commerce. Attending this meeting, in addition to chamber of commerce members, were representatives of such Lake Placid organizations as the North Elba Park Commission, Lake Placid Board of Education, North Elba Town Board, Kiwanis Club, Lake Placid Athletic Club, and others.

At this time it was hoped that the State of New York, thru the Olympic Winter Games Commission, would aid in building the arena. Later, this idea was abandoned.

Arena Sites Considered

As a result of this first mass meeting, a committee was appointed to consider several proposed sites for the arena, and William



— Pierson Studio

The Olympic arena floor before the concrete was laid. Over nine miles of these steel pipes carry the freezing mixture to make the huge ice sheet

G Distin, an architect of Saranac Lake, was instructed to prepare preliminary plans for the building and have them ready for a later meeting. The site favored by the committee for the location of the arena was in the village park, south of the outlet brook near the municipal bathing-beach. Other sites considered were the plot in the rear of Lake Placid high school and the upper level to the northwest of the stadium.

All that fall and the next winter the indoor arena project was argued pro and con. While there was pretty general agreement on the need for such a structure in Lake Placid for the Games and during the years to follow, two questions could not be answered by any convincing majority--"How is the arena to be financed?" and "Where is the best site to build it?"

Finally after many official and unofficial meetings, and after discussions probably consuming enough time for a trip around the world, in April, 1931, a joint meeting of Lake Placid, civic and Olympic groups voted to build an arena. The Olympic directors were also asked to inspect the suitability of the site on the property owned by the Grand View hotel on Main street across from the village fire-house. This site had been receiving more and more consideration by the proponents of the arena project after it was found that the village park site, at first favored, would not be satisfactory to a majority of citizens.

Secure Option on Arena Site

Early in May, the III Olympic Winter Games Committee secured an option on the Grand View property, good until June 1. Included in the parcel were approximately nine acres of land. The site was considered ideal for the arena, since it was centrally situated on the main street of Lake Placid and was only a short distance north of the Olympic stadium and Olympic headquarters in the town hall at the civic center.

In June, 1931, the North Elba Town Board purchased this property. The cost was \$20,000. The next step remaining in the project to have an indoor arena in Lake Placid by the time of the III Olympic Winter Games

was that of financing the construction of the building itself. Plans and specifications had been prepared by the architect. In the meantime necessary excavation on the newly-purchased plot was practically completed. The state would not build the arena. State officials realized the advantages of an arena but felt that it would be primarily a permanent benefit to the Lake Placid community and that for this reason state funds should not be used for its erection. The project was squarely up to the voters in the North Elba park district. Could the voters be made to see the advantage of voting the necessary funds?

Funds for the land purchase came from the North Elba park district budget. Cost of the building itself was originally estimated at approximately \$200,000. After a careful study of all the facts in the situation had been made, a special election was called for July 30. Voters were asked to approve a bond issue of \$150,000 for the construction of an Olympic arena. The balance of \$50,000 was to be taken from the Olympic budget and Essex County Park Commission funds. (Note: This and other financial matters are discussed in detail in the section of this report devoted to *Finance*.)

Preceding the special election a campaign of publicity was carried on by the Olympic Committee to acquaint the voters thoroughly with all the advantages of the arena and to show by means of tables and charts just what the additional bond issue asked for would cost the individual taxpayer per thousand of assessed valuation.

State leaders of both parties and Governor Roosevelt were appealed to in this emergency. While, as has been indicated above, they felt that state funds should not be used for the erection of the arena, they did promise a deficiency appropriation of \$100,000 to be made available by the 1932 legislature and to be used for other Olympic expenses. This would make possible the application of other funds in the budget toward the cost of building the arena. This promise of the state, which was kept to the letter, naturally had a strong influence on the taxpayers and

was undoubtedly one of the greatest single factors in bringing about a favorable vote.

Enthusiasm for the arena was voist in many quarters. Members of the New York State Olympic Winter Games Commission called it "One of the most important projects in the history of this region."

Arena Funds Voted

Results of the special election on July 30, 1931, follow: For arena bond issue, 386; against, 263.

Construction of the arena was placed in charge of a special building committee con-

sisting of Willis Wells, supervisor of the Town of North Elba, chairman; William Lamb, representing the North Elba Park Commission; and Dr Godfrey Dewey, president of the III Olympic Winter Games Committee.

Work on the foundation for the Olympic arena began on August 22, the excavation job having been completed earlier that month. 28,500 cubic yards of earth and stone were moved in making the excavation. The different contractors workt from plans prepared by Distin & Wilson, architects of Saranac Lake, with whom were associated

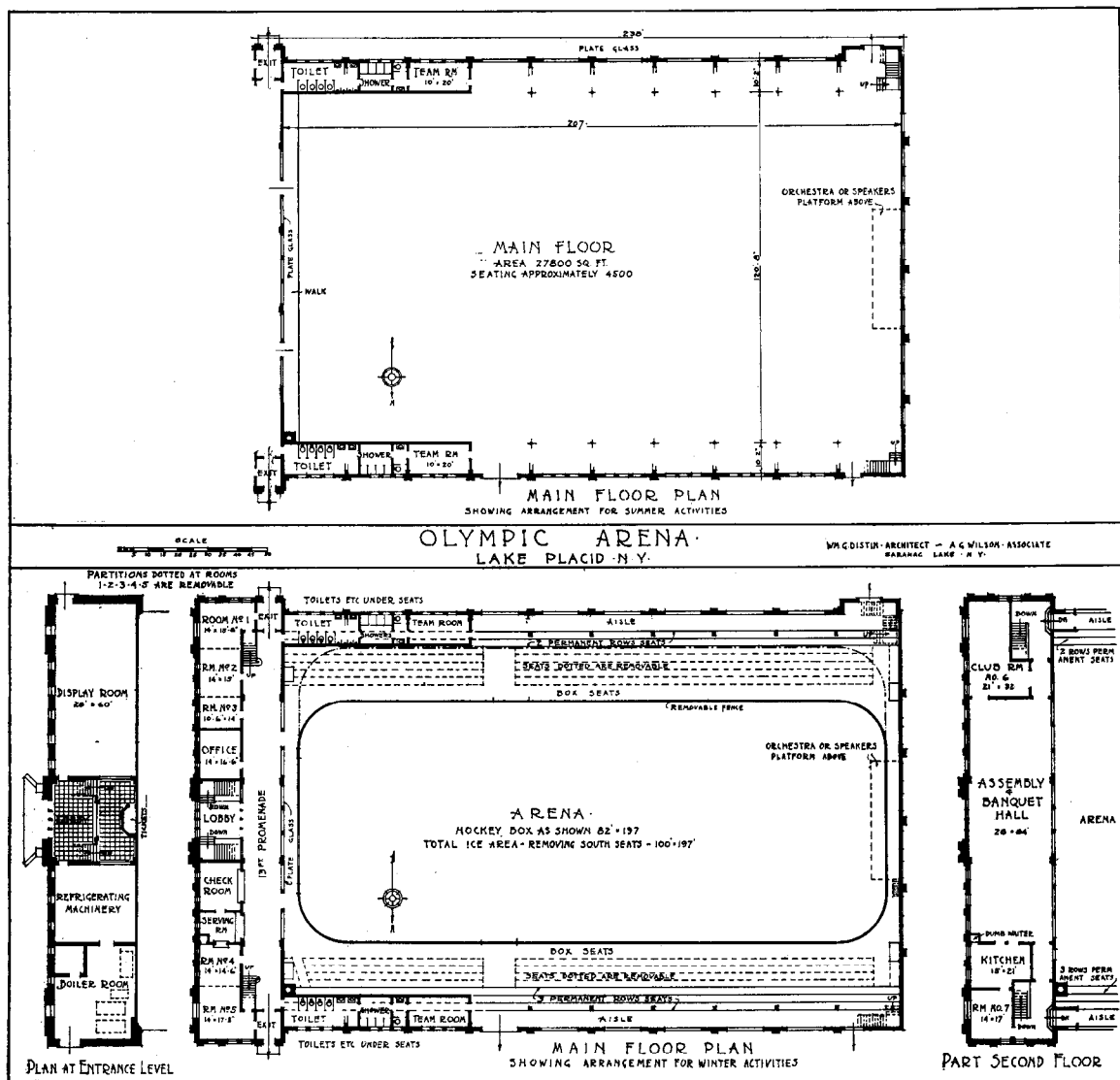

Olympic arena floor plan — winter and summer

Funk & Wilcox of Boston, leading specialists in ice arena construction.

Speed was the keynote on the arena job, as it was necessary to have the building finished in January, well in advance of the opening of the III Olympic Winter Games on February 4. Ideal weather conditions were of great assistance to all concerned in the construction of the arena, and work went forward without a hitch.

Arena Dedicated January 16, 1932

On Saturday night, January 16, 1932, the Olympic arena was formally dedicated with impressive ceremonies before a crowd that jammed every available foot of space. The dedicatory address was delivered by Gustavus T Kirby of New York, past president of the American Olympic Committee and a member of the III O W G board of directors. Mr Kirby spoke in a New York radio studio, and his address was broadcast from there, coming to the thousands gathered in the Lake Placid arena over a public-address system, part of the permanent equipment of the building.

In closing Mr Kirby said:

“Therefore in the name of international sport, in the name of the III Olympic Winter Games Committee of which the governor of the great state of New York is honorary president and Godfrey Dewey its indefatigable head and prophetic organizer; in the name of the Adirondack region, and especially of the Town of North Elba and the village of Lake Placid; in the name of the world brotherhood of sportsmen and especially of the athletes of America, I dedicate to the uses and purposes of this countryside, to the profit and enjoyment of the people now and hereafter to be gathered together for friendly sports competition, for the consideration and solution of problems of state, of professions and business, this splendid arena.”

Other speakers at the dedicatory ceremonies were Dr Godfrey Dewey, president of the III Olympic Winter Games Committee; Supervisor Willis Wells, chairman of the arena building committee; Supreme Court Justice O Byron Brewster; Senator Warren T Thayer, chairman of the New York State

Olympic Winter Games Commission; and Frank S Leonard, a trustee of Lake Placid village.

Following the dedication, the first athletic contest to take place in the arena got under way, a hockey game between the St Nicholas Club of New York and the Lake Placid Athletic Club. The “St Nicks,” with five players of the American Olympic hockey squad in their line-up, downed the Lake Placid sextet 3 to 2.

Arena Saves the Day

The arena now stands as one of Lake Placid’s greatest permanent assets as a summer and winter resort. It proved its worth during the pre-Olympic period and during the Games themselves.

Unprecedented weather conditions during the weeks immediately preceding the Games, when high temperatures and lack of snow and ice outdoors made it difficult for Olympic athletes to get in preliminary work-outs, found the Olympic arena ready to fill the breach. “The arena certainly saved the day,” was the comment frequently heard.

It provided facilities for the figure-skaters, the curlers, the hockey teams, and even the speed-skaters to practice. It was crowded with contestants and spectators morning, afternoon, and evening, all during the last part of January and early February.

During the III Olympic Winter Games themselves the Arena was the scene of all the curling matches, the figure-skating competitions, and it prevented any postponement of the hockey schedule on account of weather. Of the 12 hockey games on the Olympic program, 10 were originally scheduled for the stadium and two for the arena. Bad ice conditions on the stadium rinks caused four games to be transferred to the arena, so that half the Olympic hockey schedule was held indoors. If it had been impossible to do this, in other words if the arena had not been available, the Olympic program would have been seriously disrupted—in fact it might have been impossible to complete the hockey schedule at all.

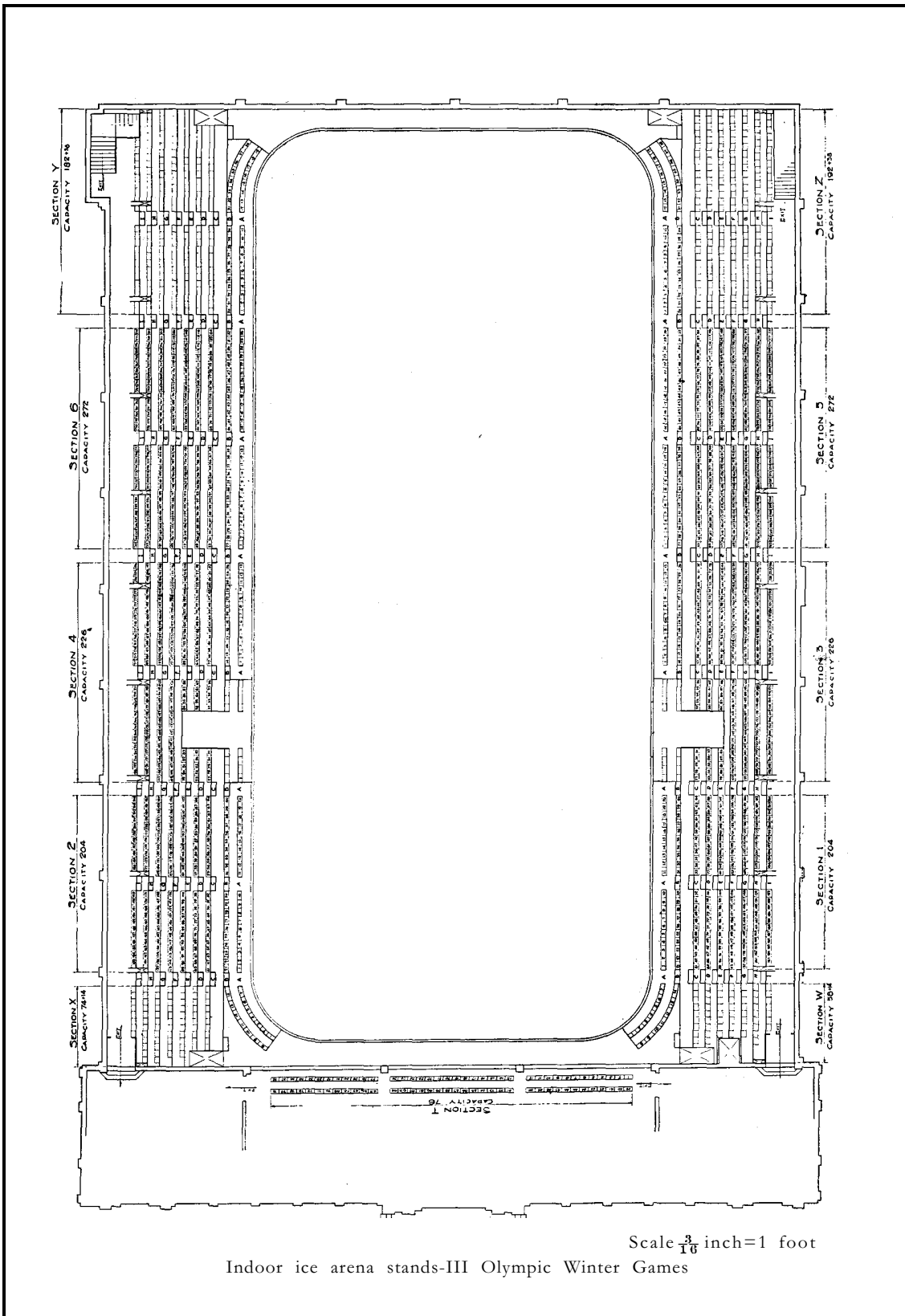



—Roger L. Moore

Hockey in the Olympic arena

Facts and Figures on the Arena

The cost of the Lake Placid arena, including site and equipment, was \$294,082.68.

The arena is a handsome structure of brick, steel, and concrete, dominating the village main street and adding greatly to its attractiveness. It will accommodate 3,360 spectators in winter, 2,360 seated and 1,000 standing; but in summer, when the ice sheet is not in use, over 5,000 can be taken care of.

238 feet long by 143 feet wide, the arena stands with the narrow end and head-house facing Main street. The building is reached by a drive and a flight of steps running up from the sidewalk. The entrance and ticket offices are on the first, or basement, floor. One end of the basement floor of the head-house is given over to the heating plant and ice-making machinery. Between the head-house and the arena proper on the floor above is a promenade, separated from the arena by a plate-glass partition. Along the

street side of the promenade are offices, check-rooms, and concession spaces.

The ice sheet measures 30 x 60 meters, or about 98½ x 197 feet, including a curling sheet at the south side of the hockey box. The entire ice sheet may be used for figure-skating, curling, or speed-skating when desired. The ice sheet is one of the largest in the world. Along either side sloping tiers of seats run down to the rink itself, with a row of boxes at the rink-side. Dressing-rooms for the men run along the south side of the building underneath the stands while those for the women are on the north side.

On the top floor of the head-house is a balcony, with club-rooms at either end. This balcony, when not used for seating, is ideal for parties and dances, in fact for almost any kind of community social activity. At the time of the III Olympic Winter Games this space was converted into a restaurant. Plate glass separates this balcony from the main part of the arena.

Over nine miles of steel pipe carry the freezing mixture to make the arena ice-sheet. These pipes are an inch and a quarter in diameter and are imbedded in a mixture of steel shavings and concrete. Over this the ice sheet is frozen. During the hockey games and figure-skating competitions the arena is maintained at a constant temperature of approximately 50 degrees. Spectators are therefore comfortable at all times.

In the Lake Placid rink the ice can be tempered for figure-skating by changing the temperature of the brine. This gives the figure-skaters just the right kind of ice needed at any time. European figure-skaters who competed in the III Olympic Winter Games stated that the arena ice was consistently of the finest quality.

The south side of the arena is practically one huge sheet of plate glass, which affords a magnificent view of the high Adirondack mountain peaks a few miles south of Lake Placid village.

A public-address system is part of the permanent equipment of the arena. Loudspeakers at the western end of the auditorium bring phonograph music to the skaters and announcements of the progress of any athletic event in the arena to the crowds.

Lake Placid's winter season, which normally lasts from early December until well into March, is expected to be extended by the arena to include the period from Octo-

ber to April. It is planned to have the ice sheet on the arena floor during that entire time, so that the huge building may be used for hockey, speed-skating practice, figure-skating, curling, ice pageants, and similar activities. These pageants, incidentally, attracted capacity crowds during the 1932 winter season.

During the spring, summer, and early fall the arena will be utilized for convention meetings, horse-shows, automobile shows, indoor baseball, indoor tennis, roller-skating, badminton, horseshoe pitching, play periods for children in bad weather, and a variety of community activities.

Lake Placid is now the only resort in the United States, situated in the country, where artificial ice is available all winter long, so that when weather conditions outdoors are too severe the many sports activities which the arena provides may be enjoyed indoors regardless of rains, sub-zero temperatures, or raging storms. Now no visitor to Lake Placid need fear that weather conditions will interfere with the enjoyment of his holiday. This combination of rural and urban sports advantages places Lake Placid in a class alone.

It is confidently expected that the arena will bring in many thousands of dollars yearly to Lake Placid. From facts available up to the time this report is written, including a highly successful automobile show held early in May, 1932, that expectation will be amply fulfilled.

The Mt Van Hoevenberg Bob-run

Included in Lake Placid's proposal to the International Olympic Committee that the III Olympic Winter Games be awarded to this resort was the express promise that if such award should be made, Lake Placid would provide a bobsled run for the international competitions equal to any of the famous European slides.

The Games were awarded to Lake Placid in April, 1929, by the International Olympic Committee, meeting in Lausanne, Switzerland, but work on the bob-run project began early that same year. It was carried steadily

forward month by month in the face of obstacles which tested to the limit the courage of those promoting the Games. The story of events leading up to the actual construction of the Mt Van Hoevenberg slide is interesting and will be told briefly here.

State Promises Co-operation

Prior to the extension of the invitation to the International Olympic Committee to award the III Olympic Games of 1932 to Lake Placid, unofficial conferences with Governor Franklin D Roosevelt and other state

leaders disclosed the fact that the state was willing and anxious to co-operate with Lake Placid in its ambitious project to stage the international Games. This promise of co-operation was an essential factor in Lake Placid's submitting a formal bid to the Lausanne meeting. Without this co-operation of the state the Games could never have been staged in Lake Placid.

State political leaders of both parties promise that the state's initial assistance would be in the form of funds with which to build a bobsled run, since construction of the bob-run at that time appeared to be one of the largest items of expense in the proposed Olympic budget, and with the best sites for the run on state land it was quite appropriate that state funds be used for this purpose.

In February, 1929, the New York state legislature passed a bill authorizing the building of a bob-run on privately-owned lands

with state funds, if and when they should be available, and provided the III Olympic Winter Games were finally awarded to Lake Placid. Governor Roosevelt signed this bill on February 21, 1929, and it became Chapter 23 of the Laws of 1929. A copy of this bill became part of Lake Placid's proposal for the Games as submitted by Dr Dewey at the meeting of the International Olympic Committee at Lausanne in April. This concrete evidence of state support of Lake Placid in its plans for the Games helped materially to secure the award. This was the first Olympic bob-run legislation to be passed at Albany. Much more followed, as will be seen.

Sections of this first state act follow:
 "AN ACT

"To authorize the construction, equipment, and maintenance of a bobsleigh run or slide in the Town of North Elba, Essex county, for use in connection with the III Olympic Winter Games.

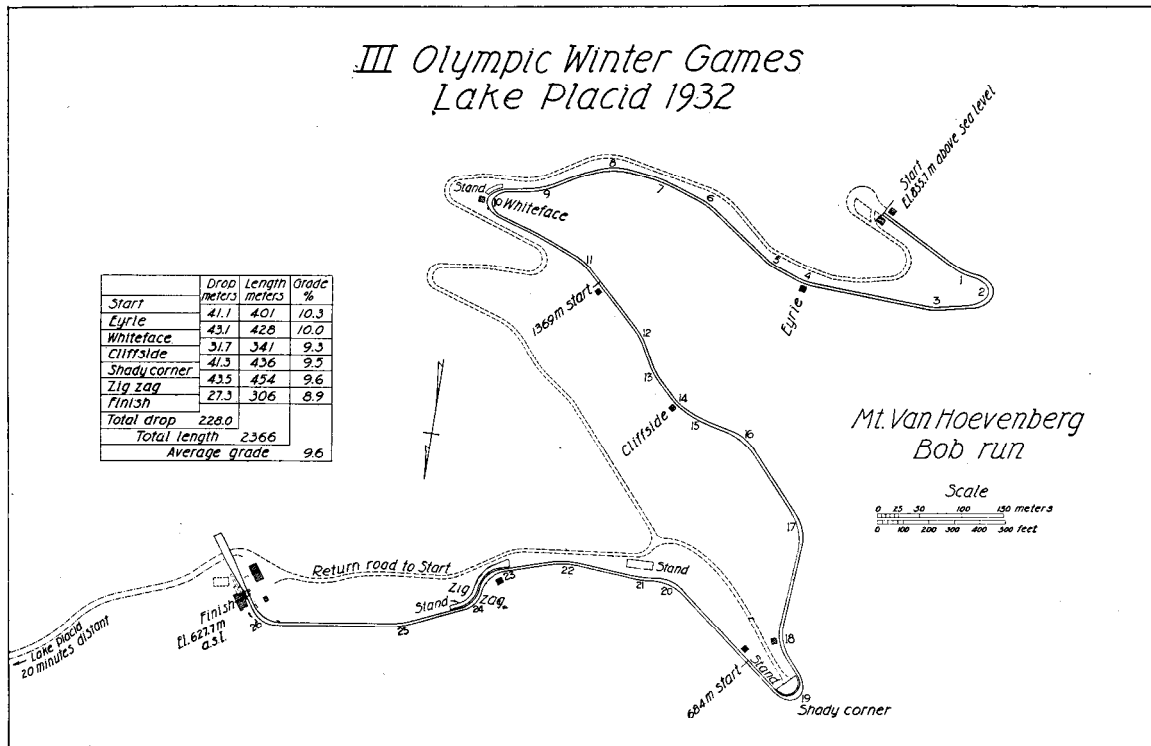

Olympic Bob-run

"The People of the State of New York, represented in Senate and Assembly, do enact as follows:

"Section 1. When moneys shall be available therefor by appropriation, the conservation commissioner is hereby authorized to construct, equip, and maintain, for use of the public in connection with the III Olympic Winter Games to be held January and/or February of nineteen hundred thirty-two, a bobsleigh run or slide, including a way for returning such sleighs to the top, on lands in which any necessary easement may be provided without cost to the state, in the Town of North Elba, Essex county. This authorization, however, shall not be effective unless and until it shall appear to the satisfaction of the commissioner, and he shall have so certified to the comptroller, that the organization known as the International Olympic Committee has determined to hold the III Olympic Winter Games at the times above stated at or in the vicinity of Lake Placid . . . When completed, such run or slide shall be maintained for the use of the public under the direction of the conservation department, and shall be used and operated subject to its rules.

"Section 2. This act shall take effect immediately."

The foreign copies of Lake Placid's proposal for the III Olympic Winter Games went forward on February 22.

Second Bill Introduced

Before the close of the 1929 session of the legislature another bill was introduced providing for the construction and maintenance of a bobsleigh run or slide on state lands on the western slope of Sentinel range in the Adirondack forest preserve and contemplating an appropriation of \$75,000. This measure was past by both assembly and senate and was signed by Governor Roosevelt, becoming Chapter 417 of the Laws of 1929.

This second bill was introduced because it was felt by state leaders and proponents of the Olympic Winter Games project that undoubtedly many of the best sites for the building of the bob-run would be found on state land in the Adirondack forest preserve, and the state constitution provides as follows:

"The lands of the state now owned or hereafter acquired, constituting the forest preserve as now

fixed by law, shall be forever kept as wild forest lands. They shall not be leased, sold or exchanged, or taken by any corporation, public or private, nor shall the timber thereon be sold, removed or destroyed."

It was thought advisable to make a test case of the constitutionality of building the run on state land before actual construction should be far advanced, in order that a last-minute injunction, by interests opposed to the construction of the bob-run on such land, might not seriously hamper the work of having the run ready for use a year before the Games. If it should be ruled that the Olympic run could not be built on state-owned land in the forest preserve, leaders planned to know it well ahead of time and proceed to the selection of a site on privately-owned land near Lake Placid.

The matter of the construction of the bob-run rested there during the spring of 1929. State co-operation was assured, and plans were matured for finding out just where the Olympic slide could legally be built.

Games Awarded to Lake Placid

On April 10, 1929, the III Olympic Winter Games were awarded to Lake Placid. The III Olympic Winter Games Committee was immediately organized.

On June 4, 1929, Hamilton Ward, attorney-general of New York state, advised Conservation Commissioner Alexander Macdonald that it would be proper for him to proceed with the initial steps leading to the construction of the bobsled run. This opinion was advanced merely to bring before the courts of the state the question of whether the run could, or could not, be built on state land.

The last paragraph of Attorney-general Ward's letter to Commissioner Macdonald is as follows:

"Therefore for the purpose of bringing this matter before the Courts I advise you that in my opinion it is proper for you to proceed under Chapter 417 of the Laws of 1929 until restrained by appropriate action."

This letter was written by Attorney-general Ward following receipt of a communi-



—G Cleveland

Crowd in the stands at Zig-zag curve

cation from John G Agar, president of the Association for the Protection of the Adirondacks, stating that if the attorney-general ruled that Chapter 417 of the Laws of 1929 was constitutional, he (Mr Agar) had been directed to test the question in the courts.

Initial Surveys Are Made

While this legal sparring was going on the III Olympic Winter Games Committee had not been idle. Early in the summer of 1929 following the award of the Games to Lake Placid, it began to make preliminary surveys of possible bob-run sites on both state and private land.

To do this work it brought to Lake Placid Stanislaus Zentzytzki of Berlin, engineer of the famous Schreiberhau run in Germany and other well-known European slides. Mr Zentzytzki, one of the foremost bob-run designers of the world, was asked to make the study at Lake Placid since the proposed slide

presented many unique engineering problems as the first major run ever to be constructed on this continent. The sport of bobsledding, known for decades abroad, was something new for American engineers.

Immediately upon his arrival in Lake Placid, Mr Zentzytzki lost no time in getting out into the mountains surrounding the village to study the possibilities for the construction of a championship run, possibilities that had already been thoroughly analyzed by Dr Dewey and those associated with him. There were plenty of mountains. Some, however, were almost inaccessible. Still others lacked the steep slope necessary for the construction of the type of run that he had in mind.

After weeks of study, three sites had been chosen as the most desirable, all within easy driving distance of Lake Placid, and all possessing in greater or less degree the necessary characteristics. These three sites were as follows: west slope of the Sentinel range, Scar-

face mountain, and Mt Jo. The first two sites were all, or practically all, on state land; the last on privately-owned property. The Mt Jo site was considered because it was feared that it would be declared unconstitutional to build the run on state land.

Mr Zentzytzki surveyed and staked routes, made his preliminary report to the committee, and then returned to Berlin to prepare his blueprints and submit his final report and recommendations.

Before leaving Lake Placid, however, he laid out the Intervales practice bob-run for the Lake Placid Club on a steep hill adjoining the Intervales ski-jump. This run was projected by Club officials in order to test thoroly the design of American-built sleds and to train American drivers and workmen on the run. It was seen that the Olympic run could not be finished for the season of 1929-30 because of impending litigation, and it was considered necessary to have a bob-run in use at least two years prior to the O W G for the reasons given above and also to familiarize Lake Placid residents with the sport of bobsledding and to arouse further interest in the construction of the Olympic slide itself. The Intervales run was finished before winter, the first technically-engineered run in the western hemisphere.

Intervales bob-run, the predecessor of the Mt Van Hoevenberg Olympic slide, was approximately a half mile in length, maintained a grade of from 7 to 8 per cent, contained 7 curves, and cost \$6,600. A detailed description of this slide is given in the section of this book entitled *History of Winter Sports in Lake Placid*.

In operation during the winter of 1929-30, the Intervales run proved exceedingly popular. Two major bobsled competitions were held here. Americans resident in the Adirondack section of New York state, as well as those who past part of that winter in Lake Placid, came to know bobsledding as enjoyed in Europe and were keen for its continuance and further development in the United States.

Legal Mills Grind On

In January, 1930, the Supreme Court of New York, Appellate Division, Third Department, before which an action was brought by the Association for the Protection of the Adirondacks, found the bobsled bill, known as Chapter 417 of the Laws of 1929, unconstitutional.

Recourse was now had to the Court of Appeals to declare the bill constitutional so that the Olympic slide could be built on state land.

The bobsled case was argued before the Court of Appeals on February 11. On March 18 this court affirmed the decision of the Appellate Division, namely that it was unconstitutional to build a bobsled run on state land.

Another Site Found

Shortly after the adverse decision of the Court of Appeals, Dr Godfrey Dewey, president of the III Olympic Winter Games Committee, after much study and personal investigation discovered an excellent site for the bob-run on the north slope of what had been called South Meadow mountain. This site was on land owned by Lake Placid Club, so that no conflict with the court ruling was possible. South Meadow mountain, which was later officially named Mt Van Hoevenberg, is situated eight miles from the village of Lake Placid, one mile off the main highway. Its summit rises 2,960 feet above the sea, and its north slope was found to have the grade needed for the construction of the run.

Late in April Mr Zentzytzki, the German engineer, arrived in Lake Placid for the second time to make the final survey for the Olympic run. Decision to build the slide on the north slope of South Meadow mountain (Mt Van Hoevenberg) was reached shortly after his arrival in Lake Placid. His judgment confirmed that of Dr Dewey and other committee members that no better site convenient to Lake Placid could be found.

State Votes Funds for Run

In the meantime the New York state legislature before the close of the 1930 session voted to create a State Olympic Winter

Games Commission and appropriated \$125,000 for the express purpose of constructing a bobsled run for the III Olympic Winter Games and for other expenses incident to the conduct of the Games. This act became a law April 22, 1930, and is known as Chapter 677, Laws of 1930.

With this concrete evidence of the support of the state, and with the funds placed at the disposal of the State Olympic Commission, Olympic groups prosecuted the plans for building the Olympic slide with the greatest diligence.

Mr Zentzytzki left Lake Placid early in June after completing his survey of the Mt Van Hoevenberg site and preparing his plans. Henry Homburger of Smith, Golder & Homburger, engineers of Saranac Lake, worked with Mr Zentzytzki during his survey and took over the task of supervising construction details after Mr Zentzytzki's departure.

Legal details in connection with clearing of title to the land on which the run was to be built were cleared up as rapidly as possible. A perpetual easement over this property was given to the State of New York, said easement to lapse, however, in case the state fails to maintain the run for two consecutive winters. In that event title to the property will revert to the Town of North Elba.

Actual Construction Begins

Contracts were let late in July, all necessary preliminary details were settled, and actual construction work on the Mt Van Hoevenberg Olympic bob-run began. The access road, one mile in length, leading from the main highway to the foot of the mountain, was started a few weeks earlier. As has been indicated the run was built by the New York State Olympic Winter Games Commission, Senator Warren T Thayer of Chateaugay, chairman. It represents an investment of nearly a quarter of a million dollars. Necessary additional funds for its construction were taken from subsequent state appropriations.

First Shovelful of Earth Turned

The first shovelful of earth was turned on August 4, 1930. On Christmas Day, that

same year, the run was opened to the public. It was a great construction record, but the run had been promised a year in advance of the Games, and it was ready as promised.

The Mt Van Hoevenberg Olympic run is 2,350 meters, or approximately 1½ miles, in length and maintains an average drop of about 10 per cent, with a minimum grade of 8½ and a maximum of 15 per cent.

27,374 cubic yards of earth and rock were moved to build the run, which was literally dug and blasted out of rock and forest. On the straightaways the run is 2 meters or 6½ feet wide, while on the curves the width varies from 10 to 22 feet. Some of the curves are 22 feet high, their towering banks of stone running up almost at right angles to the bottom. Unlike most of the European slides the Lake Placid run has a pronounced drop in the curves.

In many of the European runs the curves are flatter than the rest of the slide, while the curves of the Mt Van Hoevenberg run have steeper grades than most of the straightaways. This makes for steadier driving, pilots frequently stating that but little steering is necessary on the banked turns of the Olympic slide at Lake Placid. The drop in the curves serves as an offset to the normal loss of speed and is of immeasurable assistance to the driver.

The Mt Van Hoevenberg run contains 26 curves, the most thrilling being named as follows in order from the top: Whiteface, Shady Corner, Zig-zag. The first two are hairpin turns, and the latter is shaped like the letter "S."

The straightaways are of earth construction, while the highest curves are built of stone. The surface of the run in winter is of glare ice, made by freezing a mixture of snow and water, and is covered in the straightaways with a thin frosting of snow so that the sled runners may bite in and hold the track.

8,000 feet of pipe run 4 feet underground from the bottom to the top to carry the water used in spraying the run each day after it is closed in the late afternoon. About 20,000 gallons of water are needed every 24 hours

for this purpose. This water, which is pumped into the pipe line by a gasoline engine, is obtained from a huge storage reservoir at the bottom and from streams adjacent to the run.

Bobs and riders are carried from the bottom to the top in large open sleds, drawn by crawler-drive tractors.

For the convenience of those who do not wish to take the long ride from the top an intermediate starting-house is maintained at the half-mile mark at Shady Corner.

7 telephone booths, located at strategic points along the run, control its operation. Three telephone circuits run from the top to the bottom. One is a direct circuit. One is a way circuit connecting the intermediate control booths. The third is a special circuit for operating the electric timing device.

Other Bob-run Facilities

At the finish line just south of the Mt Van Hoevenberg run stands the bob-run clubhouse. This building is a two-story structure 60 x 80 feet, finished in rustic Adirondack logs. In the basement is room for four tractors, trucks, a boiler-room, workshop, and the Delco lighting system.

The timing-room, from which the electric timer is operated, is on the first floor of the clubhouse, directly above the finish line.

The second floor is taken up with a restaurant and lounge. Both counter and table service were available here during the III Olympic Winter Games, and thousands took advantage of the opportunity to dine in comfort and watch the races thru the big windows. At one end of the lounge is a huge fireplace, built of native Adirondack stone. The side of the lounge that parallels the run is of plate glass, which affords an unobstructed view of the finish line and the last curve in the run.

At the foot of the run stands the bob garage, a one-story frame structure with space for 60 bobs. An overhead carrier is used to take the sleds to and from their compartments. A large crane at the finish line hoists the bobs from the track to the trailers waiting to take them up the mountain.

The main ticket booth is just north of the finish line, directly opposite the clubhouse.

During the Olympics, stands were provided for spectators at the three best vantage points, Whiteface, Shady Corner, and Zig-zag curve. These accommodated approximately 2,500. Standing-room was practically unlimited. During the Olympic races spectators roamed up and down the entire course of the run.

By means of a public-address system reports of the progress of the bobs during the racing were carried thru loud-speakers to all stands, to the clubhouse at the foot of the run, and to the press-room in the high school in Lake Placid village. The announcer was stationed in a booth on the ground floor of the clubhouse at the foot of the run and received his reports, as the bobs took each curve, from the telephone operators in the booths along the slide. This information he translated into his own story of the races and relayed thru the public-address system. Scoreboards were placed at the three stands along the run and at the start and the finish line.

Transportation to and from the bob-run during the III Olympic Winter Games was provided by buses and taxicabs. Many, however, drove their own cars.

Parking space for several thousand cars was provided along either side of the access road.

An idea of the great interest in the bob sport may be gained from knowing that approximately 14,000 attended the first day of four-man racing during the Olympics.



Bob-run button

World's Record Made

A world's speed record for a major run was made on February 7, 1931, when the "Red Devil" team of Saranac Lake flasht down the mountainside in one minute, 52 seconds, making an average speed of over 76 kilometers or 46 miles an hour. On some of the higher curves a speed of 100 kilometers or 65 miles an hour has been attained.

In unofficial time trials before the III Olympic Winter Games the record of one minute, 52 seconds, was broken, but never in formal competitions.

European teams competing on the Mt Van Hoevenberg run in the III Olympic Winter Games were loud in their praises of its design, construction, and speed, many asserting even that it was the greatest run in the world.

The Olympic Bobs

The bobs used on the Mt Van Hoevenberg Olympic run are built of steel and wood of American design and construction, altho incorporating many of the best features of the Swiss and German sleds. Foreign bob experts at the Games voist in no uncertain terms their approval of both design and construction of the Olympic bobs.

During the winter of 1929-30 the first bob of its kind ever constructed in this country was 'designed in Lake Placid by Lake Placid residents, built at a factory nearby, and given a thoro test on the Intervales slide. With only minor changes, the design was found to be exceptionally satisfactory, and the following winter a fleet of 14 bobs, built from the same design and in the same factory, was in constant use on the Mt Van Hoevenberg run. During the winter of 1931-32, 31 bobs were added to the fleet.

Each four-man bob weighs 485 pounds; each two-man, 352 pounds. The four-man sleds are 11 feet, 7 inches long; the two-man, 9 feet. The bobs are 10½ inches above the ground and steer like an automobile. They cost from \$500 to \$600 apiece, depending on the size.

Popularity of Run Proved

During the first winter of its operation, the Mt Van Hoevenberg run was open from Christmas Day to the first of the following March. In that period 1,974 different persons rode the run, and 4,680 individual rides were taken.

The great slide has proved as popular with visitors in summer as with riders in winter. All during the summer of 1931 a corps of trained guides was on duty constantly at the run to take visitors up and down the course and to explain the many interesting details of construction and operation. Records were kept from June 22 to September 30, 1931. During that time, 8,453 people visited the run. They came in 2,596 automobiles from 33 states and 20 foreign countries.

Statistics for the winter of 1931-32, the Olympic winter, show that 1,715 different persons rode the run and 7,640 individual rides were taken. Because of weather conditions and the number of Olympic contestants using the run for practice purposes it was not open to the public for as many days as it would be in the ordinary winter season.

On May 15, 1932, following the III Olympic Winter Games, maintenance and operation of the run were taken over by the

<p>WAIVER Mt Van Hoevenberg Olympic Bob-run New York State Olympic Winter Games Commission III Olympic Winter Games Committee LAKE PLACID, N Y</p> <p>Town of North Elba County of Essex, State of New York:</p> <p>In consideration of permission granted by New York State Olympic Winter Games Commission to use the bob-sled run upon Mt Van Hoevenberg in the Town of North Elba, County of Essex, State of New York, constructed by the Commission under authority of Chapter 677 of the laws of the State of New York for the year 1930 and Chapter 21, Part 3, of the laws of 1931, I do hereby represent to the Commission:</p> <p>(a) That I know the risks inherent in such use; (b) That I fully and freely assume any injury or damage which may result to me from such use.</p> <p>I do further waive any claim for damages which I may or might have by reason of injuries sustained by me in such use, and do hereby release and discharge the State of New York, the Commission and the members thereof from any claim for damages against them or any of them which I may or might have by reason of injuries sustained in the use of the bob-sled run, except such as may or might arise from the negligence of the State of New York and/or the Commission, their agents, servants and employees.</p> <p>I do further agree to keep one of the duplicate originals of this waiver and release and to have the same in my possession whenever I am using the bob-sled run and to exhibit the same upon request to any duly authorized employee or agent of the Commission.</p> <p>IN WITNESS WHEREOF I HAVE HEREUNTO SET MY HAND AND SEAL IN DUPLICATE THIS..... DAY OF..... 19.... (L. S.) No 2229 Witness</p>

Waiver signed by riders at Olympic bob-run

New York State Conservation Department. The run will be kept open winters for public riding, and several championship races will be held each year. During the summer, experienst guides will be on duty to explain to visitors how the run was built and how it is operated.

From the experience of two winters it can definitely be prophesied that the Mt Van Hoevenberg Olympic bob-run will prove to be one of the most popular of New York state's recreational attractions.

In 1931 two racing championships were held on the Mt Van Hoevenberg slide, the North American and A A U National championships on February 6 and 7, and the Lake Placid A C Novice Bobsleigh meet on February 23 (from Shady Corner). 16 teams competed in the North American races, and 14 in the Novice meet. It is interesting to

note that a team composed entirely of girls finisht fifth in the latter competition. The following winter the Novice meet, with contestants racing from Shady Corner, was held on February 21. 23 teams participated and a girls' team took second-place honors. The Adirondack A A U Junior Bobsleigh championships were staged on March 2 (racing from Whiteface Curve). 14 teams entered and a girls' crew placed seventh. No accidents occurred during any of these races, proving again the technical soundness of the run's construction, since in all the meets, except the North American championships in 1931, the drivers were practically without racing experience.

The appetite of the people for bobsled riding and for bobsled racing has been keenly whetted by the III Olympic Winter Games. That appetite will increase annually.



—*International Newsreel*

Roumanian team rounding Shady Corner: Lieut Al Papana, driver, Capt Al Ionescu, Lieut Ulysse Petrescu, Capt Dumitru Hubert, brakesman



—*International Newsreel*
United States team No 1, winner of Olympic Q-man bob crown. William L Fiske, driver, Edward F Eagan, Clifford B Gray, and Jay O'Brien, brakesman



—Roger L. Moore
United States bobsled team No 2, second-place winner in 4-man race. *Left to right:* Edmund C Horton, brakesman, F Paul Stevens, Percy D Bryant, and Henry A Homburger, driver

III Olympic Winter Games

Summary of All Sports

The pages that immediately follow contain a detailed report of the III Olympic Winter Games, held at Lake Placid, New York, U S A, February 4 to 13, 1932.

After the description of the opening ceremony, including the traditional "March Past," the reader will find a brief account of each sports competition on the program, lists of entries and officials, and complete summaries of each event.

Every event on the program was held on the day scheduled with the following exceptions, the shifts being necessary on account of unsatisfactory weather conditions: 2-man bob racing, originally scheduled for Feb 8 and 9, was held on Feb 9 and 10; 4-man bob racing, originally scheduled for Feb 11 and 12, was held on Feb 14 and 15. Preliminary heats of the 10,000-meter speed-skating race were re-skated on Feb 6, in accordance with a ruling of the technical committee, and the final was skated on Feb 8.

The formal closing ceremonies, including final distribution of prizes, were held in the stadium, in accordance with the official program, on the afternoon of Feb. 13, following the final hockey game between Canada and the United States, which had been transferred to the arena.

The extension of two days to Feb 15 to permit the completion of the bob-sleigh races was granted by Count de Baillet-Latour, president of the International Olympic Committee.

The Opening Day

At ten o'clock on the morning of February 4, 1932, the goal of four years of unremitting effort was reached as the athletes representing 17 nations began the program of competition in the official Olympic winter sports: Skiing, Speed-skating, Figure-skating, Hockey, and Bobsledding; and the three demonstrations, Sled-dog racing, Curling, and Women's Speed-skating.

Everything was in readiness early, and even the weather, which had been anything but favorable during the period immediately preceding the Games, seemingly decided that it too should help, and the morning of the opening day dawned bright and cold.

Lake Placid was in gala attire as befitted its position as host to the pickt winter-sports stars of the world and the thousands gathered to see them in action. The flags of the nations flew everywhere. Great hotels and clubs, cottages, private homes, and business

houses, were brave with bunting. Adirondack greens and pillars and arches of clear, green ice lined the main streets.

Every Olympic facility was ready and waiting to do its part in the long-lookt-for program-the stadium, the indoor arena, the ski jump, the Mt Van Hoevenberg bob-run, and even the forest ski trails.

The athletes, most of whom had travelled thousands of miles for these tests of their skill against the best in the world, eagerly waited for the opening gun.

There was a tenseness in the air as of something impending. Even before daylight, trains, automobiles, buses, and airplanes began disgorging great crowds of passengers. Officials rusht from office to stadium and back, busy with last-minute arrangements. Every final detail. was checkt and re-checkt. And the III Olympic Winter Games of 1932 were ready to open.

The Opening Ceremony

By tradition the opening ceremonies of the Olympic Winter Games are the most impressive on the entire program. The Organizing Committee was determined to leave no stone unturned to make the opening of the Lake Placid Games the most distinctive in the history of these international competitions.

As is customary, the ceremony was held in the Olympic stadium. Overhead the brilliant Adirondack winter sun shone on a vast expanse of steel-blue ice. Freshly flooded the night before, the 400-meter skating track showed neither scratch nor blemish. On the west side of the stadium stood the grandstand and several bleacher sections. Additional bleachers and standing-room for thousands more were along the northern curve and the eastern margin of the track. In their rear were the three towering flagpoles, on which would fly at the proper times the flags of the nations winning the first three places in any event. The shell for the band stood at the end of the eastern row of bleachers next to the main entrance gate.

Within the oval of the track two hockey boxes were laid out. At the north end of these boxes rose the pole, from whose top the Olympic banner would be unfurled. The flags of the 17 competing nations flew from staffs encircling the stadium.

Loud-speakers of the public-address system were so arranged that every person in the stadium could hear clearly every announcement.

Shortly before ten o'clock the musicians marched to the bandstand. Motion-picture operators, "still" cameramen, and radio announcers were in their places. The press-box was filled with writers from every corner of the globe. Attendants were on the alert. The competing athletes were grouped just outside the main entrance to the stadium. The opening ceremony was about to begin.

Governor Meets Officials

Promptly at ten o'clock members of the International Olympic Committee and the Organizing Committee were presented to Governor Franklin D. Roosevelt of New York

state outside the stadium, between the grandstand and the high-school building.

Then Governor Roosevelt, escorted by Count de Baillet-Latour, president of the International Olympic Committee, members of the International Olympic Committee, and Dr. Godfrey Dewey, president, and members of the III Olympic Winter Games Committee, proceeded to his box in the reviewing stand.

Occupying seats of honor with the governor were the following members of the International Olympic Committee: Count de Baillet-Latour, president, Belgium; General Charles H. Sherrill, U. S. A.; Sir Thomas Fearnley, Norway; Count Clarence de Rosen, Sweden; and William M. Garland, U. S. A.

Also Avery Brundage, president of the American Olympic Association, Chicago; Dr. Godfrey Dewey, president III O. W. G. Committee, Lake Placid; Henry Morgenthau, Jr., state conservation commissioner, Albany; and Guernsey Cross, secretary to Governor Roosevelt, Albany.

Also Mrs. Roosevelt, Lady Fearnley, Mrs. Brundage, Mrs. Dewey, and Mrs. Morgenthau.

While the entire assemblage rose and stood with uncovered heads, the band played "The Star Spangled Banner."

As the strains of the American national anthem faded away to the encircling mountains, the parade of the athletes began. They came in by the main entrance at the eastern side of the stadium track and marched up the back stretch and around past the front of the grandstand, where sat Governor Roosevelt and the other officials.

The teams marched by nations in alphabetic order as follows:

Austria, Belgium, Canada, Czechoslovakia, Finland, France, Germany, Great Britain, Hungary, Italy, Japan, Norway, Poland, Roumania, Sweden, Switzerland, and the United States.

Each nation's flag was carried in front of the delegation by a representative, marching alone. Preceding the standard-bearer, marched a boy scout with a placard held aloft indicating the name of the national delegation. In passing, the flags were dipped in salute to the governor.



—Associated Press

Workmen putting the finishing touches on Zig-zag turn, Mt Van Hoevenberg Olympic bobsled run





—Pierson Studio

Austrian 2-man bob team: Hugo Weinstengel, driver, and Count Gudenus, brakesman, speeding into the straight-away after leaving Shady Corner



—*International Newsreel*

United States team No 1, Olympic 4-man title-holder, takes Shady Corner. Members of the team: William L Fiske, driver, Edward F Eagan, Clifford B Gray, and Jay O'Brien, brakesman



—*Stedman*

Swiss 2-man team rounding Whiteface curve: Reto Capadrutt, driver; Oscar Geier, brakesman. This team took second place in the Olympic bob test



Austria

—Stedman



Belgium

—Roger L. Moore



Canada's stalwarts salute Governor Roosevelt in opening ceremony

—G. Cleveland



Czechoslovakia

—Roger L Moore



Finland

—Stedman



French team passing reviewing stand in opening ceremony

—G Cleveland



Germany

—Stedman



Great Britain. The first time in Olympic history that flag in opening ceremony was carried by a woman

—G Cleveland



Hungary

—Stedman



Italy

—Stedman



Japan

—Roger L. Moore



The Norwegian team passes the reviewing stand

—G. Cleveland



Poland

—Stedman



Roumania

—Stedman



Sweden

—Roger L. Moore



Switzerland

—Stedman



—International Newsreel

The United States team passes the reviewing stand in the colorful opening ceremonies of the III Olympic Winter Games

Parading with military precision, the stride of many of the athletes showing that in other years they had marched in the uniforms of their countries to strains more martial than those at the Olympic stadium, the different contingents swung past the reviewing stand and around into the hockey box facing the tribunal of honor.

It was the most impressive sight of the Games. The brilliant sun; the multi-colored uniforms, ranging from the somber blue of the Norwegians and the Japanese to the white of the Americans; the hum of an airplane overhead; the sparkling, blue ice; and the cloudless sky above—all combined to produce

a picture of Winter and his sons and daughters that those privileged to see it will remember always.

Governor is Introduced

The "March Past" ended, picked delegates from each nation formed on the track directly in front of the governor's box bearing the flags of their countries. Dr Godfrey Dewey then introduced Governor Franklin D Roosevelt in these words:

"Four years ago Lake Placid was studying the II Olympic Winter Games at St Moritz.

"Three years ago Lake Placid was organizing the necessary co-operation of state and county with

town and village and with the whole Adirondack region to secure the award of the III Olympic Winter Games.

“Since the award of the Games to Lake Placid by the International Olympic Committee in April, 1929, this indispensable co-operation has been splendidly manifested in the face of the most difficult conditions, both national and international in the whole history of the modern Olympic Games. Today Lake Placid in the Adirondacks in New York state stands ready as a worthy host to the most distinguisht winter sportsmen of the whole world.

“The Olympic Stadium in which we are assembled offers a perfect 400-meter speed-skating track as well as hockey boxes and other facilities. The Olympic ski hill provides ideal conditions for jumps of any distance up to 60 meters. Hundreds of kilometers of new ski trails wind up and down thru the surrounding forests. The Olympic bob-run on Mt Van Hoevenberg is the first championship run on the North American continent and the peer of any in the world. Finally, the splendid new Olympic Arena at Lake Placid, added to the complete equipment of outdoor facilities already provided, meets the challenge of uncertain weather conditions as never before.

“All is in readiness for the supreme athletic event of the winter sports world.

“I have the honor to call on His Excellency, Franklin D Roosevelt, Governor of the State of New York, to welcome the representatives of the winter sports nations here assembled and officially to proclaim open the III Olympic Winter Games of Lake Placid.

“Governor Roosevelt.”

Governor Declares Games Open

Governor Roosevelt replied as follows:

“On behalf of the State of New York and because these Games are being held in this state, and on behalf of the United States, I welcome you, the representatives of many of our sister nations to this, the opening of the III Olympic Winter Games.

“It is an evidence of the age of our modern civilization that the Olympics date back nearly 2800 years, and altho in those early days they did not have the Winter Games, we in these later days, thru the Winter Games, are trying to carry out the ideals of sport that were instituted in the Olympiads.



Sven Eriksson, Sweden

—Roger L. Moore



—Acme Photo

Welcome to the III Olympic Winter Games. Dr Godfrey Dewey (right), president of Organizing Committee, greets Count de Baillet-Latour, president of International Olympic Committee

“Thruout the history of these Games, athletes have come to participate in them, seeking no recognition other than the honor received in a simple medal. But that medal has come to typify the very best athlete in all nations in honor as well as in health.

“I wish in these later days that the Olympic ideals of 2800 years ago could have been carried out in one further part.

“In those days it was the custom every 4 years, no matter what war was in progress, to cease all obligations of armies during the period of the Games. Can those early Olympic ideals be revived thruout all the world so that we can contribute in a larger measure?

“And so we are glad to welcome to this nation, our sister nations, as guests of the American people and of the State of New York, and I proclaim open the III Olympic Winter Games, celebrating the Xth Olympiad of the modern era.”

Then to the strains of bugles and the cannon’s salute, the great, white Olympic flag, with its five rings symbolizing the five continents joined together in the amity of inter-

national sports competitions, was slowly hoisted to the top of the flagstaff.

Jack Shea, United States speed-skater and a native of Lake Placid, had been selected to take the Olympic oath of amateurism. Stepping in front of the massed flags accompanied by the United States standard-bearer, William Fiske, Shea raised his right hand and repeated the oath below, all the athletes raising their right hands in token of assent:

“We swear that we will take part in the Olympic Games in loyal competition, respecting the regulations which govern them and desirous of participating in them in the true spirit of sportsmanship for the honor of our country and for the glory of sport.”

The entire opening ceremony occupied a little more than half an hour. Following a short intermission, the skaters drawn for the first heat of the 500-meter speed-skating races were called to the starting line, the gun was fired, and the first competition on the III O W G program was under way.

Official Competitions

Skiing

Large and representative entry lists and excellent competition among the best ski-runners and ski-jumpers in the world marked the ski sports at the III Olympic Winter Games of 1932 at Lake Placid. In accordance with Olympic rules and under the rules of the International Ski Federation (F I S) there were four events on the program: 18-kilometer race; 50-kilometer race; combined event (18-km race and jumping); and jumping.

The most extraordinary winter conditions in the history of the United States weather bureau wrought many hardships on both officials and contestants, not to speak of those whose duty it was to see that all facilities, trails and jumps, were in readiness for the Olympic program. Unselfish co-operation and hard work on the part of all these groups, however, made it possible to run off each of the four events on the day scheduled, and, except for the 50-kilometer race, the start of which was delayed for two hours, at the time originally planned.

Lack of sufficient snow and high temperatures running up to 45 degrees above zero Fahrenheit hindered both officials and contestants, but the jumpers, with plenty of snow on Intervales hill, were not handicapped at all and made excellent records in both jumping events.

Lake Placid's years of experience in staging both cross-country races and major jumping competitions stood it in good stead in meeting these disheartening conditions and made it possible for the entire program to be carried out.

The courses for the two cross-country ski races (18-km and 50-km) were chosen by officials of the International Ski Federation from Lake Placid's 250 miles of trails.

The night before each race, contestants were given maps showing the official course to be followed the next day. In this way the skiers, under the rules of the International Ski Federation, had no opportunity to practice on the exact course chosen for the race.

The skiing competitions extended over a

period of four days: the 18-km race on Feb 10; combined jump on Feb 11; the jump on Feb 12; and the 50-km race on Feb 13.

18-km Ski Race

The course selected by the Olympic ground jury, from among four submitted for the 18-km race, is known as the "Mt Whitney" route. It has a total climb of 500 meters, and the exact length is 18.214 kilometers. The highest climb started at the 11-kilometer mark, and the long descent terminated at a distance of 14.5 kilometers.

Start and finish of the 18-km race were inside the main entrance gate at the Olympic stadium. (See map of 18-km course and section of this book entitled "Cross-Country Ski Trails" for further information about the course.)

Since the course at no time was near any dwelling-house it was necessary to establish a field telephone at the point known as "Main Trail Junction." The contestants past twice near here, first at a distance of 6.267 kilometers and secondly at a distance of 11.674 kilometers from the start. Times of racers, as they past, were reported by telephone to the bulletin board in the stadium and to the main press headquarters in the high school.

The New York State Conservation Department co-operated by having its forest ranger in this section and a corps of assistants condition the course for the race.

Three types of competitors were entered in the 18-km race: those entered in that race alone; those entered in the combined event; and those entered in both the 18-km race and the combined event. A total of 61 competitors, including all three classes, started in the 18-km race. The snow on the course the day of the race may properly be described as "slow."

For the benefit of contestants there was placed in a conspicuous spot at every second kilometer a 16-inch yellow sign, on which was printed in black the distance traversed to that point.



—International Newsreel

Sven Utterström of Sweden, winner of the 18-kilometer ski race, crossing the finish line in one hour, 23 minutes, seven seconds

50-km Ski Race

Five courses for the 50-kilometer race were submitted to the ground jury of the FIS. The total rises in these courses ranged from 1375 meters to 1800 meters. Eventually the course known as the “Clifford Falls” route was selected for the Olympic competition.

Lack of sufficient snow was the main problem confronting the officials, altho a fall early in February seemed to indicate that conditions would be right on the day of the race, Feb 13. Immediately following the decision of the ground jury as to the course to be used, a crew of workmen began putting the Clifford Falls trail in shape for racing.

Start and finish of this race were to be at Olympic stadium.

At every 5-km distance a sign was placed in a conspicuous spot indicating the distance

covered to that point. (See map for details of 50-km course.)

The main feeding-station was to be at Ski T, near Intervales ski-jump, at a distance of 31.811 kilometers, while auxiliary feeding-stations were placed at distances of 18.2 and 41.283 kilometers. Telephone connections were to be arranged at the three feeding-stations so that intermediate times could be telephoned to the Olympic stadium scoreboard and to the main press-room in the high school.

On orders from the F I S the following supplies were to be at the three feeding-stations:

First Station, between 20 and 25 Kilometers

Oatmeal gruel
Oranges
Water
Lemons

*Second (Main) Feeding-station, between 30
and 35 Kilometers*

24 lemons
6 loaves rye bread
20 quarts warm milk
20 quarts oatmeal gruel
40 oranges
8 doz raw eggs
20 quarts tea, without sugar
10 quarts warm bouillon
16 ripe bananas
5 lbs beefsteak, cold
Water, not too cold
2 lbs lump sugar

Third Station, between 40 and 45 Kilometers

Oatmeal gruel
Oranges
Water
Lemons

Finish

Warm milk to be served in dressing-
room

Feb 11, two days before the start of the race, a thaw set in. No great concern was felt by officials, however, at this since under ordinary February conditions in Lake Placid a thaw lasts for only a few hours or a day at most, the temperature remaining around freezing.

But during the Olympic winter at Lake Placid all ordinary weather prognostications had to be thrown into the discard. Nothing could be projected on a basis of past experience. Friday, the day before the race, it was still warmer, the temperature rising from 35 (Fahrenheit) in the morning to 47 in the afternoon. Careful investigation of the 50-km trail showed that a drastic change would have to be made in the course or else the race would have to be postponed.

After going over the route, George W Martin, chief of course, felt that, despite the thaw, a section of the course, as originally planned, could be utilized by running a loop of 23.777 kilometers twice, with an extension to the finish, making the total distance 48.239 kilometers. This recommendation was accepted by the jury of terrain as the best solu-

tion to the problem. The course furnisht an excellent test of skiing skill.

The loop was part of the originally-selected 50-kilometer course and extended from the AuSable river thru the North Notch trail (See map) to Clifford Falls, returning by way of South Notch trail. The start was at the junction of South Notch trail and the River road, where the main feeding-station was also located. The auxiliary feeding-station was maintained at Keene Valley as originally planned. After running the loop twice, contestants continued along the River road to the finish.

The 50-km race started at 11 o'clock on the morning of Feb 13. The trail itself was covered with snow sufficient for ski-running, but in many places the snow-covered section was very narrow. By the time the racers were off, mercury began to drop rapidly to a point well below freezing so that no more snow was lost that day. Racers, for the most part, found the skiing conditions good and turned in excellent times for this gruelling grind, otten called the greatest test of skill and stamina in the entire field of sport, either summer or winter.

Patrols left Lake Placid before daylight on the morning of the race and took charge of the course on both sides of the Sentinel range. Men were placed as posts at certain spots to watch and be responsible for sections of the race course. Two first-aid men followed the last racer over the course, checking up on possible accidents and informing the posts and controls that the last man had past.

Combined Event—Jump

North American winter-sports enthusiasts have always been particularly keen about ski-jumping, and the forecasts of the Organizing Committee were found to be accurate, since two of the largest crowds of the entire Olympic period attended the jump of the combined event on Feb 11 and the jumping event on the following day.

Several days prior to Feb 11 were devoted to putting Intervales hill in perfect condition for the Olympic tests. During that part of the early training period when the great slide

was not in use jumpers practised on the 30-meter hill by the Olympic stadium in the village. Early February weather was not any too favorable for conditioning the hill, but little difficulty was experienced in getting it ready.

At eight o'clock on the morning of Feb 11 the thermometer stood at 35, and by noon it had risen even above that figure, but before the jumping competition was half over that afternoon, it dropped rapidly to below freezing, and the hill was very fast.

Promptly at 2:15 the jump opened as scheduled. The competition consisted of two regular jumps for each man without a trial leap. Several skiers not entered in the combined jump went down the slide to get it in just the right condition for those taking part in the meet.

Jumpers started from the top platform. The competition was completed by 3:45.

Jump

Intervalles hill was lightning-fast for the ski-jumping competition on Feb 12, which was attended by one of the two largest crowds of the Games, and taken part in by the ranking ski-jumpers of the world.

While it was even warmer in the morning than on the preceding day—the thermometer stood at 44 degrees at eight o'clock—the experiences of Feb 11 were repeated, and by mid-afternoon the mercury was down to freezing. The out-run of the lower hill was slushy in many places when the jumping began, but the upper slide and the landing-hill were not materially affected, since Intervalles faces northeast, and the afternoon sun in winter does not strike the slide directly.

The day was clear. This helped to bring out the record throng of ski-jumping enthusiasts, the largest crowd ever assembled at Intervalles. Ample parking-space for automobiles had been provided on the flat to the northwest of the main entrance. Police supervision was excellent, and the huge throng was handled with a minimum of difficulty. Seating arrangements were such (See ski-jump section of this book) that every one, whether

in grand-stand, bleacher, or standing-room section had a good view of the jumpers as they soared out into space from the take-off.

So fast was the upper hill that because of this and the change in the angle and height of the take-off, elsewhere referred to, the judges made the official starting-point about 12 feet below the top, halfway between the intermediate platform and the top of the tower. Even at this, the best official standing jump of the afternoon was 71.5 meters (235 feet), made by Hans Beck of Norway. The former record for the hill was 60.5 meters (198½ feet) made by Roy Mikkelsen of the United States.

There were few falls, and only Yoichi Takata of Japan suffered injuries. Fortunately these were only minor ones.



—Wide World
Rear Admiral Richard E. Byrd, U.S.N. (right), and
Avery Brundage, president of the American
Olympic Committee

Governing Bodies and Officials

International Ski Federation

President—Lieut-Colonel J Holmquist,
Boden, Sweden

National Ski Association of America, Inc

President—Dr R S Elmer, Bellows Falls,
Vt

Technical Delegates

Ingv. Smith-Kielland, Norway
Axe1 Norling, Sweden
Dr Francois Lacq, France

Ground Jury

Ingv. Smith-Kielland, Norway, President
Take Aso, Japan
Fred H Harris, United States
Dr Francois Lacq, France
Axe1 Norling, Sweden
Armas Palmros, Finland

Jury of Appeal

Axe1 Norling, Sweden, President
Dr R S Elmer, United States
Piero Ghiglione, Italy
Ingv. Smith-Kielland, Norway

Officials

Director-in-chief

Dr R S Elmer, United States

Tournament Director

George W Martin, United States

Ski-jump Officials

Director

George W Martin, United States

Judges

Combined Jump, Feb 11

Victor Alberts, United States

Olaf Helset, Norway

Karel Jarolimek, Czechoslovakia

Jump, Feb 12

Johan af Klercker, Sweden

Dr Francois Lacq, France

Sigurd Lockeberg, Canada

Chief of Take-off

Charles N Proctor, United States

Chief of Landing-hill

Julius P Blegen, United States

Starter

O Smith Johannsen, United States

Chief Measurer

Fred H Harris, United States

Measurers

Charles J Beck, United States

Takeo Hoshino, Japan

Louis Grimes, Canada



Feeding station at the half-way mark, 50-kilometer ski race

—Acme Photo

H Smith Johannsen, Canada
 Herman Kaier, Norway
 Norbert Lang, Czechoslovakia
 Sven Lindhagen, Sweden
 C Matheson, Norway
 Albert Mayer, Switzerland
 German Raab, Germany
 Guido Rivetti, Italy
 Jan Woyniewicz, Poland

Officials for 50-km and 18-km Ski Races

Director
 Dr R S Elmer, United States
 Chief of Course
 George W Martin, United States
 Starter
 Major Philip B Fleming, United States
 Timers
 Charles A Proctor, United States
 Elwood Kerr, United States
 Henry Stetson, United States
 Judges
 H Smith Johannsen, Canada
 Julius P Blegen, United States
 Johan af Klercker, Sweden

Events and Rules

Dates of contests:
 18-kilometer race.....Feb 10
 Combined event—jump.....Feb 11
 Jump.....Feb 12
 50-kilometer race.....Feb 13

Maximum number of entries: 8 per nation in each event.

Maximum number of contestants: 4 per nation in each event.

Rules of the International Ski Federation covering jumping require each contestant to make two jumps, the total score of which decides the winner. The contestant is judged both on distance and on form, each counting approximately 50 per cent.

Actual elapsed time made by each contestant determines place position in the cross-country competitions. The men are started at one-minute intervals and are required to follow the exact course as flagged. Scoring for the combined event is according to an elaborate table. (See page 195.)

Drawings

Drawings for the four ski events were made in the presence of the technical delegates by the representatives of the countries taking part. Drawings for the 18-kilometer race and the combined event were made on Feb 7. Drawings for the 50-kilometer race and the jump were made on Feb 9.



—Roger L Moore

Reidar Andersen, Norway, gets in some stiff practice



Members of the Swedish Olympic team training for the Games. *Left to right:* Erik Rylander, Hjert Schön, and Sven Eriksson

—Wide World

18-km SKI RACE

Entries including reserves

Number of nations entered..... 11
 Number of individuals entered..... 64
 Number of Contestants..... 42

Austria

Bosio, Harald
 Höll, Gregor
 Paumgarten, Harald

Canada

Clark, William G
 Currie, John F
 Heggveit, Halver L
 Oliver, Byron A
 Pangman, Arthur H
 Taylor, John P

Czechoslovakia

Barton, Antonin
 Cifka, Jan
 Feistauer, Jaroslav
 Novák, Vladimír
 Simunek, Frantisek

Finland

Lappalainen, Martti
 Lappalainen, Tauno
 Liikkanen, Väinö
 Penttilä, Erkki
 Saarinen, Veli
 Toikka, Valmari

France

Berthet, Raymond
 Cretin, Leonce
 Mugnier, Paul
 Secretan, Albert

Italy

Colturi, Lorenzo
 Menardi, Severino
 Solda, Gino
 Veurich, Andrea

Japan

Ageishi, Iwao
 Hoshina, Takeo
 Iwasaki, Saburo
 Kuriyagawa, Heigoro
 Taniguchi, Kinzo
 Tsubokawa, Takemitsu
 Yamada, Katsumi

Norway

Gröttumsbraaten, Johan
 Hegge, Ole
 Hovde, Kristian
 Rustadstuen, Arne
 Saetre, Magnus
 Sevre, Kolbjörn

Stenen, Ole
 Vestad, Sigurd

Poland

Czech, Bronislaw
 Marusarz, Andrzej
 Marusarz, Stanislaw
 Motyka, Zdzislaw
 Skupien, Stanislaw

Sweden

Aström, Sven
 Jonsson, Karl G
 Lindberg, Karl J
 Lindgren, John H
 Mattsson, Sivert
 Svärd, Nils E
 Utterström, Sven L
 Vikström, Axel T

United States

Andersen, Erling N
 Backstrom, Nils
 Billings, Norton R
 Blood, Edward J
 Monsen, Rolf
 Parsons, Richard E
 Reid, Robert H
 Zetterstrom, Olle

18-km RACE (11.18 Miles)

Morning, Feb 10, 9:30

Results

Contestants started at one-minute intervals.

	hrs	mins	secs
1 Utterström, Sweden.....	1	23	07
2 Vikström, Sweden.....	1	25	07
3 Saarinen, Finland.....	1	25	24
4 Lappalainen, M, Finland .	1	26	31
5 Rustadstuen, Norway.....	1	27	06
6 *Grøttumsbraaten, Norway .	1	27	15
7 Toikka, Finland.....	1	27	51
8 *Stenen, Norway.....	1	28	05
9 Liikkanen, Finland.....	1	28	30
10 Svård, Sweden.....	1	29	05
11 Mattsson, Sweden.....	1	29	54
12 *Kuriyagawa, Japan.....	1	31	34
13 Hovde, Norway.....	1	32	48
14 Novák, Czechoslovakia.....	1	32	59
15 *Tsubokawa, Japan.....	1	33	15
16 *Barton, Czechoslovakia.....	1	33	39
17 Hoshina, Japan.....	1	35	47
18 *Czech, Poland.....	1	36	37
19 Cretin, France.....	1	36	42
20 *Feistauer, Czechoslovakia.	1	37	55
21 *Bosio, Austria.....	1	38	23
22 *Cifka, Czechoslovakia.....	1	38	24
23 Zetterstrom, United States	1	38	26
24 Secretan, France.....	1	38	39
25 Veurich, Italy.....	1	38	42
26 Solda, Italy.....	1	39	43
27 *Marusarz, S, Poland.....	1	39	56
28 Parsons, United States.....	1	40	08
29 *Paumgarten, Austria.....	1	41	20
30 Mugnier, France.....	1	41	34
31 Skupien, Poland.....	1	41	48
32 Motyka, Poland.....	1	41	58
33 *Monsen, United States.....	1	42	36
34 *Menardi, Italy.....	1	43	04
35 Pangman, Canada.....	1	43	12
36 Berthet, France.....	1	43	38
37 Iwasaki, Japan.....	1	44	07
38 Clark, Canada.....	1	46	33
39 Taylor, Canada.....	1	48	11
40 Currie, Canada.....	1	49	03
41 *Höll, Austria.....	1	55	18
42 Andersen, United States....	1	58	13



Sven Utterström, Sweden

*Competed in both 18-kilometer race and combined race



—*International Newsreel*

Members of the Czechoslovakian ski team on the trail



—Associated Press

Norton Billings, United States, pauses for refreshment from an icy mountain stream during the course of the 50-kilometer ski race



—Acme Photo

Two of Norway's star ski jumpers: Sigmund Ruud (left) and Birger Ruud, his brother, winner of the Olympic jump



—Lake Placid Club Photo

Olympic ski-hill



Whiteface Mountain

Birger Ruud, 19-year-old Norwegian star, winner of the Olympic ski jump. Ruud's first jump was 66.5 meters (218 feet) ; his second, 69 meters (226 feet)



Johan Grøttumsbraaten, Norway, winner of the combined ski event

—Associated Press

50-km SKI RACE

Entries including reserves

Number of nations entered.....	9
Number of individuals entered	50
Number of contestants.....	32

Canada

Douglas, David H
Engstad, Kaare
Heggteit, Halver L
Pangman, Arthur H
Ryan, Walter

Czechoslovakia

Barton, Antonin
Cifka, Jan
Feistauer, Jaroslav
Novak, Vladimir
Simunek, Frantisek

Finland

Lappalainen, Martti
Lappalainen, Tauno
Liikkanen, Väinö
Penttilä, Erkki
Saarinen, Veli
Toikka, Valmari

Italy

Colturi, Lorenzo
Delago, Giovanni
De Zulian, Francesco
Sertorelli, Erminio

Japan

Ageishi, Iwao
Iwasaki, Saburo
Kuriyagawa, Heigoro
Taniguchi, Kinzo
Tsubokawa, Takemitsu
Yamada, Katsumi

Norway

Aas-Haugen, Oscar
Hegge, Ole
Hovde, Kristian
Rustadstuen, Arne
Saetre, Magnus
Sevre, Kolbjörn
Stenen, Ole
Vestad, Sigurd

Poland

Motyka, Zdzislaw
Skupien, Stanislaw

Sweden

Aström, Sven
Jonsson, Karl G
Lindberg, Karl J
Lindgren, John H
Mattsson, Sivert
Svård, Nils E
Utterström, Sven L
Vikström, Axe1 T

United States

Backstrom, Nils
Billings, Norton R
Monsen, Rolf
Parsons, Richard E
Reid, Robert H
Zetterstrom, Olle

50-km RACE (31.07 Miles)

Morning, Feb 13, 11:00

Results

Contestants started at one-minute intervals.

	hrs	mins	secs	No time recorded for the following starters:
1 Saarinen, Finland	4	28	00	Billings, United States
2 Liikkanen, Finland.....	4	28	20	Delago, Italy
3 Rustadstuen, Norway.....	4	31	53	De Zulian, Italy
4 Hegge, Norway.....	4	32	04	Douglas, Canada
5 Vestad, Norway.....	4	32	40	Kuriyagawa, Japan
6 Utterström, Sweden.....	4	33	25	Lappalainen, M, Finland
7 Lappalainen, T, Finland...	4	45	02	Mattsson, Sweden
8 Lindgren, Sweden.....	4	47	22	Motyka, Poland
9 Jonsson, Sweden.....	4	49	52	Ryan, Canada
10 Barton, Czechoslovakia....	4	52	24	Skupien, Poland
11 Novák, Czechoslovakia....	4	52	44	Stenen, Norway
12 Sertorelli, Italy.....	4	59	00	Taniguchi, Japan
13 Feistauer, Czechoslovakia..	5	00	19	
14 Cifka, Czechoslovakia.....	5	01	50	
15 Parsons, United States.....	5	13	59	
16 Engstad, Canada	5	19	19	
17 Ageishi, Japan.....	5	19	31	
18 Iwasaki, Japan.....	5	21	40	
19 Backstrom, United States..	5	25	40	
20 Reid, United States.....	5	26	06	



Veli Saarinen
Finland



Winter Shadows

—Pierson Studio.

COMBINED SKI EVENT—18-km RACE AND JUMP

Entries including reserves

Number of nations entered.....	11
Number of individuals entered.....	47
Number of contestants.....	33

Austria

Bosio, Harald
Höll, Gregor
Paumgarten, Harald

Canada

Bagguley, D Howard
Ball, William
Clark, William G
Engstad, Kaare
Gravel, Arthur L
Nordmoe, Jostein
Wilson, Ross F
Wright, Philemon R

Czechoslovakia

Barton, Antonin
Cifka, Jan
Feistauer, Jaroslav
Simunek, Frantisek

France

Berthet, Raymond

Italy

Dallago, Ingenuino
Menardi, Severino
Zardini, Ernesto

Japan

Kuriyagawa, Heigoro
Tsubokawa, Takemitsu
Yamada, Katsumi

Norway

Grøttumsbraaten, Johan
Hovde, Kristian
Kolterud, Sverre
Rustadstuen, Arne
Saetre, Magnus
Saetre, Ottar
Stenen, Ole
Vinjarengen, Hans

Poland

Czech, Bronislaw
Marusarz, Andrzej
Marusarz, Stanislaw

Sweden

Eriksson, Sven
Rylander, Erik
Schön, Hjert

Switzerland

Chiogna, Cesare
Kaufmann, Fritz
Steuri, Fritz

United States

Andersen, Erling N
Blood, Edward J
Ellingson, Lloyd C
Ericksen, John M
Harsh, James
Johansen, Jorgen
Monsen, Rolf
Oimen, Caspar

COMBINED SKI EVENT—18-km

RACE AND JUMP

18-km Race Morning, Feb 10

Jump Afternoon, Feb 11

Results



Johan Grøttumsbraaten, Norway

Analysis of Combined Ski Event

	Feb 10		Feb 11		Points for Jumps	Total Points		
	18-km race Time	Points	1st jump m	2nd jump ft				
1 Grøttumsbraaten, Norway	1:27:15	240	51	167	206	446		
2 Stenen, Norway	1:28:05	235.75	48	157	52	171	200.3	436.05
3 Vinjarengen, Norway	1:32:40	213	54	177	62	203	221.6	434.6
4 Kolterud, Norway	1:34:36	204	57	187	55.5	182	214.7	418.7
5 Eriksson, Sweden	1:39:32	181.5	57.5	189	61.5	202	220.8	402.3
6 Barton, Czechoslovakia	1:33:39	208.5	47.5	156	45.5	149	188.6	397.1
7 Czech, Poland	1:36:37	195	51	167	50	164	197	392
8 Simunek, Czechoslovakia	1:39:58	178.5	50	164	51.5	169	196.8	375.3
9 Monsen, United States	1:42:36	167.4	54	177	52	171	201.9	369.3
10 Nordmoe, Canada	1:42:56	165.96	53	174	52.5	172	201.6	367.56
11 Cifka, Czechoslovakia	1:38:24	186.2	43	141	49	161	181.2	367.4
12 Zardini, Italy	1:43:22	163.5	51	167	51.5	169	198.7	362.2
13 Feistaer, Czechoslovakia	1:37:55	189	46	151	38.5	126	172.6	361.6
14 Blood, United States	1:41:58	170.25	51.5	169	46	151	191.2	361.45
15 Tsubokawa, Japan	1:33:15	210	35.5	116	37	121	148.9	358.9
16 Ellingson, United States	1:44:14	160.5	45	148	56	184	193.7	354.2
17 Dallago, Italy	1:46:29	150	47.5	156	52	171	196	346
18 Paumgarten, Austria,	1:41:20	172.5	38.5	126	45	148	169.7	342.2
19 Marusarz, Poland	1:47:17	147	45	148	50	164	188.1	335.1
20 Kuriyagawa, Japan	1:31:34	219	49.5*	162	50	164	113.8	332.8
21 Menardi, Italy	1:43:04	165	36	118	45.5	149	167.7	332.7
22 Chiogna, Switzerland	1:58:33	102	58	190	59.5	195	219.6	321.6
23 Kaufmann, Switzerland	1:59:20	97.5	59.5	195	60.5	198	223.2	320.7
24 Bagguley, Canada	1:50:35	133.5	51	167	51.5	169	185.2	318.7
25 Ericksen, United States	1:54:58	115.5	49.5	162	54	177	200.8	316.3
26 Steuri, Switzerland	1:54:57	115.5	51	167	51	167	200.4	315.9
27 Marusarz, Poland	1:39:56	179.25	50	164	49 *	161	128.8	308.05
28 Schön, Sweden	1:59:07	99	53.5	175	52	171	201.8	300.8
29 Bosio, Austria	1:38:23	186	49.5*	162	49.5	162	112.7	298.7
30 Gravel, Canada	2:00:18	94.5	50.5	166	51.5	169	184.1	278.6
31 Wilson, Canada	1:43:55	162	40 *	131	36	118	90.8	252.8
32 Yamada, Japan	1:56:03	111	47 *	154	40.5	133	111.2	222.2
33 Höll, Austria	1:55:18	114	55 *	180	57 *	187	71	185

* Indicates fall.

COMBINED EVENT—JUMP

February 11, 1932

Composite of 3 Judges' Score Cards—Points for Jump Only

	Judges:	Victor Alberts (United States)			Olaf Helset (Norway)			Karel Jarolimek (Czechoslovakia)			Total Points of 3 Judges for Jumps
		Points			Points			Points			
		Style	Dis- tance	Total	Style	Dis- tance	Total	Style	Dis- tance	Total	
1 Gröttumsbraaten, Johan <i>Norway</i>	1st jump	18.5	16.9		17.5	16.9		16.5	16.9		206
	2nd jump	17.5	16.6	69.5	18	16.6	69	17.5	16.6	67.5	
2 Stenen, Ole <i>Norway</i>	1st jump	16.5	16		17	16		16.5	16		200.3
	2nd jump	16.5	17.1	66.1	17	17.1	67.1	17.5	17.1	67.1	
3 Vinjarengen, Hans <i>Norway</i>	1st jump	17.5	17.7		17.5	17.7		17.5	17.7		221.6
	2nd jump	18.5	20	73.7	18.5	20	73.7	19	20	74.2	
4 Kolterud, Sverre <i>Norway</i>	1st jump	18	18.6		16.5	18.6		16.5	18.6		214.7
	2nd jump	17	18.1	71.7	18	18.1	71.2	18.5	18.1	71.8	
5 Eriksson, Sven <i>Sweden</i>	1st jump	18	18.7		18	18.7		17	18.7		220.8
	2nd jump	18	19.9	74.6	16.5	19.9	73.1	17.5	19.9	73.1	
6 Barton, Antonin <i>Czechoslovakia</i>	1st jump	16	15.9		15.5	15.9		17	15.9		188.6
	2nd jump	15.5	15.3	62.7	14.5	15.3	61.2	16.5	15.3	64.7	
7 Czech, Bronislaw <i>Poland</i>	1st jump	17	16.9		15.5	16.9		15	16.9		197
	2nd jump	17	16.6	67.5	16.5	16.6	65.5	15.5	16.6	64	
8 Simunek, Frantisek <i>Czechoslovakia</i>	1st jump	16	16.6		15	16.6		16.5	16.6		196.8
	2nd jump	15	17	64.6	16	17	64.6	17.5	17	67.6	
9 Monsen, Rolf <i>United States</i>	1st jump	17	17.7		16.5	17.7		15.5	17.7		201.9
	2nd jump	17	17.1	68.8	16	17.1	67.3	15.5	17.1	65.8	
10 Nordmoe, Jostein <i>Canada</i>	1st jump	17	17.4		16	17.4		15.5	17.4		201.6
	2nd jump	17	17.3	68.7	16	17.3	66.7	16	17.3	66.2	
11 Cifka, Jan <i>Czechoslovakia</i>	1st jump	15.5	14.6		13	14.6		14.5	14.6		181.2
	2nd jump	15.5	16.3	61.9	14.5	16.3	58.4	15.5	16.3	60.9	
12 Zardini, Ernesto <i>Italy</i>	1st jump	16	16.9		16	16.9		16.5	16.9		198.7
	2nd jump	17	17	66.9	16	17	65.9	15.5	17	65.9	
13 Feistauer, Jaroslav <i>Czechoslovakia</i>	1st jump	14	15.4		12.5	15.4		13.5	15.4		172.6
	2nd jump	15.5	13.3	58.2	15.5	13.3	56.7	15.5	13.3	57.7	
14 Blood, Edward <i>United States</i>	1st jump	17	17		16	17		15	17		191.2
	2nd jump	16.5	15.4	65.9	15.5	15.4	63.9	14	15.4	61.4	
15 Tsubokawa, Takemitsu <i>Japan</i>	1st jump	13.5	12.4		12	12.4		10.5	12.4		148.9
	2nd jump	15	12.9	53.8	11	12.9	48.3	11	12.9	46.8	
16 Ellingson, Lloyd <i>United States</i>	1st jump	16.5	15.1		14	15.1		14.5	15.1		193.7
	2nd jump	17	18.3	66.9	15	18.3	62.4	16.5	18.3	64.4	

COMBINED EVENT—JUMP—Continued
February 11, 1932
Composite of 3 Judges' Score Cards—Points for Jump Only

	Judges:	Victor Alberts (United States)			Olaf Helset (Norway)			Karel Jarolimek (Czechoslovakia)			Total Points of 3 Judges for Jumps
		Points			Points			Points			
		Style	Dis- tance	Total	Style	Dis- tance	Total	Style	Dis- tance	Total	
17 Dallago, Ingenuino <i>Italy</i>	1st jump 2nd jump	16.5 17	15.9 17.1		16 16	15.9 17.1		15.5 16	15.9 17.1		196
18 Paumgarten, Harald <i>Austria</i>	1st jump 2nd jump	15.5 14.5	13.3 15.1		13 13.5	13.3 15.1		13 15	13.3 15.1		169.7
19 Marusarz, Andrzej <i>Poland</i>	1st jump 2nd jump	16.5 16.5	15.1 16.6		14.5 15.5	15.1 16.6		15 15	15.1 16.6		188.1
20 Kuriyagawa, Heigoro <i>Japan</i>	1st jump 2nd jump	6 * 14	6 16.6		4 * 11	4 16.6		3.5* 12	3.5 16.6		113.8
21 Menardi, Severino <i>Italy</i>	1st jump 2nd jump	15.5 15.5	12.6 15.3		13.5 13.5	12.6 15.3		12.5 13.5	12.6 15.3		167.7
22 Chiogna, Cesare <i>Switzerland</i>	1st jump 2nd jump	16 18	18.9 19.3		18.5 18	18.9 19.3		17 18.5	18.9 19.3		219.6
23 Kaufmann, Fritz <i>Switzerland</i>	1st jump 2nd jump	17 18	19.3 19.6		18 18	19.3 19.6		17.5 18	19.3 19.6		223.2
24 Bagguley, Howard <i>Canada</i>	1st jump 2nd jump	16 15	16.9 17		13 11	16.9 17		16 12.5	16.9 17		185.2
25 Ericksen, John <i>United States</i>	1st jump 2nd jump	17 17.5	16.4 17.7		16.5 16.5	16.4 17.7		15.5 15.5	16.4 17.7		200.8
26 Steuri, Fritz <i>Switzerland</i>	1st jump 2nd jump	17.5 17	16.9 16.9		16 16.5	16.9 16.9		16 16	16.9 16.9		200.4
27 Marusarz, Stanislaw <i>Poland</i>	1st jump 2nd jump	16.5 8 *	16.6 8		15 4 *	16.6 4		15.5 4 *	16.6 4		128.8
28 Schön, Hjert <i>Sweden</i>	1st jump 2nd jump	16.5 16	17.5 17.1		16 16.5	17.5 17.1		16.5 16.5	17.5 17.1		201.8
29 Bosio, Harald <i>Austria</i>	1st jump 2nd jump	3 * 15.5	5 16.4		2 * 13	2 16.4		3.5* 16	3.5 16.4		112.7
30 Gravel, Arthur <i>Canada</i>	1st jump 2nd jump	15.5 15.5	16.7 17		13 13	16.7 17		12.5 13.5	16.7 17		184.1
31 Wilson, Ross <i>Canada</i>	1st jump 2nd jump	4 * 12	4 12.6		3 * 11	3 12.6		2.5* 11	2.5 12.6		90.8
32 Yamada, Katsumi <i>Japan</i>	1st jump 2nd jump	7 * 15	7 13.9		4 * 13	4 13.9		3.5* 12.5	3.5 13.9		111.2
33 Höll, Gregor <i>Austria</i>	1st jump 2nd jump	7 * 7 *	7 7		5 * 6 *	5 6		5 * 5.5*	5 5.5		71

*Indicates fall.

Order of Finish of Contestants in Combined Event in 18-kilometer Ski Race

	Time	Points		Time	Points
*Grøttumsbraaten	1:27:15	240	*Monsen	1:42:36	167.4
*Stenen	1:28:05	235.75	Nordmoe	1:42:56	165.96
*Kuriyagawa	1:31:34	219	*Menardi	1:43:04	165
Vinjarengen	1:32:40	213	Zardini	1:43:22	163.5
*Tsubokawa	1:33:15	210	Wilson	1:43:55	162
*Barton	1:33:39	208.5	Ellingson	1:44:14	160.5
Kolterud	1:34:36	204	Dallago	1:46:29	150
*Czech	1:36:37	195	Marusarz, A.....	1:47:17	147
*Feistauer	1:37:55	189	Bagguley	1:50:35	133.5
*Bosio	1:38:23	186	Steuri	1:54:57	115.5
*Cifka	1:38:24	186.2	Ericksen	1:54:58	115.5
Eriksson	1:39:32	181.5	*Höll	1:55:18	114
*Marusarz, S.....	1:39:56	179.25	Yamada	1:56:03	111
Simunek	1:39:58	178.5	Chiogna	1:58:33	102
*Paumgarten	1:41:20	172.5	Schön	1:59:07	99
Blood	1:41:58	170.25	Kaufmann	1:59:20	97.5
			Gravel	2:00:18	94.5

* Competed in both 18-kilometer race and combined event.

Order of Rating of Contestants in Combined Event in Jump

	1st Jump (Meters)	2nd Jump (Meters)	Points		1st Jump (Meters)	2nd Jump (Meters)	Points
Kaufmann	59.5	60.5	223.2	Ellingson	45	56	193.7
Vinjarengen	54	62	221.6	Blood	51.5	46	191.2
Eriksson	57.5	61.5	220.8	Barton	47.5	45.5	188.6
Chiogna	58	59.5	219.6	Marusarz, A.....	45	50	188.1
Kolterud	57	55.5	214.7	Bagguley	51	51.5	185.2
Grøttumsbraaten	51	50	206	Gravel	50.5	51.5	184.1
Monsen	54	52	201.9	Cifka	43	49	181.2
Schön	53.5	52	201.8	Feistauer	46	38.5	172.6
Nordmoe	53	52.5	201.6	Paumgarten	38.5	45	169.7
Ericksen	49.5	54	200.8	Menardi	36	45.5	167.7
Steuri	51	51	200.4	Tsubokawa	35.5	37	148.9
Stenen	48	52	200.3	Marusarz, S.....	50	49*	128.8
Zardini	51	51.5	198.7	Kuriyagawa	49.5*	50	113.8
Czech	51	50	197	Bosio	49.5*	49.5	112.7
Simunek	50	51.5	196.8	Yamada	47*	40.5	111.2
Dallago	47.5	52	196	Wilson	40*	36	90.8
				Höll	55*	57*	71

*Indicates fall.

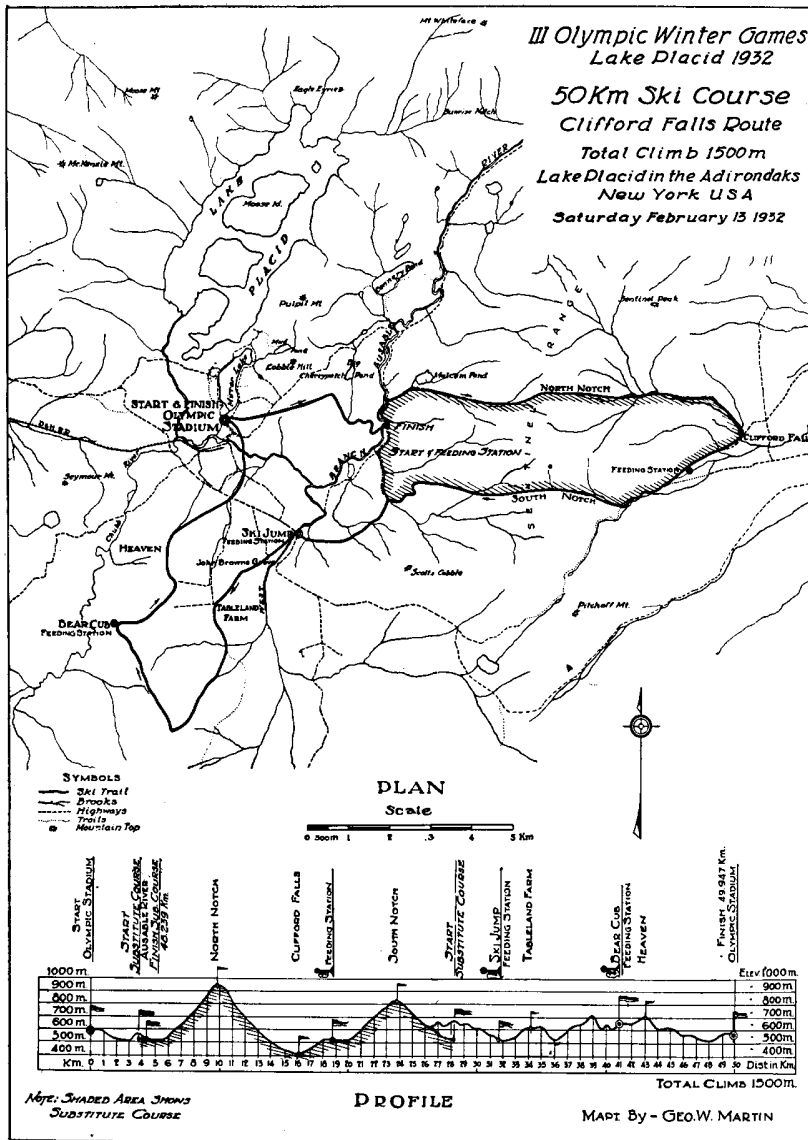

Course for 50-kilometer ski race

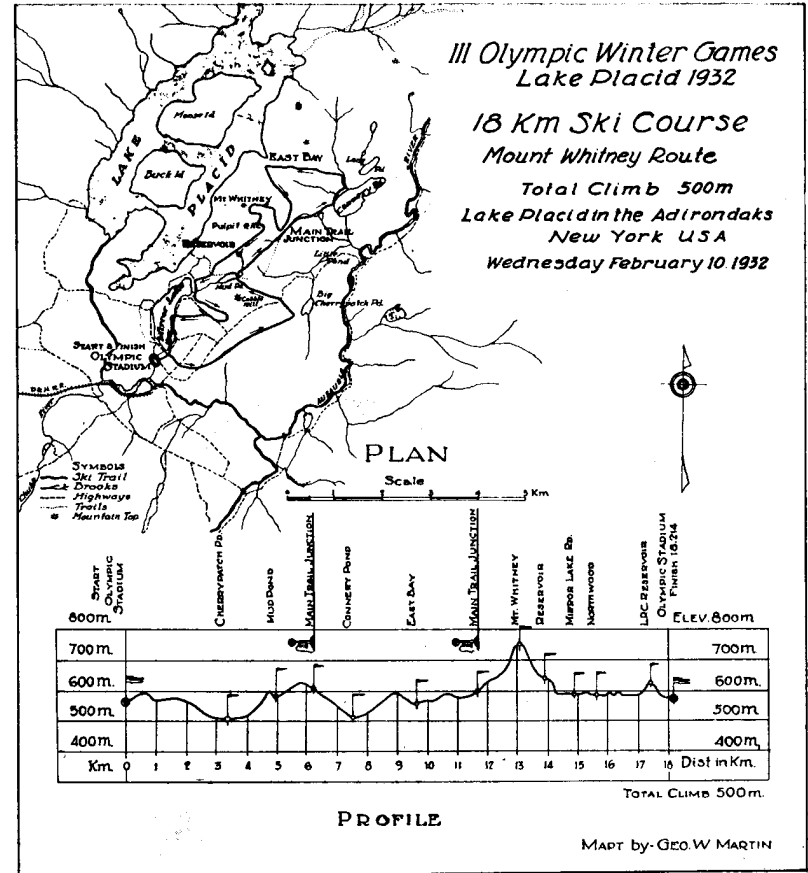

Course for 18-kilometer ski race



—Roger L. Moore

Andrzej Marusarz of Poland riding high

SKI JUMP

Entries including reserves

Number of nations entered.....	10
Number of individuals entered.....	47
Number of contestants.....	34

Austria

Bosio, Harald
Höll, Gregor
Paumgarten, Harald

Canada

Dupuis, Gerald E
Gagne, Leslie R
Hogan, Joséph E
Lafleur, Lucien
Landry, Jacques B
Lymburne, Robert S
Stone, Arnold V
Tache, Jacques R

Czechoslovakia

Barton, Antonin
Cifka, Jan
Feistauer, Jaroslav
Simunek, Frantisek

Italy

Dallago, Ingenuino
Menardi, Severino
Zardini, Ernesto

Japan

Adachi, Goro
Makita, Mitsutake
Takata, Yoichi
Yamada, Katsumi

Norway

Andersen, Reidar
Beck, Hans
Kleppen, Hans
Kolterud, Sverre
Ruud, Birger
Ruud, Sigmund
Vinjarengen, Hans
Wahlberg, Kaare

Poland

Czech, Bronislaw
Marusarz, Andrzej
Marusarz, Stanislaw

Sweden

Eriksson, Sven
Rylander, Erik
Schön, Hjert

Switzerland

Chiogna, Cesare
Kaufmann, Fritz
Steuri, Fritz

United States

Andersen, Erling N
Batson, Lemoine
Falstad, Pedar
Holmstrom, Carl
Mikkelsen, Roy
Monsen, Rolf
Oimen, Caspar
Steele, John D

SKI JUMP

Afternoon, Feb 12

Results



Birger Ruud, Norway

			1st jump		2nd jump		Points
			mtr	feet	mtr	feet	
1	Ruud, B	Norway	66.5	218	69	226	228.1
2	Beck	Norway	71.5	235	63.5	208	227
3	Wahlberg	Norway	62.5	205	64	210	219.5
4	Eriksson	Sweden	65.5	215	64	210	218.9
5	Oimen	United States	63	207	67.5	221	216.7
6	Kaufmann	Switzerland	63.5	208	65.5	215	215.8
7	Ruud, S	Norway	63	207	62.5	205	215.1
8	Adachi	Japan	60	197	66	216	210.7
9	Chiogna	Switzerland	60	197	63	207	209.8
10	Rylander	Sweden	58	190	58.5	192	206
11	Schön	Sweden	57	187	61.5	202	201.8
12	Czech	Poland	56	184	60	197	200.7
13	Falstad	United States	56	184	62.5	205	199.5
14	Zardini	Italy	53	174	65	213	196.7
15	Steele	United States	55	180	56	184	195.6
16	Dallago	Italy	58.5	192	53	174	194.9
17	Marusarz, S	Poland	55	180	53	174	192.5
18	Steuri	Switzerland	58	190	53.5	175	192.4
19	Lymburne	Canada	58	190	51	167	192.1
20	Landry	Canada	52.5	172	54	177	187.3
21	Barton	Czechoslovakia	47	154	58	190	186.1
22	Marusarz, A	Poland	51.5	169	54	177	185.9
23	Simunek	Czechoslovakia	48	157	55.5	182	183.2
24	Cifka	Czechoslovakia	47	154	51	167	172.5
25	Paumgarten	Austria	42.5	139	46.5	153	163.4
26	Feistauer	Czechoslovakia	47	154	41	134	163
27	Menardi	Italy	36.5	120	56.5	185	161.6
28	Makita	Japan	59	194	59.5*	195	134.2
29	Stone	Canada	61.5*	202	49	161	114.5
30	Gagne	Canada	45	148	44.5*	146	110.5
31	Takata	Japan	37.5	123	57 *	187	91.1
32	Yamada	Japan	57 *	187	51.5*	169	70
33	Mikkelsen	United States	68 *	223	did not jump		52
34	Bosio	Austria	53 *	174	did not jump		29

* Indicates fall.

SKI JUMP

February 12, 1932

Composite of 3 Judges' Score Cards for Points

	Judges:	Johan af Klercker (Sweden)			Dr Francois Lacq (France)			Sigurd Lockeberg (Canada)			Total Points of 3 Judges
		Points			Points			Points			
		Style	Dis- tance	Total	Style	Dis- tance	Total	Style	Dis- tance	Total	
1 Ruud, Birger <i>Norway</i>	1st jump 2nd jump	19 19	18.8 19.4		19.5 18.5	18.8 19.4		19 18.5	18.8 19.4		228.1
2 Beck, Hans <i>Norway</i>	1st jump 2nd jump	19 19	20 18	76	18.5 19	20 18	75.5	19 18.5	20 18	75.5	227
3 Wahlberg, Kaare <i>Norway</i>	1st jump 2nd jump	19 19	17.8 18.2	74	18 18.5	17.8 18.2	72.5	18.5 18.5	17.8 18.2	73	219.5
4 Eriksson, Sven <i>Sweden</i>	1st jump 2nd jump	19 18.5	18.6 18.2	74.3	17.5 17	18.6 18.2	71.3	18 18.5	18.6 18.2	73.3	218.9
5 Oimen, Caspar <i>United States</i>	1st jump 2nd jump	18 19	17.9 19	73.9	16 18	17.9 19	70.9	17 18	17.9 19	71.9	216.7
6 Kaufmann, Fritz <i>Switzerland</i>	1st jump 2nd jump	18 18.5	18 18.6	73.1	16.5 17	18 18.6	70.1	18 18	18 18.6	72.6	215.8
7 Ruud, Sigmund <i>Norway</i>	1st jump 2nd jump	18.5 18	17.9 17.8	72.2	17 18.5	17.9 17.8	71.2	18 18	17.9 17.8	71.7	215.1
8 Adachi, Goro <i>Japan</i>	1st jump 2nd jump	17 18	17.2 18.7	70.9	16.5 17	17.2 18.7	69.4	17 17.5	17.2 18.7	70.4	210.7
9 Chiogna, Cesare <i>Switzerland</i>	1st jump 2nd jump	16 18.5	17.2 17.9	69.6	16.5 17.5	17.2 17.9	69.1	18 18	17.2 17.9	71.1	209.8
10 Rylander, Erik <i>Sweden</i>	1st jump 2nd jump	18 18	16.7 16.8	69.5	17 16.5	16.7 16.8	67	18 18	16.7 16.8	69.5	206
11 Schön, Hjert <i>Sweden</i>	1st jump 2nd jump	16.5 17	16.5 17.6	67.6	15 17	16.5 17.6	66.1	16.5 17.5	16.5 17.6	68.1	201.8
12 Czech, Bronislaw <i>Poland</i>	1st jump 2nd jump	17 17	16.2 17.2	67.4	16 16	16.2 17.2	65.4	17.5 17	16.2 17.2	67.9	200.7
13 Falstad, Pedar <i>United States</i>	1st jump 2nd jump	16 16.5	16.2 17.8	66.5	15 16	16.2 17.8	65	16.5 17.5	16.2 17.8	68	199.5
14 Zardini, Ernesto <i>Italy</i>	1st jump 2nd jump	15.5 16.5	15.5 18.4	65.9	14.5 16	15.5 18.4	64.4	16 16.5	15.5 18.4	66.4	196.7
15 Steele, John <i>United States</i>	1st jump 2nd jump	17 16.5	16 16.2	65.7	16 16.5	16 16.2	64.7	17 16	16 16.2	65.2	195.6
16 Dallago, Ingenuino <i>Italy</i>	1st jump 2nd jump	17.5 16	16.8 15.5	65.8	16 15	16.8 15.5	63.3	17.5 16	16.8 15.5	55.8	194.9

SKI JUMP-Continued
February 12, 1932
Composite of 3 Judges' Score Cards for Points

		Judges: Johan af Klercker (Sweden)			Dr Francois Lacq (France)			Sigurd Lockeberg (Canada)			Total Points of 3 Judges				
		Points			Points			Points							
		Style	Dis- tance	Total	Style	Dis- tance	Total	Style	Dis- tance	Total					
17	Marusarz, Stanislaw <i>Poland</i>	1st jump 2nd jump	16.5 17.5	16 15.5		65.5	15 16	16 15.5		62.5	16 17	16 15.5		64.5	192.5
18	Steuri, Fritz <i>Switzerland</i>	1st jump 2nd jump	17 17	16.7 15.6		66.3	14.5 14	16.7 15.6		60.8	16 17	16.7 15.6		65.3	192.4
19	Lymburne, Robert <i>Canada</i>	1st jump 2nd jump	17 17	16.7 15		65.7	15.5 15	16.7 15		62.2	16 16.5	16.7 15		64.2	192.1
20	Landry, Jacques <i>Canada</i>	1st jump 2nd jump	15.5 16	15.4 15.7		62.6	14.5 15.5	15.4 15.7		61.1	15.5 16.5	15.4 15.7		63.6	187.3
21	Barton, Antonin <i>Czechoslovakia</i>	1st jump 2nd jump	16 16	14 16.7		62.7	14 15.5	14 16.7		60.2	16 16.5	14 16.7		63.2	186.1
22	Marusarz, Andrzej <i>Poland</i>	1st jump 2nd jump	15.5 16	15.1 15.7		62.3	14.5 15	15.1 15.7		60.3	16 16.5	15.1 15.7		63.3	185.9
23	Simunek, Frantisek <i>Czechoslovakia</i>	1st jump 2nd jump	15.5 16	14.3 16.1		61.9	14 14.5	14.3 16.1		58.9	15 17	14.3 16.1		62.4	183.2
24	Cifka, Jan <i>Czechoslovakia</i>	1st jump 2nd jump	15.5 14.5	14 15		59	12.5 14	14 15		55.5	14 15	14 15		58	172.5
25	Paumgarten, Harald <i>Austria</i>	1st jump 2nd jump	14.5 13	12.9 13.9		54.3	13 13.5	12.9 13.9		53.3	14.5 14.5	12.9 13.9		55.8	163.4
26	Feistauer, Jaroslav <i>Czechoslovakia</i>	1st jump 2nd jump	15 15	14 12.5		56.5	13 13.5	14 12.5		53	11 16	14 12.5		53.5	163
27	Menardi, Severino <i>Italy</i>	1st jump 2nd jump	13 14	11.4 16.3		54.7	11 14.5	11.4 16.3		53.2	12 14	11.4 16.3		53.7	161.6
28	Makita, Mitsutake <i>Japan</i>	1st jump 2nd jump	16.5 7 *	16.9 7		47.4	15.5 6.5*	16.9 6.5		45.4	14.5 5 *	16.9 5		41.4	134.2
29	Stone, Arnold <i>Canada</i>	1st jump 2nd jump	5 * 15	5 14.5		39.5	6 * 13.5	6 14.5		40	13.5 4	14.5 14.5		35	114.5
30	Gagne, Leslie <i>Canada</i>	1st jump 2nd jump	15 4 *	13.5 4		36.5	12 5.5*	13.5 5.5		36.5	15 4.5*	13.5 4.5		37.5	110.5
31	Takata, Yoichi <i>Japan</i>	1st jump 2nd jump	13 4 *	11.7 4		32.7	12 3 *	11.7		26.7	14 3 *	11.7 3		31.7	91.1
32	Yamada, Katsumi <i>Japan</i>	1st jump 2nd jump	6 * 7 *	6 7		26	6 * 4 *	6 4		20	5 7 *	5 7		24	70
33	Mikkelsen, Roy <i>United States</i>	1st jump 2nd jump	9 * †	9 †		18	9 * †	9 †		18	8 * †	8 †		16	52
34	Bosio, Harald <i>Austria</i>	1st jump 2nd jump	5 * †	5 †		10	4.5* †	4.5 †		9	5 * †	5 †		10	29

*Indicates fall. †Did not jump.

Speed Skating



—Wide World

Irving Jaffee, U S A, wins he 10,000-meter skate crown to give the United States the four Olympic speed-scating titles



—International Newsreel

Jaffee, U S A, takes 5,000-meter speed-scating event



—Wide World

Jack Shea, Lake Placid boy, breasts the tape, winner in the 1,500-meter speed-skating race, followed by three Canadians, Hurd, Logan, and Stack



—Associated Press

Jack Shea of Lake Placid, Dartmouth College sophomore, wins the 500-meter speed-skating race for the United States, beating Bernt Evensen of Norway. to the tape by five yards

Speed Skating

At the III Olympic Winter Games the speed-skating competitions at distances of 500, 1500, 5000 and 10,000 meters, for the first time in Winter Olympic history, were skated under the rules of the Amateur Skating Union of the United States. This was in accordance with a decision of the congress of the International Skating Union (I E V) at Vienna in May, 1931, permitting the adoption of the North American rules for the Lake Placid Games, if the Organizing Committee might so choose.

The Organizing Committee voted to have the North American rules govern the speed-skating races at Lake Placid since it was felt that these rules were fairer to the skaters as well as making more interesting competi-

tion for the spectators. Then, too, the award of the World's Speed-skating championships to Lake Placid, to be skated under the rules of the International Skating Union on Feb 19 and 20, made it possible for Olympic skaters to compete on the same track under both European and American rules within a fortnight—a fair test of comparative ability in the two skating styles. This decision appeared in the Official III O W G Rules Book, copies of which were mailed to 57 nations several months in advance of the Games.

Under the rules of the Amateur Skating Union of the United States, skaters, instead of racing against the watch, race against each other from a common start, the first man across the line winning the heat or final, as



Norway's Olympic speed-skating team. *Left to right:* Lindboe, Ballangrud, Staksrud, Pedersen, Engnestangen, and Evensen

—Wide World



—Wide World

Japan's Olympic speed-skaters. *Left to right:* Kitani, Ishihara, Uruma, and Kawamura

the case may be. Skaters are drawn in preliminary heats, with a certain number in each heat to qualify for the final. Under the regulations of the I S U, skaters race in pairs, strictly against time, the one having the fastest time winning the event, the rest of the field being ranked in the order of times made.

All skating races at the III Olympic Winter Games were contested on a standard 400-meter track in the Olympic stadium, with the finish line directly in front of the judges' stand.

Shift Date for 10,000-meter Final

Following the first heat of the 10,000-meter race on Friday afternoon, Feb 5, a protest was lodged against two of the skaters for not setting the pace for the agreed number of laps.

After the second heat the same afternoon, a protest was lodged against another skater for interference on the home stretch.

After considering the protests, Referee Joseph K Savage, United States, referred the matter to the three technical delegates: Her-

bert J Clarke, Great Britain; Walter Jakobsson, Finland; and Hermann Kleeberg, Germany. At their meeting the delegates decided, in fairness to all concerned, to have both heats of the 10,000-meter race re-skated the following morning, Saturday, Feb 6, and to have all the original starters Friday compete in the re-skated heats. It is interesting to note that exactly the same 8 skaters qualified in the re-skated preliminary heats.

Because of this situation it was necessary to defer skating the final of the 10,000-meter race until Monday afternoon, Feb 8.

Ice conditions for the four days of competition were ideal. Temperatures were uniformly low, but not too low to have the ice in just the right condition for racing. Snow fell during the final heat of the 5000-meter race on Feb 4 and the 10,000-meter on Feb 8, but not enough to hamper the skaters materially.

Most of the outstanding speed-skaters of the world were entered in the Lake Placid Games, an array of ice talent never before assembled in one meet on the North American continent.

Governing Bodies and Officials

International Skating Union

President—Ulrich Salchow, Stockholm, Sweden

Amateur Skating Union of the United States

President—Joseph K Savage, New York City

Technical Delegates

Herbert J Clarke, Great Britain
Walter Jakobsson, Finland
Hermann Kleeberg, Germany

Officials

Referee and Assistants

Joseph K Savage, Chief, United States
J T Rowan, Assistant, Canada
Irving W Reiner, Assistant, United States

Starter and Assistant

William E Roughton, Chief, Canada
Edmund Horton, Assistant, United States

Judges at Finish

John Harding, Chief, United States
Yngvar Bryn, Norway
Andrew Callanan, United States
Graydon Cowles, United States
Brig Gen W O H Dodds, Canada
Lewis G Graeves, United States
William Carroll Hill, United States
J Edward McVeigh, Canada
H W Main, United States
F Paul Stevens, United States
Raymond F Stevens, United States
Frank W Swift, United States
Dr C C Trembley, United States

Timers

William Reach, Chief, United States
Fred Futterer, United States
Sven Lindhagen, Sweden
Carsten Matheson, Norway
A E Morrison, United States



—Acme Photo

United States squad of Olympic speed-scaters. *Left to right:* Schroeder, Bialas, Murphy, Jaffee, Potts, Deitz, Murray, Guenther, Farrell, Springer, Wedge, Taylor, Shea



—Wide World

Canada's Olympic speed-skaters. *Left to right:* McCarthy, Sylvestre, Smyth, Flack, Stack, Hurd, and Logan

P J Mulqueen, Canada
 George L Starks, United States
 Curtis Stevens, United States
 Hubert Stevens, United States

Scorers

George Anson, Chief, United States
 Harold Eckart, Assistant, United States
 William Distin, United States
 M M Munn, United States
 Harry Noah, United States
 J Harry Pohlman, United States

Clerks of the Course

Charles H Goldsmith, Chief, United States
 John V Dolan, Assistant, United States
 Dr Cato Aall, Norway
 William E Feek, United States
 Harry Kemper, United States
 Armas Palmros, Finland
 William M Potter, United States
 Prof M Sato, Japan

Patrol Judges

Dr J Å Geis, Chief, United States
 Roy McWhirter, Assistant, United States
 Benton Ames, United States
 Benjamin Blanke, United States
 E W Cady, United States
 Arthur Flack, Canada
 R J Kennedy, United States
 J Vernon Lamb, United States
 James McWhirter, United States
 Runar Oehman, Sweden

John Tamsen, United States
 P J Hennessy, United States
 Wayne Timmerman, United States

Announcers

Clarence Eccleston, United States
 Paul Patchin, United States
 Livingston Chapman, United States

Measurers

Henry Homburger, United States
 C W Judson, United States

Events and Rules

Dates of contests: Feb 4, 5, 6, and 8.

Speed-skating consisted of four events: 500, 1500, 5000, and 10,000-meter races.

Maximum number of entries: 8 per nation in each event.

Maximum number of contestants: 4 per nation in each event.

Drawings

Drawings for heats were made in the presence of the technical delegates on January 31 by the representatives of the countries taking part.

Drawings for starting positions were made by the contestants just before each heat or final.

500-METER SPEED SKATING

Entries including reserves

Number of nations entered.....	6
Number of individuals entered.....	27
Number of contestants.....	16

Canada

Flack, Herbert S
Hurd, Alexander
Logan, William F
McCarthy, Marion S
Smyth, C Harry
Stack, Frank
Sylvestre, Leopold

Finland

Blomqvist, Ossian O

Japan

Ishihara, Shozo
Kawamura, Yasuo
Kitani, Tokuo
Uruma, Tomeju

Norway

Ballangrud, Ivar
Engnestangen, Hans
Evensen, Bernt
Lindboe, Erling
Pedersen, Haakon
Staksrud, Michael

Sweden

Lindberg, Carl E

United States

Deitz, Milford
Farrell, J O'Neil
Guenther, Lloyd W
Murray, Raymond V
Potts, Allan W
Shea, John A
Taylor, Herbert G
Wedge, Edwin

500 METER (546.8 Yards)

Stadium

Morning, Feb 4

Results

First 2 in each preliminary heat qualified
for the final.

First Heat

- 1 Stack, Canada
 - 2 Shea, United States
 - 3 Ishihara, Japan
 - 4 Lindboe, Norway
 - 5 Kawamura, Japan
- Time: 44.3 seconds

Second Heat

- 1 Evensen, Norway
 - 2 Logan, Canada
 - 3 Murray, United States
 - 4 Kitani, Japan
 - 5 Sylvestre, Canada
- Time: 45.3 seconds

Third Heat

- 1 Hurd, Canada
 - 2 Farrell, United States
 - 3 Potts, United States
 - 4 Pedersen, Norway
 - 5 Engnestangen, Norway
 - 6 Uruma, Japan
- Time: 44.9 seconds

Final

- 1 Shea, United States
 - 2 Evensen, Norway
 - 3 Hurd, Canada
 - 4 Stack, Canada
 - 5 Logan, Canada
 - 6 Farrell, United States
- Time: 43.4 seconds



—Wide World

Jack Shea, U S A

1500-METER SPEED SKATING

Entries including reserves

Number of nations entered..... 6
Number of individuals entered..... 27
Number of contestants 18

Canada

Flack, Herbert S
Hurd, Alexander
Logan, William F
McCarthy, Marion S
Smyth, C Harry
Stack, Frank
Sylvestre, Leopold

Finland

Blomqvist, Ossian O

Japan

Ishihara Shozo
Kawamura, Yasuo
Kitani, Tokuo
Uruma, Tomeju

Norway

Ballangrud, Ivar
Engnestangen, Hans
Evensen, Bernt
Lindboe, Erling
Pedersen, Haakon
Staksrud, Michael

Sweden

Lindberg, Carl E

United States

Farrell, J O'Neil
Guenther, Lloyd W
Jaffee, Irving
Murphy, Edward S
Murray, Raymond V
Potts, Allan W
Shea, John A
Taylor, Herbert G

1500 METER (.93 Mile)

Stadium

Morning, Feb 5

Results

First 2 in each preliminary heat qualified
for the final.

First Heat

- 1 Taylor, United States
 - 2 Stack, Canada
 - 3 Evensen, Norway
 - 4 Engnestangen, Norway
 - 5 Blomqvist, Finland
 - 6 Uruma, Japan
- Time: 2 minutes 49.3 seconds

Second Heat

- 1 Shea, United States
 - 2 Logan, Canada
 - 3 Ballangrud, Norway
 - 4 Flack, Canada
 - 5 Ishihara, Japan
 - 6 Guenther, United States
- Time: 2 minutes 58 seconds

Third Heat

- 1 Murray, United States
 - 2 Hurd, Canada
 - 3 Staksrud, Norway
 - 4 Kawamura, Japan
 - 5 Kitani, Japan
 - 6 Lindberg, Sweden
- Time: 2 minutes 29.9 seconds

Final

- 1 Shea, United States
 - 2 Hurd, Canada
 - 3 Logan, Canada
 - 4 Stack, Canada
 - 5 Murray, United States
 - 6 Taylor, United States
- Time: 2 minutes 57.5 seconds



—Wide World

Jack Shea, U S A

5000-METER SPEED SKATING

Entries including reserves

Number of nations entered..... 6
 Number of individuals entered..... 27
 Number of contestants..... 18

Canada

Flack, Herbert S
 Hurd, Alexander
 Logan, William F
 McCarthy, Marion S
 Smyth, C Harry
 Stack, Frank
 Sylvestre, Leopold

Finland

Blomqvist, Ossian O

Japan

Ishihara, Shozo
 Kawamura, Yasuo
 Kitani, Tokuo
 Uruma, Tomeju

Norway

Ballangrud, Ivar
 Engnestangen, Hans
 Evensen, Bernt
 Lindboe, Erling
 Pedersen, Haakon
 Staksrud, Michael

Sweden

Lindberg, Carl E

United States

Bialas, Valentine
 Jaffee, Irving
 Murphy, Edward S
 Schroeder, Edward J
 Shea, John A
 Springer, Carl F
 Taylor, Herbert G
 Wedge, Edwin

5000 METER (3.1 Miles)

Stadium *Afternoon, Feb 4*

Results

First 4 in each preliminary heat qualified for the final.

First Heat

- 1 Jaffee, United States
 - 2 Murphy, United States
 - 3 Ballangrud, Norway
 - 4 Smyth, Canada
 - 5 Blomqvist, Finland
 - * Hurd, Canada
 - * Staksrud, Norway
 - * Uruma, Japan
 - * Ishihara, Japan
- Time: 9 minutes 52 seconds

Second Heat

- 1 Evensen, Norway
 - 2 Taylor, United States
 - 3 Logan, Canada
 - 4 Stack, Canada
 - 5 Lindboe, Norway
 - 6 Springer, United States
 - * Lindberg, Sweden
 - * Kawamura, Japan
 - * Kitani, Japan
- Time: 10 minutes 1.4 seconds

Final

- 1 Jaffee, United States
 - 2 Murphy, United States
 - 3 Logan, Canada
 - 4 Taylor, United States
 - 5 Ballangrud, Norway
 - 6 Evensen, Norway
 - 7 Stack, Canada
 - 8 Smyth, Canada
- Time: 9 minutes 40.8 seconds

* Order of finish not recorded.



—Wide World

Irving Jaffee, U S A

10,000-METER SPEED SKATING

Entries including reserves

Number of nations entered.....	6
Number of individuals entered.....	26
Number of contestants.....	18

Canada

Flack, Herbert S
Hurd, Alexander
Logan, William F
McCarthy, Marion S
Smyth, C Harry
Stack, Frank
Sylvestre, Leopold

Finland

Blomqvist, Ossian O

Japan

Ishihara, Shozo
Kawamura, Yasuo
Kitani, Tokuo
Uruma, Tomeju

Norway

Ballangrud, Ivar
Engnestangen, Hans
Evensen, Bernt
Lindboe, Erling
Pedersen, Haakon
Staksrud, Michael

Sweden

Lindberg, Carl E

United States

Bialas, Valentine
Deitz, Milford
Jaffee, Irving
Schroeder, Edward J
Springer, Carl F
Taylor, Herbert G
Wedge, Edwin

10,000 METER (6.2 Miles)

Stadium

Morning, Feb 6

Results

First 4 in each preliminary heat qualified for the final.

First Heat

- 1 Hurd, Canada
 - 2 Ballangrud, Norway
 - 3 Bialas, United States
 - 4 Wedge, United States
 - 5 Blomqvist, Finland
 - 6 Staksrud, Norway
 - * Uruma, Japan
 - * Ishihara, Japan
 - * McCarthy, Canada
- Time: 17 minutes 56.2 seconds

Second Heat

- 1 Jaffee, United States
 - 2 Stack, Canada
 - 3 Evensen, Norway
 - 3 Schroeder, United States } tie
 - 5 Logan, Canada
 - 6 Engnestangen, Norway
 - * Lindberg, Sweden
 - * Kitani, Japan
 - * Kawamura, Japan
- Time: 18 minutes 5.4 seconds

Stadium

Afternoon, Feb 8

Final

- 1 Jaffee, United States
 - 2 Ballangrud, Norway
 - 3 Stack, Canada
 - 4 Wedge, United States
 - 5 Bialas, United States
 - 6 Evensen, Norway
 - 7 Hurd, Canada
 - 8 Schroeder, United States
- Time: 19 minutes 13.6 seconds



—Wide World

Irving Jaffee, U S A

* Order of finish not recorded.

Figure Skating

In reviewing the figure-skating competitions at the III Olympic Winter Games two facts loom large. For the first time in the history of the great winter-sports classic all figure-skating events were held on artificial ice indoors; and these same three events, men's singles, women's singles, and pair skating, proved to be among the most popular on the entire program.

Possibly the latter statement calls for some explanation. While figure-skating in the United States has been enjoyed both by accomplished exponents and enthusiastic supporters for years, the sport had never until the Lake Placid Games the almost universal appeal that it has so long possessed abroad. The reason is not hard to find. Practically no communities outside the larger cities have proper indoor ice rinks for the development of the sport, and in the cities devotees of the dips and whirls have been drawn for the most part from the leisure strata of society. The average youngster, if he took to the ice at all, went in for speed-skating and set as his idols the record-holders of the racing track.

Prior to the Lake Placid Games figure-skating had never received its merited share of publicity, and it is publicity in sport that sets up the idols that the young try to imitate. Widespread imitation means widespread participation and widespread appeal. These figure-skating did not have.

But the evening figure-skating events at the III Olympic Winter Games, men's free figures, women's free figures, and pair skating, found crowds storming the doors of the Olympic arena, willing to pay almost any price to get in. Thousands of additional tickets could have been sold for these three events. Every available inch of seating space and standing-room in the arena was occupied. And no one who witnessed the exhibitions was heard to say that he was in the least disappointed with what he saw.

Practice Sessions Arouse Interest

Many factors contributed to this sudden interest in figure-skating. The famous Old

World champions began to arrive in this country early in January, about a month before the Games. Their practice sessions in New York city were attended by newspaper and magazine sports experts and appropriately reported. The experts then began to look into the chances of the United States in the figure-skating events at the Olympics. And this country's champions and Olympic team members were duly exploited in the sports columns, more than they ever had been in the past.

Soon the advance guard of Olympic entrants moved on to Lake Placid and began regular work-outs in the new Olympic arena. Afternoon and evening during this pre-Olympic period the huge building was thronged with spectators. They were entranced with the grace, artistry, and ease with which the ranking ice stars executed the difficult figures. They realized that a new sport, or better a new art, was being demonstrated for them by the world's best. At the Games they almost fought to get in the arena. Figure-skating had arrived.

Weather Could Not Interfere

All the figure-skating events, both practice and championship sessions, were held in the indoor arena, completed early in January, a few weeks before the opening of the Games. The arena was built during the preceding summer with the staging of the Olympic figure-skating competitions as one of its prime objects. The wisdom of holding these events indoors was proved times without number.

In spite of extraordinary weather conditions during January and early February that wrought considerable hardship on those charged with the staging of other Olympic sports, figure-skating practice was never interfered with, the Olympic program was run off strictly according to schedule, and competitors were able always to put on their best performances, since the arena ice was of uniformly high quality, and temperatures could always be regulated to suit.



—*International Newsreel*
Karl Schäfer of Austria, winner of the Olympic
figure skating crown.



—*International Newsreel*
Sonja Henie, the pride of Norway, Olympic and
world's champion figure-skater



Graceful Fritzi Burger of Austria, second-place winner in the Olympic figure-scating



—Wide World
Maribel Vinson, who took third-place honors for the United States



—Roger L. Moore
Brunet-Brunet, France, take Olympic pair-skating crown



—Roger L. Moore
Loughran-Badger team of the United States, winners of second place in Olympic pair-skating



—Wide World
Gillis Grafström, Sweden, second-place winner in men's figure skating, in a characteristic pose

Figure Skating

Half of Great Britain's Winter Olympic team. Megan Taylor (left) and Magdalen Colledge



These 11-year-old youngsters placed seventh and eighth respectively in women's figure-skating competitions



Constance Wilson-Samuel of Canada, fourth-place winner in women's figure skating

—Stedman



Yvonne de Ligne, Belgium, sixth in the figure skating

—International Newsreel



Vivi-Anne Hulthen who took fifth-place honors for women figure-skaters back to her native Sweden

—Roger L. Moore



Rotter-Szollás of Hungary, third in pair-skating

—Roger L. Moore



Hungary wins fourth in pair skating. Órgonista-Szalay team

—Roger L. Moore

Figure Skating

More nations, 13, took part in figure-skating than in any other sport on the program of the III O W G. The most famous stars of the world were entered, including the winners of the men's singles, women's singles, and pair skating at the II Olympic Winter Games at St Moritz.

Competition was extremely close, so uniform was the high quality of the field.

Governing Bodies and Officials

International Skating Union

President—Ulrich Salchow, Stockholm, Sweden

United States Figure Skating Association

President—Sherwin C Badger, New York City

Technical Delegates

Herbert J Clarke, Great Britain
Walter Jakobsson, Finland
Hermann Kleeberg, Germany

Officials

Figure Skating—Men

Referee

Joel Liberman, United States

Judges

Yngvar Bryn, Norway
Herbert J Clarke, Great Britain
Hans Grünauer, Austria
Walter Jakobsson, Finland
J Cecil MacDougall, Canada
Dr Jenö Minich, Hungary
Charles Rotch, United States

Figure Skating—Women

Referee

Joel Liberman, United States

Judges

Yngvar Bryn, Norway
Herbert J Clarke, Great Britain
Hans Grünauer, Austria
Walter Jakobsson, Finland
J Cecil MacDougall, Canada
Charles Rotch, United States
Georges Torchon, France

Figure Skating—Pairs

Referee

Joel Liberman, United States

Judges

Yngvar Bryn, Norway
Herbert J Clarke, Great Britain
Hans Grünauer, Austria
Walter Jakobsson, Finland
Dr Jenö Minich, Hungary
Charles Rotch, United States
Georges Torchon, France

Events and Rules

Dates of contests:

Figure Skating—Men

School Figures.....Feb 8

Free Figures.....Feb 9

Figure Skating—Women

School Figures.....Feb 9

Free Figures.....Feb 10

Figure Skating—Pairs.....Feb 12

Maximum number of entries:

Figure Skating—Men: 8 per nation

Figure Skating—Women: 8 per nation

Figure Skating—Pairs: 4 pairs per nation

Maximum number of contestants:

Figure Skating—Men: 4 per nation

Figure Skating—Women: 4 per nation

Figure Skating—Pairs: 2 pairs per nation

Prescribed School Figures

The list of the prescribed school figures for the III Olympic Winter Games, as chosen by the International Skating Union (I E V), follows:

For Men

Numbers 40a, 40b (R O F)	
Bracket Change Bracket	(24) 48
Numbers 39a, 39b (R O B)	
Loop Change Loop	(30) 60
Numbers 35a, 35b (R O B)	
Three Change Three.....	(18) 36
Numbers 28a, 28b (R O I F)	
Change Double Three.....	(6) 12
Numbers 22a, 22b, (R O F)	
Counter	(18) 36
Numbers 20a, 20b (R O F)	
Rocker	(24) 48

For Women

Numbers 38a, 38b (R O F)	
Loop Change Loop	(24) 48
Numbers 33a, 33b (R I O F)	
Change Bracket	(18) 36
Numbers 35a, 35b (R O B)	
Three Change Three.....	(18) 36
Numbers 23a, 23b (R I F)	
Counter	(18) 36
Numbers 20a, 20b (R O F)	
Rocker	(24) 48
Number 12 (R O B)	
Double Three	6

FIGURE SKATING—MEN

Entries including reserves

Number of nations entered.....	9
Number of individuals entered.....	15
Number of contestants.....	12

Austria

Schafer, Karl

Canada

Reburn, Stewart
Wilson, Montgomery

Czechoslovakia

Langer, Walter

Finland

Nikkanen, Marcus

France

Torchon, Georges

Germany

Baier, Ernst

Japan

Oimatsu, Kazuyoshi
Obitani, Ryoichi

Sweden

Grafström, Gillis

United States

Borden II, Gail
Hill, George
Madden, James
Nagel, William
Turner, Roger

FIGURE SKATING—MEN

Arena

School Figures:

Morning and Afternoon, Feb 8

Free Figures: *Evening, Feb 9*

Results

		Sums of 7 Judges' Markings	
		Ratings	Points
1	Schafer, Austria.....	9	2602.0
2	Grafström, Sweden.....	13	2514.5
3	Wilson, Canada.....	24	2448.3
4	Nikkanen, Finland.....	28	2420.1
5	Baier, Germany.....	35	2334.8
6	Turner, United States.....	40	2297.6
7	Madden, United States.....	52	2049.6
8	Borden II, United States...	54	2110.8
9	Oimatsu, Japan.....	67	1978.6
10	Langer, Czechoslovakia.....	70	1964.3
11	Nagel, United States.....	77	1884.8
12	Obitani, Japan.....	79	1856.7



—International Newsreel

Karl Schäfer, Austria

FIGURE SKATING—MEN
Composite of Judges' Score Cards

Referee: J Liberman United States	Judges:		Y Bryn	H J Clarke Great Britain	Grünauer Austria	W Jakobsson Finland	J C Mac-Dougal Canada	J Minich Hungary	C Rotch U S A	Sums of Judges' Points and Ratings
		Norway								
1 Schäfer, Karl <i>Austria</i>	School Free	223.8 150.2	198.0 139.6	226.0 152.9	223.0 150.2	223.0 146.3	233.1 159.6	226.1 150.2	2602.0	
	Total	374.0	337.6	378.9	373.2	369.3	392.7	376.3		
	Rated	1	2	1	2	1	1	1		9
2 Grafström, Gillis <i>Sweden</i>	School Free	211.8 142.3	197.8 142.3	212.7 139.6	221.5 154.2	210.4 148.9	225.8 147.6	216.0 143.6	2514.5	
	Total	354.1	340.1	352.3	375.7	359.3	373.4	359.6		
	Rated	3	1	2	1	2	2	2		13
3 Wilson, Montgomery <i>Canada</i>	School Free	210.3 139.6	196.5 126.3	207.9 138.3	214.2 134.3	216.2 142.3	215.9 147.6	216.6 142.3	2448.3	
	Total	349.9	322.8	346.2	348.5	358.5	363.5	358.9		
	Rated	4	3	4	4	3	3	3		24
4 Nikkanen, Marcus <i>Finland</i>	School Free	218.9 148.9	193.1 125.0	211.1 136.9	218.5 138.3	196.2 139.6	211.0 142.3	202.0 138.3	2420.1	
	Total	367.8	318.1	348.0	356.8	335.8	353.3	340.3		
	Rated	2	4	3	3	5	5	6		28
5 Baier, Ernst <i>Germany</i>	School Free	205.1 133.0	183.8 119.7	206.3 136.9	199.2 133.0	201.9 135.6	211.2 142.3	196.5 130.3	2334.8	
	Total	338.1	303.5	343.2	332.2	337.5	353.5	326.8		
	Rated	5	5	5	5	4	4	7		35
6 Turner, Roger <i>United States</i>	School Free	201.7 134.3	184.8 110.3	207.6 129.0	210.7 114.1	199.3 122.3	201.9 130.3	218.3 133.0	2297.6	
	Total	336.0	295.1	336.6	324.8	321.6	332.2	351.3		
	Rated	6	6	6	6	6	6	4		40
7 Madden, James <i>United States</i>	School Free	184.5 123.6	168.8 106.4	188.4 119.7	192.4 121.0	180.8 123.6	181.8 114.3	204.7 139.6	2049.6	
	Total	308.1	275.2	308.1	313.4	304.4	296.1	244.3		
	Rated	7	7	8	8	8	9	5		52
8 Borden II, Gail <i>United States</i>	School Free	190.1 114.3	156.9 99.7	192.7 117.0	192.5 127.6	187.1 105.7	186.6 117.0	201.3 122.3	2110.8	
	Total	304.4	256.6	309.7	320.1	292.8	303.6	323.6		
	Rated	8	8	7	7	9	7	8		54
9 Oimatsu, Katuyoshi <i>Japan</i>	School Free	173.9 117.0	136.8 103.7	171.3 115.7	174.7 115.7	169.2 114.3	176.1 122.3	165.6 122.3	1978.6	
	Total	290.9	240.5	287.0	290.4	283.5	298.4	287.9		
	Rated	9	10	9	9	12	8	10		67
10 Langer, Walter <i>Czechoslovakia</i>	School Free	182.4 106.4	133.7 93.1	184.9 99.7	178.4 106.4	188.6 117.0	172.8 106.4	180.2 114.3	1964.3	
	Total	288.8	226.8	284.6	284.8	305.6	279.2	294.5		
	Rated	10	11	10	11	7	12	9		70
11 Nagel, William <i>United States</i>	School Free	163.0 94.4	117.5 103.0	169.7 109.0	153.1 127.6	167.9 118.3	174.5 119.7	150.1 117.0	1884.8	
	Total	257.4	220.5	278.7	280.7	286.2	294.2	267.1		
	Rated	12	12	11	10	11	10	11		77
12 Obitani, Ryoichi <i>Japan</i>	School Free	166.8 101.0	140.2 102.4	167.0 97.0	167.4 99.7	173.0 115.7	186.1 106.4	147.6 86.4	1856.7	
	Total	267.8	242.6	264.0	267.1	288.7	292.5	234.0		
	Rated	11	9	12	12	10	11	12		79

FIGURE SKATING—WOMEN

Entries including reserves

Number of nations entered.....	7
Number of individuals entered.....	16
Number of contestants.....	15

Austria

Burger, Fritz

Belgium

de Ligne, Yvonne

Canada

Fisher, Elizabeth
Littlejohn, Mary
Wilson-Samuel, Constance

Great Britain

Colledge, Magdalen
Dix, Joan

Phillips, Mollie
Taylor, Megan

Norway

Henie, Sonja

Sweden

Hulten, Vivi-Anne

United States

Bennett, Margaret
Davis, Suzanne
Peppe, Audrey
Vinson, Maribel
Weigel, Louise

FIGURE SKATING—WOMEN

Arena

School Figures:

Morning and Afternoon, Feb 9

Free Figures: *Evening, Feb 10*

Results

	Sums of 7 Judges' Markings	
	Ratings	Points
1 Henie, Norway.....	7	2302.5
2 Burger, Austria.....	18	2167.1
3 Vinson, United States.....	23	2158.5
4 Wilson-Samuel, Canada....	28	2131.9
5 Hulten, Sweden.....	29	2129.5
6 de Ligne, Belgium.....	45	1942.5
7 Taylor, Great Britain.....	55	1911.8
8 Colledge, Great Britain...	64	1851.6
9 Phillips, Great Britain.....	63	1864.7
10 Dix, Great Britain.....	75	1833.6
11 Bennett, United States.....	75	1826.8
12 Davis, United States.....	83	1780.4
13 Fisher, Canada	82	1801.0
14 Weigel, United States.....	92	1769.4
15 Littlejohn, Canada.....	101	1711.6



—Wide World

Sonja Henie, Norway

FIGURE SKATING—WOMEN
Composite of Judges' Score Cards

Referee: J Liberman United States	Judges:	Y	H J	H	W	J C	G	C	Ratings
		Bryn Norway	Clarke Great Britain	Grünauer Austria	Jakobsson Finland	Mac- Dougal Canada	Torchon France	Rotch U S A	
1 Henie, Sonja <i>Norway</i>	School	201.5	188.9	197.8	199.8	190.9	196.4	195.2	2302.5 7
	Free	135.7	131.0	130.7	136.8	129.9	135.7	132.2	
	Total Rated	337.2 1	319.9 1	328.5 1	336.6 1	320.8 1	332.1 1	327.4 1	
2 Burger, Fritz <i>Austria</i>	School	188.3	181.7	191.9	188.3	180.7	177.3	183.4	2167.1 18
	Free	128.7	121.8	128.7	122.9	124.1	122.9	126.4	
	Total Rated	317.0 2	303.5 4	320.6 2	311.2 3	304.8 2	300.2 2	309.8 3	
3 Vinson, Maribel <i>United States</i>	School	185.6	194.0	188.0	188.3	175.7	175.8	190.6	2158.5 23
	Free	124.1	121.8	122.9	120.6	121.8	119.4	129.9	
	Total Rated	309.7 4	315.8 2	310.9 3	308.9 4	297.5 5	295.2 3	320.5 2	
4 Wilson-Samuel, Constance <i>Canada</i>	School	185.6	180.9	187.8	184.1	182.6	175.8	187.4	2131.9 28
	Free	125.2	120.6	121.8	119.4	121.8	118.3	120.6	
	Total Rated	310.8 3	301.5 5	309.6 4	303.5 5	304.4 3	294.1 4	308.0 4	
5 Hulten, Vivi-Anne <i>Sweden</i>	School	180.2	187.3	187.6	188.7	178.2	174.7	177.0	2129.5 29
	Free	121.8	121.8	118.3	125.2	122.9	119.4	126.4	
	Total Rated	302.0 5	309.1 3	305.9 5	313.9 2	301.1 4	294.1 5	303.4 5	
6 de Ligne, Yvonne <i>Belgium</i>	School	171.0	166.4	175.1	167.5	172.8	168.8	168.3	1942.5 45
	Free	113.6	95.1	110.2	109.0	97.4	111.3	116.0	
	Total Rated	284.6 6	261.5 6	285.3 8	276.5 6	270.2 7	280.1 6	284.3 6	
7 Taylor, Megan <i>Great Britain</i>	School	167.5	164.8	176.2	162.9	170.5	167.4	168.4	1911.8 55
	Free	113.6	87.0	110.2	104.4	104.4	105.5	109.0	
	Total Rated	281.1 8	251.8 10	286.4 7	267.3 9	274.9 6	272.9 7	277.4 8	
8 Colledge, Magdalen <i>Great Britain</i>	School	151.9	169.5	177.4	165.9	166.6	161.1	173.9	1851.6 64
	Free	90.4	83.5	110.2	107.8	81.2	107.8	104.4	
	Total Rated	242.3 14	253.0 9	287.6 6	273.7 7	247.8 13	268.9 8	278.3 7	
9 Phillips, Mollie <i>Great Britain</i>	School	171.1	170.2	173.7	160.9	168.5	151.7	170.5	1864.7 63
	Free	111.3	85.8	106.7	104.4	95.1	91.6	103.2	
	Total Rated	282.4 7	256.0 8	280.4 9	265.3 10	263.6 8	243.3 12	273.7 9	
10 Dix, Joan <i>Great Britain</i>	School	167.7	173.8	169.4	161.2	163.1	144.4	166.4	1833.6 75
	Free	98.6	84.6	106.7	103.2	92.8	96.2	105.5	
	Total Rated	266.3 12	258.4 7	276.1 12	264.4 12	255.9 9	240.6 13	271.9 10	
11 Bennett, Margaret <i>United States</i>	School	165.3	156.4	164.5	157.8	159.5	148.5	163.9	1826.8 75
	Free	105.5	92.8	106.7	106.7	92.8	98.6	107.8	
	Total Rated	270.8 9	249.2 11	271.2 13	264.5 11	252.3 10	247.1 10	271.7 11	
12 Davis, Suzanne <i>United States</i>	School	159.9	163.3	175.1	166.3	165.8	150.1	166.8	1780.4 83
	Free	77.7	82.3	102.0	104.4	69.6	95.1	102.0	
	Total Rated	237.6 15	245.6 12	277.1 11	270.7 8	235.4 14	245.2 11	268.8 12	
13 Fisher, Elizabeth <i>Canada</i>	School	165.6	154.1	172.6	158.4	162.9	152.2	160.3	1801.0 82
	Free	104.4	84.6	105.5	92.8	87.0	97.4	103.2	
	Total Rated	270.0 10	238.7 13	278.1 10	251.2 14	249.9 12	249.6 9	263.5 14	
14 Weigel, Louise <i>United States</i>	School	160.3	149.6	161.6	159.7	163.3	145.6	163.7	1769.4 92
	Free	91.6	83.5	105.5	100.9	87.0	93.9	103.2	
	Total Rated	251.9 13	233.1 14	267.1 14	260.6 13	250.3 11	239.5 14	266.9 13	
15 Littlejohn, Mary <i>Canada</i>	School	162.4	148.5	160.3	148.2	159.9	141.6	156.3	1711.6 101
	Free	104.4	74.2	104.4	97.4	63.8	91.6	98.6	
	Total Rated	266.8 11	222.7 15	264.7 15	245.6 15	223.7 15	233.2 15	254.9 15	

FIGURE SKATING—PAIRS

Entries including reserves

Number of nations entered.....	4
Number of individuals entered.....	18
Number of contestants.....	14

Canada

Claudet, Frances
 Bangs, Chauncy
 Rogers, Isabel
 Rogers, Melville
 Wilson-Samuel, Constance
 Wilson, Montgomery

France

Brunet, Andrée
 Brunet, Pierre

Hungary

Orgonista, Olga
 Szalay, Sándor
 Rotter, Emilia
 Szollás, László

United States

Loughran, Beatrix
 Badger, Sherwin
 Meredith, Gertrude
 Savage, Joseph
 Vinson, Maribel
 Hill, George

FIGURE SKATING—PAIRS

Arena

Evening, Feb 12

Results

		Sums of 7 Judges' Markings	
		Ratings	Points
1	Brunet Brunet	} France	12 76.7
2	Loughran Badger	} United States...	16 77.5
3	Rotter Szollás	} Hungary	20 76.4
4	Orgonista Szalay	} Hungary	28 72.2
5	Wilson-Samuel Wilson	} Canada	35 69.6
6	Claudet Bangs	} Canada	36 68.9
7	Meredith Savage	} United States...	49 59.8



—Roger L. Moore

Mr and Mrs Brunet, France

FIGURE SKATING—PAIRS

Composite of Judges' Score Cards

Referee: J Liberman United States		Judges:	J. Minich Hun- gary	Y Bryn Norway	H Grünauer Austria	W Jakobsson Finland	G Torchon France	H J Clarke Great Britain	C Rotch U S A	Sums of Judges' Points and Ratings
1	Brunet, Andrée	Program Performance	5.6 5.6	5.5 5.5	5.8 5.8	5.3 4.7	5.6 5.7	5.2 5.3	5.7 5.4	76.7 12
	Brunet, Pierre <i>France</i>	Total	11.2	11.0	11.6	10.0	11.3	10.5	11.1	
	Rated	2.5	1	1.5	3	1	1	2		
2	Loughran, Beatrix	Program Performance	5.5 5.5	5.2 5.7	5.8 5.6	5.8 5.4	5.6 5.5	5.1 5.3	5.8 5.7	77.5 16
	Badger, Sherwin <i>United States</i>	Total	11.0	10.9	11.4	11.2	11.1	10.4	11.5	
	Rated	4	2	4	1	2	2	1		
3	Rotter, Emilia	Program Performance	6.0 6.0	5.3 5.5	5.8 5.7	5.0 4.9	5.4 5.5	5.1 5.2	5.3 5.7	76.4 20
	Szollás, László <i>Hungary</i>	Total	12.0	10.8	11.5	9.9	10.9	10.3	11.0	
	Rated	1	3	3	4	3	3	3		
4	Orgonista, Olga	Program Performance	5.6 5.6	5.3 5.3	5.8 5.8	4.4 4.8	4.5 4.5	5.0 5.0	5.1 5.5	72.2 28
	Szalay, Sándor <i>Hungary</i>	Total	11.2	10.6	11.6	9.2	9.0	10.0	10.6	
	Rated	2.5	5	1.5	5	5	4	5		
5	Wilson-Samuel, Constance	Program Performance	5.4 4.8	4.5 4.8	5.8 5.5	4.0 4.4	5.5 4.6	4.8 4.8	5.5 5.2	69.6 35
	Wilson, Montgomery <i>Canada</i>	Total	10.2	9.3	11.3	8.4	10.1	9.6	10.7	
	Rated	5	6	5	6	4	5	4		
6	Claudet, Frances	Program Performance	5.2 4.8	5.1 5.6	5.3 5.0	5.4 4.7	4.5 4.0	4.5 4.6	5.0 5.2	68.9 36
	Bangs, Chauncy <i>Canada</i>	Total	10.0	10.7	10.3	10.1	8.5	9.1	10.2	
	Rated	6	4	6	2	6	6	6		
7	Meredith, Gertrude	Program Performance	4.8 4.3	4.0 4.6	4.7 4.5	4.0 4.0	3.7 3.6	4.0 4.0	4.8 4.8	59.8 49
	Savage, Joseph <i>United States</i>	Total	9.1	8.6	9.2	8.0	7.3	8.0	9.6	
	Rated	7	7	7	7	7	7	7		



Entrants in men's figure-skating. *Left to right:* Roger Turner, U S A, sixth place; Walter Langer, Czechoslovakia; Montgomery Wilson, Canada, third; Karl Schäfer, Austria, first; Ernst Baier, Germany, fifth; Gail Borden II, U S A; James Madden, U S A; Gillis Grafström, Sweden, second; Marcus Nikkanen, Finland, fourth; Ryoichi Obitani, Japan; Kazuyoshi Oimatsu, Japan; William Nagel, U S A

—International Newsreel



Plenty of action in front of the net in a game between Canada and Germany. The Canadians conquered their rivals 4—1

—Associated Press

Hockey

Altho early information from countries planning to take part in the III Olympic Winter Games led the Organizing Committee to believe that a large number of ice hockey teams would compete at Lake Placid, unprecedented economic conditions all over the world, conditions that steadily grew worse as the closing date for national entries approached, resulted in only four teams entering.

These teams at Lake Placid represented Canada, Germany, Poland, and the United States. The competition was keen; every game was hard fought; and the whole program reflected the strides that hockey has made in the past few years as an international sport, both in popularity and in quality of play.

Each team played the other twice, so that, under this arrangement, there were 12 games on the official Olympic program. Six of these clashes took place outdoors in the Olympic stadium, and six indoors in the Olympic arena.

Because of the limited entry list in hockey resulting from the world-wide economic situation, the International Olympic Committee gave permission for enough exhibition contests to be staged to complete the minimum schedule of 18 games, planned for from the beginning for not less than six teams. There were five games in this series, participated in by the Olympic sextets and the following non-Olympic teams: McGill University of Canada and Lake Placid Athletic Club. Two games, originally scheduled to be played be-



—*International Newsreel*

Some fast work in center ice as Canada defeats United States 2—1 in first game of hockey series

tween Lake Placid A C and Canada and Lake Placid A C and U S A, were replaced by one game between a team made up of players from the Canadian and United States Olympic teams and the Lake Placid A C. As a result of this shift the complete hockey schedule consisted of 17 games.

Good spirit was shown by the Canadian and United States Olympic squads in combining for the exhibition game against Lake Placid A C. The Olympic players were all dressed in United States jerseys, only the stockings distinguishing the Canadian players from those of the United States. This exhibition clash was one of the best games on the entire Olympic card.

The final game of the Olympic series, that between the United States and Canada, literally packed the Olympic arena. No one can

estimate how many additional tickets could have been sold if there had been any room in which to put the purchasers.

Once again the arena proved its worth in making possible the playing thru of the hockey schedule without any interruption. There were two hockey boxes in the stadium and one in the arena. When weather conditions were against outdoor play, games were shifted to the indoor rink, with resulting satisfaction to the spectators and the players alike. With three hockey boxes available, it was always possible for teams to practice whenever they wished.

The loud-speaker installations at the stadium and the arena made it possible to announce scores and penalties so that the audience could follow the games with the utmost ease. Scores were also posted on large bulletin-boards at both stadium and arena.



—Wide World

United States hockey squad, runner-up to Canada for Olympic title. *Left to right, kneeling:* Farrell, Bent, Anderson, Cookman, Smith, Frazier. *Left to right, rear row, standing:* Winsor, coach, Nelson, Livingston, Fitzgerald, Everett, Chase, Palmer, Garrison, Hallock, Murray, trainer, and Gleason.

Governing Bodies and Officials

International Ice Hockey League

President—Paul Loicq, Brussels, Belgium

Amateur Athletic Union of the United States

President—Avery Brundage, Chicago, Illinois

Technical Delegate

Rufus J Trimble, United States

Technical Advisory Committee

Frank Greenleaf, Canada

Hermann Kleeberg, Germany

Dr Stanislaw Polakiewicz, Poland

Events and Rules

Dates of contests: Feb 4, 5, 6, 7, 8, 9, 10, 13

Maximum number of entries or contestants per nation: 1 team of 10 men with 3 reserves plus 1 reserve goal keeper.

Maximum number of players permitted to participate from one country in one contest: 10 men including 1 reserve goal keeper.

Under the rules adopted for scoring the hockey games at the III O W G, 2 points were given for each game won, 1 to each team for games tied, and none for each game lost.

Time of periods, 15 minutes each; over-time periods, 10 minutes each.



—*International Newsreel*

Canada and the United States tie at 2—2 in hockey final before huge throng in Olympic arena. Three over-time periods were played with no scoring

HOCKEY

Number of nations entered..... 4
 Number of individuals entered..... 49
 Number of contestants..... 49

G—Goal; D—Defense; C—Center; F—Forward

Canada

G—Cockburn, William
 G—Wagner, U Stanley
 D—Sutherland, Hugh
 D—Hinkel, Roy
 C—Monson, Walter
 C—Simpson, Harold
 C—Garbutt, George
 F—Malloy, Norman
 F—Wise, J Alston
 F—Lindquist, C Victor
 F—Rivers, N Romeo
 F—Moore, Kenneth
 F—Crowley, Clifford
 F—Duncanson, Albert

Poland

G—Stogowski, Jozef
 G—Sachs, Tadeusz

D—Mauer, Albert
 D—Kowalski, Aleksander
 C—Krygier, Wlodzimierz
 C—Materski, Kazimierz
 F—Marchewczyk, Czeslaw
 F—Sokolowski, Kazimierz
 F—Sabinski, Roman
 F—Kowalski, Adam
 F—Ludwiczak, Witalis

Germany

G—Leinweber, Walter
 D—Heinrich, Alfred
 D—Römer, Erich
 C—Ball, Rudi
 C—Strobl, Georg
 F—Herker, Erich
 F—Jaenecke, Gustav
 F—Korff, Werner

F—Schröttele, Martin
 F—Slevogt, F Marquardt

United States

G—Farrell, Franklin
 G—Frazier, Edward
 D—Anderson, Osborn
 D—Garrison, John
 D—Fitzgerald, Joseph
 D—Hallock, Gerard
 D—Livingston, Robert
 C—Chase, John
 C—Nelson, Francis
 F—Bent, John
 F—Cookman, John
 F—Palmer, Winthrop
 F—Everett, Douglas
 F—Smith, Gordon



—Associated Press

German Olympic hockey team. *Left to right, front row:* Strobl, Ball, Herker, Römer, and Schröttele. *Left to right, top row:* Heinrich, Leinweber, Dr Paul Schwarz, German consul-general in New York, Jaenecke, Slevogt, and Korff

HOCKEY RESULTS

Canada vs United States

Stadium *Morning, Feb 4*
Canada (2) *United States (1)*
 Cockburn.....G.....Farrell
 Sutherland.....RD.....Garrison
 Hinkel.....LD.....Anderson
 Monson.....C.....Chase
 Lindquist.....RW.....Everett
 Rivers.....LW.....Palmer

Spares

Wise	Bent
Simpson	Cookman
Malloy	Nelson

G—Goal; RD—Right Defense; LD—Left Defense; C—Center; R W—Right Wing; LW—Left Wing.

Score by periods

	<i>Overtime</i>			
	1st	2nd	3rd	Total
Canada	0	0	1	1
United States....	0	1	0	0

Goals

1st period—None
 2nd period—United States, Everett 2:05
 3rd period—Canada, Simpson..... 13:36
 Overtime period—Canada, Lindquist..... 7:14

Penalties

1st period—None
 2nd period—None
 3rd period—Garrison, United States..... 2 min
 Palmer, United States..... 2 min
 Overtime period—Sutherland, Canada..... 2 min
 Malloy, Canada..... 2 min

Referees

Lou Marsh, Canada
 Donald P Sands, United States

Goal Judges

Bert Marples, Canada
 Clarence Bisson, United States

Timers

James T Sutherland, Canada
 Elwood S Kerr, United States

Penalty Timers

Edward Gilroy, Canada
 Henry Uihlein, United States

Germany vs Poland

Stadium *Afternoon, Feb 4*
Germany (2) *Poland (1)*
 Leinweber.....G.....Stogowski
 Heinrich.....R D.....Kowalski, Al
 Romer.....LD.....Sokolowski
 Ball.....C.....Krygier
 Schröttle.....R W.....Sabinski
 Jaenecke.....LW.....Kowalski, Adam

Spares

Strobl	Marchewczyk
Korff	Materski
Slevogt	Ludwiczak

Score by periods

	1st	2nd	3rd	Total
Germany	0	1	1	2
Poland	0	1	0	1

Goals

1st period—None
 2nd period—Germany, Jaenecke..... 0:12
 Poland, Kowalski, Al..... 10:25
 3rd period—Germany, Schröttle 0:22

Penalties

1st period—Materski, Poland..... 2 min
 Sokolowski, Poland..... 2 min
 2nd period—Heinrich, Germany..... 2 min
 Strobl, Germany..... 2 min
 Heinrich, Germany..... 2 min
 Sokolowski, Poland..... 2 min
 3rd period—Sabinski, Poland..... 2 min
 Kowalski, Al, Poland..... 2 min

Referees

Lou Marsh, Canada
 Donald P Sands, United States

Goal Judges

Clarence Bisson, United States
 William Mace, United States

Timers

Elwood S Kerr, United States
 James T Sutherland, Canada

Penalty Timers

Henry Uihlein, United States
 Edward Gilroy, Canada

United States vs Poland

<i>Stadium</i>	<i>Morning, Feb 5</i>
<i>United States (4)</i>	<i>Poland (1)</i>
Farrell.....G.....	Stogowski
Garrison.....RD.....	Mauer
Anderson.....LD.....	Kowalski, Al
Chase.....C.....	Materski
Everett.....RW.....	Kowalski, Adam
Palmer.....LW.....	Marchewctyk

Spares

Bent	Sokolowski
Cookman	Sabinski
Nelson	Ludwiczak

Score by periods

	1st	2nd	3rd	Total
United States	1	2	1	4
Poland.....	0	0	1	1

Goals

1st period—United States, Bent.....	2:15
2nd period—United States, Cookman	3:15
United States, Cookman.....	10:16
3rd period—Poland, Kowalski, Adam	2:16
United States, Garrison.....	14:55

Penalties

1st period—Garrison, United States.....	2 min
Sokolowski, Poland.....	2 min
2nd period—Marchewczyk, Poland.....	2 min
3rd period—Kowalski, Al, Poland.....	2 min
Ludwiczak, Poland.....	2 min

Referees

Lou Marsh, Canada
Donald P Sands, United States

Goal Judges

Clarence Bisson, United States
William Mace, United States

Timers

Elwood S Kerr, United States
James T Sutherland, Canada

Penalty Timers

Henry Uihlein, United States
Edward Gilroy, Canada

Canada vs Germany

<i>Stadium</i>	<i>Morning, Feb 6</i>
<i>Canada (4)</i>	<i>Germany (1)</i>
Cockburn.....G.....	Leinweber
Sutherland.....RD.....	Heinrich
Henkel.....LD.....	Römer
Monson.....C.....	Ball
Lindquist.....RW.....	Jaenecke
Rivers.....LW.....	Korff

Spares

Simpson	Strobl
Malloy	Slevogt
Wise	Herker

Score by periods

	1st	2nd	3rd	Total
Canada	2	2	0	4
Germany	0	0	1	1

Goals

1st period—Canada, Monson.....	2:02
Canada, Monson.....	14:44
2nd period—Canada, Malloy.....	9:16
Canada, Wise.....	12:37
3rd period—Germany, Herker	13:58

Penalties

1st period—Simpson, Canada.....	2 min
Lindquist, Canada.....	2 min
Heinrich, Germany.....	2 min
2nd period—Hinkel, Canada.....	2 min
Strobl, Germany.....	2 min
Jaenecke, Germany.....	2 min
3rd period—None	

Referees

Lou Marsh, Canada
Donald P Sands, United States

Goal Judges

Clarence Bisson, United States
William Mace, United States

Timers

Elwood S Kerr, United States
James T Sutherland, Canada

Penalty Timers

Henry Uihlein, United States
Edward Gilroy, Canada

Canada vs Poland

Arena *Afternoon, Feb 7*
Canada (9) *Poland (0)*
 Cockburn.....G.....Stogowski
 Sutherland.....RD.....Sokolowski
 Hinkel.....LD.....Kowalski, Al
 Monson.....C.....Sabinski
 Lindquist.....RW.....Kowalski, Adam
 Rivers.....W L.....Marchewczyk

Spares

Wise
 Simpson
 Malloy
 Ludwiczuk
 Materski
 Krygier

Score by periods

	1st	2nd	3rd	Total
Canada	2	5	2	9
Poland	0	0	0	0

Goals

1st period—Canada, Rivers..... 10:45
 Canada, Rivers..... 12:04
 2nd period—Canada, Lindquist..... 3:15
 Canada, Monson..... 3:38
 Canada, Monson..... 12:48
 Canada, Simpson..... 13:54
 Canada, Simpson..... 14:52
 3rd period—Canada, Malloy..... 6:42
 Canada, Hinkel..... 11:59

Penalties

1st period—Sokolowski, Poland..... 2 min
 2nd period—None
 3rd period—Sutherland, Canada..... 2 min
 Simpson, Canada..... 2 min

Referees

Lou Marsh, Canada
 Donald P Sands, United States

Goal Judges

William Mace, United States
 J Bowlf, Canada

Timers

Elwood S Kerr, United States
 James T Sutherland, Canada

Penalty Timers

William Eggens, United States
 Nicholas Meyers, Canada

United States vs Germany

Arena *Evening, Feb 7*
United States (7) *Germany (0)*
 Farrell.....G.....Leinweber
 Frazier.....G.....
 Garrison.....RD.....Heinrich
 Anderson.....LD.....Römer
 Chase.....C.....Ball
 Everett.....RW.....Schröttle
 Palmer.....LW.....Jaenecke

Spares

Bent
 Nelson
 Cookman
 Slevogt
 Strobl
 Korff

Score by periods

	1st	2nd	3rd	Total
United States	3	2	2	7
Germany	0	0	0	0

Goals

1st period—United States, Everett..... :37
 United States, Chase..... :57
 United States, Chase..... 2:38
 2nd period—United States, Nelson..... 4:30
 United States, Palmer..... 14:58
 3rd period—United States, Palmer..... 13:42
 United States, Palmer..... 14:59

Penalties

1st period—Heinrich, Germany..... 2 min
 Heinrich, Germany..... 2 min
 2nd period—Korff, Germany..... 2 min
 Heinrich, Germany..... 2 min
 3rd period—Heinrich, Germany..... 2 min
 Slevogt, Germany..... 2 min
 Anderson, United States..... 5 min

Referees

Lou Marsh, Canada
 Donald P Sands, United States

Goal Judges

Earl Blynn, United States
 Clarence Bisson, United States

Timers

Elwood S Kerr, United States
 James T Sutherland, Canada

Penalty Timers

Henry Uihlein, United States
 William Eggens, United States

United States vs Poland

Stadium *Afternoon, Feb 8*
United States (5) *Poland (0)*
 Farrell.....G.....Stogowski
 Garrison.....RD.....Sokolowski
 Livingston.....LD.....Materski
 Chase.....C.....Sabinski
 Bent.....RW.....Marchewczyk
 Palmer.....LW.....Krygier

Spare

Smith Kowalski, Adam
 Fitzgerald Ludwiczak
 Anderson Kowalski, Al

Score by periods

	1st	2nd	3rd	Total
United States.....	1	1	3	5
Poland	0	0	0	0

Goals

1st period—United States, Smith.. 6:42
 2nd period—United States, Palmer.. 10:07
 3rd period—United States, Palmer.. :57
 United States, Chase.. 3:53
 United States; Anderson..... 9:01

Penalties

1st period—None
 2nd period—None
 3rd period—Fitzgerald, United States. 1 min

Referees

Lou Marsh, Canada
 Donald P Sands, United States

Goal Judges

Clarence Bisson, United States
 Stewart McGillis, Canada

Timers

Elwood S Kerr, United States
 James T Sutherland, Canada

Penalty Timers

Henry Uihlein, United States
 William Eggens, United States

Canada vs Germany

Arena *Evening, Feb 8*
Canada (5) *Germany (0)*
 Cockburn.....G.....Leinweber
 Hinkel RD Heinrich
 Sutherland LD Römer
 Monson. C Ball
 Lindquist RW Schröttle
 Rivers LW Jaenecke

Spare

Garbutt Korff
 Crowley Strobl
 Duncanson Herker

Score by periods

	1st	2nd	3rd	Total
Canada	2	1	2	5
Germany	0	0	0	0

Goals

1st period—Canada, Lindquist 2:44
 Canada, Monson 4:52
 2nd period—Canada, Garbutt 2:46
 3rd period—Canada, Rivers. 5:22
 Canada, Duncanson..... 8:17

Penalties

1st period—None
 2nd period—None
 3rd period—Hinkel, Canada 2 min
 Ball, Canada 1 min

Referees

Lou Marsh, Canada
 Donald P Sands, United States

Goal Judges

Clarence Bisson, United States
 William Mace, United States

Timers

Elwood S Kerr, United States
 James T Sutherland, Canada

Penalty Timers

Henry Uihlein, United States
 Ralph Ury, United States

Canada vs Poland

<i>Stadium</i>	<i>Afternoon, Feb 9</i>
Canada (10)	Poland (0)
Wagner G.	Stogowski
Hinkel RD.	Sokolowski
Sutherland LD.	Kowalski, Al
Monson. C	Krygier
Moore.RW.	Marchewczyk
Rivers.LW.	Sabinski

Spares

Simpson	Materski
Malloy	Kowalski, Adam
Wise	Ludwiczak

Score by periods

	1st	2nd	3rd	Total
Canada.	5	1	4	10
Poland.	0	0	0	0

Goals

1st period—Canada, Monson.	1:52
Canada, Simpson.	6:03
Canada, Rivers.	8:40
Canada, Monson.	8:48
Canada, Malloy.	14:12
2nd period—Canada, Sutherland.	11:11
3rd period—Canada, Simpson.	4:35
Canada, Hinkel	7:51
Canada, Moore.	9:35
Canada, Wise.	13:00

Penalties

1st period—None	
2nd period—None	
3rd period—Sabinski, Poland.2 min
Sabinski, Poland.2 min

Referees

Lou Marsh, Canada
Donald P Sands, United States

Goal Judges

Clarence Bisson, United States
H McInrue, Canada

Timers

Elwood S Kerr, United States
James T Sutherland, Canada

Penalty Timers

Nicholas Meyers, Canada

United States vs Germany

<i>Arena</i>	<i>Afternoon, Feb 10</i>
United States (8)	Germany (0)
Farrell G.	Leinweber
Garrison. RD.	Heinrich
*Hallock. LD.	Römer
Chase. C.	Ball
Everett.RW.	Schröttle
Palmer LW	Jaenecke

Spares

Nelson	Slevogt
Cookman	Korff
Bent	Strobl
Anderson	

Score by periods

	1st	2nd	3rd	Total
United States.	2	2	4	8
Germany.	0	0	0	0

Goals

1st period—United States, Chase.	7:14
United States, Palmer.	14:43
2nd period—United States, Everett.	7:27
United States, Garrison.	10:13
3rd period—United States, Bent.	1:33
United States, Bent.	2:22
United States, Palmer.	6:35
United States, Garrison.	14:15

Penalties

1st period—None	
2nd period—None	
3rd period—Heinrich, Germany	2 min

Referees

Lou Marsh, Canada
Donald P Sands, United States

Goal Judges

Stewart McGillis, Canada
H McInrue, Canada

Timers

Elwood S Kerr, United States
James T Sutherland, Canada

Penalty Timers

Henry Uihlein, United States
Ralph Ury, United States

* By special ruling Hallock, who had been injured in practice, was permitted to participate in one play and retire from the game.

Germany vs Poland

Arena *Morning, Feb 13*
Germany (4) *Poland (1)*
 Leinweber. G. Stogowski
 Heinrich RD. Kowalski, Al
 Römer LD. Sokolowski
 Ball. C. Krygier
 Schröttle W. Sabinski
 Jaenecke LW Kowalski, Adam

Spares

Strobl	Marchewczyk
Korff	Materski
Slevogt	Ludwiczak

Score by periods

	1st	2nd	3rd	Total
Germany.	0	2	2	4
Poland.	0	1	0	1

Goals

1st period—None
 2nd period—Germany, Ball. 5:57
 Poland, Kowalski, Al. 11:40
 Germany, Ball 13:08
 3rd period—Germany, Strobl 2:20
 Germany, Ball 12:15

Penalties

1st period—Sokolowski, Poland. 2 min
 Ball, Germany 5 min
 2nd period—Krygier, Poland. 2 min
 3rd period—Sokolowski, Poland. 2 min
 Jaenecke, Germany. 2 min
 Heinrich, Germany. 2 min

Referees

Lou Marsh, Canada
 Donald P Sands, United States

Goal Judges

Frank Greenleaf, Canada
 Clarence Bisson, United States

Timer

James T Sutherland, Canada

Penalty Timers

Henry Uihlein, United States
 Nicholas Meyers, Canada

United States vs Canada

Arena *Afternoon, Feb 13*
United States (2) *Canada (2)*
 Farrell. G Cockburn
 Garrison RD. Sutherland
 Anderson LD Hinkel
 Chase. C. Monson
 Everett RW. Lindquist
 Palmer. LW. Rivers

Spares

Cookman	Simpson
Nelson	Malloy
Bent	Wise

Score by periods

	1st	2nd	3rd	Total*
United States.	1	1	0	2
Canada.	1	0	1	2

} Tie

* Three overtime periods played without scoring.

Goals

1st period—United States, Everett 2:17
 Canada, Simpson. 9:47
 2nd period—United States, Palmer 13:38
 3rd period—Canada, Rivers 14:10

Penalties

1st period—Garrison, United States 2 min
 2nd period—Nelson, United States 2 min
 Simpson, Canada 2 min
 Malloy, Canada. 2 min
 3rd period—Hinkel, Canada 2 min
 Garrison, United States. 2 min
 Monson, Canada. 2 min
 1st overtime period—None
 2nd overtime period—Monson, Canada 1 min
 Chase, United States. 1 min
 3rd overtime period—None

Referees

Lou Marsh, Canada
 Donald P Sands, United States

Goal Judges

Clarence Bisson, United States
 J Bowlf, Canada

Timers

Elwood S Kerr, United States
 James T Sutherland, Canada

Penalty Timers

Henry Uihlein, United States
 Nicholas Meyers, Canada

RESULTS
Summary of Olympic Hockey Results

	Canada	Germany	Poland	United States	Won	Lost	Tie	Points
Canada		4 : 1	9 : 0	2 : 1	5	0	1	11
		5 : 0	10 : 0	2 : 2				
Germany	1 : 4		2 : 1	0 : 7	2	4		4
	0 : 5		4 : 1	0 : 8				
Poland	0 : 9	1 : 2		1 : 4	0	6		0
	0 : 10	1 : 4		0 : 5				
United States . .	1 : 2	7 : 0	4 : 1		4	1	1	9
	2 : 2	8 : 0	5 : 0					



—Wide World

THE OLYMPIC CHAMPIONS

Winning Canadian hockey team, undefeated in Olympic series. *Left to right, kneeling:* Coach Hughes, Lindquist, Rivers, Monson, Malloy. *Left to right, standing:* Duncanson, Hinkel, Cockburn, Simpson, Wagner, Sutherland, Wise



—*International Newsreel*

Stogowski, Polish goalie, gives Bent, United States forward, a spill in front of the cage in the first match between Poland and the United States, the latter winning 4-1



—*Wide World*

Poland's hockey team. *Left to right, kneeling:* Mauer, Adam Kowalski, Ludwiczak. *Standing, left to right:* Polakiewicz (member technical advisory committee), Aleksander Kowalski, Sokolowski, Sabinski, Stogowski, Marchewczyk, Krygier, and Sachs

EXHIBITION GAMES

McGill University vs Canada

Stadium *Afternoon, Feb 5*
McGill University (2) *Canada (0)*
Powers.....G.....Wagner
McGillivray.....RD.....Hinkel
McTeer.....LD.....Wooley
Crutchfield, N.....C.....Monson
Griffin.....RW.....Crowley
Ward.....LW.....Duncanson

Spares

Farguaharson	Sutherland
Crutchfield, G	Simpson
McGill	Garbutt
Farmer	Wise
Robertson	Malloy
Riddle	Moore

Score by periods

	1st	2nd	3rd	Total
McGill University.....	2	0	0	2
Canada	0	0	0	0

Goals

1st period—
McGill University, Crutchfield, N 5:05
McGill University, Crutchfield, N 14:50
2nd period—None
3rd period—None

Penalties

1st period—Malloy, Canada.2 min
Hinkel, Canada.2 min
2nd period—Wooley, Canada.2 min
3rd period—Ward, McGill University. . . .2 min

Referees

Donald P Sands, United States
William Mace, United States

Goal Judges

J Bowlf, Canada
Clarence Bisson, United States

Timers

Elwood S Kerr, United States
James T Sutherland, Canada

Penalty Timers

Henry Uihlein, United States
Nicholas Meyers, Canada

Lake Placid Athletic Club vs Germany

Arena *Evening, Feb 5*
Lake Placid A C (5) *Germany (0)*
Granger.....G.....McHugh
Ryan.....RD.....Heinrich
McGillis.....LD.....Römer
Priestley.....C.....Ball
Berger.....RW.....Jaenecke
Proulx.....LW.....McInrue

Spares

Percival	Strobl
Jacobs	Korff
Verdun	Schröttele
Schultz	Maxwell
Moreau	
Hulquist	

Score by periods

	1st	2nd	3rd	Total
Lake Placid A C	1	2	2	5
Germany.	0	0	0	0

Goals

1st period—Lake Placid AC, Verdun 7:27
2nd period—Lake Placid A C, Verdun 8:18
Lake Placid A C, Hulquist 14:40
3rd period—Lake Placid A C, Verdun 12:04
Lake Placid A C, Verdun 14:21

Penalties

1st period—Ball, Germany.2 min
Percival, Lake Placid A C 2 min
2nd period—Priestley, Lake Placid A C 2 min
Römer, Germany2 min
Heinrich, Germany2 min
3rd period—Heinrich, Germany.2 min
McInrue, Germany2 min
Heinrich, Germany2 min

Referee

Donald P Sands, United States

Goal Judges

William Mace, United States
William Timmons, United States

Timers

James P Sutherland, Canada
Elwood S Kerr, United States

Penalty Timer

Henry Uihlein, United States

Note: Several players on the German team in this game were lent by other teams.

McGill University vs United States

Arena *Afternoon, Feb 6*
 McGill University (2) *United States (1)*
 Powers G Farrell
 McTeer RD Garrison
 McGillivray. LD. Fitzgerald
 Farmer. C. Chase
 Ward RW Everett
 Farguaharson. LW. Palmer

Spares

Crutchfield, N	Nelson
Crutchfield, G	Cookman
McGill	Bent
Robertson	Livingston
Riddle	Smith

Score by periods

	1st	2nd	3rd	Total
McGill University.	1	1	0	2
United States	0	1	0	1

Goals

1st period—McGill Univ., McGill 4:53
 2nd period—
 McGill University, Crutchfield, G . . . 2:09
 United States, Garrison 7:51
 3rd period—None

Penalties

1st period—
 Crutchfield, G, McGill University..2 min
 2nd period—
 Crutchfield, N, McGill University..2 min
 3rd period—
 Bent, United States 2 min
 Fitzgerald, United States 2 min
 Crutchfield, N, McGill University 2 min
 Riddle, McGill University 2 min

Referee

Donald P Sands, United States

Goal Judges

William Mace, United States
 Clarence Bisson, United States

Timers

James T Sutherland, Canada
 Elwood S Kerr, United States

Penalty Timers

Edward Gilroy, Canada
 Henry Uihlein, United States

Lake Placid Athletic Club vs Poland

Arena *Evening, Feb 6*
 Lake Placid A C (6) *Poland (2)*
 Granger G McHugh
 Ryan. RD. Mauer
 McGillis. L D. McInrue
 Priestley C. Materski
 Berger. RW. Marchewczyk
 Proulx LW Kowalski, Adam

Spares

Moreau	Jacobs
Hulquist	Sabinski
Percival	Maxwell
Verdun	Ludwiczak
Schultz	

Score by periods

	1st	2nd	3rd	Total
Lake Placid A C	0	4	2	6
Poland	0	1	1	2

Goals

1st period—None
 2nd period—Lake Placid A C, Berger :35
 Lake Placid A C, Berger 1:20
 Lake Placid A C, McGillis. 4:55
 Lake Placid A C, Schultz 9:07
 Poland, Sabinski. 9:15
 3rd period—Lake Placid A C, Proulx 4:54
 Lake Placid A C, Verdun 8:20
 Poland, Kowalski, Adam 11:53

Penalties

1st period—Mauer, Poland 2 min
 2nd period—Maxwell, Poland 2 min
 Percival, Lake Placid A C . . . 2 min
 Priestley, Lake Placid A C . . . 2 min
 3rd period—McInrue, Poland 2 min
 Sabinski, Poland 2 min
 Jacobs, Poland 2 min
 Verdun, Lake Placid A C . . . 2 min

Referee

Donald P Sands, United States

Goal Judges

William Mace, United States
 Clarence Bisson, United States

Timers

James T Sutherland, Canada
 Elwood S Kerr, United States

Penalty Timers

Edward A Gilroy, Canada
 Henry Uihlein, United States

Note: Several players on the Polish team in this game were lent by other teams.

Canada-United States vs Lake Placid A C

Arena *Evening, Feb 11*
Canada-United States (3) *Lake Placid A C (2)*

CockburnG.Granger
 (Canada)
 Wagner G
 (Canada)
 Fitzgerald. RD Moreau
 (United States)
 Livingston. LD. McGillis
 (United States)
 Monson. C. Priestley
 (Canada)
 Smith RW. Berger
 (United States)
 Duncanson LW. Proulx
 (Canada)

Spare

Wooley (Canada)	Ryan
Garbutt (Canada)	Hulquist
Moore (Canada)	Verdun
Crowley (Canada)	Percival
	Jacobs
	Schultz

Score by periods

	Overtime			
	1st	2nd	3rd	period Total
Canada-United States.	1	1	0	1 3
Lake Placid A C	1	0	1	0 2

Goals

1st period—Lake Placid A C, Berger 3:35
 Canada-United States, Moore. 14:02

2nd period—Canada-United States, Garbutt.. 4:16
 3rd period—Lake Placid A C, Hulquist.....13:27
 Overtime period—
 Canada-United States, Monson. 9:20

Penalties

1st period—Wooley, Canada-United States..2 min
 2nd period—
 Garbutt, Canada-United States 1 min
 Fitzgerald, Canada-United States . . . 2 min
 Schultz, Lake Placid A C 2 min
 3rd period—Smith, Canada-United States . . . 2 min
 Berger, Lake Placid A C 2 min
 Berger, Lake Placid A C 2 min
 Monson, Canada-United States..2 min
 Verdun, Lake Placid A C 2 min
 Overtime period—
 Monson, Canada-United States..2 min
 Berger, Lake Placid A C Match
 Moore, Canada-United States..Match
 Wooley, Canada-United States..2 min

Referees

Clarence Bisson, United States
 Donald P Sands, United States

Goal Judges

William Timmons, United States
 Philip Proctor, United States

Timers

Elwood S Kerr, United States
 James T Sutherland, Canada

Penalty Timers

Henry Uihlein, United States
 Ralph Ury, United States



—Pierson Studio

Snowed-in



—*International Newsreel*

Captain Werner Zahn of the German bobsled team, 1931 world's champion, presenting the Martineau challenge cup, emblematic of the world's bob championship, to William Fiske, driver of the United States team No 1. The cup was put in the competition by Hubert Martineau of England, president of the bobsled club of St Moritz



—*International Newsreel*

United States team No 2, rounding Shady Corner. This team won second place in the Olympic 4-man bobsleigh competition. Members of the team: Henry A Homburger, driver, Percy D Bryant, F Paul Stevens, Edmund C Horton, brakeman

Bobsleigh

At the time of the III Olympic Winter Games the sport of bobsledding, as enjoyed on a run engineered to international specifications, was only a little over a year old in the United States. Yet it certainly proved to be a lusty infant. As a matter of fact it attained adult stature the year before the Games, when the Mt Van Hoevenberg slide at Lake Placid was completed and opened for public riding and racing.

Of course, it must be borne in mind that for generations American youth had ridden sleds down snow and ice-covered hills. But the sport, as indulged in abroad on graded runs with high bank turns, is new to this country.

During the winter of 1930-31 a world's speed record for a major bob slide was made by an American team on the Lake Placid run. Interest in bobsledding ran high all that season, and the enthusiasm carried over into the Olympic winter and increast beyond even the most optimistic forecasts.

Proof of the way in which this great sport of bobsledding has gript the American public is found in the figures for attendance on the first day of four-man racing during the III Olympic Winter Games, February 14. Approximately 14,000 thrilled that day to the breath-taking performances of the greatest bobsledders in the world.

An idea of how much this figure exceeded the es-

timates planned on for the Games is seen by noting that at the Olympic stadium total capacity, including standing-room, was only 7,475. Incidentally the stadium was never completely filled at any of the events scheduled for it.

This brief preface to the report of the Olympic bob races is given in order that the reader may realize what it meant for Lake



—*International Newsreel*

United States 2-man bob team, winner of the Olympic title. Two Lake Placid brothers comprise the team: J Hubert Stevens, driver; Curtis Stevens, brakeman

Placid and the United States to have the Olympic bobsled contests the unqualified success they proved to be. Two years before, Lake Placid had no run, and the United States practically no bobsledders. The sport, however, had hundreds of devotees in Europe, where it has been enjoyed for over 35 years and where thousands view the races annually on the different slides. But the III Olympic Winter Games at Lake Placid offered a program of bob sport and a course on which it could be enjoyed that appealed not alone to 14,000 spectators on one day, but with equal force to the veteran European drivers competing.

Bobsledding has now "arrived" as one of the favorite winter sports in America—certainly the most thrilling, with many new and peculiar thrills all its own.

A detailed description of the Mt Van Hoevenberg run will be found in the section of this book devoted to *Olympic Facilities*.

Impressive Entry List

It was evident months before the Games began that there would be a large, and representative entry list in the bob races. This expectation was fully realized. Eight nations had representatives in the two and four-man races. 28 teams entered the two bob events, and 19 raced—a truly impressive list.

The entry list at Lake Placid also contained the world's champion four-man pilot, the winners of the first three places in the bob races at the II Olympic Winter Games at St Moritz in 1928, and the 4-man team which established the world's speed record on the Mt Van Hoevenberg run the preceding winter.

As soon as the run was put in condition in December teams began to arrive, eager to get out and test their ability on the great iced track whose fame had begun to carry around the world. During January, weather conditions were far from ideal, but practice went on steadily when the slide could be kept in condition.

The pre-Olympic practice period was marred somewhat by accidents to seven members of the German squad, several of whom were first to spend time in the hospital.

Fortunately the German racers were not seriously injured, and they were all able to leave Lake Placid with their team-mates. The accident, however, was a blow to the German hopes in the Olympic events and made it necessary for another team to be entered from that country just before the Games by a special ruling of the International Olympic Committee.

Proof that the construction of the track was technically correct is found in the fact that a crew of two riders were thrown from their sled at Shady Corner, and the sled finished riderless but without tipping over, negotiating the remaining curves on the run as safely as tho piloted by an expert steersman.

European drivers were loud in their praises of the design and construction of the Mt Van Hoevenberg slide and the superlative test of skill that it afforded.

The Races

There were two events on the Olympic bobsled program, the two-man (boblet) and four-man races, each divided into four heats, two being run on one day. As a result of this schedule four days of racing were offered.

Weather conditions made it necessary to shift the two-man races, originally scheduled for Feb 8 and 9, to Feb 9 and 10, a raging blizzard making it impossible to use the run on Feb 8. The four-man events, on the program for Feb 11 and 12, were run off on Feb 14 and 15. These changes were sanctioned by the International Olympic Committee.

Total time for four heats determined place for the bobsled teams, the timing being done by an electrical device that registered minutes, seconds, and hundredths of a second. At the finish, each sled broke a thread which operated the mechanism that stamped the total time from the top on a tape. Only one sled at a time goes down a bob-run. No sled may start until "Clear Track" is reported back to the top from the intermediate telephone booths and from the finish.

Spectators filled the grandstands at the major curves on the run, while others

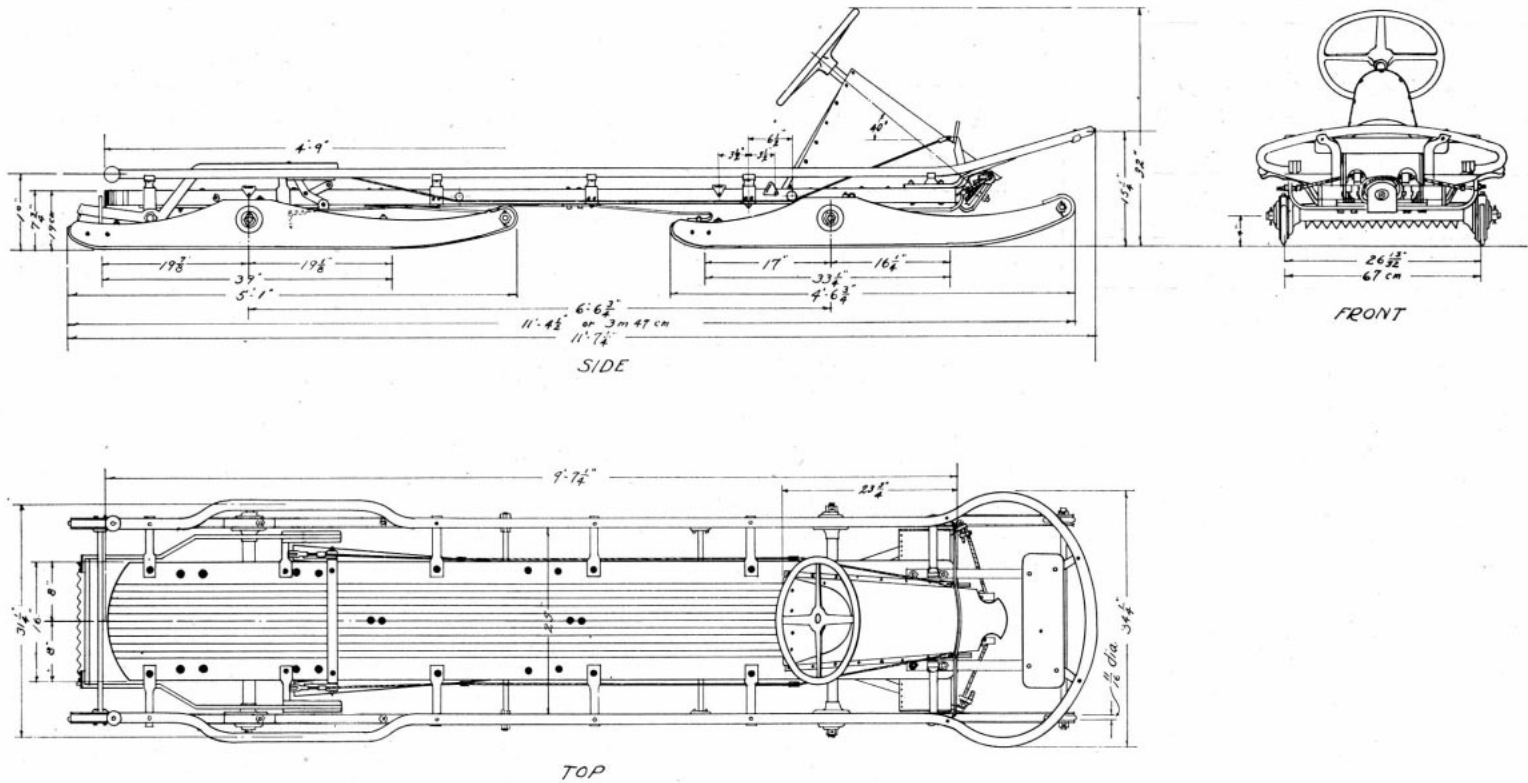

Approximate Weight Complete	478 Lbs. or 218 Kg
" " of Foot Brakes	36 Lbs.
" " of Hand Brakes	17 Lbs.
" " of Cushion	17 Lbs.

Revised May 5, 1930
 FOUR-MAN BOB-SLED
 FOR III OLYMPIC WINTER GAMES
 SCALE 1 1/2" = 1' 0"
 MAY 23, 1930
 SHEET #1 of 8

Drawing of 4-man bobsled

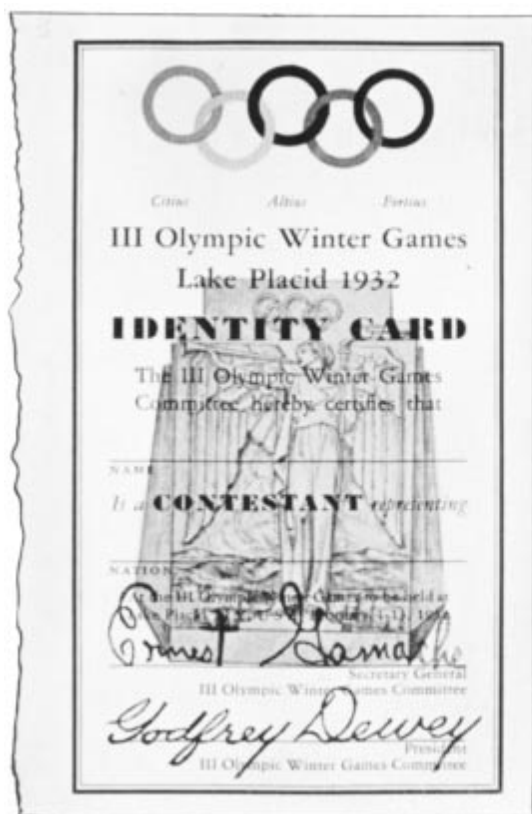

Front of III O W G Identity Card



Inside of III O W G Identity Card

crowded along the course at the best vantage points. Large score-boards were erected by the grandstands and at the finish where times of the various teams were recorded as soon as the sleds had past each of the five intermediate timing-stations. The progress of each sled was reported up and down the length of the run by means of the public-address system, the announcer's voice carrying through loudspeaker horns at the clubhouse and the various stands. The announcer, stationed in a special booth at the foot of the run, received his reports by telephone from the observers in the five intermediate timing-stations.

Spectators watched the score-boards and cheered their favorites during the progress of each heat. Final times, of course, and eventual place-winners were not known until the conclusion of the four heats for each event.

Fight for First

An idea of the closeness of the competition is gained from a study of the summaries

that follow. Less than two seconds separated the first two teams in the two-man event, while the first two four-man sleds across the line were only two and two-hundredths seconds apart. Definite places in most instances were not known until the final heat had been run.

Some of the teams used bobs of foreign design and manufacture, but the majority, including most of the European entries, rode the American-designed and American-built sleds that were supplied by the Organizing Committee.

Average temperatures during the four days of racing were:

Feb 9—13 degrees Centigrade (8 above zero Fahrenheit)

Feb 10—2 degrees Centigrade (28 above zero Fahrenheit)

Feb 14—7 degrees Centigrade (19 above zero Fahrenheit)

Feb 15—8 degrees Centigrade (18 above zero Fahrenheit)

Governing Bodies and Officials

International Federation of Bobsleigh and Tobogganing

President—Renaud de la Frégéolière, Paris, France

Amateur Athletic Union of the United States

President—Avery Brundage, Chicago, Illinois

Technical Committee

Erwin Hachmann, Germany

Daniel Ferris, United States

Albert Mayer, Switzerland

Harry de Pauer, Austria

D W Trovati, Italy

Officials

Starting Judge

Albert Mayer, Switzerland

Chief Timer

Erwin Hachmann, Germany

Timers

Daniel Ferris, United States

Ross Thompson, United States

D W Trovati, Italy

Henry Uihlein, United States

Clerk of Equipment

Harry de Pauer, Austria

Events and Rules

Dates of contests: Feb 9, 10, 14, and 15.

Bobsleigh competitions consisted of two events:

4-man Bob and 2-man Bob.

Maximum number of entries:

4-man Bob: 3 teams of 5 men each per nation.

2-man Bob: 3 teams of 3 men each per nation.

Maximum number of contestants:

4-man Bob: 2 teams of 4 men each per nation.

2-man Bob: 2 teams of 2 men each per nation.

Drawings

4-man Bob: Drawings for starting order were made in the presence of the technical committee on the evening of Feb 10 by the representatives of the countries taking part.

Starting order:

First heat, Nos 1 to 7.

Second heat, Nos 5 to 7 and 1 to 4.

Third heat, Nos 7 to 1.

Fourth heat, Nos 4 to 1 and 7 to 5.

2-man Bob: Drawings for starting order were made in the presence of the technical committee on the evening of Feb 7 by the representatives of the countries taking part.

Starting order:

First heat, Nos 1 to 12.

Second heat, Nos 7 to 12 and 1 to 6

Third heat, Nos 12 to 1.

Fourth heat, Nos 6 to 1 and 12 to 7.



—Wide World

Third-place winner in the Olympic 4-man bob event, the German team No 1: Hanns Kilian, driver, Max Ludwig, Dr Hans Mehlhorn, and Sebastian Huber, brakesman

4-MAN BOBS

Entries including reserves

Number of nations entered	6
Number of teams entered	13
Number of individuals entered	60
Number of contestants	28

Belgium

Houben, Max
Maus, Jacques
Van Hege, Louis
Hansez, Christian William
Marin, Theo

Germany

Zahn, Werner
Huth, Werner
Rossner, Heinrich
Mehlhorn, Dr Hans

Grau, Fritz
Ludwig, Max
Hopmann, Helmut
Brehme, Albert

Kilian, Hanns
Huber, Sebastian
Krotki, Rudolf

*von Mumm, Walther
*von Bismarck, Hasso
*Hessert, Baron G
*Gyssling, D Georg

Italy

Rossi di Montelera, Count
Lanfranchi, Agostino
Lanfranchi, Gaetano
Casini, Italo
Crivelli, Giuseppe

Roumania

Papana, Lieut Alexandru
Ionescu, Capt Alexandru
Petrescu, Lieut Ulysse
Hubert, Capt Dumitru
Roman, Commander Horia

Switzerland

Unger, Donald
Fonjallaz, Gustave
Stauffer, William
Fonjallaz, René
Kloetta, Antoine

Capadrutt, Reto
Eisenhut, Hans
Jenny, Charles
Geier, Oscar
Buchheim, Nicolas

Jost, Werner
Brupbacher, Max
Fonjallaz, Gaston
Wanger, Jules
Neuman, Werner

United States

Fiske, William L
Eagan, Edward F
Gray, Clifford B
O'Brien, Jay
Stevens, J Hubert

Homburger, Henry A
Bryant, Percy D
Stevens, F Paul
Horton, Edmund C
Martin, Harry G

Goodrich, Hunter
Ashforth, Albert
Lipson, Howard S
Hackney, Clement
Stevens, Curtis P

* Because of injuries to members of German bobsleigh teams, these men⁷ were permitted to enter as a second German team by authority of the International Olympic Committee.



—Roger L. Moore

William L. Fiske, U S A

4-MAN BOBS

Mt Van Hoevenberg Bob-run

Heats 1 and 2—Morning, Feb 14

Heats 3 and 4—Morning, Feb 15

Results

	<i>Heat 1</i>	<i>Heat 2</i>	<i>Time Score</i> <i>Sub-</i> <i>total</i>	<i>Heat 3</i>	<i>Heat 4</i>	<i>Total</i>
1 United States—Team 1 William L Fiske, Driver Edward F Eagan Clifford B Gray Jay O'Brien	2:00.52	1:59.16	3:59.68	1:57.41	1:56.59	7:53.68
2 United States—Team 2 Henry A Homburger, Driver Percy D Bryant F Paul Stevens Edmund C Horton	2:01.77	2:01.09	4:02.86	1:58.56	1:54.28	7:55.70
3 Germany—Team 1 Hanns Kilian, Driver Max Ludwig Dr Hans Mehlhorn Sebastian Huber	2:03.11	2:01.34	4:04.45	1:58.19	1:57.40	8:00.04
4 Switzerland—Team 2 Reto Capadrutt, Driver Hans Eisenhut Charles Jenny Oscar Geier	2:06.81	2:03.40	4:10.21	2:01.47	2:00.50	8:12.18
5 Italy Count Rossi di Montelera, Driver Agostino Lanfranchi Gaetano Lanfranchi Italo Casini	2:07.87	2:06.62	4:14.49	2:07.94	2:01.78	8:24.21
6 Roumania Lieut Al Papana, Driver Capt Al Ionescu Lieut Ulysse Petrescu Capt Dumitru Hubert	2:09.09	2:14.32	4:23.41	2:02.00	1:58.81	8:24.22
7 Germany—Team 2 Walther von Mumm, Driver Hasso von Bismarck Baron G Hessert D Georg Gyssling	2:11.59	2:11.72	4:23.31	2:07.89	2:04.25	8:35.45

2-MAN BOBS

Entries including reserves

Number of nations entered. 8
Number of teams entered. 15
Number of individuals entered. 41
Number of contestants. 24

Austria

Weinstengel, Hugo
Gudenus, Count Johann Baptist

Belgium

Houben, Max
Van Hege, Louis
Hansez, Christian William
Maus, Jacques
Marin, Theo

France

Balsan, Louis
Delille, Armand

Germany

Kilian, Hanns
Huber, Sebastian
Mehlhorn, Dr Hans
Huth, Werner
Ludwig, Max
Zahn, Werner
*von Mumm, Walther

Italy

Rossi di Montelera, Count
Casini, Italo
Lanfranchi, Agostino
Lanfranchi, Gaetano
Crivelli, Giuseppe

Roumania

Papana, Lieut Alexandru
Hubert, Capt Dumitru
Roman, Commander Horia

Switzerland

Fonjallaz, René
Fonjallaz, Gustave
Fonjallaz, Gaston
Capadrutt, Reto
Geier, Oscar
Stauffer, William
Kloetta, Antoine
Jenny, Charles

United States

Stevens, J Hubert
Adams, Arthur
Stevens, Curtis P
Heaton, John R
Minton, Robert H
Stevens, Raymond F
Homburger, Henry A
Bryant, Percy D
Martin, Harry G

* Because of injuries to members of German bobsleigh teams, von Mumm was permitted to enter as reserve on this team by authority of the International Olympic Committee.



Crowd at the finish line, Mt Van Hoevenberg bobsled run

—G Cleveland



J H Stevens, U S A ^{—Stedman}

2-MAN BOBS

Mt Van Hoevenberg Bob-run

Heats 1 and 2—Morning, Feb 9

Heats 3 and 4—Morning, Feb 10

		Results		Time Score			
		Heat 1	Heat 2	Sub-total	Heat 3	Heat 4	Total
1	United States—Team 1 J Hubert Stevens, Driver Curtis P Stevens	2:13.10	2:04.27	4:17.37	1:59.69	1:57.68	8:14.74
2	Switzerland—Team 2 Reto Capadrutt, Driver Oscar Geier	2:05.88	2:07.21	4:13.09	2:03.52	1:59.67	8:16.28
3	United States—Team 2 John R Heaton, Driver Robert H Minton	2:15.02	2:07.51	4:22.53	2:04.29	2:02.33	8:29.15
4	Roumania Lieut Al Papana, Driver Capt Dumitru Hubert	2:15.51	2:07.82	4:23.33	2:06.12	2:03.02	8:32.47
5	Germany—Team 1 Hanns Kilian, Driver Sebastian Huber	2:15.27	2:11.08	4:26.35	2:05.82	2:03.19	8:35.36
6	Italy—Team 1 Count Rossi di Montelera, Driver Italo Casini	2:15.45	2:08.10	4:23.55	2:06.58	2:06.20	8:36.33
7	Germany—Team 2 Werner Huth, Driver Max Ludwig	2:11.53	2:11.58	4:23.11	2:11.32	2:10.62	8:45.05
8	Italy—Team 2 Agostini Lanfranchi, Driver Gaetano Lanfranchi	2:20.08	2:13.47	4:33.55	2:08	2:09.11	8:50.66
9	Belgium—Team 1 Max Houben, Driver Louis Van Hege	2:17.68	2:14.90	4:32.58	2:10.90	2:09.62	8:53.10
10	Belgium—Team 2 Christian Hansez, Driver Jacques Maus	2:17.01	2:16.74	4:33.75	2:13.59	2:13.81	9:01.15
11	France Louis Balsan, Driver Armand Delille	2:20.10	2:19.37	4:39.47	2:13.56	2:09.56	9:02.59
12	Austria Hugo Weinstengel, Driver Count Johann Baptist Gudenus	2:23.83	2:21.82	4:45.65	2:16.19	2:14.58	9:16.42

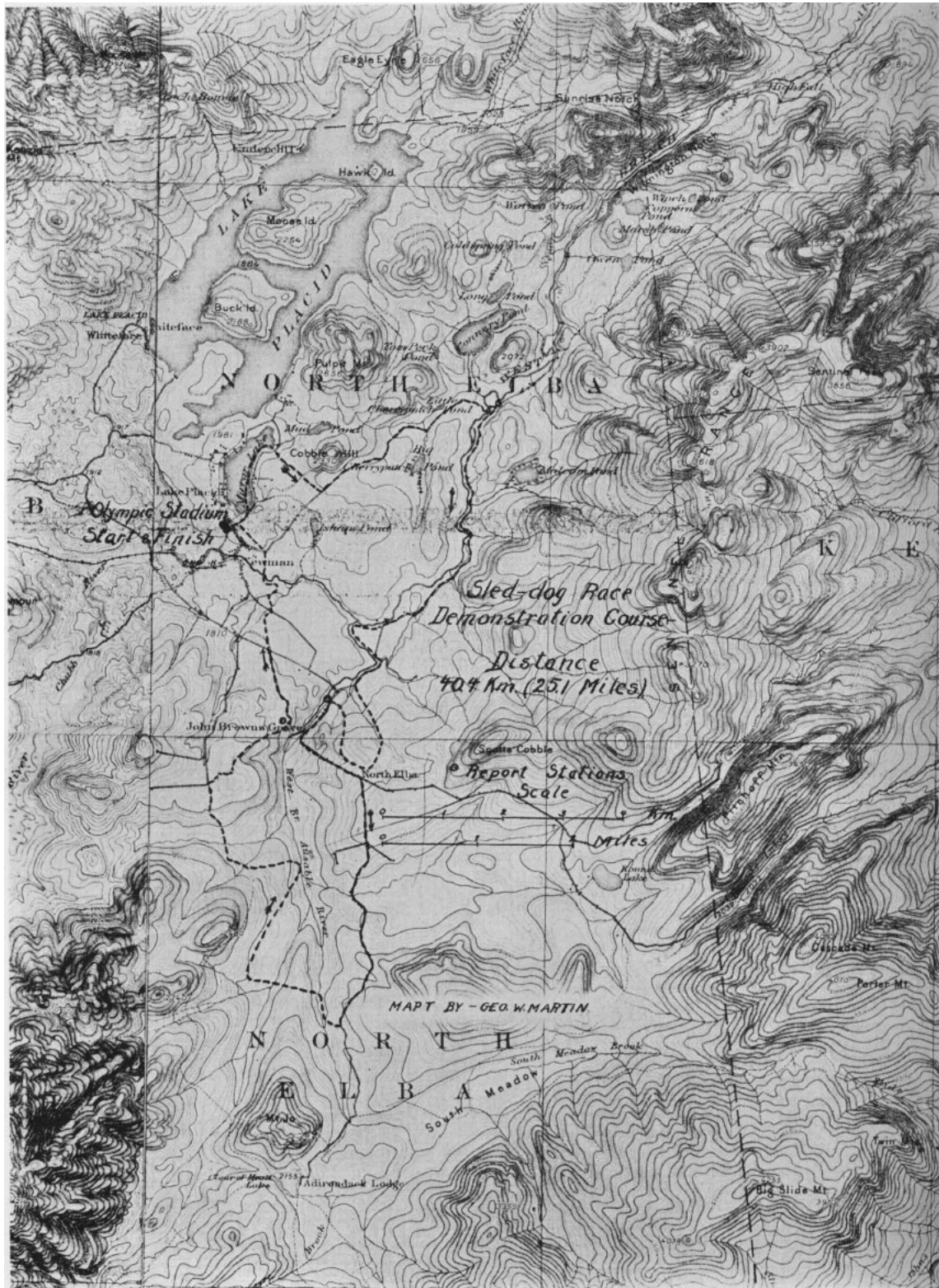

Contour map of Lake Placid section showing sled-dog race course

III Olympic Winter Games Demonstrations

Sled Dog Race

Under international Olympic rules the Organizing Committee is permitted to stage demonstrations of sports not on the official Olympic program. One should be a sport peculiar to the country holding the Games, and another should be a sport foreign to the Organizing Country.

Sled-dog racing, as a sport indigenous to the United States and the North American continent, was, therefore, approved by the International Olympic Committee as one of the demonstrations at the III Olympic Winter Games. This was the first time that sled-dog racing had appeared on an Olympic demonstration program. Winter travel by dog team in the northeastern snow belt of the United States, in Canada, and in Alaska is both a sport and a measure of necessity when all other means of getting across the frozen wastes of snow fail. In the Far North, dog teams carry mail and freight and follow regular routes and schedules.

A team usually consists of seven dogs, six harness in pairs for racing and a lead dog ahead. This was the type of team driven in the Olympic demonstration races. Each team hauled a typical dog-sled, on which the driver could ride or behind which he could run, as occasion might demand. For ordinary travel the dogs are frequently driven 7 in a row.

Many American and Canadian sportsmen are interested in the raising and racing of sled dogs, Siberian, Alaskan, or Labrador breeds, the best racing teams usually being cross-bred. Dog derbies have for years been a picturesque part of the winter-sports life of Lake Placid, and the Olympic demonstration derby was one of the most picturesque and interesting events on the entire program.

13 crack drivers of the United States and Canada were entered in the sled-dog demonstration, including former winners of famous Canadian, Alaskan, and American derbies and the driver of the team that brought the serum to stricken Nome, Alaska, at the time

of the diphtheria epidemic there a few years ago. One woman driver "musht" her own huskies twice around the gruelling 25-mile course. Teams had been in Lake Placid for weeks prior to the race training for the big tests. Dogs and drivers alike were on edge for the starter's gun and hoped-for Olympic laurels.

Arrangements for staging the race were in charge of a Dog Derby Organizing Committee, of which Walter Channing of Boston was chairman.

Course Covered Twice

The race was run on two days, Saturday and Sunday, February 6 and 7, under the rules of the New England Sled Dog Club, Inc. These rules required the same course, to be covered on two successive days, the total time for the two days to decide the placing. The route for the race, as approved



—*International Newsreel*
Leonard Seppala, veteran Alaskan musher, with his lead dogs. Seppala placed second in the Olympic sled-dog demonstration race

by the committee, measured 25.1 miles (approximately 40.5 kilometers). It was laid out along state and county roads and bridle paths, all of which lent themselves excellently to travel by dog team.

The trails were not covered with the usual heavy February snow, because of the extraordinary weather conditions prevailing, and the drivers, in their efforts to win, made a gruelling test of the race. So did their dogs. Some of them gave up and were carried in on the sleds of their masters. According to the rules every dog starting must return to the starting point, either on his feet or on the sled. One driver collapsed just as he crossed the finish line. On the other hand the winning team came thru in excellent condition on the final day of racing, as did several of the others.

Crowds thronged the space at the finish line and strung out along the 25-mile trail to watch the racers. (See map for details of the course.)

Start of the sled-dog race was at the

Olympic stadium. From there the course went north to Mirror lake; by way of Northwood road to Wilmington road; left to River road and along River road to Mid-rivers farm; along bridle path to right and return to River road at Intervales farm; along River road about a half-mile, turning left on Bolderwood bridle path loop; coming out on Cascade road 150 yards south of Ski T; left on Cascade road to Adirondack Lodge road, to a point $\frac{1}{4}$ of a mile beyond Alcohol brook; right along bridle path to Tablelands farm; to John Brown's farm; and along bridle path across Cascade road and return to stadium.

Intermediate times were communicated from the following points and recorded on bulletin boards in the stadium and in press headquarters at the high school:

Concrete bridge on Wilmington road,
4 miles from start
Ski T, 10.6 miles from start
John Brown's farm, 22.46 miles from
start



—*International Newreel*

Roger Haines, U S A, fifth-place winner in Olympic demonstration sled-dog race

Governing Bodies and Officials

New England Sled Dog Club, Inc
 President-Moseley Taylor, Boston, Mass
Demonstration Dog Derby Committee
 Walter Channing, Chairman, United States
 Louis D Hudon, Secretary, Canada
 Captain C A Billings, Canada
 Henry Stetson, United States
 J Hubert Stevens, United States
 Moseley Taylor, United States

Officials

Judges
 Walter Channing, United States
 Henry Stetson, United States
 J Hubert Stevens, United States
Timers
 Henry Stetson, United States
 Walter Channing, United States
 Francis D'Olier, United States
 Major Philip Fleming, United States
 Ross Thompson, United States

Chief of Course
 George W Martin, United States
Assistant Chief of Course
 Sherwood Ernenwein, United States

Events and Rules

Dates of contests: Feb 6 and 7.
 Competition consisted of going around 25.1-mile (approximately 40.5-kilometer) course on two successive days, the total time for the two days' racing determining place. The team covering the entire course in the least total time was declared the winner.

Drawings

Drawings for starting order were made in the presence of the Demonstration Dog Derby Committee on the evening of February 5 by drivers taking part or their representatives.
 Starting order was reverst on the second day of the race.

SLED DOG RACE

Demonstration

Entries

Number of nations entered 2
 Number of individuals entered 13
 Number of contestants 12

		<i>Canada</i>		<i>Bunnell, Earl</i>	
<i>Drivers</i>		<i>Owners</i>			Bunnell, Earl Colebrook, N H
	<i>Defalco, Jack</i>	Defalco, Jack Ottawa, Ont		<i>Haines, Roger</i>	Taylor, Moseley Boston, Mass
	<i>Pouliot, Raymond</i>	Marquis, Rodolphe Quebec, P Q		<i>Murphy, Henry</i>	McIlhenny, Jr, J,D Philadelphia, Pa
	<i>Russick, Shorty</i>	Russick, Shorty Flin Flon, Manitoba		<i>Sears, Dexter</i>	d'Avignon, Dr F J Lake Placid, N Y
	<i>St Goddard, Emile</i>	St Goddard, Emile The Pas, Manitoba		<i>Seeley, Mrs Milton</i>	Seeley, Mrs Milton Wonalancet, N H
		<i>United States</i>		<i>Seppala, Leonard</i>	Seppala, Leonard St Jovite Station, P Q
<i>Drivers</i>		<i>Owners</i>		<i>Vaughan, Norman</i>	Seeley, Mrs Milton Wonalancet, N H
	<i>Belknap, Stuart</i>	Belknap, Stuart Keene, N Y			

SLED DOG RACE

Afternoon, Feb 6 Afternoon, Feb 7

Results

Contestants started at three-minute intervals.

<i>Driver</i>	<i>Country</i>	<i>Owner</i>	First Race	Second Race	Total
			Hrs Min Sec	Hrs Min Sec	Hrs Min Sec
<i>St Goddard</i>	Canada	St Goddard	2:12: 5	2:11: 7.5	4:23:12.5
<i>Seppala</i>	United States	Seppala	2:13:34.3	2:17:27.5	4:31: 1.8
<i>Russick</i>	Canada	Russick	2:26:22.4	2:21:22.2	4:47:44.6
<i>Wheeler</i>	Canada	Wheeler	2:33:19.1	2:29:35	5:02:54.1
<i>Haines</i>	United States	Taylor	2:34:56	2:31:31.3	5:06:27.3
<i>Pouliot</i>	Canada	Marquis	2:53:14.3	2:52:21.5	5:45:35.8
<i>Defalco</i>	Canada	Defalco	2:53:49.5	2:55:50.1	5:49:39.6
<i>Belknap</i>	United States	Belknap	2:57:14	2:57: 8.5	5:54:22.5
<i>Murphy</i>	United States	McIlhenny	2:42:49.4	3:15:24.1	5:58:13.5
<i>Sears</i>	United States	d' Avignon	3: :21.7	3:01:49.5	6:02:11.2
<i>Vaughan</i>	United States	Seeley (Mrs)	3:24:10	3:49:46	7:13:56
<i>Seeley (Mrs)</i>	United States	Seeley (Mrs)	3:28: 1.7	3:46:45	7:14:46.7



-Pierson Studio

Enil St Goddard of The Pas, Manitoba, Canada, pushing his sled-dog team to first place in the 50-mile Olympic demonstration test

Curling

Born in Scotland, enjoyed in Canada, England, and many countries of the Continent, the "Roarin' Game o' Curlin' " was another demonstration on the program of the III Olympic Winter Games at Lake Placid. This was the second time that the ancient game has figured in Olympic competitions-it was on the schedule at Chamonix in 1924, where the tam-o'-shantered curlers putting down their granite stones on the rinks of glassy ice were a feature of the meet.

Curling was approved as an official demonstration at Lake Placid as a sport primarily foreign to the Organizing Country, altho as a matter of fact, during recent decades, curling has made great strides in the United States. Greater strides, still, will be made as a result of the impetus given the sport at the Lake Placid Games. Eight teams representing curling clubs of Canadian provinces and states of this country competed in the Olympic demonstration.

All curling matches were held in the Olympic indoor arena, where 4 rinks of the finest artificial ice were available. In passing, it is interesting to note that the greatest progress in the popularity of curling in this country has been made during recent years when indoor rinks with artificial ice have been built especially for the grand old Scotch game. Outdoor ice may be satisfactory but rarely is, and the uncertainties and hazards of the winter climate in the northern part of the United States, and even in Canada, have led to the building of these artificial rinks in which curling can be enjoyed at all times regardless of weather, with ice always of uniform quality. It may safely be said that artificial ice rinks and the development of curling are progressing hand in hand, both in the United States and in Canada. Outdoor rinks are still common abroad but have practically disappeared in North America.

Many golf clubs, as well as curling organizations, are now building, or contemplate building, their own enclosed curling quarters. Hockey rinks and sports arenas are also frequently used by the curlers.

Much Like Billiards

Curling has been likened to billiards or bowling on the green. Granite stones, weighing about 42 pounds each, are sent spinning down a glassy-smooth ice surface that corresponds roughly to a billiard table; the stones may be likened to the billiard balls of the famous green-cloth game. The twist that the curling experts put on their stones to have them go in just the direction they wish and stop at the exact point where they will do the most damage to the stones of the opposing rink is something like the "English" that one puts on a billiard ball. This "English" is imparted by the curler when he turns the handle of the stone, even tho it may be ever so slightly, before he sends it twisting and turning on its way down the ice toward the "house," a series of concentric circles, where the stones that have been played are group.

For each "end" or inning each stone or stones of one team, within the outer circle, nearer the center or tee than any stone of the opposite side count one point. A curling match usually consists of from 10 to 16 ends. A point-scoring system determines the winning team. Great skill is shown by the curlers in laying their own stones on or near the center of the series of circles, in protecting those same stones by other stones called "guards," and in dislodging stones of their opponents that might be placed where they would be good for certain points. Frequently one superlative shot will dislodge the inside stone nearest the center and leave the delivered stone in the scoring position. The skill of these curlers is sometimes almost uncanny. It is a game enjoyed alike by young and old. One of its most attractive features is the fact that it can be indulged in during the winter when snow and ice cover tennis-court and golf course.

Quaint Names Used

As indicated above, the series of three concentric circles is called the "house," and the smallest and inside circle is called the

“tee.” The “skip” is the captain of the team. The “hack” is the place on the ice from which the stones are sent curling on their way toward the house. Both ends of the rink are marked with hack and house, and play alternates from end to end. The distance from tee to tee is 114 feet. Brooms are used for sweeping or, as it is called, “swooping” the ice to accelerate the speed of the stone. Sweeping is done at the command of the skip.

Two teams at a time compete on one rink. Four men constitute a team. Two curlers, one from each team, are at the hack at a time, and they alternate in sending the huge stones on their way down the ice sheet. Each man plays two stones, or “stones” as they are called in Scotland. Two other men of each team are stationed with brooms along the ice to sweep in front of the stone at the order of the skips, who are at the house end directing the play.

Curlers found ice conditions at the Olympic demonstration and all other provisions made for the matches ideal. The competitions were on two different days, February 4 and 5. There were 16 matches in all.

Each of the four teams from Canada curled one match with each of the four teams from the United States.

Governing Bodies and Officials

Royal Caledonian Curling Club

Secretary-A H Hamilton, Edinburgh, Scotland

Grand National Curling Club of the United States

President-Alex S Porter, Boston, Mass

III Olympic Winter Games Curling Committee

John Calder, Chairman, United States

Dr Sidney F Blanchet, United States

William G Distin, United States

Peter Lyall, Canada

Officials

Referee

J Bruce Stewart, Canada

Events and Rules

Dates of contests: Feb 4 and 5.

Competition consisted of each Canadian team and each team from the United States curling one match with each other. There were 16 matches in all.

Drawings

Drawings for starting order were made by the III O W G Curling Committee just prior to the beginning of the first match.



Michigan and Quebec in international curling competition. Curling was one of the demonstrations at the III Olympic Winter Games

—*International Newsreel*

CURLING

Demonstration

Entries

Number of nations entered	2
Number of individuals entered	32
Number of contestants	32

Canada
Manitoba
 Willis, Errick F
 Pow, Robert B
 Bowman, James L
 Burns, William H—Skip

Northern Ontario
 Thompson, W W
 Walker, John
 Lyall, Peter
 George, E F—Skip

Ontario
 Hall, Russell G
 Lockhart, Archibald
 McDonald, Frank P
 Sims, Harvey J—Skip

Quebec
 Maclaren, Albert
 Leonard, John
 Stewart, T Howard
 Brown, William—Skip

United States

Connecticut
 Burt, H E
 Pryde, Robert
 Curran, S S
 Hatfield, A R—Skip

Massachusetts
 Parks, F R
 Curtis, Charles
 Willett, George
 Porter, A S—Skip

Michigan
 Mormley, W H
 Palmer, E R
 Fraser, Don
 Lawton, George—Skip

New York
 Williams, C B
 Peale, F D
 Ogden, G B
 Calder, J W—Skip

CURLING

Results

Arena

Afternoon, Feb 4

New York	20
Northern Ontario	8
Quebec	14
Connecticut	12
Ontario	21
Michigan	7
Manitoba	19
Massachusetts	10

Morning, Feb 5

Northern Ontario	21
Massachusetts	7
Manitoba	15
Connecticut	14
Ontario	18
New York	11
Quebec	15
Michigan	6

Evening, Feb 4

Quebec	13
New York	11
Connecticut	18
Northern Ontario	13
Ontario	22
Massachusetts	4
Manitoba	22
Michigan	12

Afternoon, Feb 5

Connecticut	14	} extra } end
Ontario	13	
Massachusetts	17	
Quebec	15	
Northern Ontario	19	
Michigan	11	
Manitoba	15	
New York	9	

SUMMARY

Curling Demonstration

	Won	Lost
Manitoba	4	0
Ontario	3	1
Quebec	3	1
Connecticut	2	2
Northern Ontario	2	2
Massachusetts	1	3
New York	1	3
Michigan	0	4



Curling team representing Province of Manitoba.
Left to right —E. F. Willis, R. B. Pow, J. L. Bowman,
 Wm. H. Burns (skip)



—*International Newsreel*

Jean Wilson, Canada, leading the way in the final of the 500-meter demonstration race



Elizabeth Dubois, United States, winning, final of the 1,000-meter speed-skating demonstration for women



—*International Newsreel*

Women's Speed Skating

The third demonstration at the III Olympic Winter Games was women's speed-skating at distances of 500, 1000, and 1500 meters. Rules of the Amateur Skating Union of the United States governed all three races. Ten contestants were entered: five from Canada, and five from the United States. All races were held on the standard 400-meter track, where the male Olympic speed-skating contestants had skated earlier in the Games.

At the 17th Congress of the Internationale Eislauf-Vereinigung (International Skating Union), which was held in Vienna in May, 1931, it was voted to recognize women's speed-skating at distances of 500, 1000, and 1500 meters. Prior to this congress women's races were not officially approved by the I E V, altho some races had been held in Europe before that time, and women had been competing for years in both the United States and Canada in meets sanctioned by the United States and Canadian governing skating bodies.

The initiative for this action by the I E V at the Vienna Congress was supplied by Poland, which had the hearty support of the representative from the United States, Dr Godfrey Dewey, president of the III Olympic Winter Games Committee.

After its approval of women's speed-skating, the I E V recognized the following as being world's records for women:

500 meters—1 minute 2 seconds

1000 meters—2 minutes 16 and 4-10 secs

1500 meters—3 minutes 28 seconds

All these records were made by Frau Zofja Nehringowa of Poland.

The demonstration of women's speed-skating at the III Olympic Winter Games was the first regularly sanctioned meet for women held after the formal recognition of the sport by the I E V.

All of Frau Nehringowa's records were shattered at Lake Placid by the girl fliers from Canada and the United States. A

glance at the times made in the Olympic demonstration, as given below, will be of interest to skating enthusiasts everywhere.

500 meters—58 seconds

1000 meters—2 minutes 1 and 2-10 secs

1500 meters—2 minutes 54 seconds,

As a matter of fact in the National Women's Championships at Oconomowoc, Wis, U S A, during the winter of 1931-32, Dorothy Franey skated 500 meters in 54.8 seconds, 3.2 seconds faster than the time made in the Olympic demonstration in the same event. The National Women's Championships also served as try-outs for the women's Olympic speed-skating team to represent the United States at Lake Placid.

It is confidently expected by skating authorities that women's speed-skating, with the sanction now given it by the I E V, will become one of the most popular of winter-sports competitions.

The girls, favored by good skating conditions on the Olympic 400-meter track at Lake Placid, put on an excellent exhibition and one that caught the fancy of the crowd, including the skating experts of both North America and Europe. Two firsts went to the United States and one to Canada, while the other places in the three races were well distributed among the entrants.

The races were much like the men's, the girls evidently patterning their speed-skating style on that of their brothers on the ice. They were off with the gun, took the turns well, watcht the pace-setters and the favorites with practised racing eyes, and came into the final stretch in a great burst of speed, giving all they had to win. With all the keen competition for honors, the young ladies displayed excellent sportsmanship, were modest in victory, and never bitter to defeat. The young stars who skated at Lake Placid will be heard from again in subsequent international competitions.

Governing Bodies and Officials

International Skating Union

President—Ulrich Salchow, Stockholm,
Sweden

Amateur Skating Union of the United States

President—Joseph K Savage, New York
City

Technical Delegates

Herbert J Clarke, Great Britain
Walter Jakobsson, Finland
Hermann Kleeberg, Germany

Officials

Referee and Assistants

Joseph K Savage, Chief, United States
Irving W Reiner, United States
J T Rowan, Canada

Starter

Edmund Horton, United States

Judges at Finish

John Harding, Chief, United States
Yngvar Bryn, Norway
Graydon Cowles, United States
Godfrey Dewey, United States
James Fortune, United States
Lewis G Graeves, United States
William Carroll Hill, United States
J Edward McVeigh, Canada
Raymond F Stevens, United States
Frank W Swift, United States

Timers

William Reach, Chief, United States
John V Dolan, United States
William Eggens, United States
Julian T Fitzgerald, United States
Fred Futterer, United States
Elwood S Kerr, United States
Charles Lee, United States
Carsten Matheson, Norway
George L Starks, United States
Curtis Stevens, United States
J Hubert Stevens, United States

Scorers

George Anson, Chief, United States
Harold Eckart, United States
William Distin, United States

Clerks of the Course

Charles H Goldsmith, Chief, United States
Dr Cato Aall, Norway
Harry Kemper, United States
Armas Palmros, Finland
William M Potter, United States
Prof M Sato, Japan

Patrol Judges

Dr J A Geis, Chief, United States
Roy McWhirter, United States
Benton Ames, United States
Benjamin Blanke, United States
E W Cady, United States
Arthur Flack, Canada
R J Kennedy, United States
J Vernon Lamb, United States
James McWhirter, United States
Runar Oehman, Sweden
John Tamsen, United States
P J Hennessy, United States
Wayne Timmerman, United States

Announcers

Clarence Eccleston, United States
Paul Patchin, United States
Livingston Chapman, United States

Measurers

Henry Homburger, United States
C W Judson, United States

Events and Rules

Dates of contests: Feb 8, 9, and 10.
Women's Speed-skating Demonstration
consisted of three events: 500, 1000 and
1500-meter races.

Drawings

Drawings for heats were made in the presence of the technical delegates by the representatives of the countries taking part.

Drawings for starting positions were made by the contestants just before each heat or final.

WOMEN'S SPEED SKATING

Demonstration

Entries

Number of nations entered 2
Number of individuals entered 10
Number of contestants 10

Canada

Brooks-Potter, Lela
Donaldson, Hattie
Hurd, Florence
Mackie, Geraldine
Wilson, Jean

United States

Bina, Helen
Dubois, Elizabeth
Francy, Dorothy
Klein, Kit
Muller-McLave, Elsie

500 METER (546.8 Yards)

Stadium

Afternoon, Feb 8

Results

First 3 in each preliminary heat qualified for
the final

First Heat

- 1 Brooks-Potter, Canada
 - 2 Muller-McLave, United States
 - 3 Bina, United States
 - 4 Donaldson, Canada
 - 5 Mackie, Canada
- Time: 62.4 seconds

Second Heat

- 1 Wilson, Canada
 - 2 Klein, United States
 - 3 Dubois, United States
 - 4 Francy, United States
 - 5 Hurd, Canada
- Time: 60.4 seconds

Final

- 1 Wilson, Canada
 - 2 Dubois, United States
 - 3 Klein, United States
 - 4 Brooks-Potter, Canada
 - 5 Muller-McLave, United States
 - 6 Bina, United States
- Time: 58 seconds



-Pierson Studio

Jean Wilson, Canada

1000 METER (1093.6 Yards)

Stadium *Afternoon, Feb 9*

Results

First 3 in each preliminary heat qualified for the final

First Heat

- 1 Brooks-Potter, Canada
 - 2 Mackie, Canada
 - 3 Donaldson, Canada
 - 4 Bina, United States
 - * Muller-McLave, United States
- Time: 2 minutes 1.2 seconds

Second Heat

- 1 Wilson, Canada
 - 2 Dubois, United States
 - 3 Franey, United States
 - * Hurd, Canada
 - * Klein, United States
- Time: 2 minutes 6 seconds

Final

- 1 Dubois, United States
 - 2 Donaldson, Canada
 - 3 Franey, United States
 - 4 Brooks-Potter, Canada
 - 5 Mackie, Canada
 - 6 Wilson, Canada
- Time: 2 minutes 4 seconds

* Did not finish.



-Acme Photo

Elizabeth Dubois, U S A

1500 METER (.93 Mile)

Stadium *Afternoon, Feb 10*

Results

First 3 in each preliminary heat qualified for the final

First Heat

- 1 Brooks-Potter, Canada
 - 2 Bina, United States
 - 3 Mackie, Canada
 - 4 Muller-McLave, United States
 - 5 Donaldson, Canada
- Time: 2 minutes 54 seconds

Second Heat

- 1 Wilson, Canada
 - 2 Klein, United States
 - 3 Franey, United States
 - 4 Dubois, United States
 - 5 Hurd, Canada
- Time: 2 minutes 54.2 seconds

Final

- 1 Klein, United States
 - 2 Wilson, Canada
 - 3 Bina, United States
 - 4 Mackie, Canada
 - 5 Franey, United States
 - 6 Brooks-Potter, Canada
- Time: 3 minutes .6 seconds



-Wide World

Kit Klein, U S A

Closing Ceremony

Altho the four-man bobsled races were postponed on account of weather conditions to February 14 and 15, the III Olympic Winter Games came officially to an end on Saturday afternoon, February 13, when the closing ceremony, including the final distribution of prizes, was held in the Olympic stadium immediately following the deciding hockey game between Canada and the United States.

Because of better ice conditions the hockey game was staged in the Olympic arena. As soon as the game was over, the crowd, estimated at more than 6,000, adjourned to the stadium, adjoining the arena, to view the impressive ceremonies of bringing the Games officially to a close.

The darkness of a winter afternoon was beginning to come down on the stadium as the ceremonies began, and the long-delayed and ardently-wished-for snow-storm quickly covered both contestants and spectators with a mantle of white. Huge arc lights shone thru the gathering gloom, and millions of snow flakes sparkled and glittered in the shafts of brightness.

It was a dramatic finish in a dramatic setting to a dramatic sports event.

Grouped in front of the grandstand were the representatives of the 17 nations competing in the III Olympic Winter Games. All except the speed-skaters, who had received their prizes earlier in the program, were waiting for the official recognition of their prowess as Olympic athletes, the Olym-

pic medals for first, second, and third places, won in the preceding competitions,

A three-deck flag-draped platform stood on the ice in front of the judges' stand. As their names were called, the first three place-winners stepped to the platform, the winner in the middle, the second-place winner on his right, and the third-place winner on his left. As the band played the national anthem of the winners, the medals were presented with a word of congratulation to each competitor by Count de Baillet-Latour of Belgium, president of the International Olympic Committee; Dr Godfrey Dewey of Lake Placid, president of the III Olympic Winter Games Committee; and Avery Brundage of Chicago, president, American Olympic Committee.

After the medals had been awarded and the victors applauded, Count de Baillet-Latour declared the III Olympic Winter Games officially ended. As a salute was fired the Olympic flag was hauled down from the towering staff, not to be raised again for Winter Olympic competitions until 1936.

By the time the ceremonies had come to an end a typical February Adirondack blizzard raged across the stadium. The thousands assembled there looked like snow-white ghosts in the eerie half-light. Darkness closed in as the flag came down.

Place medals for the winners of the 4-man bob events were awarded at the Mt Van Hoevenberg run on the final day of bob racing, Monday, February 15.



—Acme Photo

The III Olympic Winter Games come to a close. Count de Baillet-Latour, with the massed flags of the nations forming an impressive background, declares the Games officially closed

Point Scoring

There is no official point score in the Olympic Games. Officially, no nation ever "wins" the Olympic Games, winter or summer. The rules of the International Olympic Committee are most explicit on this point. General Rule 18, Prizes (see page 000), provides for the award of silver-gilt, silver, and bronze Olympic medals and diplomas to the winners of the first three places in each event, while General Rule 19, Classification, states explicitly:

"In the Olympic Games there is no classification according to points.

"A Roll of Honor . . . shall be set up bearing the names of the first six competitors in each event as soon as this classification has been made."

The official position of the International Olympic Committee is thus to regard the Olympic Games as primarily a competition among the most brilliant athletes of the world in each sport, without regard to the national affiliation of such athletes, the organization of Olympic teams by countries being chiefly for practical convenience in selecting and accrediting, training and transporting the athletes, and financing their participation. The International Olympic Committee emphasizes in support of this position that any system of point scoring inevitably works a grave injustice on the smaller countries, whose few athletes, no matter how brilliant individually, are certain to be overshadowed in any point, score, both by the number of events in which the larger countries are represented and by the ability of those countries to enter a full quota in each event.

In view of this clearly expressed official position, the typical fund-raising slogan of most national Olympic Committees, "Help America win," etc, might well take the form of "Help American athletes win," etc, which would represent a gain in accuracy with little if any loss of force.

In spite of these cogent reasons for the official position of the, International Olympic Committee, it has been, the experience of all previous Olympic Games that the press of the world insist on exploiting the aspect of na-

tional rivalry by creating and publishing a wholly unofficial point score of their own devising, most often on the basis of 10, 5, 4, 3, 2, 1 points for the six places recognized on the table of honor-that is 10 points for the first place, 5 for the second, etc. Since this unofficial newspaper point score has received world-wide publicity, reaching millions of people who are not aware of its lack of official sanction, it is here recorded for ready reference, together with the table of places won by each nation, on which it is based.

Following this section the reader will find the tables of honor for the Chamonix, St Moritz, and Lake Placid Olympic Winter Games. It is expected that these will serve as the basis for many interesting comparisons, particularly results achieved by those athletes who took part in more than one Olympic Winter Games competition.



-Wide World

Veli Saarinen of Finland, just after winning the 50-kilometer cross-country ski race, the most gruelling grind in the field of sport

Unofficial Point Score used by press, based on 10 for first, 5 for second, 4 for third, 3 for fourth, 2 for fifth, and 1 for sixth place

	Skating	Speed Skating	Figure Skating	Hockey	Bobsleigh	Total
United States	2	57	10	5	29	103
Norway	53	14	10	77
Canada	29	10	10	..	49
Sweden	21	..	7	28
Finland	22	..	3	25
Austria	15	15
Germany	2	4	6	12
France	10	10
Switzerland	1	9
Hungary	7	7
Roumania	4	4
Poland	3	..	3
Italy	3	3
Belgium	1
Czechoslovakia..	1	1
Great Britain....
Japan

***Places achieved by nations in
III Olympic Winter Games 1932**

	First	Second	Third	Fourth	Fifth	Sixth
United States....	6	4	2	2	3	3
Norway	3	4	3	2	3	3
Canada	1	1	5	3	2	1
Sweden	1	2	..	1	2	1
Finland	1	1	1	2
Austria	1	1
France	1
Germany	2	..	2	..
Switzerland	1	1	..	1	..	1
Hungary	1	1
Roumania	1	1	1
Poland	1
Italy	1	1
Belgium	1
Czechoslovakia...	1
Great Britain
Japan

* Demonstrations not included in this table.

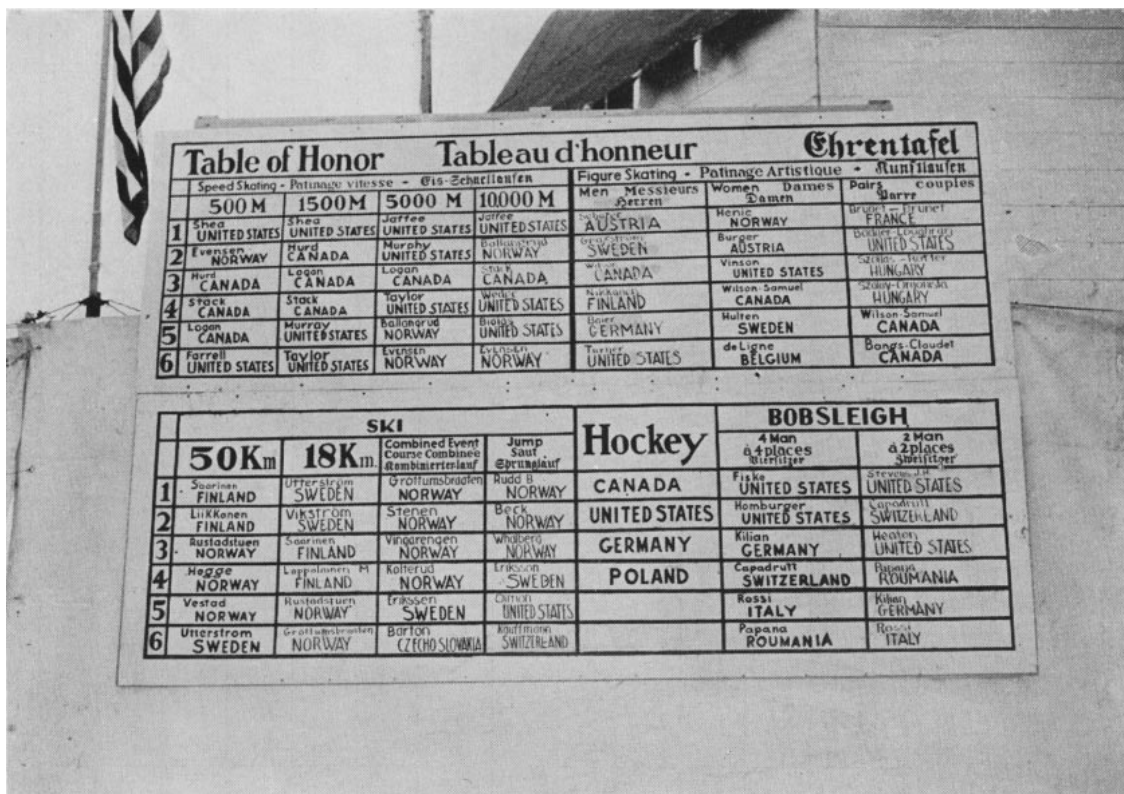

Table of honor on Stadium wall

I OLYMPIC WINTER GAMES-CHAMONIX 1924

Table of Honor					Tableau d'honneur					Ehrentafel				
Speed Skating - Patinage de vitesse - Eis-Schnellaufen					Figure Skating - Patinage Artistique - Kunstlaufen									
	500 M	1,500 M	5,000 M	10,000 M	Men Herren	Messieurs	Women Damen	Dames	Pairs Paare	Couples				
1	Jewtraw <i>United States</i>	Thunberg <i>Finland</i>	Thunberg <i>Finland</i>	Skutnabb <i>Finland</i>	Grafström <i>Sweden</i>		Szabo-Plank <i>Austria</i>		Engelmann-Berger <i>Austria</i>					
2	Olsen <i>Norway</i>	Larsen <i>Norway</i>	Skutnabb <i>Finland</i>	Thunberg <i>Finland</i>	Böckl <i>Austria</i>		Loughran <i>United States</i>		Jakobsson-Jakobsson <i>Finland</i>					
3	Larsen <i>Norway</i>	Moen <i>Norway</i>	Larsen <i>Norway</i>	Larsen <i>Norway</i>	Gautschi <i>Switzerland</i>		Muckelt <i>England</i>		Joly-Brunet <i>France</i>					
4	Thunberg <i>Finland</i>	Skutnabb <i>Finland</i>	Moen <i>Norway</i>	Paulsen <i>Norway</i>	Sliva <i>Czechoslovakia</i>		Blanchard <i>United States</i>		Muckelt-Page <i>England</i>					
5	Vallenius <i>Finland</i>	Strom <i>Norway</i>	Ström <i>Norway</i>	Ström <i>Norway</i>	Page <i>England</i>		Joly <i>France</i>		Herbos-Wagemans <i>Belgium</i>					
6	Blomqvist <i>Finland</i>	Olsen <i>Norway</i>	Bialas <i>United States</i>	Moen <i>Norway</i>	Niles <i>United States</i>		Smith <i>Canada</i>		Blanchard-Niles <i>United States</i>					
Ski					Hockey			Bobsleigh						
	50 Km	18 Km	Combined event Course Combinée Kombinierter Lauf	Jump Salt Sprunglauf				5-man						
1	Haug <i>Norway</i>	Haug <i>Norway</i>	Haug <i>Norway</i>	Thams <i>Norway</i>	Canada			Scherrer <i>Switzerland</i>						
2	Strömstad <i>Norway</i>	Gröttumsbraaten <i>Norway</i>	Strömstad <i>Norway</i>	Bonna <i>Norway</i>	United States			Broome <i>England</i>						
3	Gröttumsbraaten <i>Norway</i>	Niku <i>Finland</i>	Gröttumsbraaten <i>Norway</i>	Haug <i>Norway</i>	England			Mulder <i>Belgium</i>						
4	Maardalen <i>Norway</i>	Maardalen <i>Norway</i>	Oekern <i>Norway</i>	Haugen <i>United States</i>	Sweden			Berg <i>France</i>						
5	Persson <i>Sweden</i>	Landvik <i>Norway</i>	Nilsson <i>Sweden</i>	Landvik <i>Norway</i>				Horton <i>England</i>						
6	Alm <i>Sweden</i>	Hedlund <i>Sweden</i>	Adolf <i>Czechoslovakia</i>	Nilsson <i>Sweden</i>				Obexer <i>Italy</i>						

II OLYMPIC WINTER GAMES—ST MORITZ 1928

Table of Honor				Tableau d'honneur				
Speed Skating - Patinage de vitesse - Eis-Schnellaufen				Figure Skating - Patinage Artistique - Kunstlaufen				
500 M		1,500 M		5,000 M		Men—Messieurs—Herren	Women—Dames—Damen	Pairs—Couples—Paare
1	Thunberg Evensen	<i>Finland</i> <i>Norway</i>	Thunberg <i>Finland</i>	Ballangrud <i>Norway</i>	Grafström <i>Sweden</i>	Henie <i>Norway</i>	Joly-Brunet <i>France</i>	
2			Evensen <i>Norway</i>	Skutnabb <i>Finland</i>	Böck <i>Austria</i>	Burger <i>Austria</i>	Scholz-Kaiser <i>Austria</i>	
3	Farrell Friman Larsen	<i>United States</i> <i>Finland</i> <i>Norway</i>	Ballangrud <i>Norway</i>	Evensen <i>Norway</i>	van Zee broeck <i>Belgium</i>	Loughran <i>United States</i>	Brunner-Wrede <i>Austria</i>	
4			Larsen <i>Norway</i>	Jaffee <i>United States</i>	Schäfer <i>Austria</i>	Vinson <i>United States</i>	Loughran-Badger <i>United States</i>	
5			Murphy <i>United States</i>	Carlsen <i>Norway</i>	Sliva <i>Czechoslovakia</i>	Smith <i>Canada</i>	Jakobsson-Jakobsson <i>Finland</i>	
6	Pederson <i>Norway</i>		Bialas <i>United States</i>	Bialas <i>United States</i>	Nikkänen <i>Finland</i>	Wilson <i>Canada</i>	Leberque- van Zeebroeck <i>Belgium</i>	
Ski					Hockey	Skeleton	Bobsleigh	
	50 Km	18 Km	Combined event Course Combinée Kombinierter Lauf	Jump Saut Sprunglauf			5-man	
1	Hedlund <i>Sweden</i>	Grøttumsbraaten <i>Norway</i>	Grøttumsbraaten <i>Norway</i>	Andersen <i>Norway</i>	Canada	Heaton, J <i>United States</i>	Fiske <i>United States</i>	
2	Jonsson <i>Sweden</i>	Hegge <i>Norway</i>	Vinjarengen <i>Norway</i>	Ruud, S <i>Norway</i>	Sweden	Heaton, J R <i>United States</i>	Heaton, <i>United States</i>	
3	Andersson <i>Sweden</i>	Oedegaard <i>Norway</i>	Snersrud <i>Norway</i>	Purkert <i>Czechoslovakia</i>	Switzerland	Earl of Northesk <i>England</i>	Kilian <i>Germany</i>	
4	Kjellbotn <i>Norway</i>	Saarinen <i>Finland</i>	Nuotio <i>Finland</i>	Nilsson <i>Sweden</i>	England	Lanfranchi <i>Italy</i>	Gramajo <i>Argentine</i>	
5	Hegge <i>Norway</i>	Haakonsen <i>Norway</i>	Järvinen <i>Finland</i>	Lundgren <i>Sweden</i>		Berner <i>Switzerland</i>	Hope <i>Argentine</i>	
6	Lappalainen, T <i>Finland</i>	Hedlund <i>Sweden</i>	Eriksson <i>Sweden</i>	Monsen <i>United States</i>		Unterlechner <i>Austria</i>	Lambert	

NOTE—A demonstration of military skiing was held at St Moritz but is not included in the above table which lists only the official Olympic competitions.

III OLYMPIC WINTER GAMES—LAKE PLACID 1932

Table of Honor					Tableau d'honneur					Ehrentafel				
Speed Skating		Patinage de vitesse		Eis-Schnelllaufen		Figure Skating			Patinage Artistique			Kunstlaufen		
	500 M	1,500 M	5,000 M	10,000 M	Men Herren	Messieurs	Women Damen	Dames	Pairs Paare	Couples				
1	Shea <i>United States</i>	Shea <i>United States</i>	Jaffee <i>United States</i>	Jaffee <i>United States</i>	Schäfer <i>Austria</i>		Henie <i>Norway</i>		Brunet-Brunet <i>France</i>					
2	Evensen <i>Norway</i>	Hurd <i>Canada</i>	Murphy <i>United States</i>	Ballangrud <i>Norway</i>	Grafström <i>Sweden</i>		Burger <i>Austria</i>		Loughran-Badger <i>United States</i>					
3	Hurd <i>Canada</i>	Logan <i>Canada</i>	Logan <i>Canada</i>	Stack <i>Canada</i>	Wilson <i>Canada</i>		Vinson <i>United States</i>		Rotter-Szollas <i>Hungary</i>					
4	Stack <i>Canada</i>	Stack <i>Canada</i>	Taylor <i>United States</i>	Wedge <i>United States</i>	Nikkanen <i>Finland</i>		Wilson-Samuel <i>Canada</i>		Orgonista-Szalay <i>Hungary</i>					
5	Logan <i>Canada</i>	Murray <i>United States</i>	Ballangrud <i>Norway</i>	Bialas <i>United States</i>	Baier <i>Germany</i>		Hulten <i>Sweden</i>		Wilson-Samuel- Wilson <i>Canada</i>					
6	Farrell <i>United States</i>	Taylor <i>United States</i>	Evensen <i>Norway</i>	Evensen <i>Norway</i>	Turner <i>United States</i>		de Ligne <i>Belgium</i>		Claudet-Bangs <i>Canada</i>					
Ski					Hockey			Bobsleigh						
	50 Km	18 Km	Combined event Course Combinée Kombiniertes Lauf	Jump Saut Sprunglauf				4-man à 4 places Viersitzer	2-man à 2 places Zweisitzer					
1	Saarinen <i>Finland</i>	Utterström <i>Sweden</i>	Grøttumsbraaten <i>Norway</i>	Ruud, B <i>Norway</i>	Canada			Fiske <i>United States</i>	Stevens, <i>United States</i>					
2	Liikkanen <i>Finland</i>	Vikström <i>Sweden</i>	Stenen <i>Norway</i>	Beck <i>Norway</i>	United States			Homburger <i>United States</i>	Capadrutt <i>Switzerland</i>					
3	Rustadstuen <i>Norway</i>	Saarinen <i>Finland</i>	Vinjarengen <i>Norway</i>	Wahlberg <i>Norway</i>	Germany			Kilian <i>Germany</i>	Heaton <i>United States</i>					
4	Hegge <i>Norway</i>	Lappalainen, M <i>Finland</i>	Kolterud <i>Norway</i>	Eriksson <i>Sweden</i>	Poland			Capadrutt <i>Switzerland</i>	Papana <i>Roumania</i>					
5	Vestad <i>Norway</i>	Rustadstuen <i>Norway</i>	Eriksson <i>Sweden</i>	Oimen <i>United States</i>				Rossi <i>Italy</i>	Kilian <i>Germany</i>					
6	Utterström <i>Sweden</i>	Grøttumsbraaten <i>Norway</i>	Barton <i>Czechoslovakia</i>	Kaufmann <i>Switzerland</i>				Papana <i>Roumania</i>	Rossi <i>Italy</i>					

268

NOTE:—There were three demonstrations at the III Olympic Winter Games: Sled-dog Racing, Curling, and Women's Speed-skating For table of demonstration results see page 269.

III OLYMPIC WINTER GAMES-LAKE PLACID 1932

RESULTS OF DEMONSTRATIONS			
	SLED DOG RACE	CURLING	
1	St Goddard <i>Canada</i>	Manitoba	
2	Seppala <i>United States</i>	Ontario } Tie Quebec }	
3	Russick <i>Canada</i>		
4	Wheeler <i>Canada</i>	Connecticut } Tie Northern Ontario }	
5	Haines <i>United States</i>		
6	Pouliot <i>Canada</i>	Massachusetts } Tie New York }	
WOMEN'S SPEED SKATING			
	50 M	1000 M	1500 M
1	Wilson <i>Canada</i>	Dubois <i>United States</i>	Klein <i>United States</i>
2	Dubois <i>United States</i>	Donaldson <i>Canada</i>	Wilson <i>Canada</i>
3	Klein <i>United States</i>	Franey <i>United States</i>	Bina <i>United States</i>
4	Brooks-Potter <i>Canada</i>	Brooks-Potter <i>Canada</i>	Mackie <i>Canada</i>
5	Muller-McLave <i>United States</i>	Mackie <i>Canada</i>	Franey <i>United States</i>
6	Bina <i>United States</i>	Wilson <i>Canada</i>	Brooks-Potter <i>Canada</i>

TABLE OF PARTICIPATION—III OLYMPIC WINTER GAMES

	Skiing				Speed Skating Men				Figure Skating			Ice Hockey	Bobsleigh		Demonstrations					TOTALS
	50 kilo-meter	18 kilo-meter	Com-bined event	Jump-ing	500 meter	1500 meter	5000 meter	10,000 meter	Men	Wo-men	Pairs		4 man	2 man	Sled Dog Race	Curling	Speed Skating Women			
																	500 meter	1000 meter	1500 meter	
Austria	3	3	2	1	1	2	12
Belgium	1	4	5
Canada	3	4	4	4	4	4	4	4	1	3	4	14	5	16	5	5	5	89
Czechoslovakia	4	4	4	4	1	17
Finland	4	4	1	1	1	1	12
France	4	2	..	2	8
Germany	1	10	8	4	23
Great Britain	4	4
Hungary	4	4
Italy	3	3	3	3	4	4	20
Japan	4	4	3	4	4	4	4	4	2	33
Norway	4	4	4	4	4	4	4	4	..	1	33
Poland	2	4	3	3	11	23
Roumania	4	2	6
Sweden	4	4	2	3	..	1	1	1	1	1	18
Switzerland	3	3	4	2	12
United States	4	4	4	4	4	4	4	4	4	4	4	14	8	4	7	16	5	5	5	108
Totals	32	42	33	34	16	18	18	18	12	15	14	49	28	24	12	32	10	10	10	427

NOTE: This table indicates the number of individual participants in each event for each country. Reserves are not counted here. Because of this latter fact and also because some individuals competed in more than one event, the table does not show the actual number of entries received, which, including reserves, totalled 364. *

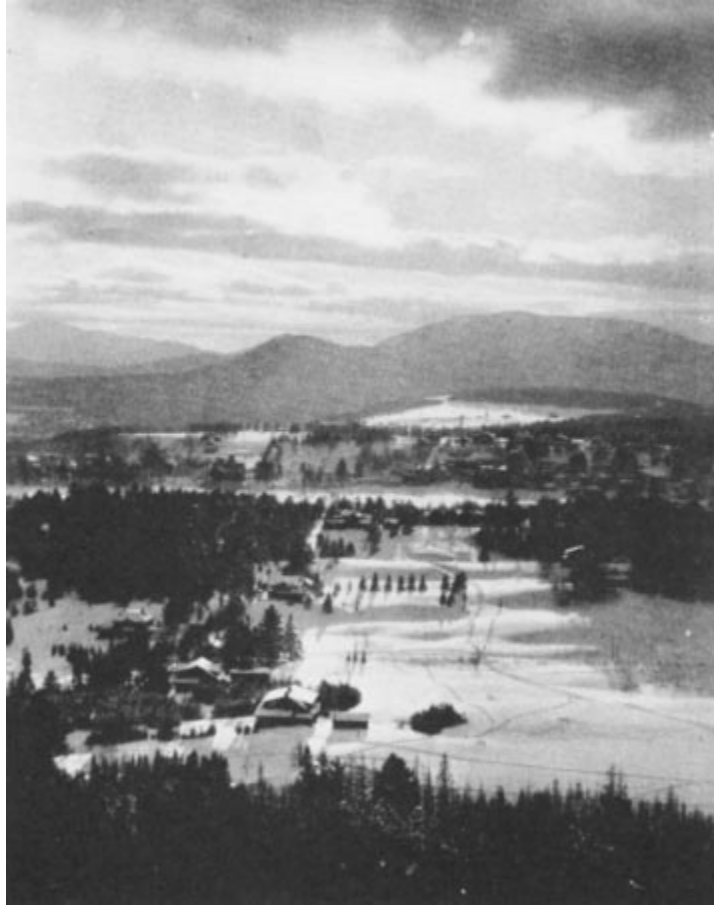

— *Siedman*

Winter lights and shadows at Lake Placid

III Olympic Winter Games

Program

Thursday, Feb 4

Morning

10:00 Stadium
Opening ceremony

10:30 Stadium
500 meter speed skating races

11:00 Stadium Hockey
Canada—United States

Afternoon

2:15 Stadium
5,000 meter speed skating races

2:45 Stadium Hockey
Poland—Germany

2:45 Arena
Curling (demonstration)

Evening

8:15 Arena
Curling
(demonstration)

Friday, Feb 5

9:30 Stadium
1,500 meter speed skating races

9:30 Arena
Curling (demonstration)

10:00 Stadium Hockey
Poland—United States

2:15 Stadium
10,000 meter speed skating races.
Preliminaries

2:45 Stadium Hockey
Canada—McGill University (exhibition)

2:45 Arena
Curling (demonstration)

8:15 Arena Hockey
Germany—Lake Placid
(exhibition)

Saturday, Feb 6

9:30 Stadium
10,000 meter speed skating races. Finals

10:00 Stadium Hockey
Canada—Germany

2:15 Stadium
Sled-dog races (demonstration)

2:45 Stadium Hockey
United States—McGill University
(exhibition)

8:15 Arena Hockey
Poland—Lake Placid
(exhibition)

Sunday, Feb 7

Free

2:15 Stadium
Sled-dog races (demonstration)

2:45 Stadium Hockey
Canada—Poland

8:15 Arena Hockey
Germany—United
States

Monday, Feb 8

9:30 Mt Van Hoevenberg Bob-run
2-man bob races
Heats 1 and 2

9:30 Arena
Men's figure skating—School figures

2:15 Arena
Men's figure skating—School figures

2:15 Stadium Hockey
United States—Poland

2:45 Stadium
Women's 500 meter speed skating race
(demonstration)

8:15 Arena Hockey
Germany—Canada

Lake Placid 1932

Tuesday, Feb 9

Morning

9:30 Mt Van Hoevenberg Bob-run
2-man bob races
Heats 3 and 4

9:30 Arena
Women's figure skating—School figures

Afternoon

2:15 Arena
Women's figure skating—School figures

2:15 Stadium Hockey
Poland—Canada

2:45 Stadium
Women's 1,000 meter speed skating race
(demonstration)

Evening

8:15 Arena
Men's figure skating
Free figures

Wednesday, Feb 10

9:30 Start and finish at Stadium
18 kilometer ski race

10:30 Stadium Hockey
Canada—Lake Placid (exhibition)

2:15 Stadium Hockey
United States—Germany

2:45 Stadium
Women's 1,500 meter speed skating race
(demonstration)

8:15 Arena
Women's figure skating
Free figures

Thursday, Feb 11

9:30 Mt Van Hoevenberg Bob-run
4-man bob races
Heats 1 and 2

2:15 Olympic Ski-hill
Ski jump (combined event)

8:15 Arena Hockey
United States—Lake Placid (exhibition)

Friday, Feb 12

9:30 Mt Van Hoevenberg Bob-run
4-man bob races
Heats 3 and 4

2:15 Olympic Ski-hill
Ski jump

8:15 Arena
Figure skating—Pairs

Saturday, Feb 13

8:00 Start and finish at Stadium
50 kilometer ski race

9:30 Stadium Hockey
Poland—Germany

2:15 Stadium Hockey
United States—Canada

3:45 Stadium
Final distribution of prizes and diplomas
Closing ceremony

Note

Hockey: Weather conditions made it necessary to transfer 5 hockey games from the stadium to the arena. The exhibition hockey game scheduled to be played on the morning of Feb 10 between Canada and Lake Placid A C and the exhibition scheduled for the arena on the evening of Feb 11 between U S A and Lake Placid A C were combined by agreement, and instead a game was played on the evening of Feb 11 at the arena between a team composed of members of the Canadian and U S Olympic squads and the Lake Placid A C.

Other events were shifted as follows:

Speed Skating: Re-skating of 10,000-meter preliminary heats held morning of Feb 6
Final of 10,000-meter race to afternoon of Feb 8

Bobsleigh: 2-man, heats 1 and 2, to morning of Feb 9
2-man, heats 3 and 4, to morning of Feb 10
4-man, heats 1 and 2, to morning of Feb 14
4-man, heats 3 and 4, to morning of Feb 15

Skiing: Start of 50-km race to 11 a m, Feb 13

Alphabetic List of Entries, Including Reserves

III Olympic Winter Games

Lake Placid 1932

<i>Contestants</i>	<i>Country</i>	<i>Sport</i>	<i>Contestants</i>	<i>Country</i>	<i>Sport</i>
Aas-Haugen, Oscar	Norway	Ski	Defalco, Jack	Canada	Dog Derby,
Adachi, Goro	Japan	Ski	Deitz, Milford	United States	Speed Skating
Adams, Arthur	United States	Bobsleigh	Delago, Giovanni	Italy	Ski
Ageishi, Iwao	Japan	Ski	de Ligne, Yvonne	Belgium	Figure Skating
Andersen, Erling N	United States	Ski	Delille, Armand	France	Bobsleigh
Andersen, Reidar	Norway	Ski	DeZulian, Francesco	Italy	Ski
Anderson, Osborn	United States	Hockey	Dix, Joan	Great Britain	Figure Skating
Ashforth, Albert	United States	Bobsleigh	Donaldson, Hattie	Canada	Women's Sp.Sk
Aström, Sven	Sweden	Ski	Douglas, David H	Canada	Ski
Backstrom, Nils	United States	Ski	Dubois, Elizabeth	United States	Women's Sp.Sk
Badger, Sherwin	United States	Figure Skating	Duncanson, Albert	Canada	Hockey
Bagguley, D Howard	Canada	Ski	Dupuis, Gerald E	Canada	Ski
Baier, Ernst	Germany	Figure Skating	Eagan, Edward F	United States	Bobsleigh
Ball, Rudi	Germany	Hockey	Eisenhut, Hans	Switzerland	Bobsleigh
Ball, William	Canada	Ski	Ellingson, Lloyd C	United States	Ski
Ballangrud, Ivar	Norway	Speed Skating	Engnestangen, Hans	Norway	Speed Skating
Balsan, Louis	France	Bobsleigh	Engstad, Kaare	Canada	Ski
Bangs, Chauncy	Canada	Figure Skating	Ericksen, John M	United States	Ski
Barton, Antonin	Czechoslovakia	Ski	Eriksson,	Sweden	Ski
Batson, Lemoine	United States	Ski	Evensen, Bernt	Norway	Speed Skating
Beck, Hans	Norway	Ski	Everett, Douglas	United States	Hockey
Belknap, Stuart	United States	Dog Derby	Falstad, Pedar	United States	Ski
Bennett, Margaret	United States	Figure Skating	Farrell, Franklin	United States	Hockey
Bent, John	United States	Hockey	Farrell, J O'Neil	United States	Speed Skating
Berthet, Raymond	France	Ski	Feistauer, Jaroslav	Czechoslovakia	Ski
Bialas, Valentine	United States	Speed Skating	Fisher, Elizabeth	Canada	Figure Skating
Billings, Norton R	United States	Ski	Fiske, William L	United States	Bobsleigh
Bina, Helen	United States	Women's Sp.Sk	Fitzgerald, Joseph	United States	Hockey
Blomqvist, Ossian O	Finland	Speed Skating	Flack, Herbert S	Canada	Speed Skating
Blood, Edward J	United States	Ski	Fonjallaz, Gaston	Switzerland	Bobsleigh
Borden II, Gail	United States	Figure Skating	Fonjallaz, Gustave	Switzerland	Bobsleigh
Bosio, Harald	Austria	Ski	Fonjallaz, René	Switzerland	Bobsleigh
Bowman, James L	Canada	Curling	Franey, Dorothy	United States	Women's Sp.Sk
Brehme, Albert	Germany	Bobsleigh	Fraser, Don	United States	Curling
Brooks-Potter, Lela	Germany	Women's Sp.Sk	Frazier, Edward	United States	Hockey
Brown, William	Canada	Curling	Gagne, Leslie R	Canada	Ski
Brunet, Andrée	France	Figure Skating	Garbutt, George	Canada	Hockey
Brunet, Pierre	France	Figure Skating	Garrison, John	United States	Hockey
Brupbacher, Max	Switzerland	Bobsleigh	Geier, Oscar	Switzerland	Bobsleigh
Bryant, Percy D	United States	Bobsleigh	George, E F	Canada	Curling
Buchheim, Nicolas	Switzerland	Bobsleigh	Goodrich, Hunter	United States	Bobsleigh
Bunnell, Earl	United States	Dog Derby	Grafström, Gillis	Sweden	Figure Skating
Burger, Fritz	Austria	Figure Skating	Grau, Fritz	Germany	Bobsleigh
Burns, William H	Canada	Curling	Gravel, Arthur L	Canada	Ski
Burt, H E	United States	Curling	Gray, Clifford B	United States	Bobsleigh
Calder, J W	United States	Curling	Gröttumsbraaten, Johan	Norway	Ski
Capadruitt, Reto	Switzerland	Bobsleigh	Gudenus, Johann Baptist	Austria	Bobsleigh
Casini, Italo	Italy	Bobsleigh	Guenther, Lloyd W	United States	Speed Skating
Chase, John	United States	Hockey	Gyssling, D Georg	Germany	Bobsleigh
Chiogna, Cesare	Switzerland	Ski	Hackney, Clement	United States	Bobsleigh
Cifka, Jan	Czechoslovakia	Ski	Haines, Roger	United States	Dog Derby
Clark, William G	Canada	Ski	Hall, Russell G	Canada	Curling
Claudet, Frances	Canada	Figure Skating	Hallock, Gerard	United States	Hockey
Cockburn, William	Canada	Hockey	Hansez, Christian Wm	Belgium	Bobsleigh
Colledge, Magdalen	Great Britain	Figure Skating	Harsh, James	United States	Ski
Cookman, John	United States	Hockey	Hatfield, A R	United States	Curling
Colturi, Lorenzo	Italy	Ski	Heaton, John R	United States	Bobsleigh
Cretin, Leonce	France	Ski	Hegge, Ole	Norway	Ski
Crivelli, Giuseppe	Italy	Bobsleigh	Heggtveit, Halver L	Canada	Ski
Crowley, Clifford	Canada	Hockey	Heinrich, Alfred	Germany	Hockey
Curran, S S	United States	Curling	Henie, Sonja	Norway	Figure Skating
Currie, John F	Canada	Ski	Herker, Erich	Germany	Hockey
Curtis, Charles	United States	Curling	Hessert, Baron G	Germany	Bobsleigh
Czech, Bronislaw	Poland	Ski	Hill, George	United States	Figure Skating
Dallago, Ingenuino	Italy	Ski	Hinkel, Roy	Canada	Hockey
Davis, Suzanne	United States	Figure Skating	Hogan, Joseph E	Canada	Ski

<i>Contestants</i>	<i>Country</i>	<i>Sport</i>	<i>Contestants</i>	<i>Country</i>	<i>Sport</i>
Höll, Gregor	Austria	Ski	Marusarz, Stanislaw	Poland	Ski
Holmstrom, Carl	United States	Ski	Materski, Kazimierz	Poland	Hockey
Homburger, Henry A	United States	Bobsleigh	Mattsson, Sivert	Sweden	Ski
Hopmann, Helmut	Germany	Bobsleigh	Mauer, Albert	Poland	Hockey
Hofton, Edmund C	United States	Bobsleigh	Maus, Jacques	Belgium	Bobsleigh
Hoshina, Takeo	Japan	Bobsleigh	Mehlhorn, Dr Hans	Germany	Bobsleigh
Houben, Max	Belgium	Bobsleigh	Menardi, Severino	Italy	Ski
Hovde, Kristian	Norway	Ski	Meredith, Gertrude	United States	Figure Skating
Huber, Sebastian	Germany	Bobsleigh	Mikkelsen, Roy	United States	Ski
Hubert, Capt Dumitru	Roumania	Bobsleigh	Minton, Robert H	United States	Bobsleigh
Hulten, Vivi-Anne	Sweden	Figure Skating	Monsen, Rolf	United States	Ski
Hurd, Alexander	Canada	Speed Skating	Monson, Walter	Canada	Hockey
Hurd, Florence	Canada	Women's Sp.Sk	Moore, Kenneth	Canada	Hockey
Huth, Werner	Germany	Bobsleigh	Mormley, W H	United States	Curling
Ionescu, Capt Alexandru	Roumania	Bobsleigh	Motyka, Zdzislaw	Poland	Curling
Ishihara, Shozo	Japan	Speed Skating	Mugnier, Paul	France	Ski
Iwasaki, Saburo	Japan	Ski	Muller-McLave, Elsie	United States	Women's Sp.Sk
Jaenecke, Gustav	Germany	Hockey	Murphy, Edward S	United States	Speed Skating
Jaffee, Irving	United States	Speed Skating	Murphy, Henry	United States	Dog Derby
Jenny, Charles	Switzerland	Bobsleigh	Murray, Raymond V	United States	Speed Skating
Johansen, Jorgen	United States	Ski	Nagel, William	United States	Figure Skating
Jonsson, Karl G	Sweden	Ski	Nelson, Francis	United States	Hockey
Jost, Werner	Switzerland	Bobsleigh	Neuman, Werner	Switzerland	Bobsleigh
Kaufmann, Fritz	Switzerland	Ski	Nikkanen, Marcus	Finland	Figure Skating
Kawamura, Yasuo	Japan	Speed Skating	Nordmoe, Jostein	Canada	Ski
Kilian, Hanns	Germany	Bobsleigh	Novák, Vladimir	Czechoslovakia	Ski
Kitani, Tokuo	Japan	Speed Skating	O'bitani, Ryoichi	Japan	Figure Skating
Klein, Kit	United States	Women's Sp.Sk	O'Brien, Jay	United States	Bobsleigh
Kleppen, Hans	Norway	Ski	Ogden, G B	United States	Curling
Kloetta, Antoine	Switzerland	Bobsleigh	Oimatsu, Kazuyoshi	Japan	Figure Skating
Kolterud, Sverre	Norway	Ski	Oimen, Caspar	United States	Ski
Korff, Werner	Germany	Hockey	Oliver, Byron A	Canada	Ski
Kowalski, Adam	Poland	Hockey	Orgonista, Olga	Hungary	Figure Skating
Kowalski, Aleksander	Poland	Hockey	Palmer, E R	United States	Curling
Krotki, Rudolf	Germany	Bobsleigh	Palmer, Winthrop	United States	Curling
Krygier, Wlodzimierz	Poland	Hockey	Pangman, Arthur H	Canada	Ski
Kuriyagawa, Heigoro	Japan	Ski	Papana, Lieut Alexandru	Roumania	Bobsleigh
Lafleur, Lucien	Canada	Ski	Parks, F R	United States	Curling
Landry, Jacques B	Canada	Ski	Parsons, Richard E	United States	Ski
Lanfranchi, Agostino	Italy	Bobsleigh	Paumgarten, Harald	Austria	Ski
Lanfranchi, Gaetano	Italy	Bobsleigh	Peale, F D	United States	Curling
Langer, Walter	Czechoslovakia	Figure Skating	Pedersen, Haakon	Norway	Speed Skating
Lappalainen, Martti	Finland	Ski	Penttilä, Erkki	Finland	Ski
Lappalainen, Tauno	Finland	Ski	Peppe, Audrey	United States	Figure Skating
Lawton, George	United States	Curling	Petrescu, Lieut Ulysse	Roumania	Bobsleigh
Leinweber, Walter	Germany	Hockey	Phillips, Mollie	Great Britain	Figure Skating
Leonard, John	Germany	Curling	Porter, A S	United States	Curling
Liikkanen, Väinö	Finland	Ski	Potts, Allan W	United States	Speed Skating
Lindberg, Carl E	Sweden	Speed Skating	Pouliot, Raymond	Canada	Dog Derby
Lindberg, Karl J	Sweden	Ski	Pow, Robert B	Canada	Curling
Lindboe, Erling	Norway	Speed Skating	Pryde, Robert	United States	Curling
Lindgren, John H	Sweden	Ski	Reburn, Stewart	Canada	Figure Skating
Lindquist, C Victor	Canada	Hockey	Reid, Robert H	United States	Ski
Lipson, Howard S	United States	Bobsleigh	Rivers, N Romeo	Canada	Hockey
Littlejohn, Mary	Canada	Figure Skating	Rogers, Isabel	Canada	Figure Skating
Livingston, Robert	United States	Hockey	Rogers, Melville	Canada	Figure Skating
Lockhart, Archibald	Canada	Curling	Roman, Commander Horia	Roumania	Bobsleigh
Logan, William F	Canada	Speed Skating	Römer, Erich	Germany	Hockey
Loughran, Beatrix	United States	Figure Skating	Rossi di Montelera, Count	Italy	Bobsleigh
Ludwiczak, Witalis	Poland	Hockey	Rossner, Heinrich	Germany	Bobsleigh
Ludwig, Max	Germany	Bobsleigh	Rotter, Emilia	Hungary	Figure Skating
Lyall, Peter	Canada	Curling	Russick, Shorty	Canada	Dog Derby
Lymburne, Robert S	Canada	Ski	Rustadstuen, Arne	Norway	Ski
Mackie, Geraldine	Canada	Women's Sp.Sk	Ruud, Birger	Norway	Ski
Maclaren, Albert	Canada	Curling	Ruud, Sigmund	Norway	Ski
McCarthy, Marion S	Canada	Speed Skating	Ryan, Walter	Switzerland	Ski
McDonald, Frank P	Canada	Curling	Rylander, Erik	Sweden	Ski
Madden, James	United States	Figure Skating	Saarinen, Veli	Finland	Ski
Makita, Mitsutake	Japan	Ski	Sabinski, Roman	Poland	Hockey
Malloy, Norman	Canada	Hockey	Sachs, Tadeusz	Poland	Hockey
Marchewczyk, Czeslaw	Poland	Hockey	Saetre, Magnus	Norway	Ski
Marin, Theo	Belgium	Bobsleigh	Saetre, Ottar	Norway	Ski
Martin, Harry G	United States	Bobsleigh	St Goddard, Emile	Canada	Dog Derby
Marusarz, Andrzej	Poland	Ski	Savage, Joseph	United States	Figure Skating

<i>Contestants</i>	<i>Country</i>	<i>Sport</i>	<i>Contestants</i>	<i>Country</i>	<i>Sport</i>
Schäfer, Karl	Austria	Figure Skating	Taniguchi, Kinzo	Japan	Ski
Schön, Hjert	Sweden	Ski	Taylor, Herbert G	United States	Speed Skating
Schroeder, Edward J	United States	Speed Skating	Taylor, John P	Canada	Ski
Schrötle, Martin	Germany	Hockey	Taylor, Megan	Great Britain	Figure Skating
Secretan, Albert	France	Ski	Thompson, W W	Canada	Curling
Sears, Dexter	United States	Dog Derby	Toikka, Valmari	Finland	Ski
Seeley, Mrs Milton	United States	Dog Derby	Torchon, Georges	France	Figure Skating
Seppala, Leonard	United States	Dog Derby	Tsubokawa, Takemitsu	Japan	Ski
Sertorelli, Erminio	Italy	Ski	Turner, Roger	United States	Figure Skating
Sevre, Kolbjörn	Norway	Ski	Unger, Donald	Switzerland	Bobsleigh
Shea, John A	United States	Speed Skating	Uruma, Tomeju	Japan	Speed Skating
Simpson, Harold	Canada	Hockey	Utterström, Sven L	Sweden	Ski
Sims, Harvey J	Canada	Curling	Van Hege, Louis	Belgium	Bobsleigh
Simunek, Frantisek	Czechoslovakia	Ski	Vaughan, Norman	United States	Dog Derby
Skupien, Stanislaw	Poland	Ski	Vestad, Sigurd	Norway	Ski
Slevogt, F Marquardt	Germany	Hockey	Veurich, Andrea	Italy	Ski
Smith, Gordon	United States	Hockey	Vikström, Axel T	Sweden	Ski
Smyth, C Harry	Canada	Speed Skating	Vinjarengen, Hans	Norway	Ski
Sokolowski, Kazimierz	Poland	Hockey	Vinson, Maribel	United States	Figure Skating
Solda, Gino	Italy	Ski	von Bismarck, Hasso	Germany	Bobsleigh
Springer, Carl F	United States	Speed Skating	von Mumm, Walther	Germany	Bobsleigh
Stack, Frank	Canada	Speed Skating	Wagner, U Stanley	Canada	Hockey
Staksrud, Michael	Norway	Speed Skating	Wahlberg, Kaare	Norway	Ski
Stauffer, William	Switzerland	Bobsleigh	Walker, John	Canada	Curling
Steele, John D	United States	Ski	Wanger, Jules	Switzerland	Bobsleigh
Stenen, Ole	Norway	Ski	Wedge, Edwin	United States	Speed Skating
Steuri, Fritz	Switzerland	Ski	Weigel, Louise	United States	Figure Skating
Stewart, T Howard	Canada	Curling	Weinstengel, Hugo	Austria	Bobsleigh
Stevens, Curtis P	United States	Bobsleigh	Wheeler, Harry	Canada	Dog Derby
Stevens, F Paul	United States	Bobsleigh	Willett, George	United States	Curling
Stevens, J Hubert	United States	Bobsleigh	Williams, C B	United States	Curling
Stevens, Raymond F	United States	Bobsleigh	Willis, Errick F	Canada	Curling
Stogowski, Jozef	Poland	Hockey	Wilson, Jean	Canada	Women's Sp.Sk
Stone, Arnold V	Canada	Ski	Wilson, Montgomery	Canada	Figure Skating
Strobl, Georg	Germany	Hockey	Wilson, Ross F	Canada	Ski
Sutherland, Hugh	Canada	Hockey	Wilson-Samuel, Constance	Canada	Figure Skating
Svärd, Nils E	Sweden	Ski	Wise, J Alston	Canada	Hockey
Sylvestre, Leopold	Canada	Speed Skating	Wright, Philemon R	Canada	Ski
Szalay, Sándor	Hungary	Figure Skating	Yamada, Katsumi	Japan	Ski
Szollás, László	Hungary	Figure Skating	Zahn, Werner	Germany	Bobsleigh
Tache, Jacques R	Canada	Ski	Zardini, Ernesto	Italy	Ski
Takata, Yoichi	Japan	Ski	Zetterstrom, Olle	United States	Ski

Summary of Entries

Ski	115
Speed Skating..	32
Figure Skating..	45
Hockey	49
Bobsleig	68
Dog Derby..	13
Curling	32
Women's Speed Skating.	10
Total.	364

Xth Olympiad Summer Games

Los Angeles 1932

Los Angeles, California, will stage the Summer Games of the Xth Olympiad from July 30 to August 14, 1932. Award of these Games was made to Los Angeles by the International Olympic Committee in 1923, six years before the award of the III Olympic Winter Games of 1932 to Lake Placid.

The American Olympic Association appointed as the Organizing Committee for the Los Angeles Games the Xth Olympiad Committee, of which Colonel William May Garland is chairman. Colonel Garland has the same relation to the Los Angeles Games that Dr Godfrey Dewey, as president of the III Olympic Winter Games Committee, had to the Lake Placid Games.

The Los Angeles committee has made ample provision for housing thousands of athletes and spectators at the Games of the Xth Olympiad. The committee expects that approximately 50 nations will be represented in the Games by their greatest athletes. For housing the athletes the committee has constructed an Olympic Village, consisting of approximately 600 separate new houses. Special cooking and dining service with the special foods and cuisine of each nation will be assured under this Village plan. Cost of construction has been estimated at \$500,000.

Special rates are being offered by many railroad and steamship companies to those going to Los Angeles for the Games. Many are expected to take this opportunity to tour the United States and enjoy the Games in California prior to their return home.

Los Angeles Program

During the 16 days, competitions will be held in the following:

Athletics (Track and Field)
Boxing
Cycling
Equestrian Sports

Fencing
Field Hockey
Gymnastics
Modern Pentathlon
Shooting
Rowing
Swimming, Diving, and Water Polo
Weight-lifting
Wrestling
Yachting
National Demonstration
International Demonstration
Fine Arts

The center of Olympic activity at Los Angeles will be the Olympic stadium in Olympic park, with a seating capacity of 105,000. The stadium will be the scene of the opening and closing ceremonies, track and field athletics, gymnastics, field hockey finals, equestrian jumping events, and the demonstrations of national and international sports. Official announcements of the final results of all events, regardless of where they are held, will be made several times daily in the Olympic stadium. It will also be the scene of the award of medals to the Olympic winners.

Tickets for the Los Angeles Games are of three classes: Olympic stadium pass, season tickets for an individual sport, and tickets for single programs.

The general program of the Xth Olympiad is given on the following page.

Information

Full information concerning the Games of the Xth Olympiad may be secured by addressing

Xth Olympiad Committee
W M Garland Building, 117 West 9th Street
Los Angeles, California, USA

GENERAL PROGRAM . . . Xth OLYMPIAD . . . LOS ANGELES . . . 1932

DATE..... DAY..... Number of Day..... (M—Morning A—Afternoon E—Evening)	JULY			AUGUST																									
	30	31	1	2	3	4	5	6	7	8	9	10	11	12	13	14													
	Sat.	Sun.	Mon.	Tues.	Wed.	Thur.	Fri.	Sat.	Sun.	Mon.	Tues.	Wed.	Thur.	Fri.	Sat.	Sun.													
	1st	2nd	3rd	4th	5th	6th	7th	8th	9th	10th	11th	12th	13th	14th	15th	16th													
OPENING CEREMONY.....	M	A	E	M	A	E	M	A	E	M	A	E	M	A	E	M	A	E	M	A	E	M	A	E	M	A	E		
WEIGHTLIFTING.....	A																												
FENCING.....		B	B	B																									
ATHLETICS.....			C	C	C	C	C	C	C	C	C	C	C	C	C	C	C	C	C	C	C	C	C	C	C	C	C	C	
WRESTLING.....			A	A	A	A	A	A	A	A	A	A	A	A	A	A	A	A	A	A	A	A	A	A	A	A	A	A	
FIELD HOCKEY.....				B	B	B	B	B	B	B	B	B	B	B	B	B	B	B	B	B	B	B	B	B	B	B	B	B	
CYCLING.....				X	X	X	X	X	X	X			A				A												
PENTATHLON.....				D	D	D	E																						
YACHTING.....				X	C	H	G	X																					
SWIMMING.....								F	F	F	F	F	F	F	F	F	F	F	F	F	F	F	F	F	F	F	F	F	
DEMONSTRATION LACROSSE.....									G	G	G	G	G	G	G	G	G	G	G	G	G	G	G	G	G	G	G	G	
GYMNASTICS.....											A																		
BOXING.....																													
ROWING.....																													
EQUESTRIAN SPORTS.....																													
DEMONSTRATION AMERICAN FOOTBALL.....																													
SHOOTING.....																													
CLOSING CEREMONY.....																													

FINE ARTS..... Competitions and Exhibits on Display during period of the Games. Los Angeles County Museum—Olympic Park.

A—Olympic Stadium. B—Olympic Auditorium. C—State Armory. D—Rose Bowl E—Road Race Course (Cycling). F—Yachting Course. G—Swimming Stadium.
H—Rifle Range I—Long Beach Marine Stadium J-Riviera C. X—To be announced later.

In Conclusion

With the publication of this Official Report of the III Olympic Winter Games of 1932 the work of the Organizing Committee comes to a close.

To others will be past the banner of Winter Sports. May it be held proudly aloft. May other resorts rally around the standard which we have carried for three years to the best of our collective abilities. May Winter Sports come to stand primarily not for the enervating relaxations of warmer climes, but rather for those sports which winter alone makes possible, especially the sports on the Olympic program—ski running and jumping, speed and figure-skating, hockey, bobsledding, sled-dog racing, and curling. May the development of these sports and the facilities necessary for their enjoyment continue in the years ahead to the advantage of those communities sponsoring them and to the better health of a great nation.

It is our hope that thru the holding of the III Olympic Winter Games of 1932 in the United States the general interest and participation in Winter Sports on this side of the Atlantic will be set forward by at least a decade, if not a generation. Our part has been done. May the example of the Games carry on where we leave off.

III Olympic Winter Games Committee

Index

A

	PAGE
Advertising space, Decision not to use.....	97
Age limit for competition in Olympic Games.....	26
Amateur, Definition of an.....	25
American Olympic Association, officers and committees.....	13, 17
American Olympic Association, Relations with.....	.80, 81
American skating rules approved for III OWG.....	68
Arena, Bond issue for.....	84, 153
Arena building committee.....	154
Arena cost and seating capacity.....	156
Arena, Cost of site for.....	152
Arena, Decision to build.....	152
Arena dedication.....	154
Arena, Statement by Count Baillet-Latour on.....	151
Arena use after Games.....	157
Arena use before Games.....	154
Attachés, Rules of IOC concerning.....	33
Attendance.....	123, 125
Attendance at different events.....	125
Award of III OWG to Lake Placid, Date of.....	48

B

Baillet-Latour, Count, First visit of, to Lake Placid.....	67
Baillet-Latour, Count, Statement by.....	9
Bid for III OWG, Date of Decision to.....	45
Bids for III OWG, Places entering.....	48
Berlin Congress, Decision to send Dr Dewey to.....	58
Board of Directors, Organization of.....	54
Bob-run, Championships held at.....	165
Bob-run club-house.....	163
Bob-run construction, Beginning of.....	64
Bob-run, Data on construction and operation of.....	162, 163
Bob-run, Funds voted by state for construction of.....	162
Bob-run, Initial surveys for.....	160
Bob-run, Intervales practice.....	161
Bob-run legislation.....	.158, 162
Bob-run, Ruling of Appellate Division on site for.....	161
Bob-run sites considered.....	161
Bob-run, Stands for spectators at.....	163
Bob-run statistics on visitors and riders.....	164, 165
Bob-run, Timing room at.....	163
Bob speed record.....	164
Bobs, Description of.....	164
Bobsledding, History of, at Lake Placid.....	.39-41
Bobsleigh, description.....	241-244
Bobsleigh drawings.....	245

	PAGE
Bobsleigh events and rules.....	245
Bobsleigh governing bodies and officials.....	245
Bobsleigh, 2-man race, entries and results.....	248-249
Bobsleigh, 4-man race, entries and results.....	246-247
Bond issue of \$200,000, North Elba.....	54, 79, 80, 147
Budget control.....	83,84
Budget, Final.....	85-87
Budget,First.....	79
Budget, Intermediate.....	.82-83
By-Laws of III OWG Committee.....	.62-64

C

Civic center.....	147
Claims to judges.....	32
Clipping services.....	98
Closing ceremony.....	263
Closing ceremony, Rules and forms for conduct of.....	25
Committees and commissions, Duties of.....	73, 74
Concessions.....	130
Conclusion, statement by committee.....	279
Co-operating bodies.....	16
Curling, description.....	255, 256
Curling drawings.....	256
Curling entries and results.....	257, 258
Curling events and rules.....	256
Curling governing bodies and officials.....	256

D

Dates for III OWG.....	54
Decorations.....	131, 132
de Coubertin, Baron Pierre, Statement by.....	9
Dewey, Dr Godfrey, Speech of, at opening ceremony.....	178,179
Dinner to Dr Dewey following award of III OWG.....	.53
Diplomas, medals, and badges.....	.126
Dressing-rooms.....	149

E

Entries, Alphabetic list of.....	274-276
Entries, Forms and methods of handling.....	117-122
Entries, IOC rules for.....	.26, 31
Entries, Number of.....	122
Essex county contribution.....	85
Essex county Park Commission, Bill creating.....	58
Executive committee named.....	60
Executive committee OWG, Tentative.....	53
Executive secretary, Gamache engaged as.....	60

F	PAGE
Feeding Games visitors.....	131
Figure-skating, description.....	213, 217
Figure-skating events and rules.....	217
Figure-skating governing bodies and officials.....	217
Figure-skating men, entries and results.....	218, 219
Figure-skating pairs, entries and results.....	222, 223
Figure-skating prescribed school figures.....	217
Figure-skating women, entries and results.....	220, 221
Finance, Complete report of.....	79 - 92
Flags.....	24
Funds, Final liquidation of.....	91, 92

G

Gate receipts arranged by facilities.....	125
General organization.....	73-78
Guarantee fund, Original, solicited.....	46

H

Headquarters, Organizing Committee.....	147
Health and safety.....	115, 116
History of Olympic Winter Games.....	35, 36
History of winter sports at Lake Placid.....	37-42
Hockey, description.....	225, 226
Hockey entries and results.....	228-235
Hockey events and rules.....	227
Hockey exhibition games, results.....	237-239
Hockey governing bodies and officials.....	227
Hockey, History of, at Lake Placid.....	39
Housing committee named.....	111
Housing director, O'Hare named.....	68, 112
Housing in nearby communities.....	111, 112
Housing office procedure.....	113, 114
Housing preliminary survey.....	109
Housing, Pullman plan.....	111
Housing rates for contestants and officials.....	111, 112
Housing, Rules of IOC concerning.....	33
Housing second survey.....	109
Housing summary of accommodations.....	114, 115
Housing teams and officials.....	114
Housing third survey.....	111

I

Information service.....	130
International federations, List of.....	33
IOC members, Seating, in stadium.....	168

	PAGE
IOC officers and members.....	11, 12
International secretary.....	128
International Skating Union, Decision to send Dr Dewey to congress of.....	68
Invitation to participate in Olympic Games, Form of.	23
Invitations to III OWG, Countries sent	57, 58

J

Judging events	31
Jury of honor.	32

L

Lake Placid Club starts winter sports.....	37
Lake Placid, Location of.....	37

M

“March Past”, Order of Nations in.....	168
Medical attention.....	132
Merchandising and advertising tie-ups.....	99, 100
Motion pictures, IOC rules concerning.....	34
Motion picture publicity.....	100, 105
Music	131

N

National committees, Material sent.....	70
National delegations, Courtesies extended, on arrival	128, 129
Nations entered, Lists of.....	70, 72
Newspaper and magazine files.....	97
New York State OWG Commission, officers and members	15, 21, 22
North American speed-skating distances.....	38

O

Office lay-out	117
Officers and committees, Lists of.	11-16
Olympic committee, Temporary.....	45
Olympic construction at Lake Placid, Beginning of	57
Olympic bills past at Albany.....	47
Olympic Games, Dates of	35
Olympic organization, International	35
Olympic state legislation, First	46
Olympic Winter Games, Dates of holding.....	36
Opening ceremony	167-180
Opening ceremony, Rules and forms for conduct of	24

	PAGE
Organization of different sports, IOC rules for.....	31
Organizing Committee, Approval by A O A given.....	54
Organizing Committee, Duties of.....	23, 26, 31
Organizing Committee, Officers, directors, and members of.....	.14, 15
Outside superintendent, Garren named as.....	67

P

Park Commission, North Elba.....	54
Park district, Size of.....	147
Participation, Table of, III OWG.....	270
Penalties in case of fraud.....	32
Personnel, executive staff.....	74,77
Point scoring, Explanation of.....	264
Policing during Games.....	116
Press, Arrangements for.....	104,114
Press box in stadium.....	148
Printed matter, summary and explanation.....	105-108
Prizes, IOC rules for, and list of.....	32
Program, Official Olympic.....	26
Program, III OWG.....	272, 273
Proposal of Lake Placid to IOC, Date of sending.....	47
Proposal of Lake Placid to IOC, Text of.....	49-52
Publicity changes in Lake Placid office.....	68
Publicity Committee named.....	64
Publicity, Domestic.....	97-103
Publicity during Games.....	103-105
Publicity, Foreign.....	93,96
Publicity, General plan of.....	93
Publicity, General report of.....	93,108
Publicity, Organization chosen to direct.....	67, 93

R

Radio broadcasting booths.....	149
Radio, Use of.....	100, 104, 105
Rate concessions on steamship and railroad lines.....	70
Real estate board.....	112
Receipts and expenditures, Final statement of.....	.88-90
Representing a country, Necessary conditions for.....	.25, 26
Reserved seats, IOC rules for officials in.....	33
Roosevelt, Governor, Speech of, at opening ceremony.....	.179, 180
Roosevelt, Governor, invited to open Games.....	69
Rules and Protocol of IOC.....	.23-34

S

Saranac Lake pledge fund.....	47
Seating capacities at facilities.....	141
Shea, Jack, North American speed-skating champion.....	38

	PAGE
Skeleton run elimination by Berlin Congress.	64
Ski, combined event, description.	183, 184
Ski, combined event, entries and results.	194-198
Ski drawings	186
Ski events and rules.	186
Ski governing bodies and officials.. . . .	185-186
Ski hill, Intervales, History and description.	141-143
Ski hill, Intervales, Record jump at.. . . .	142
Ski-jump, description.	184
Ski-jump, entries and results.. . . .	200-203
Ski trails, Lay-out of.	145-146
Ski, 18-km race, description.	181
Ski, 18-km race, entries and results.. . . .	187-188
Ski, 50-km race, description.. . . .	182, 183
Ski, 50-km race, entries and results.	193
Ski waxing rooms	149
Skiing, History of, at Lake Placid.	38, 39
Sled-dog race, description.	251, 252
Sled-dog race, drawings.	253
Sled-dog race, entries and results.	253, 254
Sled-dog race, events and rules.	253
Sled-dog race, governing bodies and officials.	253
Social affairs	132, 137-139
Souvenir book.	129
Speed-skating, description.	205, 206
Speed-skating, drawings	208
Speed-skating, events and rules.	208
Speed-skating, governing bodies and officials.	207, 208
Speed-skating, History of, at Lake Placid.	37, 38
Speed-skating, 500-meter race, entries and results.	209
Speed-skating, 1500-meter race, entries and results.	210
Speed-skating, 5000-meter race, entries and results.	211
Speed-skating, 10,000-meter race, entries and results.	212
Sports committees.	15, 16
Stadium	60
Stadium cost.	150
Stadium excavation, Yardage moved in.	148
Stadium on opening day	168
Stadium seating capacity.	149
Stadium site and acreage.	147
Stadium stands, Description of.	149
Stadium stands, Chart of.	148, 149
Stadium track.	148
Standing committees	15
Standing committee chairmen named.	64
State appropriation, \$125,000.	60, 80
State appropriation, \$375,000.. . . .	67, 83
State OWG Commission, Members of.	60-61
“Still Pictures”.	98-105
Summer Games, Xth Olympiad, Los Angeles.	277, 278

T	PAGE
Table of honor, Chamonix.....	266
Table of honor, IOC rules for.....	32
Table of honor, Lake Placid.....	268
Table of honor, Lake Placid demonstrations.....	269
Table of honor, Location of.....	150
Table of honor, St Moritz.....	267
Telegraph and cable arrangements and files.....	104
Telephone service.....	117
Thunberg-Jewtraw speed-skating match.....	38
Tickets, Prices and kinds of.....	122, 123
Time and duration of Olympic Games.....	23
Transportation at OWG.....	115
Traveling expenses of competitors.....	33
III OWG Committee, Annual meeting of.....	68
III Olympic Winter Games, How, were awarded to Lake Placid.....	43-52

U

US postage stamp for III OWG.....	103
Ushers.....	130

W

Weather conditions, Data on.....	70, 72
Winter Games, IOC rules for holding.....	23-26
Winter sports, Early, at Lake Placid.....	37-42
Winter sports programs at Lake Placid, Organizations backing.....	41, 42
Women, Participation by, in Olympic Games.....	26
Women's speed-skating, description.....	259
Women's speed-skating, drawings.....	260
Women's speed-skating, events and rules.....	260
Women's speed-skating, governing bodies and officials.....	260
Women's speed-skating recognized.....	69
Women's speed-skating, 500-meter race, entries and results.....	261
Women's speed-skating, 1000-meter race, entries and results.....	262
Women's speed-skating, 1500-meter race, entries and results.....	262

List of Illustrations

	PAGE
Jack Shea takes Olympic oath.....	6
Baron Pierre de Coubertin.....	8
Count de Baillet-Latour.....	9
Air view of Mt Tahawus.....	10
Officers of American Olympic Association.....	17
Officers and directors of III OWG Committee.....	18-20
New York State OWG Commission.....	21, 22
Olympic skating track.....	27
Air view of Mt Van Hoevenberg bob-run.....	28
Cross-country ski-runner.....	29
Frozen water fall.....	30
III OWG display at Grand Central station.....	34
Cars at entrance to bob-run.....	36
Automobile windshield sticker.....	39
Sticker stamps.....	40, 41
Map of Lake Placid village.....	44
Model poses with OWG poster.....	48
North Elba town hall.....	52
Stadium ready for the Games.....	55
Looking down bob-run.....	56
Invitation to National Olympic committees.....	57
Ted Husing broadcasting.....	59
New York state police detail.....	59
III OWG Committee letter-head.....	61
III OWG Committee news bulletin letter-head.....	61
Hockey boxes and skating track.....	65
Whiteface mountain.....	66
Invitation to Governor Roosevelt to open Games.....	69
Railroad and steamship forms.....	71
Lake Placid ski trail.....	72
Executive and office staff.....	75
High school and stadium.....	76
Arena.....	76
Scene on ski trail.....	77
Organization chart.....	78
Olympic skaters rounding turn.....	85
High school.....	91
Lakes Mirror and Placid.....	92
First Games poster.....	94
Second Games poster.....	95
George Hicks broadcasting.....	97
Broadside sent advertisers.....	101
Reverse of broadside.....	102
Metropolitan window display.....	103
US postage stamp to commemorate III OWG.....	103
Press ticket.....	107
Agreement with hotel and cottage owners.....	110
Young lady members of staff.....	113
Secretary Gamache at desk.....	118
National entry form.....	119
Team entry form.....	120
Individual entry form.....	121
Ticket office.....	123

	PAGE
OWG tickets.....	124
Commemorative medal.....	126
III OWG diploma.....	127
III OWG badges without ribbon.....	128
Place medal.....	129
Tractor clearing snow from highway.....	130
Dinner for Governor Roosevelt.....	133
Officials at Games opening.....	134
Tractor at bob-run.....	135
Southern mountain range.....	136
III OWG badge with ribbon.....	138
Invitation to dinner for Governor Roosevelt.....	139
Olympic stadium chart.....	140
Plan and elevation of Olympic ski-hill.....	142
Seating plan at Olympic ski-hill.....	143
Stanislaus Zentzytzki.....	147
Stadium grandstand.....	148, 149
Olympic arena floor before completion.....	151
Olympic arena floor plans.....	153
Arena stands.....	155
Hockey in arena.....	156
Bob-run plan.....	158
Crowd in stands at Zig-zag.....	160
Bob-run button.....	163
Bob-run waiver form.....	164
Roumanian bob team at Shady Corner.....	165
USA 4-man bob team No 1.....	166
USA 4-man bob team No 2.....	166
Workmen finishing Zig-tag turn.....	169
Icing Shady Corner.....	170
Austrian 2-man bob team.....	171
USA 4-man bob team No 1 at Shady Corner.....	172
Swiss bob team at Whiteface Curve.....	172
Teams in parade past reviewing stand at opening ceremony.....	173-178
Sven Eriksson, Sweden.....	179
Dr Godfrey Dewey and Count Baillet-Latour.....	180
Finish of 18-kilometer ski race.....	182
Rear Admiral Byrd and Avery Brundage.....	184
Feeding station during 50-kilometer ski race.....	185
Reidar Andersen, Norway.....	186
Members of Swedish team.....	187
Sven Utterström, Sweden.....	188
Czechoslovakian ski team.....	189
Norton Billings, USA.....	190
Sigmund and Birger Ruud, Norway.....	190
Ski-hill.....	190
Birger Ruud, Norway, on ski-hill.....	191
Johan Grøttumsbraaten, Norway, on ski-hill.....	192
Veli Saarinen, Finland.....	193
Winter shadows.....	194
Johan Grøttumsbraaten, Norway.....	195
18 and 50-kilometer ski race courses.....	199
Andrzej Marusarz, Poland.....	200
Birger Ruud, Norway.....	201
Finishes of four speed-skating races.....	204
Norwegian speed-skaters.....	205

	PAGE
Japanese speed-skaters.....	206
United States speed-skaters.....	207
Canadian speed-skaters.....	208
Jack Shea, USA.....	209, 210
Irving Jaffee USA,.....	211, 212
Karl Schäfer, Austria.....	214
Sonja Henie, Norway.....	214
Olympic figure-skaters.....	215, 216, 224
Karl Schafer, Austria.....	218
Sonja Henie, Norway.....	220
Mr and Mrs Brunet, France.....	222
Canada vs Germany hockey.....	224
Canada vs U S A hockey.....	225, 227
USA hockey team.....	226
German hockey team.....	228
Canadian hockey team.....	235
Poland vs USA hockey.....	236
Polish hockey team.....	236
Snowed in.....	239
Martineau bob trophy presented to William L Fiske, USA.....	240
USA 4-man bob team No 2 rounding Shady Corner.....	240
USA 2-man bob team.....	241
Drawing of 4-man bobsled.....	243
Identity card.....	244
German 4-man bob team No 1.....	245
William L Fiske, USA..	247
Crowd at finish line at bob-run.....	248
J H Stevens, USA.....	249
Contour map of Lake Placid section showing sled-dog race course.....	250
Leonard Seppala, USA.....	251
Roger Haines, USA.....	252
Emil St Goddard, Canada.....	254
Curling match.....	256
Manitoba curling club, Canada.....	258
Finishes of women's speed-skating races.....	258
Jean Wilson, Canada.....	261
Elizabeth Dubois, USA.....	262
Kit Klein, USA.....	262
Closing ceremony.....	263
Finish of 50-kilometer ski race.....	264
Table of honor on stadium wall.....	265
Winter lights and shadows.....	271
Along the trail.....	291



Along the trail

—Pierzon Studio

Notes on the digitized version of the Official Report of the III Olympic Winter Games, Lake Placid, 1932

The digital version of the Official Report of the III Olympic Winter Games was created with the intention of producing the closest possible replica of the original printed document. These technical notes are intended to describe the differences between the digital and printed documents and the technical details of the digital document.

The original document

The original paper version of the 1932 Winter Games Official Report has dimensions of 8 x 11” (20.5cm x 28cm). The words “III Olympic Winter Games – Lake Placid, 1932” are printed on the spine. The back cover is plain. The cover has a pebbled surface with an inset frame. The cover image is embossed in gilt. The book is 291 pages with one blank page of heavy bond paper at both the front and back of the book. There is a title page with the words “Official Report, III Olympic Winter Games, Lake Placid 1932. Issued by III Olympic Winter Games Committee, Lake Placid, NY, U.S.A. Compiled by George M. Lattimer.” The primary font used in the book is Minion Regular. Photograph captions are in Times New Roman.

Special features of the digital version:

- * The back cover and the binding are not included in the digital version.
- * Blank pages at the front and back of the book are not represented in the digital version.
- * Photos in landscape format were rotated from vertical to horizontal to make viewing easier.
- * The digital version includes a bookmark list, which functions as a hyperlinked table of contents. Selecting a topic heading will take you to the corresponding section in the document.
- * The final pages of the document contain an original index and list of illustrations for the book. The index and illustration entries also are hyperlinked. Selecting an entry will take you to the corresponding section in the book.

Profile of the digital version:

File name:	1932w.pdf
File size:	18,027 KB
Format:	Adobe Acrobat Portable Document Format (PDF), Version 3.0
Source document:	III Olympic Winter Games, Lake Placid, 1932 Official Report. Olympic Winter Games Committee; Lake Placid, New York, USA. Compiled by George M. Lattimer, 1932.
Creation Platform:	Windows 95
Conversion Date:	January 1998
Conversion Software:	Adobe Capture, Adobe Acrobat 3.0, EnFocus Pitstop
Image Resolution:	72 dpi for color and grayscale images
Digital Fonts:	Minion Regular, Times New Roman.
Conversion Services:	Glyphica, 2224 Old Middlefield Way, Mountain View, CA 94043. www.glyphica.com

