

Florentin **S**marandache
(author and editor)

Collected **P**apers
(on various scientific topics)

Volume XIII

Global
Knowledge
2022

Florentin Smarandache

(author and editor)

Collected Papers

(on various scientific topics)

Volume XIII

Peer-Reviewers:

Mohamed Abdel-Basset

Faculty of Computers and Informatics, Zagazig University, Sharqiyah, EGYPT
analyst_mohamed@yahoo.com

Bui Cong Cuong

Vietnam Academy of Science and Technology, Hanoi, SR VIETNAM
bccuong@gmail.com

Luu Quoc Dat

VNU University of Economics and Business, Vietnam National University, Hanoi, SR VIETNAM
datlq@vnu.edu.vn

Le Hoang Son

Vietnam National University, Hanoi, SR VIETNAM
sonlh@vnu.edu.vn

Nguyen Xuan Thao

Faculty of Information Technology, Vietnam National University of Agriculture, SR VIETNAM
nxthao2000@gmail.com

A. A. Salama

Department of Math. and Computer Science, Faculty of Sciences, Port Said University, EGYPT
drsalama44@gmail.com

Muhammad Akram

University of the Punjab, Lahore, PAKISTAN
m.akram@puclt.edu.pk

Florentin Smarandache

(author and editor)

Collected Papers

(on various scientific topics)

Volume XIII

GLOBAL KNOWLEDGE

Publishing House

Miami, United States of America

2022

Editors:

GLOBAL KNOWLEDGE - Publishing House

848 Brickell Ave Ste 950 Miami
Florida 33131, United States
<https://egk.ccgecon.us>
info@egk.ccgecon.us

ADSUMUS – Scientific and Cultural Society

13, Dimitrie Cantemir St.
410473 Oradea City, Romania
<https://adsumus.wordpress.com/>
ad.sumus@protonmail.com

NSIA Publishing House

Neutrosphic Science International Association

<https://www.publishing-nsia.com/>
University of New Mexico, Gallup, United States Universidad
Regional Autónoma de los Andes (UNIANDES), Babahoyo,
Los Rios, Ecuador

Publishing:

Prof. Dan Florin Lazar

lazar.danflorin@yahoo.com

Prof. Dr. Maykel Yelandi Leyva Vazquez

ub.c.investigacion@uniandes.edu.ec

ISBN 978-1-59973-745-4

Introductory Note

This thirteenth volume of Collected Papers is an eclectic tome of 88 papers in various fields of sciences, such as astronomy, biology, calculus, economics, education and administration, game theory, geometry, graph theory, information fusion, decision making, instantaneous physics, quantum physics, neutrosophic logic and set, non-Euclidean geometry, number theory, paradoxes, philosophy of science, scientific research methods, statistics, and others, structured in 17 chapters (Neutrosophic Theory and Applications; Neutrosophic Algebra; Fuzzy Soft Sets; Neutrosophic Sets; Hypersoft Sets; Neutrosophic Semigroups; Neutrosophic Graphs; Superhypergraphs; Plithogeny; Information Fusion; Statistics; Decision Making; Extenics; Instantaneous Physics; Paradoxism; Mathematica; Miscellanea), comprising 965 pages, published between 2005-2022 in different scientific journals, by the author alone or in collaboration with the following 110 co-authors (alphabetically ordered) from 26 countries: Abdullah Gamal, Sania Afzal, Firoz Ahmad, Muhammad Akram, Sheriful Alam, Ali Hamza, Ali H. M. Al-Obaidi, Madeleine Al-Tahan, Assia Bakali, Atiqe Ur Rahman, Sukanto Bhattacharya, Bilal Hadjadji, Robert N. Boyd, Willem K.M. Brauers, Umit Cali, Youcef Chibani, Victor Christianto, Chunxin Bo, Shyamal Dalapati, Mario Dalcín, Arup Kumar Das, Elham Davneshvar, Bijan Davvaz, Irfan Deli, Muhammet Deveci, Mamouni Dhar, R. Dhavaseelan, Balasubramanian Elavarasan, Sara Farooq, Haipeng Wang, Ugur Halden, Le Hoang Son, Hongnian Yu, Qays Hatem Imran, Mayas Ismail, Saeid Jafari, Jun Ye, Ilanthenral Kandasamy, W.B. Vasantha Kandasamy, Darjan Karabašević, Abdullah Kargin, Vasilios N. Katsikis, Nour Eldeen M. Khalifa, Madad Khan, M. Khoshnevisan, Tapan Kumar Roy, Pinaki Majumdar, Sreepurna Malakar, Masoud Ghods, Minghao Hu, Mingming Chen, Mohamed Abdel-Basset, Mohamed Talea, Mohammad Hamidi, Mohamed Loey, Mihnea Alexandru Moisescu, Muhammad Ihsan, Muhammad Saeed, Muhammad Shabir, Mumtaz Ali, Muzzamal Sitara, Nassim Abbas, Munazza Naz, Giorgio Nordo, Mani Parimala, Ion Pătrașcu, Gabrijela Popović, K. Porselvi, Surapati Pramanik, D. Preethi, Qiang Guo, Riad K. Al-Hamido, Zahra Rostami, Said Broumi, Saima Anis, Muzafer Saračević, Ganeshsree Selvachandran, Selvaraj Ganesan, Shammya Shananda Saha, Marayanagaraj Shanmugapriya, Songtao Shao, Sori Tjandrah Simbolon, Florentin Smarandache, Predrag S. Stanimirović, Dragiša Stanujkić, Raman Sundareswaran, Mehmet Şahin, Ovidiu-Ilie Şandru, Abdulkadir Şengür, Mohamed Talea, Ferhat Taş, Selçuk Topal, Alptekin Ulutaş, Ramalingam Udhayakumar, Yunita Umniyati, J. Vimala, Luige Vlăduţeanu, Ştefan Vlăduţescu, Yaman Akbulut, Yanhui Guo, Yong Deng, You He, Young Bae Jun, Wangtao Yuan, Rong Xia, Xiaohong Zhang, Edmundas Kazimieras Zavadskas, Zayen Azzouz Omar, Xiaohong Zhang, Zhirou Ma.

Keywords

Neutrosophy; Neutrosophic Logic; Neutrosophic Sets; Neutrosophic Topology; Neutrosophic Hypergraphs; Intuitionistic Fuzzy Parameters; Conventional Optimization Methods; Multiobjective Transportation Problem; Decision Making; Extenics; Classical Algebra; NeutroAlgebra; AntiAlgebra; NeutroOperation; AntiOperation; NeutroAxiom; AntiAxiom; Intuitionistic Fuzzy Soft Expert Set; Inclusion Relation; Neutrosophic Rough Set; Multi-Attribute Group Decision-Making; Multigranulation Neutrosophic Rough Set; Soft Set; Soft Expert Set; Hypersoft Set; Hypersoft Expert Set; Plithogeny; Plithogenic Set; Plithogenic Logic; Plithogenic Probability; Plithogenic Statistics; Safire Project; Infinite Velocity; Coulomb Potential; Kurepa function; Smarandache-Kurepa function; 2019 Novel Coronavirus; Deep Transfer Learning; Machine Learning; COVID-19; SARS-CoV-2; Convolutional Neural Network; Principle of Parsimony; Popperian Epistemology; Post-Empiricism Doctrine; Ockham Optimality Point; Belief Function; Dezert-Smarandache Theory; Neutrosophic Probability; Importance Discounting Factors.

Florentin Smarandache is an emeritus prof. dr. of mathematics at the University of New Mexico, United States. He got his MSc in Mathematics and Computer Science from the University of Craiova, Romania, PhD in Mathematics from the State University of Kishinev, and Postdoctoral in Applied Mathematics from Okayama University of Sciences, Japan, and The Guangdong University of Technology, Guangzhou, China. He is the founder of neutrosophy (generalization of dialectics), neutrosophic set, logic, probability and statistics since 1995 and has published hundreds of papers and books on neutrosophic physics, superluminal and instantaneous physics, unmatter, quantum paradoxes, absolute theory of relativity, redshift and blueshift due to the medium gradient and refraction index besides the Doppler effect, paradoxism, outerart, neutrosophy as a new branch of philosophy, Law of Included Multiple-Middle, multispace and multistructure, hypersoft set, IndetermSoft Set and IndetermHyperSoft Set, SuperHyperGraph, SuperHyperTopology, SuperHyperAlgebra, Neutrosophic SuperHyperAlgebra, degree of dependence and independence between neutrosophic components, refined neutrosophic set, neutrosophic over-under-off-set, plithogenic set / logic / probability / statistics, neutrosophic triplet and duplet structures, quadruple neutrosophic structures, extension of algebraic structures to NeutroAlgebra and AntiAlgebra, NeutroGeometry & AntiGeometry, Dezert-Smarandache Theory and so on to many peer-reviewed international journals and many books and he presented papers and plenary lectures to many international conferences around the world.



outerart, neutrosophy as a new branch of philosophy, Law of Included Multiple-Middle, multispace and multistructure, hypersoft set, IndetermSoft Set and IndetermHyperSoft Set, SuperHyperGraph, SuperHyperTopology, SuperHyperAlgebra, Neutrosophic SuperHyperAlgebra, degree of dependence and independence between neutrosophic components, refined neutrosophic set, neutrosophic over-under-off-set, plithogenic set / logic / probability / statistics, neutrosophic triplet and duplet structures, quadruple neutrosophic structures, extension of algebraic structures to NeutroAlgebra and AntiAlgebra, NeutroGeometry & AntiGeometry, Dezert-Smarandache Theory and so on to many peer-reviewed international journals and many books and he presented papers and plenary lectures to many international conferences around the world.

In addition, he published many books of poetry, dramas, children' stories, translations, essays, a novel, folklore collections, traveling memories, and art albums [<http://fs.unm.edu/FlorentinSmarandache.htm>].

Contents

NEUTROSOPHIC THEORY AND APPLICATIONS

Florentin Smarandache, Luige Vlădăreanu

Applications of neutrosophic logic to robotics: An introduction / 34

Ferhat Taş, Selçuk Topal, Florentin Smarandache

Clustering Neutrosophic Data Sets and Neutrosophic Valued Metric Spaces / 40

Victor Christianto, Robert N. Boyd, Florentin Smarandache

Three possible applications of Neutrosophic Logic in Fundamental and Applied Sciences / 52

Florentin Smarandache

Indeterminacy in Neutrosophic Theories and their Applications / 58

Firoz Ahmad, Florentin Smarandache, Arup Kumar Das

Neutrosophical fuzzy modeling and optimization approach for multiobjective four-index transportation problem / 67

NEUTROSOPHIC ALGEBRA

Said Broumi, Florentin Smarandache, Pabitra Kumar Maji

Intuitionistic Neutrosophic Soft Set over Rings / 99

W.B. Vasantha Kandasamy, K. Ilanthenral, Florentin Smarandache

Modified Collatz conjecture or $(3a+1)+(3b+1)I$ Conjecture for Neutrosophic Numbers $\langle \mathbb{Z} \cup I \rangle$ / 106

W.B. Vasantha Kandasamy, Ilanthenral Kandasamy, Florentin Smarandache

Neutrosophic Duplets of $\{\mathbb{Z}_{pn}, x\}$ and $\{\mathbb{Z}_{pq}, x\}$ and Their Properties / 109

D. Preethi, S. Rajareega, J. Vimala, Ganeshsree Selvachandran, Florentin Smarandache

Single-Valued Neutrosophic Hyperrings and Single-Valued Neutrosophic Hyperideals / 117

Riad K. Al-Hamido, Mayas Ismail, Florentin Smarandache

The Polar form of a Neutrosophic Complex Number / 125

Muhammad Saqlain, Florentin Smarandache

Octagonal Neutrosophic Number: Its Different Representations, Properties, Graphs and De-neutrosophication with the application of Personnel Selection / 134

Florentin Smarandache

NeutroAlgebra & AntiAlgebra vs. Classical Algebra / 149

FUZZY SOFT SETS

Said Broumi, Florentin Smarandache, Mamoni Dhar

On Fuzzy Soft Matrix Based on Reference Function / 156

Said Broumi, Pinaki Majumdar, Florentin Smarandache

New Operations on Intuitionistic Fuzzy Soft Sets based on Second Zadeh's logical Operators / 163

Said Broumi, Florentin Smarandache, Mamoni Dhar, Pinaki Majumdar

New Results of Intuitionistic Fuzzy Soft Set / 170

Said Broumi, Florentin Smarandache

Mapping on Intuitionistic Fuzzy Soft Expert Sets / 176

NEUTROSOPHIC SETS

Said Broumi, Pinaki Majumdar, Florentin Smarandache

New Operations on Intuitionistic Fuzzy Soft Sets Based on First Zadeh's Logical Operators / 187

Irfan Deli, Said Broumi, Florentin Smarandache

On neutrosophic refined sets and their applications in medical diagnosis / 198

Qays Hatem Imran, F. Smarandache, Riad K. Al-Hamido, R. Dhavaseelan

On Neutrosophic Semi Alpha Open Set / 209

Mani Parimala, Florentin Smarandache, Saeid Jafari, Ramalingam Udhayakumar

On Neutrosophic $\alpha\gamma$ -Closed Sets / 215

Chunxin Bo, Xiaohong Zhang, Songtao Shao, Florentin Smarandache

New Multigranulation Neutrosophic Rough Set with Applications / 222

Florentin Smarandache, Said Broumi

True-False Set is a particular case of the Refined Neutrosophic Set / 236

Selvaraj Ganesan, Florentin Smarandache

Neutrosophic Biminimal α -Open Sets / 240

Qays Hatem Imran, Ali H. M. Al-Obaidi, Florentin Smarandache, Said Broumi

On Neutrosophic Generalized Semi Generalized Closed Sets / 249

HYPERSOFT SETS

Florentin Smarandache

Introduction to the IndetermSoft Set and IndetermHyperSoft Set / 261

Florentin Smarandache

Introducción a los conjuntos IndetermSoft e IndetermHyperSoft Sets / 282

Muhammad Ihsan, Muhammad Saeed, Atiqe Ur Rahman, Florentin Smarandache

An Inclusive Study on Fundamentals of Hypersoft Expert Set with Application / 304

NEUTROSOPHIC SEMIGROUPS

Mumtaz Ali, Florentin Smarandache, Muhammad Shabir, Munazza Naz

Neutrosophic Bi-LA-Semigroup and Neutrosophic N-LA-Semigroup / 323

Mumtaz Ali, Muhammad Shabir, Florentin Smarandache, Luige Vlădăreanu

Neutrosophic LA-Semigroup Rings / 329

Madad Khan, Florentin Smarandache, Sania Afzal

Neutrosophic Set Approach for Characterizations of Left Almost Semigroups / 337

Madad Khan, Saima Anis, Florentin Smarandache, Young Bae Jun

Neutrosophic N-structures and their applications in semigroups / 353

Minghao Hu, Florentin Smarandache, Xiaohong Zhang

On Neutrosophic Extended Triplet LA-hypergroups and Strong Pure LA-semihypergroups / 369

K. Porselvi, Balasubramanian Elavarasan, F. Smarandache

Neutrosophic N-interior ideals in semigroups / 391

Madeleine Al-Tahan, F. Smarandache, Bijan Davvaz

NeuroOrderedAlgebra: Applications to Semigroups / 402

Xiaohong Zhang, Wangtao Yuan, Mingming Chen, Florentin Smarandache

A Kind of Variation Symmetry: Tarski Associative Groupoids (TA-Groupoids) and Tarski Associative Neutrosophic Extended Triplet Groupoids (TA-NET-Groupoids) / 417

Madeleine Al-Tahan, Bijan Davvaz, Florentin Smarandache, Osman Anis

Properties of Productional NeuroOrderedSemigroups / 437

NEUTROSOPHIC GRAPHS

Muhammad Akram, Muzzamal Sitara, Florentin Smarandache

Graph Structures in Bipolar Neutrosophic Environment / 451

Yanhui Guo, Yaman Akbulut, Abdulkadir Şengür, Rong Xia, Florentin Smarandache

An Efficient Image Segmentation Algorithm Using Neutrosophic Graph Cut / 471

Said Broumi, Raman Sundareswaran, Marayanagaraj Shanmugapriya, Giorgio Nordo, Mohamed Talea, Assia Bakali, Florentin Smarandache

Interval-Valued Fermatean Neutrosophic Graphs / 496

SUPERHYPERGRAPHS

Florentin Smarandache

Introduction to the n-SuperHyperGraph - the most general form of graph today / 522

Masoud Ghods, Zahra Rostami, Florentin Smarandache

Introduction to Neutrosophic Restricted SuperHyperGraphs and Neutrosophic Restricted SuperHyperTrees / 525

Mohammad Hamidi, Florentin Smarandache, Elham Davneshvar

Spectrum of Superhypergraphs via Flows / 533

PLITHOGENY

Florentin Smarandache

Plithogenic Probability & Statistics are generalizations of MultiVariate Probability & Statistics / 545

Florentin Smarandache

Plithogeny, Plithogenic Set, Logic, Probability, and Statistics: A Short Review / 555

INFORMATION FUSION

Florentin Smarandache

Indeterminate masses, elements and models in information fusion / 560

Florentin Smarandache, Nassim Abbas, Youcef Chibani, Bilal Hadjadji, Zayen Azzouz Omar

PCR5 and Neutrosophic Probability in Target Identification (revisited) / 568

Qiang Guo, Haipeng Wang, You He, Yong Deng, Florentin Smarandache

An Evidence Fusion Method with Importance Discounting Factors based on Neutrosophic Probability Analysis in DS_mT Framework / 572

STATISTICS

Sreepurna Malakar, Florentin Smarandache, S. Bhattacharya

Statistical Modeling of Primary Ewing Tumours of the Bone / 583

Sukanto Bhattacharya, Florentin Smarandache

Effective Number of Parties in a Multi-Party Democracy under an entropic political equilibrium with floating voters / 591

Florentin Smarandache

Short Note on Neutrosophic Statistics as a generalization of Classical Statistics / 600

DECISION MAKING

S. Bhattacharya, Florentin Smarandache, M. Khoshnevisan

MASS - Modified Assignment Algorithm in Facilities Layout Planning / 614

Shyamal Dalapati, Surapati Pramanik, Sheriful Alam, Florentin Smarandache, Tapan Kumar Roy

IN-cross Entropy Based MAGDM Strategy under Interval Neutrosophic Set Environment / 625

Mehmet Şahin, Abdullah Kargın, Florentin Smarandache

Generalized Single Valued Triangular Neutrosophic Numbers and Aggregation Operators for Application to Multi-attribute Group Decision Making / 640

Mohamed Abdel-Basset, Florentin Smarandache, Jun Ye

Special issue on “Applications of neutrosophic theory in decision making-recent advances and future trends” / 674

Mohamed Abdel-Basset, Abdullallah Gamal, Le Hoang Son, Florentin Smarandache

A Bipolar Neutrosophic Multi Criteria Decision Making Framework for Professional Selection / 676

Sara Farooq, Ali Hamza, Florentin Smarandache

Linear and Non-Linear Decagonal Neutrosophic numbers: Alpha Cuts, Representation, and solution of large MCDM problems / 697

Umit Cali, Muhammet Deveci, Shamma Shananda Saha, Ugur Halden, Florentin Smarandache

Prioritizing Energy Blockchain Use Cases Using Type-2 Neutrosophic Number Based EDAS / 715

Alptekin Ulutaş, Dragiša Stanujkić, Darjan Karabašević, Gabrijela Popović, Edmundas Kazimieras Zavadskas, Florentin Smarandache, Willem K.M. Brauers

Developing of a Novel Integrated MCDM MULTIMOOSRAL Approach for Supplier Selection / 732

Dragiša Stanujkić, Darjan Karabašević, Gabrijela Popović, Florentin Smarandache, Predrag S. Stanimirović, Muzafer Saračević, Vasilios N. Katsikis

A Single Valued Neutrosophic Extension of the Simple WISP Method / 748

EXTENICS

Florentin Smarandache

Generalizations of the Distance and Dependent Function in Extenics to 2D, 3D, and n-D / 765

Florentin Smarandache

Connections between Extension Logic and Refined Neutrosophic Logic / 773

Victor Vlădăreanu, Ovidiu-Ilie Şandru, Mihnea Alexandru Moisescu, Florentin Smarandache, Hongnian Yu

The Extenics Norm Applied to a Two-Dimensional Robotic Workspaces / 778

INSTANTANEOUS PHYSICS

Florentin Smarandache

Parameterized Special Theory of Relativity (PSTR) / 785

Florentin Smarandache

Relations between Distorted and Original Angles in STR / 787

Victor Christianto, Florentin Smarandache, Yunita Umniyati

Remark on possible binary companion of the sun: towards a symmetric cosmology model which may be called Quantum Liquid Dirac-Milne (QLDM) model / 791

Robert N. Boyd, Victor Christianto, Florentin Smarandache

Remark on creation and dis-creation processes related to origination of charge and matter / 797

Yunita Umniyati, Victor Christianto, Florentin Smarandache

A New Hypothesis of Spin Supercurrent as Plausible Mechanism of Biological Nonlocal Interaction, Synchronicity, Quantum Communication / 806

Robert N. Boyd, Florentin Smarandache

The electric Coulomb field travels with an infinite velocity: Remarks on Naudin's experiment, Montagnier-Gariaev's experiments, and Lienert-Wiechart potential / 820

Robert N. Boyd, Florentin Smarandache

Remark on Project Greenglow and Rodin coil / 825

Robert N. Boyd, Florentin Smarandache

Remark on the Safire Project's findings and infinite velocity beyond speed of light / 827

PARADOXISM

Florentin Smarandache

The Paradoxism in Mathematics, Philosophy, and Poetry / 832

Florentin Smarandache

Paradoxismul în matematică, filosofie și poezie / 835

VARIA MATHEMATICA

Florentin Smarandache

Mathematics for Everything with Combinatorics on Nature - A Report on the Promoter Dr. Linfan Mao of Mathematical Combinatorics / 841

W.B. Vasantha Kandasamy, Ilanthenral Kandasamy, Florentin Smarandache

The $3n \pm p$ Conjecture: A Generalization of Collatz Conjecture / 845

Victor Christianto, Florentin Smarandache

How many points are there in a Line Segment? A New Answer from a Discrete Cellular Space Viewpoint / 853

Zhirou Ma, Xiaohong Zhang, Florentin Smarandache

Some Results on Various Cancellative CA-Groupoids and Variant CA-Groupoids / 864

Ion Pătrașcu, Mario Dalcín, Florentin Smarandache

Two Properties of The Special Octagon / 885

Florentin Smarandache

Erratum to the paper "Fifty Years of Kurepa's $!n$ Hypothesis" by Žarko Mijajlović / 892

MISCELLANEA

Florentin Smarandache, Ștefan Vlăduțescu

The Fifth Function of University: “Neutrosophic E-function” of Communication-Collaboration-Integration of University in the Information Age / 896

Florentin Smarandache

Teoria Neutrosifică a Evoluției: Grade de Evoluție / Indeterminare / Involuție / 914

Florentin Smarandache, Jun Ye

Summary of the Special Issue “Neutrosophic Information Theory and Applications” at “Information” Journal / 917

Florentin Smarandache

How to celebrate 24 new year’s eves in a single year / 921

Mohamed Loey, Florentin Smarandache, Nour Eldeen M. Khalifa

Within the Lack of Chest COVID-19 X-ray Dataset: A Novel Detection Model Based on GAN and Deep Transfer Learning / 925

Victor Christianto, Florentin Smarandache

Remark on Artificial Intelligence, humanoid and Terminator scenario: A Neutrosophic way to futurology / 944

Florentin Smarandache

Pledoarie pentru excelență în cultură: despre Mircea Eugen Șelariu / 950

Victor Christianto, Florentin Smarandache

Five examples on using spreadsheet to solve engineering and mathematical problems / 953

Victor Christianto, Florentin Smarandache, Sori Tjandrah Simbolon

On mythical Dewaruci, Manunggaling kawula-Gusti and other nontrivial Javanese logic / 965

Victor Christianto, Florentin Smarandache, Yunita Umniyati

Beyond Post-Empiricism Doctrine: A New Philosophy of Discovery / 980

List of Countries

ALGERIA (4)

UNITED STATES OF AMERICA (7)

AUSTRALIA (1)

BELGIUM (1)

PR CHINA (14)

DENMARK (1)

EGYPT (4)

GREECE (1)

INDIA (20)

INDONESIA (3)

IRAN (5)

IRAQ (2)

ITALY (1)

LEBANON (1)

LITHUANIA (1)

MALAYSIA (1)

MOROCCO (4)

NORWAY (2)

PAKISTAN (13)

ROMÂNIA (5)

SERBIA (5)

SOUTH KOREA (1)

SYRIA (2)

TURKEY (9)

URUGUAY (1)

SR VIETNAM (1)

List of Authors

A

Abduallah Gamal

Department of Operations Research, Faculty of Computers and Informatics, Zagazig University, Sharqiyah, EGYPT
abduallahgamal@gmail.com

Sania Afzal

Department of Mathematics, COMSATS Institute of Information Technology, Abbottabad, PAKISTAN
saniaafzal1991@gmail.com

Firoz Ahmad

Department of Statistics and Operations Research, Aligarh Muslim University, Aligarh, INDIA
firoz.ahmad02@gmail.com

Muhammad Akram

Department of Mathematics, University of the Punjab, New Campus, Lahore, PAKISTAN
m.akram@pucit.edu.pk

Sheriful Alam

Department of Mathematics, Indian Institute of Engineering Science and Technology, Shibpur, Howrah, West Bengal, INDIA

Ali Hamza

Department of Mathematics and Statistics, The University of Lahore, Pakistan
alifm2909@gmail.com

Ali H. M. Al-Obaidi

Department of Mathematics, College of Education for Pure Science, University of Babylon, Hillah, IRAQ
aalobaidi@uobabylon.edu.iq

Madeleine Al-Tahan

Faculty of Economic Science and Buisness Administration, Lebanese International University, Beirut, LEBANON
madelaine.tahan@liu.edu.lb

Assia Bakali

Ecole Royale Navale, Boulevard Sour Jdid, Casablanca, MOROCCO
assiabakali@yahoo.fr

Atiqe Ur Rahman

Department of Mathematics, University of Management and Technology, Lahore, PAKISTAN
aurkhh@gmail.com

B**Sukanto Bhattacharya**

Department of Business Administration, Alaska Pacific University, UNITED STATES OF AMERICA
sbhattacharya@alaskapacific.edu

Bilal Hadjadji

University of Science and Technology, Algiers, ALGERIA
bhadjadji@usthb.dz

Robert N. Boyd

Princeton Biotechnology Corporation, Department Information Physics Research, UNITED STATES OF AMERICA

Willem K.M. Brauers

Faculty of Business and Economics, Department of Economics, University of Antwerp, Antwerp, BELGIUM
willem.brauers@uantwerpen.be

C**Umit Cali**

Norwegian University of Science and Technology, Trondheim, NORWAY
umit.cali@ntnu.no

Youcef Chibani

University of Science and Technology, Algiers, ALGERIA
ychibani@usthb.dz

Victor Christianto

Malang Institute of Agriculture (IPM), Malang, INDONESIA
victorchristianto@gmail.com

Chunxin Bo

College of Information Engineering, Shanghai Maritime University, Shanghai, PR CHINA
201640311001@stu.shmtu.edu.cn

D**Shyamal Dalapati**

Department of Mathematics, Indian Institute of Engineering Science and Technology, Shibpur, Howrah, West Bengal, INDIA
shyamal.rs2015@math.iiests.ac.in

Mario Dalcín

“Artigas” Secondary School Teachers Institute-CFE, Montevideo, URUGUAY

Arup Kumar Das

Indian Statistical Institute, Kolkata, INDIA

Elham Davneshvar

Department of Mathematics, University of Payame Noor, Tehran, IRAN

Bijan Davvaz

Department of Mathematics, Yazd University, Yazd, IRAN
davvaz@yazd.ac.ir

Irfan Deli

Muallim Rifat Faculty of Education, Aralik University, Kilis, TURKEY
irfandeli@kilis.edu.tr

Muhammet Deveci

Department of Industrial Engineering, Turkish Naval Academy, National Defence University, Istanbul, TURKEY

Mamouni Dhar

Department of Mathematics Science College Kokrajhar, Assam, INDIA
mamonidhar@gmail.com

R. Dhavaseelan

Department of Mathematics, Sona College of Technology, Salem, Tamil Nadu, INDIA
dhavaseelan.r@gmail.com

E**Balasubramanian Elavarasan**

Department of Mathematics, Karunya Institute of Technology and Sciences, Coimbatore, Tamilnadu, INDIA
elavarasan@karunya.edu

F**Sara Farooq**

Department of Mathematics and Statistics, The University of Lahore, Pakistan
sarafarooq447@gmail.com

H**Haipeng Wang**

Institute of Information Fusion Technology Department Naval Aeronautical and Astronautical University Yantai, PR CHINA

Ugur Halden

Norwegian University of Science and Technology, Trondheim, NORWAY

Le Hoang Son

VNU Information Technology Institute, Vietnam National University, Hanoi, SR VIETNAM
sonlh@vnu.edu.vn

Hongnian Yu

School of Computer Science and Network Security, Dongguan University of Technology, Guangdong, PR CHINA
yu61150@ieee.org

I**Qays Hatem Imran**

Department of Mathematics, College of Education for Pure Science, Al-Muthanna University, Samawah, IRAQ
qays.imran@mu.edu.iq

Mayas Ismail

Department of Computer Engineering, International University for Science and Technology, Daraa, SYRIA
mayas.n.ismail@gmail.com

J**Saeid Jafari**

College of Vestsjaelland South, Slagelse, DENMARK
jafaripersia@gmail.com

Jun Ye

Department of Electrical and Information Engineering, Shaoxing University, Shaoxing, PR CHINA
yehjun@aliyun.com

K**Ilanthenral Kandasamy**

School of Computer Science and Engineering, VIT, Vellore, Tamil Nadu, INDIA
ilanthenal.k@vit.ac.in

W.B. Vasantha Kandasamy

School of Computer Science and Engineering, VIT, Vellore, Tamil Nadu, INDIA
vasantha.wb@vit.ac.in

Darjan Karabašević

Faculty of Applied Management, Economics and Finance, University Business Academy in Novi Sad, Belgrade, SERBIA
darjan.karabasevic@mef.edu.rs

Abdullah Kargin

Department of Mathematics, Gaziantep University, Gaziantep, TURKEY
abdullahkargin27@gmail.com

Vasilios N. Katsikis

Division of Mathematics and Informatics, Department of Economics, National and Kapodistrian University of Athens, Panepistimiopolis, Athens, GREECE
vaskatsikis@econ.uoa.gr

Nour Eldeen M. Khalifa

Department of Information Technology, Faculty of Computers and Artificial Intelligence, Cairo University, Cairo, Egypt
nourmahmoud@cu.edu.eg

Madad Khan

Department of Mathematics, COMSATS University Islamabad, Abbottabad Campus, PAKISTAN
madadkhan@cuiatd.edu

M. Khoshnevisan

Department of Accounting, Finance and Economics, Griffith University, AUSTRALIA

Tapan Kumar Roy

Department of Mathematics, Indian Institute of Engineering Science and Technology, Shibpur, Howrah, West Bengal, INDIA
tkroy@math.iiests.ac.in

M**Pinaki Majumdar**

Department of Mathematics, M.U.C Women's College, Burdwan, West-Bengal, INDIA
pmajumdar2@rediffmail.com

Sreepurna Malakar

Department of Chemistry and Biochemistry, University of Alaska, UNITED STATES OF AMERICA

Masoud Ghods

Department of Mathematics, Semnan University, Semnan, IRAN
mghods@semnan.ac.ir

Minghao Hu

Department of Mathematics, Shaanxi University of Science & Technology, Xi'an, PR CHINA
huminghao@sust.edu.cn

Mingming Chen

Department of Mathematics, Shaanxi University of Science & Technology, Xi'an, PR CHINA
chenmingming@sust.edu.cn

Mohamed Abdel-Basset

Department of Operations Research, Faculty of Computers and Informatics, Zagazig University, Sharqiyah, EGYPT
analyst_mohamed@yahoo.com

Mohamed Talea

Laboratory of Information processing, Faculty of Science Ben M'Sik, University Hassan II, Casablanca, MOROCCO
taleamohamed@yahoo.fr

Mohammad Hamidi

Department of Mathematics, University of Payame Noor, Tehran, IRAN
m.hamidi@pnu.ac.ir

Mohamed Loey

Department of Computer Science, Faculty of Computers and Artificial Intelligence, Benha University, Benha, EGYPT
mloey@fci.bu.edu.eg

Mihnea Alexandru Moisescu

Faculty of Automation, "Politehnica" University of Bucharest, ROMÂNIA

Muhammad Ihsan

University of Management and Technology, Lahore, PAKISTAN
mihkhh@gmail.com

Muhammad Saeed

University of Management and Technology, Lahore, PAKISTAN
muhammad.saeed@umt.edu.pk

Muhammad Shabir

Department of Mathematics, Quaid-i-Azam University, Islamabad, PAKISTAN
mshabirbhatti@yahoo.co.uk

Mumtaz Ali

Department of Mathematics, Quaid-i-Azam University, Islamabad, PAKISTAN
mumtazali770@yahoo.com

Muzzamal Sitara

Department of Mathematics, University of the Punjab, New Campus, Lahore 54590, PAKISTAN
muzzamalsitara@gmail.com

N**Nassim Abbas**

University of Science and Technology, Algiers, ALGERIA
nabbas@usthb.dz

Munazza Naz

Department of Mathematical Sciences, Fatima Jinnah Women University, Rawalpindi, PAKISTAN
munazzanaz@yahoo.com

Giorgio Nordo

Dipartimento di scienze Matematiche e Informatiche, scienze Fisiche e scienze della Terra dell'Università degli Studi di Messina
Viale Ferdinando Stagno d'Alcontres, ITALY
giorgio.nordo@unime.it

P**Mani Parimala**

Department of Mathematics, Bannari Amman Institute of Technology, Sathyamangalam, Tamil Nadu, INDIA
rishwanthpari@gmail.com

Ion Pătrașcu

"Fratii Buzesti" National College, Craiova, ROMÂNIA

Gabrijela Popović

Faculty of Applied Management, Economics and Finance, University Business Academy in Novi Sad, Belgrade, SERBIA

K. Porselvi

Department of Mathematics, Karunya Institute of Technology and Sciences, Coimbatore, Tamilnadu, INDIA
porselvi94@yahoo.co.in

Surapati Pramanik

Department of Mathematics, Nandalal Ghosh B.T. College, Panpur, Bhatpara, West Bengal, INDIA
sura_pati@yahoo.co.in

D. Preethi

Department of Mathematics, Alagappa University, Karaikudi, Tamilnadu, India.
preethi06061996@gmail.com

Q**Qiang Guo**

Institute of Information Fusion Technology Department Naval Aeronautical and Astronautical University Yantai, PR CHINA
gq19860209@163.com

R**Riad K. Al-Hamido**

Department of Mathematics, College of Science, Al-Baath University, Homs, SYRIA
riad-hamido1983@hotmail.com

Zahra Rostami

Department of Mathematics, Semnan University, Semnan, IRAN
zahrorostami.98@semnan.ac.ir

S**Said Broumi**

Laboratory of Information Processing, Faculty of Science Ben M'Sik, University Hassan II, Casablanca, MOROCCO
broumisaid78@gmail.com

Saima Anis

Department of Mathematics, COMSATS University Islamabad, Abbottabad Campus, PAKISTAN
saimaanis@cuiatd.edu.pk

Muzafer Saračević

Department of Computer Sciences, University of Novi Pazar, Novi Pazar, SERBIA
muzafers@uninp.edu.rs

Ganeshsree Selvachandran

Department of Actuarial Science and Applied Statistics, Faculty of Business & Information Science, UCSI University, Jalan Menara Gading, Kuala Lumpur, MALAYSIA
Ganeshsree@ucsiuniversity.edu.my

Selvaraj Ganesan

Department of Mathematics, Raja Doraisingam Government Arts College, Sivagangai, Tamil Nadu, INDIA
sgsgsgsg77@gmail.com

Shammya Shananda Saha

Electric Power Research Institute, Knoxville, Tennessee, UNITED STATES OF AMERICA

Marayanagaraj Shanmugapriya

Department of Mathematics, Sri Sivasubramaniya Nadar College of Engineering, INDIA
shanmugapriya@ssn.edu.in

Songtao Shao

Department of Mathematics, Shanghai Maritime University, Shanghai, PR CHINA
201740310005@stu.shmtu.edu.cn

Sori Tjandrah Simbolon

Graduate Study, Satyabhakti Advanced School of Theology, East Java, INDONESIA

Florentin Smarandache

University of New Mexico, 705 Gurley Ave., Gallup, NM 87301, UNITED STATES OF AMERICA
smarand@unm.edu

Predrag S. Stanimirović

Faculty of Sciences and Mathematics, University of Niš, Niš, SERBIA
pecko@pmf.ni.ac.rs

Dragiša Stanujkić

Faculty of Management in Zajecar, John Naisbitt University, Belgrade, SERBIA
dragisa.stanujkic@fmz.edu.rs

Raman Sundareswaran

Department of Mathematics, Sri Sivasubramaniya Nadar College of Engineering, INDIA
sundareswaranr@ssn.edu.in

§**Mehmet Şahin**

Department of Mathematics, Gaziantep University, Gaziantep, TURKEY
mesahin@gantep.edu.tr

Ovidiu-Ilie Şandru

Faculty of Electronics, "Politehnica" University of Bucharest, ROMÂNIA

Abdulkadir Şengür

Department of Electrical and Electronics Engineering, Firat University, Elazig, TURKEY
ksengur@gmail.com

T**Mohamed Talea**

Laboratory of Information processing, Faculty of Science Ben M'Sik, University Hassan II, Casablanca, MOROCCO
taleamohamed@yahoo.fr

Ferhat Taş

Department of Mathematics, Faculty of Science, Istanbul University, Istanbul 34134, Turkey;
tasf@istanbul.edu.tr

Selçuk Topal

Department of Mathematics, Faculty of Arts and Sciences, Bitlis Eren University, Bitlis, TURKEY
selcuk.topal@yandex.com

U**Alptekin Ulutaş**

Sivas Cumhuriyet University, Sivas, TURKEY
aulutash@cumhuriyet.edu.tr

Ramalingam Udhayakumar

Department of Mathematics, School of Advanced Sciences, Vellore Institute of Technology, Vellore, INDIA
udhayaram_v@yahoo.co.in

Yunita Umniyati

Dept. Mechatronics Engineering, Swiss German University, Tangerang, INDONESIA
yunita.umniyati@sgu.ac.id

V**J. Vimala**

Department of Mathematics, Alagappa University, Karaikudi, Tamilnadu, INDIA
vimaljey@alagappauniversity.ac.in

Luige Vlădăreanu

Dept. of Mechatronics and Robotics, Institute of Solid Mechanics, Romanian Academy, Bucharest, ROMÂNIA
luigiv@arexim.ro

Ştefan Vlăduţescu

Faculty of Letters, University of Craiova, ROMÂNIA
vladutescu.stefan@ucv.ro

Y**Yaman Akbulut**

Department of Electrical and Electronics Engineering, Firat University, Elazig, TURKEY
yamanakbulut@gmail.com

Yanhui Guo

Department of Computer Science, University of Illinois at Springfield, Springfield, IL, UNITED STATES OF AMERICA
guoyanhui@gmail.com

Yong Deng

School of Computer and Information Science Southwest University, Chongqing, PR CHINA

You He

Institute of Information Fusion Technology Department Naval Aeronautical and Astronautical University Yantai, PR CHINA

Young Bae Jun

Department of Mathematics Education, Gyeongsang National University, Jinju, SOUTH KOREA
skywine@gmail.com

W**Wangtao Yuan**

Department of Mathematics, Shaanxi University of Science & Technology, Xi'an, PR CHINA
1809007@sust.edu.cn

X**Rong Xia**

Oracle Corporation, Westminister, UNITED STATES OF AMERICA
rrongxia@gmail.com

Xiaohong Zhang

Department of Mathematics, Shaanxi University of Science & Technology, Xi'an, PR CHINA
zhangxiaohong@sust.edu.cn

Z**Edmundas Kazimieras Zavadskas**

Institute of Sustainable Construction, Vilnius Gediminas Technical University, Vilnius, LITHUANIA
edmundas.zavadskas@vilniustech.lt

Zayen Azzouz Omar

University of Science and Technology, Algiers, ALGERIA

Xiaohong Zhang

Department of Mathematics, Shaanxi University of Science & Technology, Xi'an, PR CHINA
zhangxiaohong@sust.edu.cn

Zhirou Ma

Department of Mathematics, Shaanxi University of Science & Technology, Xi'an, PR CHINA

List of Papers

NEUTROSOPHIC THEORY AND APPLICATIONS

1. Florentin Smarandache, Luige Vlădăreanu (2011). Applications of neutrosophic logic to robotics: An introduction. *IEEE International Conference on Granular Computing*, 607-612; DOI: 10.1109/GRC.2011.6122666
2. Ferhat Taş, Selçuk Topal, Florentin Smarandache (2018). Clustering Neutrosophic Data Sets and Neutrosophic Valued Metric Spaces. *Symmetry* 10, 430; DOI: 10.3390/sym10100430
3. Victor Christianto, Robert N. Boyd, Florentin Smarandache (2020). Three possible applications of Neutrosophic Logic in Fundamental and Applied Sciences. *International Journal of Neutrosophic Science* 1(2), 90-95; DOI: 10.5281/zenodo.3692037
4. Florentin Smarandache (2021). Indeterminacy in Neutrosophic Theories and their Applications. *International Journal of Neutrosophic Science* 15(2), 89-97; DOI:10.5281/zenodo.5295819
5. Firoz Ahmad, Florentin Smarandache, Arup Kumar Das (2022). Neutrosophical fuzzy modeling and optimization approach for multiobjective four-index transportation problem. *Indian Statistical Institute*, 31

NEUTROSOPHIC ALGEBRA

1. Said Broumi, Florentin Smarandache, Pabitra Kumar Maji (2014). Intuitionistic Neutrosophic Soft Set over Rings. *Mathematics and Statistics* 2(3), 120-126; DOI: 10.13189/ms.2014.020303
2. W.B. Vasantha Kandasamy, K. Ilanthenral, Florentin Smarandache (2016). Modified Collatz conjecture or $(3a+1)+(3b+1)I$ Conjecture for Neutrosophic Numbers $\langle Z \cup I \rangle$. *Neutrosophic Sets and Systems* 14, 44-46
3. W.B. Vasantha Kandasamy, Ilanthenral Kandasamy, Florentin Smarandache (2018). Neutrosophic Duplets of $\{Z_{pn}, x\}$ and $\{Z_{pq}, x\}$ and Their Properties. *Symmetry*, 10, 345; DOI: 10.3390/sym10080345
4. D. Preethi, S. Rajareega, J. Vimala, Ganeshsree Selvachandran, Florentin Smarandache (2019). Single-Valued Neutrosophic Hyperrings and Single-Valued Neutrosophic Hyperideals. *Neutrosophic Sets and Systems* 29, 121-128
5. Riad K. Al-Hamido, Mayas Ismail, Florentin Smarandache (2020). The Polar form of a Neutrosophic Complex Number. *International Journal of Neutrosophic Science* 10(1), 36-44; DOI: 10.5281/zenodo.4001132 36
6. Muhammad Saqlain, Florentin Smarandache (2020). Octagonal Neutrosophic Number: Its Different Representations, Properties, Graphs and De-neutrosophication with the application of Personnel Selection. *International Journal of Neutrosophic Science*, 8(1), 19-33; DOI: 10.5281/zenodo.3900315
7. Florentin Smarandache (2022). NeutroAlgebra & AntiAlgebra vs. Classical Algebra. *Transactions on Fuzzy Sets and Systems* 1(1), 74-79

FUZZY SOFT SETS

1. Said Broumi, Florentin Smarandache, Mamoni Dhar (2013). On Fuzzy Soft Matrix Based on Reference Function. *International Journal of Information Engineering and Electronic Business* 2, 52-59; DOI: 10.5815/ijieeb.2013.02.08
2. Said Broumi, Pinaki Majumdar, Florentin Smarandache (2014). New Operations on Intuitionistic Fuzzy Soft Sets based on Second Zadeh's logical Operators. *International Journal of Information Engineering and Electronic Business* 1, 25-31; DOI: 10.5815/ijieeb.2014.01.03
3. Said Broumi, Florentin Smarandache, Mamoni Dhar, Pinaki Majumdar (2014). New Results of Intuitionistic Fuzzy Soft Set. *International Journal of Information Engineering and Electronic Business* 2, 47-52; DOI: 10.5815/ijieeb.2014.02.06
4. Said Broumi, Florentin Smarandache (2015). Mapping on Intuitionistic Fuzzy Soft Expert Sets. *Journal of New Results in Science* 9, 1-10

NEUTROSOPHIC SETS

1. Said Broumi, Pinaki Majumdar, Florentin Smarandache (2014). New Operations on Intuitionistic Fuzzy Soft Sets Based on First Zadeh's Logical Operators. *Journal of New Results in Science* 4, 71-81
2. Irfan Deli, Said Broumi, Florentin Smarandache (2015). On neutrosophic refined sets and their applications in medical diagnosis. *Journal of New Theory* 6, 88-98
3. Qays Hatem Imran, F. Smarandache, Riad K. Al-Hamido, R. Dhavaseelan (2017). On Neutrosophic Semi Alpha Open Set. *Neutrosophic Sets and Systems* 18, 37-42
4. Mani Parimala, Florentin Smarandache, Saeid Jafari, Ramalingam Udhayakumar (2018). On Neutrosophic $\alpha\gamma$ -Closed Sets. *Information* 2018, 9, 103; DOI: 10.3390/info9050103
5. Chunxin Bo, Xiaohong Zhang, Songtao Shao, Florentin Smarandache (2018). New Multigranulation Neutrosophic Rough Set with Applications. *Symmetry* 10, 578; DOI: 10.3390/sym10110578
6. Florentin Smarandache, Said Broumi (2020). True-False Set is a particular case of the Refined Neutrosophic Set. *International Journal of Neutrosophic Science* 12(1), 9-12; DOI: 10.5281/zenodo.4247831
7. Selvaraj Ganesan, Florentin Smarandache (2021). Neutrosophic Biminimal α -Open Sets. *Bulletin of the International Mathematical Virtual Institute* 11(3), 545-553; DOI: 10.7251/BIMVI2103545G
8. Qays Hatem Imran, Ali H. M. Al-Obaidi, Florentin Smarandache, Said Broumi (2022). On Neutrosophic Generalized Semi Generalized Closed Sets. *International Journal of Neutrosophic Science* 18(3), 10-20; DOI: 10.54216/IJNS.18030101

HYPERSOFT SETS

1. Florentin Smarandache (2022). Introduction to the IndetermSoft Set and IndetermHyperSoft Set. *Neutrosophic Sets and Systems* 50, 629-650
2. Florentin Smarandache (2022). Introducción a los conjuntos IndetermSoft e IndetermHyperSoft Sets. *Neutrosophic Computing and Machine Learning* 22, 1-22

3. Muhammad Ihsan, Muhammad Saeed, Atiqe Ur Rahman, Florentin Smarandache (2022). An Inclusive Study on Fundamentals of Hypersoft Expert Set with Application. *Punjab University Journal of Mathematics* 54(5), 315-332; DOI: 10.52280/pujm.2022.540503

NEUTROSOPHIC SEMIGROUPS

1. Mumtaz Ali, Florentin Smarandache, Muhammad Shabir, Munazza Naz (2014). Neutrosophic Bi-LA-Semigroup and Neutrosophic N-LA-Semigroup. *Neutrosophic Sets and Systems* 4, 19-24
2. Mumtaz Ali, Muhammad Shabir, Florentin Smarandache, Luige Vladareanu (2015). Neutrosophic LA-Semigroup Rings. *Neutrosophic Sets and Systems* 7, 81-88
3. Madad Khan, Florentin Smarandache, Sania Afzal (2016). Neutrosophic Set Approach for Characterizations of Left Almost Semigroups. *Neutrosophic Sets and Systems* 11, 79-94
4. Madad Khan, Saima Anis, Florentin Smarandache, Young Bae Jun (2017). Neutrosophic N-structures and their applications in semigroups. *Annals of Fuzzy Mathematics and Informatics* 14(6), 583-598
5. Minghao Hu, Florentin Smarandache, Xiaohong Zhang (2020). On Neutrosophic Extended Triplet LA-hypergroups and Strong Pure LA-semihypergroups. *Symmetry* 12, 163; DOI: 10.3390/sym12010163
6. K. Porselvi, Balasubramanian Elavarasan, F. Smarandache (2020). Neutrosophic N-interior ideals in semigroups. *Neutrosophic Sets and Systems* 36, 70-80
7. Madeleine Al-Tahan, F. Smarandache, Bijan Davvaz (2020). NeutroOrderedAlgebra: Applications to Semigroups. *Neutrosophic Sets and Systems* 39, 133-147
8. Xiaohong Zhang, Wangtao Yuan, Mingming Chen, Florentin Smarandache (2020). A Kind of Variation Symmetry: Tarski Associative Groupoids (TA-Groupoids) and Tarski Associative Neutrosophic Extended Triplet Groupoids (TA-NET-Groupoids). *Symmetry* 12, 714; DOI: 10.3390/sym12050714
9. Madeleine Al-Tahan, Bijan Davvaz, Florentin Smarandache, Osman Anis (2021). Properties of Productional NeutroOrderedSemigroups. *Neutrosophic Sets and Systems* 42, 178-190

NEUTROSOPHIC GRAPHS

1. Muhammad Akram, Muzzamal Sitara, Florentin Smarandache (2017). Graph Structures in Bipolar Neutrosophic Environment. *Mathematics*, 5(4), 60; DOI: 10.3390/math5040060
2. Yanhui Guo, Yaman Akbulut, Abdulkadir Şengür, Rong Xia, Florentin Smarandache (2017). An Efficient Image Segmentation Algorithm Using Neutrosophic Graph Cut. *Symmetry* 9, 185; DOI: 10.3390/sym9090185
3. Said Broumi, Raman Sundareswaran, Marayanagaraj Shanmugapriya, Giorgio Nardo, Mohamed Talea, Assia Bakali, Florentin Smarandache (2022). Interval-Valued Fermatean Neutrosophic Graphs. *Decision Making: Applications in Management and Engineering*, 25; DOI: 10.31181/dmame0311072022b

SUPERHYPERGRAPHS

1. Florentin Smarandache (2022). Introduction to the n-SuperHyperGraph - the most general form of graph today. *Neutrosophic Sets and Systems* 48, 483-485
2. Masoud Ghods, Zahra Rostami, Florentin Smarandache (2022). Introduction to Neutrosophic Restricted SuperHyperGraphs and Neutrosophic Restricted SuperHyperTrees. *Neutrosophic Sets and Systems* 50, 480-487
3. Mohammad Hamidi, Florentin Smarandache, Elham Davneshvar (2022). Spectrum of Superhypergraphs via Flows. *Journal of Mathematics*, ID 9158912, 12; DOI: 10.1155/2022/9158912

PLITHOGENY

1. Florentin Smarandache (2021). Plithogenic Probability & Statistics are generalizations of MultiVariate Probability & Statistics. *Neutrosophic Sets and Systems* 43, 280-289
2. Florentin Smarandache (2022). Plithogeny, Plithogenic Set, Logic, Probability, and Statistics: A Short Review. *Journal of Computational and Cognitive Engineering* 1(2) 47-50; DOI: 10.47852/bonviewJCCE2202191

INFORMATION FUSION

1. Florentin Smarandache (2013). Indeterminate masses, elements and models in information fusion. *Journal of Advances in Information Fusion* 5(6), 365-372
2. Florentin Smarandache, Nassim Abbas, Youcef Chibani, Bilal Hadjadji, Zayen Azzouz Omar (2017). PCR5 and Neutrosophic Probability in Target Identification (revisited). *Neutrosophic Sets and Systems* 16, 76-79
3. Qiang Guo, Haipeng Wang, You He, Yong Deng, Florentin Smarandache (2017). An Evidence Fusion Method with Importance Discounting Factors based on Neutrosophic Probability Analysis in DS_mT Framework. *Neutrosophic Sets and Systems* 17, 64-73

STATISTICS

3. Sreepurna Malakar, Florentin Smarandache, S. Bhattacharya (2005). Statistical Modeling of Primary Ewing Tumours of the Bone. *International Journal of Tomography & Statistics* 3, JJ05, 81-88
4. Sukanto Bhattacharya, Florentin Smarandache (2007). Effective Number of Parties in a Multi-Party Democracy under an entropic political equilibrium with floating voters. *International Journal of Applied Mathematics* 20(3), 323-332
5. Florentin Smarandache (2021). Short Note on Neutrosophic Statistics as a generalization of Classical Statistics. *Journal of Rajasthan Statistical Association* 3(1), 159-171

DECISION MAKING

1. S. Bhattacharya, Florentin Smarandache, M. Khoshnevisan (2005). MASS - Modified Assignment Algorithm in Facilities Layout Planning. *International Journal of Tomography & Statistics* 3, JJ05, 19-29
2. Shyamal Dalapati, Surapati Pramanik, Sheriful Alam, Florentin Smarandache, Tapan Kumar Roy (2017). IN-cross Entropy Based MAGDM Strategy under Interval Neutrosophic Set Environment. *Neutrosophic Sets and Systems* 18, 43-57
3. Mehmet Şahin, Abdullah Kargin, Florentin Smarandache (2018). Generalized Single Valued Triangular Neutrosophic Numbers and Aggregation Operators for Application to Multi-attribute Group Decision Making. In F. Smarandache, S. Pramanik (eds.): *New Trends in Neutrosophic Theory and Applications, II*, 51-84
4. Mohamed Abdel-Basset, Florentin Smarandache, Jun Ye (2019). Special issue on “Applications of neutrosophic theory in decision making-recent advances and future trends”. *Complex & Intelligent Systems*, 2; DOI: 10.1007/s40747-019-00127-1
5. Mohamed Abdel-Basset, Abdualлах Gamal, Le Hoang Son, Florentin Smarandache (2020). A Bipolar Neutrosophic Multi Criteria Decision Making Framework for Professional Selection. *Applied Sciences*, 10, 1202; DOI: 10.3390/app10041202
6. Sara Farooq, Ali Hamza, Florentin Smarandache (2021). Linear and Non-Linear Decagonal Neutrosophic numbers: Alpha Cuts, Representation, and solution of large MCDM problems. *International Journal of Neutrosophic Science* 14(1), 24-41; DOI: 10.5281/zenodo.4721629
7. Umit Cali, Muhammet Deveci, Shamma Shananda Saha, Ugur Halden, Florentin Smarandache (2021). Prioritizing Energy Blockchain Use Cases Using Type-2 Neutrosophic Number Based EDAS. *IEEE Access* 4, 17; DOI: 10.1109/ACCESS.2022.3162190
8. Alptekin Ulutaş, Dragiša Stanujkić, Darjan Karabašević, Gabrijela Popović, Edmundas Kazimieras Zavadskas, Florentin Smarandache, Willem K.M. Brauers (2021). Developing of a Novel Integrated MCDM MULTIMOOSRAL Approach for Supplier Selection. *Informatica* 32(1), 145–161; DOI: 10.15388/21-INFOR445
9. Dragiša Stanujkić, Darjan Karabašević, Gabrijela Popović, Florentin Smarandache, Predrag S. Stanimirović, Muzafer Saračević, Vasilios N. Katsikis (2022). A Single Valued Neutrosophic Extension of the Simple WISP Method. *Informatica*, 17; DOI: 10.15388/22-INFOR483

EXTENICS

1. Florentin Smarandache (2012). Generalizations of the Distance and Dependent Function in Extenics to 2D, 3D, and n-D. *Progress in Physics* 3, 54-61
2. Florentin Smarandache (2014). Connections between Extension Logic and Refined Neutrosophic Logic. *Journal of Guangdong University of Technology* 31(4), 5
3. Victor Vlădăreanu, Ovidiu-Ilie Şandru, Mihnea Alexandru Moisescu, Florentin Smarandache, Hongnian Yu (2016). The Extenics Norm Applied to a Two-Dimensional Robotic Workspaces. Proceedings of the Annual Symposium of the Institute of Solid Mechanics and Session of the Commission of Acoustics; *Acta Electrotechnica* 57(1-2), 35-40

INSTANTANEOUS PHYSICS

1. Florentin Smarandache (2012). Parameterized Special Theory of Relativity (PSTR). *Progress in Physics* 2, 28-29
2. Florentin Smarandache (2013). Relations between Distorted and Original Angles in STR. *Progress in Physics* 3, 21-24
3. Victor Christianto, Florentin Smarandache, Yunita Umniyati (2021). Remark on possible binary companion of the sun: towards a symmetric cosmology model which may be called Quantum Liquid Dirac-Milne (QLDM) model. *Octagon Mathematical Magazine* 29(1), 342-347
4. Robert N. Boyd, Victor Christianto, Florentin Smarandache (2022). Remark on creation and dis-creation processes related to origination of charge and matter. *Journal of Cosmology, Filaments and Astrobiology* 1(1), 33-41; DOI: 10.54216/JCFA.010105
5. Yunita Umniyati, Victor Christianto, Florentin Smarandache (2022). A New Hypothesis of Spin Supercurrent as Plausible Mechanism of Biological Nonlocal Interaction, Synchronicity, Quantum Communication. In K. S. Essa, k. H. Mahmoud, & Y. H. Chemin (Eds.), *Magnetosphere and Solar Winds - Humans and Communication*. IntechOpen. DOI: 10.5772/intechopen.102743
6. Robert N. Boyd, Florentin Smarandache (2022). The electric Coulomb field travels with an infinite velocity: Remarks on Naudin's experiment, Montagnier-Gariaev's experiments, and Lienert-Wiechart potential. *Journal of Cosmology, Filaments and Astrobiology* 1(2), 8-12; DOI: 10.54216/JCFA.010201
7. Robert N. Boyd, Florentin Smarandache (2022). Remark on Project Greenglow and Rodin coil. *Journal of Cosmology, Filaments and Astrobiology* 1(2), 13-14; DOI: 10.54216/JCFA.010202
8. Robert N. Boyd, Florentin Smarandache (2022). Remark on the Safire Project's findings and infinite velocity beyond speed of light. *Journal of Cosmology, Filaments and Astrobiology* 1(2), 15-18; DOI: 10.54216/JCFA.010203

PARADOXISM

1. Florentin Smarandache (2022). The Paradoxism in Mathematics, Philosophy, and Poetry. *Bulletin of Pure and Applied Sciences - Section - E - Mathematics & Statistics* 41E(1), 46-48; DOI: 10.5958/2320-3226.2022.00006.6
2. Florentin Smarandache (2022). Paradoxismul în matematică, filosofie și poezie. *Sæculum* 7, 131-135

VARIA MATHEMATICA

1. Florentin Smarandache (2016). Mathematics for Everything with Combinatorics on Nature - A Report on the Promoter Dr. Linfan Mao of Mathematical Combinatorics. *International Journal of Mathematical Combinatorics* 1, 130-133
2. W.B. Vasantha Kandasamy, Ilanthenral Kandasamy, Florentin Smarandache (2017). The $3n \pm p$ Conjecture: A Generalization of Collatz Conjecture. *Octagon Mathematical Magazine* 25(1), 26-33; DOI: 10.22147/jusps-A/290207

3. Victor Christianto, Florentin Smarandache (2018). How many points are there in a Line Segment? A New Answer from a Discrete Cellular Space Viewpoint. *Octogon Mathematical Magazine* 26(2), 604-615
4. Zhirou Ma, Xiaohong Zhang, Florentin Smarandache (2020). Some Results on Various Cancellative CA-Groupoids and Variant CA-Groupoids. *Symmetry* 12, 315; DOI: 10.3390/sym12020315
5. Ion Pătrașcu, Mario Dalcín, Florentin Smarandache (2021). Two Properties of The Special Octagon. *Gazeta Matematică B(CXXVI)*, 377-383
6. Florentin Smarandache (2021). Erratum to the paper “Fifty Years of Kurepa’s !n Hypothesis” by Žarko Mijajlović. *Bulletin of Pure and Applied Sciences - Section - E - Mathematics & Statistics* 40E(2), 164-166; DOI: 10.5958/2320-3226.2021.00018.7

MISCELLANEA

1. Florentin Smarandache, Ștefan Vlăduțescu (2013). The Fifth Function of University: “Neutrosophic E-function” of Communication-Collaboration-Integration of University in the Information Age. Archive.org, 18. DOI: 10.5281/zenodo.30217
2. Florentin Smarandache (2017). Teoria Neutrosifică a Evoluției: Grade de Evoluție / Indeterminare / Involuție. *Destine Literare* 89-92, 246-248
3. Florentin Smarandache, Jun Ye (2018). Summary of the Special Issue “Neutrosophic Information Theory and Applications” at “Information” Journal. *Information*, 9, 49; DOI: 10.3390/info9030049
4. Florentin Smarandache (2020). How to celebrate 24 new year’s eves in a single year. *Bulletin of Pure and Applied Sciences - Section - E - Mathematics & Statistics* 39E(1), 98-101
5. Mohamed Loey, Florentin Smarandache, Nour Eldeen M. Khalifa (2020). Within the Lack of Chest COVID-19 X-ray Dataset: A Novel Detection Model Based on GAN and Deep Transfer Learning. *Symmetry* 12, 651; DOI: 10.3390/sym12040651
6. Victor Christianto, Florentin Smarandache (2020). Remark on Artificial Intelligence, *humanoid* and *Terminator* scenario: A Neutrosophic way to futurology. *International Journal of Neutrosophic Science* 1(1), 8-13; DOI :10.5281/zenodo.3633438
7. Florentin Smarandache (2021). Pledoarie pentru excelență în cultură: despre Mircea Eugen Șelariu. *Bogdania* 87-88, 29-30
8. Victor Christianto, Florentin Smarandache (2021). Five examples on using spreadsheet to solve engineering and mathematical problems. *Octogon Mathematical Magazine* 29(1), 362-371
9. Victor Christianto, Florentin Smarandache, Sori Tjandrah Simbolon (2022). On mythical Dewaruci, Manunggaling kawula-Gusti and other nontrivial Javanese logic. *New Perspective in Theology and Religious Studies* 3(1), 14-22
10. Victor Christianto, Florentin Smarandache, Yunita Umniyati (2022). Beyond Post-Empiricism Doctrine: A New Philosophy of Discovery. *Scientific GOD Journal* 13(2), 106-123

Florentin Smarandache's Collected Papers series:*Collected Papers, Vol. I*

(first edition 1996, second edition 2007)

Free download: <http://fs.unm.edu/CP1.pdf>*Collected Papers, Vol. II*

(Chişinău, Moldova, 1997)

Free download: <http://fs.unm.edu/CP2.pdf>*Collected Papers, Vol. III*

(Oradea, Romania, 2000)

Free download: <http://fs.unm.edu/CP3.pdf>*Collected Papers, Vol. IV (100 Collected Papers of Sciences)**Multispace & Multistructure. Neutrosophic Transdisciplinarity*

(Hanko, Finland, 2010)

Free download: <http://fs.unm.edu/MultispaceMultistructure.pdf>*Collected Papers, Vol. V: Papers of Mathematics or Applied mathematics*

(Brussels, Belgium, 2014)

Free download: <http://fs.unm.edu/CP5.pdf>*Collected Papers, Vol. VI: on Neutrosophic Theory and Applications*

(Global Knowledge, 2022)

Free download: <http://fs.unm.edu/CP6.pdf>*Collected Papers, Vol. VII: on Neutrosophic Theory and Applications*

(Global Knowledge, 2022)

Free download: <http://fs.unm.edu/CP7.pdf>*Collected Papers, Vol. VIII: on Neutrosophic Theory and Applications*

(Global Knowledge, 2022)

Free download: <http://fs.unm.edu/CP8.pdf>*Collected Papers, Vol. IX: on Neutrosophic Theory and Its Applications in Algebra*

(Global Knowledge, 2022)

Free download: <http://fs.unm.edu/CP9.pdf>*Collected Papers, Vol. X: on Neutrosophics, Plithogenics, Hypersoft Set, Hypergraphs, and other topics*

(Global Knowledge, 2022)

Free download: <http://fs.unm.edu/CP10.pdf>*Collected Papers, Vol. XI: on Physics, Artificial Intelligence, Decision Making, Economics, Statistics*

(Global Knowledge, 2022)

Free download: <http://fs.unm.edu/CP11.pdf>*Collected Papers, Vol. XII: on Neutrosophics Theory and Applications*

(Global Knowledge, 2022)

Free download: <http://fs.unm.edu/CP12.pdf>

NEUTROSOPHIC THEORY AND APPLICATIONS

Applications of Neutrosophic Logic to Robotics: An Introduction

Florentin Smarandache, Luige Vlădăreanu

Florentin Smarandache, Luige Vlădăreanu (2011). Applications of neutrosophic logic to robotics: An introduction. *IEEE International Conference on Granular Computing*, 607-612; DOI: 10.1109/GRC.2011.6122666

Abstract In this paper we present the N-norms/N-conorms in neutrosophic logic and set as extensions of T-norms/T-conorms in fuzzy logic and set. Then we show some applications of the neutrosophic logic to robotics.

Keywords: *N-norm, N-conorm, N-pseudonorm, N-pseudoconorm, Neutrosophic set, Neutrosophic logic, Robotics*

I. DEFINITION OF NEUTROSOPHIC SET

Let T, I, F be real standard or non-standard subsets of $]0, 1^+[$, with $\sup T = t_{sup}, \inf T = t_{inf}$, $\sup I = i_{sup}, \inf I = i_{inf}$, $\sup F = f_{sup}, \inf F = f_{inf}$, and $n_{sup} = t_{sup} + i_{sup} + f_{sup}$, $n_{inf} = t_{inf} + i_{inf} + f_{inf}$.

Let U be a universe of discourse, and M a set included in U . An element x from U is noted with respect to the set M as $x(T, I, F)$ and belongs to M in the following way: it is t true in the set, i indeterminate (unknown if it is or not) in the set, and f false, where t varies in T , i varies in I , f varies in F ([1], [3]).

Statically T, I, F are subsets, but dynamically T, I, F are functions/operators depending on many known or unknown parameters.

II. DEFINITION OF NEUTROSOPHIC LOGIC

In a similar way we define the **Neutrosophic Logic**: A logic in which each proposition x is T true, I indeterminate, and F false, and we write it $x(T, I, F)$, where T, I, F are defined above.

III. PARTIAL ORDER

We define a *partial order relationship* on the neutrosophic set/logic in the following way:

$$x(T_1, I_1, F_1) \leq y(T_2, I_2, F_2) \text{ iff (if and only if) } T_1 \leq T_2, I_1 \leq I_2, F_1 \leq F_2 \text{ for crisp components.}$$

And, in general, for subunitary set components:

$$x(T_1, I_1, F_1) \leq y(T_2, I_2, F_2) \text{ iff } \inf T_1 \leq \inf T_2, \sup T_1 \leq \sup T_2, \inf I_1 \leq \inf I_2, \sup I_1 \leq \sup I_2, \inf F_1 \leq \inf F_2, \sup F_1 \leq \sup F_2.$$

If we have mixed - crisp and subunitary - components, or only crisp components, we can transform any crisp component, say "a" with a $\hat{I} \in]0, 1^+[$ or a $\hat{A} \in]0, 1^+[$, into a subunitary set $[a, a]$. So, the definitions for subunitary set components should work in any case.

IV. N-NORM AND N-CONORM

As a generalization of T-norm and T-conorm from the Fuzzy Logic and Set, we now introduce the **N-norms and N-conorms** for the Neutrosophic Logic and Set.

A. N-norm

$N_n: (]0, 1^+[\times]0, 1^+[\times]0, 1^+[\rightarrow]0, 1^+[\times]0, 1^+[\times]0, 1^+[$
 $N_n(x(T_1, I_1, F_1), y(T_2, I_2, F_2)) = (N_nT(x, y), N_nI(x, y), N_nF(x, y))$, where $N_nT(.,.), N_nI(.,.), N_nF(.,.)$ are the truth/membership, indeterminacy, and respectively falsehood/nonmembership components.

N_n have to satisfy, for any x, y, z in the neutrosophic logic/set M of the universe of discourse U , the following axioms:

- a) Boundary Conditions: $N_n(x, 0) = 0, N_n(x, 1) = x$.
- b) Commutativity: $N_n(x, y) = N_n(y, x)$.
- c) Monotonicity: If $x \leq y$, then $N_n(x, z) \leq N_n(y, z)$.
- d) Associativity: $N_n(N_n(x, y), z) = N_n(x, N_n(y, z))$.

There are cases when not all these axioms are satisfied, for example the associativity when dealing with the neutrosophic normalization after each neutrosophic operation. But, since we work with approximations, we can call these **N-pseudo-norms**, which still give good results in practice.

N_n represent the *and* operator in neutrosophic logic, and respectively the *intersection* operator in neutrosophic set theory.

Let $J \in \{T, I, F\}$ be a component.

Most known N-norms, as in fuzzy logic and set the T-norms, are:

- The Algebraic Product N-norm: $N_{n \text{ algebraic}}J(x, y) = x \cdot y$
- The Bounded N-Norm: $N_{n \text{ bounded}}J(x, y) = \max\{0, x + y - 1\}$
- The Default (min) N-norm: $N_{n \text{ min}}J(x, y) = \min\{x, y\}$.

A general example of N-norm would be this.

Let $x(T_1, I_1, F_1)$ and $y(T_2, I_2, F_2)$ be in the neutrosophic set/logic M. Then:

$$N_n(x, y) = (T_1 \wedge T_2, I_1 \vee I_2, F_1 \vee F_2)$$

where the “/” operator, acting on two (standard or non-standard) subunitary sets, is a N-norm (verifying the above N-norms axioms); while the “/” operator, also acting on two (standard or non-standard) subunitary sets, is a N-conorm (verifying the below N-conorms axioms).

For example, / can be the Algebraic Product T-norm/N-norm, so $T_1 / T_2 = T_1 \cdot T_2$ (herein we have a product of two subunitary sets – using simplified notation); and / can be the Algebraic Product T-conorm/N-conorm, so $T_1 / T_2 = T_1 + T_2 - T_1 \cdot T_2$ (herein we have a sum, then a product, and afterwards a subtraction of two subunitary sets).

Or / can be any T-norm/N-norm, and / any T-conorm/N-conorm from the above and below; for example the easiest way would be to consider the *min* for crisp components (or *inf* for subset components) and respectively *max* for crisp components (or *sup* for subset components).

If we have crisp numbers, we can at the end neutrosophically normalize.

B. N-conorm

$N_c: ([0,1]^+ \times [0,1]^+ \rightarrow [0,1]^+)^2 \rightarrow [0,1]^+ \times [0,1]^+ \rightarrow [0,1]^+$
 $N_c(x(T_1, I_1, F_1), y(T_2, I_2, F_2)) = (N_c T(x, y), N_c I(x, y), N_c F(x, y))$,
 where $N_n T(\dots)$, $N_n I(\dots)$, $N_n F(\dots)$ are the truth/membership, indeterminacy, and respectively falsehood/nonmembership components.

N_c have to satisfy, for any x, y, z in the neutrosophic logic/set M of universe of discourse U, the following axioms:

- a) Boundary Conditions: $N_c(x, \mathbf{1}) = \mathbf{1}$, $N_c(x, \mathbf{0}) = x$.
- b) Commutativity: $N_c(x, y) = N_c(y, x)$.
- c) Monotonicity: if $x \leq y$, then $N_c(x, z) \leq N_c(y, z)$.
- d) Associativity: $N_c(N_c(x, y), z) = N_c(x, N_c(y, z))$.

There are cases when not all these axioms are satisfied, for example the associativity when dealing with the neutrosophic normalization after each neutrosophic operation. But, since we work with approximations, we can call these **N-pseudo-conorms**, which still give good results in practice.

N_c represent the *or* operator in neutrosophic logic, and respectively the *union* operator in neutrosophic set theory.

Let $J \in \{T, I, F\}$ be a component.

Most known N-conorms, as in fuzzy logic and set the T-conorms, are:

The Algebraic Product N-conorm: $N_{c \text{ algebraic}} J(x, y) = x + y - x \cdot y$

The Bounded N-conorm: $N_{c \text{ bounded}} J(x, y) = \min\{1, x + y\}$

The Default (max) N-conorm: $N_{c \text{ max}} J(x, y) = \max\{x, y\}$.

A general example of N-conorm would be this.

Let $x(T_1, I_1, F_1)$ and $y(T_2, I_2, F_2)$ be in the neutrosophic set/logic M. Then:

$$N_n(x, y) = (T_1 \vee T_2, I_1 \wedge I_2, F_1 \wedge F_2)$$

Where – as above - the “/” operator, acting on two (standard or non-standard) subunitary sets, is a N-norm (verifying the above N-norms axioms); while the “/” operator, also acting on two (standard or non-standard) subunitary sets, is a N-conorm (verifying the above N-conorms axioms).

For example, / can be the Algebraic Product T-norm/N-norm, so $T_1 / T_2 = T_1 \cdot T_2$ (herein we have a product of two subunitary sets); and / can be the Algebraic Product T-conorm/N-conorm, so $T_1 / T_2 = T_1 + T_2 - T_1 \cdot T_2$ (herein we have a sum, then a product, and afterwards a subtraction of two subunitary sets).

Or / can be any T-norm/N-norm, and / any T-conorm/N-conorm from the above; for example the easiest way would be to consider the *min* for crisp components (or *inf* for subset components) and respectively *max* for crisp components (or *sup* for subset components).

If we have crisp numbers, we can at the end neutrosophically normalize.

Since the min/max (or inf/sup) operators work the best for subunitary set components, let’s present their definitions below. They are extensions from subunitary intervals {defined in [3]} to any subunitary sets. Analogously we can do for all neutrosophic operators defined in [3].

Let $x(T_1, I_1, F_1)$ and $y(T_2, I_2, F_2)$ be in the neutrosophic set/logic M.

C. More Neutrosophic Operators

Neutrosophic Conjunction/Intersection:

$$x / y = (T_f, I_f, F_f),$$

where $\inf T_f = \min\{\inf T_1, \inf T_2\}$
 $\sup T_f = \min\{\sup T_1, \sup T_2\}$
 $\inf I_f = \max\{\inf I_1, \inf I_2\}$
 $\sup I_f = \max\{\sup I_1, \sup I_2\}$
 $\inf F_f = \max\{\inf F_1, \inf F_2\}$
 $\sup F_f = \max\{\sup F_1, \sup F_2\}$

Neutrosophic Disjunction/Union:

$$x / y = (T_d, I_d, F_d),$$

where $\inf T_d = \max\{\inf T_1, \inf T_2\}$
 $\sup T_d = \max\{\sup T_1, \sup T_2\}$
 $\inf I_d = \min\{\inf I_1, \inf I_2\}$
 $\sup I_d = \min\{\sup I_1, \sup I_2\}$
 $\inf F_d = \min\{\inf F_1, \inf F_2\}$
 $\sup F_d = \min\{\sup F_1, \sup F_2\}$

Neutrosophic Negation/Complement:

$$C(x) = (T_c, I_c, F_c),$$

where $T_c = F_1$
 $\inf I_c = 1 - \sup I_1$

$$\frac{\sup I_C}{F_C} \quad 1 - \inf I_1$$

Upon the above Neutrosophic Conjunction/Intersection, we can define the

Neutrosophic Containment:

We say that the neutrosophic set A is included in the neutrosophic set B of the universe of discourse U, iff for any $x(T_A, I_A, F_A) \checkmark A$ with $x(T_B, I_B, F_B) \checkmark B$ we have:

$$\begin{aligned} \inf T_A & \leq \inf T_B; \sup T_A & \leq \sup T_B; \\ \inf I_A & \leq \inf I_B; \sup I_A & \leq \sup I_B; \\ \inf F_A & \leq \inf F_B; \sup F_A & \leq \sup F_B. \end{aligned}$$

D. Remarks

- a) The non-standard unit interval $]0, 1^+[$ is merely used for philosophical applications, especially when we want to make a distinction between relative truth (truth in at least one world) and absolute truth (truth in all possible worlds), and similarly for distinction between relative or absolute falsehood, and between relative or absolute indeterminacy.

But, for technical applications of neutrosophic logic and set, the domain of definition and range of the N-norm and N-conorm can be restrained to the normal standard real unit interval $[0, 1]$, which is easier to use, therefore:

$$\begin{aligned} N_n: & ([0,1] \quad [0,1] \quad [0,1])^2 \quad [0,1] \quad [0,1] \quad [0,1] \\ & \text{and} \\ N_c: & ([0,1] \quad [0,1] \quad [0,1])^2 \quad [0,1] \quad [0,1] \quad [0,1]. \end{aligned}$$

- b) Since in NL and NS the sum of the components (in the case when T, I, F are crisp numbers, not sets) is not necessary equal to 1 (so the normalization is not required), we can keep the final result un-normalized.

But, if the normalization is needed for special applications, we can normalize at the end by dividing each component by the sum all components.

If we work with intuitionistic logic/set (when the information is incomplete, i.e. the sum of the crisp components is less than 1, i.e. *sub-normalized*), or with paraconsistent logic/set (when the information overlaps and it is contradictory, i.e. the sum of crisp components is greater than 1, i.e. *over-normalized*), we need to define the neutrosophic measure of a proposition/set.

If $x(T,I,F)$ is a NL/NS, and T,I,F are crisp numbers in $[0,1]$, then the **neutrosophic vector norm** of variable/set x is the sum of its components:

$$N_{\text{vector-norm}}(x) = T+I+F.$$

Now, if we apply the N_n and N_c to two propositions/sets which maybe intuitionistic or paraconsistent or normalized (i.e. the sum of components less than 1, bigger than 1, or equal to 1), x and y, what should be the neutrosophic measure of the results $N_n(x,y)$ and $N_c(x,y)$?

Herein again we have more possibilities:

- either the product of neutrosophic measures of x and y:
 $N_{\text{vector-norm}}(N_n(x,y)) = N_{\text{vector-norm}}(x) N_{\text{vector-norm}}(y),$
- or their average:
 $N_{\text{vector-norm}}(N_n(x,y)) = (N_{\text{vector-norm}}(x) + N_{\text{vector-norm}}(y))/2,$
- or other function of the initial neutrosophic measures:

$$N_{\text{vector-norm}}(N_n(x,y)) = f(N_{\text{vector-norm}}(x), N_{\text{vector-norm}}(y)), \text{ where } f(.,.) \text{ is a function to be determined according to each application.}$$

Similarly for $N_{\text{vector-norm}}(N_c(x,y))$.

Depending on the adopted neutrosophic vector norm, after applying each neutrosophic operator the result is neutrosophically normalized. We'd like to mention that "**neutrosophically normalizing**" doesn't mean that the sum of the resulting crisp components should be 1 as in fuzzy logic/set or intuitionistic fuzzy logic/set, but the sum of the components should be as above: either equal to the product of neutrosophic vector norms of the initial propositions/sets, or equal to the neutrosophic average of the initial propositions/sets vector norms, etc.

In conclusion, we neutrosophically normalize the resulting crisp components T', I', F' by multiplying each neutrosophic component T', I', F' with $S/(T'+I'+F')$, where

$$S = N_{\text{vector-norm}}(N_n(x,y)) \text{ for a N-norm or } S = N_{\text{vector-norm}}(N_c(x,y)) \text{ for a N-conorm - as defined above.}$$

- c) If T, I, F are subsets of $[0, 1]$ the problem of neutrosophic normalization is more difficult.
 - i) If $\sup(T)+\sup(I)+\sup(F) = 1$, we have an *intuitionistic proposition/set*.
 - ii) If $\inf(T)+\inf(I)+\inf(F) = 1$, we have a *paraconsistent proposition/set*.
 - iii) If there exist the crisp numbers $t \in T, i \in I$, and $f \in F$ such that $t+i+f = 1$, then we can say that we have a *plausible normalized proposition/set*.

But in many such cases, besides the normalized particular case showed herein, we also have crisp numbers, say $t_1 \in T, i_1 \in I$, and $f_1 \in F$ such that $t_1+i_1+f_1 < 1$ (incomplete

information) and $t_2 \in T, i_2 \in I,$ and $f_2 \in F$ such that $t_2+i_2+f_2 = 1$ (paraconsistent information).

E. Examples of Neutrosophic Operators which are N-norms or N-pseudonorms or, respectively N-conorms or N-pseudoconorms

We define a binary **neutrosophic conjunction (intersection)** operator, which is a particular case of a N-norm (neutrosophic norm, a generalization of the fuzzy T-norm):

$$c_N^{NF} : ([0,1] \times [0,1] \times [0,1])^2 \rightarrow [0,1] \times [0,1] \times [0,1]$$

$$c_N^{NF}(x, y) = (T_1T_2, I_1I_2 + I_1T_2 + T_1I_2, F_1F_2 + F_1I_2 + F_1T_2 + F_2T_1 + F_2I_1)$$

The neutrosophic conjunction (intersection) operator $x \wedge_N y$ component truth, indeterminacy, and falsehood values result from the multiplication

$$(T_1 + I_1 + F_1) \cdot (T_2 + I_2 + F_2)$$

since we consider in a prudent way $T \text{ p } I \text{ p } F$, where “p” is a **neutrosophic relationship** and means “weaker”, i.e. the products $T_i I_j$ will go to I , $T_i F_j$ will go to F , and $I_i F_j$ will go to F for all $i, j \in \{1,2\}, i \neq j$, while of course the product $T_1 T_2$ will go to T , $I_1 I_2$ will go to I , and $F_1 F_2$ will go to F (or reciprocally we can say that F prevails in front of I which prevails in front of T , and this neutrosophic relationship is transitive):

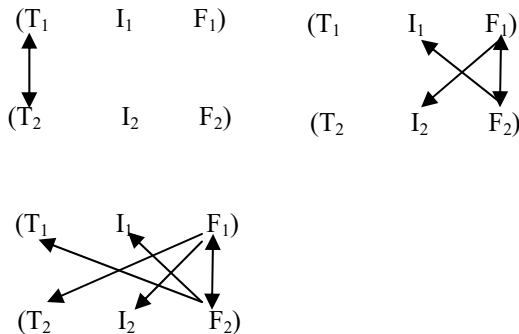

So, the truth value is T_1T_2 , the indeterminacy value is $I_1I_2 + I_1T_2 + T_1I_2$ and the false value is $F_1F_2 + F_1I_2 + F_1T_2 + F_2T_1 + F_2I_1$. The norm of $x \wedge_N y$ is $(T_1 + I_1 + F_1)(T_2 + I_2 + F_2)$. Thus, if x and y are normalized, then $x \wedge_N y$ is also normalized. Of course, the

reader can redefine the neutrosophic conjunction operator, depending on application, in a different way, for example in a more optimistic way, i.e. $I \text{ p } T \text{ p } F$ or T prevails with respect to I , then we get:

$$c_N^{IF}(x, y) = (T_1T_2 + T_1I_2 + T_2I_1, I_1I_2, F_1F_2 + F_1I_2 + F_1T_2 + F_2T_1 + F_2I_1)$$

Or, the reader can consider the order $T \text{ p } F \text{ p } I$, etc.

V. ROBOT POSITION CONTROL BASED ON KINEMATICS EQUATIONS

A robot can be considered as a mathematical relation of actuated joints which ensures coordinate transformation from one axis to the other connected as a serial link manipulator where the links sequence exists. Considering the case of revolute-geometry robot all joints are rotational around the freedom ax [4, 5]. In general having a six degrees of freedom the manipulator mathematical analysis becomes very complicated. There are two dominant coordinate systems: Cartesian coordinates and joints coordinates. Joint coordinates represent angles between links and link extensions. They form the coordinates where the robot links are moving with direct control by the actuators.

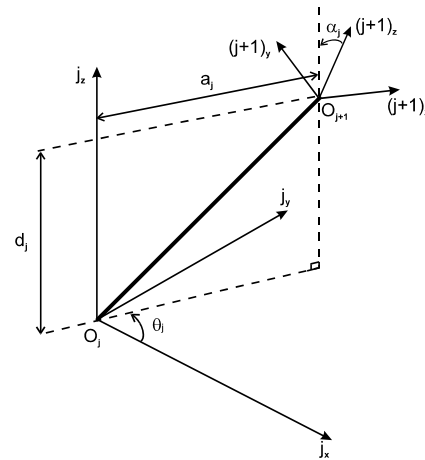

Fig.1. The robot control through DH transformation.

The position and orientation of each segment of the linkage structure can be described using Denavit-Hartenberg [DH] transformation [6]. To determine the D-H transformation matrix (Fig. 1) it is assumed that the Z-axis (which is the system’s axis in relation to the motion surface) is the axis of rotation in each frame, with the following notations: θ_j - joint angled is the joint angle positive in the right hand sense about j_z ; a_j - link length is the length of the common normal, positive in the direction of $(j+1)_x$; α_j - twist angled is the angle between j_z and $(j+1)_z$ positive in the right hand sense about the common normal; d_j - offset distance is the value of j_z at which the common normal intersects j_z ; as well if j_x and $(j+1)_x$ are parallel and in the

same direction, then $\theta_j = 0$; $(j+1)_X$ - is chosen to be collinear with the common normal between j_Z and $(j+1)_Z$ [7, 8]. Figure 1 illustrates a robot position control based on the Denavit-Hartenberg transformation. The robot joint angles, θ_c , are transformed in X_c - Cartesian coordinates with D-H transformation. Considering that a point in j , respectively $j+1$ is given by:

$$\begin{bmatrix} X \\ Y \\ Z \\ 1 \end{bmatrix}_j = {}^jP \quad \text{and} \quad \begin{bmatrix} X \\ Y \\ Z \\ 1 \end{bmatrix}_{j+1} = {}^{j+1}P' \quad (1)$$

then jP can be determined in relation to ${}^{j+1}P$ through the equation :

$${}^jP = {}^jA_{j+1} \cdot {}^{j+1}P, \quad (2)$$

where the transformation matrix ${}^jA_{j+1}$ is:

$${}^jA_{j+1} = \begin{bmatrix} \cos\theta_j - \sin\theta_j \cdot \cos\alpha_j + \sin\theta_j \cdot \sin\alpha_j \cdot a_j \cdot \cos\alpha_j & & & \\ \sin\theta_j - \cos\theta_j \cdot \cos\alpha_j - \cos\theta_j \cdot \sin\alpha_j \cdot a_j \cdot \sin\alpha_j & & & \\ 0 & \sin\theta_j & \cos\theta_j & d_j \\ 0 & 0 & 0 & 1 \end{bmatrix}.$$

Control through forward kinematics consists of the transformation of robot coordinates at any given moment, resulting directly from the measurement transducers of each axis, to Cartesian coordinates and comparing to the desired target's Cartesian coordinates (reference point). The resulting error is the difference of position, represented in Cartesian coordinates, which requires changing. Using the inverted Jacobean matrix ensures the transformation into robot coordinates of the position error from Cartesian coordinates, which allows the generating of angle errors for the direct control of the actuator on each axis.

The control using forward kinematics consists of transforming the actual joint coordinates, resulting from transducers, to Cartesian coordinates and comparing them with the desired Cartesian coordinates. The resulted error is a required position change, which must be obtained on every axis. Using the Jacobean matrix inverting it will manage to transform the change in joint coordinates that will generate angle errors for the motor axis control.

Figure 2 illustrates a robot position control system based on the Denavit-Hartenberg transformation. The robot joint angles, θ_c , are transformed in X_c - Cartesian coordinates with D-H transformation, where a matrix results from (1) and (2) with θ_j -joint angle, d_j -offset distance, a_j - link length, α_j - twist.

Position and orientation of the end effector with respect to the base coordinate frame is given by X_C :

$$X_C = A_1 \cdot A_2 \cdot A_3 \cdot \dots \cdot A_6 \quad (3)$$

Position error ΔX is obtained as a difference between desired and current position. There is difficulty in controlling robot trajectory, if the desired conditions are

specified using position difference ΔX with continuously measurement of current position $\theta_{1,2,\dots,6}$.

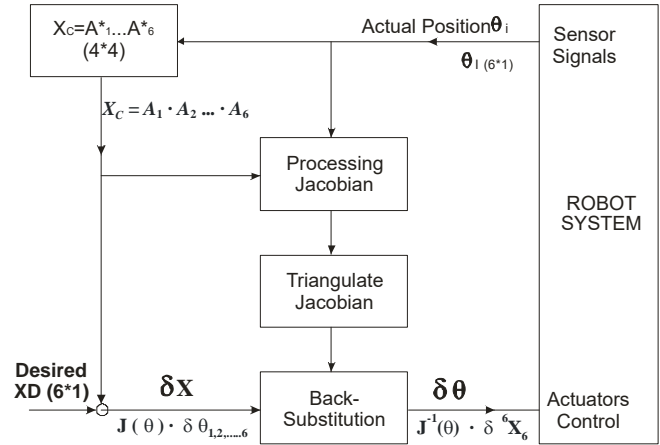

Fig. 2. Robot position control system based on the Denavit-Hartenberg transformation

The relation, between given by end-effector's position and orientation considered in Cartesian coordinates and the robot joint angles $\theta_{1,2,\dots,6}$, it is :

$$x_i = f_i(\theta) \quad (4)$$

where θ is vector representing the degrees of freedom of robot. By differentiating we will have: $\delta {}^6X_6 = J(\theta) \delta \theta_{1,2,\dots,6}$, where $\delta {}^6X_6$ represents differential linear and angular changes in the end effector at the currently values of X_6 and $\delta \theta_{1,2,\dots,6}$ represents the differential change of the set of joint angles. $J(\theta)$ is the Jacobean matrix in which the elements a_{ij} satisfy the relation: $a_{ij} = \delta f_{i-1} / \delta \theta_{j-1}$, (x.6) where i, j are corresponding to the dimensions of x respectively θ . The inverse Jacobean transforms the Cartesian position $\delta {}^6X_6$ respectively ΔX in joint angle error ($\Delta\theta$): $\delta \theta_{1,2,\dots,6} = J^{-1}(\theta) \delta {}^6X_6$.

VI. HYBRID POSITION AND FORCE CONTROL OF ROBOTS

Hybrid position and force control of industrial robots equipped with compliant joints must take into consideration the passive compliance of the system. The generalized area where a robot works can be defined in a constraint space with six degrees of freedom (DOF), with position constrains along the normal force of this area and force constrains along the tangents. On the basis of these two constrains there is described the general scheme of hybrid position and force control in figure 3. Variables X_C and F_C represent the Cartesian position and the Cartesian force exerted onto the environment. Considering X_C and F_C expressed in specific frame of coordinates, its can be determinate selection matrices S_x and S_f , which are diagonal matrices with 0 and 1

diagonal elements, and which satisfy relation: $S_x + S_f = I_d$, where S_x and S_f are methodically deduced from kinematics constrains imposed by the working environment [9, 10].

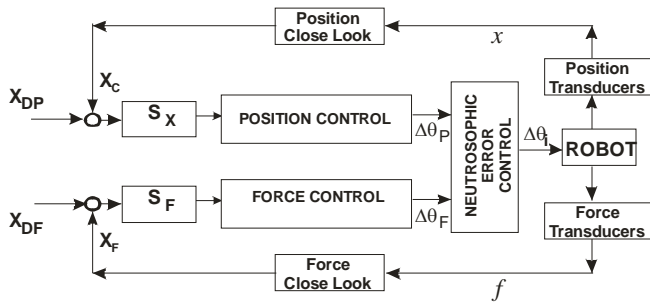

Fig. 3. General structure of hybrid control.

Mathematical equations for the hybrid position-force control. A system of hybrid position–force control normally achieves the simultaneous position–force control. In order to determine the control relations in this situation, ΔX_P – the measured deviation of Cartesian coordinate command system is split in two sets: ΔX^F corresponds to force controlled component and ΔX^P corresponds to position control with axis actuating in accordance with the selected matrixes S_f and S_x . If there is considered only positional control on the directions established by the selection matrix S_x there can be determined the desired end - effector differential motions that correspond to position control in the relation: $\Delta X_P = K_P \Delta X^P$, where K_P is the gain matrix, respectively desired motion joint on position controlled axis: $\Delta \theta_P = J^{-1}(\theta) \Delta X_P$ [11, 12].

Now taking into consideration the force control on the other directions left, the relation between the desired joint motion of end-effector and the force error ΔX_F is given by the relation: $\Delta \theta_F = J^{-1}(\theta) \Delta X_F$, where the position error due to force ΔX_F is the motion difference between ΔX^F – current position deviation measured by the control system that generates position deviation for force controlled axis and ΔX_D – position deviation because of desired residual force. Noting the given desired residual force as F_D and the physical rigidity K_W there is obtained the relation: $\Delta X_D = K_W^{-1} F_D$.

Thus, ΔX_F can be calculated from the relation: $\Delta X_F = K_F (\Delta X^F - \Delta X_D)$, where K_F is the dimensionless ratio of the stiffness matrix. Finally, the motion variation on the robot axis matched to the motion variation of the end-effectors is obtained through the relation: $\Delta \theta = J^{-1}(\theta) \Delta X_F + J^{-1}(\theta) \Delta X_P$. Starting from this representation the architecture of the hybrid position – force control system was developed with the corresponding coordinate transformations applicable to systems with open architecture and a distributed and decentralized structure.

For the fusion of information received from various sensors, information that can be conflicting in a certain degree, the robot uses the fuzzy and neutrosophic logic or set [3]. In a real time it is used a neutrosophic dynamic fusion, so an autonomous robot can take a decision at any moment.

CONCLUSION

In this paper we have provided in the first part an introduction to the neutrosophic logic and set operators and in the second part a short description of mathematical dynamics of a robot and then a way of applying neutrosophic science to robotics. Further study would be done in this direction in order to develop a **robot neutrosophic control**.

REFERENCES

- [1] Florentin Smarandache, *A Unifying Field in Logics: Neutrosophic Field, Multiple-Valued Logic / An International Journal*, Vol. 8, No. 3, 385-438, June 2002
- [2] Andrew Schumann, *Neutrosophic logics on Non-Archimedean Structures*, Critical Review, Creighton University, USA, Vol. III, 36-58, 2009.
- [3] Xinde Li, Xianzhong Dai, Jean Dezert, Florentin Smarandache, *Fusion of Imprecise Qualitative Information*, Applied Intelligence, Springer, Vol. 33 (3), 340-351, 2010.
- [4] Vladareanu L, *Real Time Control of Robots and Mechanisms by Open Architecture Systems*, cap.14, Advanced Engineering in Applied Mechanics, Eds-. T.Sireteanu,L.Vladareanu, Ed. Academiei 2006, pp.38, pg. 183-196, ISBN 978-973-27-1370-9
- [5] Vladareanu L, Ion I, Velea LM, Mitroi D, Gal A, "The Real Time Control of Modular Walking Robot Stability", Proceedings of the 8th International Conference on Applications of Electrical Engineering (AEE '09), Houston, USA, 2009,pg.179-186, ISSN: 1790-5117 , ISBN: 978-960-474-072-7
- [6] Denavit J., Hartenberg RB - *A kinematics notation for lower-pair mechanism based on matrices*. ASMEJ. Appl. Mechanics, vol.23June 1955, pg.215-221
- [7] Sidhu G.S. – *Scheduling algorithm for multiprocessor robot arm control*, Proc. 19th Southeastern Symp., March,1997
- [8] Vladareanu L; Tont G; Ion I; Vladareanu V; Mitroi D; *Modeling and Hybrid Position-Force Control of Walking Modular Robots*; American Conference on Applied Mathematics, pg:510-518; Harvard Univ, Cambridge, Boston, USA, 2010; ISBN: 978-960-474-150-2.
- [9] L.D.Joly, C.Andriot, V.Hayward, *Mechanical Analogic in Hybrid Position/Force Control*, IEEE Albuquerque, New Mexico, pg. 835-840, April 1997
- [10] Vladareanu L, *The robots' real time control through open architecture systems*, cap.11, Topics in Applied Mechanics, vol.3, Ed.Academiei 2006, pp.460-497, ISBN 973-27-1004-7
- [11] Vladareanu L, Sandru OI, Velea LM, YU Hongnian, *The Actuators Control in Continuous Flux using the Winer Filters*, Proceedings of Romanian Academy, Series A, Volume: 10 Issue: 1 Pg.: 81-90, 2009, ISSN 1454-9069
- [12] Yoshikawa T., Zheng X.Z. - *Coordinated Dynamic Hybrid Position/Force Control for Multiple Robot Manipulators Handling One Constrained Object*, The International Journal of Robotics Research, Vol. 12, No. 3, June 1993, pp. 219-230

Clustering Neutrosophic Data Sets and Neutrosophic Valued Metric Spaces

Ferhat Taş, Selçuk Topal, Florentin Smarandache

Ferhat Taş, Selçuk Topal, Florentin Smarandache (2018). Clustering Neutrosophic Data Sets and Neutrosophic Valued Metric Spaces. *Symmetry* 10, 430; DOI: 10.3390/sym10100430

Abstract: In this paper, we define the neutrosophic valued (and generalized or G) metric spaces for the first time. Besides, we newly determine a mathematical model for clustering the neutrosophic big data sets using G -metric. Furthermore, relative weighted neutrosophic-valued distance and weighted cohesion measure, is defined for neutrosophic big data set. We offer a very practical method for data analysis of neutrosophic big data although neutrosophic data type (neutrosophic big data) are in massive and detailed form when compared with other data types.

Keywords: G -metric; neutrosophic G -metric; neutrosophic sets; clustering; neutrosophic big data; neutrosophic logic

1. Introduction and Preliminaries

Neutrosophic Logic is a neonate study area in which each proposition is estimated to have the proportion (percentage) of truth in a subset T , the proportion of indeterminacy in a subset I , and the proportion of falsity in a subset F . We utilize a subset of truth (or indeterminacy, or falsity), instead of a number only, since in many situations we do not have ability to strictly specify the proportions of truth and of falsity but only approximate them; for instance, a proposition is between 25% and 55% true and between 65% and 78% false; even worse: between 33% and 48% or 42 and 53% true (pursuant to several observer), and 58% or between 66% and 73% false. The subsets are not essential intervals, but any sets (open or closed or half open/half-closed intervals, discrete, continuous, intersections or unions of the previous sets, etc.) in keeping with the given proposition. Zadeh initiated the adventure of obtaining meaning and mathematical results from uncertainty situations (fuzzy) [1]. Fuzzy sets brought a new dimension to the concept of classical set theory. Atanassov introduced intuitionistic fuzzy sets including membership and non-membership degrees [2]. Neutrosophy was proposed by Smarandache as a computational approach to the concept of neutrality [3]. Neutrosophic sets consider membership, non-membership and indeterminacy degrees. Intuitionistic fuzzy sets are defined by the degree of membership and non-membership and, uncertainty degrees by the 1-(membership degree plus non-membership degree), while the degree of uncertainty is evaluated independently of the degree of membership and non-membership in neutrosophic sets. Here, membership, non-membership, and degree of uncertainty (uncertainty), such as degrees of accuracy and falsity, can be evaluated according to the interpretation of the places to be used. It depends entirely on the subject area (the universe of discourse). This reveals a difference between neutrosophic set and intuitionistic fuzzy set. In this sense, the concept of neutrosophic is a possible solution and representation of problems in various fields. Two detailed and mathematical fundamental differences between relative truth (IFL) and absolute truth (NL) are:

- (i) NL can discern absolute truth (truth in all possible worlds, according to Leibniz) from the relative truth (truth in at least one world) because NL (absolute truth) = 1^+ while IFL (relative truth) = 1. This has practice in philosophy (see the Neutrosophy). The standard interval $[0, 1]$ used in IFL has been extended to the unitary non-standard interval $]^- 0, 1^+ [$ in NL. Parallel earmarks for absolute or relative falsehood and absolute or relative indeterminacy are permitted in NL.
- (ii) There is no limit on T, I, F other than they are subsets of $]^- 0, 1^+ [$, thus: $^- 0 \leq \inf T + \inf I + \inf F \leq \sup T + \sup I + \sup F \leq 3^+$ in NL. This permissiveness allows dialetheist, paraconsistent, and incomplete information to be described in NL, while these situations cannot be described in IFL since F (falsehood), T (truth), I (indeterminacy) are restricted either to $t + i + f = 1$ or to $t^2 + f^2 \leq 1$, if T, I, F are all reduced to the points t, i, f respectively, or to $\sup T + \sup I + \sup F = 1$ if T, I, F are subsets of $[0, 1]$ in IFL.

Clustering data is one of the most significant problems in data analysis. Useful and efficient algorithms are needed for big data. This is even more challenging for neutrosophic data sets, particularly those involving uncertainty. These sets are elements of some decision-making problems, [4–8]. Several distances and similarities are used for decision-making problems [9,10]. Algorithms for the clustering big data sets use the distances (metrics). There are some metrics used in algorithms to analysis neutrosophic data sets: Hamming, Euclidean, etc. In this paper, we examine clustering of neutrosophic data sets via neutrosophic valued distances.

The big data notion is a new label for the giant size of data—both structured and unstructured—that overflows several sectors on a time-to-time basis. It does not mean overall data are significant and the significant aspect is to obtain desired specific data interpretation. Big data can be analyzed for pre-cognition that make possible more consistent decisions and strategic having positions. Doug Laney [11] sort to make the definition of big data the three Vs and Veracity widespread: (1) Velocity: This refers to dynamic data and captures data streams in near real-time. Data streams in at an exceptional speed and must be dealt with in a well-timed mode. (2) Variety: Data comes in all types of formats—from structured, numeric data in traditional databases to formless materials. On the one hand, variety denotes to the various sources and types of organized and formless data. Storing data is made from sources like worksheets and databases. (3) Volume: Organizations gather data from a range of sources, including social media, business operations, and data from the sensor or machine to machine. (4) Veracity: It mentions to the biases, noise, and anomaly in data. That corresponds with the question “Is the data that is being put in storage and extracted meaningful to the problem being examined?”.

In this paper, we also focus on K-sets cluster algorithm which is a process of analyzing data with the aim of evaluating neutrosophic big data sets. The K-sets cluster is an unrestrained type of learning that is used when one wants to utilize unlabeled data, [12]. The goal of the algorithm is to find groups of data with the number of groups represented by variable K. The algorithm works iteratively to set-aside each data point obtained to one of the K groups based on the properties obtained. The data points are clustered according to feature similarity. Instead of identifying groups before examining patterns, clustering helps to find and analyze naturally occurring groups. “Choosing K” has the goal of “how the number of groups can be determined”. Each center of a congregation is a collection of property values describe the groups that emerged. Analysis of centroid feature weights can be used to qualitatively interpret what kind of group is represented by each cluster. The algorithm finds the clusters and data set labels for a particular pre-chosen K. To have the number of clusters in the data, the user must run the K-means clustering algorithm for a range of K values and compare the results. In general, there is no technique to determine a specific K value, but a precise estimate can be obtained using the following methods. In general, one of the metrics used to compare the results between the different K values as the average distance between the data points and their cluster synthesis. As the number of sets increases, it will always reduce the distance to the data points, while the K increment will always lower this metric as other criteria, and when K is the same as the number of data points, reaching zero will be excessive. Thus, this metric cannot be used as a single purpose. Rather, the

average distance to the center as a function of K is plotted where the shear rate falls sharply, it can be used to determine K approximately.

A number of other techniques are available for verification of K , including cross-validation, information criteria, information theoretical jump method, and G-tools algorithm. In addition, monitoring the distribution of data points between groups provides information about how the algorithm splits data for each K . K -sets algorithms base on the measurement of distances of sets. A distance is a measurement of how far apart each pair of elements of a given set is. Distance functions in mathematics and many other computational sciences are important concepts. They have wide usage areas, for example, the goal of quantifying a dissimilarity (or equivalently similarity) between two objects, sets or set of sets in some sense. However, due to the massive, complicated and different type data sets today, definitions of distance functions are required to be more generalized and detailed. For this purpose, we define a novel metric for similarity and distance to give Neutrosophic Valued-Metric Spaces (NVGMS). We present relative weighted measure definition and finally K -sets algorithm after given the definition of NVGMS.

Some readers who are unfamiliar with the topic in this paper need to have a natural example to understand the topic well. There is a need for earlier data in everyday life to give a natural example for the subject first described in this paper. There is no this type of data (we mean neutrosophic big data) in any source, but we will give an example of how to obtain and cluster such a data in Section 6 of the paper. If we encounter a sample of neutrosophic big data in the future, we will present the results with a visual sample as a technical report. In this paper, we have developed a mathematically powerful method for the notion of concepts that are still in its infancy.

1.1. G-Metric Spaces

Metric space is a pair of (A, d) , where A is a non-empty set and d is a metric which is defined by a certain distance and the elements of the set A . Some metrics may have different values such as a complex-valued metric [13,14]. Mustafa and Sims defined G -metric by generalizing this definition [15]. Specifically, fixed point theorems on analysis have been used in G -metric spaces [16,17].

Definition 1. Let A be a non-empty set and d be a metric on A , then if the following conditions hold, the pair (A, d) is called a metric space. Let $x, y, z \in A$

- (1) $d(x, y) \geq 0$, (non-negativity)
- (2) $d(x, y) = 0 \Leftrightarrow x = y$, (identity)
- (3) $d(x, y) = d(y, x)$, (symmetry)
- (4) $d(x, z) \leq d(x, y) + d(y, z)$ (triangle inequality).

where $d : A \times A \rightarrow \mathbb{R}^+ \cup \{0\}$.

Definition 2. [15] Let A be a non-empty set. A function $G : A \times A \times A \rightarrow [0, +\infty)$ is called G -distance if it satisfies the following properties:

- (1) $G(x, y, z) = 0$ if and only if $x = y = z$,
- (2) $G(x, x, y) \neq 0$ whenever $x \neq y$,
- (3) $G(x, x, y) \leq G(x, y, z)$ for any $x, y, z \in A$, with $z \neq y$,
- (4) $G(x, y, z) = G(x, z, y) = \dots$ (symmetric for all elements),
- (5) $G(x, y, z) \leq G(x, a, a) + G(a, y, z)$ for all $a, x, y, z \in A$ (Rectangular inequality).

The pair (A, G) is called a G -metric space. Moreover, if G -metric has the following property then it is called symmetric: $G(x, x, y) = G(x, y, y), \forall x, y \in A$.

Example 1. In 3-dimensional Euclidean metric space, one can assume the G-metric space (E^3, G) as the following:

$$G(x, y, z) = 2(\|x \times y\| + \|z \times y\| + \|x \times z\|)$$

where $x, y, z \in E^3$ and $\|\cdot \times \cdot\|$ represent the norm of the vector product of two vectors in E^3 . It is obvious that it satisfies all conditions in the Definition 2 because of the norm has the metric properties, and it is symmetric.

Example 2. Let (A, d) is a metric space. Then

$$G(x, y, z) = d(x, y) + d(y, z) - d(x, z)$$

is a G-metric, where $x, y, z \in A$. The fact that d is a metric indicates that it has triangle inequality. Thus, G is always positive definite.

Proposition 1. [17] Let (A, G) be a G-metric space then a metric on A can be defined from a G-metric:

$$d_G(x, y) = G(x, x, y) + G(x, y, y)$$

1.2. Neutrosophic Sets

Neutrosophy is a generalized form of the philosophy of intuitionistic fuzzy logic. In neutrosophic logic, there is no restriction for truth, indeterminacy, and falsity and they have a unit real interval value for each element neutrosophic set. These values are independent of each other. Sometimes, intuitionistic fuzzy logic is not enough for solving some real-life problems, i.e., engineering problems. So, mathematically, considering neutrosophic elements are becoming important for modelling these problems. Studies have been conducted in many areas of mathematics and other related sciences especially computer science since Smarandache made this philosophical definition, [18,19].

Definition 3. Let E be a universe of discourse and $A \subseteq E$. $A = \{(x, T(x), I(x), F(x)) : x \in E\}$ is a neutrosophic set or single valued neutrosophic set (SVNS), where $T_A, I_A, F_A : A \rightarrow]^{-0}, 1^{+}[$ are the truth-membership function, the indeterminacy-membership function and the falsity-membership function, respectively. Here, $-0 \leq T_A(x) + I_A(x) + F_A(x) \leq 3^+$.

Definition 4. For the SVNS A in E , the triple $\langle T_A, I_A, F_A \rangle$ is called the single valued neutrosophic number (SVNN).

Definition 5. Let $n = \langle T_n, I_n, F_n \rangle$ be an SVNN, then the score function of n can be given as follow:

$$s_n = \frac{1 + T_n - 2I_n - F_n}{2} \tag{1}$$

where $s_n \in [-1, 1]$.

Definition 6. Let $n = \langle T_n, I_n, F_n \rangle$ be an SVNN, then the accuracy function of n can be given as follow:

$$h_n = \frac{2 + T_n - I_n - F_n}{3} \tag{2}$$

where $h_n \in [0, 1]$.

Definition 7. Let n_1 and n_2 be two SVNNs. Then, the ranking of two SVNNs can be defined as follows:

- (I) If $s_{n_1} > s_{n_2}$, then $n_1 > n_2$;
- (II) If $s_{n_1} = s_{n_2}$ and $h_{n_1} \geq h_{n_2}$, then $n_1 \geq n_2$.

2. Neutrosophic Valued Metric Spaces

The distance is measured via some operators which are defined in some non-empty sets. In general, operators in metric spaces have zero values, depending on the set and value.

2.1. Operators

Definition 8. [20,21], Let A be non-empty SVN and $x = \langle T_x, I_x, F_x \rangle, y = \langle T_y, I_y, F_y \rangle$ be two SVN. The operations that addition, multiplication, multiplication with scalar $\alpha \in \mathbb{R}^+$, and exponential of SVN are defined as follows, respectively:

$$\begin{aligned} x \oplus y &= \langle T_x + T_y - T_x T_y, I_x I_y, F_x F_y \rangle \\ x \odot y &= \langle T_x T_y, I_x + I_y - I_x I_y, F_x + F_y - F_x F_y \rangle \\ \alpha x &= \langle 1 - (1 - T_x)^\alpha, I_x^\alpha, F_x^\alpha \rangle \\ x^\alpha &= \langle T_x^\alpha, 1 - (1 - I_x)^\alpha, 1 - (1 - F_x)^\alpha \rangle \end{aligned}$$

From this definition, we have the following theorems as a result:

Theorem 1. Let $x = \langle T_x, I_x, F_x \rangle$ be an SVN. The neutral element of the additive operator of the set A is $0_A = \langle 0, 1, 1 \rangle$.

Proof. Let $x = \langle T_x, I_x, F_x \rangle$ and $0_A = \langle T_0, I_0, F_0 \rangle$ are two SVN and using Definition 8 we have

$$\begin{aligned} x \oplus 0_A &= \langle T_x + T_0 - T_x T_0, I_x I_0, F_x F_0 \rangle = \langle T_x, I_x, F_x \rangle \\ &\Rightarrow \langle T_0, I_0, F_0 \rangle = \langle 0, 1, 1 \rangle = 0_A \end{aligned}$$

(There is no need to show left-hand side because the operator is commutative in every component).

□

To compare the neutrosophic values based on a neutral element, we shall calculate the score and accuracy functions of a neutral element $0_A = \langle 0, 1, 1 \rangle$, respectively:

$$s_0 = \frac{1 + T_0 - 2I_0 - F_0}{2} = -1 \text{ and } h_0 = \frac{2 + T_0 - I_0 - F_0}{3} = 0$$

Theorem 2. Let $x = \langle T_x, I_x, F_x \rangle$ be an SVN. The neutral element of the multiplication operator of the A is $1_A = \langle 1, 0, 0 \rangle$.

Proof. Let $x = \langle T_x, I_x, F_x \rangle$ and $1_A = \langle T_1, I_1, F_1 \rangle$ are two SVN and using Definition 8 we have

$$\begin{aligned} x \odot 1_A &= \langle T_x T_1, I_x + I_1 - I_x I_1, F_x + F_1 - F_x F_1 \rangle = \langle T_x, I_x, F_x \rangle \\ &\Rightarrow \langle T_1, I_1, F_1 \rangle = \langle 1, 0, 0 \rangle = 1_A \end{aligned}$$

In addition, score and accuracy functions of the neutral element $1_A = \langle 1, 0, 0 \rangle$ are $s_1 = \frac{1+T_1-2I_1-F_1}{2} = 1$ and $h_1 = \frac{2+T_1-I_1-F_1}{3} = 1$, respectively. □

2.2. Neutrosophic Valued Metric Spaces

In this section, we consider the metric and generalized metric spaces in the neutrosophic meaning.

Definition 9. Ordering in the Definition 6 gives an order relation for elements of the conglomerate SVN. Suppose that the mapping $d : X \times X \rightarrow A$, where X and A are SVN, satisfies:

- (I) $0_A \leq d(x, y)$ and $d(x, y) = 0_A \Leftrightarrow s_x = s_y$ and $h_x = h_y$ for all $x, y \in X$.
- (II) $d(x, y) = d(y, x)$ for all $x, y \in X$.

Then d is called a neutrosophic valued metric on X , and the pair (X, d) is called neutrosophic valued metric space. Here, the third condition (triangular inequality) of the metric spaces is not suitable for SVN spaces because the addition is not ordinary addition.

Theorem 3. Let (X, d) be a neutrosophic valued metric space. Then, there are relationships among truth, indeterminacy and falsity values:

- (I) $0 < T(x, y) - 2I(x, y) - F(x, y) + 3$ and if $s_o = s_d$ then $0 < T(x, y) - I(x, y) - F(x, y) + 2$.
- (II) If $d(x, y) = 0_A \Leftrightarrow T(x, y) = 0, I(x, y) = F(x, y) = 1$.
- (III) $T(x, y) = T(y, x), I(x, y) = I(y, x), F(x, y) = F(y, x)$ so, each distance function must be symmetric.

where $T(.,.), I(.,.)$ and $F(.,.)$ are distances within themselves of the truth, indeterminacy and falsity functions, respectively.

Proof.

- (I) $0_A < d(x, y) \Leftrightarrow \langle 0, 1, 1 \rangle < \langle T(x, y), I(x, y), F(x, y) \rangle$
 $\Leftrightarrow s_o < s_d \Leftrightarrow -1 < \frac{1 + T(x, y) - 2I(x, y) - F(x, y)}{2}$
 $\Leftrightarrow 0 < T(x, y) - 2I(x, y) - F(x, y) + 3$
- (II) $d(x, y) = d(y, x) \Leftrightarrow \langle T(x, y), I(x, y), F(x, y) \rangle = \langle T(y, x), I(y, x), F(y, x) \rangle$
 $\Leftrightarrow T(x, y) = T(y, x), I(x, y) = I(y, x), F(x, y) = F(y, x) \quad \square$

Example 3. Let A be non-empty SVN spaces and $x = \langle T_x, I_x, F_x \rangle, y = \langle T_y, I_y, F_y \rangle$ be two SVN spaces. If we define the metric $d : X \times X \rightarrow A$, as:

$$d(x, y) = \langle T(x, y), I(x, y), F(x, y) \rangle = \langle |T_x - T_y|, 1 - |I_x - I_y|, 1 - |F_x - F_y| \rangle$$

then

- (I) $0 < |T_x - T_y| - 2(1 - |I_x - I_y|) - (1 - |F_x - F_y|) + 3$
 $\Rightarrow 0 < |T_x - T_y| + 2|I_x - I_y| + |F_x - F_y|$
 Then it satisfies the first condition.

- (II) Since the properties of the absolute value function, this condition is obvious.
 So, (X, d) is a neutrosophic-valued metric space.

3. Neutrosophic Valued G-Metric Spaces

Definition 10. Let X and A be a non-empty SVN spaces. A function $G : X \times X \times X \rightarrow A$ is called neutrosophic valued G-metric if it satisfies the following properties:

- (1) $G(x, y, z) = 0_A$ if and only if $x = y = z$,
- (2) $G(x, x, y) \neq 0_A$ whenever $x \neq y$,
- (3) $G(x, x, y) \leq G(x, y, z)$ for any $x, y, z \in X$, with $z \neq y$,
- (4) $G(x, y, z) = G(x, z, y) = \dots$ (symmetric for all elements).

The pair (X, G) is called a neutrosophic valued G-metric space.

Theorem 4. Let (X, G) be a neutrosophic valued G-metric space then, it satisfies followings:

- (1) $T(x, x, x) = 0, I(x, x, x) = F(x, x, x) = 1.$
- (2) Assume $x \neq y$, then $T(x, y, z) \neq 0, I(x, y, z) \neq 1, F(x, y, z) \neq 1.$
- (3) $0 < T(x, y, z) - T(x, x, y) + 2(I(x, x, y) - I(x, y, z)) + F(x, x, y) - F(x, y, z)$
- (4) $T(x, y, z), I(x, y, z)$ and $F(x, y, z)$ are symmetric for all elements.

where $T(.,.,.), I(.,.,.)$ and $F(.,.,.)$ are G-distance functions of truth, indeterminacy and falsity values of the element of the set, respectively.

Proofs are made in a similar way to neutrosophic valued metric spaces.

Example 4. Let X be non-empty SVNS and the G-distance function defined by:

$$G(x, y, z) = \frac{1}{3}(d(x, y) \oplus d(x, z) \oplus d(y, z))$$

where $d(.,.)$ is a neutrosophic valued metric. The pair (X, G) is obviously a neutrosophic valued G-metric space because of $d(.,.)$. Further, it has commutative properties.

4. Relative Weighted Neutrosophic Valued Distances and Cohesion Measures

The relative distance measure is a method used for clustering of data sets, []. We define the relative weighted distance, which is a more sensitive method for big data sets.

Let $x_i = \langle T_{x_i}, F_{x_i}, I_{x_i} \rangle \in A$ (non-empty SVNS), $i = 0 \dots n$ be SVNNs. Then neutrosophic weighted average operator of these SVNNs is defined as:

$$M_n(A) = \sum_{i=1}^n \chi_i x_i = \left\langle 1 - \prod_{i=1}^n (1 - T_{x_i})^{\chi_i}, \prod_{i=1}^n (I_{x_i})^{\chi_i}, \prod_{i=1}^n (F_{x_i})^{\chi_i} \right\rangle$$

where χ_i is weighted for the i th data. For a given a neutrosophic data set $W = \{w_1, w_2, w_3, \dots, w_n\}$ and a neutrosophic valued metric d , we define a relative neutrosophic valued distance for choosing another reference neutrosophic data and compute the relative neutrosophic valued distance as the average of the difference of distances for all the neutrosophic data $w_i \in W$.

Definition 11. The relative neutrosophic valued distance from a neutrosophic data w_i to another neutrosophic data w_j is defined as follows:

$$RD \langle w_i || w_j \rangle = \frac{1}{n} \sum_{w_k \in W} (d(w_i, w_j) \ominus d(w_i, w_k))$$

Here, since T, I, F values of SVNNs cannot be negative, we can define the expression $d(w_i, w_j) \ominus d(w_i, w_k)$ as the distance between these two neutrosophic-valued metrics. Furthermore, the distance of metrics is again neutrosophic-valued here so, a related neutrosophic-valued distance can be defined as:

$$d(w_i, w_j) \ominus d(w_i, w_k) = \langle T(w_i, w_j), I(w_i, w_j), F(w_i, w_j) \rangle \ominus \langle T(w_i, w_k), I(w_i, w_k), F(w_i, w_k) \rangle$$

$$= \langle 1 - |T(w_i, w_j) - (T(w_i, w_k) - 1)|^2, 1 - |I(w_i, w_j) - I(w_i, w_k)|^2, 1 - |F(w_i, w_j) - F(w_i, w_k)|^2 \rangle \quad (3)$$

The difference operator \ominus generally is not a neutrosophic-valued metric (or G-metric). We used some abbreviations for saving space.

$$\begin{aligned}
 RD(w_i || w_j) &= \frac{1}{n} \sum_{w_k \in W} (d(w_i, w_j) \ominus d(w_i, w_k)) \\
 &= d(w_i, w_j) \ominus \frac{1}{n} \sum_{w_k \in W} d(w_i, w_k) \\
 &= \langle T(w_i, w_j), I(w_i, w_j), F(w_i, w_j) \rangle \ominus \frac{1}{n} (d(w_i, w_1) \oplus d(w_i, w_2) \oplus \dots \oplus d(w_i, w_n)) \\
 &= \langle T(w_i, w_j), I(w_i, w_j), F(w_i, w_j) \rangle \\
 &\ominus \frac{1}{n} [\langle T(w_i, w_1), I(w_i, w_1), F(w_i, w_1) \rangle \oplus \dots \oplus \langle T(w_i, w_n), I(w_i, w_n), F(w_i, w_n) \rangle] \\
 &= \langle T(w_i, w_j), I(w_i, w_j), F(w_i, w_j) \rangle \\
 &\ominus \frac{1}{n} \left[\left\langle \sum_{k \in W} T(w_i, w_k) - \prod_{k \in W} T(w_i, w_k), \prod_{k \in W} I(w_i, w_k), \prod_{k \in W} F(w_i, w_k) \right\rangle \right] \\
 &= \langle T(w_i, w_j), I(w_i, w_j), F(w_i, w_j) \rangle \\
 &\ominus \left\langle 1 - \left[1 - \sum_{k \in W} T(w_i, w_k) + \prod_{k \in W} T(w_i, w_k) \right]^{1/n}, \prod_{k \in W} I(w_i, w_k)^{1/n}, \prod_{k \in W} F(w_i, w_k)^{1/n} \right\rangle \\
 &= \langle T_1, I_1, F_1 \rangle \ominus \langle T_2, I_2, F_2 \rangle \\
 &= \langle 1 - |T_1 - (T_2 - 1)^2|, 1 - |I_1 - I_2^2|, 1 - |F_1 - F_2^2| \rangle
 \end{aligned}$$

where T_1, I_1, F_1 and T_2, I_2, F_2 are the first, second, and third elements of SVNN in the previous equation, respectively.

Definition 12. The relative weighted neutrosophic valued distance from a neutrosophic data w_i to another neutrosophic data w_j is defined as follows:

$$\begin{aligned}
 RD_{\chi}(w_i || w_j) &= \sum_{\substack{w_k \in W \\ i \neq j, j \neq k, i \neq k}} \chi_w (d(w_i, w_j) \ominus d(w_i, w_k)) \\
 &= \chi_{ij} d(w_i, w_j) \ominus \sum_{\substack{w_k \in W \\ i \neq j, j \neq k, i \neq k}} \chi_{ik} d(w_i, w_k) \\
 &= \chi_{ij} \langle T(w_i, w_j), I(w_i, w_j), F(w_i, w_j) \rangle \\
 &\ominus (\chi_{i1} \langle T(w_i, w_1), I(w_i, w_1), F(w_i, w_1) \rangle \oplus \dots \oplus \chi_{in} \langle T(w_i, w_n), I(w_i, w_n), F(w_i, w_n) \rangle) \\
 &= \langle 1 - (1 - T(w_i, w_j))^{\chi_{ij}}, I(w_i, w_j)^{\chi_{ij}}, F(w_i, w_j)^{\chi_{ij}} \rangle \\
 &\ominus \left(\langle 1 - (1 - T(w_i, w_1))^{\chi_{i1}}, I(w_i, w_1)^{\chi_{i1}}, F(w_i, w_1)^{\chi_{i1}} \rangle \oplus \dots \right. \\
 &\quad \left. \oplus \langle 1 - (1 - T(w_i, w_n))^{\chi_{in}}, I(w_i, w_n)^{\chi_{in}}, F(w_i, w_n)^{\chi_{in}} \rangle \right) \\
 &= \langle 1 - (1 - T(w_i, w_j))^{\chi_{ij}}, I(w_i, w_j)^{\chi_{ij}}, F(w_i, w_j)^{\chi_{ij}} \rangle \\
 &\ominus \left\langle \sum_{\substack{k=1 \\ k \neq i, j}}^n \tilde{T}_{ik} - \prod_{\substack{k=1 \\ k \neq i, j}}^n \tilde{T}_{ik}, \prod_{\substack{k=1 \\ k \neq i, j}}^n \tilde{I}_{ik}, \prod_{\substack{k=1 \\ k \neq i, j}}^n \tilde{F}_{ik} \right\rangle \\
 &= \langle T_1, I_1, F_1 \rangle \ominus \langle T_2, I_2, F_2 \rangle \\
 &= \langle 1 - |T_1 - (T_2 - 1)^2|, 1 - |I_1 - I_2^2|, 1 - |F_1 - F_2^2| \rangle
 \end{aligned}$$

where $\tilde{T}_{ik} = 1 - (1 - T(w_i, w_k))^{\chi_{ik}}, \tilde{I}_{ik} = I(w_i, w_k)^{\chi_{ik}}, \tilde{F}_{ik} = F(w_i, w_k)^{\chi_{ik}}$.

Definition 13. The relative weighted neutrosophic valued distance (from a random neutrosophic data w_i) to a neutrosophic data w_j is defined as follows:

$$\begin{aligned} RD_\chi(w_j) &= \sum_{w_i \in W} \chi_i RD_\chi(w_i || w_j) \\ &= \sum_{w_i \in W} \chi_i \left[\sum_{w_k \in W} \chi_w (d(w_i, w_j) \oplus d(w_i, w_k)) \right] \\ &= \sum_{w_i \in W} \chi_i \left[\sum_{w_k \in W} \chi_w (\delta(d_{ij}, d_{ik})) \right] \end{aligned}$$

Definition 14. The relative weighted neutrosophic valued distance from a neutrosophic data set W_1 to another neutrosophic data set W_2 is defined as follows:

$$RD_\chi(W_1 || W_2) = \sum_{x \in W_1} \chi_x \sum_{y \in W_2} \chi_y RD_\chi(x || y)$$

Definition 15. (Weighted cohesion measure between two neutrosophic data) The difference of the relative weighted neutrosophic-valued distance to w_j and the relative weighted neutrosophic-valued distance from w_i to w_j , i.e.,

$$\rho_\chi(w_i, w_j) = RD_\chi(w_j) \ominus RD_\chi(w_i || w_j) \tag{4}$$

is called the weighted neutrosophic-valued cohesion measure between two neutrosophic data w_i and w_j . If $\rho_\chi(w_i, w_j) \geq 0_W$ (resp. $\rho_\chi(w_i, w_j) \leq 0_W$) then w_i and w_j are said to be cohesive (resp. incohesive). So, the relative weighted neutrosophic distance from w_i and w_j is not larger than the relative weighted neutrosophic distance (from a random neutrosophic data) to w_j .

Definition 16. (Weighted cohesion measure between two neutrosophic data sets) Let w_i and w_j are elements of the neutrosophic data sets U and V , respectively. Then the measure

$$\rho_\chi(U, V) = \sum_{w_i \in U} \chi_u \sum_{w_j \in V} \chi_v \rho_\chi(w_i, w_j) \tag{5}$$

is called weighted cohesion neutrosophic-valued measure of the neutrosophic data sets U and V .

Definition 17. (Cluster) The non-empty neutrosophic data set W is called a cluster if it is cohesive, i.e., $\rho(W, W) \geq 0_W$.

5. Clustering via Neutrosophic Valued G-Metric Spaces

In this section, we can cluster neutrosophic big data thank to defined weighted distance definitions in Section 4 and G-metric definition.

Definition 18. The neutrosophic valued weighted G-distance from a neutrosophic data w to a neutrosophic big data set U is defined as follows:

$$G(w, y, z) = \sum_{y \in U} \chi_u \sum_{z \in U} \chi_u (d(w, y) \oplus d(w, z) \oplus d(y, z)) \tag{6}$$

Algorithm (K-sets algorithm)

Input: A neutrosophic big data set $W = \{w_1, w_2, \dots, w_n\}$, a neutrosophic distance measure $d(.,.)$, and the number of sets K .

Output: A partition of neutrosophic sets $\{U_1, U_2, \dots, U_K\}$.

1. Initially, choose arbitrarily K disjoint nonempty sets U_1, U_2, \dots, U_K as a partition of W .
 2. for i from 1 to n do
 - begin
 - Compute $G(x_i, y_k, z_k)$ for each set U_k .
 - Find the set to which the point x_i is closest in terms of G -distance.
 - Assign point x_i to that set.
 - end
 3. Repeat from 2 until there is no further change.
-

6. Application and Example

We will give an example of the definition of the data that could have this kind of data and fall into the frame to fit this definition. We can call a data set a big data set if it is difficult and/or voluminous to define, analyze and visualize a data set. We give a big neutrosophic data example in accordance with this definition and possible use of G -metric, but it is fictional since there is no real neutrosophic big data example yet. It is a candidate for a good example that one of the current topics, image processing for big data analysis. Imagine a camera on a circuit board that is able to distinguish colors, cluster all the tools it can capture in the image and record that data. The camera that can be used for any color (for example white color vehicle) assigns the following degrees:

- (I) The vehicle is at a certain distance at which the color can be detected, and the truth value of the portion of the vehicle is determined.
- (II) The rate at which the vehicle can be detected by the camera is assigned as the uncertainty value (the mixed color is the external factors such as the effect of daylight and the color is determined on a different scale).
- (III) The rate of not seeing a large part of the vehicle or the rate of out of range of the color is assigned as the value of falsity.

Thus, data of the camera is clustering via G -metric. This result gives that the numbers according to the daily quantities and colors of vehicles passing by are determined. The data will change continuously as long as the road is open, and the camera records the data. There will be a neutrosophic data for each vehicle. So, a Big Neutrosophic Data Clustering will occur.

Here, the weight functions we have defined for the metric can be given 1 value for the main colors (red-yellow-blue). For other secondary or mixed colors, the color may be given a proportional value depending on which color is closer.

A Numerical Toy Example

Take 5 neutrosophic data with their weights are equal to 1 to make a numerical example:

$$W = \{w_1 \langle 0.6, 0.6, 0.6 \rangle, w_2 \langle 0.8, 0.4, 0.5 \rangle, w_3 \langle 0.5, 0.8, 0.7 \rangle, w_4 \langle 0.9, 0.5, 0.6 \rangle, w_5 \langle 0.1, 0.2, 0.7 \rangle\}$$

$K = 3$ disjoint sets can be chosen $U_1 = \{w_1, w_4, w_5\}, U_2 = \{w_2, w_3\}$.

Then

$$d(w_i, w_j) = \begin{bmatrix} \langle 0, 1, 1 \rangle & \langle 0.2, 0.8, 0.9 \rangle & \langle 0.1, 0.8, 0.9 \rangle & \langle 0.3, 0.9, 1.0 \rangle & \langle 0.5, 0.6, 0.9 \rangle \\ \langle 0.2, 0.8, 0.9 \rangle & \langle 0, 1, 1 \rangle & \langle 0.3, 0.6, 0.8 \rangle & \langle 0.1, 0.9, 0.9 \rangle & \langle 0.7, 0.8, 0.8 \rangle \\ \langle 0.1, 0.8, 0.9 \rangle & \langle 0.3, 0.6, 0.8 \rangle & \langle 0, 1, 1 \rangle & \langle 0.4, 0.7, 0.9 \rangle & \langle 0.4, 0.4, 1.0 \rangle \\ \langle 0.3, 0.9, 1.0 \rangle & \langle 0.1, 0.9, 0.9 \rangle & \langle 0.4, 0.7, 0.9 \rangle & \langle 0, 1, 1 \rangle & \langle 0.2, 0.8, 0.9 \rangle \\ \langle 0.5, 0.6, 0.9 \rangle & \langle 0.7, 0.8, 0.8 \rangle & \langle 0.4, 0.4, 1.0 \rangle & \langle 0.2, 0.8, 0.9 \rangle & \langle 0, 1, 1 \rangle \end{bmatrix}$$

where we assume the $d(w_i, w_j)$ as in Example 3. So, we can compute the G-metrics of the data as in Equation (3):

$$\begin{aligned} G(w_1, U_1) &= G(w_1, w_4, w_5) = \langle 0.99, 0.90, 0.91 \rangle \\ G(w_1, U_2) &= G(w_1, w_2, w_3) = \langle 0.79, 0.72, 0.83 \rangle \\ G(w_2, U_1) &= G(w_2, w_1, w_4) \oplus G(w_2, w_1, w_5) \oplus G(w_2, w_4, w_5) = \langle 0.9874, 0.6027, 0.6707 \rangle \\ G(w_2, U_2) &= G(w_2, w_2, w_3) = \langle 0, 1, 1 \rangle \\ G(w_3, U_1) &= G(w_3, w_1, w_4) \oplus G(w_3, w_1, w_5) \oplus G(w_3, w_4, w_5) = \langle 1, 0.4608, 0.6707 \rangle \\ G(w_3, U_2) &= G(w_3, w_2, w_3) = \langle 0, 1, 1 \rangle \\ G(w_4, U_1) &= G(w_4, w_1, w_5) = \langle 0.81, 0.64, 0.91 \rangle \\ G(w_4, U_2) &= G(w_4, w_2, w_3) = \langle 0.97, 0.73, 0.83 \rangle \end{aligned}$$

So, according to the calculations above, w_4 belongs to set U_1 and the other data belong to U_2 . Here, we have made the data belonging to the clusters according to the fact that the truth values of the G-metrics are mainly low. If the truth value of G-distance is low, then the data is closer to the set.

7. Conclusions

This paper has introduced many new notions and definitions for clustering neutrosophic big data and geometric similarity metric of the data. Neutrosophic data sets have density. For example, sets having indeterminacy density or neutrosophic density and these are adding the more data and complexity. So, neutrosophic data sets are complex big data sets. Separation and clustering of these sets are evaluated according to weighted distances. Neutrosophic data sets in the last part of the paper, K-sets algorithm has been given for neutrosophic big data sets. We hope that the results in this paper can be applied to other data types like interval neutrosophic big data sets and can be analyzed in other metric spaces such as neutrosophic complex valued G-metric spaces etc. and can help to solve problems in other study areas.

References

1. Zadeh, L.A. Fuzzy sets. *Inf. Control* **1965**, *8*, 338–353. [[CrossRef](#)]
2. Atanassov, K.T. Intuitionistic fuzzy sets. *Fuzzy Sets Syst.* **1986**, *20*, 87–96. [[CrossRef](#)]
3. Smarandache, F. *Neutrosophy: Neutrosophic Probability, Set and Logic*; American Research Press: Rehoboth, NM, USA, 1998.
4. Deli, I.; Subas, Y. Single valued neutrosophic numbers and their applications to multicriteria decision making problem. *Neutrosophic Sets Syst.* **2014**, *2*, 1–13.
5. Fan, C.; Fan, E.; Ye, J. The Cosine Measure of Single-Valued Neutrosophic Multisets for Multiple Attribute Decision-Making. *Symmetry* **2018**, *10*, 154. [[CrossRef](#)]
6. Li, Y.; Liu, P.; Chen, Y. Some single valued neutrosophic number heronian mean operators and their application in multiple attribute group decision making. *Informatica* **2016**, *27*, 85–110. [[CrossRef](#)]

7. Lu, Z.; Ye, J. Single-valued neutrosophic hybrid arithmetic and geometric aggregation operators and their decision-making method. *Information* **2017**, *8*, 84. [[CrossRef](#)]
8. Ye, J.; Smarandache, F. Similarity measure of refined single-valued neutrosophic sets and its multicriteria decision making method. *Neutrosophic Sets Syst.* **2016**, *12*, 41–44.
9. Guo, Y.; Şengür, A.; Ye, J. A novel image thresholding algorithm based on neutrosophic similarity score. *Measurement* **2014**, *58*, 175–186. [[CrossRef](#)]
10. Xia, P.; Zhang, L.; Li, F. Learning similarity with cosine similarity ensemble. *Inf. Sci.* **2015**, *307*, 39–52. [[CrossRef](#)]
11. Laney, D. *3D Data Management: Controlling Data Volume, Velocity and Variety*; Meta Group: Stamford, CT, USA, 2001.
12. Chang, C.; Liao, W.; Chen, Y.; Liou, L. A Mathematical Theory for Clustering in Metric Spaces. *IEEE Trans. Netw. Sci. Eng.* **2016**, *3*, 2–16. [[CrossRef](#)]
13. Azam, A.; Fisher, B.; Khan, M. Common fixed point theorems in complex valued metric spaces. *Numer. Funct. Anal. Optim.* **2011**, *32*, 243–253. [[CrossRef](#)]
14. El-Sayed Ahmed, A.; Omran, S.; Asad, A.J. Fixed Point Theorems in Quaternion-Valued Metric Spaces. *Abstr. Appl. Anal.* **2014**, *2014*, 9. [[CrossRef](#)]
15. Mustafa, Z.; Sims, B. A new approach to generalized metric spaces. *J. Nonlinear Convex Anal.* **2006**, *7*, 289–297.
16. Abbas, M.; Nazir, T.; Radenović, S. Some periodic point results in generalized metric spaces. *Appl. Math. Comput.* **2010**, *217*, 4094–4099. [[CrossRef](#)]
17. Khamsi, M.A. Generalized metric spaces: A survey. *J. Fixed Point Theory Appl.* **2015**, *17*, 455–475. [[CrossRef](#)]
18. Smarandache, F. Neutrosophic set—A generalization of the intuitionistic fuzzy sets. *Int. J. Pure Appl. Math.* **2005**, *24*, 287–297.
19. Vasantha, W.B.; Smarandache, F. *Some Neutrosophic Algebraic Structures and Neutrosophic N-Algebraic Structures*; Hexis: Phoenix, AZ, USA, 2006.
20. Şahin, M.; Kargin, A. Neutrosophic triplet normed space. *Open Phys.* **2017**, *15*, 697–704. [[CrossRef](#)]
21. Stanujkic, D.; Smarandache, F.; Zavadskas, E.K.; Karabasevic, D. *An Approach to Measuring the Website Quality Based on Neutrosophic Sets*; Infinite Study: Brussel, Belgium, 2018.

Three possible applications of Neutrosophic Logic in Fundamental and Applied Sciences

Victor Christianto, Robert N. Boyd, Florentin Smarandache

Victor Christianto, Robert N. Boyd, Florentin Smarandache (2020). Three possible applications of Neutrosophic Logic in Fundamental and Applied Sciences. *International Journal of Neutrosophic Science* 1(2), 90-95; DOI: 10.5281/zenodo.3692037

Abstract

In Neutrosophic Logic, a basic assertion is that there are variations of about everything that we can measure; the variations surround three parameters called T,I,F (truth, indeterminacy, falsehood) which can take a range of values. This paper shortly reviews the links among aether and matter creation from the perspective of Neutrosophic Logic. Once we accept the existence of aether as physical medium, then we can start to ask on what causes matter ejection, as observed in various findings related to quasars etc. One particular cosmology model known as VMH (variable mass hypothesis) has been suggested by notable astrophysicists like Halton Arp and Narlikar, and the essence of VMH model is matter creation processes in various physical phenomena. Nonetheless, matter creation process in Nature remains a big mystery for physicists, biologists and other science researchers. To this problem Neutrosophic Logic offers a solution. We also discuss two other possible applications of Neutrosophic Logic. In short, Neutrosophic Logic may prove useful in offering resolution to long standing conflicts.

Keywords : Neutrosophic Logic, Physical Neutrosophy, aether, matter creation, integrative medicine

1. Introduction

Matter creation process in Nature remains a big mystery for physicists, biologists and other science researchers. To this problem Neutrosophic Logic offers a solution, along solutions to two other problems, namely the point particle assumption in Quantum Electrodynamics and also in resolving the old paradigm conflict between Western approach to medicine and Eastern approach.

In short, Neutrosophic Logic may prove useful in offering resolution to long standing conflicts. See also our previous papers on this matter. [29-30]

2. Matter creation processes

Physicists throughout many centuries have debated over the physical existence of aether medium. Since its inception by Isaac Newton and later on Anton Mesmer (Franz Anton Mesmer 1734 – 1815), many believed that it is needed because otherwise there is no way to explain interaction at a distance in a vacuum space. We need medium of interaction, of which has been called by various names, such as: quantum vacuum, zero point field, etc.

Nonetheless, modern physicists would answer: no, it is not needed, especially after Special Relativity theory. Some would even say that aether has been removed even since Maxwell's theory, but it is not true : James Clark Maxwell initially suggested a mechanical model of aether vortices in his theory [26-28]. Regardless of those debates, both approaches (with or without assuming aether) are actually resulting in the same empirical results [9].

The famous Michelson-Morley experiments were thought to give null result to aether hypothesis, and historically it was the basis of Einstein's STR. Nonetheless, newer discussions proved that the evidence was rather ambiguous, from MM data itself. Especially after Dayton Miller experiments of aether drift were reported, more and more data came to support aether hypothesis, although many physicists would prefer a new terms such as physical vacuum or superfluid vacuum. See [21]-[25].

Once we accept the existence of aether as physical medium, then we can start to ask on what causes matter ejection, as observed in various findings related to quasars etc. One particular cosmology model known as VMH (variable mass hypothesis) has been suggested by notable astrophysicists like Halton Arp and Narlikar, and the essence of VMH model is matter creation processes in various physical phenomena. Nonetheless, matter creation process in Nature remains a big mystery for physicists, biologists and other science researchers. To this problem Neutrosophic Logic offers a solution.

Although we can start with an assumption of aether medium is composed of particle-antiparticle pairs, which can be considered as a model based on Dirac's new aether by considering vacuum fluctuation (see Sinha, Sivaram, Sudharsan.) [5][6] Nonetheless, we would prefer to do a simpler assumption as follows:

Let us assume that under certain conditions that aether can transform using Bose condensation process to become "unmatter", a transition phase of material, which then it sublimates into matter (solid, gas, liquid). Unmatter can also be considered as "pre-physical matter."

Summarizing our idea, it is depicted in the following block diagram:¹

¹ The matter creation scheme as outlined here is different from Norman & Dunning-Davies's argument: "Energy may be derived at a quantum of 0.78 MeV to artificially create the resonant oscillatory condensations of a neutroid, then functioning as a Poynting vortex to induce a directionalized scalar wave of that quantum toward that vortical receptive surface." See R.L. Norman & J. Dunning-Davies, Energy and matter creation: The Poynting Vortex, 2019, vixra.org/1910.0241

Aether → bose condensation → “unmatter” (pre-physical matter) → sublimation → ordinary matter/particle

Diagram 1. How aether becomes ordinary matter

Actually the term “unmatter” can be viewed as a solution from perspective of Neutrosophic Logic. A bit of history of unmatter term may be useful here:

“The word ‘Unmatter’ was coined by one of us (F. Smarandache) and published in 2004 in three papers on the subject. Unmatter is formed by combinations of matter and antimatter that bound together, or by long-range mixture of matter and antimatter forming a weakly-coupled phase. The idea of unparticle was first considered by F. Smarandache in 2004, 2005 and 2006, when he uploaded a paper on CERN web site and he published three papers about what he called ‘unmatter’, which is a new form of matter formed by matter and antimatter that bind together. Unmatter was introduced in the context of ‘neutrosophy’ (Smarandache, 1995) and ‘paradoxism’ (Smarandache, 1980), which are based on combinations of opposite entities ‘A’ and ‘antiA’ together with their neutralities ‘neutA’ that are in between.”² See also Smarandache [13].

Nonetheless, in this paper, unmatter is considered as a transition state (pre-physical) from aether to become ordinary matter/particle, see also [14].

Moreover, superfluid model of dark matter has been discussed by some authors [7].

As one more example/case of our proposed scheme of transition from aether to matter, see a recent paper [18]. See the illustrations at pages 5 and 6 of [18] regarding the physically observed properties of the Galactic Center (GC), which are obviously completely different from the imaginary ‘black hole’ model.

The mapping of the magnetic field structures of the Core is a profile of a torus, as we have previously suggested. Page 5 also illustrates the relation between Sag A and Sag B and the space in between them.

These illustrations are also relevant to matter creation at the galactic scale. Also note the gamma ray distributions in [18], which are relevant to matter destruction processes. Electrical discharges such as lightning, stars, and galaxies, all produce gamma rays. Gamma ray resonance dissociates atomic matter back into the aether at the rate of 6,800,000,000 horsepower of energy liberated per gram of matter dissociated per second. And where does all that energy go? Back into creating new matter. It's a never-ending cycle, and infinitely Universe-wide.

3. Towards QED without renormalization

² <http://fs.unm.edu/unmatter.htm>

One problem in theoretical physics is how to do away with infinity and divergence in QED without renormalization. As we know, renormalization group theory was hailed as cure in order to solve infinity problem in QED theory.

For instance, a quote from Richard Feynman goes as follows:

“What the three Nobel Prize winners did, in the words of Feynman, was to get rid of the infinities in the calculations. The infinities are still there, but now they can be skirted around . . . We have designed a method for sweeping them under the rug. [19]

And Paul Dirac himself also wrote with similar tune:

“Hence most physicists are very satisfied with the situation. They say: Quantum electrodynamics is a good theory, and we do not have to worry about it any more. I must say that I am very dissatisfied with the situation, because this so-called good theory does involve neglecting infinities which appear in its equations, neglecting them in an arbitrary way. This is just not sensible mathematics. Sensible mathematics involves neglecting a quantity when it turns out to be small not neglecting it just because it is infinitely great and you do not want it!”[20]

Here we submit a viewpoint that the problem begins with assumption of point particle in classical and quantum electrodynamics. Therefore, a solution shall be sought in developing fluidic Electrodynamics [10], i.e. by using fluid particle, or perhaps we can call it “fluidicle.” It is hoped that a fluidicle can remove the infinity problem caused by divergence. And fluidicle can be viewed as a solution from perspective of Neutrosophic Logic.

4. Another application: Resolution to conflicting paradigms in medicine

It is well known by most medicine practitioners, that Western approach to medicine is based on “curing” or “attacking” a disease, one by one. This is called germ theory: one cure for one disease (Pasteur). On the opposite side, Eastern medicine is based in particular on ancient wisdom of returning the balance of the body, in other words: to harmonize our body and our live with nature. Although those two approaches in medicine and healthcare have caused so many conflicts and misunderstandings, actually it is possible to do a dialogue between them.

From Neutrosophic Logic perspective, a resolution to the above conflicting paradigms can be found in developing novel approaches which appreciate both traditions in medicine, or we may call such an approach: “curemony,” i.e. by at the same time curing a disease and restoring balance and returning harmony in one’s body-mind-spirit as a whole. Although we don’t mention here specific case example, in general speaking we can mention:

- a. in HGH therapy, it is known that nutrition can affect the well-being of body [12],
- b. in the same way Epigenetics admits the role of external factors into the genes.
- c. We can also mention that psoriasis –a skin problem- can be related to stress and other emotions, which suggests a plausible new term: psychodermatology.[11]

All of these examples seem to suggest relational aspect within human being, among mind-body-spirit, just like what Eastern medicine emphasizes all along. In some literature, such a dialogue between Western and Eastern medicine approaches can be considered as integrative medicine, but actually it goes far deeper that just “integrative”, it is more like rethinking the “isolate and solve” attitude of Western scientists, toward more “relational biology.” And the

concept of systems biology or relational biology have become new terms in recent years. See also recent literatures in this subject [15][16][17].

Hopefully many more approaches can be developed in the direction as mentioned above.

5. Conclusions

In this paper, we discussed three possible applications of Neutrosophic Logic in the field of matter creation processes etc. For instance, a redefinition of term “unmatter” is proposed here, where under certain conditions, aether can transform using Bose condensation process to become “unmatter”, a transition phase of material, which then it sublimates into matter (solid, gas, liquid). Unmatter can also be considered as “pre-physical matter.” Moreover, a transition phase between fluid and particle (or fluidicle) is considered necessary in order to solve the “point particle” assumption which cause the divergence problem in QED. And for the third application of NL, we consider a dialogue is possible between Eastern and Western approaches to medicine.

Further researches are recommended in the above directions.

Acknowledgment

The authors wish to thank to many scholars, especially to four anonymous reviewers for suggesting improvement to this manuscript.

References

- [1] Montgomery Childs and Michael Clarage. <https://www.safireproject.com/>
- [2] V. Christianto, F. Smarandache, R.N. Boyd. Electron Model Based Helmholtz’s Electron Vortex & Kolmogorov’s Theory of Turbulence. *Prespacetime J.* Vol. 10 no. 1 (2019) url: <https://prespacetime.com/index.php/pst/article/view/1516>
- [3] V. Christianto & F. Smarandache. One-note-Samba approach to cosmology. *Prespacetime J.*, Vol. 10, no. 6 (2019). <https://prespacetime.com/index.php/pst/article/view/1586/1532>
- [4] <https://www.cosmic-core.org/free/article-99-the-aether-part-2-aether-advocates-experiments/>
- [5] Sinha, Sivaram, Sudharsan. Aether as a superfluid state of particle-antiparticle pairs. *Foundations of Physics*, Vol. 6, No. 1 (1976)
- [6] Sinha. Bose condensation of particle-antiparticle systems. *Pra mana – J. Phys.* Vol. 25 (1985).
- [7] Lasha Berezhiani and Justin Khoury. Dark Matter Super fluidity and Galactic Dynamics. arXiv:1506.07877 (2015)
- [8] Martin J. Cooper. Vortex Motions in Ideal Bose Superfluid. *JOURNAL OF RESEARCH of the National Bureau of Standards - A. Physics and Chemistry* Val. 73A, No.3, May-June 1969.
- [9] Pablo Acuña L. On the Empirical Equivalence between Special Relativity and Lorentz’s Ether Theory.
- [10] A.A. Martin & M. Pinheiro. Fluidic electrodynamics. *Physics of Fluids* vol. 21 (2009)
- [11] Don Colbert. *Deadly Emotions*. Nashville: Thomas Nelson Inc., 2003.
- [12] Bamgbola & Kaskel. GROWTH HORMONE THERAPY IN CHRONIC KIDNEY DISEASE. *Growth, Genetics, Hormones* Vol. 21 no. 1 (2005)

- [13] F. Smarandache. A Unifying Field in Logics: Neutrosophic Logic. Neutrosophy, Neutrosophic Set, Neutrosophic Probability (sixth edition). url: <http://fs.unm.edu/eBook-Neutrosophics6.pdf>
- [14] G. Le Bon. Evolution of matter. The Walter Scott Publishing Co., Ltd. (London) Ch. Scribner's Sons (New York), 1909. Url: <http://rexresearch.com/lebonmat/lebonmat.htm>
- [15] J. Wedel. Bridging the Gap between Western and Indigenous Medicine in Eastern Nicaragua. ANTHROPOLOGICAL NOTEBOOKS 15 (1).
- [16] Christina L. Ross. Integral Healthcare: The Benefits and Challenges of Integrating Complementary and Alternative Medicine with a Conventional Healthcare Practice. Integrative Medicine Insights 2009;4 13–20
- [17] Tsuei JJ: Eastern and Western approaches to medicine. West J Med 128:551-557, Jun 1979.
- [18] Mehmet Guenduez et al. A Novel Analytical Model of the Magnetic Field Configuration in the Galactic Center Explaining the Diffuse Gamma-Ray Emission. PLoS. arXiv:1909.08379v1 [astro-ph.GA] 18 Sep 2019 .
- [19] “Dr. Richard Feynman Nobel Laureate.” California Tech, October 22, 1965. http://caltechcampuspubs.library.caltech.edu/662/1/1965_10_22_67_5_05.pdf
- [20] P. A. M. Dirac, Directions in Physics (1978), 2. Quantum Electrodynamics.
- [21] Swenson, Loyd S. (1970). The Michelson–Morley–Miller Experiments before and after 1905, Journal for the History of Astronomy. 1 (2): 56–78
- [22] Swenson, Loyd S. The Ethereal ether: A History of the Michelson-Morley-Miller Aether-drift Experiments, 1880-1930. The University of Texas – Austin, 2013. url: https://books.google.co.id/books/about/The_Ethereal_Aether.html?id=kQTUAAAAQBAJ&redir_esc_y
- [23] Dayton Miller. The Ether-Drift Experiment and the Determination of the Absolute Motion of the Earth, Reviews of Modern Physics, Vol.5(2), p.203-242, July 1933. See also [23a] Dayton Miller, untitled lecture in Conference on the Michelson-Morley Experiment, Astrophysical Journal, LXVIII:341-402, Dec. 1928; also in Contributions From the Mount Wilson Observatory, No.373, Carnegie Institution of Washington
- [24] James DeMeo. Dayton J. Miller revisited. In Should the Laws of Gravitation be Reconsidered? Hector Monera, Editor, Allieiron, Montreal 2011, 11.285-315. url: <http://www.orgonelab.org/demeopubsPDFs/2011Miller.pdf>
- [25] M. Consoli & A. Pluchino. Michelson-Morley Experiments: An Enigma for Physics and the History of Science. World Scientific, 2018. url: <https://www.worldscientific.com/worldscibooks/10.1142/11209>
- [26] James Clark Maxwell. On Physical Line of Forces. [26a] Maxwell, J. C., A Treatise on Electricity and Magnetism, 3rd edition, Dover, New York, 1954; The Dover edition is an unabridged, slightly altered, republication of the third edition, published by the Clarendon Press in 1891.
- [27] Freeman J. Dyson. Why is it so hard to understand Maxwell equations? url: <http://www.damtp.cam.ac.uk/user/tong/em/dyson.pdf>
- [28] Arthur D. Yaghjian. Reactions on Maxwell's Treatise. Progress In Electromagnetics Research, Vol. 149, 217–249, 2014
- [29] Robert Kowalski. A logic-based approach to conflict resolution. url: <http://www.doc.ic.ac.uk/~rak/papers/conflictresolution.pdf>
- [30] V. Christianto & F. Smarandache. A Review of Seven Applications of Neutrosophic Logic: In Cultural Psychology, Economics Theorizing, Conflict Resolution, Philosophy of Science, etc. J 2019, 2(2), 128-137; <https://doi.org/10.3390/j2020010>

Indeterminacy in Neutrosophic Theories and their Applications

Florentin Smarandache

Florentin Smarandache (2021). Indeterminacy in Neutrosophic Theories and their Applications. *International Journal of Neutrosophic Science* 15(2), 89-97; DOI:10.5281/zenodo.5295819

Abstract

Indeterminacy makes the main distinction between fuzzy / intuitionistic fuzzy (and other extensions of fuzzy) set / logic vs. neutrosophic set / logic, and between classical probability and neutrosophic probability. Also, between classical statistics vs. neutrosophic and plithogenic statistics, between classical algebraic structures vs. neutrosophic algebraic structures, between crisp numbers vs. neutrosophic numbers. We present a broad definition of indeterminacy, various types of indeterminacies, and many practical applications.

Keywords: Indeterminacy, Neutrality, neutA, Neutrosophic Triplets, Types of Indeterminacies, Numerical Indeterminacy, Literal Indeterminacy, Neutrosophic Number, Quadruple Neutrosophic Number, Refined Indeterminacy, Subindeterminacies, Null Indeterminacy, Over-/Under-/Off-Indeterminacy, TransIndeterminacies

1. Introduction

This paper is written after the author received many questions about the concept of Indeterminacy utilized in the neutrosophic theories (such as Neutrosophic Set / Logic / Probability / Statistics / Measure / Precalculus / Calculus / Algebraic Structures), by emails and especially on the very popular websites such as: Researchgate.net, Academia.edu, Facebook, Twitter, and LinkedIn. And after discussions with Dr. Said Broumi and Dr. Nivetha Martin.

The most general definition, the classification, and many real examples of Indeterminacies from our everyday life, utilized in the neutrosophic theories and their applications, are presented below in an understandable manner. "Indeterminacy" should not be taken into the narrow sense of a lexical dictionary, but as something that is in between the opposites.

Because of dealing with various types of indeterminacies (vague, unclear, uncertain, conflicting, incomplete, hesitancy, neutrality, unknown, etc.) related to the data or to the procedures employed in our real world, we may extend by neutrosophication any classical scientific or cultural crisp concept from any field of knowledge to a corresponding neutrosophic (un-crisp) concept, since in our world more things are indeterminate or partially indeterminate than completely determinate.

2. Neutrosophic Triplets

Firstly, let's define the neutrosophic triplets.

Let A be an item (concept, notion, idea, sentence, theory etc.) and $\text{anti}A$ its opposite. In between the opposites A and $\text{anti}A$, there is a neutral (or indeterminacy) part, denoted by $\text{neut}A$.

The $\text{neut}A$ is neither A nor $\text{anti}A$,

or sometimes the $\text{neut}A$ is a mixture of partial A and partial $\text{anti}A$.

Of course, we consider the neutrosophic triplets (A , $\text{neut}A$, $\text{anti}A$) that make sense in the world, and there are plenty of such triplets in our every day life [1].

3. Examples of Neutrosophic Triplets

- (Friend, Neutral, Enemy)
- (Positive, Zero, Negative)
- (Male, Transgender, Female)
- (Win, Tie-game, Lose)
- (Small, Medium, Tall)
- (True, Partially-true & Partially-false, False)
- (True, Indeterminacy, False)
- (Membership, Partially-membership & Partially-nonmembership, Nonmembership)
- (White, Red, Black), etc.

4. Neutrosophic Definition of Indeterminacy

In neutrosophy, which is a new branch of philosophy, we interpret Indeterminacy in the broadest possible sense, i.e.

Indeterminacy, denoted by $\text{neut}A$,

is everything that is in between the opposites A and $\text{anti}A$.

Instead of this general neutrosophic triplet (A , $\text{neut}A$, $\text{anti}A$), the neutrosophic community has been mostly using the neutrosophic triplet (T, I, F),

where in a broad sense: T = truth (or membership), I = indeterminacy (unclear, unknown, vague, uncertain, imprecise, etc.), F = falsehood (or nonmembership), with T, I, F as subsets of the interval $[0, 1]$.

The word Indeterminacy is a generic name for $\text{neut}A$ (or the letter "I"). It should not be taken literally (in a narrow sense) as in a lexical dictionary (such as Webster, Larousse, etc.).

Indeterminacy depends on each application, or problem to solve, and on the experts. That's why there are many types of Indeterminacies.

In general, Indeterminacy I is not the complement of T and F, since the neutrosophic components T, I, F are independent from each other.

As a middle side, $\text{neut}A$ is neither A nor $\text{anti}A$, but in between them, or sometimes, a combination of them.

5. Examples of Indeterminacies

For the neutrosophic triplet (Friend, Neutral, Enemy), the Indeterminacy = Neutral (i.e. neither Friend nor Enemy).

For the neutrosophic triplet (Positive, Zero, Negative), the Indeterminacy = Zero.

For the neutrosophic triplet (Proton, Neutron, Electron), the Indeterminacy = Neutron.

For the neutrosophic triplet (Positron, Antineutron, Antiproton), the Indeterminacy = Antineutron.

For the neutrosophic triplet (Matter, Unmatter, Antimatter), the Indeterminacy = Unmatter (Unmatter is formed by combinations of matter and antimatter that bound together, or by long-range mixture of matter and antimatter forming a weakly-coupled phase) [12].

For the neutrosophic triplet (Male, Transgender, Female), the Indeterminacy = Transgender (a person whose gender is unclear, indeterminate).

For the neutrosophic triplet (Win, Tie-game, Lose), the Indeterminacy = Tie-game.

For the neutrosophic triplet (Small, Medium, Tall), the Indeterminacy = Medium.

For the neutrosophic triplet (True, Partially-true & Partially-false, False), the Indeterminacy = Partially-true & Partially-false (a combination of the opposites).

For the neutrosophic triplet (True, Indeterminacy, False), the Indeterminacy = Indeterminacy.

For the neutrosophic triplet (Membership, Partially-membership & Partially-nonmembership, Nonmembership), the Indeterminacy = Partially-membership & Partially-nonmembership (a combination of the opposites).

For the neutrosophic triplet (Cause, Neither Cause Nor Effect, Effect), the Indeterminacy = Neither Cause Nor Effect.

For the neutrosophic triplet (White, Red, Black), the Indeterminacy = Red.

In Fuzzy Set and Logic, T = the truth (or membership), while $F = 1 - T$ = the falsehood (or nonmembership), while $I = 0$ is the indeterminacy.

In Intuitionistic Fuzzy Set and Logic, T = the truth (or membership), F = the falsehood (or nonmembership), and the indeterminacy is called hesitancy $H = 1 - T - F$.

In Picture Fuzzy Set and Logic, T = the truth (or membership), F = the falsehood (or nonmembership), and the indeterminacy (I) was split/refined into N = neutrality (or the first subindeterminacy I_1), and the hesitancy $H = 1 - T - F - N$ (or the second subindeterminacy I_2). Therefore: $T, I_1 = N, I_2 = H, F$. Picture Fuzzy Set and Logic (also called Inconsistent Intuitionistic Fuzzy Set and Logic, or Ternary Fuzzy Set and Logic) are particular cases of Refined Neutrosophic Set and respectively Logic (where T is split/refined into T_1, T_2, \dots, T_p ; I is split/refined into I_1, I_2, \dots, I_r ; and F is split/refined into F_1, F_2, \dots, F_s ; with integers $p, r, s \geq 0$ and at least one of p, r, s is ≥ 2 ; if some T_0, I_0, F_0 occur, it is discarded) [3].

Similarly for other fuzzy extension sets and logics {such as: Pythagorean Fuzzy Set and Logic (also called Atanassov's Intuitionistic Fuzzy Set and Logic of second type), q-Rung Orthopair Fuzzy Set and Logic, Fermatean Fuzzy Set and

Logic, also Spherical Fuzzy Set and Logic, n-HyperSpherical Fuzzy Set and Logic, etc.} [13]. They have either two components (T and F) or three (T, I, and F), but with the restrictions that $0 \leq T + F \leq 1$ where what's left $1 - T - F$ is indeterminacy, and respectively $0 \leq T + I + F \leq 1$ where what's left $1 - T - I - F$ is indeterminacy too.

6. Refined Indeterminacy [3]

In between the opposite A White and $\text{anti}A$ Black, there is a whole spectrum of colors. In this case, the Indeterminacy $\text{neut}A$ is split into many Subindeterminacies: $\text{neut}A_1, \text{neut}A_2, \dots, \text{neut}A_n$, for $n \geq 2$. We have the following I-refined neutrosophic triplet (where I-refined means refinement with respect to Indeterminacy): $(A; \text{neut}A_1, \text{neut}A_2, \dots, \text{neut}A_n; \text{anti}A)$.

Therefore, the (total) Indeterminacy is the union (\cup) of all Subindeterminacies:

$$\text{neut}A = \text{neut}A_1 \cup \text{neut}A_2 \cup \dots \cup \text{neut}A_n .$$

7. Example of Refined Indeterminacy

For the I-refined neutrosophic triplet (White; Yellow, Pink, Red, Blue, Violet; Black), the Indeterminacy $\text{neut}A = \text{Yellow} \cup \text{Pink} \cup \text{Red} \cup \text{Blue} \cup \text{Violet}$.

And the subindeterminacies are: $\text{neut}A_1 = \text{Yellow}$, $\text{neut}A_2 = \text{Pink}$, $\text{neut}A_3 = \text{Red}$, $\text{neut}A_4 = \text{Blue}$, and $\text{neut}A_5 = \text{Violet}$.

There also is possible to have an infinite I-refined neutrosophic triplet by considering the infinite color spectrum between White and Black.

8. The Neutrosophic Logic Triplet [1]

The Neutrosophic Logic (NL) truth-value of a proposition P is:

$\text{NL}(P) = (T, I, F)$, where T the degree of truth of the proposition P;

I the indeterminate-degree of the proposition P to be true or false;

F the degree of falsehood of the proposition P;

or T truth, I indeterminacy, F falsehood. We prefer to use these descriptive notations T, I, F all over for the neutrosophic components.

9. The Neutrosophic Set Triplet

The Neutrosophic Set (NS) membership-value of an element x with respect to a give set M is:

$$\text{NS}(x) = (T, I, F),$$

where

T the degree of membership of the element x with respect to the set M;

I the indeterminate-degree of membership or nonmembership of the element x with respect to the set M;

F the degree of nonmembership of the element x with respect to the set M ;

or T membership, I indeterminacy, F nonmembership.

10. The Neutrosophic Probability Triplet [4]

The Neutrosophic Probability (NP) of an event A to occur is:

$NP(A) = (ch(A), ch(neutA), ch(antiA))$, where:

$ch(A)$ the chance that the event A occurs;

$ch(neutA)$ the indeterminate-chance (not sure, not clear) that the event A occurs or not;

$ch(antiA)$ the chance that the event A does not occur.

In this case, the Indeterminacy = $ch(neutA)$.

11. Indeterminacy in Neutrosophic Statistics [5, 6]

While the Classical Statistics deals with determinate data, determinate probability distributions, and determinate inference methods only, the Neutrosophic Statistics may deals with indeterminate data {i.e. data that has some degree of indeterminacy (unclear, vague, partially unknown, contradictory, incomplete, etc.)}, indeterminate probability distributions, and indeterminate inference methods {i.e. distributions and inferences that contain some degrees of indeterminacy as well (for example, instead of crisp arguments and values for the probability distributions and inference methods, charts, diagrams, algorithms, functions etc. one may deal with inexact or ambiguous arguments and values)}.

For example:

- The sample's size or population's size are not exactly known (for example, the size may be between 200 – 250 individuals).
- Not all individuals may belong 100% to the sample or populations, some may only partially belong (their degree of belongingness $T \neq 1$), others may over-belonging (their degree of belongingness $T > 1$).

An application:

Upon their work for a factory, John belongs 100%, George 50% (he's a part-timer), and Mary 110% (because she works overtime). John is 40 years old, George 60, and Mary 20. What is the age average of this company's workers?

In the classical statistics, where the degree of belongingness to the factory does not count, the age average is simply: $(40 + 60 + 20) / 3 = 40$.

In neutrosophic statistics, where the degree of belongingness does count, one has:

$(40 \cdot 1 + 60 \cdot 0.5 + 20 \cdot 1.1) / (1 + 0.5 + 1.1) = 92 / 2.6 = 35.38$.

{In classical statistics, the degree of belongingness was considered $T = 1$ for all workers: but the age average $(40 \cdot 1 + 60 \cdot 1 + 20 \cdot 1) / (1+1+1) = 120 / 3 = 40$ is inaccurate, since George's work of only 50 cannot be the same as Mary's of 110% .}

- The distribution probability curves may not be crisp or exactly known (as in classical statistics), but indeterminate functions (with approximations, or vague and conflicting information), or they may be represented by thick functions (the area between two curves).

12. When Indeterminacy = 0

Let T, I, F belonging to the interval [0, 1] be the neutrosophic components. If Indeterminacy I = 0, the neutrosophic components (T, 0, F) are still more flexible and more general than fuzzy components and intuitionistic fuzzy components. Because, we get:

- for the fuzzy set and the intuitionistic fuzzy set (they coincide):
 $T + F = 1$.

- while for the neutrosophic set:

$$0 \leq T + F \leq 2,$$

whence we may have any of these situations:

$T + F = 2$ (for incomplete information);

$T + F = 2$ (for complete information);

$T + F = 2$ (for paraconsistent / conflicting information, coming from independent sources).

Therefore, the neutrosophic set is more flexible and more general than the other sets, no matter the value of indeterminacy.

13. Classification of Indeterminacies

Since there are many types of indeterminacies, it is possible to define many types of neutrosophic measures in any field of knowledge.

And, in general, because of dealing with lots of types of indeterminacies, we can extend any classical scientific or cultural concept from various indeterminate/neutrosophic viewpoints.

(i) There is the Numerical Indeterminacy, as part of the numerical neutrosophic triplet (T, I, F), when I is a numerical subset (interval, hesitant subset, single-valued number, etc.) of [0, 1], and it is used in neutrosophic set, neutrosophic logic, and neutrosophic probability.

(ii) And the Literal Indeterminacy, where $I \subseteq [0, 1]$, with I just a letter [7], used in neutrosophic algebraic structures (such as: neutrosophic group, neutrosophic ring, neutrosophic vector space, etc.) that are built on the sets of the form:

$$S = \{a + bI, \text{ with } I \subseteq [0, 1], \text{ and } a, b \text{ in } M\}, \text{ where } M \text{ is a given real or complex set.}$$

The Literal Indeterminacy (I) is also used in neutrosophic calculus and in some neutrosophic graphs and neutrosophic cognitive maps, when the edge between two vertexes is unknown and it is denoted by a dotted line (meaning indeterminate edge).

(iii) TransIndeterminacies, inspired from the transreal numbers [11], some of which are:

(a) Infinite Indeterminacy (denoted by ∞_I)

$$I^\infty = \lim_{n \rightarrow \infty} I^n = \infty_I$$

$$\frac{I}{0} = \lim_{x \rightarrow 0} \frac{I}{x} = \infty_I$$

$$I \cdot \infty = \infty \cdot I = \lim_{x \rightarrow \infty} (n \cdot I) = \infty_I$$

(b) Null Indeterminacy (denoted by ϕ_I)

$$\frac{I}{\infty} = \lim_{x \rightarrow \infty} \frac{I}{x} = \phi_I$$

$$I^{-\infty} = \frac{1}{I^\infty} = \lim_{n \rightarrow \infty} \frac{1}{I^n} = \frac{1}{\infty_I} = \phi_I$$

(iv) Also, the Neutrosophic Number, $N = d + e \cdot I$, where a and b are real or complex numbers introduced in [7], and they were interpreted as $N = d + e \cdot I$, where d is the determinate part of the number N , and $e \cdot I$ is the indeterminate part of the number N in [5].

There are transcendental, irrational etc. numbers that are not well known, they are only partially known and partially unknown, and they have infinitely many decimals. Not even the most modern supercomputers can compute more than a few thousands decimals, but the infinitely many left decimals still remain unknown. Therefore, such numbers are very little known (because only a finite number of decimals are known), and infinitely unknown (because an infinite number of decimals are unknown).

Let's take $\sqrt{3} = 1.7320508\dots$, then an easy example of neutrosophic number capturing (3) is:

$N = a + b \cdot I = 1.732 + 4 [0.000010, 0.000015] = [1.73204, 1.73206]$, where of course $a = 1.732$, $b = 4$, and $I = [0.000010, 0.000015]$.

The way of choosing the parameters a, b, I depends on the needed accuracy of the neutrosophic number N , on the problem to solve, and on the experts.

The neutrosophic number is used in neutrosophic statistics, and in neutrosophic precalculus [8].

(v) In the Quadruple Neutrosophic Number, which has the form $QN = a + b \cdot T + c \cdot I + d \cdot F$, where the known part of QN is a ,

and the unknown part of QN is $b \cdot T + c \cdot I + d \cdot F$,

then the unknown part is split into three subparts:

degree of confidence (T),

degree of indeterminacy between confidence-nonconfidence (I),

and degree of nonconfidence (F).

QN is a four-dimensional vector that can also be written as: $QN = (a, b, c, d)$.

T, I, F are herein literal parameters. The multiplication amongst these literal parameters uses the absorbance (prevalence) law, i.e. one parameter absorbs (includes) another (see [9]).

But in specific applications T, I, F may be numerical too (in general, subsets of $[0, 1]$).

(vi) The Over-/Under-/Off-Indeterminacy

For OverIndeterminacy we have $I = 1$ within the frame of Neutrosophic Overset;

for UnderIndeterminacy we have $I = 0$ within the Neutrosophic Underset;

and in general for OffIndeterminacy we have sometimes $I = 1$ and other times $I = 0$ within the frame of neutrosophic Offset.

For your information, there are cases when the degrees of membership, indeterminacy or nonmembership may be each of them $= 1$ or $= 0$, and these are happening in our real life applications (see [10, 11]).

Conclusion

We have presented the broad definition of Indeterminacy, then listed various types of indeterminacies used in neutrosophic set / logic / probability / statistics / measure / precalculus / calculus / algebraic structures, accompanied by applications in our every day life. Indeterminacy is the main distinction between neutrosophic theories and other theories.

References

- [1] F. Smarandache, Neutrosophy. Neutrosophic Probability, Set, and Logic, ProQuest Information & Learning, Ann Arbor, Michigan, USA, 105 p., 1998; <http://fs.unm.edu/eBook-Neutrosophics6.pdf>
- [2] F. Smarandache, Neutrosophic Quadruple Numbers, Refined Neutrosophic Quadruple Numbers, Absorbance Law, and the Multiplication of Neutrosophic Quadruple Numbers, Ch. 7, pp. 186-193, Chapters in his book: Symbolic Neutrosophic Logic, Europa Nova, Brussels, 194 p., 2015; <http://fs.unm.edu/SymbolicNeutrosophicTheory.pdf>
- [3] F. Smarandache, n-Valued Refined Neutrosophic Logic and Its Applications in Physics, Progress in Physics, 143-146, Vol. 4, 2013; <http://fs.unm.edu/n-ValuedNeutrosophicLogic-PiP.pdf>
- [4] F. Smarandache, Introduction to Neutrosophic Measure, Neutrosophic Integral, and Neutrosophic Probability, Sitech & Educational, Craiova, Columbus, 140 p., 2013; <https://arxiv.org/ftp/arxiv/papers/1311/1311.7139.pdf>
- [5] F. Smarandache: Introduction to Neutrosophic Statistics, Sitech & Education Publishing, 2014, 124 p.; <http://fs.unm.edu/NeutrosophicStatistics.pdf>
- [6] J. Kaplan, Neutrosophic Statistics is a generalization of Classical Statistics, Open Library, San Francisco, USA, https://archive.org/details/neutrosophic-statistics?tab_about
https://archive.org/details/neutrosophic-statistics?tab_collection
- [7] W. B. Vasantha Kandasamy, F. Smarandache, Fuzzy Cognitive Maps and Neutrosophic Cognitive Maps, Xiquan, Phoenix, 211 p., 2003, <http://fs.unm.edu/NCMs.pdf>
- [8] F. Smarandache, Neutrosophic Precalculus and Neutrosophic Calculus, EdituraNova, Belgium, 2015, <http://fs.unm.edu/NeutrosophicPrecalculusCalculus.pdf>
- [9] F. Smarandache, Neutrosophic Overset, Neutrosophic Underset, and Neutrosophic Offset. Similarly for Neutrosophic Over-/Under-/Off- Logic, Probability, and Statistics, 168 p., Pons Editions, Brussels, Belgium, 2016, <http://fs.unm.edu/NeutrosophicOversetUndersetOffset.pdf>,
on Cornell University's website: <https://arxiv.org/ftp/arxiv/papers/1607/1607.00234.pdf>
and in France at the HAL international scientific database: <https://hal.archives-ouvertes.fr/hal-01340830>
- [10] N. Martin, Priya. R, F. Smarandache: Decision Making on Teachers' adaptation to Cybergogy in Saturated Interval-valued Refined Neutrosophic overset /underset /offset Environment, International Journal of Neutrosophic Science (IJNS), Volume 12, Issue 2, pp. 58-70, 2020; DOI: 10.5281/zenodo.4268284
- [11] Tiago S. dos Reis, Walter Gomide, James A.D.W. Anderson, Construction of Transreal Numbers and Algebraic Transfields, IAENG International Journal of Applied Mathematics, 46:1, IJAM_46_1_03, Advance Online Publication: 15 February 2016.

[12] F. Smarandache, Matter, Antimatter, and Unmatter, CERN - The European Organization for Nuclear Research, Geneva, Switzerland, 01 Jun 1980, <http://cdsweb.cern.ch/record/798551>

[13] F. Smarandache, Neutrosophic Set is a Generalization of Intuitionistic Fuzzy Set, Inconsistent Intuitionistic Fuzzy Set (Picture Fuzzy Set, Ternary Fuzzy Set), Pythagorean Fuzzy Set (Atanassov's Intuitionistic Fuzzy Set of second type), q-Rung Orthopair Fuzzy Set, Spherical Fuzzy Set, and n-HyperSpherical Fuzzy Set, while Neutrosophication is a Generalization of Regret Theory, Grey System Theory, and Three-Ways Decision, Journal of New Theory 29 pp. 01-35,2019; also in arXiv, Cornell University, New York City, NY, USA, pp. 1-50, 17-29 November 2019, <https://arxiv.org/ftp/arxiv/papers/1911/1911.07333.pdf>; and in The University of New Mexico, Albuquerque, USA, Digital Repository, https://digitalrepository.unm.edu/math_fsp/21.

Neutrosophical fuzzy modeling and optimization approach for multiobjective four-index transportation problem

Firoz Ahmad, Florentin Smarandache, Arup Kumar Das

Firoz Ahmad, Florentin Smarandache, Arup Kumar Das (2022). Neutrosophical fuzzy modeling and optimization approach for multiobjective four-index transportation problem. *Indian Statistical Institute*, 31

Abstract

This study investigates a four-index multiobjective transportation problem (F-IMOTPs) with uncertain supply and demand coverage. Different echelons having uncertain parameters' values are considered. An inter-connected multi-product F-IMOTPs is assumed for the smooth flow of items, enhancing supply chain reliability under uncertainty. A mixed-integer multiobjective programming problem that minimizes total transportation costs, time, safety costs, and carbon emissions abatement is depicted under an intuitionistic fuzzy environment. Further, three different interactive approaches, namely extended fuzzy programming approach (EFPA), extended intuitionistic fuzzy programming approach (EIFPA), and extended neutrosophic programming approach (ENPA), are developed to solve the proposed F-IMOTPs model. Different membership functions elicit each objective's marginal evaluation. The proposed F-IMOTPs model is implemented in a logistic company and solved using three interactive approaches that reveal the proposed methods' validity and applicability. An ample opportunity to generate the compromise solution is suggested by tuning various weight parameters. The outcomes are evaluated with practical managerial implications based on the significant findings. Finally, conclusions and future research scope are addressed based on the proposed work. The discussed F-IMOTPs model can be merged with and extended by considering inventory and supply chain facilities, which are not included in this study. Uncertainty among parameters due to randomness can be incorporated and tackled with historical data. Besides the proposed conventional solution methods, various metaheuristic approaches may be applied to solve the proposed F-IMOTPs model as a future research scope. The strategy advised is to provide an opportunity to create valuable decision-making policies within India by helping existing transportation networks, safety features, and imports only if necessary to meet timelines. The reduction in carbon emissions abatement also ensures less burden on environmental impacts. Thus, any logistics/transportation company or organization can adopt the distribution management initiatives amongst the supply and demand points to strengthen and enable the company to handle the uncertainties. Finally, managers or policy-makers can take advantage of the current study and extract fruitful information and knowledge regarding the optimal distribution strategies while making decisions. This research work manifests the supply-demand oriented extension of the integrated F-IMOTPs model design with minimum total transportation costs, time, safety costs, and carbon emissions abatement under flexible uncertainty. The practical managerial implications are explored that immensely support the managers or practitioners to adopt the distribution policies for the PIs to ensure sustainability in the designed F-IMOTPs model.

Keywords: Intuitionistic fuzzy parameters; Conventional optimization methods; Neutrosophic set theory; Multiobjective transportation problem.

1 Introduction

Transportation problem is a special case of linear programming problem. The objective is to determine the amount that should be transported from each source to each destination, so that the total transportation cost is minimized. It consists with a linear objective function and linear constraints. In this article we consider to model multiobjective transportation problem using fuzzy set theory. We face many situations where more than one conflicting/non-conflicting objectives are to be optimized under a set of well-defined constraints. In optimization theory, this class of problems is known as multiobjective programming problems (MOPP) and identified as an important class of optimization problem. Because of the presence of multiple objective functions, the problems become harder to obtain a single solution that satisfies each objective function efficiently. Instead, attempts are taking to obtain the compromised solution sets which satisfy each objective function marginally. A multiobjective optimization problem (MOOP) refers to obtain a solution $x \in G \subset R^E$ which minimizes an objective function vector $f : G \rightarrow R^H$ such that G denotes the E -dimensional solution space, and R^H represents the H -dimensional objective space. Most commonly, the sole target of MOOPs is to determine a set of non-dominated solution which attains the approximates of Pareto front in the same objective spaces. Mathematically, MOOPs can be expressed as follows:

$$\begin{aligned} \text{Min}_{\zeta \in R^n} F(\zeta) &= [f_1(\zeta), f_2(\zeta), \dots, f_m(\zeta)] \in R^m \\ \text{Subject to} & \\ p(\zeta) &\leq 0 \\ q(\zeta) &= 0 \\ \zeta_{ri} &\leq \zeta_i \leq \zeta_{si}, \quad i = [1, 2, \dots, n] \end{aligned} \tag{1}$$

where $\zeta = [\zeta_1, \zeta_1, \dots, \zeta_n]$ is defined as the decision variables, $F(\zeta)$ is the objective vector, $p(\zeta)$ represents the inequality and $q(\zeta)$ denotes equality constraint vectors, respectively, ζ_{ri} and ζ_{si} are the lower and upper bounds in the decision space of the ζ_i variable. The solutions methods can classified into three broad categories namely classical technique, fuzzy-based solution approach, and nature-inspired algorithm. In this context we mention that vector optimization is a subclass of optimization problems with a vector-valued objective function for a given partial ordering. A multi-objective optimization problem is a special case of a vector optimization problem. The classical techniques contemplate

the use of priority information while optimizing the MOOPs. Various methods such as Weighted sum method, ϵ -Constraint method, Weighted metric method, Benson's method, Value function method and Goal programming method. The Weighted sum method is based on the working principle that the objectives are transformed into a single objective by multiplying the pre-determined weight. The ϵ -Constraint method resolves the problems that are encountered while the weighted sum method is applied. It alleviates obtaining the solution having non-convex objective spaces by solving the single objectives and keeping the objectives within a well-specified value. The weighted metric method considers the metrics such as l_p and l_∞ distance metrics are commonly used in place of the weighted sum of the objectives. Hence the weighted metric methods convert the multiple objectives into a single objective. The weighted metric method and the Bensons method are similar to each other except that the reference solution is obtained as the feasible non-Pareto optimal solution. The value function methods determine the mathematical value function $U : R^M \rightarrow R$, concerning all objectives. The validity of the value function should be over the whole feasible solution search space. The goal programming technique tries to search the pre-targeted values of one or more than one objective function at a time. When no solution attains the pre-specified target values, the task is to determine such a solution that minimizes deviations from the targets. If a solution with desired target values exists, then the task is to determine that specific solution. For more details, visit Das and Jana [17], Mohan et al. [22] etc.

The fuzzy programming approach (FPA) is basically concerned with maximizing satisfaction degree for the decision-maker(s) while dealing with multiple objectives simultaneously. In last several decades, a tremendous amount of research was presented based on the fuzzy decision set. The limitation of the fuzzy set has been examined because it cannot define the non-membership function of the element into the fuzzy set. The intuitionistic fuzzy programming approach (IFPA) is a more flexible and realistic optimization technique compared to the fuzzy technique because it deals with the membership function and the non-membership function of the element into a feasible decision set.

Therefore, an efficient algorithm is needed to solve the MOPP. The fuzzy set (FS) was initially proposed by Zadeh et al. [32], and later on, it was extensively used in multiple criteria, multiple attributes, and multiobjective decision-making problems. Afterward, Zimmermann [37] investigated the fuzzy programming technique for the multiobjective optimization problem, which was based on the membership function for the marginal evaluation of each objective function. Therefore, the fuzzy set's extension was first presented by Atanassov [15] which is based on more intuition compared to the fuzzy set and termed as the intuitionistic fuzzy set (IFS). Later on, the potential applications of IFS have been presented in many decision-making processes and emerged as useful tools while dealing with uncertainty.

Based on IFS, Angelov [14] first addressed the intuitionistic fuzzy programming approach (IFPA) for real-life decision-making problems. Peng and Yang [24] also obtained some useful results based on the Pythagorean fuzzy set for multi-attribute decision-making

problems. Peng and Selvachandran [23] addressed some well-known results and also discussed some future direction of research-based Pythagorean fuzzy set. Wan et al. [30] also presented the Pythagorean fuzzy mathematical optimization technique for multi-attribute group decision-making problem under the Pythagorean fuzzy scenario. Zhang and Xu [33] developed a new model for multiple criteria decision-making problem under Pythagorean fuzzy environment and also proposed a technique for order preference by similarity to ideal solution (TOPSIS) method to determine the degree of closeness to the ideal solution. Unlike IFS, the flexible nature of PFS would be immensely adopted for further research scope. Ye [31] presented a study on multi-attribute decision-making method with the single-valued neutrosophic hesitant fuzzy information. Zhang et al. [34] addressed a multiple criteria decision-making problem with the hesitant fuzzy information regarding the values of different parameters. Zhou and Xu [36] also presented a portfolio optimization technique under a hesitant fuzzy environment.

Alcantud and Torra [13] have proposed some decomposition theorem and extensions principle for the hesitant fuzzy set. Bharati [16] suggested a hesitant fuzzy technique to solve the multiobjective optimization problem. Faizi et al. [18] also discussed multiple criteria decision-making problems under hesitant fuzzy set theory. Lan et al. [20] extended the application of hesitant fuzzy set to hesitant preference degree in multiple attribute decision-making problem. Liu and Luo [21] also proposed a new aggregation operator based on a neutrosophic hesitant fuzzy set and applied it to multiple attribute decision making. Zhang [35] also discussed hesitant fuzzy multi-criteria decision-making problem under the unknown weight information. Akram et al. [10] suggested a novel model based on the combination of hesitant fuzzy set and N -soft set. The application of hesitant N -soft set in group decision-making problem is also presented. Alcantud and Santos-García [12] also performed a study on expanded hesitant fuzzy sets along with the application in group decision-making problems. Alcantud and Giarlotta [11] also investigated a new model for group decision-making problems with the aid of necessary and possible hesitant fuzzy sets.

Nature-inspired algorithms are categorized into three different approaches namely, aggregating functions, population-based approaches and Pareto-based methods. The aggregation functions convert all the objective functions into a single objective employing some arithmetical operations. These methods contain the linear aggregation functions, which make it trivial and not that much impressive. Often, the population-based approaches are based on the EA's population to initiates the search. A Vector Evaluated Genetic Algorithm considered the conventional example of population-based approaches. At each generation, sub-populations are generated by proportional selection. For example, if the population size is N and n is the total number of objectives, the sub-population size will be N/n . The population-based optimization method is straightforward to apply, but the main difficulty is to find the appropriate selection scheme, which is not based on Pareto-optimality. Pareto-based methods are the most popular and extensively used techniques, which are divided into two different generations. The first generation comprises the fitness sharing, niching combined with Pareto ranking, second generation with elitism.

Motivation and research contribution

The TPs are well-known in the field of continuous optimization. Various advance mathematical programming models are presented in the literature based on the different scenarios and assumptions. The best estimation of uncertain parameters is always a challenging task in TPs because it decides the optimal allocation policies of the products and determines the optimal transportation cost and other objectives defined in the model. One more essential issue arising these days is the existence of multiple objectives in the TPs. More than one commensurable and conflicting objectives are to be optimized, such as transportation time, carbon emissions, and the transportation cost that addresses TPs sustainability. Thus, we have presented the F-IMOTPs under an intuitionistic fuzzy environment. Due to incomplete, inconsistent, and inappropriate information or knowledge, the different parameters are represented by intuitionistic fuzzy numbers comprising the membership grades, covering a wide vagueness. The extended version of various conventional approaches such as EFPA, EIFPA, and ENPA is developed to solve the F-IMOTPs. The robustness of the solution approaches has been established with the help of solution results. The ample opportunity to obtain different solution sets has been introduced for decision-makers or managers by tuning the feasibility degree (λ). The selection of the best compromise solution set among multiple outcomes has been determined by the fuzzy TOPSIS ranking method. A numerical study of Indian-based transportation companies has been done along with the significant findings. The remaining portion of the article is structured as follows. In Section 2, some definitions, results and the concept regarding the intuitionistic fuzzy parameters are presented which will be used in the subsequent sections. Section 3 contains several novel modeling approaches of F-IMOTP along with the related results. The extended version of solution approaches are proposed in Section 4. In Section 5, a numerical example is presented to illustrate the proposed methods. The conclusions and future research scope are given in Section 6.

2 Preliminaries

In this section we consider some definitions, results and concepts which are used in the following sections.

Definition 1: [15] (Intuitionistic fuzzy set) Assume that there be a universal set X . Then, an intuitionistic fuzzy set (IFS) \tilde{Y} in X is defined by the ordered triplets as follows:

$$\tilde{Y} = \{x, \mu_{\tilde{Y}}(x), \nu_{\tilde{Y}}(x) \mid x \in X\}$$

where $\mu_{\tilde{Y}}(x) : X \rightarrow [0, 1]$ denotes the membership function and $\nu_{\tilde{Y}}(x) : X \rightarrow [0, 1]$ denotes the non-membership function of the element $x \in X$ into the set \tilde{Y} , respectively,

with the conditions $0 \leq \mu_{\tilde{Y}}(x) + \nu_{\tilde{Y}}(x) \leq 1$. The value of $\phi_{\tilde{Y}}(x) = 1 - \mu_{\tilde{Y}}(x) - \nu_{\tilde{Y}}(x)$, is called the degree of uncertainty of the element $x \in X$ to the IFS \tilde{Y} . If $\phi_{\tilde{Y}}(x) = 0$, an IFS changes into fuzzy set and becomes $\tilde{Y} = \{x, \mu_{\tilde{Y}}(x), 1 - \mu_{\tilde{Y}}(x) \mid x \in X\}$.

Definition 2: [5] (Intuitionistic fuzzy number) An IFS $\tilde{Y} = \{x, \mu_{\tilde{Y}}(x), \nu_{\tilde{Y}}(x) \mid x \in X\}$ is said to be an intuitionistic fuzzy number iff

1. There exists a real number $x_0 \in \mathbb{R}$ for which $\mu_{\tilde{Y}}(x) = 1$ and $\nu_{\tilde{Y}}(x) = 0$.
2. The membership function $\mu_{\tilde{Y}}(x)$ of \tilde{Y} is fuzzy convex and non-membership function $\nu_{\tilde{Y}}(x)$ of \tilde{Y} is fuzzy concave.
3. Also, $\mu_{\tilde{Y}}(x)$ is upper semi-continuous and $\nu_{\tilde{Y}}(x)$ is lower semi-continuous.
4. The support of \tilde{Y} is depicted as $(x \in \mathbb{R} : \nu_{\tilde{Y}}(x) \leq 1)$.

Definition 3: [5] (Triangular intuitionistic fuzzy number) A triangular intuitionistic fuzzy number (TrIFN) is represented by $\tilde{Y} = ((y_1, y_2, y_3); (z_1, y_2, z_3))$ where $z_1, y_1, y_2, y_3, z_3 \in \mathbb{R}$ such that $z_1 \leq y_1 \leq y_2 \leq y_3 \leq z_3$; and its membership function $\mu_{\tilde{Y}}(x)$ and non-membership function $\nu_{\tilde{Y}}(x)$ is of the form

$$\mu_{\tilde{Y}}(x) = \begin{cases} \frac{x - y_1}{y_2 - y_1}, & \text{if } y_1 < x < y_2, \\ 1, & \text{if } x = y_2, \\ \frac{y_3 - x}{y_3 - y_2}, & \text{if } y_2 < x < y_3, \\ 0, & \text{if otherwise.} \end{cases} \quad \text{and } \nu_{\tilde{Y}}(x) = \begin{cases} \frac{y_2 - x}{y_2 - z_1}, & \text{if } z_1 < x < y_2, \\ 0, & \text{if } x = y_2, \\ \frac{x - y_2}{z_3 - y_2}, & \text{if } y_2 < x < z_3, \\ 1, & \text{if otherwise.} \end{cases}$$

Definition 4: [5] Consider that a TrIFN is given by $\tilde{Y} = ((y_1, y_2, y_3); (z_1, y_2, z_3))$ where $z_1, y_1, y_2, y_3, z_3 \in \mathbb{R}$ such that $z_1 \leq y_1 \leq y_2 \leq y_3 \leq z_3$. Then the parametric form of \tilde{Y} are $u(\tau) = (\overline{u(\tau)}, \underline{u(\tau)})$ and $v(\tau) = (\overline{v(\tau)}, \underline{v(\tau)})$. Further, $u(\tau)$ and $v(\tau)$ are the parametric form of TrIFN corresponding to membership and non-membership functions such that $\overline{u(\tau)} = y_3 - \tau(y_3 - y_1)$, $\underline{u(\tau)} = y_1 - \tau(y_2 - y_1)$ and $\overline{v(\tau)} = y_2 - (1 - \tau)(y_2 - z_1)$, $\underline{v(\tau)} = y_2 + (1 - \tau)(z_3 - y_2)$ respectively. A TrIFN $\tilde{Y} = ((y_1, y_2, y_3); (z_1, y_2, z_3))$ is said to be positive TrIFN if $z_1 > 0$ and hence y_1, y_2, y_3, z_3 are all positive numbers.

Remark 1: Assume that $\tilde{Y} = ((y_1, y_2, y_3); (z_1, y_2, z_3))$ and $\tilde{W} = ((w_1, w_2, w_3); (v_1, w_2, v_3))$ are two TrIFNs. Then addition of \tilde{Y} and \tilde{W} is again a TrIFN.

$$\tilde{Y} + \tilde{W} = [(y_1 + w_1, y_2 + w_2, y_3 + w_3); (z_1 + v_1, y_2 + w_2, z_3 + v_3)]$$

Remark 2: Consider that $\tilde{Y} = ((y_1, y_2, y_3); (z_1, y_2, z_3))$ be a TrIFN and $k \in \mathbb{R}$. Then scalar multiplication of \tilde{Y} is again a TrIFN.

$$k(\tilde{Y}) = \begin{cases} (ky_1, ky_2, ky_3; kz_1, ky_2, kz_3) & k > 0 \\ (ky_3, ky_2, ky_1; kz_3, ky_2, kz_1) & k < 0 \\ (0, 0, 0; 0, 0, 0), & k = 0 \end{cases}$$

Remark 3: The two TrIFNs $\tilde{Y} = ((y_1, y_2, y_3); (z_1, y_2, z_3))$ and $\tilde{W} = ((w_1, w_2, w_3); (v_1, w_2, v_3))$ are said to be equal iff $y_1 = w_1, y_2 = w_2, y_3 = w_3; z_1 = v_1, y_2 = w_2, z_3 = v_3$.

Definition 5: [9] (Expected interval and expected value of TrIFNs) Suppose that $\tilde{Y} = ((y_1, y_2, y_3); (z_1, y_2, z_3))$ be a TrIFN and EI^μ and EI^ν depict the expected intervals for membership and non-membership functions respectively. Thus, these can be defined as follows:

$$\begin{aligned} EI^\mu(\tilde{Y}) &= \left[\int_0^1 \underline{u}(\tau) d_k \tau, \int_0^1 \overline{u}(\tau) d_k \tau \right] \\ &= \left[\int_0^1 y_3 - \tau(y_3 - y_1) d_k \tau, \int_0^1 y_1 - \tau(y_2 - y_1) d_k \tau \right] \end{aligned}$$

$$\begin{aligned} EI^\nu(\tilde{Y}) &= \left[\int_0^1 \underline{v}(\tau) d_k \tau, \int_0^1 \overline{v}(\tau) d_k \tau \right] \\ &= \left[\int_0^1 y_2 - (1 - \tau)(y_2 - z_1) d_k \tau, \int_0^1 y_2 + (1 - \tau)(z_3 - y_2) d_k \tau \right] \end{aligned}$$

Moreover, consider that $EV^\mu(\tilde{Y})$ and $EV^\nu(\tilde{Y})$ represent the expected values corresponding to membership and non-membership functions respectively. These can be depicted as follows:

$$EV^\mu(\tilde{Y}) = \frac{\int_0^1 \underline{u}(\tau) d_k \tau + \int_0^1 \overline{u}(\tau) d_k \tau}{2} = \frac{y_1 + 2y_2 + y_3}{4} \tag{2}$$

$$EV^\nu(\tilde{Y}) = \frac{\int_0^1 \underline{v}(\tau) d_k \tau + \int_0^1 \overline{v}(\tau) d_k \tau}{2} = \frac{z_1 + 2y_2 + z_3}{4} \tag{3}$$

The expected value EV of a TrIFN $\tilde{Y} = ((y_1, y_2, y_3); (z_1, y_2, z_3))$ is given as follows:

$$EV(\tilde{Y}) = \psi EV^\mu(\tilde{Y}) + (1 - \psi) EV^\nu(\tilde{Y}), \text{ where } \psi \in [0, 1]$$

Definition 6: [6] (Accuracy function) The expected value (EV) for TrIFN

$$\tilde{Y} = ((y_1, y_2, y_3); (z_1, y_2, z_3))$$

with the help of Eqs. (2) and (3) and for $\psi = 0.5$ can be represented as follows:

$$EV(\tilde{Y}) = \frac{y_1 + y_3 + 4y_2 + z_1 + z_3}{8}$$

Thus $EV(\tilde{Y})$ is also known as accuracy function of \tilde{Y} .

Theorem 1: [26] Suppose that \tilde{Y} be a TrIFN. Then for any $EV : IF(\mathbb{R}) \rightarrow \mathbb{R}$; the expected value $EV(k\tilde{A}) = kEV(\tilde{A})$ for all $k \in \mathbb{R}$.

Theorem 2: [26] Suppose that \tilde{Y} and \tilde{W} be two TrIFNs. Then the accuracy function $EV : IF(\mathbb{R}) \rightarrow \mathbb{R}$ is a linear function i.e., $EV(\tilde{Y} + k\tilde{W}) = EV(\tilde{Y}) + kEV(\tilde{W}) \forall k \in \mathbb{R}$.

Theorem 3: [26] Suppose that $\tilde{Y} = ((y_1, y_2, y_3); (z_1, y_2, z_3))$ be a TrIFN. If $z_1 = y_1, z_3 = y_3$, then $EV(\tilde{Y}) = \frac{y_1 + 2y_2 + y_3}{4}$, represents a defuzzified value of triangular fuzzy number.

Theorem 4: [26] The expected value $EV(k) = k$, where $k \in \mathbb{R}$.

Definition 7: [3] (Neutrosophic set) Suppose $x \in X$ denotes the universal discourse. A neutrosophic set (NS) A in X can be depicted by the truth $\mu_A(x)$, indeterminacy $\lambda_A(x)$ and a falsity $\nu_A(x)$ membership functions and is expressed as follows:

$$A = \{ \langle x, \mu_A(x), \lambda_A(x), \nu_A(x) \rangle \mid x \in X \}$$

where $\mu_A(x), \lambda_A(x)$ and $\nu_A(x)$ are real standard or non-standard subsets belong to $]0^-, 1^+[$, also given as, $\mu_A(x) : X \rightarrow]0^-, 1^+[$, $\lambda_A(x) : X \rightarrow]0^-, 1^+[$, and $\nu_A(x) : X \rightarrow]0^-, 1^+[$. Also, the sum of $\mu_A(x), \lambda_A(x)$ and $\nu_A(x)$ is free from all restrictions. Thus, we have

$$0^- \leq \sup \mu_A(x) + \lambda_A(x) + \sup \nu_A(x) \leq 3^+$$

Definition 8 : [3] A NS is said to be single valued neutrosophic set A if the following condition will holds:

$$A = \{ \langle x, \mu_A(x), \lambda_A(x), \nu_A(x) \rangle \mid x \in X \}$$

where $\mu_A(x), \lambda_A(x)$ and $\nu_A(x) \in [0, 1]$ and $0 \leq \mu_A(x) + \lambda_A(x) + \nu_A(x) \leq 3$ for each $x \in X$.

Definition 9: [5] The union of two single valued neutrosophic sets A and B is also a single valued neutrosophic set C , i.e., $C = (A \cup B)$ with the truth $\mu_C(x)$, indeterminacy $\lambda_C(x)$ and falsity $\nu_C(x)$ membership functions as follows:

$$\mu_C(x) = \max(\mu_A(x), \mu_B(x))$$

$$\lambda_C(x) = \max(\lambda_A(x), \lambda_B(x))$$

$$\nu_C(x) = \min (\nu_A(x), \nu_B(x))$$

for each $x \in X$.

Definition 10: [5] The intersection of two single valued neutrosophic sets A and B is also a single valued neutrosophic set C , i.e., $C = (A \cap B)$ with the truth $\mu_C(x)$, indeterminacy $\lambda_C(x)$ and falsity $\nu_C(x)$ membership functions as follows:

$$\mu_C(x) = \min (\mu_A(x), \mu_B(x))$$

$$\lambda_C(x) = \min (\lambda_A(x), \lambda_B(x))$$

$$\nu_C(x) = \max (\nu_A(x), \nu_B(x))$$

for each $x \in X$.

3 Multiobjective transportation problem

Transportation problems (TPs) are concerned with the transporting of different kinds of products from one place to another to achieve the optimal prescribed objective(s). The classical transportation model can be defined as follows:

$$Min Z = \sum_{i=1}^m \sum_{j=1}^n c_{ij} x_{ij}$$

Subject to

$$\sum_{j=1}^n x_{ij} = a_i, \quad i = 1, 2, 3, \dots, m$$

$$\sum_{i=1}^m x_{ij} = b_j, \quad j = 1, 2, 3, \dots, n$$

$$\sum_{i=1}^m a_i = \sum_{j=1}^n b_j, \quad x_{ij} \geq 0, \quad \forall i \text{ \& } j$$

Ahmad and Adhami [3] presented the multiobjective transportation model under fuzziness. The performances of the fuzzy approach are analyzed using the family of the distance function. Adhami and Ahmad [1] also solved the multiobjective transportation problem using the interactive fuzzy programming approaches. Singh and Yadav [28] represented the cost parameter with the triangular intuitionistic fuzzy number, and the ordering of fuzzy number have used to develop intuitionistic fuzzy modified distribution method with the help of accuracy function for finding the optimal solution of TPs. Singh and Yadav [27] used the ranking function to deal with all uncertain parameters and consequently proposed an intuitionistic fuzzy method to find the initial basic feasible solution of TPs. Jana [19]

solved a type-2 intuitionistic fuzzy transportation problem by the ranking function for the mean interval method by taking all the parameters type-2 intuitionistic fuzzy number. Here, we propose a new F-IMOTP with k ($= 1, 2, 3, \dots, K$) objectives which are to be optimized under each m origins having a_i ($i = 1, 2, 3, \dots, m$) units of availability and to be transported among n destinations having b_j ($j = 1, 2, 3, \dots, n$) units of demand level. The different cost associated with the k objectives is represented as c_{ijk} . A decision variable x_{ijk} is defined, which is an unknown quantity and are to be transported from i^{th} origin to j^{th} destination in such a way that the total transportation cost, labor cost, and safety cost is minimum. The useful notations are summarized in Table 1.

Table 1: Notions and descriptions

Indices	Descriptions
i	Represents the sources
j	Represents the destinations
k	Represents the conveyance
g	Represents the types of products
Decision variable	
x_{ijk}^g	Unit quantity of products
y_{ijk}^g	Binary variable such that $y_{ijk}^g = \begin{cases} 1, & x_{ijk}^g > 0 \\ 0, & x_{ijk}^g = 0 \end{cases}$
Parameters	
\tilde{c}_{ijk}^g	Unit transportation cost
\tilde{p}_k^g	Unit penalty cost
\tilde{t}_{ijk}^g	Unit transportation time
\tilde{s}_{ijk}^g	The safety factor
\tilde{sc}_{ijk}^g	Unit safety cost
\tilde{ce}_{ijk}^g	Unit carbon emissions cost
\tilde{a}_i^g	Total availability
\tilde{b}_j^g	Total demand
\tilde{e}_i^g	Total conveyance capacity
B_j	Total budget
B	Desired safety value

So, the mathematical model for F-IMOTPs can be given as follows (4):

$$\begin{aligned}
 \text{Min } \tilde{Z}_1^{IF} &= \sum_{i=1}^I \sum_{j=1}^J \sum_{k=1}^K \sum_{g=1}^G \tilde{c}_{ijk}^g x_{ijk}^g && (\text{Transportation cost}) \\
 \text{Min } \tilde{Z}_2^{IF} &= \sum_{i=1}^I \sum_{j=1}^J \sum_{k=1}^K \sum_{g=1}^G \tilde{t}_{ijk}^g y_{ijk}^g && (\text{Transportation time}) \\
 \text{Min } \tilde{Z}_3^{IF} &= \sum_{i=1}^I \sum_{j=1}^J \sum_{k=1}^K \sum_{g=1}^G \tilde{s}_{ijk}^g y_{ijk}^g && (\text{Safety cost}) \\
 \text{Min } \tilde{Z}_4^{IF} &= \sum_{i=1}^I \sum_{j=1}^J \sum_{k=1}^K \sum_{g=1}^G \tilde{p}_k^g \left(\tilde{c}e_{ijk}^g x_{ijk}^g \right) && (\text{Carbon emissions})
 \end{aligned}$$

Subject to

$$\begin{aligned}
 \sum_{i=1}^I \sum_{j=1}^J \sum_{k=1}^K \sum_{g=1}^G x_{ijk}^g &\leq \tilde{a}_i^g, && i = 1, 2, 3, \dots, m \\
 \sum_{i=1}^I \sum_{j=1}^J \sum_{k=1}^K \sum_{g=1}^G x_{ijk}^g &\geq \tilde{b}_j^g, && j = 1, 2, 3, \dots, n \\
 \sum_{i=1}^I \sum_{j=1}^J \sum_{k=1}^K \sum_{g=1}^G x_{ijk}^g &\leq \tilde{e}_i^g, && i = 1, 2, 3, \dots, m \\
 \sum_{i=1}^I \sum_{j=1}^J \sum_{k=1}^K \sum_{g=1}^G \tilde{c}_{ijk}^g x_{ijk}^g &\leq B_j, && j = 1, 2, 3, \dots, n \\
 \sum_{i=1}^I \sum_{j=1}^J \sum_{k=1}^K \sum_{g=1}^G \tilde{s}_{ijk}^g y_{ijk}^g &> B, && i = 1, 2, 3, \dots, m \\
 \sum_{i=1}^m \tilde{a}_i &\geq \sum_{j=1}^n \tilde{b}_j, && x_{ij} \geq 0, \forall i \text{ \& } j
 \end{aligned} \tag{4}$$

where notations ($\tilde{(\cdot)}$) over different parameters represents the triangular intuitionistic fuzzy number for all indices' set.

The equivalent intuitionistic fuzzy multiobjective transprotation problem (4) can be sum-

marized as follows (5):

$$\begin{aligned}
 \text{Min} \quad & \tilde{Z}^{IF}(x) = \left[\tilde{Z}_1^{IF}(x_{ijk}^g), \tilde{Z}_2^{IF}(x_{ijk}^g), \tilde{Z}_3^{IF}(x_{ijk}^g), \tilde{Z}_4^{IF}(x_{ijk}^g) \right] \\
 \text{Subject to} \quad & \sum_{j=1}^J \tilde{A}_{ij} x_{ijk}^g \geq \tilde{B}_i, \quad i = 1, 2, \dots, I_1, \\
 & \sum_{j=1}^J \tilde{A}_{ij} x_{ijk}^g \leq \tilde{B}_i, \quad i = I_1 + 1, I_1 + 2, \dots, I_2, \\
 & \sum_{j=1}^J \tilde{A}_{ij} x_{ijk}^g = \tilde{B}_i, \quad i = I_2 + 1, I_2 + 2, \dots, I. \\
 & x_{ijk}^g \geq 0, \quad j = 1, 2, \dots, J.
 \end{aligned} \tag{5}$$

where $\tilde{Z}_k^{IF}(x) = \sum_{k=1}^4 (\cdot)^{IF} x_{ijk}^g, \forall k = 1, 2, \dots, 4$ is the k -th objective function with trapezoidal intuitionistic fuzzy parameters.

With the aid of accuracy function (Theorem 1) which is linear, the intuitionistic fuzzy programming problem (IFMOPP) (5) can be converted into the following deterministic MOPP (6):

$$\begin{aligned}
 \text{Min} \quad & Z'(x_{ijk}^g) = \left[Z'_1(x_{ijk}^g), Z'_2(x_{ijk}^g), Z'_3(x_{ijk}^g), Z'_4(x_{ijk}^g) \right] \\
 \text{Subject to} \quad & \sum_{j=1}^J A'_{ij} x_{ijk}^g \geq B'_i, \quad i = 1, 2, \dots, I_1, \\
 & \sum_{j=1}^J A'_{ij} x_{ijk}^g \leq B'_i, \quad i = I_1 + 1, I_1 + 2, \dots, I_2, \\
 & \sum_{j=1}^J A'_{ij} x_{ijk}^g = B'_i, \quad i = I_2 + 1, I_2 + 2, \dots, I. \\
 & x_{ijk}^g \geq 0, \quad j = 1, 2, \dots, J.
 \end{aligned} \tag{6}$$

where $Z'_k(x_{ijk}^g) = EV \left(\tilde{Z}_k^{IF}(x_{ijk}^g) \right) = \sum_{k=1}^K EV \left(\tilde{c}_{ijk} \right) x_{ijk}^g, \forall k = 1, 2, \dots, K; B'_i = EV \left(\tilde{B}_i \right)$ and $A'_{ij} = EV \left(\tilde{A}_{ij} \right)$, for all $i = 1, 2, \dots, I, j = 1, 2, \dots, J$ are the crisp version of all the objective functions and parameters.

Of particular interest, we have proven the existence of an efficient solution of the problem (5) and the convexity property of crisp MOPP (6) in Theorems 5 and 6, respectively.

Definition 13: Assume that X be the set of feasible solution for the crisp MOPP (6). Then a point x^* is said to be an efficient or Pareto optimal solution of the crisp MOPP (6) if and only iff there does not exist any $x \in X$ such that, $O_k(x^*) \geq O_k(x), \forall k = 1, 2, \dots, 4$ and $O_k(x^*) > O_k(x)$ for all at least one $\forall k = 1, 2, \dots, 4$. Here, k is the number of objective function present in the crisp MOPP (6).

Definition 14: A point $x^* \in X$ is said to be weak Pareto optimal solution for the crisp MOPP (6) iff there does not exist any $x \in X$ such that, $O_k(x^*) \geq O_k(x), \forall k = 1, 2, \dots, 4$.

We prove the following theorem to establish the existence of efficient solution which has one-one correspondence between MOPP and IFMOPP.

Theorem 5: An efficient solution of the crisp MOPP (6) is also an efficient solution for the IFMOPP (5).

Proof: Consider that $x \in X$ be an efficient solution of the crisp MOPP (6). Then X is also feasible for the crisp MOPP (6). It means that the following condition will hold:

$$\begin{aligned} \sum_{j=1}^J A'_{ij} x_{ijk}^g &\geq B'_i, \quad i = 1, 2, \dots, I_1, \\ \sum_{j=1}^J A'_{ij} x_{ijk}^g &\leq B'_i, \quad i = I_1 + 1, I_1 + 2, \dots, I_2, \\ \sum_{j=1}^J A'_{ij} x_{ijk}^g &= B'_i, \quad i = I_2 + 1, I_2 + 2, \dots, I, \\ x_{ijk}^g &\geq 0, \quad j = 1, 2, \dots, J. \end{aligned}$$

Since it is proven that EV is a linear function (Theorem 2), we have

$$\begin{aligned} \sum_{j=1}^J EV \left(\tilde{A}_{ij} \right) x_{ijk}^g &\geq EV \left(\tilde{B}_i \right), \quad i = 1, 2, \dots, I_1, \\ \sum_{j=1}^J EV \left(\tilde{A}_{ij} \right) x_{ijk}^g &\leq EV \left(\tilde{B}_i \right), \quad i = I_1 + 1, I_1 + 2, \dots, I_2, \\ \sum_{j=1}^J EV \left(\tilde{A}_{ij} \right) x_{ijk}^g &= EV \left(\tilde{B}_i \right), \quad i = I_2 + 1, I_2 + 2, \dots, I, \\ x_j &\geq 0, \quad j = 1, 2, \dots, J. \end{aligned}$$

Consequently, we have

$$\begin{aligned} \sum_{j=1}^J \tilde{A}_{ij} x_{ijk}^g &\leq \tilde{B}_i, \quad i = I_1 + 1, I_1 + 2, \dots, I_2, \\ \sum_{j=1}^J \tilde{A}_{ij} x_{ijk}^g &= \tilde{B}_i, \quad i = I_2 + 1, I_2 + 2, \dots, I, \\ x_{ijk}^g &\geq 0, \quad j = 1, 2, \dots, J. \end{aligned}$$

Hence, X is a feasible solution for the IFMOPP (5).

Moreover, since X is an efficient solution for the crisp MOPP (6), there does not exist any $X^* = (x_1^*, x_2^*, \dots, x_n^*)$ such that $Z_k(X^*) \leq Z_k(X) \forall k = 1, 2, \dots, 4$ and $Z_k(X^*) < Z_k(X)$

for at least one $k = 1, 2, \dots, 4$. Thus we have no X^* such that $\text{Min} \sum_{k=1}^K EV \left(\tilde{Z}_k(X) \right) \leq \text{Min} \sum_{k=1}^K EV \left(\tilde{Z}_k(X^*) \right) \forall k = 1, 2, \dots, 4$ and $\text{Min} \sum_{k=1}^K EV \left(\tilde{Z}_k(X) \right) < \text{Min} \sum_{k=1}^K EV \left(\tilde{Z}_k(X^*) \right) \forall k = 1, 2, \dots, 4$ for at least one $k = 1, 2, \dots, 4$.

Since EV is a linear function (Theorem 2), we have no X^* such that $\text{Min} \sum_{k=1}^K EV \left(\tilde{Z}_k(X) \right) \leq \text{Min} \sum_{k=1}^K EV \left(\tilde{Z}_k(X^*) \right) \forall k = 1, 2, \dots, 4$ and $\text{Min} \sum_{k=1}^K EV \left(\tilde{Z}_k(X) \right) < \text{Min} \sum_{k=1}^K EV \left(\tilde{Z}_k(X^*) \right) \forall k = 1, 2, \dots, 4$ for at least one $k = 1, 2, \dots, 4$. Thus X is an efficient solution for the IFMOPP (5). ■

We propose the following model which is equivalent the crisp MOPP.

Let Z_1 and Z_2 be comonotonic functions, then for any intuitionistic fuzzy parameter \tilde{Y} , we have

$$EV \left[Z_1(\tilde{Y}) + Z_2(\tilde{Y}) \right] = EV \left[Z_1(\tilde{Y}) \right] + EV \left[Z_2(\tilde{Y}) \right]$$

For the sake of simplicity, let us consider an auxiliary model (7) which is an equivalent to the crisp MOPP (6) and can be given as follows:

$$\text{Min} \quad EV \left[Z(X, \tilde{Y}) \right] = \left(EV \left[Z_1(X, \tilde{Y}) \right], \dots, EV \left[Z_k(X, \tilde{Y}) \right] \right) \quad \forall k = 1, 2, 3, 4.$$

Subject to

$$\begin{aligned} \sum_{j=1}^J A'_{ij} x_{ijk}^g &\geq B'_i, \quad i = 1, 2, \dots, I_1, \\ \sum_{j=1}^J A'_{ij} x_{ijk}^g &\leq B'_i, \quad i = I_1 + 1, I_1 + 2, \dots, I_2, \\ \sum_{j=1}^J A'_{ij} x_{ijk}^g &= B'_i, \quad i = I_2 + 1, I_2 + 2, \dots, I. \\ x_{ijk}^g &\geq 0, \quad j = 1, 2, \dots, J. \end{aligned}$$

(7)

Where $EV[\cdot]$ in auxiliary model (7) represents the expected values (accuracy function) of the intuitionistic fuzzy parameters.

In Theorem 5, we have already proven the expected value EV efficient solution for the IFMOPP (5). This concept is obtained by presenting the crisp MOPP (6), which comprise the expected value of intuitionistic fuzzy uncertain objectives of the IFMOPP (5).

Intuitively, if the intuitionistic fuzzy uncertain vectors in the auxiliary model (7) degenerate into intuitionistic fuzzy parameters, then the following convexity Theorem 6 of the auxiliary model (7) can be proved.

Theorem 6: Suppose that the function $Z(X, \tilde{Y})$ is differentiable and a convex vector function with respect to X and \tilde{Y} . Thus, for any given $X_1, X_2 \in X$, if $Z_k(X_1, \tilde{Y})$ and $Z_k(X_2, \tilde{Y})$ are comonotonic on intuitionistic fuzzy parameters \tilde{Y} , then the auxiliary model (7) is a convex programming problem.

Proof: Since, the feasible solution set X is a convex set, intuitively, it is sufficient to obtain that the auxiliary model (7) is a convex vector function.

Note that the $Z(X, \tilde{Y})$ is a convex vector function on X for any given \tilde{Y} , the inequality

$$Z \left(\delta X_1 + (1 - \delta) X_2, \tilde{Y} \right) \leq \delta Z(X_1, \tilde{Y}) + (1 - \delta) Z(X_2, \tilde{Y})$$

holds for any $\delta \in [0, 1]$ and $X_1, X_2 \in X$, i.e;

$$Z_k \left(\delta X_1 + (1 - \delta) X_2, \tilde{Y} \right) \leq \delta Z_k(X_1, \tilde{Y}) + (1 - \delta) Z_k(X_2, \tilde{Y})$$

holds for each $k, 1 \leq k \leq 4$.

By using the assumed condition that $Z_k(X_1, \tilde{Y})$ and $Z_k(X_2, \tilde{Y})$ are comonotonic on \tilde{Y} , it follows from Definition 13 that

$$EV \left[Z_k \left(\delta X_1 + (1 - \delta) X_2, \tilde{Y} \right) \right] \leq \delta EV \left[Z_k(X_1, \tilde{Y}) \right] + (1 - \delta) EV \left[Z_k(X_2, \tilde{Y}) \right], \forall k;$$

which implies that

$$EV \left[Z \left(\delta X_1 + (1 - \delta) X_2, \tilde{Y} \right) \right] \leq \delta EV \left[Z(X_1, \tilde{Y}) \right] + (1 - \delta) EV \left[Z(X_2, \tilde{Y}) \right]$$

The above inequality shows that $EV \left[Z(X, \tilde{Y}) \right]$ is a convex vector function. Hence the auxiliary model (7) is a convex programming problem. Consequently, the crisp MOPP (6) is also a convex programming problem. Thus Theorem 6 is proved. ■

4 Solution approach

4.1 Extended Fuzzy Programming Approach

Based on fuzzy set theory [37], fuzzy programming is developed to solve the multiobjective optimization problem. The fuzzy programming approach (FPA) deals with the degree of belongingness (membership function) lying between 0 to 1. It shows the marginal evaluation of each objective function into the feasible solution sets. The membership functions can be defined by a mapping function (say $\mu(Z_k) \rightarrow [0, 1] | \lambda \in [0, 1]$) that assigned the values between 0 to 1 to each objective function which shows the decision makers' preferences have been fulfilled up to λ level of satisfaction. Mathematically, it can be expressed as follows:

$$\mu(Z_k(x)) = \begin{cases} 1 & \text{if } Z_k(x) < L_k \\ \frac{U_k - Z_k(x)}{U_k - L_k} & \text{if } L_k \leq Z_k(x) \leq U_k \\ 0 & \text{if } Z_k(x) > U_k \end{cases}$$

where U_k and L_k are the lower and upper bound for each objective function and obtained by the minimization and maximization of each objective function individually.

Hence, the mathematical formulation of EFPA to solve the transportation problem can be represented as below:

$$\begin{aligned} \text{Max } \psi(x) &= \lambda(\alpha) + (1 - \lambda) \left(\sum_{k=1}^4 \mu_k(Z_k(x)) \right) \\ \text{Subject to} & \\ &\mu_k(Z_k(x)) \geq \alpha, \\ &\alpha \geq 0, \quad 0 \leq \alpha \leq 1, \\ &\lambda \in [0, 1] \\ &\text{constraints (4)} \end{aligned} \tag{8}$$

where $\mu_k(Z_k(x))$ represents the membership degree of k -th objective function and α depicts the satisfaction level for each objective function and provides a compromise solution under the given set of constraints under fuzzy environment.

We prove that the unique optimal solution of LTMFA is efficient.

Theorem 7: A unique optimal solution of problem (8) (LTMFA) is also an efficient solution for the problem (5).

Proof: Suppose that $(\bar{x}, \bar{\alpha})$ be a unique optimal solution of problem (8) (LTMFA). Then, $(\bar{\alpha}) > (\alpha)$ for any (x, α) feasible to the problem (8) (LTMFA). On the contrary, assume that $(\bar{x}, \bar{\alpha},)$ is not an efficient solution of the crisp IP-TPP (8). For that, there exists $x^* (x^* \neq \bar{x})$ feasible to the crisp IP-TPP (8), such that $O_m(x^*) \leq O_m(\bar{x})$ for all $m = 1, 2, \dots, M$ and $O_m(x^*) < O_m(\bar{x})$ for at least one m .

Therefore, we have $\frac{O_m(x^*)-L_m}{U_m-L_m} \leq \frac{O_m(\bar{x})-L_m}{U_m-L_m}$ for all $m = 1, 2, \dots, M$ and $\frac{O_m(x^*)-L_m}{U_m-L_m} < \frac{O_m(\bar{x})-L_m}{U_m-L_m}$ for at least one m .

Hence, $\max_m \left(\frac{O_m(x^*)-L_m}{U_m-L_m} \right) \leq (<) \max_m \left(\frac{O_m(\bar{x})-L_m}{U_m-L_m} \right) = \bar{\alpha}$.

Assume that $\alpha^* = \min_m \left(\frac{U_m-O_m(x^*)}{U_m-L_m} \right)$, this gives $(\bar{\alpha}) < (\alpha^*)$ which means that the solution is not unique optimal. Thus, we have arrived at a contradiction with the fact that $(\bar{x}, \bar{\alpha})$ is the unique optimal solution of (LTMFA). Therefore, it is also an efficient solution for the problem (5). This completes the proof of Theorem 7. ■

4.2 Extended Intuitionistic Fuzzy Programming Approach

Based on intuitionistic fuzzy set theory [15], intuitionistic fuzzy programming is developed to solve the multiobjective optimization problem. The intuitionistic fuzzy programming approach (IFPA) deals with the degree of belongingness (membership function) and degree of non-belongingness (non-membership function) simultaneously, lying between 0 to 1. It shows the marginal evaluation of each objective function into the feasible solution sets. The membership functions can be defined by a mapping function (say $\mu(Z_k), \nu(Z_k) \rightarrow [0, 1] \mid \alpha, \beta \in [0, 1]$) that assigned the values between 0 to 1 to each objective function which shows the decision makers' preferences have been fulfilled up to $(\alpha - \beta)$ level of satisfaction. Mathematically, it can be expressed as follows:

$$\mu(Z_k(x)) = \begin{cases} 1 & \text{if } Z_k(x) < L_k \\ \frac{U_k-Z_k(x)}{U_k-L_k} & \text{if } L_k \leq Z_k(x) \leq U_k \\ 0 & \text{if } Z_k(x) > U_k \end{cases}$$

and

$$\nu(Z_k(x)) = \begin{cases} 0 & \text{if } Z_k(x) < L_k \\ \frac{Z_k(x)-L_k}{U_k-L_k} & \text{if } L_k \leq Z_k(x) \leq U_k \\ 1 & \text{if } Z_k(x) > U_k \end{cases}$$

Therefore the mathematical formulation of EIFPA to solve the transportation problem can be represented as below:

$$\begin{aligned}
 \text{Max } \psi(x) &= \lambda(\alpha - \beta) + (1 - \lambda) \sum_{k=1}^K (\mu_k(Z_k(x)) - \nu_k(Z_k(x))) \\
 \text{Subject to} & \\
 &\mu_k(Z_k(x)) \geq \alpha, \\
 &\nu_k(Z_k(x)) \leq \beta, \\
 &\alpha \geq \beta, \quad 0 \leq \alpha + \beta \leq 1, \\
 &\lambda \in [0, 1] \\
 &\text{constraints (4)}
 \end{aligned} \tag{9}$$

where $\mu_k(Z_k(x))$ and $\nu_k(Z_k(x))$ represent the satisfaction and dissatisfaction degrees of k -th objective function under intuitionistic fuzzy environment. Also, $\alpha = \min [\mu_k(Z_k(x))]$ and $\beta = \max [\nu_k(Z_k(x))]$ denote the minimum satisfaction and maximum dissatisfaction degrees of each objectives, respectively. Moreover, $(\alpha - \beta)$ represents the overall degree of satisfaction for each objective function and provides a compromise solution under the given set of constraints.

Theorem 8: A unique optimal solution of problem (9) (LTMFA) is also an efficient solution for the problem (5).

Proof: Suppose that $(\bar{x}, \bar{\alpha}, \bar{\beta})$ be a unique optimal solution of problem (9) (LTMFA). Then, $(\bar{\alpha} - \bar{\beta}) > (\alpha - \beta)$ for any (x, α, β) feasible to the problem (9) (LTMFA). On the contrary, assume that $(\bar{x}, \bar{\alpha}, \bar{\beta})$ is not an efficient solution of the crisp IP-TPP (9). For that, there exists x^* ($x^* \neq \bar{x}$) feasible to the crisp IP-TPP (9), such that $O_m(x^*) \leq O_m(\bar{x})$ for all $m = 1, 2, \dots, M$ and $O_m(x^*) < O_m(\bar{x})$ for at least one m .

Therefore, we have $\frac{O_m(x^*) - L_m}{U_m - L_m} \leq \frac{O_m(\bar{x}) - L_m}{U_m - L_m}$ for all $m = 1, 2, \dots, M$ and $\frac{O_m(x^*) - L_m}{U_m - L_m} < \frac{O_m(\bar{x}) - L_m}{U_m - L_m}$ for at least one m .

Hence, $\max_m \left(\frac{O_m(x^*) - L_m}{U_m - L_m} \right) \leq (<) \max_m \left(\frac{O_m(\bar{x}) - L_m}{U_m - L_m} \right)$.

Suppose that that $\beta^* = \max_m \left(\frac{U_m - O_m(x^*)}{U_m - L_m} \right)$, then $\beta^* \leq (<) \bar{\beta}$.

In the same manner, we have $\frac{U_m - O_m(x^*)}{U_m - L_m} \geq \frac{U_m - O_m(\bar{x})}{U_m - L_m}$ for all $m = 1, 2, \dots, M$ and $\frac{U_m - O_m(x^*)}{U_m - L_m} > \frac{U_m - O_m(\bar{x})}{U_m - L_m}$ for at least one m .

Thus, $\min_m \left(\frac{U_m - O_m(x^*)}{U_m - L_m} \right) \geq (>) \min_m \left(\frac{U_m - O_m(\bar{x})}{U_m - L_m} \right)$.

Assume that $\alpha^* = \min_m \left(\frac{U_m - O_m(x^*)}{U_m - L_m} \right)$, this gives $(\bar{\alpha} - \bar{\beta}) < (\alpha^* - \beta^*)$ which means that the solution is not unique optimal. Thus, we have arrived at a contradiction with the fact that $(\bar{x}, \bar{\alpha}, \bar{\beta})$ is the unique optimal solution of (LTMFA). Therefore, it is also an efficient solution for the problem (5). This completes the proof of Theorem 8. ■

4.3 Extended Neutrosophic Programming Approach

In reality, the characteristic of indeterminacy is the most trivial concern in the decision-making process. It seldom happens that DM(s) has(have) neutral thoughts about any specific value about membership degree of the element into feasible decision set. In this situation, indeterminacy/neutral values are possible to assign it. Inspired with such cases, Smarandache [29] proposed a set named neutrosophic set (NS), which is the extension of FS and IFS. The NS deals with an indeterminacy degree of the element into a feasible decision set. The neutrosophic programming approach (NPA) has been widely used by researchers. Ahmad et al. [4] have proposed a new computational algorithm based on a single-valued neutrosophic hesitant fuzzy decision set and applied it to the multiobjective nonlinear optimization problem of the manufacturing system. Ahmad et al. [6] and Ahmad et al. [5] have also addressed modified neutrosophic fuzzy optimization technique for multiobjective programming problem under uncertainty. For more details, please visit [2?] Thus, the upper and lower bound for each objective as given below:

$$U_k = \max[Z_k(X^k)] \text{ and } L_k = \min[Z_k(X^k)] \quad \forall k = 1, 2, 3, \dots, K.$$

The bounds for k objective function is given as follows:

$$\begin{aligned} U_k^\mu &= U_k, \quad L_k^\mu = L_k \quad \text{for truth membership} \\ U_k^\sigma &= L_k^\mu + s_k, \quad L_k^\sigma = L_k^\mu \quad \text{for indeterminacy membership} \\ U_k^\nu &= U_k^\mu, \quad L_k^\nu = L_k^\mu + t_k \quad \text{for falsity membership} \end{aligned}$$

where s_k and $t_k \in (0, 1)$ are predetermined real numbers assigned by DM(s). Hence, the different membership functions can be defined as follows:

$$\begin{aligned} \mu_k(Z_k(x)) &= \begin{cases} 1 & \text{if } Z_k(x) < L_k^\mu \\ \frac{U_k^\mu - Z_k(x)}{U_k^\mu - L_k^\mu} & \text{if } L_k^\mu \leq Z_k(x) \leq U_k^\mu \\ 0 & \text{if } Z_k(x) > U_k^\mu \end{cases} \\ \sigma_k(Z_k(x)) &= \begin{cases} 1 & \text{if } Z_k(x) < L_k^\sigma \\ \frac{U_k^\sigma - Z_k(x)}{U_k^\sigma - L_k^\sigma} & \text{if } L_k^\sigma \leq Z_k(x) \leq U_k^\sigma \\ 0 & \text{if } Z_k(x) > U_k^\sigma \end{cases} \\ \nu_k(Z_k(x)) &= \begin{cases} 1 & \text{if } Z_k(x) > U_k^\nu \\ \frac{Z_k(x) - L_k^\nu}{U_k^\nu - L_k^\nu} & \text{if } L_k^\nu \leq Z_k(x) \leq U_k^\nu \\ 0 & \text{if } Z_k(x) < L_k^\nu \end{cases} \end{aligned}$$

Therefore the mathematical formulation of ENPA to solve the transportation problem can be represented as below:

$$\begin{aligned}
 \text{Max } \psi(x) &= \lambda(\alpha - \beta - \gamma) + (1 - \lambda) \sum_{k=1}^K (\mu_k(Z_k(x)) - \lambda_k(Z_k(x)) - \nu_k(Z_k(x))) \\
 \text{Subject to:} & \\
 &\mu_k(Z_k(x)) \geq \alpha, \quad \sigma_k(Z_k(x)) \leq \beta, \quad \nu_k(Z_k(x)) \leq \gamma, \\
 &\alpha \geq \beta, \quad 0 \leq \alpha + \beta + \gamma \leq 3, \\
 &\lambda \in [0, 1] \\
 &\text{constraints (4)}
 \end{aligned} \tag{10}$$

where $(\alpha + \beta - \gamma)$ represents the overall degree of satisfaction for each objective function and provides a compromise solution under the given set of constraints.

Theorem 9: A unique optimal solution of problem (10) (LTMFA) is also an efficient solution for the problem (5).

Proof: Suppose that $(\bar{x}, \bar{\alpha}, \bar{\beta}, \bar{\gamma})$ be a unique optimal solution of problem (10) (LTMFA). Then, $(\bar{\alpha} - \bar{\beta} - \bar{\gamma}) > (\alpha - \beta - \gamma)$ for any $(x, \alpha, \beta, \gamma)$ feasible to the problem (10) (LTMFA). On the contrary, assume that $(\bar{x}, \bar{\alpha}, \bar{\beta}, \bar{\gamma})$ is not an efficient solution of the problem (10). For that, there exists $x^* (x^* \neq \bar{x})$ feasible to problem (10), such that $O_k(x^*) \leq O_k(\bar{x})$ for all $k = 1, 2, \dots, K$ and $O_k(x^*) < O_k(\bar{x})$ for at least one k .

Therefore, we have $\frac{O_k(x^*) - L_k}{U_k - L_k} \leq \frac{O_k(\bar{x}) - L_k}{U_k - L_k}$ for all $k = 1, 2, \dots, K$ and $\frac{O_k(x^*) - L_k}{U_k - L_k} < \frac{O_k(\bar{x}) - L_k}{U_k - L_k}$ for at least one k .

$$\text{Hence, } \max_k \left(\frac{O_k(x^*) - L_k}{U_k - L_k} \right) \leq (<) \max_k \left(\frac{O_k(\bar{x}) - L_k}{U_k - L_k} \right).$$

Suppose that $\gamma^* = \max_k \left(\frac{U_k - O_k(x^*)}{U_k - L_k} \right)$, then $\gamma^* \leq (<) \bar{\gamma}$.

Also, consider that $\beta^* = \max_k \left(\frac{U_k - O_k(x^*)}{U_k - L_k} \right)$, then $\beta^* \leq (<) \bar{\beta}$.

In the same manner, we have $\frac{U_k - O_k(x^*)}{U_k - L_k} \geq \frac{U_k - O_k(\bar{x})}{U_k - L_k}$ for all $k = 1, 2, \dots, K$ and $\frac{U_k - O_k(x^*)}{U_k - L_k} > \frac{U_k - O_k(\bar{x})}{U_k - L_k}$ for at least one k .

$$\text{Thus, } \min_k \left(\frac{U_k - O_k(x^*)}{U_k - L_k} \right) \geq (>) \min_k \left(\frac{U_k - O_k(\bar{x})}{U_k - L_k} \right).$$

Assume that $\alpha^* = \min_k \left(\frac{U_k - O_k(x^*)}{U_k - L_k} \right)$, this gives $(\bar{\alpha} - \bar{\beta} - \bar{\gamma}) < (\alpha^* - \beta^* - \gamma^*)$ which means that the solution is not unique optimal. Thus, we have arrived at a contradiction with the fact that $(\bar{x}, \bar{\alpha}, \bar{\beta}, \bar{\gamma})$ is the unique optimal solution of (LTMFA). ■

4.4 Sensitivity analyses

Three different robust solution approaches have been suggested to solve the proposed F-IMOTPs. A variety of obtained solution results may not reflect the most appropriate

technique to solve the F-IMOTPs in a generalized way. To select the most promising solution techniques and solution sets, it is further presented with the different sensitivity measures. The following are various criteria to analyze the performances of different approaches.

Savings compared to baseline solution: The most reasonable compromise solution is assumed to be a baseline solution for each objective function. The comparison is made with a different optimal solution which is then selected in terms of more savings (See, [2]).

Co-efficient of variation: It is a relative measure and most suitable method to compare two series. The size of the measure of dispersion also depends on the size of the measurement. Thus, it is an appropriate measure of dispersion to compare two series that differ largely in respect of their means. Moreover, a series or a set of values having a lesser co-efficient of variation than others is more consistent. It also indicates how much fluctuation is happening in the existing mean response. The lower value of co-efficient of variation indicates the more homogeneous and robustness of the data (See, [2, 8]).

Degrees of desirability: The concept of degrees of desirability has been first proposed by [7, 8]. Linear physical programming [8] is a method that is used to depict the degrees of desirability (priority) for each objective function of the MOOP. The degree of desirability is a beneficial and handy tool for assigning the target values (T_l) for the objective function and categorizing the solutions. By obtaining the individual best and worst solution of each objective function, the upper and lower bound for target values (T_l) can be determined directly. By using the pay-off matrix (individual best and worst solutions of each objective function), bound ($T_l \max$) and ($T_l \min$) can be obtained. These bound provides the reduction in solvability set which can be denoted as S' and mathematically it can be shown expressed as $S' = \{S | T_l \min \leq T_l \leq T_l \max; \forall l = 1, 2, \dots, L\}$ where S is a set of parameter values for which the problem is solvable. Thus, the reduced solvability set can be used for defining the degree of desirability in the form of linguistic preferences. For more information and a stepwise procedure, one can visit the research paper by [8].

Stepwise solution algorithm

The stepwise solution procedures for the proposed F-IMOTP can be summarized as follows:

Step-1. Model the proposed F-IMOTP under uncertainty.

Step-2. Convert each intuitionistic fuzzy parameters involved in F-IMOTP into its crisp form using the accuracy function (Definition 6).

Step-3. Formulate the model (6) and solve each objective function individually in order to obtain the best and worst solution.

Step-4. Apply the different solution approach such as EFPA, EIFPA and ENPA discussed

in Sub-sections (4.1), (4.2) and (4.3) respectively.

Step-5. Solve the final model for F-IMOTP to get the compromise solution at different feasibility degree λ using suitable techniques or some optimizing software packages.

Step-6. Use the sensitivity analysis to analyze the better performance of different solution techniques at various feasibility degree λ and choose the desired compromise solution.

5 Numerical illustration

A logistic company transports two kinds of products from three sources to three different destinations using two types of conveyances. The relevant data are summarized in Table 2. The logistic company's decision-maker intends to find optimal units of different products that should be transported from various sources to different destinations using the suitable mode of conveyance, which minimizes the cost and time according to the input parameters, respectively. We have considered the three different source and destinations using two conveyances for the shipment of two types products. The decision-maker(s) wants to determine the optimal shipment policies for which the total transportation cost, time, safety cost and carbon emissions are minimized by maintaining the resource restrictions. The transportation problem is coded in AMPL language and solved using solver Knitro available on NEOS server online facility provided by Wisconsin Institutes for Discovery at the University of Wisconsin in Madison for solving optimization problems, see [25]. The solution results are summarized in Table 3. From the Table 3, it can be observed that by tuning the weight parameters between 0 to 1, various solution results are obtained. Due to space limitations, the optimal allocation of products among different echelon has not presented in this paper. The compromise solution for all four objectives has obtained at a different weight parameter (λ).

From Table 3, it can be observed that by using EFPA; the minimum value of all the objectives are found to be \$ 4360.10, 887.644 hrs., \$ 88.7644 and 5.97024 mt (metric ton), at weight parameter $\lambda = 0.1$ respectively. As for weight parameter λ increases, the values of each objective also reach towards its worst solution, and at $\lambda = 0.9$ the worst values of each objective are \$ 4357.69, 886.239 hrs., \$ 88.6283 and 5.96459 mt, which shows the more consciousness of decision makers towards the uncertainty. Similarly, EIFPA techniques also yield in different compromise solutions. At $\lambda = 0.1$, the values of each objectives by using EIFPA have been found to be \$ 4324.70, 868.882 hrs., \$ 86.8882 and 5.83967 mt, respectively. As for weight parameter λ increases, all the objectives reach towards their worst solution and at $\lambda = 0.9$, it approaches to \$ 4325.80, 870.357 hrs., \$ 87.0357 and 5.85055 mt, due to supreme importance has been given to risk violation by decision makers. Furthermore, ENPA technique results in different objective values at various weight parameter λ . At $\lambda = 0.1$, the magnitude of each objectives have been obtained as \$ 4306.83, 853.027 hrs., \$ 85.3027 and 5.7299 mt, respectively. With the increase in weight parameter λ , it has observed that each objective reaches towards their

worst outcomes which reveals that the decision makers have given more importance to the risk violation under uncertainty. Moreover, if we perform the comparison among all four approaches with respect to objective functions then it can be observed that EFPA results in better outcomes for the second and fourth objective over the other two approaches whereas EIFPA and ENPA methods yield in better results for first and third objectives for each weight parameter λ respectively. Hence all three approaches are well capable of providing the best solution for different objectives.

The corresponding achievement degree of each compromise solution has presented in Table 3. As the weight parameter λ is increasing, the values of the membership function μ is decreasing which shows the inverse trade-off between the feasibility degree and acceptance level of each compromise solution set. Interestingly, each methods EFPA, EIFPA and ENPA have been assigned with top three ranks at minimum weight parameter $\lambda = 0.1$ respectively. All the techniques have outperformed for this presented study over others. Initial few ranks have assigned to the solution set yielded by ENPA approach whereas systematic and deserving ranks have allocated to the solution sets obtained by different methods at each weight parameter λ .

The two critical aspects have highlighted that inherently involved in decision-making processes: (1) violation of risk under uncertainty and (2) balancing the global optimality of each objective. By applying EIFPA, the budget are found to be decreasing as the weight parameter λ increases. Likewise, EFPA and ENPA techniques also result in the same declining pattern of the objectives which ensures the potential management of different products. Hence, from the decision-making point of view, the computational results cope with all the prime target of the company to survive in the competitive market. An extensive opportunity to select the most promising compromise solution set is a significant advantage for the decision makers. The ENPA yield comparatively better compromise results at different weight parameters. There are ample opportunity to choose the most desired solution sets based on the decision-makers satisfaction level. Thus the decision-makers can be reached towards the optimal policies and strategies by adopting the most desired solution methods and the corresponding results. The Table 4 represents the the most desirable, desirable and most undesirable values for each objectives based on the degrees of desirability.

Table 2: Intuitionistic fuzzy input parameters

Parameters	Product 1	Product 2
\tilde{s}_{ijk}	(83,85,87;81,85,89),(80,83,86;79,83,87),(86,87,88;85,87,89) (83,85,87;81,85,89),(81,83,85;80,83,86),(75,78,81;74,78,82) (83,84,85;82,84,86),(80,82,84;78,82,86),(78,79,80;77,79,81) (83,84,85;82,84,86),(80,82,84;78,82,86),(76,78,80;75,78,81) (83,84,85;82,84,86),(80,82,84;78,82,86),(72,75,78;71,75,79) (84,85,86;83,85,87),(80,83,86;79,83,87),(76,78,80;75,78,81)	(82,84,86;80,84,88),(81,82,83;80,82,84),(74,75,76;73,75,77) (84,85,86;83,85,87),(80,83,85;78,83,87),(76,78,80;75,78,81) (84,85,86;83,85,87),(82,83,84;81,83,85),(83,84,85;82,84,86) (84,85,86;83,85,87),(82,83,84;81,83,85),(86,87,88;85,87,89) (82,84,86;80,84,88),(81,82,83;80,82,84),(78,79,80;77,79,81) (83,84,85;82,84,86),(80,82,84;78,82,86),(77,79,81;76,79,82)
\tilde{c}_{ijk}	(14,15,16;13,15,17),(20,23,25;18,23,28),(16,17,18;15,17,19) (53,55,57;51,55,59),(70,73,76;69,73,77),(37,38,39;36,38,40) (53,54,55;52,54,56),(50,52,54;48,52,56),(28,29,30;27,29,31) (72,74,76;70,74,78),(42,43,44;41,43,45),(26,28,30;25,28,31) (42,44,46;40,44,48),(20,22,24;18,22,26),(44,45,46;43,45,47) (44,45,46;43,45,47)(52,53,54;50,53,56),(16,18,20;15,18,21)	(42,44,46;40,44,48),(40,42,44;38,42,46),(44,45,46;43,45,47) (24,25,26;23,25,27),(61,63,65;60,63,66),(36,38,40;35,38,41) (24,25,26;23,25,27),(21,23,25;20,23,26),(12,14,16;11,14,17) (64,65,66;63,65,67),(42,43,44;41,43,45),(26,27,28;25,27,29) (12,14,16;11,14,17),(30,32,34;28,32,36),(48,49,50;47,49,51) (22,24,26;20,24,28),(70,72,74;68,72,76),(38,39,40;37,39,41)
\tilde{t}_{ijk}	(3,5,7;2,5,8),(1,2,3;0,2,4),(6,7,8;5,7,9) (3,5,7;2,5,8),(5,7,9;4,7,10),(5,8,11;4,8,12) (3,4,5;2,4,6),(3,5,7;2,5,8),(7,9,11;6,9,12) (3,4,5;2,4,6),(2,4,6;1,4,7),(6,8,10;5,8,11) (3,4,5;2,4,6),(1,2,3;0,2,4),(4,5,6;3,5,7) (4,5,6;3,5,7),(3,5,7;2,5,8),(6,8,10;5,8,11)	(3,4,5;2,4,6),(2,4,6;0,4,8),(4,5,6;3,5,7) (4,5,6;3,5,7),(3,6,9;2,6,10),(7,8,9;6,8,10) (2,5,8;1,5,9),(1,2,3;0,2,4),(2,4,6;0,4,8) (4,5,6;3,5,7),(2,4,6;1,4,7),(5,7,9;4,7,10) (3,4,5;2,4,6),(2,3,4;1,3,5),(7,9,11;6,9,12) (2,4,6;1,3,7),(5,7,9;4,7,10),(8,9,10;7,9,11)
\tilde{s}_{cijk}	(0.3,0.5,0.8;0.2,0.5,0.9),(0.1,0.2,0.3;0.0,0.2,0.4),(0.5,0.7,0.9;0.4,0.7,1.0) (0.3,0.5,0.7;0.2,0.5,0.8),(0.6,0.7,0.8;0.5,0.7,0.9),(0.6,0.8,1.0;0.5,0.8,1.1) (0.3,0.4,0.5;0.2,0.4,0.6),(0.4,0.5,0.6;0.3,0.5,0.7),(0.8,0.9,1.0;0.7,0.9,1.1) (0.3,0.4,0.5;0.2,0.4,0.6),(0.3,0.4,0.5;0.2,0.4,0.6),(0.6,0.8,1.0;0.5,0.8,1.1) (0.3,0.4,0.5;0.2,0.4,0.6),(0.1,0.2,0.3;0.0,0.2,0.4),(0.3,0.5,0.7;0.2,0.5,0.8) (0.3,0.5,0.7;0.2,0.5,0.8),(0.3,0.5,0.7;0.2,0.5,0.8),(0.7,0.8,0.9;0.6,0.8,1)	(0.3,0.4,0.5;0.2,0.4,0.6),(0.2,0.4,0.6;0.1,0.4,0.7),(0.4,0.5,0.6;0.3,0.5,0.8) (0.4,0.5,0.6;0.3,0.5,0.7),(0.5,0.6,0.7;0.4,0.6,0.8),(0.6,0.8,1.0;0.5,0.8,1.1) (0.3,0.5,0.7;0.2,0.5,0.8),(0.1,0.2,0.3;0.0,0.2,0.4),(0.3,0.4,0.5;0.2,0.4,0.6) (0.3,0.5,0.7;0.2,0.5,0.8),(0.2,0.4,0.6;0.1,0.4,0.7),(0.5,0.7,0.9;0.4,0.7,1.0) (0.3,0.4,0.5;0.2,0.4,0.6),(0.2,0.3,0.4;0.1,0.3,0.5),(0.7,0.9,1.1;0.6,0.9,1.2) (0.3,0.4,0.5;0.2,0.4,0.6),(0.5,0.7,0.9;0.4,0.7,1),(0.8,0.9,1.0;0.7,0.9,1.1)
\tilde{c}_{eijk}	(0.03,0.05,0.07;0.02,0.05,0.08),(0.01,0.02,0.03;0.0,0.02,0.04),(0.06,0.07,0.08;0.05,0.07,0.09) (0.04,0.05,0.06;0.03,0.05,0.07),(0.06,0.07,0.08;0.05,0.07,0.09),(0.07,0.08,0.09;0.06,0.08,0.1) (0.03,0.04,0.05;0.02,0.04,0.06),(0.04,0.05,0.06;0.03,0.05,0.07),(0.07,0.09,0.11;0.06,0.06,0.12) (0.03,0.04,0.05;0.02,0.04,0.06),(0.03,0.04,0.05;0.02,0.04,0.06),(0.07,0.08,0.09;0.06,0.08,0.1) (0.03,0.04,0.05;0.02,0.04,0.06),(0.01,0.02,0.03;0.0,0.02,0.04),(0.04,0.05,0.06;0.03,0.05,0.07) (0.04,0.05,0.06;0.03,0.05,0.07),(0.04,0.05,0.06;0.03,0.05,0.07),(0.07,0.08,0.09;0.06,0.08,0.1)	(0.03,0.04,0.05;0.02,0.04,0.06),(0.03,0.04,0.05;0.02,0.04,0.06),(0.04,0.05,0.06;0.03,0.05,0.07) (0.03,0.05,0.07;0.02,0.05,0.08),(0.05,0.06,0.07;0.04,0.06,0.08),(0.07,0.08,0.09;0.06,0.08,0.1) (0.03,0.05,0.07;0.02,0.05,0.08),(0.01,0.02,0.03;0.0,0.02,0.04),(0.03,0.04,0.05;0.02,0.04,0.06) (0.03,0.05,0.07;0.02,0.05,0.08),(0.03,0.04,0.05;0.02,0.04,0.06),(0.06,0.07,0.08;0.05,0.07,0.09) (0.03,0.04,0.05;0.02,0.04,0.06),(0.03,0.05,0.07;0.02,0.05,0.08),(0.07,0.09,0.11;0.06,0.06,0.12) (0.03,0.04,0.05;0.02,0.04,0.06),(0.06,0.07,0.08;0.05,0.07,0.09),(0.07,0.09,0.11;0.06,0.06,0.12)
\tilde{a}_i	(206,208,210;205,208,211),(250,252,254;248,252,256),(224,226,228;222,226,230) (152,154,156;150,154,158),(562,564,566;560,564,568),(540,545,550;535,545,555) (272,274,276;270,274,278),(255,256,257;254,256,258),(254,255,256;253,255,257)	(252,254,256;250,254,258),(262,264,266;260,264,268),(244,245,246;243,245,247) (158,159,160;157,159,161),(146,148,150;144,148,152),(123,125,127;122,125,128) (272,274,276;270,274,278),(765,767,769;764,767,780),(453,455,457;452,455,458)
\tilde{b}_j	(82,83,84;81,83,85),(85,87,89;84,87,91),(93,94,95;92,94,96) (82,84,86;80,84,88),(84,85,86;83,85,87),(92,95,98;91,95,99) (84,85,86;83,85,87),(65,67,69;64,67,70),(92,94,96;90,94,98)	(73,74,75;72,74,76),(50,52,54;48,52,56),(83,85,87;81,85,89) (41,45,49;40,45,50),(56,57,58;55,57,59),(74,75,76;73,75,77) (71,75,79;70,75,80),(85,87,89;84,87,90),(62,63,64;60,63,66)
\tilde{e}_i	(22,24,26;20,24,28),(20,24,28;18,24,30)(34,35,36;33,35,37) (34,35,36;33,35,37),(33,35,37;32,35,38)(24,25,26;23,25,27)	(23,24,25;22,24,26),(42,44,46;40,44,48) (30,35,40;25,35,45)(32,35,38;31,35,39),(44,45,46;43,45,47)
\tilde{p}_k	(0.2,0.4,0.6;0.1,0.4,0.7),(0.3,0.5,0.7;0.2,0.5,0.8)	(0.7,0.9,1.1;0.6,0.9,1.2),(0.6,0.8,1.0;0.5,0.8,1.1)
B_j	(2450,2445,2505)(1425,1665,1545)(1565,1685,1425)	(2450,2445,2505)(1425,1665,1545)(1565,1685,1425)
B	5	5

Table 3: Optimal solutions obtained by different methods

Weight (λ)	Objective values	Extended Fuzzy Programming Approach (EFPA)	Extended Intuitionistic Fuzzy Programming Approach (EIFPA)	Extended Neutrosophic Programming Approach (ENPA)
$\lambda=0.1$	<i>Min</i> Z_1	4360.1	4324.7	4306.83
	<i>Min</i> Z_2	887.644	868.882	853.027
	<i>Min</i> Z_3	88.7644	86.8882	85.3027
	<i>Min</i> Z_4	5.97024	5.83967	5.7299
$\lambda=0.2$	<i>Min</i> Z_1	4360.09	4358.87	3889.59
	<i>Min</i> Z_2	887.646	887.751	835.3
	<i>Min</i> Z_3	88.7646	88.7751	83.53
	<i>Min</i> Z_4	5.97025	5.97094	5.58824
$\lambda=0.3$	<i>Min</i> Z_1	4357.6	4322.77	4228.76
	<i>Min</i> Z_2	882.777	870.266	848.714
	<i>Min</i> Z_3	88.2777	87.0266	84.8714
	<i>Min</i> Z_4	5.93873	5.84968	5.69559
$\lambda=0.4$	<i>Min</i> Z_1	4356.27	4313.18	4057.54
	<i>Min</i> Z_2	883.088	857.292	846.627
	<i>Min</i> Z_3	88.3088	85.7292	84.6627
	<i>Min</i> Z_4	5.93522	5.72106	5.67529
$\lambda=0.5$	<i>Min</i> Z_1	4360.19	4337.69	4311.32
	<i>Min</i> Z_2	887.609	872.949	853.118
	<i>Min</i> Z_3	88.7609	87.2949	85.3118
	<i>Min</i> Z_4	5.97005	5.86669	5.731
$\lambda=0.6$	<i>Min</i> Z_1	4359.6	4324.34	3926.1
	<i>Min</i> Z_2	887.456	868.335	833.667
	<i>Min</i> Z_3	88.7456	86.8335	83.3667
	<i>Min</i> Z_4	5.96928	5.83305	5.57907
$\lambda=0.7$	<i>Min</i> Z_1	4349.47	4325.95	4206.61
	<i>Min</i> Z_2	871.233	870.301	848.91
	<i>Min</i> Z_3	87.1233	87.0301	84.891
	<i>Min</i> Z_4	5.87853	5.85014	5.69869
$\lambda=0.8$	<i>Min</i> Z_1	4355.73	4314.35	4146.7
	<i>Min</i> Z_2	883.183	851.972	834.551
	<i>Min</i> Z_3	88.3183	85.1972	83.4551
	<i>Min</i> Z_4	5.9364	5.70287	5.5971
$\lambda=0.9$	<i>Min</i> Z_1	4357.69	4325.8	4304.75
	<i>Min</i> Z_2	886.239	870.357	852.007
	<i>Min</i> Z_3	88.6283	87.0357	85.2007
	<i>Min</i> Z_4	5.96459	5.85055	5.72234

5.1 Sensitivity analyses

The three different solution sets based on the degree of desirability scenario have been generated, and the corresponding performances of each solution method under the dif-

ferent solution sets are also recorded. From Table 5 (solution 1), the EFPA reveals that transportation cost (T.C) can be reduced by 53.73%, transportation time (T.T) can be lowered by 20.69%, safety cost (S.C) can be mitigated by 79.36% and carbon emissions (C.E) can be mitigated by 79.36% as compared to the baseline solution. Furthermore, EIFPA technique yield in the reduction of T.C by 55.21%, a significant increment in the T.T by 17.23%, notably decrement in the S.C by 83.81% and C.E by 83.81% as compared to the baseline solution. Similarly, on applying ENPA technique, it is observed that the T.C can be reduced by 55.99 %, T.T can be lowered by 23.12 %, S.C can be mitigated by 79.36% and C.E can be mitigated by 87.45% as compared to the baseline solution. Likewise, from Table 6 (solution 2), the EFPA technique shows that T.C can be diminished by 55.81 %, T.T can be increased by 22.77 %, S.C can be mitigated by 79.36% and C.E can be reduced by 87.15 % as compared to the baseline solution. Furthermore, EIFPA technique results in the reduction of T.C by 53.63 %, a significant increment in the T.T by 19.56 %, notably decrement in the S.C by 83.55 % and C.E can be mitigated by 79.36% as compared to the baseline solution. Similarly, on applying ENPA technique, it is observed that the T.C can be mitigated by 55.01 %, T.T can be enhanced by 16.63 %, S.C can be reduced by 79.26% and C.E can be mitigated by 79.36% as compared to the baseline solution. From Table 7 (solution 3), EFPA ensures that T.C can be reduced by 53.77 %; T.T can be enhanced by 20.96 %, and S.C can be mitigated by 79.43% and C.E can be reduced by 79.36% as compared to the baseline solution. Furthermore, the EIFPA technique results in the reduction of T.C by 56.13 %, a significant increment in the T.T by 23.24 %, remarkable decrement in the S.C by 87.66 % and C.E can be mitigated by 79.36% as compared to the baseline solution. Similarly, on applying ENPA technique, it is observed that the T.C can be reduced by 55.01 %, T.T can be enhanced by 16.63 %, S.C can be mitigated by 79.26% and C.E can be mitigated by 79.36% as compared to the baseline solution.

For solution 1, a comparative study with the co-efficient of variation shows that all the objective functions are more homogeneous under variation while using ENPA techniques over others. Similarly, more robust (homogeneous) results of each objective function have been achieved for solution 2 while using EFPA technique. Furthermore, it is also observed that all the objective functions are more homogeneous under variation while using the EIFPA technique for solution 3. The trending behavior of the different techniques has been depicted in Figure 2 for each solution set. The graphical representation of solution 1 (sub-figure 2a), solution 2 (sub-figure 2b) and solution 3 (sub-figure 2c) by using different techniques reveals the performances of each solution approaches. In addition to the different solutions set, the behavior of the overall satisfaction level with the co-efficient of variations has also been shown in Figure 3. The representation of fluctuating behavior for solution 1 (sub-figure 3a), solution 2 (sub-figure 3b) and solution 3 (sub-figure 3c) by using different techniques reflects homogeneity or robustness under the variation. Finally, the optimal solution results for three different solution sets have been summarized in Table 8. From Table 8, all the solution sets are under the most desirable zone, which provides an opportunity to select a better one amongst the best solution sets. Thus these criteria

(savings compared to baseline solution, CV, and degrees of desirability) for selection of optimal solution results are proven to be quite helpful tools while dealing with multiple objective optimization problems. Moreover, the different solutions set, the behavior of the overall satisfaction level with the weight parameter (λ) has also been shown in Figure 1. The representation of fluctuating behavior for solution 1 (sub-figure 1a), solution 2 (sub-figure 1b) and solution 3 (sub-figure 1c) by using different techniques reflects homogeneity or robustness under the variation.

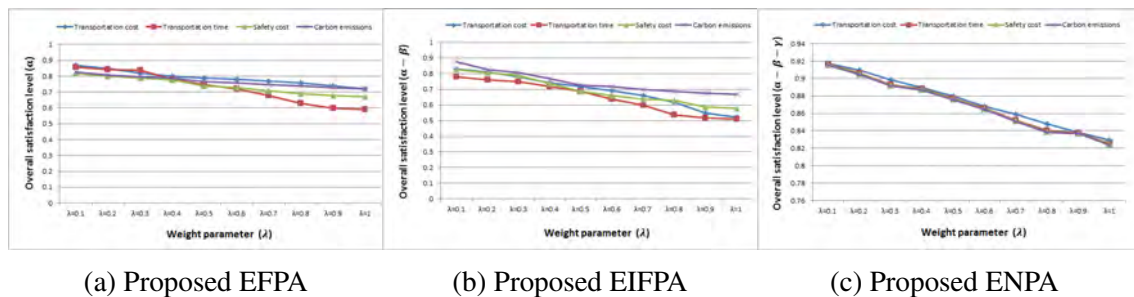

Figure 1: Overall satisfaction level v/s Weight parameter (λ)

Table 4: Degrees of desirability for each objective function

Objective functions	Most Desirable (MD)	Desirable (D)	Most Undesirable (MU)
Minimum $Z_1(X)$ (Transportation cost)	4360.19	5230.80	5794.80
Minimum $Z_2(X)$ (Transportation time)	887.609	901.456	917.739
Minimum $Z_3(X)$ (Safety cost)	88.7609	93.8349	98.4924
Minimum $Z_4(X)$ (Carbon emissions)	5.97005	9.45924	13.8984

Table 5: Solution 1: ($Z_1 \leq 4360.19$, $Z_2 \leq 887.609$, $Z_3 \leq 88.7609$ and $Z_4 \leq 5.97005$)

Objective functions	EFPA		EIFPA		ENPA		
	Baseline solution	Solution	CV	Solution	CV	Solution	CV
$Z_1(X)$ (Transportation cost)	4276.34	4360.10	1.23	4324.70	1.34	4306.83	1.05
$Z_2(X)$ (Transportation time)	810.4543	887.644	0.93	868.882	1.02	853.027	0.91
$Z_3(X)$ (Safety cost)	72.8690	88.7644	1.17	86.8882	1.14	85.3027	1.09
$Z_4(X)$ (Carbon emissions)	2.03943	5.97024	1.03	5.83967	1.09	5.7299	1.14

Table 6: Solution 2: ($Z_1 \leq 5230.80$, $Z_2 \leq 901.456$, $Z_3 \leq 93.8349$ and $Z_4 \leq 9.45924$)

Objective functions	EFPA		EIFPA		ENPA		
	Baseline solution	Solution	CV	Solution	CV	Solution	CV
$Z_1(X)$ (Transportation cost)	4276.349	4360.19	1.39	4337.69	1.84	411.32	1.71
$Z_2(X)$ (Transportation time)	810.4543	887.609	0.78	872.949	0.89	853.118	0.98
$Z_3(X)$ (Safety cost)	72.8690	88.7609	1.29	87.2949	1.43	85.3118	1.67
$Z_4(X)$ (Carbon emissions)	2.03943	5.97005	1.11	5.86669	1.17	5.7310	1.23

Table 7: Solution 3: ($Z_1 \leq 5794.80$, $Z_2 \leq 917.739$, $Z_3 \leq 98.4924$ and $Z_4 \leq 13.8984$)

Objective functions	EFPA		EIFPA		ENPA		
	Baseline solution	Solution	CV	Solution	CV	Solution	CV
$Z_1(X)$ (Transportation cost)	4276.34	4357.69	1.37	4325.80	1.17	4304.75	1.49
$Z_2(X)$ (Transportation time)	810.4543	886.239	0.98	870.357	0.87	852.007	1.13
$Z_3(X)$ (Safety cost)	72.8690	88.6283	1.26	87.0357	1.01	85.2007	1.14
$Z_4(X)$ (Carbon emissions)	2.03943	5.96459	1.21	5.85055	1.11	5.72234	1.25

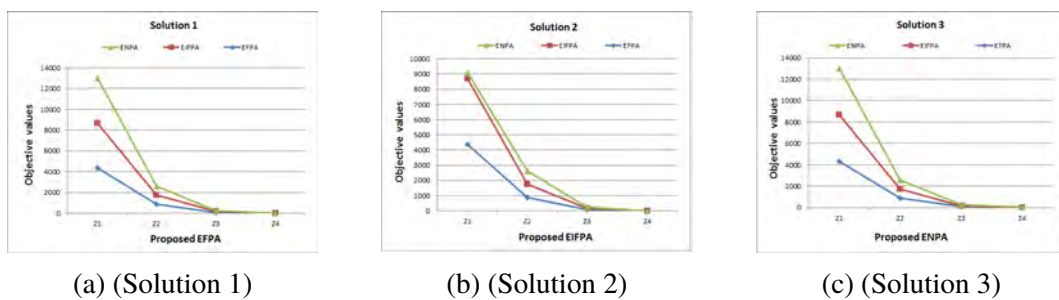

Figure 2: Objective functions v/s solution methods

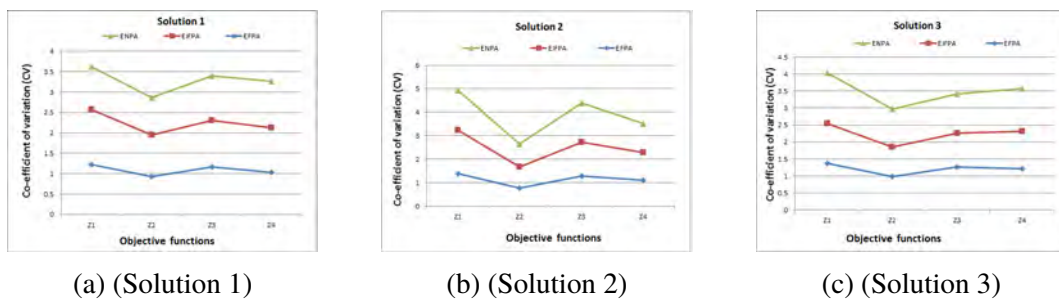

Figure 3: Co-efficient of variation v/s solution methods

Table 8: Comparison of optimal solutions with multiple criteria

Different approaches	Baseline solution	CV	Degree of desirability
Solution 1 (EFPA)	Z ₁ : 55.01 % ↓	1.05	4360.19 (MD)
	Z ₂ : 23.12 % ↓	0.91	887.609 (MD)
	Z ₃ : 87.45 % ↓	1.09	88.7609 (MD)
	Z ₄ : 72.34 % ↓	1.19	5.97005 (MD)
Solution 2 (EIFPA)	Z ₁ : 55.81 % ↓	1.39	4360.19 (MD)
	Z ₂ : 16.63 % ↓	0.78	887.609 (MD)
	Z ₃ : 87.15 % ↓	1.29	88.7609 (MD)
	Z ₄ : 72.03 % ↓	1.12	5.97005 (MD)
Solution 3 (ENPA)	Z ₁ : 56.13 % ↓	1.17	4360.19 (MD)
	Z ₂ : 23.24 % ↓	0.87	887.609 (MD)
	Z ₃ : 87.66 % ↓	1.01	88.7609 (MD)
	Z ₄ : 71.89 % ↓	1.03	5.97005 (MD)

6 Conclusions

In this article we consider various modeling approaches for multiobjective transportation problem under intuitionistic fuzzy parameters. Minimization of transportation cost, time, safety cost and carbon-emissions are considered as objective functions under the supply, demand, capacity, safety and budget constraints. The extended version of various conventional approaches such as EFPA, EIFPA and ENPA are developed to solve the MOTPs. The robustness of the solution approaches have been established with the help of results. At different weight parameter, a set of compromised solution are obtained. The sensitivity analysis is also performed based on the different criteria such as baseline solution, CV and degrees of desirability which generates the variety of solution sets based on the satisfaction level of the decision-maker. It is observed that ENPA outperforms others. For all the solution approaches, when decision-maker(s) are more concerned about the vagueness then objective values reaches to its worst and vice-versa. We propose that the present work can be extended further for multi-level MOPP and applied to different real-life problems such as supply chain, inventory control and assignment problem as well.

References

- [1] Adhami, A. Y. and Ahmad, F. [2020], ‘Interactive pythagorean-hesitant fuzzy computational algorithm for multiobjective transportation problem under uncertainty’, *International Journal of Management Science and Engineering Management* **15**(4), 288–297.
- [2] Ahmad, F. [2021], ‘Robust neutrosophic programming approach for solving intuitionistic fuzzy multiobjective optimization problems’, *Complex & Intelligent Systems* **7**, 1935–1954.
- [3] Ahmad, F. and Adhami, A. Y. [2019], ‘Neutrosophic programming approach to mul-

- tiobjective nonlinear transportation problem with fuzzy parameters', *International Journal of Management Science and Engineering Management* **14**(3), 218–229.
- [4] Ahmad, F., Adhami, A. Y. and Smarandache, F. [2018], 'Single Valued Neutrosophic Hesitant Fuzzy Computational Algorithm for Multiobjective Nonlinear Optimization Problem', *Neutrosophic Sets and Systems* **22**, 76–86.
- [5] Ahmad, F., Adhami, A. Y. and Smarandache, F. [2019], 'Neutrosophic optimization model and computational algorithm for optimal shale gas water management under uncertainty', *Symmetry* **11**(4).
URL: <http://www.mdpi.com/2073-8994/11/4/544>
- [6] Ahmad, F., Adhami, A. Y. and Smarandache, F. [2020], Modified neutrosophic fuzzy optimization model for optimal closed-loop supply chain management under uncertainty, in 'Optimization theory based on neutrosophic and plithogenic sets', Elsevier, pp. 343–403.
- [7] Ahmad, F., Ahmad, S. and Zaindin, M. [2021], 'A sustainable production and waste management policies for covid-19 medical equipment under uncertainty: A case study analysis', *Computers & Industrial Engineering* **157**(3), 107381.
- [8] Ahmad, F., Alnowibet, K. A., Alrasheedi, A. F. and Adhami, A. Y. [2021], 'A multi-objective model for optimizing the socio-economic performance of a pharmaceutical supply chain', *Socio-Economic Planning Sciences* p. 101126.
- [9] Ahmadini, A. A. H. and Ahmad, F. [2021], 'A novel intuitionistic fuzzy preference relations for multiobjective goal programming problems', *Journal of Intelligent & Fuzzy Systems* **40**(3), 4761–4777.
- [10] Akram, M., Adeel, A. and Alcantud, J. C. R. [2019], 'Group decision-making methods based on hesitant n-soft sets', *Expert Systems with Applications* **115**, 95–105.
- [11] Alcantud, J. C. R. and Giarlotta, A. [2019], 'Necessary and possible hesitant fuzzy sets: A novel model for group decision making', *Information Fusion* **46**, 63–76.
- [12] Alcantud, J. C. R. and Santos-García, G. [2017], Expanded hesitant fuzzy sets and group decision making, in '2017 IEEE International Conference on Fuzzy Systems (FUZZ-IEEE)', IEEE, pp. 1–6.
- [13] Alcantud, J. C. R. and Torra, V. [2018], 'Decomposition theorems and extension principles for hesitant fuzzy sets', *Information Fusion* **41**, 48–56.
- [14] Angelov, P. P. [1997], 'Optimization in an intuitionistic fuzzy environment', *Fuzzy Sets and Systems* **86**(3), 299–306.

- [15] Atanassov, K. T. [1986], ‘Intuitionistic fuzzy sets’, *Fuzzy Sets and Systems* **20**(1), 87–96.
- [16] Bharati, S. K. [2018], ‘Hesitant fuzzy computational algorithm for multiobjective optimization problems’, *International Journal of Dynamics and Control* pp. 1–8.
- [17] Das, A. K., D. and Jana, R. [2020], ‘Some aspects on solving transportation problem’, *Yugoslav Journal of Operations Research* **30**(1), 45–57.
- [18] Faizi, S., Rashid, T., Saabun, W., Zafar, S. and Wtrbski, Jaros, j. v. n. p. y. p. [n.d.], ‘Decision making with uncertainty using hesitant fuzzy sets’.
- [19] Jana, D. K. [2016], ‘Paci fi c Science Review A : Natural Science and Engineering Novel arithmetic operations on type-2 intuitionistic fuzzy and its applications to transportation problem’, *Pacific Science Review A: Natural Science and Engineering* **18**(3), 178–189.
URL: <http://dx.doi.org/10.1016/j.psra.2016.09.008>
- [20] Lan, J., Jin, R., Zheng, Z. and Hu, M. [2017], ‘Priority degrees for hesitant fuzzy sets: Application to multiple attribute decision making’, *Operations Research Perspectives* **4**, 67–73.
- [21] Liu, C.-f. and Luo, Y.-S. [2017], ‘New aggregation operators of single-valued neutrosophic hesitant fuzzy set and their application in multi-attribute decision making’, *Pattern Analysis and Applications* pp. 1–11.
- [22] Mohan, S., Neogy, S. and Das, A. [2004], ‘A note on linear complementarity problems and multiple objective programming’, *Mathematical programming* **100**(2), 339–344.
- [23] Peng, X. and Selvachandran, G. [2017], ‘Pythagorean fuzzy set: state of the art and future directions’, *Artificial Intelligence Review* pp. 1–55.
- [24] Peng, X. and Yang, Y. [2015], ‘Some results for pythagorean fuzzy sets’, *International Journal of Intelligent Systems* **30**(11), 1133–1160.
- [25] Server, N. [2016], ‘State-of-the-art solvers for numerical optimization’.
- [26] Singh, S. K. and Yadav, S. P. [2015], ‘Modeling and optimization of multi objective non-linear programming problem in intuitionistic fuzzy environment’, *Applied Mathematical Modelling* **39**(16), 4617–4629.
URL: <http://dx.doi.org/10.1016/j.apm.2015.03.064>
- [27] Singh, S. K. and Yadav, S. P. [2016a], ‘Intuitionistic fuzzy transportation problem with various kinds of uncertainties in parameters and variables’, *International Journal of Systems Assurance Engineering and Management* **7**(3), 262–272.

- [28] Singh, S. and Yadav, S. [2016b], 'A new approach for solving intuitionistic fuzzy transportation problem of type-2', *Annals of Operations Research* **243**(1-2), 131–140.
- [29] Smarandache, F. [1999], *A Unifying Field in Logics: Neutrosophic Logic*.
URL: <http://cogprints.org/1919/>
- [30] Wan, S.-P., Jin, Z. and Dong, J.-Y. [2018], 'Pythagorean fuzzy mathematical programming method for multi-attribute group decision making with pythagorean fuzzy truth degrees', *Knowledge and Information Systems* **55**(2), 437–466.
- [31] Ye, J. [2015], 'Multiple-attribute decision-making method under a single-valued neutrosophic hesitant fuzzy environment', *Journal of Intelligent Systems* **24**(1), 23–36.
- [32] Zadeh, L. A. et al. [1965], 'Fuzzy sets', *Information and control* **8**(3), 338–353.
- [33] Zhang, X. and Xu, Z. [2014], 'Extension of TOPSIS to multiple criteria decision making with pythagorean fuzzy sets', *International Journal of Intelligent Systems* **29**(12), 1061–1078.
- [34] Zhang, X., Xu, Z. and Xing, X. [2016], 'Hesitant fuzzy programming technique for multidimensional analysis of hesitant fuzzy preferences', *OR Spectrum* **38**(3), 789–817.
- [35] Zhang, Z. [2017], 'Hesitant fuzzy multi-criteria group decision making with unknown weight information', *International Journal of Fuzzy Systems* **19**(3), 615–636.
- [36] Zhou, W. and Xu, Z. [2018], 'Portfolio selection and risk investment under the hesitant fuzzy environment', *Knowledge-Based Systems* **144**, 21–31.
URL: <https://doi.org/10.1016/j.knosys.2017.12.020>
- [37] Zimmermann, H. J. [1978], 'Fuzzy programming and linear programming with several objective functions', *Fuzzy Sets and Systems* **1**(1), 45–55.

NEUTROSOPHIC ALGEBRA

Intuitionistic Neutrosophic Soft Set over Rings

Said Broumi, Florentin Smarandache, Pabitra Kumar Maji

Said Broumi, Florentin Smarandache, Pabitra Kumar Maji (2014). Intuitionistic Neutrosophic Soft Set over Rings. *Mathematics and Statistics* 2(3), 120-126; DOI: 10.13189/ms.2014.0203031.

Abstract . S.Broumi and F.Smarandache introduced the concept of intuitionistic neutrosophic soft set as an extension of the soft set theory. In this paper we have applied the concept of intuitionistic neutrosophic soft set to rings theory. The notion of intuitionistic neutrosophic soft set over ring (INSSOR for short) is introduced and their basic properties have been investigated. The definitions of intersection, union, AND, and OR operations over ring (INSSOR) have also been defined. Finally, we have defined the product of two intuitionistic neutrosophic soft set over ring.

Keywords Intuitionistic Neutrosophic Soft Set, Intuitionistic Neutrosophic Soft Set over Ring, Soft Set, Neutrosophic Soft Set

1. Introduction

The theory of neutrosophic set (NS), which is the generalization of the classical sets, conventional fuzzy set [1], intuitionistic fuzzy set [2] and interval valued fuzzy set [3], was introduced by Smarandache [4]. This concept has recently motivated new research in several directions such as databases [5,6], medical diagnosis problem [7], decision making problem [8], topology [9], control theory [10] and so on. We become handicapped to use fuzzy sets, intuitionistic fuzzy sets or interval valued fuzzy sets when the indeterministic part of uncertain data plays an important role to make a decision. In this context some works can be found in [11,12,13,14].

Another important concept that addresses uncertain information is the soft set theory originated by Molodtsov [15]. This concept is free from the parameterization inadequacy syndrome of fuzzy set theory, rough set theory, probability theory. Molodtsov has successfully applied the soft set theory in many different fields such as smoothness of functions, game theory, operations research, Riemann integration, Perron integration, and probability.

In recent years, soft set theory has been received much attention since its appearance. There are many papers devoted to fuzzify the concept of soft set theory which leads to a series of mathematical models such as fuzzy soft set [16,17,18,19,20], generalized fuzzy soft set [21,22], possibility fuzzy soft set [23] and so on. Thereafter, P.K.Maji and his coworker [24] introduced the notion of intuitionistic fuzzy soft set which is based on a combination of the intuitionistic fuzzy sets and soft set models and studied the properties of intuitionistic fuzzy soft set. Later, a lot of extensions of intuitionistic fuzzy soft are appeared such as generalized intuitionistic fuzzy soft set [25], possibility Intuitionistic fuzzy soft set [26] and so on. Furthermore, few researchers have contributed a lot towards neutrosophication of soft set theory. In [27] P.K.Maji, first proposed a new mathematical model called “neutrosophic soft set” and investigate some properties regarding neutrosophic soft union, neutrosophic soft intersection, complement of a neutrosophic soft set, De Morgan’s laws. In 2013, S.Broumi and F. Smarandache [28] combined the intuitionistic neutrosophic set and soft set which lead to a new mathematical model called “intuitionistic neutrosophic soft sets”. They studied the notions of intuitionistic neutrosophic soft set union, intuitionistic neutrosophic soft set intersection, complement of intuitionistic neutrosophic soft set and several other properties of intuitionistic neutrosophic soft set along with examples and proofs of certain results. S.Broumi [29] presented the concept of “generalized neutrosophic soft set” by combining the generalized neutrosophic sets [13] and soft set models, studied some properties on it, and presented an application of generalized neutrosophic soft Set in decision making problem.

The algebraic structure of soft set theories has been explored in recent years. In [30], Aktas and Cagman gave a definition of soft groups and compared soft sets to the related concepts of fuzzy sets and rough sets. Sezgin and Atagün [33] defined the notion of normalistic soft groups and corrected some of the problematic cases in paper by Aktas and Cagman [30]. Aygunoglu and Aygun [31] introduced the notion of fuzzy soft groups based on Rosenfeld’s approach [32] and studied its properties. In 2010, Acar et al. [34] introduced the

basic notion of soft rings which are actually a parametrized family of subrings. Ghosh, Binda and Samanta [35] introduced the notion of fuzzy soft rings and fuzzy soft ideals and studied some of its algebraic properties. Inan and Ozturk [36] concurrently studied the notion of fuzzy soft rings and fuzzy soft ideals but they dealt with these concepts in a more detailed manner compared to Ghosh et al.[35]. In 2012, B.P.Varol et al [37]introduced the notion of fuzzy soft ring in different way and studied several of their basic properties. J. Zhan et al[38]introduced soft rings related to fuzzy set theory. G. Selvachandran and A. R. Salleh[39]introduced vague soft rings and vague soft ideals and studied some of their basic properties. Z.Zhang [40] introduced intuitionistic fuzzy soft rings studied the algebraic properties of intuitionistic fuzzy soft ring. Studies of fuzzy soft rings are carried out by several researchers but the notion of neutrosophic soft rings is not studied. So, in this work we first study with the algebraic properties of intuitionistic neutrosophic soft set in ring theory. This paper is organized as follows. In section 2 we gives some known and useful preliminary definitions and notations on soft set theory, neutrosophic set, intuitionistic neutrosophic set, intuitionistic neutrosophic soft set and ring theory. In section 3 we discuss intuitionistic neutrosophic soft set over ring (INSSOR). In section 4 concludes the paper.

2. Preliminaries

In this section we recapitulate some relevant definitions viz, soft set, neutrosophic set, intuitionistic neutrosophic set, intuitionistic neutrosophic soft sets, fuzzy subring for better understanding of this article.

2.1. Definition 1

Molodtsov defined the notion of a soft set in the following way: Let U be an initial universe and E be a set of parameters. Let $\zeta(U)$ denotes the power set of U and A be a non-empty subset of E . Then a pair (P, A) is called a soft set over U , where P is a mapping given by $P : A \rightarrow \zeta(U)$. In other words, a soft set over U is a parameterized family of subsets of the universe U . For $\varepsilon \in A$, $P(\varepsilon)$ may be considered as the set of ε -approximate elements of the soft set (P, A) .

2.2. Definition

Let U be an universe of discourse then the neutrosophic set A is an object having the form $A = \{x : T_A(x), I_A(x), F_A(x), x \in U\}$, where the functions $T, I, F : U \rightarrow]0, 1^+[$ define respectively the degree of membership, the degree of indeterminacy, and the degree of non-membership of the element $x \in X$ to the set A with the condition.

$$0 \leq T_A(x) + I_A(x) + F_A(x) \leq 3^+ \quad (1)$$

From philosophical point of view, the neutrosophic set takes the value from real standard or non-standard subsets

of $]0, 1^+[$. So instead of $]0, 1^+[$ we need to take the interval $[0, 1]$ for technical applications, because $]0, 1^+[$ will be difficult to apply in the real applications such as in scientific and engineering problems.

2.2. Definition 11

An element x of U is called significant with respect to neutrosophic set A of U if the degree of truth-membership or falsity-membership or indeterminacy-membership value, i.e., $T_A(x)$ or $I_A(x)$ or $F_A(x) \geq 0.5$. Otherwise, we call it insignificant. Also, for neutrosophic set the truth-membership, indeterminacy-membership and falsity-membership all can not be significant. We define an intuitionistic neutrosophic set by

$$A = \{x : T_A(x), I_A(x), F_A(x), x \in U\}, \text{ where}$$

$$\min \{ T_A(x), F_A(x) \} \leq 0.5,$$

$$\min \{ T_A(x), I_A(x) \} \leq 0.5,$$

$$\min \{ F_A(x), I_A(x) \} \leq 0.5, \text{ for all } x \in U,$$

$$\text{with the condition } 0 \leq T_A(x) + I_A(x) + F_A(x) \leq 2. \quad (2)$$

As an illustration, let us consider the following example.

2.2. Example

Assume that the universe of discourse $U = \{x_1, x_2, x_3\}$, where x_1 characterizes the capability, x_2 characterizes the trustworthiness and x_3 indicates the prices of the objects. Further, It may be assumed that the values of x_1, x_2 and x_3 are in $[0, 1]$ and they are obtained from some questionnaires of some experts. The experts may impose their opinion in three components viz. the degree of goodness, the degree of indeterminacy and that of poorness to explain the characteristics of the objects. Suppose A is an intuitionistic neutrosophic set (INS) of U , such that,

$A = \{x_1, 0.3, 0.5, 0.4, x_2, 0.4, 0.2, 0.6, x_3, 0.7, 0.3, 0.5\}$, where the degree of goodness of capability is 0.3, degree of indeterminacy of capability is 0.5 and degree of falsity of capability is 0.4 etc.

2.2. Definition

Let U be an initial universe set and $A \subset E$ be a set of parameters. Let $N(U)$ denotes the set of all intuitionistic neutrosophic sets of U . The collection (P, A) is termed to be the soft intuitionistic neutrosophic set over U , where P is a mapping given by $P : A \rightarrow N(U)$.

2.2. Remark

We will denote the intuitionistic neutrosophic soft set defined over a universe by INSS.

Let us consider the following example.

2.2. Example

Let U be the set of blouses under consideration and E is the set of parameters (or qualities). Each parameter is a intuitionistic neutrosophic word or sentence involving intuitionistic neutrosophic words. Consider $E = \{ \text{Bright, Cheap, Costly, very costly, Colorful, Cotton, Polystyrene, long sleeve, expensive} \}$. In this case, to define an intuitionistic neutrosophic soft set means to point out Bright blouses, Cheap blouses, Blouses in Cotton and so on. Suppose that, there are five blouses in the universe U given by, $U = \{b_1, b_2, b_3, b_4, b_5\}$ and the set of parameters $A = \{e_1, e_2, e_3, e_4\}$, where each e_i is a specific criterion for blouses: e_1 stands for 'Bright', e_2 stands for 'Cheap', e_3 stands for 'costly', e_4 stands for 'Colorful',
Suppose that,

- $P(\text{Bright}) = \{ b_1, 0.5, 0.6, 0.3, b_2, 0.4, 0.7, 0.2, b_3, 0.6, 0.2, 0.3, b_4, 0.7, 0.3, 0.2, b_5, 0.8, 0.2, 0.3 \}$.
- $P(\text{Cheap}) = \{ b_1, 0.6, 0.3, 0.5, b_2, 0.7, 0.4, 0.3, b_3, 0.8, 0.1, 0.2, b_4, 0.7, 0.1, 0.3, b_5, 0.8, 0.3, 0.4 \}$.
- $P(\text{Costly}) = \{ b_1, 0.7, 0.4, 0.3, b_2, 0.6, 0.1, 0.2, b_3, 0.7, 0.2, 0.5, b_4, 0.5, 0.2, 0.6, b_5, 0.7, 0.3, 0.2 \}$.
- $P(\text{Colorful}) = \{ b_1, 0.8, 0.1, 0.4, b_2, 0.4, 0.2, 0.6, b_3, 0.3, 0.6, 0.4, b_4, 0.4, 0.8, 0.5, b_5, 0.3, 0.5, 0.7 \}$.

. . Definition

For two intuitionistic neutrosophic soft sets (P,A) and (Q,B) over the common universe U . We say that (P,A) is an intuitionistic neutrosophic soft subset of (Q,B) if and only if (i) $A \subseteq B$.

(ii) $P(e)$ is an intuitionistic neutrosophic subset of $Q(e)$.

$$T_{P(e)}(x) \leq T_{Q(e)}(x), I_{P(e)}(x) \leq I_{Q(e)}(x), F_{P(e)}(x) \leq F_{Q(e)}(x)$$

$$F_{Q(e)}(x), \forall e \in A, x \in U.$$

We denote this relationship by $(P,A) \subseteq (Q,B)$.

(P,A) is said to be intuitionistic neutrosophic soft super set of (Q,B) if (Q,B) is an intuitionistic neutrosophic soft subset of (P,A) . We denote it by $(P,A) \supseteq (Q,B)$.

. . Definition

Two INSSs (P, A) and (Q, B) over the common universe U are said to be equal if (P,A) is an intuitionistic neutrosophic soft subset of (Q,B) and (Q,B) is an intuitionistic neutrosophic soft subset of (P,A) which can be denoted by $(P,A) = (Q,B)$.

.1 . Definition

Let (P,A) and (Q,B) be two INSSs over the same universe U . Then the union of (P, A) and (Q, B) is denoted by $(P,A) \cup (Q, B)$ and is defined by $(P,A) \cup (Q,B) = (K, C)$, where $C = A \cup B$ and the truth-membership, indeterminacy-membership and falsity-membership of (K, C)

are as follows:

$$T_{K(\varepsilon)}(m) = \begin{cases} T_{P(\varepsilon)}(m), & \text{if } \varepsilon \in A - B, \\ T_{Q(\varepsilon)}(m), & \text{if } \varepsilon \in B - A \\ \max(T_{P(\varepsilon)}(m), T_{Q(\varepsilon)}(m)), & \text{if } \varepsilon \in A \cap B \end{cases}$$

$$I_{K(\varepsilon)}(m) = \begin{cases} I_{P(\varepsilon)}(m), & \text{if } \varepsilon \in A - B, \\ I_{Q(\varepsilon)}(m), & \text{if } \varepsilon \in B - A \\ \min(I_{P(\varepsilon)}(m), I_{Q(\varepsilon)}(m)), & \text{if } \varepsilon \in A \cap B \end{cases}$$

$$F_{K(\varepsilon)}(m) = \begin{cases} F_{P(\varepsilon)}(m), & \text{if } \varepsilon \in A - B, \\ F_{Q(\varepsilon)}(m), & \text{if } \varepsilon \in B - A \\ \min(F_{P(\varepsilon)}(m), F_{Q(\varepsilon)}(m)), & \text{if } \varepsilon \in A \cap B \end{cases} \quad (3)$$

.11. Definition

Let (P,A) and (Q,B) be two INSSs over the same universe U such that $A \cap B \neq \emptyset$. Then the intersection of (P, A) and (Q, B) is denoted by $(P,A) \cap (Q,B)$ and is defined by $(P,A) \cap (Q,B) = (L,C)$, where $C = A \cap B$ and the truth-membership, indeterminacy membership and falsity-membership of (L,C) are related to those of (P,A) and (Q,B) by:

$$T_{L(\varepsilon)}(m) = \begin{cases} T_{P(\varepsilon)}(m), & \text{if } \varepsilon \in A - B, \\ T_{Q(\varepsilon)}(m), & \text{if } \varepsilon \in B - A \\ \min(T_{P(\varepsilon)}(m), T_{Q(\varepsilon)}(m)), & \text{if } \varepsilon \in A \cap B \end{cases}$$

$$I_{L(\varepsilon)}(m) = \begin{cases} I_{P(\varepsilon)}(m), & \text{if } \varepsilon \in A - B, \\ I_{Q(\varepsilon)}(m), & \text{if } \varepsilon \in B - A \\ \min(I_{P(\varepsilon)}(m), I_{Q(\varepsilon)}(m)), & \text{if } \varepsilon \in A \cap B \end{cases}$$

$$F_{L(\varepsilon)}(m) = \begin{cases} F_{P(\varepsilon)}(m), & \text{if } \varepsilon \in A - B, \\ F_{Q(\varepsilon)}(m), & \text{if } \varepsilon \in B - A \\ \max(F_{P(\varepsilon)}(m), F_{Q(\varepsilon)}(m)), & \text{if } \varepsilon \in A \cap B \end{cases} \quad (4)$$

.1 . Definition

Let (P, A) be a soft set. The set $\text{Supp}(P,A) = \{x \in A \mid P(x) \neq \emptyset\}$ is called the support of the soft set (P,A) . A soft set (P, A) is non-null if $\text{Supp}(P, A) \neq \emptyset$.

.1 . Definition 1

A fuzzy subset μ of a ring R is called a fuzzy subring of R (in Rosenfeld's sense), if for all $x, y \in R$ the following requirements are met:

$$\mu(x-y) \geq \min(\mu(x), \mu(y)) \text{ and } \mu(xy) \geq \min(\mu(x), \mu(y)) \quad ()$$

. Intuitionistic Neutrosophic Soft Set over Ring

In this section, we introduce the notions of intuitionistic neutrosophic soft set over ring and intuitionistic

neutrosophic soft subring in Rosenfeld's sense and study some of their properties related to this notions.

Throughout this paper. Let $(R, +, \cdot)$ be a ring. E be a parameter set and let $A \subseteq E$. For the sake of simplicity, we will denote the ring $(R, +, \cdot)$ simply as R .

From now on, R denotes a commutative ring and all intuitionistic neutrosophic soft sets are considered over R .

.1. Definition

Let (\tilde{P}, A) be an intuitionistic neutrosophic soft set. The set $\text{Supp}(\tilde{P}, A) = \{\varepsilon \in A \mid \tilde{P}(\varepsilon) \neq \emptyset\}$ is called the support of the intuitionistic neutrosophic soft set (\tilde{P}, A) . An intuitionistic neutrosophic soft set (\tilde{P}, A) is non-null if $\text{Supp}(\tilde{P}, A) \neq \emptyset$.

. . Definition

A pair (\tilde{P}, A) is called an intuitionistic neutrosophic soft set over ring, where \tilde{P} is a mapping given by

$$\tilde{P}: A \rightarrow ([0,1] \times [0,1] \times [0,1])^R, \tilde{P}(\varepsilon) : R \rightarrow [0,1] \times [0,1] \times [0,1],$$

$$\tilde{P}(\varepsilon) = \{(x, T_{\tilde{P}(\varepsilon)}(x), I_{\tilde{P}(\varepsilon)}(x), F_{\tilde{P}(\varepsilon)}(x)) : x \in R\} \text{ for all } \varepsilon \in A,$$

If for all $x, y \in R$ the following condition hold:

$$(1) \begin{aligned} T_{\tilde{P}(\varepsilon)}(x - y) &\geq T_{\tilde{P}(\varepsilon)}(x) \wedge T_{\tilde{P}(\varepsilon)}(y), \\ F_{\tilde{P}(\varepsilon)}(x - y) &\leq F_{\tilde{P}(\varepsilon)}(x) \vee F_{\tilde{P}(\varepsilon)}(y) \text{ and} \\ I_{\tilde{P}(\varepsilon)}(x - y) &\leq I_{\tilde{P}(\varepsilon)}(x) \vee I_{\tilde{P}(\varepsilon)}(y) \end{aligned} \quad ()$$

$$(2) \begin{aligned} T_{\tilde{P}(\varepsilon)}(xy) &\geq T_{\tilde{P}(\varepsilon)}(x) \wedge T_{\tilde{P}(\varepsilon)}(y), \\ F_{\tilde{P}(\varepsilon)}(xy) &\leq F_{\tilde{P}(\varepsilon)}(x) \vee F_{\tilde{P}(\varepsilon)}(y) \text{ and} \\ I_{\tilde{P}(\varepsilon)}(xy) &\leq I_{\tilde{P}(\varepsilon)}(x) \vee I_{\tilde{P}(\varepsilon)}(y) \end{aligned} \quad (7)$$

. . Definition

For two intuitionistic neutrosophic soft set over ring (\tilde{P}, A) and (\tilde{Q}, B) , we say that (\tilde{P}, A) is an intuitionistic neutrosophic soft subring of (\tilde{Q}, B) and write $(\tilde{P}, A) \subseteq (\tilde{Q}, B)$ if

- (i) $A \subseteq B$
- (ii) for each $x \in R, \varepsilon \in A, T_{\tilde{P}(\varepsilon)}(x) \leq T_{\tilde{Q}(\varepsilon)}(x),$
 $I_{\tilde{P}(\varepsilon)}(x) \geq I_{\tilde{Q}(\varepsilon)}(x), F_{\tilde{P}(\varepsilon)}(x) \geq F_{\tilde{Q}(\varepsilon)}(x) . ()$

. . Definition

Two intuitionist neutrosophic soft set over ring (\tilde{P}, A) and (\tilde{Q}, B) are said to be equal if $(\tilde{P}, A) \subseteq (\tilde{Q}, B)$ and $(\tilde{Q}, B) \subseteq (\tilde{P}, A)$.

. . Theorem

Let (\tilde{P}, A) and (\tilde{Q}, B) be two intuitionistic neutrosophic soft over ring R . if $\tilde{P}(\varepsilon) \leq \tilde{Q}(\varepsilon)$ for all $\varepsilon \in A$ and $A \subseteq B$, then (\tilde{P}, A) is an intuitionistic neutrosophic soft subring of (\tilde{Q}, B) .

Proof The proof is straightforward

. . Definition

The union of two intuitionistic neutrosophic soft set over ring (\tilde{P}, A) and (\tilde{Q}, B) is denoted by $(\tilde{P}, A) \tilde{\cup} (\tilde{Q}, B)$ and is defined by a intuitionistic neutrosophic soft set over ring

$\tilde{H}: A \cup B \rightarrow ([0,1] \times [0,1] \times [0,1])^R$ such that for each $\varepsilon \in A \cup B$.

$$\tilde{H}(\varepsilon) = \begin{cases} \langle x, T_{\tilde{P}(\varepsilon)}(x), I_{\tilde{P}(\varepsilon)}(x), F_{\tilde{P}(\varepsilon)}(x) \rangle & \text{if } \varepsilon \in A - B \\ \langle x, T_{\tilde{Q}(\varepsilon)}(x), I_{\tilde{Q}(\varepsilon)}(x), F_{\tilde{Q}(\varepsilon)}(x) \rangle & \text{if } \varepsilon \in B - A \\ \langle x, T_{\tilde{P}(\varepsilon)}(x) \vee T_{\tilde{Q}(\varepsilon)}(x), I_{\tilde{P}(\varepsilon)}(x) \wedge I_{\tilde{Q}(\varepsilon)}(x), F_{\tilde{P}(\varepsilon)}(x) \wedge F_{\tilde{Q}(\varepsilon)}(x) \rangle, & \text{if } \varepsilon \in A \cap B \end{cases} \quad ()$$

This is denoted by $(\tilde{H}, C) = (\tilde{P}, A) \tilde{\cup} (\tilde{Q}, B)$, where $C = A \cup B$.

. . Theorem

If (\tilde{P}, A) and (\tilde{Q}, B) are two intuitionistic neutrosophic soft set over ring R , then, so are $(\tilde{P}, A) \tilde{\cup} (\tilde{Q}, B)$.

Proof. For any $\varepsilon \in A \cup B$ and $x, y \in R$, we consider the following cases.

Case 1. Let $\varepsilon \in A - B$. Then,

$$\begin{aligned} T_{\tilde{H}(\varepsilon)}(x - y) &= T_{\tilde{P}(\varepsilon)}(x - y) \\ &\geq T_{\tilde{P}(\varepsilon)}(x) \wedge T_{\tilde{P}(\varepsilon)}(y) \\ &= T_{\tilde{H}(\varepsilon)}(x) \wedge T_{\tilde{H}(\varepsilon)}(y), \\ T_{\tilde{H}(\varepsilon)}(xy) &= T_{\tilde{P}(\varepsilon)}(xy) \\ &\geq T_{\tilde{P}(\varepsilon)}(x) \wedge T_{\tilde{P}(\varepsilon)}(y) \\ &= T_{\tilde{H}(\varepsilon)}(x) \wedge T_{\tilde{H}(\varepsilon)}(y), \\ I_{\tilde{H}(\varepsilon)}(x - y) &= I_{\tilde{P}(\varepsilon)}(x - y) \\ &\leq I_{\tilde{P}(\varepsilon)}(x) \vee I_{\tilde{P}(\varepsilon)}(y) \\ &= I_{\tilde{H}(\varepsilon)}(x) \vee I_{\tilde{H}(\varepsilon)}(y), \\ I_{\tilde{H}(\varepsilon)}(xy) &= I_{\tilde{P}(\varepsilon)}(xy) \\ &\leq I_{\tilde{P}(\varepsilon)}(x) \vee I_{\tilde{P}(\varepsilon)}(y) \\ &= I_{\tilde{H}(\varepsilon)}(x) \vee I_{\tilde{H}(\varepsilon)}(y), \\ F_{\tilde{H}(\varepsilon)}(x - y) &= F_{\tilde{P}(\varepsilon)}(x - y) \\ &\leq F_{\tilde{P}(\varepsilon)}(x) \vee F_{\tilde{P}(\varepsilon)}(y) \\ &= F_{\tilde{H}(\varepsilon)}(x) \vee F_{\tilde{H}(\varepsilon)}(y), \\ F_{\tilde{H}(\varepsilon)}(xy) &= F_{\tilde{P}(\varepsilon)}(xy) \\ &\leq F_{\tilde{P}(\varepsilon)}(x) \vee F_{\tilde{P}(\varepsilon)}(y) \\ &= F_{\tilde{H}(\varepsilon)}(x) \vee F_{\tilde{H}(\varepsilon)}(y), \end{aligned}$$

Case . Let if $\varepsilon \in B - A$. Then, analogous to the proof of case 1, we have

$$\begin{aligned} T_{\tilde{H}(\varepsilon)}(x - y) &\geq T_{\tilde{H}(\varepsilon)}(x) \wedge T_{\tilde{H}(\varepsilon)}(y) \\ T_{\tilde{H}(\varepsilon)}(xy) &\geq T_{\tilde{H}(\varepsilon)}(x) \wedge T_{\tilde{H}(\varepsilon)}(y) \\ I_{\tilde{H}(\varepsilon)}(x - y) &\leq I_{\tilde{H}(\varepsilon)}(x) \vee I_{\tilde{H}(\varepsilon)}(y) \\ I_{\tilde{H}(\varepsilon)}(xy) &\leq I_{\tilde{H}(\varepsilon)}(x) \vee I_{\tilde{H}(\varepsilon)}(y) \end{aligned}$$

$$F_{\tilde{H}(\varepsilon)}(x - y) \leq F_{\tilde{H}(\varepsilon)}(x) \vee F_{\tilde{H}(\varepsilon)}(y)$$

$$F_{\tilde{H}(\varepsilon)}(xy) \leq F_{\tilde{H}(\varepsilon)}(x) \vee F_{\tilde{H}(\varepsilon)}(y)$$

Case . Let $\varepsilon \in A \cap B$. In this case the proof is straightforward. thus ,in any cases ,we have

$$T_{\tilde{H}(\varepsilon)}(x - y) \geq T_{\tilde{H}(\varepsilon)}(x) \wedge T_{\tilde{H}(\varepsilon)}(y)$$

$$T_{\tilde{H}(\varepsilon)}(xy) \geq T_{\tilde{H}(\varepsilon)}(x) \wedge T_{\tilde{H}(\varepsilon)}(y)$$

$$I_{\tilde{H}(\varepsilon)}(x - y) \leq I_{\tilde{H}(\varepsilon)}(x) \vee I_{\tilde{H}(\varepsilon)}(y)$$

$$I_{\tilde{H}(\varepsilon)}(xy) \leq I_{\tilde{H}(\varepsilon)}(x) \vee I_{\tilde{H}(\varepsilon)}(y)$$

$$F_{\tilde{H}(\varepsilon)}(x - y) \leq F_{\tilde{H}(\varepsilon)}(x) \vee F_{\tilde{H}(\varepsilon)}(y)$$

$$F_{\tilde{H}(\varepsilon)}(xy) \leq F_{\tilde{H}(\varepsilon)}(x) \vee F_{\tilde{H}(\varepsilon)}(y)$$

Therefore , $(\tilde{P}, A) \tilde{\cup} (\tilde{Q}, B)$ is an intuitionistic neutrosophic soft set over ring

. . Definition

The intersection of two intuitionistic neutrosophic soft set over ring (\tilde{P}, A) and (\tilde{Q}, B) is denoted by $(\tilde{P}, A) \tilde{\cap} (\tilde{Q}, B)$ and is defined by an intuitionistic neutrosophic soft set over ring.

$\tilde{M}: A \cup B \rightarrow ([0, 1] \times [0, 1] \times [0, 1])^R$ such that for each $\varepsilon \in A \cup B$.

$$\tilde{M}(\varepsilon) \begin{cases} < x, T_{\tilde{P}(\varepsilon)}(x), I_{\tilde{P}(\varepsilon)}(x), F_{\tilde{P}(\varepsilon)}(x) > \text{ if } \varepsilon \in A - B \\ < x, T_{\tilde{Q}(\varepsilon)}(x), I_{\tilde{Q}(\varepsilon)}(x), F_{\tilde{Q}(\varepsilon)}(x) > \text{ if } \varepsilon \in B - A \\ < x, T_{\tilde{P}(\varepsilon)}(x) \wedge T_{\tilde{Q}(\varepsilon)}(x), I_{\tilde{P}(\varepsilon)}(x) \wedge I_{\tilde{Q}(\varepsilon)}(x), F_{\tilde{P}(\varepsilon)}(x) \vee F_{\tilde{Q}(\varepsilon)}(x) >, \\ & \text{if } \varepsilon \in A \cap B \end{cases} \quad (1)$$

This is denoted by $(\tilde{M}, C) (\tilde{P}, A) \tilde{\cap} (\tilde{Q}, B)$, where $C = A \cup B$.

. . Theorem

If (\tilde{P}, A) and (\tilde{Q}, B) are two intuitionistic neutrosophic soft set over ring, then , so are $(\tilde{P}, A) \tilde{\cap} (\tilde{Q}, B)$.

Proof. The proof is similar to that of Theorem 3.8.

.1 . Definition

Let (\tilde{P}, A) and (\tilde{Q}, B) be two intuitionistic neutrosophic soft set over ring R. Then , “ (\tilde{P}, A) AND (\tilde{Q}, B) ” is denoted by $(\tilde{P}, A) \tilde{\wedge} (\tilde{Q}, B)$ and is defined by $(\tilde{P}, A) \tilde{\wedge} (\tilde{Q}, B) (\tilde{N}, C)$, where $C = A \times B$ and $\tilde{H}: C \rightarrow ([0, 1]^3 \times [0, 1]^3)^R$ is defined as

$$\tilde{N}(\alpha, \beta) = \tilde{P}(\alpha) \cap \tilde{Q}(\beta), \text{ for all } (\alpha, \beta) \in C.$$

.11. Theorem

If (\tilde{P}, A) and (\tilde{Q}, B) are two intuitionistic neutrosophic soft set over ring R, then , so is $(\tilde{P}, A) \tilde{\wedge} (\tilde{Q}, B)$.

Proof. For all $x, y \in R$ and $(\alpha, \beta) \in A \times B$ we have

$$T_{\tilde{N}(\alpha, \beta)}(x - y) = (T_{\tilde{P}(\alpha)}(x - y) \wedge T_{\tilde{Q}(\beta)}(x - y))$$

$$\geq (T_{\tilde{P}(\alpha)}(x) \wedge T_{\tilde{P}(\alpha)}(y)) \wedge (T_{\tilde{Q}(\beta)}(x) \wedge T_{\tilde{Q}(\beta)}(y))$$

$$(T_{\tilde{P}(\alpha)}(x) \wedge T_{\tilde{Q}(\beta)}(x)) \wedge (T_{\tilde{P}(\alpha)}(y) \wedge T_{\tilde{Q}(\beta)}(y))$$

$$T_{\tilde{N}(\alpha, \beta)}(x) \wedge T_{\tilde{N}(\alpha, \beta)}(y)$$

$$T_{\tilde{N}(\alpha, \beta)}(xy) = (T_{\tilde{P}(\alpha)}(xy) \wedge T_{\tilde{Q}(\beta)}(xy))$$

$$\geq (T_{\tilde{P}(\alpha)}(x) \wedge T_{\tilde{P}(\alpha)}(y)) \wedge (T_{\tilde{Q}(\beta)}(x) \wedge T_{\tilde{Q}(\beta)}(y))$$

$$(T_{\tilde{P}(\alpha)}(x) \wedge T_{\tilde{Q}(\beta)}(x)) \wedge (T_{\tilde{P}(\alpha)}(y) \wedge T_{\tilde{Q}(\beta)}(y))$$

$$T_{\tilde{N}(\alpha, \beta)}(x) \wedge T_{\tilde{N}(\alpha, \beta)}(y)$$

In a similar way ,we have

$$I_{\tilde{N}(\alpha, \beta)}(x - y) \leq I_{\tilde{N}(\alpha, \beta)}(x) \vee I_{\tilde{N}(\alpha, \beta)}(y)$$

$$I_{\tilde{N}(\alpha, \beta)}(xy) \leq I_{\tilde{N}(\alpha, \beta)}(x) \vee I_{\tilde{N}(\alpha, \beta)}(y)$$

$$F_{\tilde{N}(\alpha, \beta)}(x - y) \leq F_{\tilde{N}(\alpha, \beta)}(x) \vee F_{\tilde{N}(\alpha, \beta)}(y)$$

$$F_{\tilde{N}(\alpha, \beta)}(xy) \leq F_{\tilde{N}(\alpha, \beta)}(x) \vee F_{\tilde{N}(\alpha, \beta)}(y)$$

For all $x, y \in R$ and $(\alpha, \beta) \in C$. It follows that $(\tilde{P}, A) \tilde{\cap} (\tilde{Q}, B)$ is an intuitionistic neutrosophic soft set over ring R.

.1 . Definition

Let (\tilde{P}, A) and (\tilde{Q}, B) be two intuitionistic neutrosophic soft set over ring R. Then , “ (\tilde{P}, A) OR (\tilde{Q}, B) ” is denoted by $(\tilde{P}, A) \tilde{\vee} (\tilde{Q}, B)$ and is defined by $(\tilde{P}, A) \tilde{\vee} (\tilde{Q}, B) (\tilde{O}, C)$, where $C = A \times B$ and $\tilde{O}: C \rightarrow ([0, 1]^3 \times [0, 1]^3)^R$ is defined as

$$\tilde{O}(\alpha, \beta) = \tilde{P}(\alpha) \tilde{\cup} \tilde{Q}(\beta), \text{ for all } (\alpha, \beta) \in C.$$

.1 . Theorem

If (\tilde{P}, A) and (\tilde{Q}, B) are two intuitionist neutrosophic soft set over ring R, then , so are $(\tilde{P}, A) \tilde{\vee} (\tilde{Q}, B)$.

Proof. The proof is straightforward.

The following theorem is a generalization of previous results.

.1 . Theorem

Let (\tilde{P}, A) be an intuitionist neutrosophic soft set over ring R, and let $\{(\tilde{P}_i, A_i)\}_{i \in I}$ be a nonempty family of intuitionistic neutrosophic soft set over ring, where I is an index set .Then , one has the following:

(1) $\bigwedge_{i \in I} (\tilde{P}_i, A_i)$ is an intuitionistic neutrosophic soft set over ring R.

(2) if $A_i \cap A_j = \emptyset$, for all $i, j \in I$, then $\bigvee_{i \in I} (\tilde{P}_i, A_i)$ is an intuitionistic neutrosophic soft set over ring R.

.1 . Definition

Let (\tilde{P}, A) and (\tilde{Q}, B) be two intuitionistic neutrosophic

soft set over ring R. Then ,the product of (\tilde{P},A) and (\tilde{Q},B) is defined to be the intuitionistic neutrosophic soft set over ring $(\tilde{P} \circ \tilde{Q}, C)$,where $C = A \cup B$ and

$$T_{(\tilde{P} \circ \tilde{Q})(\varepsilon)}(x) \begin{cases} T_{\tilde{P}(\varepsilon)}(x) \text{ if } \varepsilon \in A - B \\ T_{\tilde{Q}(\varepsilon)}(x) \text{ if } \varepsilon \in B - A \\ \bigvee_{x=ab} \{T_{\tilde{P}(\varepsilon)}(a) \wedge T_{\tilde{Q}(\varepsilon)}(b)\} \text{ if } \varepsilon \in A \cap B \end{cases} \quad (11)$$

$$I_{(\tilde{P} \circ \tilde{Q})(\varepsilon)}(x) \begin{cases} I_{\tilde{P}(\varepsilon)}(x) \text{ if } \varepsilon \in A - B \\ I_{\tilde{Q}(\varepsilon)}(x) \text{ if } \varepsilon \in B - A \\ \bigwedge_{x=ab} \{I_{\tilde{P}(\varepsilon)}(a) \vee I_{\tilde{Q}(\varepsilon)}(b)\} \text{ if } \varepsilon \in A \cap B \end{cases}$$

$$F_{(\tilde{P} \circ \tilde{Q})(\varepsilon)}(x) \begin{cases} F_{\tilde{P}(\varepsilon)}(x) \text{ if } \varepsilon \in A - B \\ F_{\tilde{Q}(\varepsilon)}(x) \text{ if } \varepsilon \in B - A \\ \bigwedge_{x=ab} \{F_{\tilde{P}(\varepsilon)}(a) \vee F_{\tilde{Q}(\varepsilon)}(b)\} \text{ if } \varepsilon \in A \cap B, a, b \in R \end{cases}$$

For all $\varepsilon \in C$ and $a, b \in R$. This is denoted by $(\tilde{P} \circ \tilde{Q}, C)$ $(\tilde{P},A) \circ (\tilde{Q},B)$.

.1 . Theorem

If (\tilde{P},A) and (\tilde{Q},B) are two intuitionistic neutrosophic soft set over ring R. Then , so is $(\tilde{P},A) \circ (\tilde{Q},B)$.

Proof. Let (\tilde{P},A) and (\tilde{Q},B) be two intuitionistic neutrosophic soft set over ring R. Then ,for any $\varepsilon \in A \cup B$,and $x, y \in R$, we consider the following cases.

Case 1. Let $\varepsilon \in A - B$. Then,

$$T_{(\tilde{P} \circ \tilde{Q})(\varepsilon)}(x - y) = T_{\tilde{P}(\varepsilon)}(x - y) \geq T_{\tilde{P}(\varepsilon)}(x) \wedge T_{\tilde{P}(\varepsilon)}(y) = T_{(\tilde{P} \circ \tilde{Q})(\varepsilon)}(x) \wedge T_{(\tilde{P} \circ \tilde{Q})(\varepsilon)}(y),$$

$$T_{(\tilde{P} \circ \tilde{Q})(\varepsilon)}(xy) = T_{\tilde{P}(\varepsilon)}(xy) \geq T_{\tilde{P}(\varepsilon)}(x) \wedge T_{\tilde{P}(\varepsilon)}(y) = T_{(\tilde{P} \circ \tilde{Q})(\varepsilon)}(x) \wedge T_{(\tilde{P} \circ \tilde{Q})(\varepsilon)}(y)$$

$$I_{(\tilde{P} \circ \tilde{Q})(\varepsilon)}(x - y) = I_{\tilde{P}(\varepsilon)}(x - y) \leq I_{\tilde{P}(\varepsilon)}(x) \vee I_{\tilde{P}(\varepsilon)}(y) = I_{(\tilde{P} \circ \tilde{Q})(\varepsilon)}(x) \vee I_{(\tilde{P} \circ \tilde{Q})(\varepsilon)}(y),$$

$$I_{(\tilde{P} \circ \tilde{Q})(\varepsilon)}(xy) = I_{\tilde{P}(\varepsilon)}(xy) \leq I_{\tilde{P}(\varepsilon)}(x) \vee I_{\tilde{P}(\varepsilon)}(y) = I_{(\tilde{P} \circ \tilde{Q})(\varepsilon)}(x) \vee I_{(\tilde{P} \circ \tilde{Q})(\varepsilon)}(y)$$

$$F_{(\tilde{P} \circ \tilde{Q})(\varepsilon)}(x - y) = F_{\tilde{P}(\varepsilon)}(x - y) \leq F_{\tilde{P}(\varepsilon)}(x) \vee F_{\tilde{P}(\varepsilon)}(y) = F_{(\tilde{P} \circ \tilde{Q})(\varepsilon)}(x) \vee F_{(\tilde{P} \circ \tilde{Q})(\varepsilon)}(y),$$

$$F_{(\tilde{P} \circ \tilde{Q})(\varepsilon)}(xy) = F_{\tilde{P}(\varepsilon)}(xy) \leq F_{\tilde{P}(\varepsilon)}(x) \vee F_{\tilde{P}(\varepsilon)}(y) = F_{(\tilde{P} \circ \tilde{Q})(\varepsilon)}(x) \vee F_{(\tilde{P} \circ \tilde{Q})(\varepsilon)}(y)$$

Case . Let $\varepsilon \in B - A$. Then, analogous to the proof of case 1,the proof is straightforward.

Case . Let $\varepsilon \in A \cap B$. Then,

$$T_{(\tilde{P} \circ \tilde{Q})(\varepsilon)}(x) = \bigvee_{x=ab} (T_{\tilde{P}(\varepsilon)}(a) \wedge T_{\tilde{Q}(\varepsilon)}(b))$$

$$\begin{aligned} &\geq \bigvee_{xy=aby} (T_{\tilde{P}(\varepsilon)}(a) \wedge T_{\tilde{Q}(\varepsilon)}(by)) \\ &\geq \bigvee_{xy=cd} (T_{\tilde{P}(\varepsilon)}(c) \wedge T_{\tilde{Q}(\varepsilon)}(d)) \\ &= T_{(\tilde{P} \circ \tilde{Q})(\varepsilon)}(xy) \end{aligned}$$

Similarly ,we have $T_{(\tilde{P} \circ \tilde{Q})(\varepsilon)}(xy) \geq T_{(\tilde{P} \circ \tilde{Q})(\varepsilon)}(y)$, and so

$$T_{(\tilde{P} \circ \tilde{Q})(\varepsilon)}(xy) \geq T_{(\tilde{P} \circ \tilde{Q})(\varepsilon)}(x) \wedge T_{(\tilde{P} \circ \tilde{Q})(\varepsilon)}(y)$$

In a similar way , we prove that

$$I_{(\tilde{P} \circ \tilde{Q})(\varepsilon)}(xy) \leq I_{(\tilde{P} \circ \tilde{Q})(\varepsilon)}(x) \vee I_{(\tilde{P} \circ \tilde{Q})(\varepsilon)}(y)$$

$$\text{and } F_{(\tilde{P} \circ \tilde{Q})(\varepsilon)}(xy) \leq F_{(\tilde{P} \circ \tilde{Q})(\varepsilon)}(x) \vee F_{(\tilde{P} \circ \tilde{Q})(\varepsilon)}(y)$$

Therefore $(\tilde{P},A) \circ (\tilde{Q},B)$ is an intuitionistic neutrosophic soft set over ring R.

. Conclusion

In this paper we have introduced the concept of intuitionistic neutrosophic soft set over ring (INSSOR for short). We also studied and discussed some properties related to this concept. The definitions of intersection, union, AND, and OR operations over ring (INSSOR) have also been defined. we have defined the product of two intuitionistic neutrosophic soft set over ring. Finally, it is hoped that this concept will be useful for the researchers to further promote and advance the research in neutrosophic soft set theory.

REFERENCES

- [1] L.A.Zadeh," Fuzzy sets". Information and Control.(1965), 8: pp.338-353.
- [2] K. Atanassov," Intuitionistic fuzzy sets". Fuzzy Sets and Systems.(1986), 20, pp.87-96.
- [3] Turksen, "Interval valued fuzzy sets based on normal forms". Fuzzy Sets and Systems, 20,(1968), pp.191-210.
- [4] F.Smarandache ,"A Unifying Field in Logics. Neutrosophy: Neutrosophic Probability, Set and Logic". Rehoboth: American Research Press,(1998).
- [5] M.Arora, R.Biswas,U.S.Pandy, "Neutrosophic Relational Database Decomposition", International Journal of Advanced Computer Science and Applications, Vol. 2, No. 8, (2011), pp.121-125.
- [6] M. Arora and R. Biswas," Deployment of Neutrosophic technology to retrieve answers for queries posed in natural language", in 3rdInternational Conference on Computer Science and Information Technology ICCSIT, IEEE catalog Number CFP1057E-art,Vol.3, ISBN: 978-1-4244-5540-9,(20 10), pp. 435-439.

- [7] Ansari, Biswas, Aggarwal, "Proposal for Applicability of Neutrosophic Set Theory in Medical AI", International Journal of Computer Applications (0975 – 8887), Vo 27–No.5, (2011), pp:5-11
- [8] A. Kharal, "A Neutrosophic Multicriteria Decision Making Method ", New Mathematics & Natural Computation, to appear in Nov 2013.
- [9] F.G Lupi ez, On neutrosophic topology , Kybernetes, Vol. 37 Iss: 6,(2008), pp.797 - 800 ,Doi:10.1108/03684920810876990.
- [10] S. Aggarwal, R. Biswas, A.Q.Ansari, " Neutrosophic Modeling and Control", 978-1-4244-9034-/10/ 26.00 2010 IEEE, pp.718-723.
- [11] M. Bhowmik and M. Pal , " Intuitionistic Neutrosophic Set", ISSN 1746-7659, England, UK, Journal of Information and Computing Science, Vol. 4, No. 2, (2009), pp. 142-152.
- [12] M. Bhowmik and M. Pal , " Intuitionistic Neutrosophic Set Relations and Some of Its Properties , ISSN 1746-7659, England, UK, Journal of Information and Computing Science, Vol. 5, No. 3, (2010), pp. 183-192
- [13] A. A. Salama, S.A.Ablowi, "Generalized Neutrosophic Set and Generalized Neutrosophic Topological Spaces" , Computer Science and Engineering, p-ISSN: 2163-1484 e-ISSN: 2163-1492 DOI: 10.5923/j.computer.20120207.01,2(7), 2012), pp. 129-132
- [14] Wang, H., Smarandache, F., Zhang, Y. Q., Sunderraman, R, "Single valued neutrosophic sets". Multispace and Multistructure, 4,(2010) , pp. 410–413.
- [15] D. A. Molodtsov, "Soft Set Theory - First Result", Computers and Mathematics with Applications, Vol. 37, (1999), pp. 19-31.
- [16] P. K. Maji, R. Biswas and A.R. Roy, "Fuzzy Soft Sets", Journal of Fuzzy Mathematics, Vol 9 , no.3, (2001), pp. 589-602.
- [17] B. Ahmad, and A. Kharal, On Fuzzy Soft Sets, Hindawi Publishing Corporation, Advances in Fuzzy Systems, volume Article ID 586507, (2009), 6 pages doi: 10.1155/2009/586507.
- [18] P. K. Maji, A. R. Roy and R. Biswas, "Fuzzy soft sets" ,Journal of Fuzzy Mathematics. 9 (3),(2001), pp.589-602.
- [19] T. J. Neog and D. K. Sut, "On Fuzzy Soft Complement and Related Properties", Accepted for publication in International Journal of Energy, Information and communications (IJEIC).
- [20] M. Borah, T. J. Neog and D. K. Sut, "A study on some operations of fuzzy soft sets", International Journal of Modern Engineering Research (IJMER), Vol.2, Issue. 2,(2012), pp. 157-168.
- [21] H. L. Yang, "Notes On Generalized Fuzzy Soft Sets", Journal of Mathematical Research and Exposition, Vol 31, No. 3, (2011), pp.567-570.
- [22] P. Majumdar, S. K. Samanta, "Generalized Fuzzy Soft Sets", Computers and Mathematics with Applications, 59, (2010), pp.1425-1432.
- [23] S. Alkhazaleh, A. R. Salleh, and N. Hassan, "Possibility Fuzzy Soft Set", Advances in Decision Sciences, Vol 2011, Article ID 479756, 18 pages, doi:10.1155/2011/479756.
- [24] P. K. Maji, R. Biswas, A. R. Roy, "Intuitionistic fuzzy soft sets", The journal of fuzzy mathematics 9(3)(2001), pp.677-692.
- [25] K.V .Babitha and J. J. Sunil, " Generalized Intuitionistic Fuzzy Soft Sets and Its Applications " ,Gen. Math. Notes, ISSN 2219-7184; Copyright ICSRS Publication, (2011), Vol. 7, No. 2, (2011), pp.1-14.
- [26] M.Bashir, A.R. Salleh, and S. Alkhazaleh, " Possibility Intuitionistic Fuzzy Soft Set", Advances in Decision Sciences Volume 2012 (2012), Article ID 404325, 24 pages, doi:10.1155/2012/404325.
- [27] P. K. Maji, " Neutrosophic Soft Set", Annals of Fuzzy Mathematics and Informatics, Vol 5, No. 1, ISSN: 2093-9310 , ISSN: 2287-623.
- [28] S.Broumi and F. Smarandache, "Intuitionistic Neutrosophic Soft Set", Journal of Information and Computing Science, England, UK ,ISSN 1746-7659, Vol. 8, No. 2, (2013), pp.130-140.
- [29] S.Broumi, "Generalized Neutrosophic Soft Set", International Journal of Computer Science, Engineering and Information Technology (JCSEIT), ISSN: 2231-3605, E-ISSN : 2231-3117 ,Vol.3, No.2, (2013), pp.17-30.
- [30] H. Aktas & N. Cagman, "Soft Sets and Soft Groups", Inf. Sci 177 (13) (2007), pp.2726-2735.
- [31] A. Aygunoglu & H. Aygun, "Introduction to Fuzzy Soft Groups", Comput. Math. Appl. 58 (2009), pp. 1279-1286.
- [32] A. Rosenfeld, "Fuzzy Groups", J. Math. Anal. Appl. 35 (1971), pp.512-517.
- [33] A. Sezgin & A.O. Atagun, "Soft Groups and Normalistic Soft Groups", Computers and Mathematics with Applications 62 (2011), pp.685-698.
- [34] U. Acar, F. Koyuncu & B. Tanay, "Soft Sets and Soft Rings", Computers and Mathematics with Applications: doi:10.1016/j.camwa.2010.03.034 (2010).
- [35] J. Ghosh, B. Dinda & T.K. Samanta, "Fuzzy Soft Rings and Fuzzy Soft Ideals", Int. J. P. App. Sc. Tech. 2(2) (2011), pp.66-74.
- [36] E. Inan & M.A. Ozturk, "Fuzzy Soft Rings and Fuzzy Soft Ideals", Neural Computing and Applications: doi: 10.1007/s00521-011-0550-5 (2011).
- [37] B.Varol , "on fuzzy soft ring", Journal of Hyperstructures, IS SN:2251-8436, print:2322-1666 online, 1(2) 2012, pp.1-15.
- [38] J. Zhan, X. Liu, D. Xiang, K. P. Shum, "Soft Related to Fuzzy Set Theory", Hacettepe Journal of Mathematics and Statistics ,Volume 42 (1) (2013), pp.51 – 66.
- [39] G. Selvachandran and A. R. Salleh , "Vague Soft Rings and Vague Soft Ideals", International Journal of Algebra, Vol. 6, 2012, no. 12, pp.557 – 572.
- [40] Z. Zhang, "Intuitionistic Fuzzy Soft Rings", International Journal of Fuzzy Systems, Vol. 14, No. 3, September 2012, pp.420-433.
- [41] WANG, X-P., MO, Z.W., and LIU, W.J., "Fuzzy ideals generated by fuzzy points in semigroups", J. Sichuan Normal Univ., 15, (1992), pp. 17-24

Modified Collatz conjecture or $(3a + 1) + (3b + 1)I$ Conjecture for Neutrosophic Numbers $\langle Z \cup I \rangle$

W.B. Vasantha Kandasamy, K. Ilanthenral, Florentin Smarandache

W.B. Vasantha Kandasamy, K. Ilanthenral, Florentin Smarandache (2016). Modified Collatz conjecture or $(3a+1)+(3b+1)I$ Conjecture for Neutrosophic Numbers $\langle Z \cup I \rangle$. *Neutrosophic Sets and Systems* 14, 44-46

Abstract: In this paper, a modified form of Collatz conjecture for neutrosophic numbers $\langle Z \cup I \rangle$ is defined. We see for any $n \in \langle Z \cup I \rangle$ the related sequence using the formula $(3a + 1) + (3b + 1)I$ converges to any one of the 55 elements mentioned in this paper. Using the akin formula

of Collatz conjecture viz. $(3a - 1) + (3b - 1)I$ the neutrosophic numbers converges to any one of the 55 elements mentioned with appropriate modifications. Thus, it is conjectured that every $n \in \langle Z \cup I \rangle$ has a finite sequence which converges to any one of the 55 elements.

Keywords: Collatz Conjecture, Modified Collatz Conjecture, Neutrosophic Numbers.

1 Introduction

The Collatz conjecture was proposed by Lothar Collatz in 1937. Till date this conjecture remains open. The $3n - 1$ conjecture was proposed by authors [9]. Later in [9] the $3n \pm p$ conjecture; a generalization of Collatz Conjecture was proposed in 2016 [9].

However, to the best of authors knowledge, no one has studied the Collatz Conjecture in the context of neutrosophic numbers $\langle Z \cup I \rangle = \{a + bI \mid a, b \in Z; I^2 = I\}$ where I is the neutrosophic element or indeterminacy introduced by [7]. Several properties about neutrosophic numbers have been studied. In this paper, authors for the first time study Collatz Conjecture for neutrosophic numbers. This paper is organized into three sections.

Section one is introductory. Section two defines / describes Collatz conjecture for neutrosophic numbers. Final section gives conclusions based on this study. Extensive study of Collatz conjecture by researchers can be found in [1-6]. Collatz conjecture or $3n + 1$ conjecture can be described as for any positive integer n perform the following operations.

If n is even divide by 2 and get $\frac{n}{2}$ if $\frac{n}{2}$ is even divide

by 2 and proceed till $\frac{n}{2^i}$ is odd.

If n is odd multiply n by 3 and add 1 to it and find $3n + 1$. Repeat the process (which has been called Half of Triple Plus One or HTPO) indefinitely. The conjecture puts forth the following hypothesis; whatever positive number one starts with one will always eventually reach 1 after a finite number of steps.

Let $n = 3$, the related sequence is $3n + 1, 10, 5, 16, 8, 4, 2, 1$.

Let $n = 11$, the related sequence is $34, 17, 52, 26, 13, 40, 20, 10, 5, 16, 8, 4, 2, 1$.

Let $n = 15$, the related sequence is $15, 46, 23, 70, 35, 106, 53, 160, 80, 40, 20, 10, 5, 16, 8, 4, 2, 1$.

In simple notation of mod 2 this conjecture can be viewed as

$$f(n) = \begin{cases} \frac{n}{2} & \text{if } n \equiv 0 \pmod{2} \\ 3n+1 & \text{if } n \equiv 1 \pmod{2} \end{cases}$$

The total stopping time for very large numbers have been calculated. The $3n - 1$ conjecture is a kin to Collatz conjecture.

Take any positive integer n . If n is even divide by 2 and get $\frac{n}{2}$ if $\frac{n}{2}$ is odd multiply it by 3 and subtract 1 to i.e. $3n - 1$, repeat this process indefinitely, [9] calls this method as Half Or Triple Minus One (HOTMO).

The conjecture state for all positive n , the number will converge to 1 or 5 or 17.

In other words, the $3n - 1$ conjecture can be described as follows.

$$f(n) = \begin{cases} \frac{n}{2} & \text{if } n \equiv 0 \pmod{2} \\ 3n-1 & \text{if } n \equiv 1 \pmod{2} \end{cases}$$

Let $n = 3, 3n - 1 = 8, 4, 2, 1$.

Let $n = 28, 14, 7, 20, 10, 5$.

$n = 17, 50, 25, 74, 37, 110, 55, 164, 82, 41, 122, 61, 182, 91, 272, 136, 68, 34, 17$.

Several interesting features about the $3n - 1$ conjecture is derived and described explicitly in [9].

It is pertinent to keep on record in the Collatz conjecture $3n + 1$ if n is taken as a negative number than using $3n + 1$ for negative values sequence terminate only at -1 or -5 or -17 . Further the $3n - 1$ conjecture for any negative n , the sequence ends only in -1 .

Thus, for using $3n + 1$ any integer positive or negative the sequence terminates at any one of the values $\{-17, -5, -1, 0, 1\}$ and using $3n - 1$ the sequence for any integer n positive or negative terminates at any one of the values $\{-1, 0, 1, 5, 17\}$.

2 Collatz Conjecture for the neutrosophic numbers $\langle Z \cup I \rangle$

In this section, we introduce the modified form of Collatz conjecture in case of neutrosophic numbers $\langle Z \cup I \rangle$ $\{a + bI / a, b \in Z \text{ and } I^2 = I\}$ where I is the neutrosophic element or the indeterminacy introduced by [7]. For more info, please refer to [7].

Now, we will see how elements of $\langle Z \cup I \rangle$ behave when we try to apply the modified form of Collatz conjecture.

The modified formula for Collatz conjecture for neutrosophic numbers $n = a + bI$ is $(3a + 1) + (3b + 1)I$; if $a \neq 0$ then $3bI + I = (3b + 1)I$ is taken if $b = 0$ then $3a + 1$ term is taken, however iteration is taken the same number of times for a and bI in $n = a + bI$.

If $n \in \langle Z \cup I \rangle$ is of the form $n = a$, $a \in Z$ then Collatz conjecture is the same, when $n = aI$, $a \in I$, $I^2 = I$ then also the Collatz conjecture takes the value I ; for we say aI is even if a is even and aI is odd if a is odd.

For $3I, 9I, 27I, 15I, 45I, 19I, 35I, 47I, 105I, 101I, 125I$ are all odd neutrosophic numbers.

Now $12I, 16I, 248I, 256I$ etc. are even neutrosophic numbers.

The working is instead of adding 1 after multiplying with 3 we add I after multiplying with 3.

For instance consider $n = 12I$, the sequence for $n = 12I$ is as follows:

$12I, 6I, 3I, 3 \times 3I + I = 10I, 5I, 16I, 8I, 4I, 2I, I$.

So the element $n = 12I$ has a sequence which terminates at I .

Consider $n = 256I$, the sequence is $256I, 128I, 64I, 32I, 16I, 8I, 4I, 2I, I$ so converges to I .

Take $n = 31I$, $31I$ is odd so the sequence for $n = 31I$ is $31I, 94I, 47I, 142I, 71I, 214I, 107I, 322I, 161I, 484I, 242I, 121I, 364I, 182I, 91I, 274I, 137I, 412I, 206I, 103I, 310I, 155I, 466I, 233I, 700I, 350I, 175I, 526I, 263I, 790I, 385I, 1156I, 578I, 289I, 868I, 434I, 217I, 652I, 326I, 163I, 490I, 245I, 736I, 368I, 184I, 92I, 46I, 23I, 70I, 35I, 106I, 53I, 160I, 80I, 40I, 20I, 10I, 5I, 16I, 8I, 4I, 2I, I$.

Let $n = 45I$ the sequence is $45I, 136I, 68I, 34I, 17I, 52I, 26I, 13I, 40I, 20I, 10I, 5I, 16I, 8I, 4I, 2I, I$.

So if $n \in Z$ then as usual by the Collatz conjecture the sequence converges to 1. If $n \in ZI$ then by applying the Collatz conjecture it converges to I . Now if $x \in \langle Z \cup I \rangle$ that is $x = a + bI$ how does x converge.

We will illustrate this by an example.

Now if $x = a + bI$, $a, b \in Z \setminus \{0\}$; is it even or odd? We cannot define or put the element x to be odd or to be even. Thus to apply Collatz conjecture one is forced to define in a very different way. We apply the Collatz conjecture separately for a and for bI , but maintain the number of iterations to be the same as for that of $a + bI$. We will illustrate this situation by some examples.

Consider $n = 3I + 14 \in \langle Z \cup I \rangle$. n is neither odd nor even. We use $(3a + 1) + (3b + 1)I$ formula in the following way

$3I + 14, 10I + 7, 5I + 22, 16I + 11, 8I + 34, 4I + 17, 2I + 52, I + 26, 4I + 13, 2I + 40, I + 20, 4I + 10, 2I + 5, I + 16, 4I + 8, 2I + 4, I + 2, 4I + 1, 2I + 4, I + 2, 4I + 1, I + 4, I + 2$.

So the sequence terminates at $I + 2$.

Consider $n = 3I - 14 \in \langle Z \cup I \rangle$, n is neither even nor odd.

The sequence for this n is as follows.

$3I - 14, 10I - 7, 5I - 20, 16I - 10, 8I - 5, 4I - 14, 2I - 7, I - 20, 4I - 10, 2I - 5, I - 14, 4I - 7, 2I - 20, I - 10, 4I - 5, 2I - 14, I - 7, 4I - 20, 2I - 10, I - 5, 4I - 14, 2I - 7, I - 20, 4I - 10, 2I - 5, \dots, I - 5$.

So for $n = 3I - 14$ the sequence converges to $2I - 5$.

Consider $n = -5I - 34$; $-5I - 34, -14I - 17, -7I - 50, -20I - 25, -10I - 74, -5I - 37, -14I - 110, -7I - 55, -20I - 164, -10I - 82, -5I - 41, -14I - 122, -7I - 61, -20I - 182, -10I - 91, -5I - 272, -14I - 136, -7I - 68, -20I - 34, -10I - 17, -5I - 50, -14I - 25, -7I - 74, -20I - 37, -10I - 110, -5I - 55, -14I - 164, -7I - 82, -20I - 41, -10I - 122, -5I - 61, -14I - 182, -7I - 91, -20I - 272, -10I - 136, -5I - 68, -14I - 34, -7I - 17, -20I - 136, -5I - 68, -14I - 34, -7I - 17, -20I - 50, -10I - 25, -5I - 74, -14I - 37, -7I - 110, -20I - 55, -10I - 164, -5I - 82, -14I - 41, -7I - 122, -20I - 61, -10I - 182, -5I - 91, -14I - 272, -7I - 136, -20I - 68, -10I - 34, -5I - 17. (1)$

$n = -5I - 34$, converges to $-5I - 17$.

Let $n = -10I - 17, -5I - 50, -14I - 25, -7I - 74, -20I - 37, -10I - 110, -5I - 55, -14I - 164, -7I - 82, -20I - 41, -10I - 122, -5I - 61, -14I - 182, -7I - 91, -20I - 272, -10I - 136, -5I - 68, -14I - 34, -7I - 17, -20I - 50, -10I - 25, -5I - 74, -14I - 37, -7I - 110, -20I - 55, -10I - 164, -5I - 82, -14I - 41, 7I - 122, -20I - 61, -10I - 182, -5I - 91, -14I - 272, -7I - 136, -20I - 68, -10I - 34, -5I - 17$.

Thus, by using the modified form of Collatz conjecture for neutrosophic numbers $\langle Z \cup I \rangle$ we get the following collection A of numbers as the limits of finite sequences after performing the above discussed operations using the modified formula $3(a + bI) + 1 + I$ or $(3a + 1) + (3b + 1)I$; $a,$

$b \in \mathbb{Z} \setminus \{0\}$ if $a = 0$ then $(3b + 1)I$ formula and if $b = 0$ then $3a + 1$ formula is used.

$A = \{1, -1, 0, I, -I, 1 + I, -I + 1, -1 + I, -1 - I, -17, -5, -17I, -5I, 1 + 2I, 1 - 2I, -1 - 2I, -1 + 2I, 2 - I, 2 + I, -2 - I, -2 + I, -5 + I, -5 + 2I, -5 - 17I, -5 - I, -5 - 2I, -5I + 1, -5I + 2, -5I - 2, -5I - 1, -5I - 17, -17 - I, -17 + I, -17I + 1, -17I - 1, -17 - 2I, -17 + 2I, -17I + 2, -17I - 2, 1 + 4I, 4I + 1, 4 - I, 4I - 1, -34 - 5I, -17I - 10, -17 - 10I, -34I - 5, -17 - 20I, -17I - 20, -68I - 5, -68 - 5I, -5I + 4, -5 + 4I, -17 + 4I, -17I + 4\}$.

Thus, the modified $3n + 1$ Collatz conjecture for neutrosophic numbers $\langle \mathbb{Z} \cup I \rangle$ is $(3a + 1) + (3b + 1)I$ for $n = a + bI \in \langle \mathbb{Z} \cup I \rangle$, $a, b \in \mathbb{Z} \setminus \{0\}$.

If $a = 0$ then we use the formula $(3b + 1)I$ and if $b = 0$ then use the classical Collatz conjecture formula $3a + 1$. It is conjectured that using $(3a + 1) + (3b + 1)I$ where $a, b \in \mathbb{Z} \setminus \{0\}$ or $3a + 1$ if $b = 0$ or $(3b + 1)I$ if $a = 0$, formula every $n \in \langle \mathbb{Z} \cup I \rangle$ ends after a finite number of iterations to one and only one of the 55 elements from the set A given above. Prove or disprove.

Now the $3n - 1$ conjecture for neutrosophic numbers $\langle \mathbb{Z} \cup I \rangle$ reads as $(3a - 1) + (3bI - I)$ where $n = a + bI$; $a, b \in \mathbb{Z} \setminus \{0\}$; if $a = 0$ then $(3b - 1)I = 3bI - I$ is used instead of $3n - 1$ or $(3a - 1) + (3b - 1)I$.

If $b = 0$ then $3a - 1$ that is formula $3n - 1$ is used.

Now every $n \in \langle \mathbb{Z} \cup I \rangle$ the sequence converges to using the modified $3n - 1$ Collatz conjecture $(3a - 1) + (3b - 1)I$ to one of the elements in the set B ; where

$B = \{1, 0, -1, I, 5I, 5, 17, 17I, -I, 1 + 2I, 1 - 2I, -1 + 2I, -1 - 2I, 1 + I, 1 - 2, 1 + 2, -I - 2, -I + 2, 1 - 1, -I - 1, 5 + I, 5 - I, 5 - 2I, 5 + 2I, -I + 1, 5 + 17I, 17 - I, 17 + I, 17 - 2I, 17 + 2I, 17 + 5I, 5I - 1, 5I - 2, 5I + 1, 5I + 2, 17I - 1, 17I - 2, 17I + 1, 17I + 2, 17 + 10I, 17I + 10, 34 + 5I, 34I + 5, 17 + 20I, 20 + 17I, 68 + 5I, 68I + 5, 5I - 4, 5 - 4I, 17 - 4I, 17I - 4, -4I + 1, -4I - 1, -4 + I, -4 - I\}$.

We will just illustrate how the $(3a - 1) + (3b - 1)I$ formula functions on $\langle \mathbb{Z} \cup I \rangle$.

Consider $12 + 17I \in \langle \mathbb{Z} \cup I \rangle$ the sequence attached to it is $12 + 17I, 6 + 50I, 3 + 25I, 8 + 74I, 4 + 37I, 2 + 110I, 1 + 55I, 2 + 164I, 1 + 82I, 2 + 41I, 1 + 122I, 2 + 61I, 1 + 182I, 2 + 91I, 1 + 272I, 2 + 136I, 1 + 68I, 2 + 34I, 1 + 17I, 2 + 50I, 1 + 25I, 2 + 74I, 1 + 37I, 2 + 110I, 1 + 55I, 2 + 164I, 1 + 82I, 2 + 41I, 1 + 122I, 2 + 61I, 1 + 182I, 2 + 91I, 1 + 272I, 2 + 136I, 1 + 68I, 2 + 34I, 1 + 17I$.

The sequence associated with $12 + 17I$ terminates at $1 + 17I$.

Thus, it is conjectured that every $n \in \langle \mathbb{Z} \cup I \rangle$ using the modified Collatz conjecture $(3a - 1) + (3b - 1)I$; $a, b \in \mathbb{Z} \setminus \{0\}$ or $3a - 1$ if $b = 0$ or $(3b + 1)I$ if $a = 0$, has a finite sequence which terminates at only one of the elements from the set B .

3 Conclusions

In this paper, the modified form of $3n \pm 1$ Collatz conjecture for neutrosophic numbers $\langle \mathbb{Z} \cup I \rangle$ is defined and described. It is defined analogously as $(3a \pm 1) + (3b \pm 1)I$ where $a + bI \in \langle \mathbb{Z} \cup I \rangle$ with $a \neq 0$ and $b \neq 0$.

If $a = 0$ the formula reduces to $(3b \pm 1)I$ and if $b = 0$ the formula reduces to $(3a \pm 1)$.

It is conjectured every $n \in \langle \mathbb{Z} \cup I \rangle$ using the modified form of Collatz conjecture has a finite sequence which terminates at one and only element from the set A or B according as $(3a + 1) + (3b + 1)I$ formula is used or $(3a - 1) + (3b - 1)I$ formula is used respectively. Thus, when a neutrosophic number is used from $\langle \mathbb{Z} \cup I \rangle$ the number of values to which the sequence terminates after a finite number of steps is increased from 5 in case of $3n \pm 1$ Collatz conjecture to 55 when using $(3a \pm 1) + (3b \pm 1)I$ the modified Collatz conjecture.

References

- [1] Stefan Andrei and Cristian Masalagiu. About the Collatz conjecture. *Acta Informatica*, 35(2):167-179, 1998.
- [2] Lynn E Garner. On the Collatz $3n + 1$ algorithm. *Proceedings of the American Mathematical Society*, 82(1):19-22, 1981.
- [3] Michael A Idowu. A novel theoretical framework formulated for information discovery from number system and Collatz conjecture data. *Procedia Computer Science*, 61:105-111, 2015.
- [4] Jeffrey C Lagarias. The $3x + 1$ problem and its generalizations. *The American Mathematical Monthly*, 92(1):3-23, 1985.
- [5] K LaTourette et al. Explorations of the Collatz conjecture. *Moravian College Senior Honours Thesis*, 2007.
- [6] Jean Paul Van Bendegem. The Collatz conjecture. a case study in mathematical problem solving. *Logic and Logical Philosophy*, 14(1):7-23, 2005.
- [7] Florentin Smarandache, Neutrosophic logic - Generalization of Intuitionistic Fuzzy Logic, presented at the special session on Intuitionistic Fuzzy Sets and Related Concepts, of International EUSFLAT Conference, Zittau, Germany, 10-2 September 2003.
- [8] Vasantha Kandasamy and Florentin Smarandache, Basic Neutrosophic Algebraic Structures and their Application to Fuzzy and Neutrosophic Models, Hexis, US, 2004.
- [9] Vasantha Kandasamy, Ilanthenral and Florentin Smarandache, The $3n \pm p$ conjecture: A generalization of Collatz Conjecture, *Journal of Ultra Scientist of Physical Sciences*, 29(2):83 -88, 2017.

Neutrosophic Duplets of $\{Z_{p^n}, \times\}$ and $\{Z_{pq}, \times\}$ and Their Properties

W.B. Vasantha Kandasamy, Ilanthenral Kandasamy, Florentin Smarandache

W.B. Vasantha Kandasamy, Ilanthenral Kandasamy, Florentin Smarandache (2018). Neutrosophic Duplets of $\{Z_{p^n}, \times\}$ and $\{Z_{pq}, \times\}$ and Their Properties. *Symmetry*, 10, 345; DOI: 10.3390/sym10080345

Abstract: The notions of neutrosophy, neutrosophic algebraic structures, neutrosophic duplet and neutrosophic triplet were introduced by Florentin Smarandache. In this paper, the neutrosophic duplets of Z_{p^n} , Z_{pq} and $Z_{p_1 p_2 \dots p_n}$ are studied. In the case of Z_{p^n} and Z_{pq} , the complete characterization of neutrosophic duplets are given. In the case of $Z_{p_1 \dots p_n}$, only the neutrosophic duplets associated with p_i s are provided; $i = 1, 2, \dots, n$. Some open problems related to neutrosophic duplets are proposed.

Keywords: neutrosophic duplets; semigroup; neutrosophic triplet groups

1. Introduction

Real world data, which are predominately uncertain, indeterminate and inconsistent, were represented as neutrosophic set by Smarandache [1]. Neutrosophy deals with the existing neutralities and indeterminacies of the problems. Neutralities in neutrosophic algebraic structures have been studied by several researchers [1–8]. Wang et al. [9] proposed Single-Valued Neutrosophic Set (SVNS) to overcome the difficulty faced in relating neutrosophy to engineering discipline and real world problems. Neutrosophic sets have evolved further as Double Valued Neutrosophic Set (DVNS) [10] and Triple Refined Indeterminate Neutrosophic Set (TRINS) [11]. Neutrosophic sets are useful in dealing with real-world indeterminate data, which Intuitionistic Fuzzy Set (IFS) [12] and Fuzzy sets [13] are incapable of handling accurately [1].

The current trends in neutrosophy and related theories of neutrosophic triplet, related triplet group, neutrosophic duplet, and duplet set was presented by Smarandache [14]. Neutrosophic duplets and neutrosophic triplets have been of interest and many have studied them [15–24]. Neutrosophic duplet semigroup were studied in [19] and the neutrosophic triplet group was introduced in [8]. Neutrosophic duplets and neutrosophic duplet algebraic structures were introduced by Smarandache.

In the case of neutrosophic duplets, we see $ax = a$ and $x = neut(a)$, where, as in L -fuzzy sets [25] as per definition is a mapping from $A : X \rightarrow L$, L may be semigroup or a poset or a lattice or a Boolean σ -ring; however, neutrosophic duplets are not mapping, more so in our paper algebraic properties of them are studied for Z_n for specific values of n . However, in the case of all structures, the semigroup or lattice or Boolean σ -ring or a poset, there are elements which are neutrosophic duplets. Here, we mainly analyze neutrosophic duplets in the case of Z_n only number theoretically.

In this paper, we investigate the neutrosophic duplets of $\{Z_{p^n}, \times\}$, where p is a prime (odd or even) and $n \geq 2$. Similarly, neutrosophic duplets in the case of Z_{pq} and $Z_{p_1 p_2 \dots p_n}$ are studied. It is noted that the major difference between the neutrals of neutrosophic triplets and that of neutrosophic duplets is that in the former case they are idempotents and in the latter case they are units. Idempotents in the neutrosophic duplets are called trivial neutrosophic duplets.

This paper is organized as five sections, Section 1 is introductory in nature and Section 2 provides the important results of this paper. Neutrosophic duplets in the case of Z_{p^n} ; p an odd prime are studied

in Section 3. In Section 4, neutrosophic duplets of Z_{pq} and $Z_{p_1 p_2 \dots p_n}$, and their properties are analyzed. Section 5 discusses the conclusions, probable applications and proposes some open problems.

2. Results

The basic definition of neutrosophic duplet is recalled from [8].

Consider U to be the universe of discourse, and D a set in U , which has a well-defined law $\#$.

Definition 1. Consider $\langle a, neut(a) \rangle$, where a , and $neut(a)$ belong to D . It is said to be a neutrosophic duplet if it satisfies the following conditions:

1. $neut(a)$ is not the same as the unitary element of D in relation with the law $\#$ (if any);
2. $a \# neut(a) = neut(a) \# a = a$; and
3. $anti(a) \notin D$ for which $a \# anti(a) = anti(a) \# a = neut(a)$.

Here, the neutrosophic duplets of $\{Z_{p^n}, \times\}$, p is a prime (odd or even) and $n \geq 2$ are analyzed number theoretically. Similarly, neutrosophic duplets in the case of Z_{pq} and $Z_{p_1 p_2 \dots p_n}$ are studied in this paper.

The results proved by this study are:

1. The neutrals of all nontrivial neutrosophic duplets are units of $\{Z_{p^n}, \times\}$, $\{Z_{pq}, \times\}$ and $\{Z_{p_1 p_2 \dots p_n}, \times\}$.
2. If p is a prime in anyone of the semigroups ($\{Z_{p^n}, \times\}$ or $\{Z_{pq}, \times\}$ or $\{Z_{p_1 p_2 \dots p_n}, \times\}$) as mentioned in 1, then mp has only p number of neutrals, for the appropriate m .
3. The neutrals of any mp^t for a prime p ; $(m, p) = 1$ are obtained and they form a special collection.

3. Neutrosophic Duplets of $\{Z_{p^n}, \times\}$ and its Properties

Neutrosophic duplets and neutrosophic duplet algebraic structures were introduced by Florentin Smarandache in 2016. Here, we investigate neutrosophic duplets of $\{Z_{p^n}, \times\}$, where p is a prime (odd or even) and $n \geq 2$. First, neutrosophic duplets in the case of Z_{2^4} and Z_{3^3} and their associated number theoretic properties are explored to provide a better understanding of the theorems proved. Then, several number theoretical properties are derived.

Example 1. Let $S = \{Z_{16}, \times\}$ be the semigroup under \times modulo 16. Z_{16} has no idempotents. The units of Z_{16} are $\{1, 3, 5, 7, 9, 11, 13, 15\}$. The elements which contribute to the neutrosophic duplets are $\{2, 4, 6, 8, 10, 12, 14\}$. The neutrosophic duplet sets under usual product modulo 16 are:

$$\begin{aligned} & \{\{2, 1\}, \{2, 9\}\}, \{\{4, 1\}, \{4, 5\}, \{4, 9\}, \{4, 13\}\}, \\ & \{\{6, 1\}, \{6, 9\}\}, \{\{8, 1\}, \{8, 3\}, \{8, 5\}, \{8, 7\}, \{8, 9\}, \{8, 11\}, \{8, 13\}, \{8, 15\}\}, \\ & \{\{10, 1\}, \{10, 9\}\}, \{\{12, 1\}, \{12, 5\}, \{12, 9\}, \{12, 13\}\}, \{\{14, 1\}, \{14, 9\}\} \end{aligned}$$

The observations made from this example are:

1. Every non-unit of Z_{16} is a neutrosophic duplet.
2. Every non-unit divisible by 2, viz. $\{2, 6, 10, 14\}$, has only $\{1, 9\}$ as their neutrals.
3. Every non-unit divisible by 4 are 4 and 12, which has $\{1, 5, 9, 13\}$ as neutrals.

The biggest number which divides 16 is 8 and all units act as neutrals in forming neutrosophic duplets. Thus, $A = \{1, 3, 5, 7, 9, 11, 13, 15\}$, which forms a group of order 8, yields the 8 neutrosophic duplets; $8 \times i = 8$ for all $i \in A$ and A forms a group under multiplication modulo 16; and $\{1, 9\}$ and $\{1, 5, 9, 13\}$ are subgroups of A .

In view of this, we have the following theorem.

Theorem 1. Let $S = \{Z_{2^n}, \times\}$, be the semigroup under product modulo 2^n , $n \geq 2$.

- (i) The set of units of S are $A = \{1, 3, 5, \dots, 2^n - 1\}$, forms a group under \times and $|A| = 2^{n-1}$.
- (ii) The set of all neutrosophic duplets with 2^{n-1} is A ; neutrals of 2^{n-1} are A .
- (iii) All elements of the form $2m \in Z_{2^n}$ (m an odd number) has only the elements $\{1, 2^{n-1} + 1\}$ to contribute to neutrosophic duplets (neutrals are $1, 2^{n-1} + 1$).
- (iv) All elements of the form $m2^t \in Z_{2^n}; 1 < t < n - 1; m$ odd has its neutrals from $B = \{1, 2^{n-t} + 1, 2^{n-t+1} + 1, 2^{n-t+2} + 1, \dots, 2^{n-1} + 1, 2^{n-t} + 2^{n-t+1} + 1, \dots, 2^{n-t} + 2^{n-1} + 1, \dots, 1 + 2^{n-t} + 2^{n-t+1} + \dots + 2^{n-1}\}$.

Proof.

- (i) Given $S = \{Z_{2^n}, \times\}$ where $n \geq 2$ and S is a semigroup under product modulo 2^n . $A = \{1, 3, 5, 7, \dots, 2^n - 1\}$ is a group under product as every element is a unit in S and closure axiom is true by property of modulo integers and $|A| = 2^{n-1}$. Hence, Claim (i) is true.
- (ii) Now, consider the element 2^{n-1} ; the set of duplets for 2^{n-1} is A for $2^{n-1} \times 1 = 2^{n-1}; 2^{n-1} \times 3 = 2^{n-1}[2 + 1] = 2^n + 2^{n-1} = 2^{n-1}, \dots, 2^{n-1}(m); (m$ is odd) will give only $m2^{n-1}$. Hence, this proves Claim (ii).
- (iii) Consider $2m \in Z_{2^n}$; we see $2m \times 1 = 2m$ and $2m(2^{n-1} + 1) = m2^n + 2m = 2m$. $(2m, 2^{n-1} + 1)$ is a neutrosophic duplet pair; hence, the claim.
- (iv) Let $m2^t \in Z_{2^n}$; clearly, $m2^t \times x = m2^t$ for all $x \in B$.
□

Next, we proceed onto describe the duplet pairs in $S = \{Z_{3^3}, \times\}$.

Example 2. Let $S = \{Z_{3^3}, \times\}$ be a semigroup under product modulo 3^3 . The units of S are $A = \{1, 2, 4, 5, 7, 8, 10, 11, 13, 14, 16, 17, 19, 20, 22, 23, 25, 26\}$. Clearly, A forms a group under a product. The non-units of S are $\{3, 6, 9, 12, 15, 18, 21, 24\}$. Zero can be included for $0 \times x = 0$ for all $x \in S$, in particular for $x \in A$. The duplet pairs related to 3 are $B_1 = \{\{3, 1\}, \{3, 10\}, \{3, 19\}\}$. The duplet pairs related to 6 are $B_2 = \{\{6, 1\}, \{6, 10\}, \{6, 19\}\}$. The duplet pairs related to 9 are

$$B_3 = \{\{9, 1\}, \{9, 4\}, \{9, 7\}, \{9, 13\}, \{9, 10\}, \{9, 16\}, \{9, 19\}, \{9, 22\}, \{9, 25\}\}.$$

The neutrosophic duplets of 12 are $B_4 = \{\{12, 1\}, \{12, 10\}, \{12, 19\}\}$. The neutrosophic duplets of 15 are $B_5 = \{\{15, 1\}, \{15, 10\}, \{15, 19\}\}$. Finally, the neutrosophic duplets of 18 are

$$B_6 = \{\{18, 1\}, \{18, 4\}, \{18, 7\}, \{18, 13\}, \{18, 10\}, \{18, 16\}, \{18, 19\}, \{18, 22\}, \{18, 25\}\}.$$

The neutrosophic duplets associated with 21 are $B_7 = \{\{21, 1\}, \{21, 10\}, \{21, 19\}\}$ and 24 are $B_8 = \{\{24, 1\}, \{24, 10\}, \{24, 19\}\}$. Now, the trivial duplet of 0, which we take is

$$B_0 = \{\{0, 1\}, \{0, 4\}, \{0, 7\}, \{0, 13\}, \{0, 10\}, \{0, 16\}, \{0, 19\}, \{0, 22\}, \{0, 25\}\}.$$

We see $L = \{B_0 \cup B_1 \cup B_2 \cup \dots \cup B_8\}$ forms a semigroup under product modulo 27 and $o(L) = 45$.

We have the following result.

Theorem 2. Let $S = \{Z_{p^n}, \times\}$, where p is an odd prime, $n \geq 2$ is a semigroup under \times , and product modulo is p^n . The units of S are denoted by A and non-units of S are denoted by B . The neutrosophic duplets of S associated with B are groups under product and are subgroups of A . The neutrals of $tp^s = b \in B$ are of the form $D = \{1, 1 + p^{n-s}, 1 + p^{n-s+1}, 1 + p^{n-s+2}, \dots, 1 + p^{n-1}, 1 + p^{n-s} + p^{n-s+1}, 1 + p^{n-s} + p^{n-s+2}, \dots, 1 + p^{n-1} + p^{n-s}, \dots, 1 + p^{n-s} + \dots + p^{n-1}\}; 1 \leq t < m, p/m; 1 < s < n$.

Proof. Let $tp^s \in Z_{p^n}$ all elements which act as neutrosophic duplets for tp^s are from the set D . For any $x \in D$ and $tp^s \in Z_{p^n}$, we see $xtp^s = tp^s$; hence, the claim. □

It is important to note that $S = \{Z_{p^n}, \times\}$ has no non-trivial neutrosophic triplets as Z_{p^n} has no non-trivial idempotents.

Next, we proceed to finding the neutrosophic duplets of Z_{pq} ; p and q are distinct primes.

4. Neutrosophic Duplets of Z_{pq} and $Z_{p_1 p_2 \dots p_n}$

In this section, we study the neutrosophic duplets of Z_{pq} where p and q are primes. Further, we see Z_{pq} also has neutrosophic triplets. The neutrosophic triplets in the case of Z_{pq} have already been characterized in [23]. We find the neutrosophic duplets of Z_{2p} , p a prime. We find the neutrosophic duplets and neutrosophic triplets groups of Z_{26} in the following.

Example 3. Let $S = \{Z_{26}, \times\}$ be the semigroup under product modulo 26. The idempotents of S are 13 and 14. We see 13 is just a trivial neutrosophic triplet, however only 14 contributes to non-trivial neutrosophic triplets. We now find the neutrosophic duplets of Z_{26} . The units of Z_{26} are $A = \{1, 3, 5, 7, 9, 11, 15, 17, 19, 21, 23, 25\}$ and they act as neutrals of the duplets. The non-units which contribute for neutrosophic duplets are $B = \{2, 4, 6, 8, 10, 12, 13, 14, 16, 18, 20, 22, 24\}$. 0 is the trivial duplet as $0 \times x = 0$ for all $x \in A$. Consider $2 \in B$ the pairs of duplets are $\{2, 1\}$, $2 \times 14 = 2$ but 14 cannot be taken as $\text{anti}(2) = 20$ and $\text{anti}(2)$ exists so 2 is not a neutrosophic duplet for $(2, 14, 20)$ is a neutrosophic triplet group.

Consider $4 \in B$; $\{4, 1\}$ is a trivial neutrosophic duplet. Then, $4 \times 14 = 4$ and $(4, 14, 16)$ are again a neutrosophic triplet as $\text{anti}(4) = 16$ so 4 is not a neutrosophic duplet. Thus, 16 and 20 are also not neutrosophic duplets. Consider $6 \in B$; we see $\{6, 1\}$ is a non-trivial neutrosophic duplet. In addition, $(6, 14, 10)$ are neutrosophic triplet groups so 6 and 10 are not non-trivial neutrosophic duplets. Consider $8 \in B$, $(8, 14, 18)$ is a neutrosophic triplet group. hence 8 and 18 are not neutrosophic duplets. Then, $(12, 14, 12)$ is also a neutrosophic triplet group. Thus, 12 is not a neutrosophic duplet. Let $22 \in B$ be such that $(22, 14, 24)$ is a neutrosophic triplet group, hence 22 and 24 are not neutrosophic duplets.

Consider $13 \in B$; we see the neutrals are $\{1, 3, 5, 7, 9, 11, 15, 17, 19, 21, 23, 25\}$. We see the collection of neutrosophic duplets associated with $13 \in Z_{26}$ happens to yield a semigroup under product if 13 is taken as the trivial neutrosophic duplets, as it is an idempotent in Z_{26} , and, in all pairs, it is treated as semigroup of order 13, where $(13, 1)$ and $(13, 13)$ are trivial neutrosophic duplets.

In view of this, we have the following theorem.

Theorem 3. Let $S = \{Z_{2p}, \times\}$ be a semigroup under product modulo $2p$; p an odd prime. This S has only p and $p + 1$ to be the idempotents and only p contributes for a neutrosophic duplet collection with all units of Z_{2p} and the collection $B = \{(p, x) | x \in Z_{2p}\}$, x is a unit in Z_{2p} forms a commutative semigroup of order p which includes 1 and p which result in the trivial duplets pair $(p, 1)$ and (p, p) .

Proof. Given $S = \{Z_{2p}, \times\}$ is a semigroup under \times and p is an odd prime. We see from [23] p and $p + 1$ are idempotents of Z_{2p} . It is proven in [23] that $p + 1$ acts for the neutrosophic triplet group of Z_{2p} (formed by elements $2, 4, 6, \dots, 2p - 2$) as the only neutral. (p, p, p) is a trivial neutrosophic triplet. However, Z_{2p} has no neutrosophic duplet other than those related with p alone and $p \times x = p$ for all x belonging to the collection of all units of Z_{2p} including 1. If x is a unit in Z_{2p} , two things are essential: x is odd and $x \neq p$. Since x is odd, we see $x = 2y + 1$ and $p(x) = p(2y + 1) = 2yp + p = p$, hence (p, x) is a neutrosophic duplet. The units of Z_{2p} are $(p - 1)$ in number. Further, (p, p) and $(p, 1)$ form trivial neutrosophic duplets. Thus, the collection of all neutrosophic duplets $B = \{(p, x)\}$, x is a unit and $x = p$ is also taken to form the semigroup of order p and is commutative as the collection of all odd numbers forms a semigroup under product modulo $2p$; hence, the claim. \square

It is important and interesting to note that, unlike Z_{p^n} , p is a prime and $n \geq 2$. We see Z_{2p} has both non-trivial neutrosophic triplet groups which forms a classical group [23] as well as has a neutrosophic duplet which forms a semigroup of order p .

Next, we study the case when Z_{pq} is taken where both p and q are odd primes first by an example.

Example 4. Let $S = \{Z_{15}, \times\}$ be a semigroup under product. The idempotents of Z_{15} are 10 and 6. However, 10 does not contribute to non-trivial neutrosophic triplet groups other than $\{5, 10, 5\}$, $\{10, 10, 10\}$. The neutrosophic triplet groups associated with 6 are $(3, 6, 12)$, $(12, 6, 3)$, $(9, 6, 9)$ and $(6, 6, 6)$. The neutrosophic duplets of Z_{15} are contributed by $\{5\}$, $\{10\}$ and $\{3, 12, 6, 9\}$ in a unique way.

$$D_1 = \{\{5, 1\}, \{5, 4\}, \{5, 7\}, \{5, 13\}, \{5, 10\}\},$$

$$D_2 = \{\{10, 13\}, \{10, 7\}, \{10, 1\}, \{10, 4\}, \{10, 10\}\},$$

$$D_3 = \{\{3, 11\}, \{3, 1\}, \{3, 6\}, \{12, 11\}, \{12, 1\}, \{12, 6\}, \{6, 11\}, \{6, 1\}, \{6, 6\}, \{9, 11\}, \{9, 1\}, \{9, 6\}\}$$

All three collections of duplets put together is not closed under \times ; however, D_2 and D_3 form a semigroup under product modulo 15. If we want to make D_1 a semigroup, we should adjoin the trivial duplets $\{0, 4\}$, $\{0, 7\}$, $\{0, 13\}$, $\{0, 1\}$, $\{0, 6\}$, $\{0, 10\}$ as well as D_2 . Further, we see $D_1 \cup D_2 \cup D_3$ is not closed under product.

Thus, the study of Z_{pq} where p and q are odd primes happens to be a challenging problem. We give the following examples in the case when $p = 5$ and $q = 7$.

Example 5. Let $S = \{Z_{35}, \times\}$ be a semigroup of order 35. The idempotents of Z_{35} are 15 and 21. The neutrosophic triplets associated with 15 are $\{(15, 15, 15), (5, 15, 10), (25, 15, 30), (20, 15, 20), (30, 15, 25), (10, 15, 5)\}$, a cyclic group of order six. The cyclic group contributed by the neutrosophic triplet groups associated with 21 is as follows: $\{(21, 21, 21), (7, 21, 28), (28, 21, 7), (14, 21, 14)\}$, which is of order four. The neutrosophic duplets are tabulated in Table 1. Similarly, the neutrosophic duplets associated with $S = \{Z_{105}, \times\}$ are tabulated in Table 2.

Table 1. Neutrosophic Duplets of $\{Z_{35}, \times\}$.

Neutrals for duplets	Neutrals for duplets
5, 10, 15, 20, 25, 30	7, 14, 21, 28
1, 8, 15, 22, 24	1, 6, 11, 16, 21, 26, 31

Table 2. Neutrosophic Duplets of $\{Z_{105}, \times\}$.

Neutrals for duplets	Neutrals for duplets
3, 6, 9, 12, 18, 21, 24, 27, 33, 36, 39, 48, 51, 54, 57, 66, 69, 78, 81, 87, 93, 96, 99, 102	5, 10, 20, 25, 40, 50, 55, 65, 80, 85, 95, 100
1, 36, 71	1, 22, 43, 64, 84
Neutrals for duplets	Neutrals for duplets
7, 14, 28, 49, 56, 77, 91, 98	15, 30, 45, 60, 75, 90
1, 16, 31, 46, 61, 76, 91	1, 8, 15, 22, 29, 36, 43, 50, 57, 64, 71, 78, 85, 92, 99
Neutrals for duplets	Neutrals for duplets
21, 42, 63, 84	35, 70
1, 6, 11, 16, 21, 26, 31, 36, 41, 46, 51, 56, 61, 66, 71, 76, 81, 86, 91, 96, 101	1, 4, 7, 10, 13, 16, 19, 22, 25, 28, 31, 34, 37, 40, 43, 46, 49, 52, 55, 58, 61, 64, 67, 70, 73, 76, 79, 82, 85, 88, 91, 94, 97, 100, 103

Theorem 4. Let $\{Z_n, \times\}$ be a semigroup under product modulo n ; $x \in Z_n \setminus \{0\}$ has a neutral $y \in Z_n \setminus \{0\}$ or is a non-trivial neutrosophic duplet if and only if x is not unit in Z_n .

Proof. $x \in Z_n \setminus \{0\}$ is a neutrosophic duplet if $x \times y = x(mod n)$ and y is called the neutral of x . If $x^2 = x$, then we call the pair (x, x) as trivial neutrosophic duplet pair. We see $x \times y = x$, if x is a unit in Z_n , then there exists a $z \in Z_n$ such that $z \times (x \times y) = z \times x$, so that $y = 1$ as $z \times x = 1(mod n)$; so $y = 1$ gives trivial neutrosophic duplets. Thus, x is not a unit if it has to form a non-trivial neutrosophic duplet pair; $x \times y = x$ and $y \neq 1$ then if x is a unit we arrive at contradiction; hence, the theorem. \square

Theorem 5. Let $S = \{Z_{pq}, \times\}$ be a semigroup under product modulo pq , p and q distinct odd primes. There is p number of neutrosophic duplets for every $p, 2p, 3p, \dots, (q-1)p$. Similarly, there is q number of neutrosophic duplets associated with every $q, 2q, \dots, (p-1)q$. The neutrals of sq and tp is given by $1 + nq$ for $1 \leq t \leq q-1, 0 \leq n \leq p-1$ and that of sq is given by $1 + mp; 1 \leq s \leq p-1, 0 \leq m \leq q-1$.

Proof. Given $\{Z_{pq}, \times\}$ is a semigroup under product modulo pq (p and q two distinct odd primes). The neutrals associated with any $tp; 1 \leq t \leq q-1$ is given by the sequence $\{1 + q, 2q + 1, 3q + 1, \dots, (p-1)q + 1\}$ for every $tp \in \{p, 2p, \dots, (q-1)p\}$. We see, if $tp \in Z_{pq}$,

$$\begin{aligned} tp \times (1 + nq) &= tp + tpnq \\ &= tp + tnpq = tp(mod pq). \end{aligned}$$

A similar argument for sq completes the proof; hence, the claim. \square

Theorem 6. Let $S = \{Z_{p_1 p_2 \dots p_n}, \times\}$ be the semigroup under product modulo $p_1 p_2 \dots p_n$, where p_1, p_2, \dots, p_n are n distinct primes. The duplets are contributed by the non-units of S . The neutrosophic duplets associated with $A_i = \{p_i, 2p_i, \dots, (p_1 p_2 \dots p_{i-1} p_{i+1} \dots p_n - 1)p_i\}$ are $\{1 + (p_1 p_2 \dots p_{i-1} p_{i+1} \dots p_n)t\}$ where $t = 1, 2, \dots, p_i - 1$; and $i = 1, 2, \dots, n$. Thus, every element x_i of A_i has only $p_i - 1$ number of elements which neutralizes x_i ; thus, using each x_i , we have $p_i - 1$ neutrosophic duplets.

Proof. Given $S = \{Z_{p_1 p_2 \dots p_n}, \times\}$ is a semigroup under product modulo $p_1 \dots p_n$, where p_i s are distinct primes, $i = 1, 2, \dots, n$. Considering $A_i = \{p_i, 2p_i, \dots, (p_1 p_2 \dots p_{i-1} p_{i+1} \dots p_n - 1)p_i\}$, we have to prove that, for any $sp_i, sp_i \times [1 + (p_1 p_2 \dots p_{i-1} p_{i+1} \dots p_n)t] = sp_i; 1 \leq t \leq p_i - 1$.

Clearly,

$$\begin{aligned} sp_i \times [1 + (p_1 p_2 \dots p_{i-1} p_{i+1} \dots p_n)t] &= sp_i + sp_i[(p_1 p_2 \dots p_{i-1} p_{i+1} \dots p_n)t] \\ &= sp_i + st[(p_1 p_2 \dots p_{i-1} p_{i+1} \dots p_n)] = sp_i \end{aligned}$$

as $p_1 p_2 \dots p_n = 0(mod (p_1 p_2 \dots p_n))$. Hence, the claim. \square

Thus, for varying t and varying s given in the theorem, we see

$$\{sp_i, (1 + (p_1 p_2 \dots p_{i-1} p_{i+1} \dots p_n)t)\}$$

is a neutrosophic duplet pair $1 \leq t \leq p_i - 1; 1 \leq s \leq p_1 p_2 \dots p_{i-1} p_{i+1} \dots p_n$ and $i = 1, 2, \dots, n$.

5. Discussions and Conclusions

This paper studies the neutrosophic duplets in the case Z_{p^n}, Z_{pq} and $Z_{p_1 p_2 \dots p_n}$. In the case of Z_{p^n} and Z_{pq} , a complete characterization of them is given; however, in the case $Z_{p_1 \dots p_n}$, only the neutrosophic duplets associated with p_i s are provided; $i = 1, 2, \dots, n$. Further, the following problems are left open:

1. For Z_{pq} , p and q odd primes, how many neutrosophic duplet pairs are there?
2. For $Z_{p_1 \dots p_n}$, what are the neutrals of $p_i p_j, p_i p_j p_k, \dots, p_1 p_2 \dots p_{i-1} p_{i+1} \dots p_n$?
3. The study of neutrosophic duplets of $Z_{p_1^{t_1} p_2^{t_2} \dots p_n^{t_n}}; p_1, \dots, p_n$ are distinct primes and $t_i \geq 1; 1 \leq i \leq n$ is left open.

For future research, one can apply the proposed neutrosophic duplets to SVNS, DVNS or TRINS. These neutrosophic duplets can be applied in problems where neutral elements for a given a in Z_{p^n} or Z_{pq} happens to be many. However, the concept of $anti(a)$ does not exist in the case of neutrosophic duplets. Finally, these neutrosophic duplet collections form a semigroup only when all the trivial neutrosophic duplet pairs $(0, a)$ for all appropriate a are taken. These neutrosophic duplets from Z_{p^n} and Z_{pq} can be used to model suitable problems where the $anti(a)$ under study does not exist and many neutrals are needed. This study can be taken up for further development.

Abbreviations

The following abbreviations are used in this manuscript:

SVNS	Single Valued Neutrosophic Sets
DVNS	Double Valued Neutrosophic Sets
TRINS	Triple Refined Indeterminate Neutrosophic Sets
IFS	Intuitionistic Fuzzy Sets

References

1. Smarandache, F. *A Unifying Field in Logics: Neutrosophic Logic. Neutrosophy, Neutrosophic Set, Neutrosophic Probability and Statistics*; American Research Press: Rehoboth, MA, USA, 2005.
2. Vasantha, W.B. *Smarandache Semigroups*; American Research Press: Rehoboth, MA, USA, 2002.
3. Vasantha, W.B.; Smarandache, F. *Basic Neutrosophic Algebraic Structures and Their Application to Fuzzy and Neutrosophic Models*; Hexis: Phoenix, AZ, USA, 2004.
4. Vasantha, W.B.; Smarandache, F. *N-Algebraic Structures and SN-Algebraic Structures*; Hexis: Phoenix, AZ, USA, 2005.
5. Vasantha, W.B.; Smarandache, F. *Some Neutrosophic Algebraic Structures and Neutrosophic N-Algebraic Structures*; Hexis: Phoenix, AZ, USA, 2006.
6. Smarandache, F. Neutrosophic set—a generalization of the intuitionistic fuzzy set. In Proceedings of the 2006 IEEE International Conference on Granular Computing, Atlanta, GA, USA, 10–12 May 2006; pp. 38–42.
7. Smarandache, F. Operators on Single-Valued Neutrosophic Oversets, Neutrosophic Undersets, and Neutrosophic Offsets. *J. Math. Inf.* **2016**, *5*, 63–67. [[CrossRef](#)]
8. Smarandache, F.; Ali, M. Neutrosophic triplet group. *Neural Comput. Appl.* **2018**, *29*, 595–601. [[CrossRef](#)]
9. Wang, H.; Smarandache, F.; Zhang, Y.; Sunderraman, R. Single valued neutrosophic sets. *Rev. Air Force Acad.* **2010**, *1*, 10–15.
10. Kandasamy, I. Double-Valued Neutrosophic Sets, their Minimum Spanning Trees, and Clustering Algorithm. *J. Intell. Syst.* **2018**, *27*, 163–182. [[CrossRef](#)]
11. Kandasamy, I.; Smarandache, F. Triple Refined Indeterminate Neutrosophic Sets for personality classification. In Proceedings of the 2016 IEEE Symposium Series on Computational Intelligence (SSCI), Athens, Greece, 6–9 December 2016; pp. 1–8.
12. Atanassov, K.T. Intuitionistic fuzzy sets. *Fuzzy Sets Syst.* **1986**, *20*, 87–96. [[CrossRef](#)]
13. Zadeh, L.A. Fuzzy sets. *Inf. Control* **1965**, *8*, 338–353. [[CrossRef](#)]
14. Smarandache, F. *Neutrosophic Perspectives: Triplets, Duplets, Multisets, Hybrid Operators, Modal Logic, Hedge Algebras and Applications*, 2nd ed.; Pons Publishing House: Brussels, Belgium, 2017.
15. Sahin, M.; Abdullah, K. Neutrosophic triplet normed space. *Open Phys.* **2017**, *15*, 697–704. [[CrossRef](#)]
16. Smarandache, F. Hybrid Neutrosophic Triplet Ring in Physical Structures. *Bull. Am. Phys. Soc.* **2017**, *62*, 17.
17. Smarandache, F.; Ali, M. Neutrosophic Triplet Field used in Physical Applications. In Proceedings of the 18th Annual Meeting of the APS Northwest Section, Pacific University, Forest Grove, OR, USA, 1–3 June 2017.

18. Smarandache, F.; Ali, M. Neutrosophic Triplet Ring and its Applications. In Proceedings of the 18th Annual Meeting of the APS Northwest Section, Pacific University, Forest Grove, OR, USA, 1–3 June 2017.
19. Zhang, X.H.; Smarandache, F.; Liang, X.L. Neutrosophic Duplet Semi-Group and Cancellable Neutrosophic Triplet Groups. *Symmetry* **2017**, *9*, 275. [[CrossRef](#)]
20. Bal, M.; Shalla, M.M.; Olgun, N. Neutrosophic Triplet Cosets and Quotient Groups. *Symmetry* **2017**, *10*, 126. [[CrossRef](#)]
21. Zhang, X.H.; Smarandache, F.; Ali, M.; Liang, X.L. Commutative neutrosophic triplet group and neutro-homomorphism basic theorem. *Ital. J. Pure Appl. Math.* **2017**, in press.
22. Vasantha, W.B.; Kandasamy, I.; Smarandache, F. *Neutrosophic Triplet Groups and Their Applications to Mathematical Modelling*; EuropaNova: Brussels, Belgium, 2017.
23. Vasantha, W.B.; Kandasamy, I.; Smarandache, F. A Classical Group of Neutrosophic Triplet Groups Using $\{Z_{2p}, \times\}$. *Symmetry* **2018**, *10*, 194. [[CrossRef](#)]
24. Zhang, X.; Hu, Q.; Smarandache, F.; An, X. On Neutrosophic Triplet Groups: Basic Properties, NT-Subgroups, and Some Notes. *Symmetry* **2018**, *10*, 289. [[CrossRef](#)]
25. Goguen, J.A. L-fuzzy sets. *J. Math. Anal. Appl.* **1967**, *18*, 145–174. [[CrossRef](#)]

Single-Valued Neutrosophic Hyperrings and Single-Valued Neutrosophic Hyperideals

D. Preethi, S. Rajareega, J. Vimala, Ganeshsree Selvachandran, Florentin Smarandache

D. Preethi, S. Rajareega, J. Vimala, Ganeshsree Selvachandran, Florentin Smarandache (2019). Single-Valued Neutrosophic Hyperrings and Single-Valued Neutrosophic Hyperideals. *Neutrosophic Sets and Systems* 29, 121-128

Abstract. In this paper, we introduced the concepts of Single-valued neutrosophic hyperring and Single-valued neutrosophic hyperideal. The algebraic properties and structural characteristics of the single-valued neutrosophic hyperrings and hyperideals are investigated and verified.

Keywords: Hyperring, Hyperideal, Single-valued neutrosophic set, Single-valued neutrosophichyperring and Single-valued neutrosophichyperideal.

1 Introduction

Hyperstructure theory was introduced by Marty in 1934 [16]. The concept of hyperring and the general form of hyperring for introducing the notion of hyperring homomorphism was developed by Corsini [11]. Vougiouklis [31] coined different type of hyperrings called H_v -ring, H_v -subring, and left and right H_v -ideal of a H_v -ring, all of which are generalizations of the corresponding concepts related to hyperrings introduced by Corsini [11].

In general fuzzy sets [34] the grade of membership is represented as a single real number in the interval $[0,1]$. The uncertainty in the grade of membership of the fuzzy set model was overcome using the interval-valued fuzzy set model introduced by Turksen [29]. In 1986, Atanassov [8] introduced intuitionistic fuzzy sets which is a generalization of fuzzy sets. This model was equivalent to interval valued fuzzy sets in [32]. Intuitionistic fuzzy sets can only handle incomplete information, and not indeterminate information which commonly exists in real-life [32]. To overcome these problems, Smarandache introduced the neutrosophic model. Some new trends of neutrosophic theory were introduced in [1,2,3,4,5,6,7]. Wang et al. [32] introduced the concept of single-valued neutrosophic sets (SVNSs), whereas Smarandache introduced plithogenic set as generalization of neutrosophic set model in [13].

The theory of hyperstructures are widely used in various mathematical theories. The study on fuzzy algebra began by Rosenfeld [17], and this was subsequently expanded to other fuzzy based models such as intuitionistic fuzzy sets, fuzzy soft sets and vague soft sets. Some of the recent works related to fuzzy soft rings and ideal, vague soft groups, vague soft rings and vague soft ideals can be found in [21; 22; 23; 26, 27]. Research on fuzzy algebra led to the development of fuzzy hyperalgebraic theory. The concept of fuzzy ideals of a ring introduced by Liu [15]. The generalization of the fuzzy hyperideal introduced by Davvaz [12]. The concepts of fuzzy γ -ideal was then introduced by Bharathi

and Vimala [10], and the fuzzy γ -ideal was subsequently expanded in [33]. The hypergroup and hyperring theory for vague soft sets were developed by Selvachandran et al. in [18,19,20,24,25] In this paper we develop the theory of single-valued neutrosophic hyperrings and single-valued neutrosophic hyperideals to further contribute to the development of the body of knowledge in neutrosophic hyperalgebraic theory.

2 Preliminaries

Let X be a space of points (objects) with a generic element in X denoted by x .

Definition 2.1. [32] A SVNS A is a neutrosophic set that is characterized by a truth-membership function $T_A(x)$, an indeterminacy-membership function $I_A(x)$, and a falsity-membership function $F_A(x)$, where $T_A(x), I_A(x), F_A(x) \in [0, 1]$. This set A can thus be written as

$$A = \{ \langle x, T_A(x), I_A(x), F_A(x) \rangle : x \in U \}. \tag{1}$$

The sum of $T_A(x), I_A(x)$ and $F_A(x)$ must fulfill the condition $0 \leq T_A(x) + I_A(x) + F_A(x) \leq 3$. For a SVNS A in U , the triplet $(T_A(x), I_A(x), F_A(x))$ is called a single-valued neutrosophic number (SVNN). Let $x = (T_x, I_x, F_x)$ to represent a SVNN.

Definition 2.2. [32] Let A and B be two SVNSs over a universe U .

- (i) A is contained in B , if $T_A(x) \leq T_B(x), I_A(x) \leq I_B(x)$, and $F_A(x) \geq F_B(x)$, for all $x \in U$. This relationship is denoted as $A \subseteq B$.
- (ii) A and B are said to be equal if $A \subseteq B$ and $B \subseteq A$.
- (iii) $A^c = \langle x, (F_A(x), 1 - I_A(x), T_A(x)) \rangle$, for all $x \in U$.
- (iv) $A \cup B = \langle x, (\max(T_A, T_B), \max(I_A, I_B), \min(F_A, F_B)) \rangle$, for all $x \in U$.
- (v) $A \cap B = \langle x, (\min(T_A, T_B), \min(I_A, I_B), \max(F_A, F_B)) \rangle$, for all $x \in U$.

Definition 2.3. [16] A hypergroup $\langle H, \circ \rangle$ is a set H with an associative hyperoperation $(\circ) : H \times H \rightarrow P(H)$ which satisfies $x \circ H = H \circ x = H$ for all x in H (reproduction axiom).

Definition 2.4.[12] A hyperstructure $\langle H, \circ \rangle$ is called an H_v -group if the following axioms hold:

- (i) $x \circ (y \circ z) \cap (x \circ y) \circ z \neq \emptyset$ for all $x, y, z \in H$, (H_v -semigroup)
- (ii) $x \circ H = H \circ x = H$ for all x in H .

Definition 2.5.[16] A subset K of H is called a *subhypergroup* if $\langle K, \circ \rangle$ is a hypergroup.

Definition 2.6.[11]A H_v -ring is a multi-valued system $(R, +, \circ)$ which satisfies the following axioms:

- (i) $(R, +)$ is a H_v -group,
- (ii) (R, \circ) is a H_v -semigroup,
- (iii) The hyperoperation " \circ " is weak distributive over the hyperoperation "+", that is for each $x, y, z \in R$ the conditions $x \circ (y + z) \cap ((x \circ y) + (x \circ z)) \neq \emptyset$ and $(x + y) \circ z \cap ((x \circ z) + (y \circ z)) \neq \emptyset$ holds true.

Definition 2.7. [11]A nonempty subset R' of R is a *subhyperring* of $(R, +, \circ)$ if $(R', +)$ is a subhypergroup of $(R, +)$ and for all $x, y, z \in R'$, $x \circ y \in P^*(R')$, where $P^*(R')$ is the set of all non-empty subsets of R' .

Definition 2.8. [11] Let R be a H_v -ring. A nonempty subset I of R is called a *left* (respectively *right*) H_v -ideal if the following axioms hold:

- (i) $(I, +)$ is a H_v -subgroup of $(R, +)$,
- (ii) $R \circ I \subseteq I$ (resp. $I \circ R \subseteq I$).

If I is both a left and right H_v -ideal of R , then I is said to be a H_v -ideal of R .

3 Single-Valued Neutrosophic Hyperrings

Throughout this section, we denote the hyperring $(R, +, \circ)$ by R .

Definition 3.1. Let A be a SVN over R . A is called a single-valued neutrosophic hyperring over R , if,

- (i) $a, b \in R, \min\{T_A(a), T_A(b)\} \leq \inf\{T_A(c) : c \in a + b\}, \max\{I_A(a), I_A(b)\} \geq \sup\{I_A(c) : c \in a + b\}$ and $\max\{F_A(a), F_A(b)\} \geq \sup\{F_A(c) : c \in a + b\}$
- (ii) $x, a \in R$, there exists $b \in R$ such that $a \in x + b$ and $\min\{T_A(x), T_A(a)\} \leq T_A(b), \max\{I_A(x), I_A(a)\} \geq I_A(b)$ and $\max\{F_A(x), F_A(a)\} \geq F_A(b)$
- (iii) $x, a \in R$, there exists $c \in R$ such that $a \in c + x$ and $\min\{T_A(x), T_A(a)\} \leq T_A(c), \max\{I_A(x), I_A(a)\} \geq I_A(c)$ and $\max\{F_A(x), F_A(a)\} \geq F_A(c)$
- (iv) $a, b \in R, \min\{T_A(a), T_A(b)\} \leq \inf\{T_A(c) : c \in a \circ b\}, \max\{I_A(a), I_A(b)\} \geq \sup\{I_A(c) : c \in a \circ b\}$ and $\max\{F_A(a), F_A(b)\} \geq \sup\{F_A(c) : c \in a \circ b\}$

Example 3.2. The family of t -level sets of SVN over R is a subhyperring of R is given below:

$$A_t = \{a \in R : T_A(a) \geq t, I_A(a) \geq t, F_A(a) \leq t\}, \text{ for all } t \in [0, 1].$$

Then A is a single-valued neutrosophic hyperring over R .

Theorem 3.3. A is a SVN over R . Then A is a single-valued neutrosophic hyperring over R iff A is single-valued neutrosophic semi hyper group over (R, \circ) and also a single-valued neutrosophic hypergroup over $(R, +)$.

Proof. This is obvious by Definition 3.1. ■

Theorem 3.4. Let A and B be single-valued neutrosophic hyperrings over R . Then $A \cap B$ is a single-valued neutrosophic hyperring over R if it is non-null.

Proof. Let A and B are single-valued neutrosophic hyperrings over R . By Definition 3.1, $A \cap B = \{(a, T_{A \cap B}(a), I_{A \cap B}(a), F_{A \cap B}(a)) : a \in R\}$, where $T_{A \cap B}(a) = \min(T_A(a), T_B(a)), I_{A \cap B}(a) = \max(I_A(a), I_B(a)), F_{A \cap B}(a) = \max(F_A(a), F_B(a))$. Then for all $a, b \in R$, we have the following. We only prove all the four conditions for the truth membership terms T_A, T_B . The proof for the I_A, I_B and F_A, F_B membership functions obtained in a similar manner.

$$\begin{aligned} \text{(i)} \quad \min\{T_{A \cap B}(a), T_{A \cap B}(b)\} &= \min\{\min(T_A(a), T_B(a)), \min(T_A(b), T_B(b))\} \\ &\leq \min\{\min(T_A(a), T_A(b)), \min(T_B(a), T_B(b))\} \\ &\leq \min\{\inf\{T_A(c) : c \in a + b\}, \inf\{T_B(c) : c \in a + b\}\} \\ &\leq \inf\{\min(T_A(c), T_B(c)) : c \in a + b\} \\ &= \inf\{T_{A \cap B}(c) : c \in a + b\} \end{aligned}$$

Similarly, $\max\{I_{A \cap B}(a), I_{A \cap B}(b)\} \geq \sup\{I_{A \cap B}(c) : c \in a + b\}$ and $\max\{F_{A \cap B}(a), F_{A \cap B}(b)\} \geq \sup\{F_{A \cap B}(c) : c \in a + b\}$.

(ii) $x, a \in R$, there exists $b \in R$ such that $a \in x + b$. Then it follows that:

$$\begin{aligned} \min\{T_{A \cap B}(a), T_{A \cap B}(b)\} &= \min\{\min(T_A(a), T_B(a)), \min(T_A(b), T_B(b))\} \\ &\leq \min\{\min(T_A(a), T_A(b)), \min(T_B(a), T_B(b))\} \\ &\leq \min(T_A(c), T_B(c)) \\ &= T_{A \cap B}(c) \end{aligned}$$

Similarly, $\max\{I_{A \cap B}(a), I_{A \cap B}(b)\} \geq I_{A \cap B}(c)$ and $\max\{F_{A \cap B}(a), F_{A \cap B}(b)\} \geq F_{A \cap B}(c)$.

(iii) It can be easily verified that $x, a \in R$, there exists $c \in R$ such that $a \in c + x$ & $\min\{T_{A \cap B}(x), T_{A \cap B}(a)\} \leq T_{A \cap B}(c), \max\{I_{A \cap B}(x), I_{A \cap B}(a)\} \geq I_{A \cap B}(c)$ and $\max\{F_{A \cap B}(x), F_{A \cap B}(a)\} \geq$

$$F_{A \cap B}(c).$$

$$(iv) \quad a \in R, \min\{T_{A \cap B}(a), T_{A \cap B}(b)\} \leq \inf\{T_{A \cap B}(c): c \in a \circ b\}, \max\{I_{A \cap B}(a), I_{A \cap B}(b)\} \geq \sup\{I_{A \cap B}(c): c \in a \circ b\} \text{ and } \max\{F_{A \cap B}(a), F_{A \cap B}(b)\} \geq \sup\{F_{A \cap B}(c): c \in a \circ b\}.$$

Hence, $A \cap B$ is single-valued neutrosophichyperring over R . ■

Theorem 3.5. Let A be a single-valued neutrosophic hyperring over R . Then for every $t \in [0, 1], A_t \neq \emptyset$ is a subhyperring over R .

Proof. Let A be a single-valued neutrosophichyperring over R . $t \in [0, 1]$, let $a, b \in A_t$. Then $T_A(a), T_A(b) \geq t, I_A(a), I_A(b) \leq t$ and $F_A(a), F_A(b) \leq t$. Since A is a single-valued neutrosophic sub hyper group of $(R, +)$, we have the following:

$$\inf\{T_A(c): c \in a + b\} \geq \min\{T_A(a), T_A(b)\} \geq \min\{t, t\} = t,$$

$$\sup\{I_A(c): c \in a + b\} \leq t,$$

and

$$\sup\{F_A(c): c \in a + b\} \leq t.$$

This implies that $c \in A_t$ and then for every $c \in a + b$, we obtain $a + b \subseteq A_t$. As such, for every $c \in A_t$, we obtain $c + A_t \subseteq A_t$. Now let $a, c \in A_t$. Then $T_A(a), T_A(c) \geq t, I_A(a), I_A(c) \leq t$ and $F_A(a), F_A(c) \leq t$.

A is a single-valued neutrosophic subhypergroup of $(R, +)$, there exists $b \in R$ such that $a \in c + b$ and $T_A(b) \geq \min(T_A(a), T_A(c)) \geq t, I_A(b) \leq \max(I_A(a), I_A(c)) \leq t, F_A(b) \leq \max(F_A(a), F_A(c)) \leq t$, and this implies that $b \in A_t$. Therefore, we obtain $A_t \subseteq c + A_t$. As such, we obtain $c + A_t = A_t$. As a result, A_t is a subhypergroup of $(R, +)$.

Let $a, b \in A_t$, then $T_A(a), T_A(b) \geq t, I_A(a), I_A(b) \leq t$ and $F_A(a), F_A(b) \leq t$. Since A is a single-valued neutrosophic subsemihypergroup of (R, \circ) , then for all $a, b \in R$, we have the following:

$$\inf\{T_A(c): c \in a \circ b\} \geq \min\{T_A(a), T_A(b)\} = t,$$

$$\sup\{I_A(c): c \in a \circ b\} \leq \max\{I_A(a), I_A(b)\} = t,$$

and

$$\sup\{F_A(c): c \in a \circ b\} \leq \max\{F_A(a), F_A(b)\} = t.$$

This implies that $c \in A_t$ and consequently $a \circ b \in A_t$. Therefore, for every $a, b \in A_t$ we obtain $a \circ b \in P^*(R)$. Hence A_t is a subhyperring over R .

Theorem 3.6. Let A be a single-valued neutrosophic set over R . Then the following statements are equivalent:

- (i) A is a single-valued neutrosophic hyperring over R .
- (ii) $t \in [0, 1]$, a non-empty A_t is a sub hyperring over R .

Proof.

(i) \Rightarrow (ii) $t \in [0, 1]$, by Theorem 3.5, A_t is sub hyperring over R .

(ii) \Rightarrow (i) Assume that A_t is a subhyperring over R . Let $a, b \in A_t$ and therefore $a + b \subseteq A_{t_0}$. Then for every $c \in a + b$ we have $T_A(c) \geq t_0, I_A(c) \leq t_0$ and $F_A(c) \leq t_0$, which implies that:

$$\min\{T_A(a), T_A(b)\} \leq \inf\{T_A(c): c \in a + b\},$$

$$\max\{I_A(a), I_A(b)\} \geq \sup\{I_A(c): c \in a + b\},$$

and

$$\max(F_A(a), F_A(b)) \geq \sup\{F_A(c) : c \in a + b\}$$

Therefore, condition (i) of Definition 3.1 has been verified.

Next, let $x, a \in A_{t_1}$ for every $t_1 \in [0, 1]$ which means that there exists $b \in A_{t_1}$ such that $a \in x \circ b$. Since $b \in A_{t_1}$, we have $T_A(b) \geq t_1, I_A(b) \leq t_1$ and $F_A(b) \leq t_1$, and thus we have

$$\begin{aligned} T_A(b) &\geq t_1 = \min(T_A(a), T_A(c)), \\ I_A(b) &\leq t_1 = \max(I_A(a), I_A(c)), \end{aligned}$$

and

$$F_A(b) \leq t_1 = \max(F_A(a), F_A(c)).$$

Therefore, condition (ii) of Definition 3.1 has been verified. Compliance to condition (iii) of Definition 3.1 can be proven in a similar manner. Thus, A is a single-valued neutrosophic subhypergroup of $(R, +)$. Now since A_t is a subsemihypergroup of the semihypergroup (R, \circ) , we have the following. Let $a, b \in A_{t_2}$ and therefore we have $a \circ b \in A_{t_2}$. Thus for every $c \in a \circ b$, we obtain $T_A(c) \geq t_2, I_A(c) \leq t_2$ and $F_A(c) \leq t_2$, and therefore it follows that:

$$\begin{aligned} \min(T_A(a), T_A(b)) &\leq \inf\{T_A(c) : c \in a \circ b\}, \\ \max(I_A(a), I_A(b)) &\geq \sup\{I_A(c) : c \in a \circ b\}, \end{aligned}$$

and

$$\max(F_A(a), F_A(b)) \geq \sup\{F_A(c) : c \in a \circ b\},$$

which proves that condition (iv) of Definition 3.1 has been verified. Hence A is a single-valued neutrosophic hyperring over R .

4 Single-Valued Neutrosophic Hyperideals

Definition 4.1. Let A be a SVNS over R . Then A is single-valued neutrosophic left (resp. right) hyperideal over R , if ,

- (i) $a, b \in R, \min\{T_A(a), T_A(b)\} \leq \inf\{T_A(c) : c \in a + b\}, \max\{I_A(a), I_A(b)\} \geq \sup\{I_A(c) : c \in a + b\}$ and $\max\{F_A(a), F_A(b)\} \geq \sup\{F_A(c) : c \in a + b\}$
- (ii) $x, a \in R$, there exists $b \in R$ such that $a \in x + b$ and $\min\{T_A(x), T_A(a)\} \leq T_A(b), \max\{I_A(x), I_A(a)\} \geq I_A(b)$ and $\max\{F_A(x), F_A(a)\} \geq F_A(b)$
- (iii) $x, a \in R$, there exists $c \in R$ such that $a \in c + x$ and $\min\{T_A(x), T_A(a)\} \leq T_A(c), \max\{I_A(x), I_A(a)\} \geq I_A(c)$ and $\max\{F_A(x), F_A(a)\} \geq F_A(c)$
- (iv) $a, b \in R, T_A(b) \leq \inf\{T_A(c) : c \in a \circ b\}$ (resp. $T_A(a) \leq \inf\{T_A(c) : c \in a \circ b\}$), $I_A(b) \geq \sup\{I_A(c) : c \in a \circ b\}$ (resp. $I_A(a) \geq \sup\{I_A(c) : c \in a \circ b\}$) and $F_A(b) \geq \sup\{F_A(c) : c \in a \circ b\}$ (resp. $F_A(a) \geq \sup\{F_A(c) : c \in a \circ b\}$)

A is a single-valued neutrosophic left (resp. right) hyperideal of R . From conditions (i), (ii) and (iii) A is a single-valued neutrosophic subhypergroup of $(R, +)$.

Definition 4.2. Let A be a SVNS over R . Then A is a single-valued neutrosophic hyper ideal over R , if the following conditions are satisfied:

- (i) $a, b \in R, \min\{T_A(a), T_A(b)\} \leq \inf\{T_A(c) : c \in a + b\}, \max\{I_A(a), I_A(b)\} \geq \sup\{I_A(c) : c \in a + b\}$ and $\max\{F_A(a), F_A(b)\} \geq \sup\{F_A(c) : c \in a + b\}$
- (ii) $x, a \in R$, there exists $b \in R$ such that $a \in x + b$ and $\min\{T_A(x), T_A(a)\} \leq T_A(b), \max\{I_A(x), I_A(a)\} \geq I_A(b)$ and $\max\{F_A(x), F_A(a)\} \geq F_A(b)$
- (iii) $x, a \in R$, there exists $c \in R$ such that $a \in c + x$ and $\min\{T_A(x), T_A(a)\} \leq T_A(c), \max\{I_A(x), I_A(a)\} \geq I_A(c)$ and $\max\{F_A(x), F_A(a)\} \geq F_A(c)$
- (iv) $a, b \in R, \max\{T_A(a), T_A(b)\} \leq \inf\{T_A(c) : c \in a \circ b\}, \max\{I_A(a), I_A(b)\} \geq \sup\{I_A(c) : c \in a \circ b\}$ and $\max\{F_A(a), F_A(b)\} \geq \sup\{F_A(c) : c \in a \circ b\}$

From conditions (i), (ii) and (iii) A is a single-valued neutrosophic sub hyper group of $(R, +)$. Condition (iv) indicate both single-valued neutrosophic left hyperideal and single-valued neutrosophic right hyperideal. Hence A is a single-valued neutrosophic hyper ideal of R .

Theorem 4.3. Let A be a non-null SVN over R . A is a single-valued neutrosophic hyperideal over R iff A is a single-valued neutrosophic hyper group over $(R, +)$ and also A is both a single-valued neutrosophic left hyper ideal and a single-valued neutrosophic right hyper ideal of R .

Proof. This is straight forward by Definitions 4.1 and 4.2.

Theorem 4.4. Let A and B be two single-valued neutrosophic hyper ideals over R . Then $A \cap B$ is a single-valued neutrosophic hyperideal over R if it is non-null.

Proof. Let A and B are single-valued neutrosophic hyper ideals over R . By Definition 4.2, $A \cap B = \{(a, T_{A \cap B}(a), I_{A \cap B}(a), F_{A \cap B}(a)) : a \in R\}$, where $T_{A \cap B}(a) = \min(T_A(a), T_B(a))$, $I_{A \cap B}(a) = \max(I_A(a), I_B(a))$ and $F_{A \cap B}(a) = \max(F_A(a), F_B(a))$. Then $a, b \in R$, we have the following. We only prove all the four conditions for the truth membership terms T_A, T_B . The proof for the I_A, I_B and F_A, F_B membership functions obtained in a similar manner.

$$\begin{aligned} \text{(i)} \quad \min\{T_{A \cap B}(a), T_{A \cap B}(b)\} &= \min\{\min(T_A(a), T_B(a)), \min(T_A(b), T_B(b))\} \\ &\leq \min\{\min(T_A(a), T_A(b)), \min(T_B(a), T_B(b))\} \\ &\leq \min\{\inf\{T_A(c) : c \in a + b\}, \inf\{T_B(c) : c \in a + b\}\} \\ &\leq \inf\{\min(T_A(c), T_B(c)) : c \in a + b\} \\ &= \inf\{T_{A \cap B}(c) : c \in a + b\} \end{aligned}$$

Similarly, it can be proven that $\max\{I_{A \cap B}(a), I_{A \cap B}(b)\} \geq \sup\{I_{A \cap B}(c) : c \in a + b\}$ and $\max\{F_{A \cap B}(a), F_{A \cap B}(b)\} \geq \sup\{F_{A \cap B}(c) : c \in a + b\}$.

(ii) $x, a \in R$, there exists $b \in R$ such that $a \in x + b$. Then:

$$\begin{aligned} \min\{T_{A \cap B}(a), T_{A \cap B}(b)\} &= \min\{\min(T_A(a), T_B(a)), \min(T_A(b), T_B(b))\} \\ &\leq \min\{\min(T_A(a), T_A(b)), \min(T_B(a), T_B(b))\} \\ &\leq \min(T_A(c), T_B(c)) \\ &= T_{A \cap B}(c) \end{aligned}$$

Similarly, $\max\{I_{A \cap B}(a), I_{A \cap B}(b)\} \geq I_{A \cap B}(c)$ and $\max\{F_{A \cap B}(a), F_{A \cap B}(b)\} \geq F_{A \cap B}(c)$.

(iii) $x, a \in R$, there exists $c \in R$ such that $a \in c + x$ and $\min\{T_{A \cap B}(x), T_{A \cap B}(a)\} \leq T_{A \cap B}(c)$, $\max\{I_{A \cap B}(x), I_{A \cap B}(a)\} \geq I_{A \cap B}(c)$ and $\max\{F_{A \cap B}(x), F_{A \cap B}(a)\} \geq F_{A \cap B}(c)$.

(iv) $a \in R$, $\max\{T_{A \cap B}(a), T_{A \cap B}(b)\} \leq \inf\{T_{A \cap B}(c) : c \in a \circ b\}$, $\min\{I_{A \cap B}(a), I_{A \cap B}(b)\} \geq \sup\{I_{A \cap B}(c) : c \in a \circ b\}$ and $\min\{F_{A \cap B}(a), F_{A \cap B}(b)\} \geq \sup\{F_{A \cap B}(c) : c \in a \circ b\}$.

Hence, it is verified that $A \cap B$ is a single-valued neutrosophic hyperideal over R .

5. Conclusion

We developed hyperstructure for the SVN model through several hyperalgebraic structures such as hyperrings and hyperideals. The properties of these structures were studied and verified. The future work is on the development of hyperalgebraic theory for Plithogenic sets which is the generalization of neutrosophic set and also planned to develop some real life applications.

Acknowledgement

The article has been written with the joint financial support of RUSA-Phase 2.0 grant sanctioned vide letter No. F 24-51/2014-U, Policy (TN Multi-Gen), Dept. of Edn. Govt. of India, Dt. 09.10.2018, UGC-SAP

(DRS-I) vide letter No.F.510/8/DRS-I/2016(SAP-I) Dt. 23.08.2016, DST-PURSE 2nd Phase programme vide letter No. SR/PURSE Phase 2/38 (G) Dt. 21.02.2017 and DST (FST - level I) 657876570 vide letter No.SR/FIST/MSI/2018/17 Dt. 20.12.2018.

The fourth author would like to gratefully acknowledge the financial assistance received from the Ministry of Education, Malaysia under grant no. FRGS/1/2017/STG06/UCSI/03/1.

References

1. Abdel-Basset, M., Mohamed, R., Zaiied, A. E. N. H., & Smarandache, F. (2019). A Hybrid Plithogenic Decision Making Approach with Quality Function Deployment for Selecting Supply Chain Sustainability Metrics. *Symmetry*, 11(7), 903.
2. Abdel-Basset, M., Nabeeh, N. A., El-Ghareeb, H. A., & Aboelfetouh, A. (2019). Utilising neutrosophic theory to solve transition difficulties of IoT-based enterprises. *Enterprise Information Systems*, 1-21.
3. Nabeeh, N. A., Abdel-Basset, M., El-Ghareeb, H. A., & Aboelfetouh, A. (2019). Neutrosophic multi-criteria decision making approach for iot-based enterprises. *IEEE Access*, 7, 59559-59574.
4. Abdel-Baset, M., Chang, V., & Gamal, A. (2019). Evaluation of the green supply chain management practices: A novel neutrosophic approach. *Computers in Industry*, 108, 210-220.
5. Abdel-Basset, M., Saleh, M., Gamal, A., & Smarandache, F. (2019). An approach of TOPSIS technique for-developing supplier selection with group decision making under type-2 neutrosophic number. *Applied Soft Computing*, 77, 438-452.
6. Abdel-Baset, M., Chang, V., Gamal, A., & Smarandache, F. (2019). An integrated neutrosophic ANP and VIKOR method for achieving sustainable supplier selection: A case study in importing field. *Computers in Industry*, 106, 94-110.
7. Abdel-Basset, M., Manogaran, G., Gamal, A., & Smarandache, F. (2019). A group decision making framework based on neutrosophic TOPSIS approach for smart medical device selection. *Journal of medical systems*, 43(2), 38
8. K. Atanassov. Intuitionistic fuzzy sets. *Fuzzy Sets and Systems* 20 (1986) 87-96.
9. Balasubramaniyan Elavarasan, F. Smarandache, Young Bae Jun, Neutrosophic ideals in semigroups, *Neutrosophic Sets and Systems*, Vol. 28, 2019, pp. 273-280.
10. P. Bharathi and J. Vimala. The role of fuzzy γ -ideals in a commutative γ -group. *Global Journal of Pure and Applied Mathematics* 12(3) (2016) 2067-2074.
11. P. Corsini. Prolegomena of hypergroup theory. Aviani Editor, Tricesimo, Italy, 2nd edition, 1993.
12. B. Davvaz. On H_ν -rings and fuzzy H_ν -ideal. *Journal of Fuzzy Mathematics* 6(1) (1998) 33-42.
13. F. Smarandache. Plithogeny, plithogenic set, logic, probability, and statistics. Pons Publishing House, Brussels, Belgium, 141 p., 2017; arXiv.org (Cornell University).
14. S. Khademan, M. M. Zahedi, R. A. Borzooei, Y. B. Jun, Neutrosophic Hyper BCK- Ideals, *Neutrosophic Sets and Systems*, Vol. 27, 2019, pp. 201-217.
15. W. J. Liu. Fuzzy invariant subgroups and fuzzy ideals. *Fuzzy Sets and Systems* 8(2) (1982) 133-139.
16. F. Marty. Sur unegeneralisation de la notion de groupe. *Proceedings of the 8th Congress Mathematicians Scandinaves, Stockholm, Sweden* (1934) 45-49.
17. A. Rosenfeld. Fuzzy groups. *Journal of Mathematical Analysis and Applications* 35 (1971) 512-517.
18. G. Selvachandran and A. R. Salleh. Vague soft hypergroups and vague soft hypergroup homomorphism. *Advances in Fuzzy Systems* 2014 (2014) 1-10.
19. G. Selvachandran and A. R. Salleh. Algebraic hyperstructures of vague soft sets associated with hyperrings and hyperideals. *The Scientific World Journal* 2015 (2015) 1-12.
20. G. Selvachandran. Introduction to the theory of soft hyperrings and soft hyperring homomorphism. *JP Journal of Algebra, Number Theory and Applications* 36(3) (2015) 279-294.
21. G. Selvachandran and A. R. Salleh. Fuzzy soft ideals based on fuzzy soft spaces. *Far East Journal of Mathematical Sciences* 99(3) (2016) 429-438.
22. G. Selvachandran and A. R. Salleh. Rings and ideals in a vague soft set setting. *Far East Journal of Mathematical Sciences* 99(2) (2016) 279-300.
23. G. Selvachandran and A. R. Salleh. On normalistic vague soft groups and normalistic vague soft group homomorphism. *Advances in Fuzzy Systems* 2015 (2015) 1-8.
24. G. Selvachandran and A. R. Salleh. Fuzzy soft hyperrings and fuzzy soft hyperideals. *Global Journal of Pure and Applied Mathematics* 11(2) (2015) 807-823.

25. G. Selvachandran and A.R. Salleh. Hypergroup theory applied to fuzzy soft sets. *Global Journal of Pure and Applied Mathematics* 11(2) (2015) 825-835.
26. G. Selvachandran and A.R. Salleh. Vague soft rings and vague soft ideals. *International Journal of Algebra* 6(12) (2012) 557-572.
27. G. Selvachandran and A.R. Salleh. Idealistic vague soft rings and vague soft ring homomorphism. *International Journal of Mathematical Analysis* 6(26) (2012) 1275-1290.
28. F. Smarandache. *Neutrosophy: Neutrosophic probability, set and logic*. ProQuest Learning, Ann Arbor, Michigan, 1998.
29. I. Turksen. Interval valued fuzzy sets based on normal forms. *Fuzzy Sets and Systems* 20 (1986) 191-210.
30. T. Vougiouklis. *Hyperstructures and their representations*. Hadronic Press, Palm Harbor, Florida, USA, 1994.
31. T. Vougiouklis. A new class of hyperstructures. *Journal of Combination and Information Systems and Sciences* 20 (1995) 229-235.
32. H. Wang, F. Smarandache, Y.Q. Zhang and R. Sunderraman. Single valued neutrosophic sets. *Multi-space Multistructure* 4 (2010) 410-413.
33. J. Vimala and J. Arockia Reeta. Ideal approach on lattice ordered fuzzy soft group and its application in selecting best mobile network coverage among travelling paths. *ARP Journal of Engineering and Applied Sciences* 13(7)(2018) 2414-2421.
34. L.A. Zadeh. Fuzzy sets. *Information and Control* 8 (1965) 338-353.

The Polar form of a Neutrosophic Complex Number

Riad K. Al-Hamido, Mayas Ismail, Florentin Smarandache

Riad K. Al-Hamido, Mayas Ismail, Florentin Smarandache (2020). The Polar form of a Neutrosophic Complex Number. *International Journal of Neutrosophic Science* 10(1), 36-44; DOI: 10.5281/zenodo.4001132 36

Abstract

In this paper, we will define the exponential form of a neutrosophic complex number. We have proven some characteristics and theories, including the conjugate of the exponential form of a neutrosophic complex number, division of the exponential form of a neutrosophic complex numbers, multiplication of the exponential form of a neutrosophic complex numbers. In addition, we have given the method of changing from the exponential to the algebraic form of a complex number.

Keywords : Neutrosophic numbers, neutrosophic complex number, the exponential form of a neutrosophic complex number.

1. Introduction

The American scientist and philosopher F. Smarandache came to place the neutrosophic logic in [1-5], and this logic is as a generalization of the fuzzy logic [6], conceived by L. Zadeh in 1965.

The neutrosophic logic is of great importance in many areas of them, including applications in image processing [7-8], the field of geographic information systems [9], and possible applications to database [10-11], and have applications in the medical field [12-15], and in neutrosophic bitopology in [16-18], and in neutrosophic algebra in [19-23], professor F. Smarandache presented the definition of the standard form of neutrosophic real number and conditions for the division of two neutrosophic real numbers to exist, he defined the standard form of neutrosophic complex number [24], and Y. Alhasan presented the properties of the concept of neutrosophic complex numbers including the conjugate of neutrosophic complex number, division of neutrosophic complex numbers, the inverted neutrosophic complex number and the absolute value of a neutrosophic complex number and theories related to the conjugate of neutrosophic complex numbers, and that the product of a neutrosophic complex number by its conjugate equals the absolute value of number [25].

This paper aims to study and define the exponential form of a neutrosophic complex number by defining the conjugate of the exponential form of a neutrosophic complex number, division of the exponential form of the neutrosophic complex numbers, and multiplication of the exponential form of a neutrosophic complex numbers.

2. Preliminaries

In this section, we present the basic definitions that are useful in this research.

Definition 2.1 [24]

A neutrosophic number has the standard form:

$$a + bI$$

where a, b are real or complex coefficients, and I indeterminacy, such $0.I = 0$

$I^n = I$ for all positive integer n.

If the coefficients a and b are real, and then $a + bI$ is called neutrosophic real number.

For example: $5+7I$

Definition 2.2 [25]

z is a neutrosophic complex number, if it takes the following standard form:

$$z = a + bI + ci + diI$$

Where a, b, c, d are real coefficients, and I indeterminacy, and $i^2 = -1$.

Division of Neutrosophic Real Numbers [24]

$$(a_1 + b_1I) / (a_2 + b_2I) = ?$$

We denote the result by:

$$\frac{a_1 + b_1I}{a_2 + b_2I} = x + yI$$

$$x = \frac{a_1}{a_2}$$

and

$$y = \frac{a_2b_1 - a_1b_2}{a_2(a_2 + b_2)}$$

Definition 2.4 [25]

Suppose that $z = a + bI + ci + diI$ is a neutrosophic complex number, then the absolute value of a neutrosophic complex number defined by the following form:

$$|z| = \sqrt{(a + bI)^2 + (c + dI)^2}$$

3. The Polar form of a Neutrosophic Complex Number

In this section, we present and study the exponential form of a neutrosophic complex number.

Definition 3.1

We define the Exponential Form of a Neutrosophic Complex Number as follows:

$$z = r e^{i(\theta + I)}$$

where r the Absolute Value of the neutrosophic complex number.

Remark 3.1.1:

From the general form:

$$z = a + bI + ci + diI$$

$$z = r \left(\frac{a + bI}{r} + \frac{ci + diI}{r} \right)$$

$$z = r \left(\frac{a + bI}{r} + i \cdot \frac{c + dI}{r} \right)$$

Remark 3.1.2:

$$r = |z| = \sqrt{(a + bI)^2 + (c + dI)^2}$$

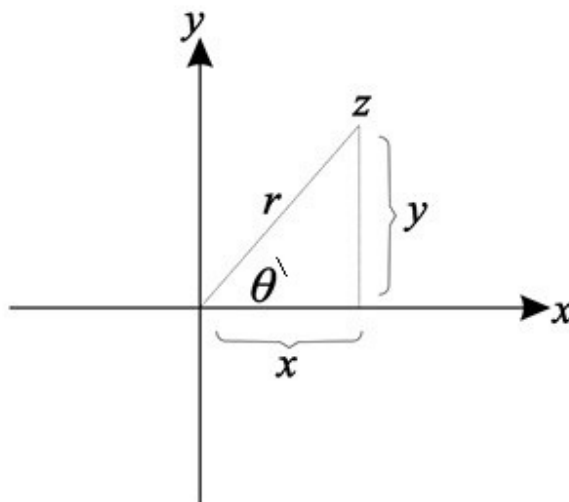

Figure 1: The Geometrical Figure

The formula neutrosophically works in the following way:

$x = a + bI$ is a neutrosophic number whose determinate part is a and indeterminate part is bI , where I indeterminacy;

similarly $y = c + dI$ is a neutrosophic number whose determinate part is c and indeterminate part is dI ;

$\theta + I$ is a neutrosophic angle, whose determinate part is θ (theta) and indeterminate part is I .

It is a big θ (inside the geometrical figure) and small θ in the formulas.

That means that we work with two lengths x and y that are not well-known (they were approximated), and an angle ($\theta + I$) that is not well known either (it was approximated by θ plus some indeterminacy I).

$$\cos(\theta + I) = \frac{x}{r} = \frac{a + bI}{r}, \quad \sin(\theta + I) = \frac{y}{r} = \frac{c + dI}{r}$$

$$z = r(\cos(\theta + I) + i \cdot \sin(\theta + I))$$

Exponential Form:

$$z = r e^{i(\theta + I)}$$

Definition 3.2

Trigonometric formula

$$z = r(\cos(\theta + I) + i \sin(\theta + I))$$

4. Properties

In this section, we present some important properties of the exponential form.

Multiplying the exponential forms of the neutrosophic complex numbers

Suppose that z_1, z_2 are two neutrosophic complex numbers, where

$$z_1 = r_1 e^{i(\theta_1 + I_1)} \text{ and } z_2 = r_2 e^{i(\theta_2 + I_2)}$$

If $I_1 + I_2 = I$

Definition 4.1

$$z_1 \cdot z_2 = r_1 r_2 e^{i(\theta_1 + \theta_2 + I)}$$

Remark 4.1.1:

$$z_1 \cdot z_2 = r_1 e^{i(\theta_1 + I_1)} \cdot r_2 e^{i(\theta_2 + I_2)}$$

$$z_1 \cdot z_2 = r_1 r_2 (e^{i(\theta_1 + I_1)} \cdot e^{i(\theta_2 + I_2)})$$

$$z_1 \cdot z_2 = r_1 r_2 e^{i(\theta_1 + \theta_2 + I_1 + I_2)}$$

$I_1 + I_2 = I$

Then

$$z_1 \cdot z_2 = r_1 r_2 e^{i(\theta_1 + \theta_2 + I)}$$

Example 4.1.2

If $z_1 = r_1 e^{i(\frac{\pi}{4} + I)}$ and $z_2 = r_2 e^{i(\frac{3\pi}{4} + I)}$

$$z_1 \cdot z_2 = r_1 r_2 e^{i(\frac{\pi}{4} + \frac{3\pi}{4} + I)} = r_1 r_2 e^{i(\pi + I)}$$

Division of the exponential forms of neutrosophic complex numbers

Suppose that z_1, z_2 are two neutrosophic complex numbers, where

$$z_1 = r_1 e^{i(\theta_1 + I_1)} \text{ and } z_2 = r_2 e^{i(\theta_2 + I_2)}$$

If $I_1 - I_2 = I$

then

Definition 4.2

$$\frac{z_1}{z_2} = \frac{r_1}{r_2} e^{i(\theta_1 - \theta_2 + I)}$$

Remark 4.2.1:

Depending on [25]

$$z \cdot \bar{z} = |z|^2 = r^2$$

When $r = 1$ we get

$$\bar{z} = \frac{1}{z} = \frac{e^0}{e^{i(\theta+I)}} = e^{-i(\theta+I)}$$

Then

$$\frac{z_1}{z_2} = \frac{r_1 e^{i(\theta_1+I_1)}}{r_2 e^{i(\theta_2+I_2)}}$$

$$\frac{z_1}{z_2} = \frac{r_1}{r_2} \left(\frac{e^{i(\theta_1+I_1)}}{e^{i(\theta_2+I_2)}} \right)$$

$$\frac{z_1}{z_2} = \frac{r_1}{r_2} \left(e^{i(\theta_1+I_1)} \cdot \frac{1}{e^{i(\theta_2+I_2)}} \right)$$

$$\frac{z_1}{z_2} = \frac{r_1}{r_2} \left(e^{i(\theta_1+I_1)} \cdot e^{-i(\theta_2+I_2)} \right)$$

$$I_1 - I_2 = I$$

Then

$$\frac{z_1}{z_2} = \frac{r_1}{r_2} e^{i(\theta_1 - \theta_2 + I)}$$

Example 4.2.2

If $z_1 = r_1 e^{i(\frac{\pi}{4}+I)}$ and $z_2 = r_2 e^{i(\frac{3\pi}{4}+I)}$

$$\frac{z_1}{z_2} = \frac{r_1}{r_2} e^{i(\frac{\pi}{4} - \frac{3\pi}{4} + I)} = \frac{r_1}{r_2} e^{-i(\frac{\pi}{2}+I)}$$

The conjugate of the exponential form of a neutrosophic complex numbers 4.3

Suppose that z is a neutrosophic complex number, where

$$z = r e^{i(\theta+I)}$$

We denote the conjugate of a neutrosophic complex number by \bar{z} and define it by the following form:

$$\bar{z} = r e^{-i(\theta+I)}$$

Example 4.3.1

$$z = r e^{i(\frac{\pi}{2}+I)}$$

$$\bar{z} = r e^{-i(\frac{\pi}{2}+I)}$$

Remark 4.4

If $I = 0$ we will return to the basic formula for the complex number.

$$z = r e^{i(\theta+0)}$$

$$z = r e^{i(\theta)}$$

Conclusion

In this paper, we defined the exponential form of a neutrosophic complex number and demonstrated this with appropriate proof, and many examples were presented to illustrate the concepts introduced in this paper.

Future Research Directions

As a future work, some special cases related to exponential form can be discussed and benefit from this article in many engineering sciences, including theories of control and signal processing.

References

- [1] F. Smarandache, Neutrosophic Precalculus and Neutrosophic Calculus , EuropaNova asbl, Clos du Parnasse, 3E 1000, Bruxelles, Belgium, 2015.
- [2] F. Smarandache, An Introduction to Neutrosophic Probability Applied in Quantum Physics , Bulletin of the American Physical Society, 2009 APS April Meeting, Volume 54, Number 4, Saturday–Tuesday, May 2–5, 2009; Denver, Colorado, USA, <http://meetings.aps.org/Meeting/APR09/Event/102001>.
- [3] F. Smarandache, An Introduction to Neutrosophic Probability Applied in Quantum Physics , SAO/NASA ADS Physics Abstract Service, <http://adsabs.harvard.edu/abs/2009APS..APR.E1078S>.

- [4] F. Smarandache, A Unifying Field in Logics: Neutrosophic Logic, Neutrosophic Set , Neutrosophic Probability and Statistics, (1999), (2000), (2003), (2005).
- [5] F. Smarandache; Huda E.Khalid, Neutrosophic Precalculus and Neutrosophic Calculus , Second enlarged edition, Pons asbl, 5, Quai du Batelage, Brussels, Belgium, European Union, 2018.
- [6] L. Zadeh, Fuzzy sets, Inform and Control , 8, pp.338-353, 1965.
- [7] A. A Salama; I. M Hanafy; Hewayda Elghawalby Dabash M.S, Neutrosophic Crisp Closed Region and Neutrosophic Crisp Continuous Functions , New Trends in Neutrosophic Theory and Applications.
- [8] A. A Salama; Hewayda Elghawalby; M.S. Dabash; A. M. NASR , Retrac Neutrosophic Crisp System For Gray Scale Image , Asian Journal of Mathematics and Computer Research, Vol. 24, 104-117-22, 2018.
- [9] A. A Salama, Basic Structure of Some Classes of Neutrosophic Crisp Nearly Open Sets & Possible Application to GIS Topology , Neutrosophic Sets and Systems, Vol. 7, 18-22, 2015.
- [10] A. A Salama, F. Smarandache, Neutrosophic Crisp Set Theory , Neutrosophic Sets and Systems, Vol. 5, 1-9, 2014.
- [11] F. Smarandache, Neutrosophy and Neutrosophic Logic, First International Conference on Neutrosophy, Neutrosophic Logic, Set, Probability, and Statistics , University of New Mexico, Gallup, NM 87301, USA ,2002.
- [12] M. Abdel-Basset; M. Mai, E. Mohamed; C. Francisco;H. Z. Abd El-Nasser, Cosine similarity measures of bipolar neutrosophic set for diagnosis of bipolar disorder diseases , Artificial Intelligence in Medicine Vol. 101 , 101735,2019.
- [13] M. Abdel-Basset; E. Mohamed; G. Abdulllah; and S. Florentin, A novel model for evaluation Hospital medical care systems based on plithogenic sets , Artificial intelligence in medicine 100, 101710, 2019.
- [14] M. Abdel-Basset; G. Gunasekaran Mohamed; G. Abdulllah. C. Victor, A Novel Intelligent Medical Decision Support Model Based on Soft Computing and IoT , IEEE Internet of Things Journal, Vol. 7, 2019.
- [15] M. Abdel-Basset; G. Abdulllah; G. Gunasekaran; L. Hoang Viet, A novel group decision making model based on neutrosophic sets for heart disease diagnosis , Multimedia Tools and Applications, pp.1-26, 2019.
- [16] R.K. Al-Hamido, Neutrosophic Crisp Supra Bi-Topological Spaces , International Journal of Neutrosophic Science, Vol. 1, 66-73, 2018.
- [17] R.K. Al-Hamido, Neutrosophic Crisp Bi-Topological Spaces , Neutrosophic Sets and Systems, vol. 21, pp.66-73, 2018.
- [18] R.K. Al-Hamido; T. Gharibah; S. Jafari, F.Smarandache, On Neutrosophic Crisp Topology via N-Topology , Neutrosophic Sets and Systems, vol. 21, 96-109, 2018.
- [19] V. Christianto; F. Smarandache; M. Aslam, How we can extend the standard deviation notion with neutrosophic interval and quadruple neutrosophic numbers , International Journal of Neutrosophic Science, vol. 2, No. 2, pp.72-76 , 2020.
- [20] E. O. Adeleke; A. A. A. Agboola; F. Smarandache, Refined Neutrosophic Rings I , International Journal of Neutrosophic Science, vol. 2 , No. 2, pp.77-81 , 2020.
- [21] E. O. Adeleke; A. A. A. Agboola; F. Smarandache, Refined Neutrosophic Rings II , International Journal of Neutrosophic Science, vol 2. , No. 2, pp.89-94 , 2020.
- [22] M. A. Ibrahim; A. A. A. Agboola; E. O. Adeleke; S. A. Akinleye, Introduction to Neutrosophic Subtraction Algebra and Neutrosophic Subtraction Semigroup , International Journal of Neutrosophic Science, vol. 2 , No. 1, pp.47-62 , 2020.
- [23] A. Hatip, The Special Neutrosophic Functions , International Journal of Neutrosophic Science, vol. 4 , No. 2, pp.104-116, 2020.
- [24] F. Smarandache, Introduction to Neutrosophic Statistics , Sitech-Education Publisher, pp.34-44, 2014.
- [25] Y. Alhasan, Concepts of Neutrosophic Complex Numbers , International Journal of Neutrosophic Science, Vol. 8 No. 1, pp. 9-18, 2020.
- [26] Samah Ibrahim Abdel Aal, Mahmoud M. A. Abd Ellatif, Mohamed Monir Hassan: Two Ranking Methods of Single Valued Triangular Neutrosophic Numbers to Rank and Evaluate Information Systems Quality, Neutrosophic Sets and Systems, vol. 19, pp. 132-141, 2018. <http://doi.org/10.5281/zenodo.1235339>

- [27] Faruk Karaaslan: Gaussian single-valued neutrosophic numbers and its application in multi-attribute decision making, *Neutrosophic Sets and Systems*, vol. 22, pp. 101-117, 2018. DOI: 10.5281/zenodo.2159762
- [28] Surapati Pramanik, Rama Mallick: VIKOR based MAGDM Strategy with Trapezoidal Neutrosophic Numbers, *Neutrosophic Sets and Systems*, vol. 22, pp. 118-130, 2018. DOI: 10.5281/zenodo.2160840
- [29] Irfan Deli: Operators on Single Valued Trapezoidal Neutrosophic Numbers and SVTN-Group Decision Making, *Neutrosophic Sets and Systems*, vol. 22, pp. 131-150, 2018. DOI: 10.5281/zenodo.2160120
- [30] Bibhas C. Giri, Mahatab Uddin Molla, Pranab Biswas: TOPSIS Method for MADM based on Interval Trapezoidal Neutrosophic Number, *Neutrosophic Sets and Systems*, vol. 22, pp. 151-167, 2018. DOI: 10.5281/zenodo.2160749

Octagonal Neutrosophic Number: Its Different Representations, Properties, Graphs and De-neutrosophication with the application of Personnel Selection

Muhammad Saqlain, Florentin Smarandache

Muhammad Saqlain, Florentin Smarandache (2020). Octagonal Neutrosophic Number: Its Different Representations, Properties, Graphs and De-neutrosophication with the application of Personnel Selection. *International Journal of Neutrosophic Science*, 8(1), 19-33; DOI: 10.5281/zenodo.3900315

Abstract

To deal with fluctuations in decision-making, fuzzy / neutrosophic numbers are used. The problem having more fluctuations are difficult to solve. Thus it is a dire need to define higher order number, also It is a very curious question by researchers all around the world that how octagonal neutrosophic number can be represented and how to be graphed? In this research article, the primarily focused on the representation and graphs of octagonal neutrosophic number. at last, a case study is done using VIKOR method based on octagonal neutrosophic number. These representations will be helpful in multi-criteria decision making problems in the case that there are large number of fluctuations. Finally, concluded the present work with future directions.

Keywords : Neutrosophic Number, Octagonal Number, VIKOR Method, MCDM, Uncertainty, Indeterminacy, Accuracy Function, De-neutrosophication.

1. Introduction

The theory of uncertainty plays a very important role to solve different issues like modelling in engineering domain. To deal with uncertainty the first concept was given by [1], extended by [2] named as intuitionistic fuzzy numbers. In year 1995, Smarandache proposed the idea of neutrosophic set, and the idea was published in 1998 [3], they have three distinct logic components i) truthfulness ii) indeterminacy iii) falsity. This idea also has a concept of hesitation component the research gets a high impact in different research domain. In neutrosophic, truth membership is noted by T , indeterminacy membership is noted by I , falsity membership is noted by F , These are all independent and their sum is between $0 \leq T + I + F \leq 3$. While when talking about intuitionistic fuzzy sets, uncertainty depends on the degree of membership and non-membership, but in neutrosophic sets then indeterminacy factor does not depend on the truth and falsity value. Neutrosophic fuzzy number can describe about the uncertainty, falsity and hesitation information of real-life problem.

Researchers from different fields developed triangular, trapezoidal and pentagonal neutrosophic numbers, and presented the notions, properties along with applications in different fields [4-6]. The de-neutrosophication technique of pentagonal number and its applications are presented by [7-10].

Scientists from different areas investigated the various properties and fluctuations of neutrosophic numbers and the properties of correlation between these numbers [6-7]. The applications in decision-making in different fields like phone selection [11-12], games prediction [13], supplier selection [14-16], medical [17], personnel selection [18-19].

Octagonal neutrosophic number and its types are presented by [20] in his recent work. The graphical representation and properties are yet to be defined while dealing with the concept of octagonal neutrosophic number a decision-maker can solve more fluctuations because they have more edges as compare to pentagonal. Table:1 represents different numbers and their applicability.

Edge Parameter	Uncertainty Measurement	Hesitation Measurement	Vagueness Measurement	Fluctuations
Crisp number				
Fuzzy number	determinable			
Intuitionistic Fuzzy number	determinable	determinable		
Neutrosophic number	determinable	determinable	determinable	determinable

Table 1: Fuzzy numbers, their extensions and applicability

1.1 Motivation

From the literature, it is found that octagonal neutrosophic numbers (ONN) their notations, graphs and properties are not yet defined. Since it is not yet defined so also it will be a question that how and where it can be applied? For this purpose, is de-neutrosophication important? How should we define membership, indeterminacy and non-membership functions? From this point of view ONN is a good choice for a decision maker in a practical scenario.

1.2 Novelties

The work contributed in this research is;

- Membership, Non-membership and Indeterminacy functions
- Graphical Representation of ONN.
- De-neutrosophication technique of ONN.
- Case study of personnel selection having octagonal fluctuations.

1.3 Structure of Paper

The article is structured as follows as shown in the Figure 1:

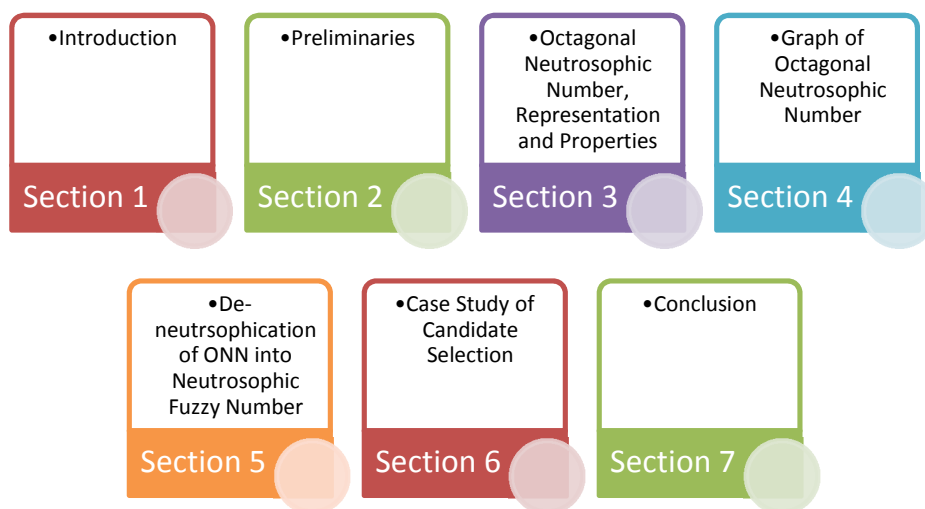

Figure 1: Pictorial view of the structure of the article

2. Preliminaries

Definition 2.1: Fuzzy Number [1]

A fuzzy number is generalized form of a real number. It doesn't represent a single value, instead a group of values, where each entity has its membership value between [0, 1]. Fuzzy number \tilde{S} is a fuzzy set in R if it satisfies the given conditions.

- \exists relatively one $y \in R$ with $\mu_{\tilde{S}}(y) = 1$.
- $\mu_{\tilde{S}}(y)$ is piecewise continuous.
- \tilde{S} should be convex and normal.

Definition 2.2: Neutrosophic Fuzzy Number [3]

Let U be a universe of discourse then the neutrosophic set A is an object having the form

$$A = \{ x: T_A(x), I_A(x), F_A(x), ; x \in U \}$$

where the functions $T, I, F: U \rightarrow [0,1]$ define respectively the degree of membership, the degree of indeterminacy, and the degree of non-membership of the element $x \in X$ to the set A with the condition. $0 \leq T_A(x) + I_A(x) + F_A(x) \leq 3$.

Definition 2.3: Accuracy Function [21]

Accuracy function is used to convert neutrosophic number NFN into fuzzy number (De-neutrosophication using A_F).

$$A(F) = \{ x = \frac{[T_x + I_x + F_x]}{3} \}$$

A_F represents the De-neutrosophication of neutrosophic number into fuzzy number.

Definition 2.4: Pentagonal Neutrosophic Number [6]

Pentagonal Neutrosophic Number PNN is defined as,

$$PNN = \{ (\Omega, \square, \xi, \varphi, \varepsilon) \Theta \}, [(\Omega^1, \square^1, \xi^1, \varphi^1, \varepsilon^1) \Psi], [(\Omega^2, \square^2, \xi^2, \varphi^2, \varepsilon^2):] \}$$

Where $\Theta, \Psi, \in [0,1]$.

The truth membership function (Θ): $\mathbb{R} \rightarrow [0, 6]$,

the indeterminacy membership function (Ψ): $\mathbb{R} \rightarrow [8, 1]$,

and the falsity membership function (ε): $\mathbb{R} \rightarrow [, 1]$.

3. Octagonal Neutrosophic Number [ONN] Representation and Properties

In this section, we define ONN, representations and properties along with suitable examples.

Definition 3.1: Side Conditions of Octagonal Neutrosophic Number [ONN]

An Octagonal Neutrosophic Number denoted by;

$\hat{S} \{ (\Omega, \square, \xi, \varphi, \varepsilon, \delta, \zeta) \Theta \}, [(\Omega^1, \square^1, \xi^1, \varphi^1, \varepsilon^1, \delta^1, \zeta^1) \Psi], [(\Omega^2, \square^2, \xi^2, \varphi^2, \varepsilon^2, \delta^2, \zeta^2):] \}$ should satisfy the following conditions:

Condition 1:

1. $\Theta_{\hat{S}}$: truth membership function ($\Theta_{\hat{S}}$): $\mathbb{R} \rightarrow [0, 1]$,
2. $\Psi_{\hat{S}}$: indeterminacy membership function ($\Psi_{\hat{S}}$): $\mathbb{R} \rightarrow [8, 1]$,
3. $\varepsilon_{\hat{S}}$: falsity membership function ($\varepsilon_{\hat{S}}$): $\mathbb{R} \rightarrow [, 1]$.

Condition 2:

1. Θ_{δ} : truth membership function is strictly non-decreasing continuous function on the intervals $[\Omega, \varepsilon]$.
2. Ψ_{δ} : indeterminacy membership function is strictly non-decreasing continuous function on the intervals $[\Omega^1, \varepsilon^1]$.
3. ς : falsity membership function is strictly non-decreasing continuous function on the intervals $[\Omega^2, \varepsilon^2]$.

Condition 3:

1. Θ_{δ} : truth membership function is strictly non-increasing continuous function on the intervals $[\varepsilon, \Omega]$.
2. Ψ_{δ} : indeterminacy membership function is strictly non-increasing continuous function on the intervals $[\varepsilon^1, \Omega^1]$.
3. ς : falsity membership function is strictly non-increasing continuous function on the intervals $[\varepsilon^2, \Omega^2]$.

Definition 3.2 : Octagonal Neutrosophic Number [ONN] A Neutrosophic Number denoted by \hat{S} is defined as,

$$\hat{S} = \{ (\Omega, \square, \varepsilon, \nu, \varepsilon, \delta, \delta, \delta) \Theta, [(\Omega^1, \square^1, \varepsilon^1, \nu^1, \varepsilon^1, \delta^1, \delta^1, \delta^1) \Psi], [(\Omega^2, \square^2, \varepsilon^2, \nu^2, \varepsilon^2, \delta^2, \delta^2, \delta^2) \varsigma] \}$$

Where $\Theta, \Psi, \varsigma \in [0,1]$.

The truth membership function $(\Theta_{\delta}): \mathbb{R} \rightarrow [0,1]$,

the indeterminacy membership function $(\Psi_{\delta}): \mathbb{R} \rightarrow [\delta, 1]$,

and the falsity membership function $(\varsigma): \mathbb{R} \rightarrow [0, 1]$ are given as:

$$\Theta_{\delta}(x) = \begin{cases} \Theta_{\delta 0}(x) & \Omega \leq x < \square \\ \Theta_{\delta 1}(x) & \square \leq x < \varepsilon \\ \Theta_{\delta 2}(x) & \varepsilon \leq x < \nu \\ \Theta_{\delta 3}(x) & \nu \leq x < \varepsilon \\ \delta & x = \varepsilon \\ \Theta_{\delta 3}(x) & \varepsilon \leq x < \delta \\ \Theta_{\delta 2}(x) & \delta \leq x < \delta^1 \\ \Theta_{\delta 1}(x) & \delta^1 \leq x < \delta^1 \\ 0 & \text{otherwise} \end{cases}$$

$$\Psi_{\delta}(x) = \begin{cases} \Psi_{\delta 0}(x) & \Omega^1 \leq x < \square^1 \\ \Psi_{\delta 1}(x) & \square^1 \leq x < \varepsilon^1 \\ \Psi_{\delta 2}(x) & \varepsilon^1 \leq x < \nu^1 \\ \Psi_{\delta 3}(x) & \nu^1 \leq x < \varepsilon^1 \\ \delta & x = \varepsilon^1 \\ \Psi_{\delta 3}(x) & \varepsilon^1 \leq x < \delta^1 \\ \Psi_{\delta 2}(x) & \delta^1 \leq x < \delta^1 \\ \Psi_{\delta 1}(x) & \delta^1 \leq x < \delta^1 \\ 1 & \text{otherwise} \end{cases}$$

$$\hat{s}(x) \begin{cases} \hat{s}_0(x) & \Omega^2 \leq x < \square^2 \\ \hat{s}_1(x) & \square^2 \leq x < \xi^2 \\ \hat{s}_2(x) & \xi^2 \leq x < \nu^2 \\ \hat{s}_3(x) & \nu^2 \leq x < \varepsilon^2 \\ & x = \varepsilon^2 \\ \hat{s}_3(x) & \varepsilon^2 \leq x < \quad^2 \\ \hat{s}_2(x) & \quad^2 \leq x < \acute{o}^2 \\ \hat{s}_1(x) & \acute{o}^2 \leq x < 3^2 \\ 1 & \text{otherwise} \end{cases}$$

Where $\hat{S} \{ (\Omega < \square < \xi < \nu < \varepsilon < \quad < \acute{o} < 3) : \Theta \}, [(\Omega^1 < \square^1 < \xi^1 < \nu^1 < \varepsilon^1 < \quad^1 < \acute{o}^1 < 3^1) : \Psi], [(\Omega^2 < \square^2 < \xi^2 < \nu^2 < \varepsilon^2 < \quad^2 < \acute{o}^2 < 3^2) : \Upsilon \}$

4. Gra phical Repres entation of Octa gonal Neutroso phic Number [O NN]

In this section, graphs of truthiness, indeterminacy and falsity function are presented.

Definition 4.1: Octagonal Neutrosophic Number [ONN]

$$\Theta_{\hat{s}}(x) \begin{cases} \Theta_{\hat{s}_0}(0) & 0.1 \leq x < 0.2 \\ \Theta_{\hat{s}_1}(0) & 0.2 \leq x < 0.3 \\ \Theta_{\hat{s}_2}(0.1) & 0.3 \leq x < 0.4 \\ \Theta_{\hat{s}_3}(0.1) & 0.4 \leq x < 0.5 \\ 1 & x = 0.5 \\ \Theta_{\hat{s}_3}(1) & 0.5 \leq x < 0.6 \\ \Theta_{\hat{s}_2}(0.1) & 0.6 \leq x < 0.7 \\ \Theta_{\hat{s}_1}(0.1) & 0.7 \leq x < 0.8 \\ 0 & \text{otherwise} \end{cases}$$

$$\Psi_{\hat{s}}(x) \begin{cases} \Psi_{\hat{s}_0}(1) & 0.1 \leq x < 0.2 \\ \Psi_{\hat{s}_1}(1) & 0.2 \leq x < 0.3 \\ \Psi_{\hat{s}_2}(0.9) & 0.3 \leq x < 0.4 \\ \Psi_{\hat{s}_3}(0.9) & 0.4 \leq x < 0.5 \\ 0 & x = 0.5 \\ \Psi_{\hat{s}_3}(0) & 0.5 \leq x < 0.6 \\ \Psi_{\hat{s}_2}(0.9) & 0.6 \leq x < 0.7 \\ \Psi_{\hat{s}_1}(0.9) & 0.7 \leq x < 0.8 \\ 1 & \text{otherwise} \end{cases}$$

$$\hat{s}(x) \begin{cases} \hat{s}_0(1) & 0.1 \leq x < 0.2 \\ \hat{s}_1(1) & 0.2 \leq x < 0.3 \\ \hat{s}_2(0.9) & 0.3 \leq x < 0.4 \\ \hat{s}_3(0.9) & 0.4 \leq x < 0.5 \\ 0 & x = 0.5 \\ \hat{s}_3(0) & 0.5 \leq x < 0.6 \\ \hat{s}_2(0.9) & 0.6 \leq x < 0.7 \\ \hat{s}_1(0.9) & 0.7 \leq x < 0.8 \\ 1 & \text{otherwise} \end{cases}$$

4.1 Graphical Representation of Membership, Non-membership, Indeterminacy and ONN

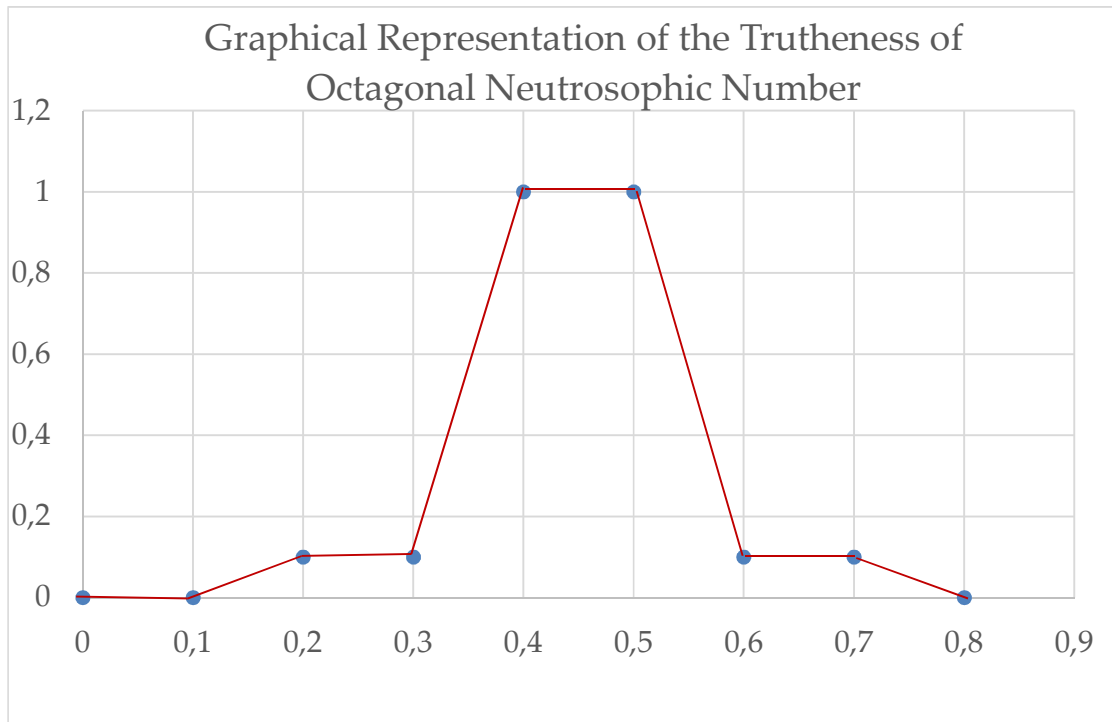

Figure 2: Graphical representation of the truthiness of ONN

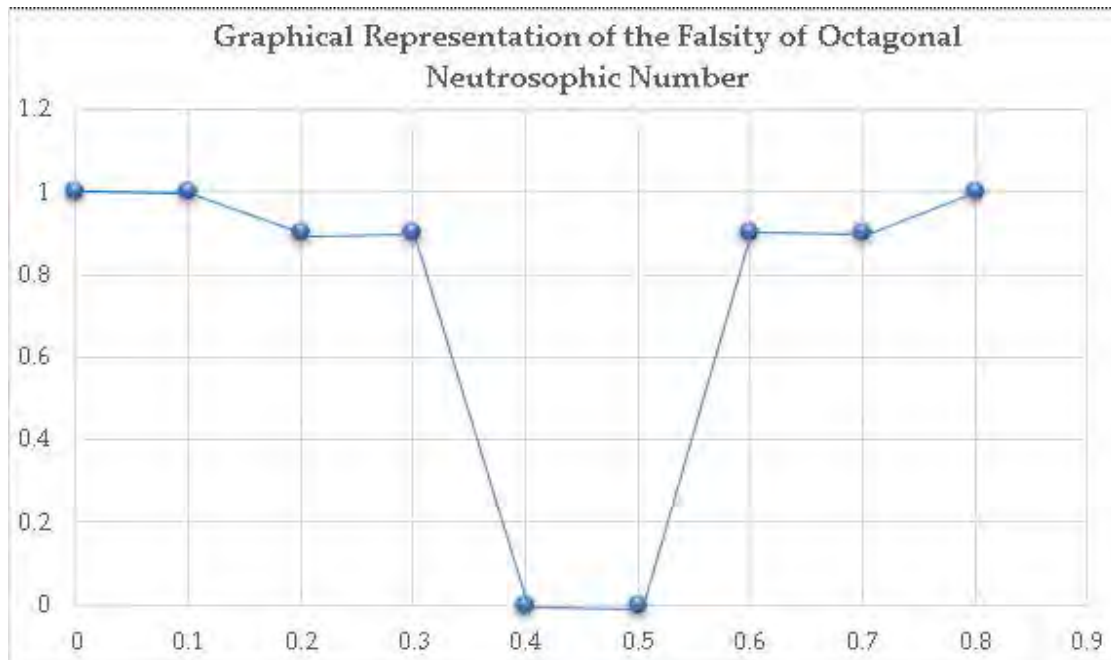

Figure 3: Graphical representation of the Falsity of ONN

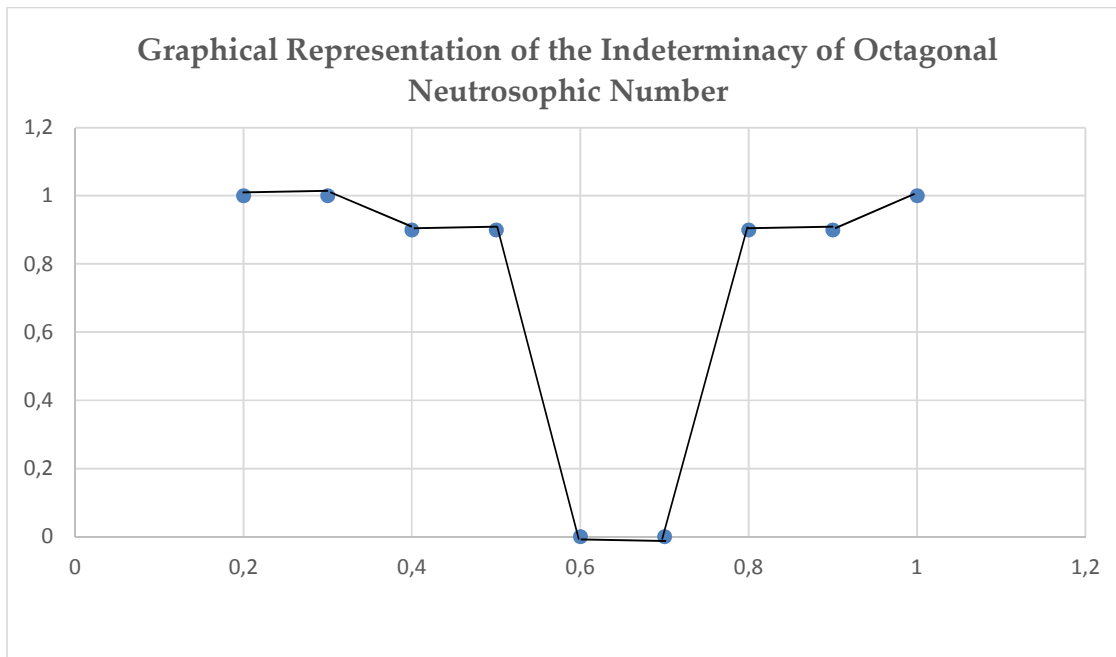

Figure 4: Graphical representation of the Indeterminacy of ONN

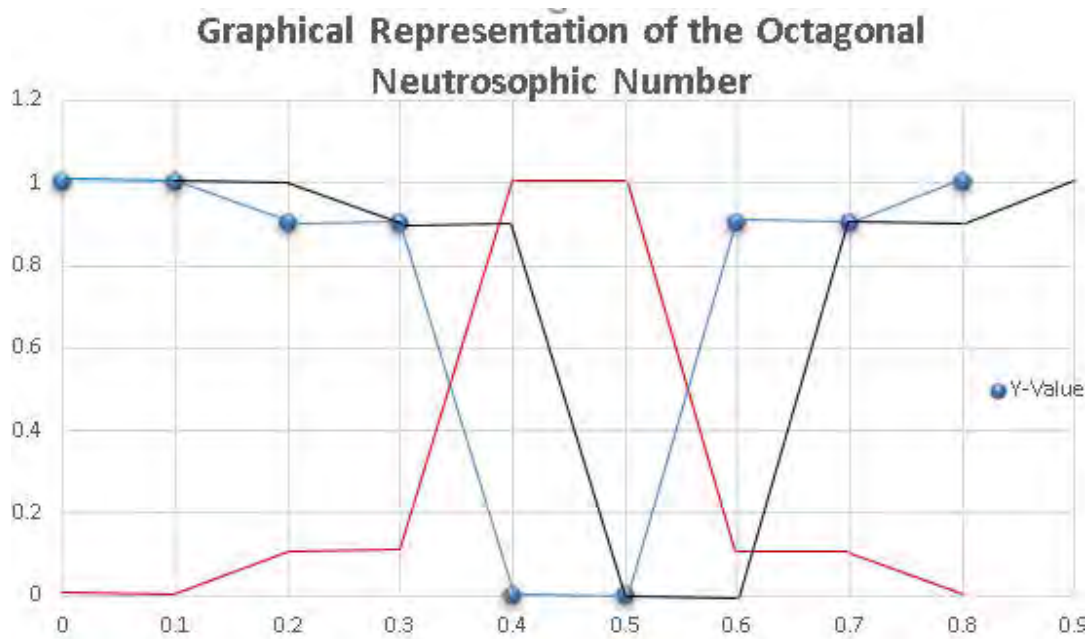

Figure 5: Graphical representation of the Octagonal Neutrosophic Number

5. Accuracy Function for De-neutrosophication of Octagonal Neutrosophic Number (ONN)

5.1 De-neutrosophication of ONN into Neutrosophic Number

On the way of development of De-neutrosophication technique, we can generate results into neutrosophic number according to the result of octagonal neutrosophic number and its membership functions.

$$D^{TNO_N} = \left(\frac{\Omega + \square + \xi + \nu + \varepsilon + \delta + \zeta}{8} \right),$$

$$D^{INO_N} = \left(\frac{\Omega^1 + \square^1 + \xi^1 + \nu^1 + \varepsilon^1 + \delta^1 + \zeta^1}{8} \right),$$

$$D^{FNO_N} = \left(\frac{\Omega^2 + \square^2 + \xi^2 + \nu^2 + \varepsilon^2 + \delta^2 + \zeta^2}{8} \right)$$

$$D_{NO_N} = \left\{ \frac{\Omega + \square + \xi + \nu + \varepsilon + \delta + \zeta}{8}, \frac{\Omega^1 + \square^1 + \xi^1 + \nu^1 + \varepsilon^1 + \delta^1 + \zeta^1}{8}, \frac{\Omega^2 + \square^2 + \xi^2 + \nu^2 + \varepsilon^2 + \delta^2 + \zeta^2}{8} \right\}$$

$$D_{NO_F} = \frac{D^{TNO_N} + D^{INO_N} + D^{FNO_N}}{3},$$

- D^{TNO_N} represents the de-neutrosophication of trueness of neutrosophic octagonal number into neutrosophic.
- D^{INO_N} represents the de-neutrosophication of indeterminacy of neutrosophic octagonal number into neutrosophic.
- D^{FNO_N} represents the de-neutrosophication of falsity of neutrosophic octagonal number into neutrosophic.
- D_{NO_N} represents the de-neutrosophication of octagonal number into neutrosophic number.

Example 1: In Table: 3 five octagonal neutrosophic numbers ONN are defuzzified into Neutrosophic Number.

	Octagonal Neutrosophic Number	D_{NO_N}
1	(0.1,0.2,0.3,0.4,0.5,0.6,0.7,0.8;0.2,0.3,0.4,0.5,0.6,0.7,0.8,0.9; 0.1,0.3,0.4,0.5,0.6,0.7,0.8,0.9)	(0.45,0.55,0.5375)
2	(0.2,0.3,0.4,0.5,0.6,0.7,0.8,0.9;0.1,0.3,0.4,0.5,0.6,0.7,0.8,0.9; 0.2,0.3,0.4,0.5,0.6,0.7,0.8,0.9)	(0.55,0.5375,0.55)
3	(0.1,0.2,0.3,0.4,0.5,0.6,0.7,0.9;0.1,0.2,0.3,0.4,0.5,0.6,0.7,0.8; 0.1,0.2,0.4,0.5,0.6,0.7,0.8,0.9)	(0.4625,0.45,0.525)
4	(0.1,0.2,0.4,0.5,0.6,0.7,0.8,0.9; 0.1,0.3,0.4,0.5,0.6,0.7,0.8,0.9; 0.2,0.3,0.4,0.5,0.6,0.7,0.8,0.9)	(0.45,0.5375,0.55)
5	(0.2,0.3,0.4,0.5,0.6,0.7,0.8,0.9; 0.1,0.2,0.3,0.4,0.5,0.6,0.7,0.8; 0.1,0.2,0.3,0.4,0.5,0.6,0.7,0.9)	(0.55,0.45,0.4625)

Table 2: De-neutrosophication of ONN into Neutrosophic number using Accuracy Function.

5.2 De-neutrosophication of Neutrosophic Number

On the way of development of de-Neutrosophication technique, we can generate results into fuzzy number according to the result of neutrosophic number.

$$D_{NO_F} = \frac{D^{TNO_N} + D^{INO_N} + D^{FNO_N}}{3},$$

D_{NO_F} represents the de-neutrosophication of octagonal number into fuzzy number.

Example 2: In Table: 3 five octagonal neutrosophic numbers are defuzzified into Fuzzy.

	Octagonal Neutrosophic Number	D_{NO_N}	D_{NO_F}
1	(0.1,0.2,0.3,0.4,0.5,0.6,0.7,0.8;0.2,0.3,0.4,0.5,0.6,0.7,0.8,0.9; 0.1,0.3,0.4,0.5,0.6,0.7,0.8,0.9)	(0.45,0.55,0.5375)	0.5125
2	(0.2,0.3,0.4,0.5,0.6,0.7,0.8,0.9;0.1,0.3,0.4,0.5,0.6,0.7,0.8,0.9; 0.2,0.3,0.4,0.5,0.6,0.7,0.8,0.9)	(0.55,0.5375,0.55)	0.54583
3	(0.1,0.2,0.3,0.4,0.5,0.6,0.7,0.9;0.1,0.2,0.3,0.4,0.5,0.6,0.7,0.8; 0.1,0.2,0.4,0.5,0.6,0.7,0.8,0.9)	(0.4625,0.45,0.525)	0.47916
4	(0.1,0.2,0.4,0.5,0.6,0.7,0.8,0.9; 0.1,0.3,0.4,0.5,0.6,0.7,0.8,0.9; 0.2,0.3,0.4,0.5,0.6,0.7,0.8,0.9)	(0.45,0.5375,0.55)	0.5125
5	(0.2,0.3,0.4,0.5,0.6,0.7,0.8,0.9; 0.1,0.2,0.3,0.4,0.5,0.6,0.7,0.8; 0.1,0.2,0.3,0.4,0.5,0.6,0.7,0.9)	(0.55,0.45,0.4625)	0.4875

Table 3: De-neutrosophication of ONN using Accuracy Function.

6. Case Study

To demonstrate the;

- Feasibility
- Productiveness

of the proposed method, here is the most useful real-life candidate selection problem is presented.

6.1 Problem Formulation

Suppose we have three candidates which have different degree, experience and number of publications, the thing which matter the most to select one which have more potential to deal with situation. The potential of person depends upon degree, experience and number of publications they have. To improve the competitiveness capability, the best selection plays an important role, and to select the best one. Due to octagonal we can deal with more fluctuations. The background of formal education comparison also necessary. Same case for experience because it illustrates the personality and also mention that person is capable to handle the circumstances. Same as publications is also important for selection. With the concept of octagonal we have more expanse to deal with more edges. Suppose we are talking about degree we can mention his all necessary degrees with grades.

6.2 Parameters

Selection is a complex issue, to resolve this problem criteria and alternative plays an important role. Following criteria and alternatives are considered in this problem formulation.

6.2.1 Alternatives

Candidates are considered as the set of alternatives represented with $\check{S} = \langle \zeta, \varpi, \nu \rangle$

6.2.2. Criteria

Following three criteria are considered for the selection

- Degree
- Experience
- Publications

6.3 Assumptions

The decision makers $\{D_1, D_2, D_3, D_4, D_5, D_6, D_7, D_8\}$ will assign ONN, according to his own interest, knowledge and experience, to the above-mentioned criteria and alternatives.

- o Assigning Octagonal Neutrosophic Number ONN, by decision makers to the candidate ζ .

Sr	No	Criteria	Octagonal Neutrosophic Number (ONN)
1		Degree	$\langle (0.72,0.35,0.71,0.77,0.41,0.73,0.77,0.81), (0.93,0.83,0.93,0.88,0.94,0.99,0.96,0.90), (0.86,0.95,0.99,0.97,0.94,0.93,0.95,0.91) \rangle$
2		Experience	$\langle (0.75,0.65,0.96,0.54,0.73,0.65,0.83,0.56), (0.75,0.45,0.95,0.38,0.68,0.79,0.57,0.13), (0.36,0.59,0.68,0.79,0.47,0.36,0.47,0.95) \rangle$
3		Publications	$(0.74,0.73,0.64,0.75,0.96,0.34,0.85,0.89), (0.35,0.46,0.58,0.79,0.85,0.71,0.64,0.96), (0.84,0.73,0.85,0.75,0.98,0.84,0.66,0.94)$

Table 4(a): ONN by decision makers to each criterion to the candidate ζ .

- o Assigning Octagonal Neutrosophic Number ONN, by decision makers to the candidate ϖ .

Sr	No	Criteria	Octagonal Neutrosophic Number (ONN)
1		Degree	$\langle (0.73,0.73,0.94,0.85,0.96,0.74,0.95,0.89), (0.33,0.46,0.59,0.79,0.85,0.79,0.74,0.86), (0.48,0.33,0.55,0.75,0.68,0.64,0.36,0.70) \rangle$
2		Experience	$\langle (0.75,0.55,0.96,0.54,0.93,0.65,0.73,0.56), (0.93,0.83,0.83,0.58,0.84,0.69,0.76,0.80), (0.66,0.59,0.68,0.99,0.47,0.46,0.87,0.95) \rangle$
3		Publications	$(0.94,0.93,0.74,0.95,0.96,0.94,0.85,0.99), (0.28,0.26,0.58,0.35,0.45,0.61,0.64,0.36), (0.28,0.23,0.25,0.45,0.68,0.44,0.26,0.34)$

Table 4(b): ONN by decision makers to each criterion to the candidate ϖ .

- o Assigning Octagonal Neutrosophic Number ONN, by decision makers to the candidate υ .

Sr	No	Criteria	Octagonal Neutrosophic Number (ONN)
1		Degree	$\langle (0.73,0.83,0.93,0.56,0.95,0.95,0.73,0.88), (0.76,0.95,0.69,0.94,0.94,0.63,0.55,0.61), (0.74,0.73,0.85,0.75,0.48,0.34,0.66,0.74) \rangle$
2		Experience	$\langle (0.73,0.65,0.96,0.54,0.63,0.65,0.81,0.59), (0.75,0.45,0.85,0.38,0.78,0.79,0.67,0.13), (0.38,0.59,0.68,0.79,0.97,0.36,0.67,0.85) \rangle$
3		Publications	$(0.74,0.73,0.64,0.75,0.96,0.34,0.85,0.89), (0.35,0.44,0.58,0.79,0.75,0.71,0.54,0.96), (0.74,0.63,0.35,0.35,0.98,0.34,0.28,0.64)$

Table 4(c): ONN by decision makers to each criterion to the candidate υ .

6.4 VIKOR Method

Vikor method is best for solve the problem of multi criteria decision making, it is used to drive on ranking and for selection of a set of possibilities and solve consolation solution for a problem with aggressive criteria. Opricovic [12] introduced the idea of Vikor method in 1998. It is related with both positive and the negative ideal solution, it can change the variable into two or more alternative variables to find out the best compromise solution. By the help of Vikor method we can put new ideas for group decision making problem under the certain criteria.

Vikor Method consist of following steps;

Step 1. Normalization of decision matrix and weight assigning.

Step 2. Now we will calculate the group unity value $\tilde{H}_i [H_i^L, H_i^U]$ and the individual regard value $\tilde{S}_i [S_i^L, S_i^U]$, where;

$$H_i^L = \sum_j \frac{S_i^L - S_j^+}{S_i^L - S_j^+}, H_i^U = \sum_j \frac{S_i^U - S_j^-}{S_i^U - S_j^-}$$

and

$$S_i^L = \max_{1 \leq j \leq n} w_j \left\{ \frac{s_{ij}^L - s_j^+}{s_j^- - s_j^+} \right\}, S_i^U = \max_{1 \leq j \leq n} w_j \left\{ \frac{s_{ij}^U - s_j^+}{s_j^- - s_j^+} \right\}$$

Step 3. Here we will Calculate the comprehensive sorting index $\tilde{W}_i = [W_i^L, W_i^U]$, where

$$\tilde{W}_i = \frac{H_i - H^*}{H^- - H^*} + (1 - \alpha) \frac{S_i - S^*}{S^- - S^*}$$

Now by using algorithm of interval fuzzy number:

$$W_i^L = \frac{H_i^L - H^*}{H^- - H^*} + (1 - \alpha) \frac{S_i^L - S^*}{S^- - S^*}$$

and

$$W_i^U = \frac{H_i^U - H^*}{H^- - H^*} + (1 - \alpha) \frac{S_i^U - S^*}{S^- - S^*}$$

Here $H^* = \min_i H_i^L, H^- = \max_i H_i^U, S^* = \min_i S_i^L, S^- = \max_i S_i^U$. Parameter α is called decision mechanism index, and it lies between $[0,1]$. If $\alpha = 0.5$, it is the decision making in the light of maximum group benefit (i.e., if α is big, group utility is emphasized); if $\alpha < 0.5$, here decision making in accordance with compromise. If $\alpha > 0.5$, it is the decision making in the light of minimum individual regret value. In VIKOR, we take $\alpha = 0.5$ generally, that is called compromise makes maximum group benefit and minimum individual regret value.

Step 4. The rank of fuzzy numbers is \tilde{S}_i, \tilde{W}_i and \tilde{H}_i .

Since \tilde{S}_i, \tilde{W}_i and \tilde{H}_i are all still individual numbers, now to compare the two-interval value we use the possible degree theory.

Here number of interval number $\check{A}_i = [A_i^L, A_i^U], (i = 1, 2, 3, \dots, m)$, the comparison steps are given of these interval numbers;

- (a) For any two intervals numbers $\check{A}_i = [A_i^L, A_i^U]$ and $\check{A}_j = [A_j^L, A_j^U]$, now we will calculate the possible degree $\rho_{ij} = \rho(\check{A}_i \geq \check{A}_j)$ and now we will construct the possible degree matrix $\rho = (\rho_{ij})_{m \times m}$, and the product by comparison of any two interval numbers $\check{A}_i = [A_i^L, A_i^U]$ and $\check{A}_j = [A_j^L, A_j^U]$, where $i, j = 1, 2, 3, \dots, m$. Xu [18] proved that matrix $\rho = (\rho_{ij})_{m \times m}$ satisfies $(\rho_{ij} \geq 0, \rho_{ij} + \rho_{ji} = 1, \rho_{ii} = 0.5 (i, j = 1, 2, 3, \dots, m))$

The matrix $\rho = (\rho_{ij})_{m \times m}$ is called the fuzzy complementary judgement matrix, and we can rank the alternatives as follow.

- (b) The rank of interval numbers $\check{A}_i = [A_i^L, A_i^U], (i = 1, 2, 3, \dots, m)$

Ranking formula is given below

$$U_i = \frac{1}{m(m-1)} \left(\sum_{j=1}^m \rho_{ij} + \frac{m}{2} - 1 \right), i = 1, 2, 3, \dots, m$$

The smaller U_i , is the smaller $\check{A}_i = [A_i^L, A_i^U]$ is.

Step 5. Now we will rank the alternatives based on \check{S}_i, \tilde{W}_i and $\tilde{H}_i (i = 1, 2, 3, \dots, m)$. here the smaller of interval number \check{S}_i is, and the better alternative x_i is. propose as a min $\{\check{S}_i \mid i = 1, 2, 3, \dots, m\}$ if these two condition are satisfied[16]:

- (i) $S(A^{(2)}) \leq S(A^{(1)}) - 1/(m - 1)$, where $A^{(2)}$ called the second alternative with second position in the ranking list by \mathcal{R} ; m is the number of alternatives.
- (ii) $A^{(1)}$ alternative also must be best ranked by $\{S_i \text{ or/and } \mathcal{R}_i \mid i = 1, 2, 3 \dots m\}$.



Figure 6: Flowchart of VIKOR algorithm

6.5 Numerical Analysis

Suppose that U is the universal set. Let HR which is responsible for recruiting and interviewing, and wants to hire a new candidate in company. Three candidates $\mathcal{S} = \langle \zeta, \varpi, \nu \rangle$ apply for this opportunity, which have different degrees, experiences and publications. On the base of choice parameters $\{C_1 = \text{Dergre}, C_2 = \text{Experience}, C_3 = \text{Publication}\}$ we apply the algorithm to find the potential candidate.

Step 1. Associated Decision Matrix

Candidate= ζ	Candidate= ϖ	Candidate= ν
$\{C_1(0.72,0.35,0.71,0.77,0.41,0.73,0.77,0.81)$	$\{C_1(0.73,0.73,0.94,0.85,0.96,0.74,0.95,0.89)$	$\{C_1(0.73,0.83,0.93,0.56,0.95,0.95,0.73,0.88)$
$(0.93,0.83,0.93,0.88,0.94,0.99,0.96,0.90)$	$(0.33,0.46,0.59,0.79,0.85,0.79,0.74,0.86)$	$(0.76,0.95,0.69,0.94,0.94,0.63,0.55,0.61)$
$(0.86,0.95,0.99,0.97,0.94,0.93,0.95,0.91)$	$(0.48,0.33,0.55,0.75,0.68,0.64,0.36,0.70)$	$(0.74,0.73,0.85,0.75,0.48,0.34,0.66,0.74)$
$\{C_2(0.75,0.65,0.96,0.54,0.73,0.65,0.83,0.56)$	$\{C_2(0.75,0.55,0.96,0.54,0.93,0.65,0.73,0.56)$	$\{C_2(0.73,0.65,0.96,0.54,0.63,0.65,0.81,0.59)$
$(0.75,0.45,0.95,0.38,0.68,0.79,0.57,0.13)$	$(0.93,0.83,0.83,0.58,0.84,0.69,0.76,0.80)$	$(0.75,0.45,0.85,0.38,0.78,0.79,0.67,0.13)$
$(0.36,0.59,0.68,0.79,0.47,0.36,0.47,0.95)$	$(0.66,0.59,0.68,0.99,0.47,0.46,0.87,0.95)$	$(0.38,0.59,0.68,0.79,0.97,0.36,0.67,0.85)$
$\{C_3(0.74,0.73,0.64,0.75,0.96,0.34,0.85,0.89)$	$\{C_3(0.94,0.93,0.74,0.95,0.96,0.94,0.85,0.99)$	$\{C_3(0.74,0.73,0.64,0.75,0.96,0.34,0.85,0.89)$
$(0.35,0.46,0.58,0.79,0.85,0.71,0.64,0.96)$	$(0.28,0.26,0.58,0.35,0.45,0.61,0.64,0.36)$	$(0.35,0.44,0.58,0.79,0.75,0.71,0.54,0.96)$
$(0.84,0.73,0.85,0.75,0.98,0.84,0.66,0.94)$	$(0.28,0.23,0.25,0.45,0.68,0.44,0.26,0.34)$	$(0.74,0.63,0.35,0.35,0.98,0.34,0.28,0.64)$

De-Neutrosophication of Octagonal Neutrosophic number by,

$$D^{TNO_N} = \left(\frac{\Omega + \square + \varepsilon + \nu + \varepsilon + \square + \delta + 3}{8} \right), D^{INO_N} = \left(\frac{\Omega^1 + \square^1 + \varepsilon^1 + \nu^1 + \varepsilon^1 + \square^1 + \delta^1 + 3^1}{8} \right), D^{FNO_N} = \left(\frac{\Omega^2 + \square^2 + \varepsilon^2 + \nu^2 + \varepsilon^2 + \square^2 + \delta^2 + 3^2}{8} \right)$$

The associated neutrosophic matrix is,

$$X = \begin{pmatrix} (0.65,0.92,0.93) & (0.84,0.67,0.56) & (0.82,0.88,0.66) \\ (0.70,0.59,0.58) & (0.70,0.78,0.70) & (0.69,0.60,0.66) \\ (0.86,0.66,0.82) & (0.91,0.44,0.36) & (0.73,0.64,0.49) \end{pmatrix}$$

The associated fuzzy matrix is,

$$X = \begin{pmatrix} (0.8333) & (0.6900) & (0.7866) \\ (0.6233) & (0.7266) & (0.6500) \\ (0.7800) & (0.5700) & (0.6200) \end{pmatrix}$$

After calculating normalized decision matrix, we determine the positive ideal solution as well as negative ideal solution

$$r^+ \{(0.65,0.92,0.93)\} \quad r^- \{(0.91,0.44,0.36)\}$$

Step 2. Calculate the group utility value as $\check{H}_i [H_i^L, H_i^U]$ and $\check{S}_i [S_i^L, S_i^U]$

$$\check{H}_1 [0.2769,0.2000] \quad \check{H}_2 =[0.1076,0.3846] \quad \check{H}_3 =[0.4230,0.2230]$$

And $\check{S}_1 =[0.1461,0.1615] \quad \check{S}_2 =[0.0384,0.2000] \quad \check{S}_3 [0.2000,0.1307]$

Step 3. Now we will calculate the comprehensive sorting index $\check{W}_i [W_i^L, W_i^U]$

W1 0.0506

W2 0.0275

W3 0.0163

Step 4. Calculation of H_i, W_i and S_i

S1 0.2767 H1 0.1088 W1 0.0506

S2 0.2394 H2 0.1165 W2 0.0275

S3 0.2530 H3 0.1066 W3 0.0163

Step 5. Orderi ng of H_i, W_i and S_i

Order the alternatives, listed by the values Si; Hi and Wi:

S2 0.2394 H3 0.1066 W3 0.0163

S3 0.2530 H1 0.1088 W2 0.0275

S1 0.2767 H2 0.1165 W1 0.0506

According to the ranking S3 is the potential candidate for the company.

7. Conclusion

The concept of octagonal neutrosophic number has sufficient scope of utilization in different studies in various domain. In this paper, we proposed a new concept of octagonal neutrosophic number ONN, notion and graphical representation. The de-neutrosophication technique is carried out by implementing accuracy function and following points were concluded.

- The octagonal neutrosophic number, function and graph add a new tool for modeling different aspects of daily life issues, science and environment.
- Since this study has not yet been studied yet, the comparative study cannot be done with the existing methods.

- Detailed illustrations of truthiness, indeterminacy, falsity and de-neutrosophication techniques will provide all the required information in one platform to model any real-world problem.

In forthcoming work, authors will define the types Symmetric, Asymmetric, along with their α -cuts. Proposed work can be used to model different dynamics, of applied sciences, such as MCDM and networking problems, etc.

References

- [1] Zadeh LA. Fuzzy Sets. Inform Control. 1965;8(3):338–353.
- [2] Atanassov, K. Intuitionistic fuzzy sets. Fuzzy Sets Syst. (1986), 20, pp.87–96.
- [3] Smarandache, F. Neutrosophy/neutrosophic probability, set, and logic. American Research Press, Rehoboth. (1998).
- [4] Chakraborty, A.; Mondal, S. P.; Ahmadian, A.; Senu, N.; Alam, S.; and Salahshour, S.; Different Forms of Triangular Neutrosophic Numbers, De-Neutrosophication Techniques, and their Applications, Symmetry, vol 10, 327, 2018.; doi:10.3390/sym10080327.
- [5] Chakraborty, A.; Mondal, S. P.; Mahata, A.; Alam, S.; Different linear and non-linear form of Trapezoidal Neutrosophic Numbers, De-Neutrosophication Techniques and its Application in time cost optimization technique, sequencing problem; RAIRO Operation Research, vol 11, 327, 2018. doi:10.1051/ro/2019090.
- [6] Chakraborty. A., Sankar P. Mondal, Shariful A. Ali A., Norazak S., Debashis De. and Soheil S., The Pentagonal Fuzzy Number: Its Different Representations, Properties, Ranking, Defuzzification and Application in Game Problems, Symmetry, vol 10, pp 248, 2018.
- [7] A. Chakraborty, S. Broumi, P.K Singh, "Some properties of Pentagonal Neutrosophic Numbers and its Applications in Transportation Problem Environment," Neutrosophic Sets and Systems, vol.28, pp.200-215, 2019.
- [8] A. Chakraborty, S. Mondal, S. Broumi, "De-Neutrosophication technique of pentagonal neutrosophic number and application in minimal spanning tree," Neutrosophic Sets and Systems, vol. 29, pp. 1-18, 2019. doi: 10.5281/zenodo.3514383.
- [9] Chakraborty, A. "A New Score Function of Pentagonal Neutrosophic Number and its Application in Networking Problem," International Journal of Neutrosophic Science, Volume 1, Issue 1, pp. 40-51, 2020.
- [10] Edalatpanah, S. A., "A Direct Model for Triangular Neutrosophic Linear Programming," International Journal of Neutrosophic Science, Volume 1, Issue 1, pp. 19-28, 2020.
- [11] Saqlain, M., Jafar, M. N., Riaz, M. A New Approach of Neutrosophic Soft Set with Generalized Fuzzy TOPSIS in Application of Smart Phone Selection, Neutrosophic Sets and Systems, vol. 32, pp. 307-316, 2020. DOI: 10.5281/zenodo.3723161
- [12] Saqlain. M., Jafar. N. and Riffat. A., Smart phone selection by consumers' in Pakistan: FMCGDM fuzzy multiple criteria group decision making approach, Gomal University Journal of Research, vol 34(1), pp. 27-31, 2018.
- [13] Riaz. M., Saqlain. M. and Saeed. M. Application of Generalized Fuzzy TOPSIS in Decision Making for Neutrosophic Soft set to Predict the Champion of FIFA 2018: A Mathematical Analysis, Punjab University Journal of Mathematics, vol 51(8), pp.111-126, 2019.
- [14] Abdel-Basset, M., Saleh, M., Gamal, A., & Smarandache, F. An approach of the TOPSIS technique for developing supplier selection with group decision making under type-2 neutrosophic number. Applied Soft Computing, vol77, pp. 438-452, 2019.
- [15] Abdel-Baset, M., Chang, V., Gamal, A., & Smarandache, F. An integrated neutrosophic ANP and VIKOR method for achieving sustainable supplier selection: A case study in the importing field. Computers in Industry, vol 106, pp. 94-110, 2019.

- [16] Abdel-Basset, M., Manogaran, G., Gamal, A., & Smarandache, F. A hybrid approach of neutrosophic sets and DEMATEL method for developing supplier selection criteria. *Design Automation for Embedded Systems*, pp.1-22, 2018.
- [17] Abdel-Basset, M., Manogaran, G., Gamal, A., & Smarandache, F. A group decision-making framework based on the neutrosophic TOPSIS approach for smart medical device selection. *Journal of medical systems*, vol 43, issue 2, pp. 38-43, 2019.
- [18] Nabeeh, N. A., Smarandache, F., Abdel-Basset, M., El-Ghareeb, H. A., & Aboelfetouh, A. An Integrated Neutrosophic-TOPSIS Approach and Its Application to Personnel Selection: A New Trend in Brain Processing and Analysis. *IEEE Access*, vol 7, pp. 29734-29744. 2019.
- [19] K. Mondal, and S. Pramanik. Neutrosophic decision making model of school choice. *Neutrosophic Sets and Systems*, vol 7, pp. 62-68, 2015.
- [20] M. Saqlain, A. Hamza, and S. Farooq, "Linear and Non-Linear Octagonal Neutrosophic Numbers: Its Representation, α -Cut and Applications," *International Journal of Neutrosophic Science*, vol. 3, no. 1, pp. 29–43, 2020.
- [21] Saqlain M, Saeed M, Ahmad M. R, Smarandache F, (2019), Generalization of TOPSIS for Neutrosophic Hypersoft set using Accuracy Function and its Application, *Neutrosophic Sets and Systems (NSS)*, 27: 131-137.

NeutroAlgebra & AntiAlgebra vs. Classical Algebra

Florentin Smarandache

Florentin Smarandache (2022). NeutroAlgebra & AntiAlgebra vs. Classical Algebra. *Transactions on Fuzzy Sets and Systems* 1(1), 74-79

Abstract. NeutroAlgebra & AntiAlgebra vs. Classical Algebra is a like Realism vs. Idealism. Classical Algebra does not leave room for partially true axioms nor partially well-defined operations. Our world is full of indeterminate (unclear, conflicting, unknown, etc.) data.

This paper is a review of the emerging, development, and applications of the NeutroAlgebra and AntiAlgebra [2019-2022] as generalizations and alternatives of classical algebras.

Keywords and Phrases: Classical Algebra, NeutroAlgebra, AntiAlgebra, NeutroOperation, AntiOperation, NeutroAxiom, AntiAxiom

1 Introduction

The Classical Algebraic Structures were generalized in 2019 by Smarandache [16] to NeutroAlgebraic Structures (or NeutroAlgebras) {whose operations and axioms are partially true, partially indeterminate, and partially false} as extensions of Partial Algebra, and to AntiAlgebraic Structures (or AntiAlgebras) {whose operations and axioms are totally false} and on 2020 he continued to develop them [18, 20, 17].

The NeutroAlgebras & AntiAlgebras form a *new field of research*, which is inspired by our real world. Many researchers from various countries around the world have contributed to this new field, such as F. Smarandache, A.A.A. Agboola, A. Rezaei, M. Hamidi, M.A. Ibrahim, E.O. Adeleke, H.S. Kim, E. Mohammadzadeh, P.K. Singh, D.S. Jimenez, J.A. Valenzuela Mayorga, M.E. Roja Ubilla, N.B. Hernandez, A. Salama, M. Al-Tahan, B. Davvaz, Y.B. Jun, R.A. Borzooei, S. Broumi, M. Akram, A. Broumand Saeid, S. Mirvakili, O. Anis, S. Mirvakili, etc (See [1, 2, 3, 4, 5, 6, 7, 8, 9, 10, 11, 12, 13, 14, 15, 16, 17, 18, 19, 20, 21, 22, 23, 24]).

2 Distinctions between Classical Algebraic Structures vs. NeutroAlgebras & AntiAlgebras

In classical algebraic structures, all operations are 100% well-defined, and all axioms are 100% true, but in real life, in many cases, these restrictions are too harsh since in our world we have things that only partially verify some operations or some laws.

Using the process of *NeutroSophication* of a classical algebraic structure we produce a NeutroAlgebra, while the process of *AntiSophication* of a classical algebraic structure produces an AntiAlgebra.

3 The neutrosophic triplet (Operation, NeutroOperation, AntiOperation)

When we define an operation on a given set, it does not automatically mean that the operation is well-defined. There are three possibilities:

(i) The operation is well-defined (also called inner-defined) for all set's elements [degree of truth $T = 1$] (as in classical algebraic structures; this is a classical **Operation**). Neutrosophically we write: Operation(1, 0, 0).

(ii) The operation is well-defined for some elements [degree of truth T], indeterminate for other elements [degree of indeterminacy I], and outer-defined for the other elements [degree of falsehood F], where (T, I, F) is different from $(1, 0, 0)$ and from $(0, 0, 1)$ (this is a **NeutroOperation**). Neutrosophically we write: NeutroOperation(T, I, F).

(iii) The operation is outer-defined for all set's elements [degree of falsehood $F = 1$] (this is an **AntiOperation**). Neutrosophically we write: AntiOperation(0, 0, 1).

4 The neutrosophic triplet (Axiom, NeutroAxiom, AntiAxiom)

Similarly for an axiom, defined on a given set, endowed with some operation(s). When we define an axiom on a given set, it does not automatically mean that the axiom is true for all set elements. We have three possibilities again:

(i) The axiom is true for all set's elements (totally true) [degree of truth $T = 1$] (as in classical algebraic structures; this is a classical **Axiom**). Neutrosophically we write: Axiom(1, 0, 0).

(ii) The axiom is true for some elements [degree of truth T], indeterminate for other elements [degree of indeterminacy I], and false for other elements [degree of falsehood F], where (T, I, F) is different from $(1, 0, 0)$ and from $(0, 0, 1)$ (this is **NeutroAxiom**). Neutrosophically we write NeutroAxiom(T, I, F).

(iii) The axiom is false for all set's elements [degree of falsehood $F = 1$] (this is **AntiAxiom**). Neutrosophically we write AntiAxiom(0, 0, 1).

5 The neutrosophic triplet (Theorem, NeutroTheorem, AntiTheorem)

In any science, a classical Theorem, defined on a given space, is a statement that is 100% true (i.e. true for all elements of the space). To prove that a classical theorem is false, it is sufficient to get a single counter-example where the statement is false.

Therefore, the classical sciences do not leave room for the *partial truth* of a theorem (or a statement). But, in our world and our everyday life, we have many more examples of statements that are only partially true, than statements that are totally true. The NeutroTheorem and AntiTheorem are generalizations and alternatives of the classical Theorem in any science.

Let's consider a theorem, stated on a given set, endowed with some operation(s). When we construct the theorem on a given set, it does not automatically mean that the theorem is true for all set elements. We have three possibilities again:

(i) The theorem is true for all set's elements [totally true] (as in classical algebraic structures; this is a classical **Theorem**). Neutrosophically we write Theorem(1, 0, 0).

(ii) The theorem is true for some elements [degree of truth T], indeterminate for other elements [degree of indeterminacy I], and false for the other elements [degree of falsehood F], where (T, I, F) is different from $(1, 0, 0)$ and from $(0, 0, 1)$ (this is a **NeutroTheorem**). Neutrosophically we write NeutroTheorem(T, I, F).

(iii) The theorem is false for all set's elements (this is an **AntiTheorem**). Neutrosophically we write AntiTheorem(0, 0, 1).

And similarly, for (Lemma, NeutroLemma, AntiLemma), (Consequence, NeutroConsequence, AntiConsequence), (Algorithm, NeutroAlgorithm, AntiAlgorithm), (Property, NeutroProperty, AntiProperty), etc.

6 The neutrosophic triplet (Algebra, NeutroAlgebra, AntiAlgebra)

(i) An algebraic structure whose all operations are well-defined and all axioms are totally true is called a classical Algebraic Structure (or **Algebra**).

(ii) An algebraic structure that has at least one NeutroOperation or one NeutroAxiom (and no AntiOperation and no AntiAxiom) is called a NeutroAlgebraic Structure (or **NeutroAlgebra**).

(iii) An algebraic structure that has at least one AntiOperation or one Anti Axiom is called an AntiAlgebraic Structure (or **AntiAlgebra**).

Therefore, a neutrosophic triplet is formed: $\langle \text{Algebra}, \text{NeutroAlgebra}, \text{AntiAlgebra} \rangle$, where Algebra can be any classical algebraic structure, such as a groupoid, semigroup, monoid, group, commutative group, ring, field, vector space, BCK-Algebra, BCI-Algebra, etc.

7 Theorems and Examples

Theorem 7.1. *If a Classical Statement (theorem, lemma, congruence, property, proposition, equality, inequality, formula, algorithm, etc.) is totally true in a classical Algebra, then the same Statement in a NeutroAlgebra maybe be:*

- *totally true (degree of truth $T = 1$, degree of indeterminacy $I = 0$, and degree of falsehood $F = 0$);*
- *partially true (degree of truth T), if partial indeterminate (degree of indeterminacy I), and partial falsehood (degree of falsehood F), where $(T, I, F) \notin \{(1, 0, 0), (0, 0, 1)\}$.*
- *totally false (degree of falsehood $F = 1$, degree of truth $T = 0$, and degree of indeterminacy $I = 0$).*

Example 7.2. (Examples of Classical Algebra, NeutroAlgebra, and AntiAlgebra)

Let $S = \{a, b, c\}$ be a set, and a binary law (operation) $*$ defined on S :

$$* : S^2 \rightarrow S.$$

As in the below Cayley Table:

$*$	a	b	c
a	a	c	a
b	a	b	a
c	b	c	a

Then:

1. $(S, *)$ is a Classical Grupoid since the law $*$ is totally (100%) well-defined (classical law), or $\forall x, y \in S, x * y \in S$.

2. $(S, *)$ is a NeutroSemigroup, since:

- (i) the law $*$ is totally well-defined (classical law);
- (ii) the associativity law is a NeutroAssociativity, i.e.

- partially true, because $\exists a, b, c \in S$ such that

$$(a * b) * c = c * c = a = a * (b * c) = a * a = a,$$

the degree of truth $T > 0$,

- degree of indeterminacy $I = 0$ since no indeterminacy exists;
- and partially false, because $\exists c, c, c \in S$ such that

$$(c * c) * c = a * c = a \neq c * (c * c) = a * a = b,$$

so degree of falsehood $F > 0$.

3. $(S, *)$ is an AntiCommutative NeutroSemigroup, since:

- (i) the law $*$ is totally well-defined (classical law);
- (ii) the associativity is a NeutroAssociativity (as proven above);
- (iii) the commutativity is an AntiCommutativity, since:

$$\forall x, y \in S, \quad x * y \neq y * x.$$

Proof.

$$a * b = c \neq a = b * a,$$

$$a * c = a \neq b = c * a,$$

$$b * c = a \neq c = c * b.$$

□

Theorem 7.3. *If a Classical Statement is false in a classical Algebra, then in a NeutroAlgebra it may be:*

- (i) *either a NeutroStatement, i.e. true (T) for some elements, indeterminate (I) for other elements, and false (F) for the others, where (T, I, F) is different from $(1, 0, 0)$ and from $(0, 0, 1)$;*
- (ii) *or an AntiStatement, i.e. false for the elements.*

Theorem 7.4. *A Classical Group can be:*

- (i) *either Commutative (the commutative law is true for all elements);*
- (ii) *or NeutroCommutative (the commutative law is true (T) for some elements, indeterminate (I) for others, and false (F) for the other elements where (T, I, F) is different from $(1, 0, 0)$ and from $(0, 0, 1)$;*
- (iii) *or AntiCommutative (the commutative law is false for all the elements).*

Corollary 7.5. *The Classical Non-Commutative Group is either NeutroCommutative or AntiCommutative.*

Corollary 7.6. *The Classical Non-Associative Groupoid is either NeutroAssociative or AntiAssociative.*

8 Conclusion

The Classical Structures in science mostly exist in theoretical, abstract, perfect, homogeneous, idealistic spaces - because in our everyday life almost all structures are NeutroStructures, since they are neither perfect nor applying to the whole population, and not all elements of the space have the same relations and same attributes in the same degree (not all elements behave in the same way).

The indeterminacy and partiality, with respect to the space, to their elements, to their relations or their attributes are not taken into consideration in the Classical Structures. But our Real World is full of structures with indeterminate (vague, unclear, conflicting, unknown, etc.) data and partialities.

There are exceptions to almost all laws, and the laws are perceived in different degrees by different people in our every-day life.

References

- [1] A. A. A. Agboola, Introduction to NeutroGroups, *Int. J. Neutrosophic Sci.*, 6 (2020), 41-47. Available online: <http://fs.unm.edu/IntroductionToNeutroGroups.pdf>.
- [2] A. A. A. Agboola, Introduction to NeutroRings, *Int. J. Neutrosophic Sci.*, 7 (2020), 62-73. Available online: <http://fs.unm.edu/IntroductionToNeutroRings.pdf>.
- [3] A. A. A. Agboola, On Finite NeutroGroups of Type-NG, *Int. J. Neutrosophic Sci.*, 10 (2020), 84-95. Available online: <http://fs.unm.edu/IJNS/OnFiniteNeutroGroupsOfType-NG.pdf>.
- [4] A. A. A. Agboola, On Finite and Infinite NeutroRings of Type-NR, *Int. J. Neutrosophic Sci.*, 11 (2020), 87-99. Available online: <http://fs.unm.edu/IJNS/OnFiniteAndInfiniteNeutroRings.pdf>.
- [5] A. A. A. Agboola, Introduction to AntiGroups, *Int. J. Neutrosophic Sci.*, 12(2) (2020), 71-80, <http://fs.unm.edu/IJNS/IntroductionAntiGroups.pdf>.
- [6] A. A. A. Agboola, M.A. Ibrahim and E.O. Adeleke, Elementary Examination of NeutroAlgebras and AntiAlgebras viz-a-viz the Classical Number Systems, *Int. J. Neutrosophic Sci.*, 4 (2020), 16-19. Available online: <http://fs.unm.edu/ElementaryExaminationOfNeutroAlgebra.pdf>.
- [7] M. Al-Tahan, NeutroOrderedAlgebra: Theory and Examples, *3rd International Workshop on Advanced Topics in Dynamical Systems, University of Kufa, Kufa, Iraq*, (2021).
- [8] M. Al-Tahan, B. Davvaz, F. Smarandache and O. Anis, On Some NeutroHyperstructures, *Symmetry*, 13 (2021), 1-12. Available online: <http://fs.unm.edu/NeutroHyperstructure.pdf>.
- [9] M. Al-Tahan, F. Smarandache and B. Davvaz, NeutroOrderedAlgebra: Applications to Semigroups, *Neutrosophic Sets and Syst.* 39 (2021), 133-147, DOI: 10.5281/zenodo.4444331.
- [10] M. Hamidi and F. Smarandache, Neutro-BCK-Algebra, *Int. J. Neutrosophic Sci.*, 8 (2020), 110-117. Available online: <http://fs.unm.edu/Neutro-BCK-Algebra.pdf>.
- [11] M. A. Ibrahim and A. A. A. Agboola, Introduction to NeutroHyperGroups, *Neutrosophic Sets Syst.*, 38 (2020), 15-32. Available online: <http://fs.unm.edu/NSS/IntroductionToNeutroHyperGroups2.pdf>.
- [12] D. S. Jiménez, J. A. V. Mayorga, M. E. R. Ubilla and N. B. Hernández, NeutroAlgebra for the evaluation of barriers to migrants access in Primary Health Care in Chile based on PROSPECTOR function, *Neutrosophic Sets Syst.*, 39 (2021), 1-9. DOI: 10.5281/zenodo.4444189.
- [13] E. Mohammadzadeh and A. Rezaei, On NeutroNilpotentGroups, *Neutrosophic Sets Syst.*, 38 (2020), 33-40. Available online: <http://fs.unm.edu/NSS/OnNeutroNilpotentGroups3.pdf>.
- [14] A. Rezaei and F. Smarandache, On Neutro-BE-algebras and Anti-BE-algebras, *Int. J. Neutrosophic Sci.*, 4 (2020), 8-15. Available online: <http://fs.unm.edu/OnNeutroBEalgebras.pdf>.
- [15] A. Rezaei, F. Smarandache and S. Mirvakili, Applications of (Neutro/Anti)sophications to Semihypergroups, *Journal of Mathematics*, Hindawi, (2021), 1-7. <https://doi.org/10.1155/2021/6649349>.
- [16] F. Smarandache, Introduction to NeutroAlgebraic Structures and AntiAlgebraic Structures, *Pons Publishing House Brussels, Belgium*, (2019), 240-265. Available online: <http://fs.unm.edu/AdvancesOfStandardAndNonstandard.pdf>.

- [17] F. Smarandache, Generalizations and Alternatives of Classical Algebraic Structures to NeutroAlgebraic Structures and AntiAlgebraic Structures, *J. Fuzzy. Ext. Appl.*, 1(2) (2020), 8587. Available online: <http://fs.unm.edu/NeutroAlgebra-general.pdf>.
- [18] F. Smarandache, NeutroAlgebra is a Generalization of Partial Algebra, *Int. J. Neutrosophic Sci.*, 2 (2020), 8-17. Available online: <http://fs.unm.edu/NeutroAlgebra.pdf>.
- [19] F. Smarandache, Structure, NeutroStructure, and AntiStructure in Science, *Int. J. Neutrosophic Sci.*, 13 (2020), 28-33. Available online: <http://fs.unm.edu/IJNS/NeutroStructure.pdf>.
- [20] F. Smarandache, Introduction to NeutroAlgebraic Structures and AntiAlgebraic Structures (revisited), *Neutrosophic Sets Syst.*, 31 (2020), 1-16. Available online: <http://fs.unm.edu/NSS/NeutroAlgebraic-AntiAlgebraic-Structures.pdf>.
- [21] F. Smarandache, Extension of HyperGraph to n-SuperHyperGraph and to Plithogenic n-SuperHyperGraph, and Extension of HyperAlgebra to n-ary (Classical-/Neutro-/Anti-)HyperAlgebra, *Neutrosophic Sets Syst.*, 33 (2020), 290-296. Available online: <http://fs.unm.edu/NSS/n-SuperHyperGraph-n-HyperAlgebra.pdf>.
- [22] F. Smarandache, Universal NeutroAlgebra and Universal AntiAlgebra, *Educational Publ., Grandview Heights, OH, United States* (2021).
- [23] F. Smarandache, A. Rezaei, A. A. A. Agboola, Y. B. Jun, R. A. Borzooei, B. Davvaz, A. Broumand Saeid, M. Akram, M. Hamidi and S. Mirvakilii, On NeutroQuadrupleGroups, *51st Annual Mathematics Conference, February, Kashan, Iran*, (2021), 16-19.
- [24] F. Smarandache, A. Rezaei and H. S. Kim, A New Trend to Extensions of CI-algebras, *Int. J. Neutrosophic Sci.* 5 (2020), 8-15. Available online: <http://fs.unm.edu/Neutro-CI-Algebras.pdf>.

FUZZY SOFT SETS

On Fuzzy Soft Matrix Based on Reference Function

Said Broumi, Florentin Smarandache, Mamoni Dhar

Said Broumi, Florentin Smarandache, Mamoni Dhar (2013). On Fuzzy Soft Matrix Based on Reference Function. *International Journal of Information Engineering and Electronic Business* 2, 52-59; DOI: 10.5815/ijieeb.2013.02.08

Abstract—In this paper we study fuzzy soft matrix based on reference function. Firstly, we define some new operations such as fuzzy soft complement matrix and trace of fuzzy soft matrix based on reference function. Then, we introduced some related properties, and some examples are given. Lastly, we define a new fuzzy soft matrix decision method based on reference function.

Index Terms Soft set, fuzzy soft set, fuzzy soft set based on reference function, fuzzy soft matrix based on reference function.

I. INTRODUCTION

Fuzzy set theory was proposed by Lotfi A. Zadeh^[1] in 1965, where each element (real valued) $[0, 1]$ had a degree of membership defined on the universe of discourse X , the theory has been found extensive application in various field to handle uncertainty. Therefore, several researches were conducted on the generalization on the notions of fuzzy sets such as intuitionistic fuzzy set proposed by Atanassov^[2,3], interval valued fuzzy set^[5]. In the literature we found many well-known theories to describe uncertainty: rough set theory^[6], etc, but all of these theories have their inherent difficulties as pointed by Molodtsov in his pioneer work^[7]. The concept introduced by Molodtsov is called “soft set theory” which is set valued mapping. This new mathematical model is free from the difficulties mentioned above. Since its introduction, the concept of soft set has gained considerable attention and this concept has resulted in a series of work^[8,9,10,11,12,13,14].

Also as we know, matrices play an important role in science and technology. However, the classical matrix theory sometimes fails to solve the problems involving uncertainties, occurring in an imprecise environment. In^[4] Thomason, introduced the fuzzy matrices to represent fuzzy relation in a system based on fuzzy set theory and

discussed about the convergence of powers of fuzzy matrix. In^[15,16,17], some important results on determinant of a square fuzzy matrices are discussed. Also, Ragab et al.^[18,19] presented some properties of the min-max composition of fuzzy matrices. Later on, several studies and some applications of fuzzy matrices are defined in^[20,21].

In 2010, Cagman et al^[13] defined soft matrix which is representation of soft set, to make operations in theoretical studies in soft set more functional. This representation has several advantages, it is easy to store and manipulate matrices and hence the soft sets represented by them in a computer.

Recently several research have been studied the connection between soft set and soft matrices^[13,14,22]. Later, Maji et al^[9] introduced the theory of fuzzy soft set and applied it to decision making problem. In 2011, Yang and C. Ji^[22], defined fuzzy soft matrix (FSM) which is very useful in representing and computing the data involving fuzzy soft sets.

The concept of fuzzy set based on reference function was first introduced by Baruah^[23,24,25] in the following manner - According to him, to define a fuzzy set, two functions namely fuzzy membership function and fuzzy reference function are necessary. Fuzzy membership value is the difference between fuzzy membership function and reference function. Fuzzy membership function and fuzzy membership value are two different things. In^[26,27] M. Dhar applied this concept to fuzzy square matrix and developed some interesting properties as determinant, trace and so on. Thereafter, in^[28], T.J. Neog, D. K. Sutwere extended this new concept to soft set theory, introducing a new concept called “fuzzy soft set based on fuzzy reference function”. Recently, Neog, T.J., Sut D.K., M. Bora^[29] combined fuzzy soft set based on reference function with soft matrices. The paper unfolds as follows. The next section briefly introduces some definitions related to soft set, fuzzy soft set, and fuzzy soft set based on reference function. Section 3 presents fuzzy soft complement

matrix based on reference function. Section 4 presents trace of fuzzy soft matrix based on reference function. Section 5 presents new fuzzy soft matrix theory in decision making. Conclusions appear in the last section.

II. PRELIMINARIES

In this section first we review some concepts and definitions of soft set, fuzzy soft set, and fuzzy soft set based on reference function from [9,12,13,29], which will be needed in the sequel.

Remark:

For the sake of simplicity we adopt the following notation of fuzzy soft set based on reference function defined in our way as: Fuzzy soft set based on reference $(F, A)_{rf}$

To make the difference between the notation (F, A) defined for classical soft set or its variants as fuzzy soft set.

2.1. Definition (Soft Set [13])

Suppose that U is an initial universe set and E is a set of parameters, let $P(U)$ denotes the power set of U . A pair (F, E) is called a soft set over U where F is a mapping given by $F: E \rightarrow P(U)$. Clearly, a soft set is a mapping from parameters to $P(U)$, and it is not a set, but a parameterized family of subsets of the universe.

2.2. Example.

Suppose that $U = \{s1, s2, s3, s4\}$ is a set of students and $E = \{e1, e2, e3\}$ is a set of parameters, which stand for result, conduct and sports performances respectively. Consider the mapping from parameters set E to the set of all subsets of power set U . Then soft set (F, E) describes the character of the students with respect to the given parameters, for finding the best student of an academic year.

$$(F, E) = \{ \text{result } \{s1, s3, s4\} \text{ conduct } \{s1, s2\} \text{ sports performances } \{s2, s3, s4\} \}$$

2.3. Definition (Fuzzy Soft Set [9, 12])

Let U be an initial universe set and E be the set of parameters. Let $A \subseteq E$. A pair (F, A) is called fuzzy soft set over U where F is a mapping given by $F: A \rightarrow F^U$, where F^U denotes the collection of all fuzzy subsets of U .

2.4. Example.

Consider the example 2.2, in soft set (F, E) , if $s1$ is medium in studies, we cannot express it with only the two numbers 0 and 1, we can characterize it by a membership function instead of the crisp number 0 and 1, which associates with each element a real number in the interval $[0, 1]$. Then fuzzy soft set can describe as

$$(F, A) = \{ F(e1) = \{(s1, 0.9), (s2, 0.3), (s3, 0.8), (s4, 0.9)\}, F(e2) = \{(s1, 0.8), (s2, 0.9), (s3, 0.4), (s4, 0.3)\} \}, \text{ where } A = \{e1, e2\}.$$

In the following, Neog et al. [29] showed by an example

that this definition sometimes gives degenerate cases and revised the above definition as follows:

2.5. Definition [29]

Let $A = (\mu_1, \mu_2) = \{x, \mu_1(x), \mu_2(x); x \in U\}$ and $B = (\mu_3, \mu_4) = \{x, \mu_3(x), \mu_4(x); x \in U\}$ be two fuzzy sets defined over the same universe U .

Then the operations intersection and union are defined as $A \cap B = (\mu_1, \mu_2) \cap (\mu_3, \mu_4) = \{x, \min(\mu_1(x), \mu_3(x)), \max(\mu_2(x), \mu_4(x)); x \in U\}$ and $A \cup B = (\mu_1, \mu_2) \cup (\mu_3, \mu_4) = \{x, \max(\mu_1(x), \mu_3(x)), \min(\mu_2(x), \mu_4(x)); x \in U\}$

2.6. Definition [29]

Let $A = (\mu_1, \mu_2) = \{x, \mu_1(x), \mu_2(x); x \in U\}$ and $B = (\mu_3, \mu_4) = \{x, \mu_3(x), \mu_4(x); x \in U\}$ be two fuzzy sets defined over the same universe U . To avoid degenerate cases we assume that $\min(\mu_1(x), \mu_3(x)) \geq \max(\mu_2(x), \mu_4(x))$ for all $x \in U$.

Then the operations intersection and union are defined as $A \cap B = (\mu_1, \mu_2) \cap (\mu_3, \mu_4) = \{x, \min(\mu_1(x), \mu_3(x)), \max(\mu_2(x), \mu_4(x)); x \in U\}$ and $A \cup B = (\mu_1, \mu_2) \cup (\mu_3, \mu_4) = \{x, \max(\mu_1(x), \mu_3(x)), \min(\mu_2(x), \mu_4(x)); x \in U\}$

2.7. Definition [29]

For usual fuzzy sets $A = (\mu, 0) = \{x, \mu(x), 0; x \in U\}$ and $B = (1, \mu) = \{x, 1, \mu(x); x \in U\}$ defined over the same universe U , we have $A \cap B = (\mu, 0) \cap (1, \mu) = \{x, \min(\mu(x), 1), \max(0, \mu(x)); x \in U\} = \{x, \mu(x), \mu(x); x \in U\}$, which is nothing but the null set \emptyset and $A \cup B = (1, \mu) \cup (\mu, 0) = \{x, \max(\mu(x), 1), \min(0, \mu(x)); x \in U\} = \{x, 1, 0; x \in U\}$, which is nothing but the universal set U .

This means if we define a fuzzy set $(A(\mu, 0))^c = \{x, 1, \mu(x); x \in U\}$ it is nothing but the complement of $A(\mu, 0) = \{x, \mu(x), 0; x \in U\}$.

2.8. Definition [29]

Let $A = (\mu_1, \mu_2) = \{x, \mu_1(x), \mu_2(x); x \in U\}$ and $B = (\mu_3, \mu_4) = \{x, \mu_3(x), \mu_4(x); x \in U\}$ be two fuzzy sets defined over the same universe U . The fuzzy set $A(\mu_1, \mu_2)$ is a subset of the fuzzy set $B(\mu_3, \mu_4)$ if for all $x \in U$, $\mu_1(x) \leq \mu_3(x)$ and $\mu_2(x) \leq \mu_4(x)$.

Two fuzzy sets $C = \{x, \mu_C(x); x \in U\}$ and $D = \{x, \mu_D(x); x \in U\}$ in the usual definition would be expressed as $C(\mu_C, 0) = \{x, \mu_C(x), 0; x \in U\}$ and $D(\mu_D, 0) = \{x, \mu_D(x), 0; x \in U\}$

Accordingly, we have $C(\mu_C, 0) \subseteq D(\mu_D, 0)$ if for all $x \in U$, $\mu_C(x) \leq \mu_D(x)$, which can be obtained by putting $\mu_2(x) = \mu_4(x) = 0$ in the new definition.

2.9. Definition [29] (Fuzzy soft matrices (FSMs) based on reference function)

Let U be an initial universe, E be the set of parameters and $A \subseteq E$. Let (f_A, E) be fuzzy soft set (FS) over U . Then a subset of $U \times E$ is uniquely defined by $R_A = \{(u, e); e \in A, u \in f_A(e)\}$ which is called a relation form of (f_A, E) .

2.10. Example

Assume that $U = \{u_1, u_2, u_3, u_4\}$ is a universal set and $E = \{e_1, e_2, e_3, e_4, e_5\}$ be the set of parameters and $A = \{e_1, e_2, e_3\} \subseteq E$ and

$$\begin{aligned} f_A(e_1) &= \{u_1/(0.7, 0), u_2/(0.1, 0), u_3/(0.2, 0), u_4/(0.6, 0)\} \\ f_A(e_2) &= \{u_1/(0.8, 0), u_2/(0.6, 0), u_3/(0.1, 0), u_4/(0.5, 0)\} \\ f_A(e_3) &= \{u_1/(0.1, 0), u_2/(0.2, 0), u_3/(0.7, 0), u_4/(0.3, 0)\} \end{aligned}$$

Then the fuzzy soft set (f_A, E) is a parameterized family $\{f_A(e_1), f_A(e_2), f_A(e_3)\}$ of all fuzzy soft sets over U . Then the relation form of (f_A, E) is written as

TABLE 1. The relation form of (f_A, E)

R_A	e_1	e_2	e_3	e_4
u_1	(0.7, 0)	(0.8, 0)	(0.1, 0)	(0, 0)
u_2	(0.1, 0)	(0.6, 0)	(0.2, 0)	(0, 0)
u_3	(0.2, 0)	(0.1, 0)	(0.7, 0)	(0, 0)
u_4	(0.6, 0)	(0.5, 0)	(0.3, 0)	(0, 0)

Hence, the fuzzy soft matrix representing this fuzzy soft set would be represented as

$$A = \begin{bmatrix} (0.7, 0)(0.8, 0)(0.1, 0)(0, 0) \\ (0.1, 0)(0.6, 0)(0.2, 0)(0, 0) \\ (0.2, 0)(0.1, 0)(0.7, 0)(0, 0) \\ (0.6, 0)(0.5, 0)(0.3, 0)(0, 0) \end{bmatrix}$$

2.11. Definition [29]

We define the membership value matrix corresponding to the matrix A as $MV(A) = [\delta_{ij}(c_i)]$ Where $\delta_{(A)ij} = \mu_{j1}(c_i) - \mu_{j2}(c_i)$ $i = 1, 2, 3, \dots, m$ and $j = 1, 2, 3, \dots, n$, where $\mu_{j1}(c_i)$ and $\mu_{j2}(c_i)$ represent the fuzzy membership function and fuzzy reference function respectively of c_i in the fuzzy set $F(e_j)$.

2.12. Definition [29]

Let the fuzzy soft matrices corresponding to the fuzzy soft sets (F, E) , and (G, E) be $A = [a_{ij}] \in FSM_{m \times n}$, $B = [b_{ij}]$ where $a_{ij} = (\mu_{j1}(c_i), \mu_{j2}(c_i))$ and $b_{ij} = (\chi_{j1}(c_i), \chi_{j2}(c_i))$, $i = 1, 2, 3, \dots, m$; $j = 1, 2, 3, \dots, n$; Then A and B are called fuzzy soft equal matrices denoted by $A \sim B$, if $\mu_{j1}(c_i) = \chi_{j1}(c_i)$ and $\mu_{j2}(c_i) = \chi_{j2}(c_i)$ for all i, j .

In [13], the addition (+) operation between two fuzzy soft matrices is defined as follows

2.13. Definition [29]

Let $U = \{c_1, c_2, c_3, \dots, c_m\}$ be the universal set and E be the set of parameters given by $E = \{e_1, e_2, e_3, \dots, e_n\}$. Let the set of all $m \times n$ fuzzy soft matrices over U be $FSM_{m \times n}$.

Let $A, B \in FSM_{m \times n}$, where $A = [a_{ij}]_{m \times n}$, $a_{ij} = (\mu_{j1}(c_i), \mu_{j2}(c_i))$ and $B = [b_{ij}]_{m \times n}$, $b_{ij} = (\chi_{j1}(c_i), \chi_{j2}(c_i))$. To avoid degenerate cases we assume

that $\min(\mu_{j1}(c_i), \chi_{j1}(c_i)) \geq \max(\mu_{j2}(c_i), \chi_{j2}(c_i))$ for all i and j . The operation of addition (+) between A and B is defined as $A + B = C$, where $C = [c_{ij}]_{m \times n}$, $c_{ij} = (\max(\mu_{j1}(c_i), \chi_{j1}(c_i)), \min(\mu_{j2}(c_i), \chi_{j2}(c_i)))$

2.14. Example

Let $U = \{c_1, c_2, c_3, c_4\}$ be the universal set and E be the set of parameters given by $E = \{e_1, e_2, e_3\}$. We consider the fuzzy soft sets based on reference function.

$$(F, E) = \{F(e_1) = \{(c_1, 0.3, 0), (c_2, 0.5, 0), (c_3, 0.6, 0), (c_4, 0.5, 0)\}, F(e_2) = \{(c_1, 0.7, 0), (c_2, 0.9, 0), (c_3, 0.7, 0), (c_4, 0.8, 0)\}, F(e_3) = \{(c_1, 0.6, 0), (c_2, 0.7, 0), (c_3, 0.7, 0), (c_4, 0.3, 0)\}\}$$

$$(G, E) = \{G(e_1) = \{(c_1, 0.8, 0), (c_2, 0.7, 0), (c_3, 0.5, 0), (c_4, 0.4, 0)\}, G(e_2) = \{(c_1, 0.9, 0), (c_2, 0.9, 0), (c_3, 0.8, 0), (c_4, 0.7, 0)\}, G(e_3) = \{(c_1, 0.5, 0), (c_2, 0.9, 0), (c_3, 0.6, 0), (c_4, 0.8, 0)\}\}$$

The fuzzy soft matrices based on reference function representing these two fuzzy soft sets are respectively

$$A = \begin{bmatrix} (0.3, 0)(0.7, 0)(0.6, 0) \\ (0.5, 0)(0.9, 0)(0.7, 0) \\ (0.6, 0)(0.7, 0)(0.7, 0) \\ (0.5, 0)(0.8, 0)(0.3, 0) \end{bmatrix} \quad B = \begin{bmatrix} (0.8, 0)(0.9, 0)(0.5, 0) \\ (0.7, 0)(0.9, 0)(0.9, 0) \\ (0.5, 0)(0.8, 0)(0.6, 0) \\ (0.4, 0)(0.7, 0)(0.8, 0) \end{bmatrix}$$

$$\text{Here } A + B = \begin{bmatrix} (0.8, 0)(0.9, 0)(0.6, 0) \\ (0.7, 0)(0.9, 0)(0.9, 0) \\ (0.6, 0)(0.8, 0)(0.7, 0) \\ (0.5, 0)(0.8, 0)(0.8, 0) \end{bmatrix}$$

III. FUZZY SOFT COMPLEMENT MATRIX BASED ON REFERENCE FUNCTION

In this section, we start by introducing the notion of the fuzzy soft complement matrix based on reference function, and we prove some formal properties.

3.1. Definition

Let $A = [(a_{ij}, 0)]_{m \times n} \in FSM_{m \times n}$ according to the definition in [26], then A^c is called fuzzy soft complement matrix if $A^c = [(1, a_{ij})]_{m \times n}$ for all $a_{ij} \in [0, 1]$.

3.2. Example

Let $A = \left[\begin{matrix} (0.7, 0)(0.8, 0) \\ (0.1, 0)(0.6, 0) \end{matrix} \right]$ be fuzzy soft matrix based on reference function, then the complement of this matrix is $A^c = \left[\begin{matrix} (1, 0.7)(1, 0.8) \\ (1, 0.1)(1, 0.6) \end{matrix} \right]$.

3.3. Proposition

Let A, B be two fuzzy soft matrix based on fuzzy reference function. Then

$$(i) (A^c)^T = (A^T)^c \tag{1}$$

$$(ii)(A^c + B^c)^T = (A^T)^c + (B^T)^c \tag{2}$$

Proof:

To show (i)
 $(A^c)^T = (A^T)^c$

We have, let $A \in FSM_{m \times n}$, then

$$A = [(\mu_{j1}(c_i), \mu_{j2}(c_i))] \\ A^c = [1, \mu_{j1}(c_i)] \\ (A^c)^T = [1, \mu_{i1}(c_j)] \\ \text{For } A^T = [(\mu_{i1}(c_j), \mu_{i2}(c_j))],$$

we have

$$(A^T)^c = [1, \mu_{i1}(c_j)] \\ \text{Hence } (A^c)^T = (A^T)^c$$

The proof of (ii) follows similar lines as above.

3.4. Example

$$\text{Let } A = \begin{bmatrix} (0.2, 0)(0.3, 0) \\ (0.1, 0)(0.4, 0) \end{bmatrix}, B = \begin{bmatrix} (0.5, 0)(0.4, 0) \\ (0.6, 0)(0.2, 0) \end{bmatrix}$$

$$A^c = \begin{bmatrix} (1, 0.2)(1, 0.3) \\ (1, 0.1)(1, 0.4) \end{bmatrix}, B^c = \begin{bmatrix} (1, 0.5)(1, 0.4) \\ (1, 0.6)(1, 0.2) \end{bmatrix}$$

$$(A^c)^T = \begin{bmatrix} (1, 0.2)(1, 0.1) \\ (1, 0.3)(1, 0.4) \end{bmatrix}, (B^c)^T = \begin{bmatrix} (1, 0.5)(1, 0.6) \\ (1, 0.4)(1, 0.2) \end{bmatrix} \\ (A^T)^c + (B^T)^c = \begin{bmatrix} (1, 0.2)(1, 0.1) \\ (1, 0.3)(1, 0.2) \end{bmatrix}$$

$$A^c + B^c = \begin{bmatrix} (1, 0.2)(1, 0.3) \\ (1, 0.1)(1, 0.2) \end{bmatrix}, (A^c + B^c)^T = \begin{bmatrix} (1, 0.2)(1, 0.1) \\ (1, 0.3)(1, 0.2) \end{bmatrix}$$

Then

$$(A^c + B^c)^T = (A^T)^c + (B^T)^c.$$

IV. TRACE OF FUZZY SOFT MATRIXBASED ON REFERENCE FUNCTION

In this section we extend the concept of trace of fuzzy square matrix proposed M. Dhar^[26] to fuzzy soft square matrix based on reference function, and we prove some formal properties.

4.1. Definition

Let A be a square matrix. Then the trace of the matrix A is denoted by trA and is defined as:

$$\text{trA} = (\max(\mu_{ii}), \min(r_{ii})) \tag{3}$$

where μ_{ii} stands for the membership functions lying along the principal diagonal and r_{ii} refers to the reference function of the corresponding membership functions.

4.2. Proposition

Let A and B be two fuzzy soft square matrices each of order n.

Then

$$\text{tr}(A+B) = \text{trA} + \text{trB} \tag{4}$$

proof.

We have from the proposed definition of trace of

fuzzy soft matrices

$$\text{trA} = (\max a_{ii}, \min r_{ii})$$

and

$$\text{trB} = (\max b_{ii}, \min r'_{ii})$$

then

$$A+B = C \text{ where } C = [c_{ij}]$$

Following the definition of addition of two fuzzy soft matrices, we have

$$C_{ij} = (\max(a_{ii}, b_{ii}), \min(r_{ii}, r'_{ii}))$$

According to definition 4.1 the trace of fuzzy soft matrix based on reference function would be:

$$\text{tr}(C) = [\max \{ \max(a_{ii}, b_{ii}) \}, \min \{ \min(r_{ii}, r'_{ii}) \}] \\ [\max \{ \max(a_{ii}), \max(b_{ii}) \}, \min \{ \min(r_{ii}), \min(r'_{ii}) \}] \\ \text{trA} + \text{trB},$$

Conversely,

$$\text{trA} + \text{trB} = [\max \{ \max(a_{ii}), \max(b_{ii}) \}, \min \{ \min(r_{ii}), \min(r'_{ii}) \}]$$

$$[\max \{ \max(a_{ii}, b_{ii}), \min(\min(r_{ii}, r'_{ii})) \}]$$

$$\text{tr}(A+B)$$

hence the result $\text{trA} + \text{trB} = \text{tr}(A+B)$

4.3. Example:

Let us consider the following two fuzzy soft matrices A and B based on reference function for illustration purposes

$$A = \begin{bmatrix} (0.3, 0)(0.7, 0)(0.8, 0) \\ (0.4, 0)(0.5, 0)(0.3, 0) \\ (0.6, 0)(0.1, 0)(0.4, 0) \end{bmatrix} \text{ and } B = \begin{bmatrix} (1, 0)(0.2, 0)(0.3, 0) \\ (0.8, 0)(0.5, 0)(0.2, 0) \\ (0.5, 0)(1, 0)(0.8, 0) \end{bmatrix}$$

The addition of two soft matrices would be:

$$A+B = \begin{bmatrix} (1, 0)(0.7, 0)(0.8, 0) \\ (0.8, 0)(0.5, 0)(0.3, 0) \\ (0.6, 0)(1, 0)(0.8, 0) \end{bmatrix}$$

Using the definition of trace of fuzzy soft matrices, we see the following results:

$$\text{trA} = \{ \max(0.3, 0.5, 0.4), \min(0, 0, 0) \} = (0.5, 0)$$

$$\text{trB} = \{ \max(1, 0.5, 0.8), \min(0, 0, 0) \} = (1, 0)$$

Thus we have

$$\text{trA} + \text{trB} = \{ \max(1, 0.5, 0.8), \min(0, 0, 0) \} = (1, 0)$$

And

$$\text{tr}(A+B) = \{ \max(1, 0.5, 0.8), \min(0, 0, 0) \} = (1, 0)$$

Hence the result

$$\text{trA} + \text{trB} = \text{tr}(A+B)$$

4.4. Proposition

Let $A = [a_{ij}, r_{ij}] \in FSM_{m \times n}$ be fuzzy soft square matrix of order n, if λ is a scalar such that $0 \leq \lambda \leq 1$. Then

$$\text{tr}(\lambda A) = \lambda \text{tr}(A) \tag{5}$$

proof.

to prove

$$\text{tr}(\lambda A) = \lambda \text{tr} A \quad 0 \leq \lambda \leq 1$$

we have

$$\begin{aligned} \text{tr}(\lambda A) &= \{ \max(\lambda a_{ii}), \min(\lambda r_{ii}) \} \\ &= \lambda \{ \max(a_{ii}), \min(r_{ii}) \} \\ &= \lambda \text{tr}(A) \end{aligned}$$

4.5. Example

$$\text{Let } A = \begin{bmatrix} (0.3, 0)(0.7, 0)(0.8, 0) \\ (0.4, 0)(0.5, 0)(0.3, 0) \\ (0.6, 0)(0.1, 0)(0.4, 0) \end{bmatrix} \text{ and } \lambda = 0.5$$

Then

$$\lambda A = \begin{bmatrix} (0.15, 0)(0.35, 0)(0.40, 0) \\ (0.20, 0)(0.25, 0)(0.15, 0) \\ (0.30, 0)(0.05, 0)(0.20, 0) \end{bmatrix}$$

$$\text{tr}(\lambda A) = \{ \max(0.15, 0.25, 0.20), \min((0, 0, 0)) \} = (0.25, 0)$$

Again

$$\text{tr} A = (0.5, 0)$$

and hence

$$\text{tr}(\lambda A) = 0.5 (0.5, 0) = (0.25, 0)$$

4.6. Proposition:

Let $A = [a_{ij}, r_{ij}] \in \text{FSM}_{m \times n}$ be fuzzy soft square matrices each of order n .

Then

$$\text{tr} A = \text{tr}(A^t), \text{ where } A^t \text{ is the transpose of } A$$

4.7. Example

$$\text{Let } A^t = \begin{bmatrix} (0.3, 0)(0.4, 0)(0.6, 0) \\ (0.7, 0)(0.5, 0)(0.1, 0) \\ (0.8, 0)(0.3, 0)(0.4, 0) \end{bmatrix}$$

Then

$$\text{tr}(A^t) = \{ \max(0.3, 0.5, 0.4), \min(0, 0, 0) \} = (0.5, 0)$$

$$\text{Hence } \text{tr} A = \text{tr}(A^t)$$

The same result will hold if we consider the complements of fuzzy soft square matrices.

$$A^c = \begin{bmatrix} (1, 0.3)(1, 0.7)(1, 0.8) \\ (1, 0.4)(1, 0.5)(1, 0.3) \\ (1, 0.6)(1, 0.1)(1, 0.4) \end{bmatrix}$$

$$\text{tr} A^c = \{ \max(1, 1, 1), \min(0.3, 0.5, 0.4) \} = (1, 0.3)$$

If we consider another fuzzy soft matrix B:

$$B = \begin{bmatrix} (1, 0)(0.2, 0)(0.3, 0) \\ (0.8, 0)(0.5, 0)(0.2, 0) \\ (0.5, 0)(1, 0)(0.8, 0) \end{bmatrix}$$

$$B^c = \begin{bmatrix} (1, 1)(1, 0.2)(1, 0.3) \\ (1, 0.8)(1, 0.5)(1, 0.2) \\ (1, 0.5)(1, 1)(1, 0.8) \end{bmatrix}$$

Then the trace of B^c will be the following:

$$\text{tr}(B^c) = \{ \max(1, 1, 1), \min(1, 0.5, 0.8) \} = (1, 0.5)$$

Following the definition 2.13 of addition of two fuzzy

soft matrices based on reference function, we have.

$$A^c + B^c = \begin{bmatrix} (1, 0.3)(1, 0.2)(1, 0.3) \\ (1, 0.4)(1, 0.5)(1, 0.2) \\ (1, 0.5)(1, 0.1)(1, 0.4) \end{bmatrix}$$

$$\text{tr}(A^c + B^c) = \{ \max(1, 1, 1), \min(0.3, 0.5, 0.4) \} = (1, 0.3)$$

V. NEW FUZZY SOFT MATRIX THEORY IN DECISION MAKING

In this section we adopted the definition of fuzzy soft matrix decision method proposed by P. Rajarajeswari, P. Dhanalakshmi in [30] to the case of fuzzy soft matrix based on reference function in order to define a new fuzzy soft matrix decision method based on reference function.

5.1. Definition: (Value Matrix)

Let $A = [a_{ij}, 0] \in [\text{FSM}]_{m \times n}$. Then we define the value matrix of fuzzy soft matrix A based on reference function as $V(A) = [a_{ij} - r_{ij}]$, $i = 1, 2, \dots, m, j = 1, 2, 3, \dots, n$, where $r_{ij} = [0]_{m \times n}$.

5.2. Definition: (Score Matrix)

If $A = [a_{ij}] \in \text{FSM}, B = [b_{ij}] \in [\text{FSM}]_{m \times n}$. Then we define score matrix of A and B as:

$$S_{A,B} = [d_{ij}]_{m \times n} \text{ where } [d_{ij}] = V(A) - V(B)$$

5.3. Definition: (Total Score)

If $A = [a_{ij}, 0] \in [\text{FSM}]_{m \times n}, B = [b_{ij}, 0] \in [\text{FSM}]_{m \times n}$. Let the corresponding value matrices be $V(A), V(B)$ and their score matrix is $S_{A,B} = [d_{ij}]_{m \times n}$ then we define total score for each c_i in U as $s_i = \sum_{j=1}^n d_{ij}$.

Methodology and algorithm

Assume that there is a set of candidates (programmer), $U = \{c_1, c_2, \dots, c_n\}$ is a set of candidates to be recruited by software development organization in programmer post. Let E is a set of parameters related to innovative attitude of the programmer. We construct fuzzy soft set (F, E) over U represent the selection of candidate by field expert X, where F is a mapping $F: E \rightarrow F^u, F^u$ is the collection of all fuzzy subsets of U . We further construct another fuzzy soft set (G, E) over U represent the selection of candidate by field expert Y, where G is a mapping $G: E \rightarrow F^u, F^u$ is the collection of all fuzzy subsets of U . The matrices A and B corresponding to the fuzzy softsets (F, E) and (G, E) are constructed, we compute the complements and their matrices A^c and B^c corresponding to $(F, E)^c$ and $(G, E)^c$ respectively. Compute $A + B$ which is the maximum membership of selection of candidates by the judges. Compute $A^c + B^c$ which is the maximum membership of non selection of candidates by the judges. using def (5.1), Compute $V(A+B), V(A^c + B^c) = S_{((A+B), (A^c+B^c))}$ and the total

score S_i for each candidate in U . Finally find S_j $\max(S_i)$, then conclude that the candidate c_j has selected by the judges. If S_j has more than one value the process is repeated by reassessing the parameters.

Now, using definitions 5-1, 5-2 and 5-3 we can construct a fuzzy soft matrix decision making method based on reference function by the following algorithm.

Algorithm

Step1: Input the fuzzy soft set (F, E), (G, E) and obtain the fuzzy soft matrices A, B corresponding to (F, E) and (G, E) respectively.

Step2: Write the fuzzy soft complement set $(F, E)^c$, $(G, E)^c$ and obtain the fuzzy soft matrices A^c , B^c corresponding to $(F, E)^c$ and $(G, E)^c$ respectively.

Step3: Compute $(A+B)$, (A^c+B^c) , $V(A+B)$, $V(A^c+B^c)$ and $S_{((A+B), (A^c+B^c))}$.

Step4: Compute the total score S_i for each c_i in U .

Step5: Find c_i for which $\max(S_i)$.

Then we conclude that the candidate c_i is selected for the post.

In case $\max S_i$ occurs for more than one value, then repeat the process by reassessing the parameters.

Case Study

Let (F, E) and (G, E) be two fuzzy soft set based on reference function representing the selection of four candidates from the universal set $U = \{c_1, c_2, c_3, c_4\}$ by the experts X, and Y. Let $E = \{e_1, e_2, e_3\}$ be the set of parameters which stand for intelligence, innovative and analysis.

$(F, E) = \{F(e_1) = \{(c_1, 0.1, 0), (c_2, 0.5, 0), (c_3, 0.1, 0), (c_4, 0.4, 0)\}, F(e_2) = \{(c_1, 0.6, 0), (c_2, 0.4, 0), (c_3, 0.5, 0), (c_4, 0.7, 0)\}, F(e_3) = \{(c_1, 0.5, 0), (c_2, 0.7, 0), (c_3, 0.6, 0), (c_4, 0.5, 0)\}\}$.

$(G, E) = \{G(e_1) = \{(c_1, 0.2, 0), (c_2, 0.6, 0), (c_3, 0.2, 0), (c_4, 0.3, 0)\}, G(e_2) = \{(c_1, 0.6, 0), (c_2, 0.5, 0), (c_3, 0.6, 0), (c_4, 0.8, 0)\}, G(e_3) = \{(c_1, 0.5, 0), (c_2, 0.8, 0), (c_3, 0.7, 0), (c_4, 0.5, 0)\}\}$.

These two fuzzy soft sets based on reference function are represented by the following fuzzy soft matrices based on reference function respectively

$$A = \begin{bmatrix} (0.1, 0)(0.6, 0)(0.5, 0) \\ (0.5, 0)(0.4, 0)(0.7, 0) \\ (0.1, 0)(0.5, 0)(0.6, 0) \\ (0.4, 0)(0.7, 0)(0.5, 0) \end{bmatrix}, B = \begin{bmatrix} (0.2, 0)(0.6, 0)(0.5, 0) \\ (0.6, 0)(0.5, 0)(0.8, 0) \\ (0.2, 0)(0.6, 0)(0.7, 0) \\ (0.3, 0)(0.8, 0)(0.5, 0) \end{bmatrix}$$

Then, the fuzzy soft complement matrices based on reference function are

$$A^c = \begin{bmatrix} (1.0, 1)(1.0, 6)(1.0, 5) \\ (1.0, 5)(1.0, 4)(1.0, 7) \\ (1.0, 1)(1.0, 5)(1.0, 6) \\ (1.0, 4)(1.0, 7)(1.0, 5) \end{bmatrix}, B^c = \begin{bmatrix} (1.0, 2)(1.0, 6)(1.0, 5) \\ (1.0, 6)(1.0, 5)(1.0, 8) \\ (1.0, 2)(1.0, 6)(1.0, 7) \\ (1.0, 3)(1.0, 8)(1.0, 5) \end{bmatrix}$$

Then the addition matrices are

$$A+B = \begin{bmatrix} (0.2, 0)(0.6, 0)(0.5, 0) \\ (0.6, 0)(0.5, 0)(0.8, 0) \\ (0.2, 0)(0.6, 0)(0.7, 0) \\ (0.4, 0)(0.8, 0)(0.5, 0) \end{bmatrix}, A^c+B^c = \begin{bmatrix} (1.0, 1)(1.0, 6)(1.0, 5) \\ (1.0, 5)(1.0, 4)(1.0, 7) \\ (1.0, 1)(1.0, 5)(1.0, 6) \\ (1.0, 3)(1.0, 7)(1.0, 5) \end{bmatrix}$$

$$V(A+B) = \begin{bmatrix} 0.2 & 0.6 & 0.5 \\ 0.6 & 0.5 & 0.8 \\ 0.2 & 0.6 & 0.7 \\ 0.4 & 0.8 & 0.5 \end{bmatrix}, V(A^c+B^c) = \begin{bmatrix} 0.9 & 0.4 & 0.5 \\ 0.5 & 0.6 & 0.3 \\ 0.9 & 0.5 & 0.4 \\ 0.7 & 0.3 & 0.5 \end{bmatrix}$$

Calculate the score matrix and the total score for selection

$$S_{((A+B), (A^c+B^c))} = \begin{bmatrix} -0.7 & 0.2 & 0 \\ 0.1 & -0.1 & 0.5 \\ -0.3 & 0.5 & 0 \end{bmatrix}$$

$$\text{Total score} = \begin{bmatrix} -0.5 \\ 0.5 \\ -0.3 \\ 0.2 \end{bmatrix}$$

We see that the second candidate has the maximum value and thus conclude that from both the expert's opinion, candidate c_2 is selected for the post.

VI. CONCLUSIONS

In our work, we have put forward some new concepts such as complement, trace of fuzzy soft matrix based on reference function. Some related properties have been established with example. Finally an application of fuzzy soft matrix based on reference function in decision making problem is given. It is hoped that our work will enhance this study in fuzzy soft matrix.

VII. ACKNOWLEDGMENTS

The authors would like to thank the anonymous reviewers for their careful reading of this paper and for their helpful comments.

REFERENCES

- [1] Zadeh Lotfi Ahmed. Fuzzy Sets, Information and Control, 8 (1965), pp. 338-353.
- [2] Krassimir Atanassov. Intuitionistic fuzzy sets, Fuzzy Sets and Systems, 20, (1986), pp.87-96.
- [3] Krassimir Atanassov. Intuitionistic fuzzy sets, Theory and Applications, Physica-Verlag, Wurzberg, 1999.
- [4] Michael G. Thomason. Convergence of powers of a fuzzy matrix, J. Math Anal. Appl. 57 (1977), pp.476-480.
- [5] I. Burhan Turksen. Interval valued fuzzy sets based on normal forms. Fuzzy Sets and

- Systems, 20 (1968), pp.191–210.
- [6] ZdzislawPawlak, Rough sets, International Journal of Information and ComputerSciences, 11 (1982), pp.341-356.
- [7] Molodtsov Dmitri. Soft Set Theory - First Result, Computers and Mathematics with Applications, Vol. 37 (1999), pp. 19-31.
- [8] NeogTridivJyoti, SutDusmantaKumar. An Application of Fuzzy Soft Sets in Decision Making Problems Using Fuzzy SoftMatrices, International Journal of Mathematical Archive, Vol. 2(11), pp. 2258-2263.
- [9] MajiPabitraKumar, BiswasRanjit. andRoy AkhilRanjan. Fuzzy Soft Sets, Journal of Fuzzy Mathematics, Vol. 9, no.3 (2001), pp. 589-602.
- [10] MajiPabitra. Kumar.and Roy AkhilRanjan. Soft Set Theory, Computers and Mathematics with Applications 45 (2003), pp. 555–562.
- [11] PinakiMajumdar, S. K. Samanta.Generalised fuzzy soft sets, Computers andMathematics with Applications, 59 (2010), pp.1425-1432.
- [12] FengFeng, C. Li, BijanDavvaz, MuhammadIrfan Ali. Soft sets combined with fuzzy setsand rough sets: a tentative approach, Soft Computing 14 (2010), pp.899–911.
- [13] Naim a man, SerdarEngino lu. Soft matrix theory and its decision making,Journal Coomputers & Mathematics with Applications, Volume 59 Issue10 (2010), pp. 3308-3314.
- [14] S. Ruban Raj, M. Saradha.Properties of Fuzzy Soft Set, International Journal for BasicSciences and Social Sciences (IJBSS), ISSN:2319-2968, 2(1) (2013), pp.112-118.
- [15] Jin Bai Kim, A. Baartmans. Determinant Theory for Fuzzy Matrices, Fuzzy Sets and Systems, 29(1989), pp.349-356.
- [16] JinBai Kim. Determinant theory for Fuzzy and Boolean Matrices, Congressus Numerantium Utilitus MathematicaPub ,(1978), pp.273-276.
- [17] Ki Hong Kim and Fred W. Roush. Generalized fuzzy matrices, Fuzzy Sets and Systems, 4 (1980), pp.293-315.
- [18] M.Z. Ragab and E.G. Emam The determinant and adjoint of a square fuzzy matrix, Fuzzy Setsand Systems, 61 (1994), pp.297-307.
- [19] M.Z. Ragab and E.G. Emam, On the min-max composition of fuzzy matrices, Fuzzy Sets and Systems, 75 (1995), pp.83-92.
- [20] Hiroshi Hashimoto. Convergence of powers of a fuzzy transitive matrix, Fuzzy Sets and Systems, 9 (1983), pp.153-160.
- [21] Jin Bai Kim.Inverses of Boolean Matrices, Bull.Inst.Math.Acod, Science 12 (2)(1984), 125-1
- [22] Young Yang, Chenli Ji. Fuzzy Soft Matrices and their Applications, Artificial Intelligence and Computational IntelligenceLecture Notes in Computer Science Volume 7002 (2011), pp. 618-627.
- [23] BaruahHemanta Kumar. The Theory of Fuzzy Sets: Beliefs and Realities, International Journal of Energy, Information and Communications, Vol. 2, Issue 2, (2011), pp. 1-22.
- [24] BaruahHemanta Kumar. Towards Forming A Field Of Fuzzy Sets, International Journal of Energy, Information and Communications, Vol. 2, Issue 1 (2011), pp. 16-20.
- [25] BaruahHemanta Kumar. Fuzzy Membership with respect to a Reference Function, Journal of the Assam Science Society, 40(3)(1999), pp.65-73.
- [26] Mamonidhar. Representation of Fuzzy Matrices Based on Reference Function, I.J. Intelligent Systems and Applications,02(2013), pp.84-90 , DOI: 10.5815/ijisa.2013.02.10.
- [27] Mamonidhar.A Note on Determinant and Adjoint of Fuzzy Square Matrix, I.J. Intelligent Systems and Applications, 05(2013), pp.58-67 ,DOI: 10.5815/ijisa.2013.05.07.
- [28] NeogTridivJyoti,SutDusmantaKumar. Fuzzy Soft Sets from a New PerspectiveInt. J Latest Trends Computing, Vol-2 No 3 (2011) , pp.439-450.
- [29] NeogTridivJyoti,SutDusmantaKumar,M. Bora.on Fuzzy Soft Matrix Theory, International Journal of Mathematical Archive ISSN 2229-5046, 3(2)v(2012),pp.491-500.
- [30] P. Rajarajeswari, P. Dhanalakshmi, “Intuitionistic Fuzzy Soft Matrix Theory And Its Application In Decision Making,International Journal of Engineering Research & Technology (IJERT), ISSN:2278-0181,Vol. 2 Issue 4 (2013), pp.1100-1111.

New Operations on Intuitionistic Fuzzy Soft Sets based on Second Zadeh's logical Operators

Said Broumi, Pinaki Majumdar, Florentin Smarandache

Said Broumi, Pinaki Majumdar, Florentin Smarandache (2014). New Operations on Intuitionistic Fuzzy Soft Sets based on Second Zadeh's logical Operators. *International Journal of Information Engineering and Electronic Business* 1, 25-31; DOI: 10.5815/ijieeb.2014.01.03

Abstract — In this paper, three new operations have been introduced on intuitionistic fuzzy soft sets. They are based on Second Zadeh's implication, conjunction and disjunction operations on intuitionistic fuzzy sets. Some examples of these operations were given and a few important properties were also studied.

Index Terms — Second Zadeh's implication, Second Zadeh's conjunction, Second Zadeh's disjunction, Intuitionistic fuzzy soft set.

1. Introduction

The concept of the intuitionistic fuzzy (IFS, for short) was introduced in 1983 by K. Atanassov [1] as an extension of Zadeh's fuzzy set. All operations, defined over fuzzy sets were transformed for the case the IFS case. This concept is capable of capturing the information that includes some degree of hesitation and applicable in various fields of research. For example, in decision making problems, particularly in the case of medical diagnosis, sales analysis, new product marketing, financial services, etc. Atanassov et al. [2,3] have widely applied theory of intuitionistic sets in logic programming, Szmidt and Kacprzyk [4] in group decision making, De et al [5] in medical diagnosis etc. Therefore in various engineering application, intuitionistic fuzzy sets techniques have been more popular than fuzzy sets techniques in recent years. After defining a lot of operations over intuitionistic fuzzy sets during last ten years [6], in 2011, K. Atanassov [7] constructed two new operations based on the First Zadeh's IF-implication [8] which are the First Zadeh's conjunction and disjunction, after that, in 2013, K. Atanassov [9] introduced the second type of Zadeh's conjunction and disjunction based on the

Second Zadeh's IF-implication. Later on, S. Broumi et al. [22] introduced three new operations based on first Zadeh's implication, conjunction and disjunction operations on intuitionistic fuzzy soft sets.

Another important concept that addresses uncertain information is the soft set theory originated by Molodtsov [10]. This concept is free from the parameterization inadequacy syndrome of fuzzy set theory, rough set theory, probability theory. Molodtsov has successfully applied the soft set theory in many different fields such as smoothness of functions, game theory, operations research, Riemann integration, Perron integration, and probability. In recent years, soft set theory has been received much attention since its appearance. There are many papers devoted to fuzzify the concept of soft set theory which leads to a series of mathematical models such as fuzzy soft set [11,12,13,14,15], generalized fuzzy soft set [16,17], possibility fuzzy soft set [18] and so on. Thereafter, P.K. Maji and his coworker [19] introduced the notion of intuitionistic fuzzy soft set which is based on a combination of the intuitionistic fuzzy sets and soft set models and studied the properties of intuitionistic fuzzy soft set. Later, a lot of extensions of intuitionistic fuzzy soft are appeared such as generalized intuitionistic fuzzy soft set [20], possibility intuitionistic fuzzy soft set [21] etc.

In this paper our aim is to extend the three new operations introduced by K.T. Atanassov to the case of intuitionistic fuzzy soft and study its properties. This paper is arranged in the following manner. In section 2, some basics related to soft set, fuzzy soft set and intuitionistic fuzzy soft set are presented. These definitions will help us in the section that will follow. In section 3, we discuss the three operations of intuitionistic fuzzy soft such as Second Zadeh's implication, Second Zadeh's intuitionistic fuzzy

conjunction and Second Zadeh's intuitionistic fuzzy disjunction. In section 4, we conclude the paper.

1. Preliminaries

In this section, some definitions and notions about soft sets and intuitionistic fuzzy soft set are given. These will be useful in later sections. For more detailed the reader can see [10, 11, 12, 13, 19].

Let U be an initial universe, and E be the set of all possible parameters under consideration with respect to U . The set of all subsets of U , i.e. the power set of U is denoted by $P(U)$ and the set of all intuitionistic fuzzy subsets of U is denoted by IF^U . Let A be a subset of E .

2.1. Definition.

A pair (F, A) is called a soft set over U , where F is a mapping given by $F: A \rightarrow P(U)$.

In other words, a soft set over U is a parameterized family of subsets of the universe U . For $\varepsilon \in A$, $F(\varepsilon)$ may be considered as the set of ε -approximate elements of the soft set (F, A) .

2.2. Definition

Let U be an initial universe set and E be the set of parameters. Let IFU denote the collection of all intuitionistic fuzzy subsets of U . Let $A \subseteq E$ pair (F, A) is called an intuitionistic fuzzy soft set over U where F is a mapping given by $F: A \rightarrow IFU$.

2.3. Definition

Let $F: A \rightarrow IFU$ then F is a function defined as $F(\varepsilon) = \{x, \mu_{F(\varepsilon)}(x), \nu_{F(\varepsilon)}(x) : x \in U, \varepsilon \in E\}$ where μ , ν denote the degree of membership and degree of non-membership respectively.

2.4. Definition.

For two intuitionistic fuzzy soft sets (F, A) and (G, B) over a common universe U , we say that (F, A) is an intuitionistic fuzzy soft subset of (G, B) if

- (1) $A \subseteq B$ and
 - (2) $F(\varepsilon) \subseteq G(\varepsilon)$ for all $\varepsilon \in A$. i.e. $\mu_{F(\varepsilon)}(x) \leq \mu_{G(\varepsilon)}(x)$, $\nu_{F(\varepsilon)}(x) \geq \nu_{G(\varepsilon)}(x)$ for all $\varepsilon \in E$ and
- We write $(F, A) \subseteq (G, B)$.

2.5. Definition.

Two intuitionistic fuzzy soft sets (F, A) and (G, B) over a common universe U are said to be soft equal if (F, A) is a soft subset of (G, B) and (G, B) is a soft subset of (F, A) .

2.6. Definition.

Let U be an initial universe, E be the set of parameters, and $A \subseteq E$.

- (a) (F, A) is called a null intuitionistic fuzzy soft set (with respect to the parameter set A), denoted by φ_A , if $F(\varepsilon) = \varphi$, with $\varphi_A = (\varphi, A) = \{(0, 1), \forall x \in U, \forall \varepsilon \in A\}$. (1)

- (b) (G, A) is called a absolute intuitionistic fuzzy soft set (with respect to the parameter set A), denoted by $\mathbf{1}_A$, if $G(\varepsilon) = U$, with $\mathbf{1}_A = (U, A) = \{(1, 0), \forall x \in U, \forall \varepsilon \in A\}$. (2)

2.7. Definition

Let (F, A) and (G, B) be two IFSSs over the same universe U . Then the union of (F, A) and (G, B) is denoted by $(F, A) \cup (G, B)$ and is defined by $(F, A) \cup (G, B) = (H, C)$, where $C = A \cup B$ and the truth-membership, falsity-membership of (H, C) are as follows:

$$K(\varepsilon) = \left\{ \begin{array}{l} \{\mu_{F(\varepsilon)}(x), \nu_{F(\varepsilon)}(x) : x \in U\} \text{ for } \varepsilon \in A - B \\ \{\mu_{G(\varepsilon)}(x), \nu_{G(\varepsilon)}(x) : x \in U\} \text{ for } \varepsilon \in B - A \\ \{\max(\mu_{F(\varepsilon)}(x), \mu_{G(\varepsilon)}(x)), \min(\nu_{F(\varepsilon)}(x), \nu_{G(\varepsilon)}(x)) : x \in U\} \text{ for } \varepsilon \in A \cap B \end{array} \right. \quad (3)$$

Where $\mu_{(F, A) \cup (G, B)}(x) = \max(\mu_{F(\varepsilon)}(x), \mu_{G(\varepsilon)}(x))$ and $\nu_{(F, A) \cup (G, B)}(x) = \min(\nu_{F(\varepsilon)}(x), \nu_{G(\varepsilon)}(x))$

2.8. Definition

Let (F, A) and (G, B) be two IFSSs over the same universe U such that $A \cap B \neq \emptyset$. Then the intersection of (F, A) and (G, B) is denoted by $(F, A) \cap (G, B)$ and is defined by $(F, A) \cap (G, B) = (K, C)$, where $C = A \cap B$ and the truth-membership, falsity-membership of (K, C) are related to those of (F, A) and (G, B) by:

$$K(\varepsilon) = \left\{ \begin{array}{l} \{\mu_{F(\varepsilon)}(x), \nu_{F(\varepsilon)}(x) : x \in U\} \text{ for } \varepsilon \in A - B \\ \{\mu_{G(\varepsilon)}(x), \nu_{G(\varepsilon)}(x) : x \in U\} \text{ for } \varepsilon \in B - A \\ \{\min(\mu_{F(\varepsilon)}(x), \mu_{G(\varepsilon)}(x)), \max(\nu_{F(\varepsilon)}(x), \nu_{G(\varepsilon)}(x)) : x \in U\} \text{ for } \varepsilon \in A \cap B \end{array} \right. \quad (4)$$

In the next section, we state and prove some new operations involving second implication, conjunction and disjunction of intuitionistic fuzzy soft set.

2. New Operations on Intuitionistic Fuzzy Soft Sets.

3.1 Second Zadeh's implication of intuitionistic fuzzy soft sets.

3.1.1. Definition:

Let (F, A) and (G, B) are two intuitionistic fuzzy soft set over (U, E) . We define the second Zadeh's intuitionistic fuzzy soft set implication $(F, A) \rightarrow (G, B)$ by

$$(F, A) \rightarrow (G, B) = \left\{ \begin{array}{l} \{\nu_{F(\varepsilon)}(x), \mu_{G(\varepsilon)}(x) : x \in U\} \text{ for } \varepsilon \in A - B \\ \{\mu_{F(\varepsilon)}(x), \nu_{G(\varepsilon)}(x) : x \in U\} \text{ for } \varepsilon \in B - A \\ \{\min(\nu_{F(\varepsilon)}(x), \mu_{G(\varepsilon)}(x)), \max(\mu_{F(\varepsilon)}(x), \nu_{G(\varepsilon)}(x)) : x \in U\} \text{ for } \varepsilon \in A \cap B \end{array} \right. \quad (5)$$

3.1.2. Example:

Let (F, A) and (G, B) be two intuitionistic fuzzy soft set over (U, E) where $U = \{a, b, c\}$ and $E = \{e_1, e_2\}$, $A = \{e_1\} \subseteq E$, $B = \{e_1\} \subseteq E$.

$$(F, A) = \{F(e_1) = (a, 0.3, 0.2), (b, 0.2, 0.5), (c, 0.4, 0.2)\}$$

$$(G, B) = \{G(e_1) = (a, 0.4, 0.5), (b, 0.3, 0.5), (c, 0.6, 0.1)\}$$

Then

$$(F, A) \rightarrow (G, B) = \{(a, 0.3, 0.3), (b, 0.5, 0.2), (c, 0.4, 0.2)\}$$

3.1.3. Proposition:

Let (F, A), (G, B) and (H, C) are three intuitionistic fuzzy soft sets over (U, E).

Then the following results hold

- (i) $(F, A) \cap (G, B) \rightarrow (H, C) \supseteq [(F, A) \rightarrow (H, C)] \cup [(G, B) \rightarrow (H, C)]$
- (ii) $(F, A) \cup (G, B) \rightarrow (H, C) \supseteq [(F, A) \rightarrow (H, C)] \cup [(G, B) \rightarrow (H, C)]$
- (iii) $(F, A) \rightarrow (F, A)^c = (F, A)$
- (iv) $(F, A) \rightarrow (\varnothing) = (F, A)^c$ where \varnothing denote the null intuitionistic fuzzy soft
- (v) With $(\varnothing) = \{(0, 1), (U, A)\}$

Proof.

(i) $(F, A) \cap (G, B) \rightarrow (H, C)$

$$[\min (v_{(F \cap G)}(x), \mu_{(F \cap G)}(x)), \max (v_{(F \cap G)}(x), \mu_{(F \cap G)}(x))] \rightarrow (v_{(H)}(x), \mu_{(H)}(x))$$

$$\left[\begin{matrix} \max\{(\max(v_{(F \cap G)}(x), \mu_{(F \cap G)}(x)), \min(\mu_{(F \cap G)}(x), v_{(F \cap G)}(x)), \mu_{(H)}(x)\}, \\ \min\{(\min(\mu_{(F \cap G)}(x), v_{(F \cap G)}(x)), \max(v_{(F \cap G)}(x), \mu_{(F \cap G)}(x)), \mu_{(H)}(x)\} \end{matrix} \right]$$

(a)

$$[(F, A) \rightarrow (H, C)] \cup [(G, B) \rightarrow (H, C)]$$

$$\left[\begin{matrix} \max\{(\max(v_{(F \cap G)}(x), \mu_{(F \cap G)}(x)), \min(\mu_{(F \cap G)}(x), v_{(F \cap G)}(x)), \mu_{(H)}(x)\}, \\ \min\{(\min(\mu_{(F \cap G)}(x), v_{(F \cap G)}(x)), \max(v_{(F \cap G)}(x), \mu_{(F \cap G)}(x)), \mu_{(H)}(x)\} \end{matrix} \right] \cup \left[\begin{matrix} \max\{(\max(v_{(G \cap B)}(x), \mu_{(G \cap B)}(x)), \min(\mu_{(G \cap B)}(x), v_{(G \cap B)}(x)), \mu_{(H)}(x)\}, \\ \min\{(\min(\mu_{(G \cap B)}(x), v_{(G \cap B)}(x)), \max(v_{(G \cap B)}(x), \mu_{(G \cap B)}(x)), \mu_{(H)}(x)\} \end{matrix} \right]$$

$$\left[\begin{matrix} \max\{(\max(v_{(F \cap G)}(x), \mu_{(F \cap G)}(x)), \min(\mu_{(F \cap G)}(x), v_{(F \cap G)}(x)), \mu_{(H)}(x)\}, \\ \min\{(\min(\mu_{(F \cap G)}(x), v_{(F \cap G)}(x)), \max(v_{(F \cap G)}(x), \mu_{(F \cap G)}(x)), \mu_{(H)}(x)\} \end{matrix} \right] \cup \left[\begin{matrix} \max\{(\max(v_{(G \cap B)}(x), \mu_{(G \cap B)}(x)), \min(\mu_{(G \cap B)}(x), v_{(G \cap B)}(x)), \mu_{(H)}(x)\}, \\ \min\{(\min(\mu_{(G \cap B)}(x), v_{(G \cap B)}(x)), \max(v_{(G \cap B)}(x), \mu_{(G \cap B)}(x)), \mu_{(H)}(x)\} \end{matrix} \right]$$

(b)

From (a) and (b) it is clear that $(F, A) \cap (G, B) \rightarrow (H, C)$

$$[(F, A) \rightarrow (H, C)] \cup [(G, B) \rightarrow (H, C)]$$

(ii) $(F, A) \cup (G, B) \rightarrow (H, C)$

$$[\max (v_{(F \cup G)}(x), \mu_{(F \cup G)}(x)), \min (v_{(F \cup G)}(x), \mu_{(F \cup G)}(x))] \rightarrow (v_{(H)}(x), \mu_{(H)}(x))$$

$$\left[\begin{matrix} \max\{(\max(v_{(F \cup G)}(x), \mu_{(F \cup G)}(x)), \min(\mu_{(F \cup G)}(x), v_{(F \cup G)}(x)), \mu_{(H)}(x)\}, \\ \min\{(\min(\mu_{(F \cup G)}(x), v_{(F \cup G)}(x)), \max(v_{(F \cup G)}(x), \mu_{(F \cup G)}(x)), \mu_{(H)}(x)\} \end{matrix} \right]$$

(c)

$$[(F, A) \rightarrow (H, C)] \cup [(G, B) \rightarrow (H, C)]$$

$$\left[\begin{matrix} \max\{(\max(v_{(F \cup G)}(x), \mu_{(F \cup G)}(x)), \min(\mu_{(F \cup G)}(x), v_{(F \cup G)}(x)), \mu_{(H)}(x)\}, \\ \min\{(\min(\mu_{(F \cup G)}(x), v_{(F \cup G)}(x)), \max(v_{(F \cup G)}(x), \mu_{(F \cup G)}(x)), \mu_{(H)}(x)\} \end{matrix} \right] \cup \left[\begin{matrix} \max\{(\max(v_{(G \cup B)}(x), \mu_{(G \cup B)}(x)), \min(\mu_{(G \cup B)}(x), v_{(G \cup B)}(x)), \mu_{(H)}(x)\}, \\ \min\{(\min(\mu_{(G \cup B)}(x), v_{(G \cup B)}(x)), \max(v_{(G \cup B)}(x), \mu_{(G \cup B)}(x)), \mu_{(H)}(x)\} \end{matrix} \right]$$

$$\left[\begin{matrix} \max\{(\max(v_{(F \cup G)}(x), \mu_{(F \cup G)}(x)), \min(\mu_{(F \cup G)}(x), v_{(F \cup G)}(x)), \mu_{(H)}(x)\}, \\ \min\{(\min(\mu_{(F \cup G)}(x), v_{(F \cup G)}(x)), \max(v_{(F \cup G)}(x), \mu_{(F \cup G)}(x)), \mu_{(H)}(x)\} \end{matrix} \right] \cup \left[\begin{matrix} \max\{(\max(v_{(G \cup B)}(x), \mu_{(G \cup B)}(x)), \min(\mu_{(G \cup B)}(x), v_{(G \cup B)}(x)), \mu_{(H)}(x)\}, \\ \min\{(\min(\mu_{(G \cup B)}(x), v_{(G \cup B)}(x)), \max(v_{(G \cup B)}(x), \mu_{(G \cup B)}(x)), \mu_{(H)}(x)\} \end{matrix} \right]$$

(d)

From (c) and (d) it is clear that $(F, A) \cup (G, B) \rightarrow (H, C)$

$$[(F, A) \rightarrow (H, C)] \cup [(G, B) \rightarrow (H, C)]$$

(iii) $(F, A) \rightarrow (F, A)^c = (F, A)$

$$\left[\begin{matrix} \max\{(\max(v_{(F \cap A^c)}(x), \mu_{(F \cap A^c)}(x)), \min(\mu_{(F \cap A^c)}(x), v_{(F \cap A^c)}(x)), \mu_{(F)}(x)\}, \\ \min\{(\min(\mu_{(F \cap A^c)}(x), v_{(F \cap A^c)}(x)), \max(v_{(F \cap A^c)}(x), \mu_{(F \cap A^c)}(x)), \mu_{(F)}(x)\} \end{matrix} \right]$$

$$= \left[\begin{matrix} \max\{(\max(v_{(F)}(x), \mu_{(F)}(x)), \min(\mu_{(F)}(x), v_{(F)}(x)), \mu_{(F)}(x)\}, \\ \min\{(\min(\mu_{(F)}(x), v_{(F)}(x)), \max(v_{(F)}(x), \mu_{(F)}(x)), \mu_{(F)}(x)\} \end{matrix} \right]$$

It is shown that the second Zadeh's intuitionistic fuzzy soft implication generate the complement of intuitionistic fuzzy soft set.

(iv) the proof is straightforward.

3.1.4. Example:

Let (F, A), (G, B) and (H, C) be three intuitionistic fuzzy soft set over (U, E) where $U = \{a, b, c\}$ and $E = \{e_1, e_2\}$, $A = \{e_1\} \subseteq E$, $B = \{e_1\} \subseteq E$ and $C = \{e_1\} \subseteq E$.

$$(F, A) = \{F(e_1) = (a, 0.3, 0.2), (b, 0.2, 0.5), (c, 0.4, 0.2)\}$$

$$(G, B) = \{G(e_1) = (a, 0.4, 0.5), (b, 0.3, 0.5), (c, 0.6, 0.1)\}$$

$$(H, C) = \{H(e_1) = (a, 0.3, 0.6), (b, 0.4, 0.5), (c, 0.4, 0.1)\}$$

Firstly, we have $(F, A) \cap (G, B) = \{(a, 0.3, 0.5), (b, 0.2, 0.5), (c, 0.4, 0.2)\}$

Then $(F, A) \cap (G, B) \rightarrow (H, C) = \left[\begin{matrix} \max\{(\max(v_{(F \cap G)}(x), \mu_{(F \cap G)}(x)), \min(\mu_{(F \cap G)}(x), v_{(F \cap G)}(x)), \mu_{(H)}(x)\}, \\ \min\{(\min(\mu_{(F \cap G)}(x), v_{(F \cap G)}(x)), \max(v_{(F \cap G)}(x), \mu_{(F \cap G)}(x)), \mu_{(H)}(x)\} \end{matrix} \right]$

{(a, 0.5, 0.3), (b, 0.5, 0.2), (c, 0.4, 0.4)}

3.2. Second Zadeh’s Intuitionistic Fuzzy Conjunction of intuitionistic fuzzy soft sets.

3.2.1. Definition:

Let (F, A) and (G, B) are two intuitionistic fuzzy soft sets over (U,E) .We define the second Zadeh s intuitionistic fuzzy conjunction of (F, A) and (G,B) as the intuitionistic fuzzy soft set (H,C) over (U,E), written as (F, A) $\tilde{\wedge}_{z,2}$ (G,B) (H ,C) Where C = A \cap B and $\forall \varepsilon \in C, x \in U,$

$$\begin{aligned} & \mu_{(F,A)}^{(\varepsilon)}(x) = \min \{ \mu_{(F,A)}^{(\varepsilon)}(x), \max(\mu_{(G,B)}^{(\varepsilon)}(x), \nu_{(G,B)}^{(\varepsilon)}(x)) \} \\ & \nu_{(F,A)}^{(\varepsilon)}(x) = \max \{ \nu_{(F,A)}^{(\varepsilon)}(x), \min(\mu_{(G,B)}^{(\varepsilon)}(x), \nu_{(G,B)}^{(\varepsilon)}(x)) \}, \forall x \in U, \quad A \end{aligned} \quad (6)$$

3.2. 2.Example:

Let U = {a, b, c} and E = {e₁, e₂, e₃, e₄}, A = {e₁, e₄} \subseteq E, B = {e₁, e₂, e₃} \subseteq E

(F, A) = { **F(e₁)** = {(a, 0.5, 0.1), (b, 0.1, 0.8), (c, 0.2, 0.5)}, **F(e₂)** = {(a, 0.7, 0.1), (b, 0, 0.8), (c, 0.3, 0.5)}, **F(e₄)** = {(a, 0.6, 0.3), (b, 0.1, 0.7), (c, 0.9, 0.1)} }

(G, B) = { **G(e₁)** = {(a, 0.2, 0.6), (b, 0.7, 0.1), (c, 0.8, 0.1)}, **G(e₂)** = {(a, 0.4, 0.1), (b, 0.5, 0.3), (c, 0.4, 0.5)}, **G(e₃)** = {(a, 0, 0.6), (b, 0, 0.8), (c, 0.1, 0.5)} }

Let (F, A) $\tilde{\wedge}_{z,2}$ (G,B) = (H, C), where C = A \cap B = {e₁, e₄}

(H, C) = { **H(e₁)** = {(a, min(0.5, max(0.1,0.2)), max(0.1, min(0.5, 0.6))), (b, min(0.1, max(0.8,0.7)), max(0.8, min(0.1, 0.1))), (c, min(0.2, max(0.5,0.8)), max(0.5, min(0.2, 0.1))),},

H(e₂) = {(a, min(0.7, max(0.1,0.4)), max(0.1, min(0.7, 0.1))), (b, min(0, max(0.8,0.5)), max(0.8, min(0, 0.3))), (c, min(0.3, max(0.5,0.4)), max(0.5, min(0.3, 0.5)))} }

Then ,(H, C) = { **H(e₁)** = {(a, min(0.5, 0.2), max(0.1, 0.5)), (b, min(0.1, 0.8), max(0.8, 0.1)), (c, min(0.2, 0.8), max(0.5, 0.1))}, **H(e₂)** = {(a, min(0.7, 0.4), max(0.1, 0.1)), (b, min(0, 0.8), max(0, 0.8)), (c, min(0.3, 0.5), max(0.5, 0.3))} }

Hence, (H, C) = { **H(e₁)** = {(a, 0.2, 0.5), (b, 0.1, 0.8), (c, 0.2, 0.5)}, **H(e₂)** = {(a, 0.4, 0.1), (b, 0, 0.8), (c, 0.3, 0.5)} }

3.2. 3 Proposition:

Let (F, A), (G, B) and (H, C) are three intuitionistic fuzzy soft sets over (U, E) Then the following result hold

$$\begin{aligned} (F, A) \tilde{\wedge}_{z,2} (G, B) \rightarrow (H, C) & \supseteq [(F, A) \rightarrow (H, C)] \tilde{\wedge} \\ & [(G, B) \rightarrow (H, C)] \end{aligned} \quad (7)$$

Proof: let (F, A), (G, B) and (H, C) are three intuitionistic fuzzy soft set, then

$$(F, A) \tilde{\wedge}_{z,2} (G, B) \rightarrow (H, C)$$

$$\begin{aligned} & (\max [\max \{ \mu_{(F,A)}^{(\varepsilon)}(x), \min(\mu_{(G,B)}^{(\varepsilon)}(x), \nu_{(G,B)}^{(\varepsilon)}(x)) \}, \min \{ \min \{ \mu_{(F,A)}^{(\varepsilon)}(x), \max(\nu_{(F,A)}^{(\varepsilon)}(x), \nu_{(G,B)}^{(\varepsilon)}(x)) \}, \mu_{(G,B)}^{(\varepsilon)}(x) \}], \\ & \min [\min \{ \mu_{(F,A)}^{(\varepsilon)}(x), \max(\nu_{(F,A)}^{(\varepsilon)}(x), \nu_{(G,B)}^{(\varepsilon)}(x)) \}, \max [\max \{ \mu_{(G,B)}^{(\varepsilon)}(x), \min(\nu_{(G,B)}^{(\varepsilon)}(x), \nu_{(F,A)}^{(\varepsilon)}(x)) \}, \mu_{(F,A)}^{(\varepsilon)}(x)]]) \end{aligned}$$

$$\text{Let } [(F, A) \rightarrow (H, C)] \tilde{\wedge}_{z,2} [(G, B) \rightarrow (H, C)]$$

$$\begin{aligned} (F, A) \rightarrow (H, C) & = (\max [\mu_{(F,A)}^{(\varepsilon)}(x), \min(\nu_{(F,A)}^{(\varepsilon)}(x), \nu_{(H,C)}^{(\varepsilon)}(x))], \\ & \min[\mu_{(H,C)}^{(\varepsilon)}(x), \max(\nu_{(F,A)}^{(\varepsilon)}(x), \nu_{(H,C)}^{(\varepsilon)}(x))]) \end{aligned}$$

$$\begin{aligned} [(G, B) \rightarrow (H, C)] & = (\max [\mu_{(G,B)}^{(\varepsilon)}(x), \min(\nu_{(G,B)}^{(\varepsilon)}(x), \nu_{(H,C)}^{(\varepsilon)}(x))], \\ & \min[\mu_{(H,C)}^{(\varepsilon)}(x), \max(\nu_{(G,B)}^{(\varepsilon)}(x), \nu_{(H,C)}^{(\varepsilon)}(x))]) \end{aligned}$$

$$\text{Then } [(F, A) \rightarrow (H, C)] \tilde{\wedge} [(G, B) \rightarrow (H, C)]$$

$$\begin{aligned} & (\min[\max \{ \mu_{(F,A)}^{(\varepsilon)}(x), \min(\nu_{(F,A)}^{(\varepsilon)}(x), \nu_{(H,C)}^{(\varepsilon)}(x)) \}, \max \{ \mu_{(G,B)}^{(\varepsilon)}(x), \min(\nu_{(G,B)}^{(\varepsilon)}(x), \nu_{(H,C)}^{(\varepsilon)}(x)) \}], \\ & \max \{ \min[\mu_{(F,A)}^{(\varepsilon)}(x), \max(\nu_{(F,A)}^{(\varepsilon)}(x), \nu_{(H,C)}^{(\varepsilon)}(x))], \min \{ \max [\mu_{(G,B)}^{(\varepsilon)}(x), \min(\nu_{(G,B)}^{(\varepsilon)}(x), \nu_{(H,C)}^{(\varepsilon)}(x))], \min[\mu_{(H,C)}^{(\varepsilon)}(x), \max(\nu_{(G,B)}^{(\varepsilon)}(x), \nu_{(H,C)}^{(\varepsilon)}(x)) \} \} \end{aligned}$$

$$\begin{aligned} & \max [\min[\mu_{(F,A)}^{(\varepsilon)}(x), \max(\nu_{(F,A)}^{(\varepsilon)}(x), \nu_{(H,C)}^{(\varepsilon)}(x))], \min \{ \max [\mu_{(G,B)}^{(\varepsilon)}(x), \min(\nu_{(G,B)}^{(\varepsilon)}(x), \nu_{(H,C)}^{(\varepsilon)}(x))], \\ & \min[\mu_{(H,C)}^{(\varepsilon)}(x), \max(\nu_{(G,B)}^{(\varepsilon)}(x), \nu_{(H,C)}^{(\varepsilon)}(x)) \} \} \end{aligned}$$

From (e) and (f) it is clear that

$$\begin{aligned} (F, A) \tilde{\wedge}_{z,2} (G, B) \rightarrow (H, C) & \supseteq [(F, A) \rightarrow (H, C)] \tilde{\wedge} \\ & [(G, B) \rightarrow (H, C)] \end{aligned}$$

3.3. The Second Zadeh’s Intuitionistic Fuzzy Disjunction of Intuitionistic Fuzzy Soft Sets.

3.3.1. Definition:

Let (F, A) and (G, B) are two intuitionistic fuzzy soft set s over (U, E) .We define the second Zadeh s intuitionistic fuzzy disjunction of (F, A) and (G, B) as the intuitionistic fuzzy soft set (H, C) over (U,E), written as (F, A) $\tilde{\vee}_{z2}$ (G, B) (H ,C) Where C = A \cup B and $\forall \varepsilon \in A, x \in U$

$$\begin{aligned} & \mu_{(F,A)}^{(\varepsilon)}(x) = \max(\mu_{(F,A)}^{(\varepsilon)}(x), \min(\mu_{(G,B)}^{(\varepsilon)}(x), \nu_{(G,B)}^{(\varepsilon)}(x))) \\ & \nu_{(F,A)}^{(\varepsilon)}(x) = \min \{ \nu_{(F,A)}^{(\varepsilon)}(x), \max(\mu_{(G,B)}^{(\varepsilon)}(x), \nu_{(G,B)}^{(\varepsilon)}(x)) \}, \forall x \in U, \quad A \end{aligned} \quad (8)$$

3.3. 2. Example:

Let $U = \{a, b, c\}$ and $E = \{e_1, e_2, e_3, e_4\}$, $A = \{e_1, e_4\} \subseteq E$, $B = \{e_1, e_2, e_3\} \subseteq E$

$(F, A) = \{F(e_1) = \{(a, 0.5, 0.1), (b, 0.1, 0.8), (c, 0.2, 0.5)\}, F(e_2) = \{(a, 0.7, 0.1), (b, 0, 0.8), (c, 0.3, 0.5)\}, F(e_4) = \{(a, 0.6, 0.3), (b, 0.1, 0.7), (c, 0.9, 0.1)\}\}$

$(G, A) = \{G(e_1) = \{(a, 0.2, 0.6), (b, 0.7, 0.1), (c, 0.8, 0.1)\}, G(e_2) = \{(a, 0.4, 0.1), (b, 0.5, 0.3), (c, 0.4, 0.5)\}, G(e_3) = \{(a, 0, 0.6), (b, 0, 0.8), (c, 0.1, 0.5)\}\}$

Let $(F, A) \tilde{V}_{z,2} (G, B) = (H, C)$, where $C = A \cap B = \{e_1, e_4\}$

$(H, C) = \{H(e_1) = \{(a, \max(0.5, \min(0.1, 0.2)), \min(0.1, \max(0.5, 0.6))), (b, \max(0.1, \min(0.8, 0.7)), \min(0.8, \max(0.1, 0.1))\}, H(e_4) = \{(a, \max(0.7, \min(0.1, 0.4)), \min(0.1, \max(0.7, 0.1))), (b, \max(0, \min(0.8, 0.5)), \min(0.8, \max(0, 0.3))), (c, \max(0.3, \min(0.5, 0.4)), \min(0.5, \max(0.3, 0.5))\}\}$

Then, $(H, C) = \{H(e_1) = \{(a, \max(0.5, 0.1), \min(0.1, 0.6)), (b, \max(0.1, 0.7), \min(0.8, 0.1)), (c, \max(0.2, 0.5), \min(0.5, 0.2))\}, H(e_2) = \{(a, \max(0.7, 0.1), \min(0.1, 0.7)), (b, \max(0, 0.5), \min(0.8, 0.3)), (c, \max(0.3, 0.4), \min(0.5, 0.5))\}\}$.

hence, $(H, C) = \{H(e_1) = \{(a, 0.5, 0.1), (b, 0.7, 0.1), (c, 0.5, 0.2)\}, H(e_2) = \{(a, 0.7, 0.1), (b, 0.5, 0.3), (c, 0.4, 0.5)\}\}$

3.3.3. Proposition:

- (i) $(\varphi, A) \tilde{\Lambda}_{z,2} (U, A) = (\varphi, A)$
- (ii) $(\varphi, A) \tilde{V}_{z,2} (U, A) = (U, A)$, where $(U, A) = \{(1, 0), (U, A)\}$
- (iii) $(F, A) \tilde{V}_{z,2} (\varphi, A) = (F, A)$

Proof

- (i) Let $(\varphi, A) \tilde{\Lambda}_{z,2} (U, A) = (H, A)$, where for all $A, x \in U$, we have

$$\begin{aligned} \mu_{(\varepsilon)}(x) &= \min(0, \max(1, 1)) = \min(0, 1) = 0 \\ \nu_{(\varepsilon)}(x) &= \max(1, \min(0, 0)) = \max(1, 0) = 1 \end{aligned}$$

Therefore $(H, A) = (0, 1)$, For all $\varepsilon \in A, x \in U$

It follows that $((\varphi, A) \tilde{\Lambda}_{z,2} (U, A) = (\varphi, A)$

- (ii) Let $(\varphi, A) \tilde{V}_{z,2} (U, A) = (H, A)$, where For all $A, x \in U$, we have

$$\begin{aligned} \mu_{(\varepsilon)}(x) &= \max(0, \min(1, 1)) = \max(0, 1) = 1 \\ \nu_{(\varepsilon)}(x) &= \min(1, \max(0, 0)) = \min(1, 0) = 0 \end{aligned}$$

Therefore $(H, A) = (1, 0)$, For all $A, x \in U$

It follows that $((\varphi, A) \tilde{V}_{z,2} (U, A) = (U, A)$

- (iii) Let $(F, A) \tilde{V}_{z,2} (\varphi, A) = (H, A)$, where For all $A, x \in U$, we have

$$\begin{aligned} \mu_{(\varepsilon)}(x) &= \max(\mu_{(\varepsilon)}(x), \min(\mu_{(\varepsilon)}(x), 0)) \\ &= \max(\mu_{(\varepsilon)}(x), 0) = \mu_{F(\varepsilon)}(x) \end{aligned}$$

$$\begin{aligned} \nu_{(\varepsilon)}(x) &= \min(\nu_{(\varepsilon)}(x), \max(\mu_{F(\varepsilon)}(x), 1)) = \\ &= \min(\nu_{F(\varepsilon)}(x), 1) = \nu_{F(\varepsilon)}(x) \end{aligned}$$

Therefore $(H, A) = (\mu_{(\varepsilon)}(x), \nu_{F(\varepsilon)}(x))$, for all $A, x \in U$

It follows that $(F, A) \tilde{V}_{z,2} (\varphi, A) = (F, A)$

3.3.4. Proposition:

$$(F, A) \tilde{V}_{z,1} (G, B) \rightarrow (H, C) \supseteq [(F, A) \rightarrow (H, C)] \tilde{V} [(G, B) \rightarrow (H, C)] \tag{9}$$

Proof, the proof is similar as in proposition 3.2.3

3.3.5. Proposition:

- (i) $[(F, A) \tilde{\Lambda}_{z,2} (G, B)]^c = (A)^c \tilde{V}_{z,2} (G, B)$
- (ii) $[(F, A) \tilde{V}_{z,2} (G, B)]^c = (A)^c \tilde{\Lambda}_{z,2} (G, B)$
- (iii) $[(F, A)^c \tilde{\Lambda}_{z,2} (G, B)]^c = (F, A) \tilde{V}_{z,2} (G, B)$

Proof:

- (i) Let $[(F, A) \tilde{\Lambda}_{z,2} (G, B)]^c = (H, C)$, where For all $C, x \in U$, we have

$$\begin{aligned} \mu_{(\varepsilon)}(x) &= [\min\{\mu_{(\varepsilon)}(x), \max(\mu_{(\varepsilon)}(x), \mu_{(\varepsilon)}(x))\}]^c = \max\{\mu_{(\varepsilon)}(x), \min(\mu_{(\varepsilon)}(x), \mu_{(\varepsilon)}(x))\} \\ \nu_{(\varepsilon)}(x) &= [\max\{\mu_{(\varepsilon)}(x), \min(\mu_{(\varepsilon)}(x), \mu_{(\varepsilon)}(x))\}]^c = \min\{\mu_{(\varepsilon)}(x), \max(\mu_{(\varepsilon)}(x), \mu_{(\varepsilon)}(x))\} \end{aligned}$$

- (ii) Let $[(F, A) \tilde{V}_{z,2} (G, B)]^c = (H, C)$, where For all $C, x \in U$, we have

$$\begin{aligned} \mu_{(\varepsilon)}(x) &= [\max\{\mu_{(\varepsilon)}(x), \min(\mu_{(\varepsilon)}(x), \mu_{(\varepsilon)}(x))\}]^c = \min\{\mu_{(\varepsilon)}(x), \max(\mu_{(\varepsilon)}(x), \mu_{(\varepsilon)}(x))\} \\ \nu_{(\varepsilon)}(x) &= [\min\{\mu_{(\varepsilon)}(x), \max(\mu_{(\varepsilon)}(x), \mu_{(\varepsilon)}(x))\}]^c = \max\{\mu_{(\varepsilon)}(x), \min(\mu_{(\varepsilon)}(x), \mu_{(\varepsilon)}(x))\} \end{aligned}$$

- (iii) The proof is straightforward.

3.3.6. Proposition:

The following equalities are not valid

- I. $(F, A) \tilde{V}_{z,2} (G, B) = (G, B) \tilde{V}_{z,2} (F, A)$
- II. $(F, A) \tilde{\Lambda}_{z,2} (G, B) = (G, B) \tilde{\Lambda}_{z,2} (F, A)$

- III. $[(F, A) \tilde{\lambda}_{z,2}(G, B)] \tilde{\lambda}_{z,2}(K, C) \quad (F, A) \tilde{\lambda}_{z,2} [(G, B) \tilde{\lambda}_{z,2}(K, C)]$
- IV. $[(F, A) \tilde{\nu}_{z,2}(G, B)] \tilde{\nu}_{z,2}(K, C) \quad (F, A) \tilde{\nu}_{z,2} [(G, B) \tilde{\nu}_{z,2}(K, C)]$
- V. $[(F, A) \tilde{\lambda}_{z,2}(G, B)] \tilde{\nu}_{z,2}(K, C) \quad [(F, A) \tilde{\nu}_{z,2}(G, B)] \tilde{\lambda}_{z,2} [(G, B) \tilde{\nu}_{z,2}(K, C)]$
- VI. $[(F, A) \tilde{\nu}_{z,2}(G, B)] \tilde{\lambda}_{z,2}(K, C) \quad [(F, A) \tilde{\lambda}_{z,2}(G, B)] \tilde{\nu}_{z,2} [(G, B) \tilde{\lambda}_{z,2}(K, C)]$

3.3.7. Example :

Let $U = \{a, b, c\}$ and $E = \{e_1, e_2, e_3, e_4\}$, $A = \{e_1, e_2, e_4\}$
 $E, B = \{e_1, e_2, e_3\} \subseteq E$

$(F, A) = \{ \mathbf{F}(e_1) = \{(a, 0.5, 0.1), (b, 0.1, 0.8), (c, 0.2, 0.5)\}, \mathbf{F}(e_2) = \{(a, 0.7, 0.1), (b, 0, 0.8), (c, 0.3, 0.5)\}, \mathbf{F}(e_4) = \{(a, 0.6, 0.3), (b, 0.1, 0.7), (c, 0.9, 0.1)\} \}$, $(G, B) = \{ \mathbf{G}(e_1) = \{(a, 0.2, 0.6), (b, 0.7, 0.1), (c, 0.8, 0.1)\}, \mathbf{G}(e_2) = \{(a, 0.4, 0.1), (b, 0.5, 0.3), (c, 0.4, 0.5)\}, \mathbf{G}(e_3) = \{(a, 0, 0.6), (b, 0, 0.8), (c, 0.1, 0.5)\} \}$

Let $(F, A) \tilde{\lambda}_{z,2} (G, B) = (H, C)$, where $C = A \cap B = \{e_1, e_2\}$

Then $(F, A) \tilde{\lambda}_{z,2} (G, B) = (H, C) = \{ \mathbf{H}(e_1) = \{(a, 0.2, 0.5), (b, 0.1, 0.8), (c, 0.2, 0.5)\}, \mathbf{H}(e_2) = \{(a, 0.4, 0.1), (b, 0, 0.8), (c, 0.3, 0.5)\} \}$

For $(G, B) \tilde{\lambda}_{z,2} (F, A) = (K, C)$, where $K = A \cap B = \{e_1, e_2\}$

$(K, C) = \{ \mathbf{K}(e_1) = \{(a, \min(0.2, \max(0.6, 0.5)), \max(0.6, \min(0.2, 0.1)))\}, \mathbf{K}(e_2) = \{(a, \min(0.7, \max(0.1, 0.1)), \max(0.1, \min(0.7, 0.8)))\}, \mathbf{K}(e_3) = \{(a, \min(0.8, \max(0.1, 0.2)), \max(0.1, \min(0.8, 0.5)))\} \}$, $\mathbf{K}(e_2) = \{(a, \min(0.7, \max(0.1, 0.4)), \max(0.1, \min(0.4, 0.1)))\}$, $\mathbf{K}(e_3) = \{(a, \min(0.7, \max(0.1, 0.4)), \max(0.1, \min(0.4, 0.1)))\}$, $\mathbf{K}(e_4) = \{(a, \min(0.5, \max(0.3, 0.)), \max(0.3, \min(0.5, 0.8)))\}$, $\mathbf{K}(e_5) = \{(a, \min(0.5, \max(0.3, 0.)), \max(0.3, \min(0.5, 0.8)))\}$

Then, $(K, C) = \{ \mathbf{K}(e_1) = \{(a, \min(0.2, 0.6), \max(0.6, 0.1))\}, \mathbf{K}(e_2) = \{(a, \min(0.7, 0.1), \max(0.1, 0.7))\}, \mathbf{K}(e_3) = \{(a, \min(0.8, 0.2), \max(0.1, 0.5))\}, \mathbf{K}(e_4) = \{(a, \min(0.4, 0.4), \max(0.1, 0.1))\}, \mathbf{K}(e_5) = \{(a, \min(0.5, 0.3), \max(0.3, 0.5))\}, \mathbf{K}(e_6) = \{(a, \min(0.4, 0.5), \max(0.5, 0.4))\} \}$

Hence, $(K, C) = \{ \mathbf{K}(e_1) = \{(a, 0.2, 0.6), (b, 0.1, 0.7), (c, 0.2, 0.5)\}, \mathbf{K}(e_2) = \{(a, 0.4, 0.1), (b, 0, 0.5), (c, 0.3, 0.5)\} \}$
 Then $(G, B) \tilde{\lambda}_{z,2} (F, A) = (K, C) = \{ \mathbf{K}(e_1) = \{(a, 0.2, 0.6), (b, 0.1, 0.7), (c, 0.2, 0.5)\}, \mathbf{K}(e_2) = \{(a, 0.4, 0.1), (b, 0.3, 0.5), (c, 0.4, 0.5)\} \}$

It is obviously that $(F, A) \tilde{\lambda}_{z,2} (G, B) \neq (G, B) \tilde{\lambda}_{z,2} (F, A)$

. Conclusion

In this paper, We have introduced and extended the operations of second Zadeh s implication, second Zadeh s intuitionistic fuzzy disjunction and second Zadeh s intuitionistic fuzzy conjunction of intuitionistic fuzzy set that was introduced by Krassimir Atanasov in relation to the intuitionistic fuzzy soft set and other related properties with examples are presented. We hope that the findings, in this paper will help researchers enhance the study on the intuitionistic fuzzy soft set theory.

References

- [1] K.T. Atanassov, "intuitionistic fuzzy set". Fuzzy Sets and Systems, vol. 20(1), pp.87-86, 1986.
- [2] K.T. Atanassov and G. Gargov, "intuitionistic fuzzy logic "C.R Academy of Bulgarian Society, Vol. 53, pp .9-12, 1990
- [3] K.T. Atanassov, and G.Gargov, "intuitionistic fuzzy prolog ", Fuzzy Sets and sSystems, Vol. 4, No 3, ,1993 pp .121-128
- [4] E.Szmidt and J.Kacprzyk, "Intuitionistic fuzzy sets in group decision making", Notes on IFS 2, 1996, pp.11-14.
- [5] S.K.De, R. Biswas and A.Roy, "an application of intuitionistic fuzzy set in medical diagnosis ", Fuzzy Sets and Systems, vol .117, 2001, pp 209-213.
- [6] K.T. Atanassov."Intuitionistic Fuzzy Sets ", Springer Physica-Verlag, Heidelberg, 1999.
- [7] K.T. Atanassov, " on some intuitionistic fuzzy implication. Comptes Rendus de l Academie bulgare des Sciences, Tome 59 , No .1 , 2006, pp.19-24.
- [8] K.T. Atanassov. "On Zadeh s intuitionistic fuzzy disjunction and conjunction. Notes on Intuitionistic Fuzzy Sets, Vol 17, No1, 2011, pp.1-4.
- [9] K.T. Atanassov. "Second Zadeh s intuitionistic fuzzy implication. Notes on Intuitionistic Fuzzy Sets, Vol .17, No 3, 2011, pp.11-14.
- [10] D. A. Molodtsov, "Soft Set Theory - First Result", Computers and Mathematics with Applications, Vol. 37, 1999, pp. 19-31.
- [11] P. K. Maji, R. Biswas and A.R. Roy, "Fuzzy Soft Sets", Journal of Fuzzy Mathematics, Vol 9 , No.3, 2001, pp.-589-602.
- [12] B. Ahmad, and A. Kharal, On Fuzzy Soft Sets, Hindawi Publishing Corporation, Advances in Fuzzy Systems, volume Article ID 586507, (2009), 6 pages doi: 10.1155/2009/586507.
- [13] P. K. Maji, A. R. Roy and R. Biswas, "Fuzzy soft sets" ,Journal of Fuzzy Mathematics. Vol 9, No 3, 2001, pp.589-602.

- [14] T. J. Neog and D. K. Sut, "On Fuzzy Soft Complement and Related Properties", Accepted for publication in International, Journal of Energy, Information and communications (IJEIC).
- [15] M. Borah, T. J. Neog and D. K. Sut," A study on some operations of fuzzy soft sets", International Journal of Modern Engineering Research (IJMER), Vol.2, no. 2, 2012, pp. 157-168.
- [16] H. L. Yang, "Notes On Generalized Fuzzy Soft Sets", Journal of Mathematical Research and Exposition, Vol 31, No. 3, (2011), pp.567-570.
- [17] P. Majumdar, S. K. Samanta, "Generalized Fuzzy Soft Sets", Computers and Mathematics with Applications, Vol 59, 2010, pp.1425-1432.
- [18] S. Alkhazaleh, A. R. Salleh, and N. Hassan," Possibility Fuzzy Soft Set", Advances in Decision Sciences, Vol 2011, Article ID 479756,18pages,doi:10.1155/2011/479756.
- [19] P. K. Maji, R. Biswas, A. R. Roy, "Intuitionistic Fuzzy Soft sets", The journal of fuzzy mathematics Vol 9, NO3 ,2001, pp.677-692.
- [20] K.V .Babitha and J. J. Sunil," Generalized Intuitionistic Fuzzy Soft Sets and Its Applications "Gen. Math. Notes, ISSN 2219-7184; Copyright ICSRS Publication, (2011), Vol. 7, No. 2, 2011, pp.1-14.
- [21] M.Bashir, A.R. Salleh, and S. Alkhazaleh," Possibility Intuitionistic Fuzzy Soft Set", Advances in Decision Sciences Volume 2012, 2012, Article ID 404325, 24 pages, doi:10.1155/2012/404325.
- [22] S. Broumi, P.Majumdar, F.Smarandache," New Operations on Intuitionistic Fuzzy Soft Set", 2013 ,submitted

New Results of Intuitionistic Fuzzy Soft Set

Said Broumi, Florentin Smarandache, Mamoni Dhar, Pinaki Majumdar

Said Broumi, Florentin Smarandache, Mamoni Dhar, Pinaki Majumdar (2014). New Results of Intuitionistic Fuzzy Soft Set. *International Journal of Information Engineering and Electronic Business* 2, 47-52; DOI: 10.5815/ijieeb.2014.02.06

Abstract In this paper, three new operations are introduced on intuitionistic fuzzy soft sets. They are based on concentration, dilatation and normalization of intuitionistic fuzzy sets. Some examples of these operations were given and a few important properties were also studied.

Index Terms Soft Set, Intuitionistic Fuzzy Soft Set, Concentration, Dilatation, Normalization.

I. INTRODUCTION

The concept of the intuitionistic fuzzy (IFS, for short) was introduced in 1983 by K. Atanassov [1] as an extension of Zadeh's fuzzy set. All operations, defined over fuzzy sets were transformed for the case of the IFS. This concept is capable of capturing the information that includes some degree of hesitation and applicable in various fields of research. For example, in decision making problems, particularly in the case of medical diagnosis, sales analysis, new product marketing, financial services, etc. Atanassov et al [2,3] have widely applied theory of intuitionistic sets in logic programming, Szmidt and Kacprzyk [4] in group decision making, De et al [5] in medical diagnosis etc. Therefore in various engineering applications, intuitionistic fuzzy sets techniques have been more popular than fuzzy sets techniques in recent years. Another important concept that addresses uncertain information is the soft set theory originated by Molodtsov [6]. This concept is free from the parameterization inadequacy syndrome of fuzzy set theory, rough set theory, probability theory. Molodtsov has successfully applied the soft set theory in many different fields such as smoothness of functions, game theory, operations research, Riemann integration, Perron

integration, and probability. In recent years, soft set theory has been received much attention since its appearance. There are many papers devoted to fuzzify the concept of soft set theory which leads to a series of mathematical models such as fuzzy soft set [7,8,9,10,11], generalized fuzzy soft set [12,13], possibility fuzzy soft set [14] and so on. Thereafter, P.K.Maji and his coauthor [15] introduced the notion of intuitionistic fuzzy soft set which is based on a combination of the intuitionistic fuzzy sets and soft set models and they studied the properties of intuitionistic fuzzy soft set. Then, a lot of extensions of intuitionistic fuzzy soft set have appeared such as generalized intuitionistic fuzzy soft set [16], possibility intuitionistic fuzzy soft set [17] etc.

In this paper our aim is to extend the two operations defined by Wang et al. [18] on intuitionistic fuzzy set to the case of intuitionistic fuzzy soft sets, then we define the concept of normalization of intuitionistic fuzzy soft sets and we study some of their basic properties.

This paper is arranged in the following manner. In section 2, some definitions and notions about soft set, fuzzy soft set, intuitionistic fuzzy soft set and several properties of them are presented. In section 3, we discuss the normalization intuitionistic fuzzy soft sets. In section 4, we conclude the paper.

II. PRELIMINARIES

In this section, some definitions and notions about soft sets and intuitionistic fuzzy soft set are given. These will be useful in later sections.

Let U be an initial universe, and E be the set of all possible parameters under consideration with respect to U . The set of all subsets of U , i.e. the power set of U is denoted by $P(U)$ and the set of all intuitionistic fuzzy subsets of U is denoted by IF^U . Let A be a subset of E .

2.1 Definition

A pair (F, A) is called a soft set over U, where F is a mapping given by F: A → P(U).

In other words, a soft set over U is a parameterized family of subsets of the universe U. For ε ∈ A, F(ε) may be considered as the set of ε -approximate elements of the soft set (F, A).

2.2 Definition

Let U be an initial universe set and E be the set of parameters. Let IF^U denote the collection of all intuitionistic fuzzy subsets of U. Let. A ⊆ E pair (F, A) is called an intuitionistic fuzzy soft set over U where F is a mapping given by F: A → IF^U.

2.3 Definition

Let F: A → IF^U then F is a function defined as F(ε) = {x, μ_{F(ε)}(x), ν_{F(ε)}(x) : x ∈ U, ε ∈ E} where μ, ν denote the degree of membership and degree of non-membership respectively.

2.4 Definition

For two intuitionistic fuzzy soft sets (F, A) and (G, B) over a common universe U, we say that (F, A) is an intuitionistic fuzzy soft subset of (G, B) if

(1) A ⊆ B and

(2) F(ε) ⊆ G(ε) for all ε ∈ A. i.e μ_{F(ε)}(x) ≤ μ_{G(ε)}(x), ν_{F(ε)}(x) ≥ ν_{G(ε)}(x) for all ε ∈ E and We write (F, A) ⊆ (G, B).

2.5 Definition

Two intuitionistic fuzzy soft sets (F, A) and (G, B) over a common universe U are said to be soft equal if (F, A) is a soft subset of (G, B) and (G, B) is a soft subset of (F, A).

2.6 Definition

Let U be an initial universe, E be the set of parameters, and A ⊆ E.

(a) (F, A) is called a null intuitionistic fuzzy soft set (with respect to the parameter set A), denoted by φ_A, if F(a) = ∅ for all a ∈ A.

(b) (G, A) is called an absolute intuitionistic fuzzy soft set (with respect to the parameter set A), denoted by U_A, if G(e) = U for all e ∈ A.

2.7 Definition

Let (F, A) and (G, B) be two IFSSs over the same universe U. Then the union of (F, A) and (G, B) is denoted by (F, A) ∪ (G, B) and is defined by (F, A) ∪ (G, B) = (H, C), where C = A ∪ B and the truth-membership, falsity-membership of (H, C) are as follows:

$$H(\varepsilon) = \left\{ \begin{array}{l} \{(\mu_{F(\varepsilon)}(x), \nu_{F(\varepsilon)}(x)) \mid x \in U\} \\ \{(\mu_{G(\varepsilon)}(x), \nu_{G(\varepsilon)}(x)) \mid x \in U\} \\ \{(\mu_{(F \cup G)(\varepsilon)}(x), \nu_{(F \cup G)(\varepsilon)}(x)) \mid x \in U\} \end{array} \right.$$

Where μ_{(F ∪ G)(ε)}(x) = max{μ_{F(ε)}(x), μ_{G(ε)}(x)} and ν_{(F ∪ G)(ε)}(x) = min{ν_{F(ε)}(x), ν_{G(ε)}(x)}

2.8 Definition

Let (F, A) and (G, B) be two IFSSs over the same universe U such that A ∩ B = ∅. Then the intersection of (F, A) and (G, B) is denoted by (F, A) ∩ (G, B) and is defined by (F, A) ∩ (G, B) = (K, C), where C = A ∩ B and the truth-membership, falsity-membership of (K, C) are related to those of (F, A) and (G, B) by:

$$K(\varepsilon) = \left\{ \begin{array}{l} \{(\mu_{F(\varepsilon)}(x), \nu_{F(\varepsilon)}(x)) \mid x \in U\} \\ \{(\mu_{G(\varepsilon)}(x), \nu_{G(\varepsilon)}(x)) \mid x \in U\} \\ \{(\mu_{(F \cap G)(\varepsilon)}(x), \nu_{(F \cap G)(\varepsilon)}(x)) \mid x \in U\} \end{array} \right.$$

III. CONCENTRATION OF INTUITIONISTIC FUZZY SOFT SET

3.1 Definition

The concentration of an intuitionistic fuzzy soft set (F, A) of universe U, denoted by CON(F, A), and is defined as a unary operation on IF^U:

$$\mathbf{Con}: IF^U \rightarrow IF^U$$

CON(F, A) = {Con{F(ε)} = {x, μ_{(F(ε))}(x), 1 - (1 - μ_{(F(ε))}(x))²} ⊆ U and ε ∈ A}. where

$$0 \leq \mu_{(F(\varepsilon))}(x), \nu_{(F(\varepsilon))}(x) \leq 1$$

$$\text{and } \mu_{(F(\varepsilon))}(x) + \nu_{(F(\varepsilon))}(x) \leq 1,$$

$$\text{we obtain } 0 \leq \mu_{(F(\varepsilon))}(x) \leq \mu_{(F(\varepsilon))}(x)$$

$$1 - (1 - \mu_{(F(\varepsilon))}(x)) \leq \nu_{(F(\varepsilon))}(x)$$

CON(F, A) ∈ IF^U, i.e CON(F, A) ⊆ (F, A) this means that concentration of a intuitionistic fuzzy soft set leads to a reduction of the degrees of membership.

In the following theorem, The operator CON reveals nice distributive properties with respect to intuitionistic union and intersection.

3.2 Theorem

- i. $\text{Con} (F, A) \subseteq (F, A)$
- ii. $\text{Con} ((F, A) \cup (G, B)) = \text{Con} (F, A) \cup \text{Con} (G, B)$
- iii. $\text{Con} ((F, A) \cap (G, B)) = \text{Con} (F, A) \cap \text{Con} (G, B)$
- iv. $\text{Con} ((F, A) \otimes (G, B)) = \text{Con} (F, A) \otimes \text{Con} (G, B)$
- v. $\text{Con} (F, A) \oplus \text{Con} (G, B) \subseteq \text{Con} ((F, A) \oplus (G, B))$
- vi. $(F, A) \subseteq (G, B) \Rightarrow \text{Con} (F, A) \subseteq \text{Con} (G, B)$

Proof, we prove only (v), i.e

$$\frac{(\varepsilon)(x) + (\varepsilon)(x) - (\varepsilon)(x)}{(\varepsilon)(x)} \cdot \frac{(\varepsilon)(x)}{(\varepsilon)(x)^2} = \frac{(\varepsilon)(x)}{(\varepsilon)(x)^2}$$

$$(1 - (1 - (\varepsilon)(x))^2) \cdot (1 - (1 - (\varepsilon)(x))^2) \geq 1 - (1 - (\varepsilon)(x))^2$$

a $(\varepsilon)(x), b (\varepsilon)(x), c (\varepsilon)(x), d \nu_{G(\varepsilon)}(x)$

$$+ - ()^2,$$

$$(1 - ()^2) \cdot (1 - ()^2) \geq 1 - (1 - c \cdot d)$$

The last inequality follows from $0 \leq a, b, c, d \leq 1$.

Example

Let $U = \{a, b, c\}$ and $E = \{e_1, e_2, e_3, e_4\}, A = \{e_1, e_2, e_3, e_4\}$
 $E, B = \{e_1, e_2, e_3\} \subseteq E$

$(F, A) = \{F(e_1) = \{(a, 0.5, 0.1), (b, 0.1, 0.8), (c, 0.2, 0.5)\}, F(e_2) = \{(a, 0.7, 0.1), (b, 0, 0.8), (c, 0.3, 0.5)\}, F(e_3) = \{(a, 0.6, 0.3), (b, 0.1, 0.7), (c, 0.9, 0.1)\}, F(e_4) = \{(a, 0.6, 0.3), (b, 0.1, 0.7), (c, 0.9, 0.1)\}\}$

$(G, B) = \{G(e_1) = \{(a, 0.2, 0.6), (b, 0.7, 0.1), (c, 0.8, 0.1)\}, G(e_2) = \{(a, 0.4, 0.1), (b, 0.5, 0.3), (c, 0.4, 0.5)\}, G(e_3) = \{(a, 0, 0.6), (b, 0, 0.8), (c, 0.1, 0.5)\}\}$

$\text{Con} (F, A) = \{\text{con}(F(e_1)) = \{(a, 0.25, 0.19), (b, 0.01, 0.96), (c, 0.04, 0.75)\}, \text{con}(F(e_2)) = \{(a, 0.49, 0.19), (b, 0, 0.96), (c, 0.09, 0.75)\}, \text{con}(F(e_3)) = \{(a, 0.36, 0.51), (b, 0.01, 0.91), (c, 0.81, 0.19)\}\}$

$\text{Con} (G, B) = \{\text{con}(G(e_1)) = \{(a, 0.04, 0.84), (b, 0.49, 0.19), (c, 0.64, 0.75)\},$

$\text{con}(G(e_2)) = \{(a, 0.16, 0.19), (b, 0.25, 0.51), (c, 0.16, 0.51)\}, \text{con}(G(e_3)) = \{(a, 0, 0.84), (b, 0, 0.96), (c, 0.01, 0.75)\}\}$

$(F, A) \cap (G, B) = (H, C) = \{H(e_1) = \{(a, 0.2, 0.6), (b, 0.1, 0.8), (c, 0.2, 0.5)\}, H(e_2) = \{(a, 0.4, 0.1), (b, 0, 0.8), (c, 0.3, 0.5)\}\}$

$\text{Con} ((F, A) \cap (G, B)) = \{\text{con} H(e_1) = \{(a, 0.04, 0.84), (b, 0.01, 0.96), (c, 0.04, 0.75)\}, \text{con} H(e_2) = \{(a, 0.16, 0.19), (b, 0, 0.96), (c, 0.09, 0.75)\}\}$

$\text{Con} (F, A) \cap \text{Con} (G, B) = (K, C) = \{\text{con} K(e_1) = \{(a, 0.04, 0.84), (b, 0.01, 0.96), (c, 0.04, 0.75)\}, \text{con} K(e_2) = \{(a, 0.16, 0.19), (b, 0, 0.96), (c, 0.09, 0.75)\}\}$

Then

$$\text{Con} ((F, A) \cap (G, B)) = \text{Con} (F, A) \cap \text{Con} (G, B)$$

IV. DILATATION OF INTUITIONISTIC FUZZY SOFT SET

4.1 Definition

The dilatation of an intuitionistic fuzzy soft set (F, A) of universe U , denoted by $\text{DIL} (F, A)$, and is defined as a unary operation on IF^U :

$$\text{DIL}: \text{IF}^U \rightarrow \text{IF}^U$$

$$(F, A) = \{x, (\varepsilon)(x), (\varepsilon)(x) \mid x \in U \text{ and } \varepsilon \in A\}$$

$$\text{DIL}(F, A) = \{\text{DIL} \{F(\varepsilon)\}$$

$$\{x, \mu_{F(\varepsilon)}^-(x), 1 - (1 - (\varepsilon)(x))^2 \mid x \in U \text{ and } \varepsilon \in A\}$$

where

$$\text{From } 0 \leq (\varepsilon)(x), (\varepsilon)(x) \leq 1,$$

$$\text{and } (\varepsilon)(x) + (\varepsilon)(x) \leq 1,$$

$$\text{we obtain } 0 \leq (\varepsilon)(x) \leq \mu_{F(\varepsilon)}^-(x)$$

$$0 \leq (1 - (\varepsilon)(x))^2 \leq (\varepsilon)(x)$$

$\text{DIL} (F, A) \in \text{IF}^U$, i.e $(F, A) \subseteq \text{DIL} (F, A)$ this means that dilatation of an intuitionistic fuzzy soft set leads to an increase of the degrees of membership.

4.2 Theorem

- i. $(F, A) \subseteq \text{DIL}(F, A)$
- ii. $\text{DIL} ((F, A) \cup (G, B)) = \text{DIL} (F, A) \cup \text{DIL} (G, B)$
- iii. $\text{DIL} ((F, A) \cap (G, B)) = \text{DIL}(F, A) \cap \text{DIL} (G, B)$
- iv. $\text{DIL}((F, A) \otimes (G, B)) = \text{DIL} (F, A) \otimes \text{DIL} (G, B)$
- v. $\text{DIL} (F, A) \oplus \text{DIL} (G, B) \subseteq \text{DIL} ((F, A) \oplus (G, B))$
- vi. $\text{CON} (\text{DIL} (F, A)) = (F, A)$
- vii. $\text{DIL} (\text{CON} (F, A)) = (F, A)$
- viii. $(F, A) \subseteq (G, B) \Rightarrow \text{DIL} (F, A) \subseteq \text{DIL}(G, B)$

Proof .we prove only (v), i.e

$$\frac{\bar{F}(\epsilon)(x) + \bar{G}(\epsilon)(x) - \bar{F}(\epsilon)(x) - \bar{G}(\epsilon)(x)}{\bar{F}(\epsilon)(x) \cdot \bar{G}(\epsilon)(x)} = \frac{\bar{F}(\epsilon)(x) - \bar{F}(\epsilon)(x)}{\bar{F}(\epsilon)(x) \cdot \bar{G}(\epsilon)(x)}$$

$$(1 - (1 - \bar{F}(\epsilon)(x))^2) \cdot (1 - (1 - \bar{G}(\epsilon)(x))^2) = 1 - (1 - \bar{F}(\epsilon)(x))^2 \cdot (1 - \bar{G}(\epsilon)(x))^2$$

$$a = \bar{F}(\epsilon)(x), b = \bar{G}(\epsilon)(x), c = \bar{F}(\epsilon)(x), d = \bar{G}(\epsilon)(x)$$

$$\frac{a + b - c - d}{a \cdot b} = \frac{a + b - a - b}{a \cdot b} = 0$$

The last inequality follows from $0 \leq a, b, c, d \leq 1$.

Example

Let $U = \{a, b, c\}$ and $E = \{e_1, e_2, e_3, e_4\}$, $A = \{e_1, e_2, e_4\}$
 $E, B = \{e_1, e_2, e_3\} \subseteq E$

$(F, A) = \{F(e_1) = \{(a, 0.5, 0.1), (b, 0.1, 0.8), (c, 0.2, 0.5)\}, F(e_2) = \{(a, 0.7, 0.1), (b, 0, 0.8), (c, 0.3, 0.5)\}, F(e_4) = \{(a, 0.6, 0.3), (b, 0.1, 0.7), (c, 0.9, 0.1)\}\}$ and

$(G, B) = \{G(e_1) = \{(a, 0.2, 0.6), (b, 0.7, 0.1), (c, 0.8, 0.1)\}, G(e_2) = \{(a, 0.4, 0.1), (b, 0.5, 0.3), (c, 0.4, 0.5)\}, G(e_3) = \{(a, 0, 0.6), (b, 0, 0.8), (c, 0.1, 0.5)\}\}$

$DIL(F, A) = \{DIL(F(e_1)) = \{(a, 0.70, 0.05), (b, 0.31, 0.55), (c, 0.44, 0.29)\}, DIL(F(e_2)) = \{(a, 0.83, 0.05), (b, 0, 0.55), (c, 0.54, 0.29)\}, DIL(F(e_4)) = \{(a, 0.77, 0.05), (b, 0.31, 0.45), (c, 0.94, 0.05)\}$ and

$DIL(G, B) = \{DIL(G(e_1)) = \{(a, 0.44, 0.36), (b, 0.83, 0.05), (c, 0.89, 0.05)\},$

$DIL(G(e_2)) = \{(a, 0.63, 0.05), (b, 0.70, 0.05), (c, 0.63, 0.29)\}, DIL(G(e_3)) = \{(a, 0, 0.36), (b, 0, 0.55), (c, 0.31, 0.29)\}$

$(F, A) \cap (G, B) = (H, C) = \{H(e_1) = \{(a, 0.2, 0.6), (b, 0.1, 0.8), (c, 0.2, 0.5)\}, H(e_2) = \{(a, 0.4, 0.1), (b, 0, 0.8), (c, 0.3, 0.5)\}\}$

$DIL((F, A) \cap (G, B)) = \{DILH(e_1) = \{(a, 0.44, 0.36), (b, 0.31, 0.55), (c, 0.44, 0.29)\}, DILH(e_2) = \{(a, 0.63, 0.05), (b, 0, 0.55), (c, 0.54, 0.29)\}\}$

$DIL(F, A) \cap DIL(G, B) = (K, C) = \{DIL K(e_1) = \{(a, 0.04, 0.84), (b, 0.01, 0.96), (c, 0.04, 0.75)\}, DIL K(e_2) = \{(a, 0.16, 0.19), (b, 0, 0.96), (c, 0.09, 0.75)\}\}$

Then

$$DIL((F, A) \cap (G, B)) = DIL(F, A) \cap DIL(G, B)$$

V. NORMALIZATION OF INTUITIONISTIC FUZZY SOFT SET

In this section, we shall introduce the normalization operation on intuitionistic fuzzy soft set.

5.1 Definition:

The normalization of an intuitionistic fuzzy soft set (F, A) of universe U , denoted by

NORM (F, A) is defined as:

$NORM(F, A) = \{Norm\{F(\epsilon)\} = \{x, (F(\epsilon))(x), (F(\epsilon))(x), x \in U \text{ and } A\}$. where

$$\frac{(F(\epsilon))(x)}{(\mu_{(F(\epsilon))}(x))} \text{ and } \frac{(F(\epsilon))(x) - (v_{(F(\epsilon))}(x))}{(v_{(F(\epsilon))}(x))}$$

$Inf(F(\epsilon)(x)) \neq \dots$

Example. Let there are five objects as the universal set where $U = \{x_1, x_2, x_3, x_4, x_5\}$ and the set of parameters as $E = \{\text{beautiful, moderate, wooden, muddy, cheap, costly}\}$ and Let $A = \{\text{beautiful, moderate, wooden}\}$. Let the attractiveness of the objects represented by the intuitionistic fuzzy soft sets (F, A) is given as

$F(\text{beautiful}) = \{x_1/(.6, .4), x_2/(.7, .3), x_3/(.5, .5), x_4/(.8, .2), x_5/(.9, .1)\}$,

$F(\text{moderate}) = \{x_1/(.3, .7), x_2/(.6, .4), x_3/(.8, .2), x_4/(.3, .7), x_5/(.1, .9)\}$ and

$F(\text{wooden}) = \{x_1/(.4, .6), x_2/(.6, .4), x_3/(.5, .5), x_4/(.2, .8), x_5/(.3, .7)\}$.

Then,

$(\mu_{F(\text{bea})}(x)) = 0.9, (v_{F(\text{bea})}(x)) = 0.1$. We have

$$(F(\text{bea}))(x_1) = \frac{0.6}{0.9} = 0.66,$$

$$(F(\text{bea}))(x_2) = \frac{0.7}{0.9} = 0.77,$$

$$(F(\text{bea}))(x_3) = \frac{0.5}{0.9} = 0.55,$$

$$(F(\text{bea}))(x_4) = \frac{0.8}{0.9} = 0.88,$$

$$(F(\text{bea}))(x_5) = \frac{0.9}{0.9} = 1 \text{ and}$$

$$(F(\text{bea}))(x_1) = \frac{0.3}{0.9} = 0.33,$$

$$(F(\text{bea}))(x_2) = \frac{0.2}{0.9} = 0.22,$$

$$(F(\text{be}))(\mathbf{x}_3) = 0.44$$

$$(F(\text{be}))(\mathbf{x}_4) = 0.11,$$

$$(F(\text{be}))(\mathbf{x}_5) = 0.$$

Norm(F) { $X_1/(.66,.33)$, $X_2/(.77,.22)$, $X_3/(.55,.44)$, $X_4/(.88,.11)$, $X_5/(1,0)$ }.

We have $(\mu_{F(\text{mo})})(\mathbf{x}) = 0.8$, $(\nu_{F(\text{mo})})(\mathbf{x}) = 0.2$.

$$(F(\text{mo}))(\mathbf{x}_1) = 0.375,$$

$$(F(\text{mo}))(\mathbf{x}_2) = 0.75,$$

$$(F(\text{mo}))(\mathbf{x}_3) = 1,$$

$$(F(\text{mo}))(\mathbf{x}_4) = 0.375,$$

$$(F(\text{mo}))(\mathbf{x}_5) = 0.125$$
 And

$$(F(\text{mo}))(\mathbf{x}_1) = 0.625,$$

$$(F(\text{mo}))(\mathbf{x}_2) = 0.25,$$

$$(F(\text{mo}))(\mathbf{x}_3) = 0,$$

$$(F(\text{mo}))(\mathbf{x}_4) = 0.625,$$

$$(F(\text{mo}))(\mathbf{x}_5) = 0.875.$$

Norm(F) { $X_1/(.375,.625)$, $X_2/(.75,.25)$, $X_3/(1,0)$, $X_4/(.375,.625)$, $X_5/(0.125,0.875)$ }.

We have $(\mu_{F(\text{w})})(\mathbf{x}) = 0.6$, $(\nu_{F(\text{w})})(\mathbf{x}) = 0.4$.

$$(F(\text{w}))(\mathbf{x}_1) = 0.66,$$

$$(F(\text{w}))(\mathbf{x}_2) = 1,$$

$$(F(\text{w}))(\mathbf{x}_3) = 0.83,$$

$$(F(\text{w}))(\mathbf{x}_4) = 0.34,$$

$$(F(\text{w}))(\mathbf{x}_5) = 0.5$$
 and

$$(F(\text{woo}))(\mathbf{x}_1) = 0.34,$$

$$(F(\text{woo}))(\mathbf{x}_2) = 0,$$

$$(F(\text{woo}))(\mathbf{x}_3) = 0.17,$$

$$(F(\text{woo}))(\mathbf{x}_4) = 0.66,$$

$$(F(\text{w}))(\mathbf{x}_5) = 0.5.$$

Norm(F(wooden)) { $X_1/(.66,.34)$, $X_2/(1,.0)$, $X_3/(0.83,0.17)$, $X_4/(.34,.66)$, $X_5/(0.5,0.5)$ }.

Then, Norm (F, A) { Norm F (), Norm F(moderate), Norm F() }

Norm (F,A) { F() { $X_1/(.66,.33)$, $X_2/(.77,.22)$, $X_3/(.55,.44)$, $X_4/(.88,.11)$, $X_5/(1,0)$ }, F() { $X_1/(.375,.625)$, $X_2/(.75,.25)$, $X_3/(1,0)$, $X_4/(.375,.625)$, $X_5/(0.125,0.875)$ }, F() { $X_1/(.66,.34)$, $X_2/(1,.0)$, $X_3/(0.83,0.17)$, $X_4/(.34,.66)$, $X_5/(0.5,0.5)$ } }

Clearly, $\mu_{Norm(F(\epsilon))}(\mathbf{x}) = (F(\epsilon))(\mathbf{x}) = 1$, for $i = 1, 2, 3, 4, 5$ which satisfies the property of intuitionistic fuzzy soft set. Therefore, Norm (F, A) is an intuitionistic fuzzy soft set.

VI. CONCLUSION

In this paper, we have extended the two operations of intuitionistic fuzzy set introduced by Wang et al.[18] to the case of intuitionistic fuzzy soft sets. Then we have introduced the concept of normalization of intuitionistic fuzzy soft sets and studied several properties of these operations.

REFERENCES

- [1] K.T. Atanassov, "Intuitionistic Fuzzy Set". Fuzzy Sets and Systems, vol. 20(1), pp.87-86, 1986.
- [2] K.T. Atanassov and G. Gargov, "intuitionistic fuzzy logic", C.R Academy of Bulgarian Society, Vol. 53, pp .9-12, 1990.
- [3] K.T. Atanassov and G.Gargov, "intuitionistic fuzzy prolog", Fuzzy Sets and sSystems, Vol. 4, No 3, 1993 pp .121-128.
- [4] E.Szmidt and J.Kacprzyk, "Intuitionistic Fuzzy Sets in Group Decision Making", Notes on IFS 2, ,1996, pp.11-14.
- [5] S.K.De, R. Biswas and A.Roy, "An Application of Intuitionstic Fuzzy Set in Medical Diagnosis", Fuzzy Sets and Systems, vol .117,2001, pp .209-213.
- [6] D. A. Molodtsov, "Soft Set Theory - First Result", Computers and Mathematics with Applications, Vol. 37, 1999, pp. 19-31.

- [7] P. K. Maji, R. Biswas and A.R. Roy, "Fuzzy Soft Sets", *Journal of Fuzzy Mathematics*, Vol 9 , No.3, 2001, pp. 589-602.
- [8] B. Ahmad and A. Kharal, "On Fuzzy Soft Sets", Hindawi Publishing Corporation, *Advances in Fuzzy Systems*, volume Article ID 586507, (2009), 6 pages doi: 10.1155/2009/586507.
- [9] P. K. Maji, A. R. Roy and R. Biswas, "Fuzzy Soft Sets", *Journal of Fuzzy Mathematics*. Vol 9, No 3, 2001, pp.589-602.
- [10] T. J. Neog and D. K. Sut, "On Fuzzy Soft Complement and Related Properties", Accepted for publication in *International Journal of Energy, Information and communications (IJEIC)*.
- [11] M. Borah, T. J. Neog and D. K. Sut, "A study on some operations of fuzzy soft sets", *International Journal of Modern Engineering Research (IJMER)*, Vol.2, No. 2, 2012, pp. 157-168.
- [12] H. L. Yang, "Notes On Generalized Fuzzy Soft Sets", *Journal of Mathematical Research and Exposition*, Vol 31, No. 3, (2011), pp.567-570.
- [13] P. Majumdar, S. K. Samanta, "Generalized Fuzzy Soft Sets", *Computers and Mathematics with Applications*, Vol 59, 2010, pp.1425-1432.
- [14] S. Alkhazaleh, A. R. Salleh, and N. Hassan, "Possibility Fuzzy Soft Set", *Advances in Decision Sciences*, Vol 2011, Article ID 479756, doi:10.1155/2011/479756, 18 pages.
- [15] P. K. Maji, R. Biswas, A. R. Roy, "Intuitionistic fuzzy soft sets", *The journal of fuzzy mathematics* Vol 9, NO3, 2001, pp.677-692.
- [16] K.V .Babitha and J. J. Sunil, "Generalized Intuitionistic Fuzzy Soft Sets and Its Applications" *Gen. Math. Notes*, ISSN 2219-7184; ICSRS Publication, (2011), Vol. 7, No. 2, 2011, pp.1-14.
- [17] M.Bashir, A.R. Salleh, and S. Alkhazaleh, "Possibility Intuitionistic Fuzzy Soft Set", *Advances in Decision Sciences* Volume 2012, 2012, Article ID 404325, 24 pages, doi:10.1155/2012/404325.
- [18] W.Yang-Ping, Z.Jun, "Modifying Operations on Intuitionistic Fuzzy sets.

Mapping on Intuitionistic Fuzzy Soft Expert Sets

Said Broumi, Florentin Smarandache

Said Broumi, Florentin Smarandache (2015). Mapping on Intuitionistic Fuzzy Soft Expert Sets. Journal of New Results in Science 9, 1-10

Abstract – We introduce the mapping on intuitionistic fuzzy soft expert set and its operations are studied. The basic operations of mapping on intuitionistic fuzzy soft expert set theory are defined.

Keywords –

Intuitionistic fuzzy soft expert set, intuitionistic fuzzy soft expert images, intuitionistic fuzzy soft expert inverse images, mapping on intuitionistic fuzzy soft expert set

1. Introduction

The concept of fuzzy sets was introduced by Zadeh [16] whose basic component is only a degree of membership. Atanassov [10] generalized this idea to intuitionistic fuzzy set (IFS in short) using a degree of membership and a degree of non-membership, under the constraint that the sum of the two degrees does not exceed one. The conception of IFS can be viewed as an appropriate /alternative approach in case where available information is not sufficient to define the impreciseness by the conventional fuzzy set. A detailed theoretical study may be found in [10]. Later on, many hybrid structures with the concept of intuitionistic fuzzy sets appeared in [32, 33, 34, 35, 36, 37, 38].

Soft set theory [6] was firstly introduced by Molodtsov in 1999 as a general mathematical tool for dealing with uncertainties which traditional mathematical tools cannot handle and how soft set theory is free from the parameterization inadequacy syndrome of fuzzy set theory, rough set theory, probability theory. A soft set is in fact a set-valued map which gives an approximation description of objects under consideration based on some parameters. After Molodtsov's work, Maji et al.[29] introduced the concept of fuzzy soft set, a more generalized concept, which is a combination of fuzzy set and soft set and studied its properties and also discussed their properties. Also, Maji et al.[30] devoted the concept of intuitionistic fuzzy soft sets by combining intuitionistic fuzzy sets with soft sets. Then, many interesting results of soft set theory have been studied on fuzzy soft sets [22, 23, 27, 28], on intuitionistic fuzzy soft set theory [24, 25, 26, 30], on possibility fuzzy soft set [34], on generalized fuzzy soft sets [8,39], on generalized intuitionistic fuzzy soft [15, 31,43,44], on possibility intuitionistic fuzzy soft set [17], on possibility vague soft set [11] and so on. All these research aim to solve most of our real life problems in medical sciences, engineering, management, environment and social science which involve data

that are not crisp and precise. Moreover all the models created will deal only with one expert. To redefine this one expert opinion, Alkhezaleh and Salleh in 2011 [32] defined the concept of soft expert set in which the user can know the opinion of all the experts in one model and give an application of this concept in decision making problem. Also, they introduced the concept of the fuzzy soft expert set [40] as a combination between the soft expert set and the fuzzy set. Recently, Broumi and Smarandache [42] introduced, a more generalized concept, the concept of the intuitionistic fuzzy soft expert set as a combination between the soft expert set and the intuitionistic fuzzy set and gave the application in decision making problem. The soft expert models are richer than soft set models since the soft set models are created with the help of one expert whereas but the soft expert models are made with the opinions of all experts. Later on, many researchers have worked with the concept of soft expert sets and their hybrid structures [1,2, 3, 7, 10, 11, 12, 16, 17, 19, 45]. The notion of mapping on soft classes are introduced by Kharal and Ahmad [4]. The same authors presented the concept of a mapping on classes of fuzzy soft sets [5] and studied the properties of fuzzy soft images and fuzzy soft inverse images of fuzzy soft sets, and supported them with examples and counterexamples. In intuitionistic fuzzy environment, there is no study on mapping on the classes of intuitionistic fuzzy soft expert sets, so there is a need to develop a new mathematical tool called “Mapping on intuitionistic fuzzy soft expert set”.

In this paper we introduce the notion of mapping on intuitionistic fuzzy soft expert classes and study the properties of intuitionistic fuzzy soft expert images and intuitionistic fuzzy soft expert inverse images of intuitionistic fuzzy soft expert sets. Finally, we give some examples of mapping on intuitionistic fuzzy soft expert.

Preliminaries

In this section, we will briefly recall the basic concepts of intuitionistic fuzzy sets, soft set, soft expert sets, fuzzy soft expert sets and intuitionistic fuzzy soft expert set.

Let U be an initial universe set of objects and E the set of parameters in relation to objects in U . Parameters are often attributes, characteristics or properties of objects. Let $P(U)$ denote the power set of U and $A \subseteq E$.

.1. Intuitionistic Fuzzy Set

Definition .1 : Let U be an universe of discourse then the intuitionistic fuzzy set A is an object having the form $A = \{ x, \mu_A(x), \omega_A(x) ,x \in U\}$, where the functions $\mu_A(x)$, $\omega_A(x) : U \rightarrow [0,1]$ define respectively the degree of membership, and the degree of non-membership of the element $x \in X$ to the set A with the condition.

$$0 \leq \mu_A(x) + \omega_A(x) \leq 1.$$

For two IFS,

$$A_{IFS} = \{ x, \mu_A(x), \omega_A(x) \mid x \in X \}$$

and

$$B_{IFS} = \{ x, \mu_B(x), \omega_B(x) \mid x \in X \}$$

Then,

1. $A_{IFS} \subseteq B_{IFS}$ if and only if

$$\mu_A(x) \leq \mu_B(x), \omega_A(x) \geq \omega_B(x)$$

2. $A_{IFS} = B_{IFS}$ if and only if,

$$\mu_A(x) = \mu_B(x), \omega_A(x) = \omega_B(x) \text{ for any } x \in X.$$

3. The complement of A_{IFS} is denoted by A_{IFS}^o and is defined by

$$A_{IFS}^o = \{ x, \omega_A(x), \mu_A(x) \mid x \in X \}$$

4. $A \cap B = \{ x, \min\{\mu_A(x), \mu_B(x)\}, \max\{\omega_A(x), \omega_B(x)\} \mid x \in X \}$

5. $A \cup B = \{ x, \max\{\mu_A(x), \mu_B(x)\}, \min\{\omega_A(x), \omega_B(x)\} \mid x \in X \}$

As an illustration, let us consider the following example.

Example . . Assume that the universe of discourse $U = \{x_1, x_2, x_3, x_4\}$. It may be further assumed that the values of x_1, x_2, x_3 and x_4 are in $[0, 1]$ Then, A is an intuitionistic fuzzy set (IFS) of U , such that,

$$A = \{ x_1, 0.4, 0.6 \ , \ x_2, 0.3, 0.7 \ , \ x_3, 0.2, 0.8 \ , \ x_4, 0.2, 0.8 \ }$$

. **Soft set**

Definition . .

Let U be an initial universe set and E be a set of parameters. Let $P(U)$ denote the power set of U . Consider a nonempty set $A, A \subset E$. A pair (K, A) is called a soft set over U , where K is a mapping given by $K : A \rightarrow P(U)$.

As an illustration, let us consider the following example.

Example . . Suppose that U is the set of houses under consideration, say $U = \{h_1, h_2, \dots, h_5\}$. Let E be the set of some attributes of such houses, say $E = \{e_1, e_2, \dots, e_8\}$, where e_1, e_2, \dots, e_8 stand for the attributes “beautiful”, “costly”, “in the green surroundings”, “moderate”, “cheap”, “expensive”, “wooden” and “very costly” respectively.

In this case, to define a soft set means to point out expensive houses, beautiful houses, and so on. For example, the soft set (K, A) that describes the “attractiveness of the houses” in the opinion of a buyer, say Thomas, may be defined like this:

$$A = \{e_1, e_2, e_3, e_4, e_5\};$$

$$K(e_1) = \{h_2, h_3, h_5\}, K(e_2) = \{h_2, h_4\}, K(e_3) = \{h_1\}, K(e_4) = U, K(e_5) = \{h_3, h_5\}.$$

. **Intuitionistic fuzzy soft sets.**

Definition . . Let U be an initial universe set and $A \subset E$ be a set of parameters. Let $IFS(U)$ denotes the set of all intuitionistic fuzzy subsets of U . The collection (F, A) is termed to be the intuitionistic fuzzy soft set over U , where F is a mapping given by $F: A \rightarrow IFS(U)$.

Example . . Let U be the set of houses under consideration and E is the set of parameters. Each parameter is a word or sentence involving intuitionistic fuzzy words. Consider $E = \{\text{beautiful, wooden, costly, very costly, moderate, green surroundings, in good repair, in bad repair, cheap, expensive}\}$. In this case, to define a intuitionistic fuzzy soft set means to point out beautiful houses, wooden houses, houses in the green surroundings and so on. Suppose that, there are five houses in the universe U given by $U = \{h_1, h_2, \dots, h_5\}$ and the set of parameters

$A = \{e_1, e_2, e_3, e_4\}$, where e_1 stands for the parameter ‘beautiful’, e_2 stands for the parameter ‘wooden’, e_3 stands for the parameter ‘costly’ and the parameter e_4 stands for ‘moderate’. Then the intuitionistic fuzzy set (F, A) is defined as follows:

$$(F, A) = \left\{ \begin{array}{l} \left(e_1 \left\{ \frac{h_1}{(0.1,0.6)}, \frac{h_2}{(0.2,0.7)}, \frac{h_3}{(0.6,0.2)}, \frac{h_4}{(0.7,0.3)}, \frac{h_5}{(0.2,0.3)} \right\} \right) \\ \left(e_2 \left\{ \frac{h_1}{(0.3,0.5)}, \frac{h_2}{(0.2,0.4)}, \frac{h_3}{(0.1,0.2)}, \frac{h_4}{(0.1,0.3)}, \frac{h_5}{(0.3,0.6)} \right\} \right) \\ \left(e_3 \left\{ \frac{h_1}{(0.4,0.3)}, \frac{h_2}{(0.6,0.3)}, \frac{h_3}{(0.2,0.5)}, \frac{h_4}{(0.2,0.6)}, \frac{h_5}{(0.7,0.3)} \right\} \right) \\ \left(e_4 \left\{ \frac{h_1}{(0.1,0.6)}, \frac{h_2}{(0.3,0.6)}, \frac{h_3}{(0.6,0.4)}, \frac{h_4}{(0.4,0.2)}, \frac{h_5}{(0.5,0.3)} \right\} \right) \end{array} \right\}$$

. . Soft expert sets

Definition . Let U be a universe set, E be a set of parameters and X be a set of experts (agents). Let O = {1 agree, 0 disagree} be a set of opinions. Let Z = E × X × O and A ⊆ Z

A pair (F, E) is called a soft expert set over U, where F is a mapping given by F : A → P(U) and P(U) denote the power set of U.

Definition . An agree- soft expert set (F, A)₁ over U, is a soft expert subset of (F, A) defined as :

$$(F, A)_1 = \{F(\alpha) : \alpha \in E \times X \times \{1\}\}.$$

Definition . A disagree- soft expert set (F, A)₀ over U, is a soft expert subset of (F, A) defined as :

$$(F, A)_0 = \{F(\alpha) : \alpha \in E \times X \times \{0\}\}.$$

. . Fuzzy Soft expert sets

Definition .1 A pair (F, A) is called a fuzzy soft expert set over U, where F is a mapping given by

$$F : A \rightarrow I^U, \text{ and } I^U \text{ denote the set of all fuzzy subsets of } U.$$

. . Intuitionistic Fuzzy Soft expert sets

Definition .11 Let U = {u₁, u₂, u₃, ..., u_n} be a universal set of elements, E = {e₁, e₂, e₃, ..., e_m} be a universal set of parameters, X = {x₁, x₂, x₃, ..., x_i} be a set of experts (agents) and O = {1 agree, 0 disagree} be a set of opinions. Let Z = {E × X × O} and A ⊆ Z. Then the pair (U, Z) is called a soft universe. Let F : Z → (I × I)^U where (I × I)^U denotes the collection of all intuitionistic fuzzy subsets of U. Suppose F : Z → (I × I)^U be a function defined as:

$$F(z) = (F(z)(u_i), \omega_{F(z)}(u_i)), \text{ for all } u_i \in U.$$

Then F(z) is called an intuitionistic fuzzy soft expert set (IFSES in short) over the soft universe (U, Z)

For each z_i ∈ Z. F(z) = (F(z_i)(u_i), ω_{F(z_i)}(u_i)) where F(z_i) represents the degree of belongingness and non-belongingness of the elements of U in F(z_i). Hence F(z_i) can be written as:

$$F(z_i) = \left\{ \left(\frac{u_i}{F(z_i)(u_i)}, \omega_{F(z_i)}(u_i) \right), \dots, \left(\frac{u_i}{F(z_i)(u_i)}, \omega_{F(z_i)}(u_i) \right) \right\}, \text{ for } i = 1, 2, 3, \dots, n$$

where F(z_i)(u_i) = μ_{F(z_i)}(u_i), ω_{F(z_i)}(u_i) with μ_{F(z_i)}(u_i) and ω_{F(z_i)}(u_i) representing the membership function and non-membership function of each of the elements u_i ∈ U respectively.

Sometimes we write F as (F, Z). If A ⊆ Z. we can also have IFSES (F, A).

. Mapping on Intuitionistic Fuzzy Soft Expert Set.

In this paper, we introduce the notion of a mapping on intuitionistic fuzzy soft expert classes. Intuitionistic fuzzy soft expert classes are collections of an intuitionistic fuzzy soft expert sets. We also define and study the properties of an intuitionistic fuzzy soft expert images and an intuitionistic fuzzy soft expert inverse images of an intuitionistic fuzzy soft expert sets, and support them with example and theorems.

Definition .1: Let $(\widetilde{U}, \widetilde{Z})$ and $(\widetilde{Y}, \widetilde{Z}')$ be an intuitionistic fuzzy soft expert classes. Let $r: U \rightarrow Y$ and

$s: Z \rightarrow Z'$ be mappings. Then a mapping $f: (\widetilde{U}, \widetilde{Z}) \rightarrow (\widetilde{Y}, \widetilde{Z}')$ is defined as follows :

For an intuitionistic fuzzy soft expert set (F, A) in $(\widetilde{U}, \widetilde{Z})$, $f(F, A)$ is an intuitionistic fuzzy soft expert set in $(\widetilde{Y}, \widetilde{Z}')$

$$f(F, A)(\beta)(y) \begin{cases} \bigvee_{x \in r^{-1}(y)} (\bigvee_{\alpha} F(\alpha)) & \text{if } r^{-1}(y) \text{ and } s^{-1}(\beta) \cap A \neq \emptyset, \\ 0 & \text{otherwise} \end{cases}$$

for $\beta \in s(Z) \subseteq Z'$, $y \in Y$ and $\forall \alpha \in s^{-1}(\beta) \cap A$, $f(F, A)$ is called an intuitionistic fuzzy soft expert image of the intuitionistic fuzzy soft expert set (F, A) .

Definition . :Let $(\widetilde{U}, \widetilde{Z})$ and $(\widetilde{Y}, \widetilde{Z}')$ be an intuitionistic fuzzy soft expert classes. Let $r: U \rightarrow Y$ and

$s: Z \rightarrow Z'$ be mappings. Then a mapping $f^{-1}: (\widetilde{Y}, \widetilde{Z}')$ \rightarrow $(\widetilde{U}, \widetilde{Z})$ is defined as follows :

For an intuitionistic fuzzy soft expert set (G, B) in $(\widetilde{Y}, \widetilde{Z}')$, $f^{-1}(G, B)$ is an intuitionistic fuzzy soft expert set in $(\widetilde{U}, \widetilde{Z})$

$$f^{-1}(G, B)(\alpha)(u) \begin{cases} G(s(\alpha))(r(u)) & , \text{if } s(\alpha) \in B \\ 0 & \text{otherwise} \end{cases}$$

For $\alpha \in s^{-1}(\beta) \subseteq Z$ and $u \in U$. $f^{-1}(G, B)$ is called an intuitionistic fuzzy soft expert inverse image of the an intuitionistic fuzzy soft expert set (F, A) .

Example . . Let $U = \{u_1, u_2, u_3\}$, $Y = \{y_1, y_2, y_3\}$ and let $A \subseteq Z = \{(e_1, p, 1), (e_2, p, 0), (e_3, p, 1)\}$, and $A' \subseteq Z' = \{(e_1, p, 1), (e_2, p, 0), (e_1, q, 1)\}$.

Suppose that (\widetilde{U}, A) and (\widetilde{Y}, A') are an intuitionistic fuzzy soft expert classes. Define $r: U \rightarrow Y$ and $s: A \rightarrow A'$ as follows :

$$r(u_1) = y_1, r(u_2) = y_3, r(u_3) = y_2,$$

$$s(e_1, p, 1) = (e_2, p, 0), s(e_2, p, 0) = (e_1, p, 1), s(e_3, p, 1) = (e_1, q, 1),$$

Let (F, A) and (G, A') be two an intuitionistic fuzzy soft experts over U and Y respectively such that.

$$(F, A) = \left\{ \left((e_1, p, 1), \left\{ \frac{u_1}{(0.4, 0.6)}, \frac{u_2}{(0.3, 0.4)}, \frac{u_3}{(0.3, 0.5)} \right\} \right), \left((e_3, p, 1), \left\{ \frac{u_1}{(0.3, 0.2)}, \frac{u_2}{(0.5, 0.4)}, \frac{u_3}{(0.6, 0.3)} \right\} \right) \right\},$$

$$\left((e_2, p, 0), \left\{ \frac{u_1}{(0.5, 0.3)}, \frac{u_2}{(0.5, 0.2)}, \frac{u_3}{(0.6, 0.1)} \right\} \right) \Big\}$$

$$(G, A') = \left\{ \left((e_1, p, 1), \left\{ \frac{y_1}{(0.3, 0.1)}, \frac{y_2}{(0.5, 0.4)}, \frac{y_3}{(0.3, 0.1)} \right\} \right), \left((e_1, q, 1), \left\{ \frac{y_1}{(0.5, 0.4)}, \frac{y_2}{(0.5, 0.3)}, \frac{y_3}{(0.6, 0.1)} \right\} \right) \right\},$$

$$\left((e_2, p, 0), \left\{ \frac{y_1}{(0.3, 0.4)}, \frac{y_2}{(0.1, 0.5)}, \frac{y_3}{(0.1, 0.2)} \right\} \right) \Big\}$$

Then we define the mapping from $f: (\widetilde{U}, \widetilde{Z}) \rightarrow (\widetilde{Y}, \widetilde{Z}')$ as follows :

For an intuitionistic fuzzy soft expert set (F, A) in $(\widetilde{U}, \widetilde{Z})$, $f(F, A), K$ is an intuitionistic fuzzy soft expert set in $(\widetilde{Y}, \widetilde{Z}')$ where

$K = s(A) = \{(e_1, p, 1), (e_2, p, 0), (e_1, q, 1)\}$. and is obtained as follows:

$$f(F, A)(e_1, p, 1)(y_1) = \bigvee_{x \in r^{-1}(y_1)} (\bigvee_{\alpha} F(\alpha)) = \bigvee_{x \in \{u_1\}} (\bigvee_{\alpha \in \{(e_1, p, 1), (e_3, p, 1)\}} F(\alpha)) = (0.5, 0.3) \cup (0.3, 0.2) = (0.5, 0.2)$$

$$f(F, A) (e'_1, p', 1) (y_2) \quad \begin{matrix} V_{x \in r^{-1}(y_2)}(V_\alpha F(\alpha)) & V_{x \in \{u_2\}}(V_{\alpha \in \{(e_2, p, 0), (e_2, p, 1)\}} F(\alpha)) \\ (0.6, 0.1) \cup (0.6, 0.3) & \\ (0.6, 0.1) & \end{matrix}$$

$$f(F, A) (e'_1, p', 1) (y_3) \quad \begin{matrix} V_{x \in r^{-1}(y_3)}(V_\alpha F(\alpha)) & V_{x \in \{u_3\}}(V_{\alpha \in \{(e_2, p, 0), (e_2, p, 1)\}} F(\alpha)) \\ (0.5, 0.2) \cup (0.5, 0.4) & \\ (0.5, 0.2) & \end{matrix}$$

Then

$$f(F, A) (e'_1, p', 1) \quad \left\{ \frac{y_1}{(0.5, 0.2)}, \frac{y_2}{(0.6, 0.1)}, \frac{y_3}{(0.5, 0.2)} \right\}$$

$$f(F, A) (e'_2, p', 0) (y_1) \quad \begin{matrix} V_{x \in r^{-1}(y_1)}(V_\alpha F(\alpha)) & V_{x \in \{u_1\}}(V_{\alpha \in \{(e_1, p, 1)\}} F(\alpha)) \\ (0.4, 0.6) & \end{matrix}$$

$$f(F, A) (e'_2, p', 0) (y_2) \quad \begin{matrix} V_{x \in r^{-1}(y_2)}(V_\alpha F(\alpha)) & V_{x \in \{u_2\}}(V_{\alpha \in \{(e_1, p, 1)\}} F(\alpha)) \\ (0.3, 0.5) & \end{matrix}$$

$$f(F, A) (e'_2, p', 0) (y_3) \quad \begin{matrix} V_{x \in r^{-1}(y_3)}(V_\alpha F(\alpha)) & V_{x \in \{u_3\}}(V_{\alpha \in \{(e_1, p, 1)\}} F(\alpha)) \\ (0.3, 0.4) & \end{matrix}$$

Then

$$f(F, A) ((e'_2, p', 0) \quad \left\{ \frac{y_1}{(0.4, 0.6)}, \frac{y_2}{(0.3, 0.5)}, \frac{y_3}{(0.3, 0.4)} \right\}$$

$$f(F, A) (e'_1, q', 1) (y_1) \quad \begin{matrix} V_{x \in r^{-1}(y_1)}(V_\alpha F(\alpha)) & V_{x \in \{u_1\}}(V_{\alpha \in \{(e_1, p, 1)\}} F(\alpha)) \\ (0.3, 0.2) & \end{matrix}$$

$$f(F, A) (e'_1, q', 1) (y_2) \quad \begin{matrix} V_{x \in r^{-1}(y_2)}(V_\alpha F(\alpha)) & V_{x \in \{u_2\}}(V_{\alpha \in \{(e_1, p, 1)\}} F(\alpha)) \\ (0.6, 0.3) & \end{matrix}$$

$$f(F, A) (e'_1, q', 1) (y_3) \quad \begin{matrix} V_{x \in r^{-1}(y_3)}(V_\alpha F(\alpha)) & V_{x \in \{u_3\}}(V_{\alpha \in \{(e_1, p, 1)\}} F(\alpha)) \\ (0.5, 0.4) & \end{matrix}$$

Then

$$f(F, A) ((e'_1, q', 1) \quad \left\{ \frac{y_1}{(0.3, 0.2)}, \frac{y_2}{(0.6, 0.3)}, \frac{y_3}{(0.5, 0.4)} \right\}$$

Hence

$$(f(F, A), K) \quad \left\{ \left((e'_1, p', 1), \left\{ \frac{y_1}{(0.5, 0.2)}, \frac{y_2}{(0.6, 0.1)}, \frac{y_3}{(0.5, 0.2)} \right\} \right), \left((e'_2, p', 0), \left\{ \frac{y_1}{(0.4, 0.6)}, \frac{y_2}{(0.3, 0.5)}, \frac{y_3}{(0.3, 0.4)} \right\} \right), \right. \\ \left. \left((e'_1, q', 1), \left\{ \frac{y_1}{(0.3, 0.2)}, \frac{y_2}{(0.6, 0.3)}, \frac{y_3}{(0.5, 0.4)} \right\} \right) \right\}$$

Next, for the intuitionistic fuzzy soft expert set inverse images, we have the following:

For an intuitionistic fuzzy soft expert set (G, A) in (Y, Z) , $(f^{-1}(G, A), D)$ is an intuitionistic fuzzy soft expert set in (U, Z) where

$D = s^{-1}(A) = \{(e_1, p, 1), (e_2, p, 0), (e_3, p, 1)\}$. and is obtained as follows:

$$f^{-1}(G, B) (e_1, p, 1) (u_1) \quad G(s(e_1, p, 1))(r(u_1)) \quad G((e_2, p', 0))(y_1) \quad (0.3, 0.4) f^{-1}(G, B) (e_1, p, 1) (u_2) \quad G(s(e_1, p, 1))(r(u_2)) \quad G((e_2, p', 0))(y_3) \quad (0.1, 0.2)$$

$$f^{-1}(G, B) (e_1, p, 1) (u_3) \quad G(s(e_1, p, 1))(r(u_3)) \quad G((e_2, p', 0))(y_2) \quad (0.1, 0.5) \quad \text{Then}$$

$$f^{-1}(G, B) (e_1, p, 1) \quad \left\{ \frac{u_1}{(0.3, 0.4)}, \frac{u_2}{(0.1, 0.2)}, \frac{u_3}{(0.1, 0.5)} \right\}$$

$$f^{-1}(G, B) (e_2, p, 0) (u_1) \quad G(s(e_2, p, 0))(r(u_1)) \quad G((e_1, p', 1))(y_1) \quad (0.3, 0.1)$$

$$f^{-1}(G, B) (e_2, p, 0) (u_2) \quad G(s(e_2, p, 0))(r(u_2)) \quad G((e_1, p', 1))(y_3) \quad (0.3, 0.1)$$

$$f^{-1}(G, B) (e_2, p, 0) (u_3) \quad G(s(e_2, p, 0))(r(u_3)) \quad G((e_1, p', 1))(y_2) \quad (0.5, 0.4)$$

Then

$$f^{-1}(G, B) (e_2, p, 0) \quad \left\{ \frac{u_1}{(0.3, 0.1)}, \frac{u_2}{(0.3, 0.1)}, \frac{u_3}{(0.5, 0.4)} \right\}$$

$$f^{-1}(G, B)(e_3, p, 1)(u_1) = G(s(e_3, p, 1))(r(u_1)) = G((e'_1, q', 1))(y_1) = (0.5, 0.4)$$

$$f^{-1}(G, B)(e_3, p, 1)(u_2) = G(s(e_3, p, 1))(r(u_2)) = G((e'_1, q', 1))(y_3) = (0.6, 0.1)$$

$$f^{-1}(G, B)(e_3, p, 1)(u_3) = G(s(e_3, p, 1))(r(u_3)) = G((e'_1, q', 1))(y_2) = (0.5, 0.3)$$

Then

$$f^{-1}(G, B)(e_3, p, 1) = \left\{ \frac{u_1}{(0.5, 0.4)}, \frac{u_2}{(0.6, 0.1)}, \frac{u_3}{(0.5, 0.4)} \right\}$$

Hence

$$(f^{-1}(G, A), D) = \left\{ \left((e_1, p, 1), \left\{ \frac{u_1}{(0.3, 0.4)}, \frac{u_2}{(0.1, 0.2)}, \frac{u_3}{(0.1, 0.5)} \right\} \right), \left((e_2, p, 0), \left\{ \frac{u_1}{(0.3, 0.1)}, \frac{u_2}{(0.3, 0.1)}, \frac{u_3}{(0.5, 0.4)} \right\} \right), \left((e_3, p, 1), \left\{ \frac{u_1}{(0.5, 0.4)}, \frac{u_2}{(0.6, 0.1)}, \frac{u_3}{(0.5, 0.4)} \right\} \right) \right\}$$

Definition . Let $f: (\widetilde{U}, \widetilde{Z}) \rightarrow (\widetilde{Y}, \widetilde{Z})$ be a mapping and (F, A) and (G, B) intuitionistic fuzzy soft expert sets in $(\widetilde{U}, \widetilde{E})$. Then for $\beta \in \widetilde{Z}, y \in \widetilde{Y}$ the union and intersection of intuitionistic fuzzy soft expert images (F, A) and (G, B) are defined follows :

$$(f(F, A) \widetilde{V} f(G, B))(\beta)(y) = f(F, A)(\beta)(y) \widetilde{V} f(G, B)(\beta)(y).$$

$$(f(F, A) \widetilde{\wedge} f(G, B))(\beta)(y) = f(F, A)(\beta)(y) \widetilde{\wedge} f(G, B)(\beta)(y).$$

Definition . Let $f: (\widetilde{U}, \widetilde{Z}) \rightarrow (\widetilde{Y}, \widetilde{Z})$ be a mapping and (F, A) and (G, B) intuitionistic fuzzy soft expert sets in $(\widetilde{U}, \widetilde{E})$. Then for $\alpha \in \widetilde{Z}, u \in \widetilde{U}$, the union and intersection of intuitionistic fuzzy soft expert inverse images (F, A) and (G, B) are defined follows :

$$(f^{-1}(F, A) \widetilde{V} f^{-1}(G, B))(\alpha)(u) = f^{-1}(F, A)(\alpha)(u) \widetilde{V} f^{-1}(G, B)(\alpha)(u).$$

$$(f^{-1}(F, A) \widetilde{\wedge} f^{-1}(G, B))(\alpha)(u) = f^{-1}(F, A)(\alpha)(u) \widetilde{\wedge} f^{-1}(G, B)(\alpha)(u).$$

Theorem . Let $f: (\widetilde{U}, \widetilde{Z}) \rightarrow (\widetilde{Y}, \widetilde{Z})$ be a mapping. Then for intuitionistic fuzzy soft expert sets (F, A) and (G, B) in the intuitionistic fuzzy soft expert class $(\widetilde{U}, \widetilde{Z})$.

1. $f(\emptyset) = \emptyset$
2. $f(\widetilde{Z}) \subseteq \widetilde{Y}$.
3. $f((F, A) \widetilde{V} (G, B)) = f(F, A) \widetilde{V} f(G, B)$
4. $f((F, A) \widetilde{\wedge} (G, B)) = f(F, A) \widetilde{\wedge} f(G, B)$
5. If $(F, A) \subseteq (G, B)$, Then $f(F, A) \subseteq f(G, B)$.

Proof For (1), (2) and (5) the proof is trivial, so we just give the proof of (3) and (4).

For $\beta \in \widetilde{Z}$ and $y \in \widetilde{Y}$, we want to prove that

$$(f(F, A) \widetilde{V} f(G, B))(\beta)(y) = f(F, A)(\beta)(y) \widetilde{V} f(G, B)(\beta)(y)$$

For left hand side, consider $f((F, A) \widetilde{V} (G, B))(\beta)(y) = f(H, A \cup B)(\beta)(y)$. Then

$$f(H, A \cup B)(\beta)(y) = \begin{cases} \bigvee_{x \in r^{-1}(y)} (\bigvee_{\alpha \in s^{-1}(\beta)} H(\alpha)) & \text{if } r^{-1}(y) \text{ and } s^{-1}(\beta) \cap (A \cup B) \neq \emptyset \\ 0 & \text{otherwise} \end{cases} \quad (1,1)$$

Such that $H(\alpha) = F(\alpha) \widetilde{U} G(\alpha)$ where \widetilde{U} denotes intuitionistic fuzzy union.

Considering only the non-trivial case, Then equation 1.1 becomes:

$$f(H, A \cup B)(\beta)(y) = \bigvee_{x \in r^{-1}(y)} (\bigvee_{\alpha \in s^{-1}(\beta)} (F(\alpha) \widetilde{U} G(\alpha))) \quad (1,)$$

For right hand side and by using Definition 3.4, we have

$$(f(F, A) \widetilde{V} f(G, B))(\beta)(y) = f(F, A)(\beta)(y) \widetilde{V} f(G, B)(\beta)(y) = \bigvee_{x \in r^{-1}(y)} (\bigvee_{\alpha \in s^{-1}(\beta) \cap A} F(\alpha)(x)) \widetilde{V} \bigvee_{x \in r^{-1}(y)} (\bigvee_{\alpha \in s^{-1}(\beta) \cap B} F(\alpha)(x)) = \bigvee_{x \in r^{-1}(y)} (\bigvee_{\alpha \in s^{-1}(\beta) \cap (A \cup B)} (F(\alpha) \widetilde{V} G(\alpha)))$$

$$\bigvee_{x \in r^{-1}(y)} (\bigvee_{\alpha \in S^{-1}(\beta)} (F(\alpha) \tilde{\vee} G(\alpha))) (1,3)$$

From equation (1.1) and (1.3) we get (3)

4. For $\beta \in Z$ and $y \in Y$, and using Definition 3.4, we have

$$\begin{aligned} & f((F, A) \tilde{\wedge} (G, B))(\beta)(y) \\ & f(H, A \cup B)(\beta)(y) \\ & \bigvee_{x \in r^{-1}(y)} (\bigvee_{\alpha \in S^{-1}(\beta) \cap (A \cup B)} H(\alpha))(x) \\ & \bigvee_{x \in r^{-1}(y)} (\bigvee_{\alpha \in S^{-1}(\beta) \cap (A \cup B)} F(\alpha) \tilde{\wedge} G(\alpha))(x) \\ & \bigvee_{x \in r^{-1}(y)} (\bigvee_{\alpha \in S^{-1}(\beta) \cap (A \cup B)} F(\alpha)(x) \tilde{\wedge} G(\alpha)(x)) \\ \subseteq & \left(\bigvee_{x \in r^{-1}(y)} \left(\bigvee_{\alpha \in S^{-1}(\beta) \cap A} F(\alpha) \right) \right) \wedge \bigvee_{x \in r^{-1}(y)} \left(\bigvee_{\alpha \in S^{-1}(\beta) \cap B} G(\alpha) \right) \\ & f((F, A)(\beta)(y) \wedge (G, B)(\beta)(y)) \\ & (f(F, A) \tilde{\wedge} f(G, B))(\beta)(y) \end{aligned}$$

This gives (4)

Theorem . . Let $f^{-1}: (\widetilde{U}, \widetilde{Z}) \rightarrow (\widetilde{Y}, \widetilde{Z})$ be a mapping. Then for intuitionistic fuzzy soft expert sets (F, A) and (G, B) in the intuitionistic fuzzy soft expert class $(\widetilde{U}, \widetilde{Z})$.

$$f^{-1}(\emptyset) = \emptyset$$

$$f^{-1}(X) \subseteq X.$$

$$f^{-1}((F, A) \tilde{\vee} (G, B)) = f^{-1}(F, A) \tilde{\vee} f^{-1}(G, B)$$

$$f^{-1}((F, A) \tilde{\wedge} (G, B)) = f^{-1}(F, A) \tilde{\wedge} f^{-1}(G, B)$$

If $(F, A) \subseteq (G, B)$, Then $f^{-1}(F, A) \subseteq f^{-1}(G, B)$.

Proof. The proof is straightforward.

. Conclusion

In this paper, we studied a mapping on intuitionistic fuzzy soft expert classes and its properties. We give some illustrative examples of mapping intuitionistic fuzzy soft expert set. We hope these fundamental results will help the researchers to enhance and promote the research on intuitionistic fuzzy soft set theory.

References

- [1] A. A. Hazaymeh, I. B. Abdullah, Z. T. Balkhi and R.I. Ibrahim, Generalized fuzzy soft expert set, Journal of Applied Mathematics, (2012) 22 pages, Article ID 328195
- [2] A. ArokiaLancy, C. Tamilarasi and I. Arockiarani, Fuzzy parameterization for decision making in risk management system via soft expert set, International Journal of Innovative Research and studies, Vol 2 issue 10, (2013) 339-344, from www.ijirs.com.
- [3] A. ArokiaLancy, I. Arockiarani, A Fusion of soft expert set and matrix models, International Journal of Research in Engineering and Technology, Vol 02, issue 12, (2013) 531-535, from http://www.ijret.org.
- [4] A. Kharal and B. Ahmad, Mappings on soft classes, New Mathematics and Natural Computation, 07 (3) (2011), 471-481.
- [5] A. Kharal and B. Ahmad, Mappings on Fuzzy soft classes, Advances in Fuzzy Systems Volume 2009 (2009), Article ID 407890, 6 pages

- [6] D. Molodtsov, Soft set theory-first result, *Computers and Mathematics with Applications*, 37(1999) 19-31.
- [7] G. Selvachandran, Possibility Vague Soft Expert Set Theory.(2014) Submitted.
- [8] H. L. Yang, Notes On generalized fuzzy soft sets, *Journal of Mathematical Research and Exposition*, 31/ 3 (2011) 567-570.
- [9] I. Arockiarani and A. A. ArokiaLancy, Multi criteria decision making problem with soft expert set. *International journal of Computer Applications*, Vol 78- No.15,(2013) 1-4 , from www.ijcaonline.org.
- [10] K.T. Atanassov, Intuitionistic fuzzy sets, *Fuzzy Sets and Systems* 20(1),(1986) 87-96.
- [11] K. Alhazaymeh& N. Hassan, Possibility vague soft set and its application in decision making. *International Journal of Pure and Applied Mathematics* 77 (4), (2012) 549-563.
- [12] K. Alhazaymeh& N. Hassan, Application of generalized vague soft expert set in decision making, *International Journal of Pure and Applied Mathematics* 93(3), (2014) 361-367.
- [13] K. Alhazaymeh& N. Hassan, Generalized vague soft expert set, *International Journal of Pure and Applied Mathematics*, (in press).
- [14] K. Alhazaymeh& N. Hassan, Mapping on generalized vague soft expert set, *International Journal of Pure and Applied Mathematics*, Vol 93, No. 3 (2014) 369-376.
- [15] K.V. Babitha and J. J. Sunil, Generalized intuitionistic fuzzy soft sets and Its Applications, *Gen. Math. Notes*, 7/ 2 (2011) 1-14.
- [16] L.A. Zadeh, Fuzzy sets, *Information and Control*, Vol8 (1965) 338-356.
- [17] M. Bashir & A.R. Salleh & S. Alkhazaleh, Possibility intuitionistic fuzzy soft Sets. *Advances in Decision Sciences*, 2012, Article ID 404325, 24 pages.
- [18] M. Bashir & A.R. Salleh, Fuzzy parameterized soft expert set. *Abstract and Applied Analysis*, 2012, Article ID 25836, 15 pages.
- [19] M. Bashir & A.R. Salleh, Possibility fuzzy soft expert set. *Open Journal of Applied Sciences* 12,(2012) 208-211.
- [20] M. Borah, T. J. Neog and D. K. Sut, A study on some operations of fuzzy soft sets, *International Journal of Modern Engineering Research*, 2/ 2 (2012) 157-168.
- [21] N. Hassan & K. Alhazaymeh, Vague soft expert set theory. *AIP Conference Proceedings* 1522, 953 (2013) 953-958.
- [22] N. a man, S. Engino lu, F. itak, Fuzzy soft set theory and Its Applications. *Iranian Journal of Fuzzy System* 8(3) (2011) 137-147.
- [23] N. a man, F itak , S. Engino lu, Fuzzy parameterized fuzzy soft set theory and its applications, *Turkish Journal of Fuzzy System* 1/1 (2010) 21-35.
- [24] N. a man, S. Karataş, Intuitionistic fuzzy soft set theory and its decision making, *Journal of Intelligent and Fuzzy Systems* DOI:10.3233/IFS-2012-0601.
- [25] N. a man, I. Deli, Intuitionistic fuzzy parametrized soft set theory and its decision making, *Applied Soft Computing* 28 (2015) 109–113.
- [26] N. a man, F. Karaaslan, IFP fuzzy soft set theory and its applications, Submitted.
- [27] N. a man, I. Deli, Product of FP-soft sets and its applications, *Hacettepe Journal of Mathematics and Statistics*, 41/3 (2012) 365 - 374.
- [28] N. a man, I. Deli, Means of FP-softsets and its applications, *Hacettepe Journal of Mathematics and Statistics*, 41/5 (2012) 615–625.

- [29] P. K. Maji, A. R. Roy and R. Biswas, Fuzzy soft sets, *Journal of Fuzzy Mathematics*, 9/3 (2001) 589-602.
- [30] P. K. Maji, R. Biswas and A. R. Roy, Intuitionistic fuzzy soft sets, *The Journal of Fuzzy Mathematics*, 9/3 (2001) 677-692.
- [31] P. Majumdar, S. K. Samanta, Generalized fuzzy soft sets, *Computers and Mathematics with Applications*, 59 (2010) 1425-1432.
- [32] P.D. Liu, Some Hamacher aggregation operators based on the interval-valued intuitionistic fuzzy numbers and their application to Group Decision Making, *IEEE Transactions on Fuzzy systems*, 22(1) (2014) 83 - 97
- [33] P.D. Liu, ZM. Liu, X. Zhang, Some Intuitionistic Uncertain Linguistic Heronian mean Operators and Their Application to Group Decision Making, *Applied Mathematics and Computation*, 230 (2014) 570–586.
- [34] P.D. Liu, YM. Wang, Multiple Attribute Group Decision Making Methods Based on Intuitionistic Linguistic Power Generalized Aggregation Operators, *Applied soft computing*, 2014, 17:90–104
- [35] P.D. Liu, Some Generalized Dependent Aggregation Operators with Intuitionistic Linguistic Numbers and Their Application to Group Decision Making, *Journal of Computer and System Sciences* 79 (1) (2013) 131–143
- [36] P.D. Liu, F. Jin, Methods for Aggregating Intuitionistic Uncertain Linguistic variables and Their Application to Group Decision Making, *Information Sciences* 205 (2012) 58–71
- [37] P.D. Liu, C. Yubao, C. Yanchang, Intuitionistic Uncertain Linguistic Weighted Bonferroni OWA Operator and Its Application to Multiple Attribute Decision Making, *Cybernetics and Systems*, 45(5) (2014) 418-438
- [38] P.D. Liu, Y. Liu, An approach to multiple attribute group decision making based on intuitionistic trapezoidal fuzzy power generalized aggregation operator, *International Journal of Computational Intelligence Systems*, 7(2)(2014) 291-304.
- [39] S. Alkhazaleh & A.R. Salleh, Fuzzy soft expert set and its application. *Applied Mathematics* 5(2014) 1349-1368.
- [40] S. Alkhazaleh & A.R. Salleh, Soft expert sets. *Advances in Decision Sciences* 2011, Article ID 757868, 12 pages.
- [41] S. Alkhazaleh, A. R. Salleh & N. Hassan, Possibility fuzzy soft sets. *Advances in Decision Sciences* (2011) Article ID 479756, 18 pages.
- [42] S. Broumi, F. Smarandache, Intuitionistic fuzzy soft expert sets and its application in decision making, *Journal of New Theory*, No.1 (2015) 89-105, from <http://www.newtheory.org>.
- [43] S. Broumi, F. Smarandache, M. Dhar & P. Majumdar, New Results of Intuitionistic Fuzzy Soft Set, *I.J. Information Engineering and Electronic Business*, 2,(2014) 47-52.
- [44] S. Broumi, P. Majumdar & F. Smarandache, New Operations on intuitionistic fuzzy soft sets Based on first Zadeh's logical operators, *Journal of New Results in Science*, No.4 (2014) 71-81.
- [45] T. A. Albinaa & I. Arockiarani, Soft expert pgsset, *Journal of Global Research in Mathematical Archives*, Vol 2, No. 3 (2014) 29-35.

NEUTROSOPHIC SETS

New Operations on Intuitionistic Fuzzy Soft Sets Based on First Zadeh's Logical Operators

Said Broumi, Pinaki Majumdar, Florentin Smarandache

Said Broumi, Pinaki Majumdar, Florentin Smarandache (2014). New Operations on Intuitionistic Fuzzy Soft Sets Based on First Zadeh's Logical Operators. *Journal of New Results in Science* 4, 71-81

Abstract – In this paper , we have defined First Zadeh's implication , First Zadeh's intuitionistic fuzzy conjunction and intuitionistic fuzzy disjunction of two intuitionistic fuzzy soft sets and some their basic properties are studied with proofs and examples.

Keywords – Fuzzy sets, Intuitionistic fuzzy sets, Fuzzy soft sets, Intuitionistic fuzzy soft sets.

1. Introduction

The concept of the intuitionistic fuzzy (IFS , for short) was introduced in 1983 by Atanassov [1] as an extension of Zadeh's fuzzy set. All operations, defined over fuzzy sets were transformed for the case the IFS case .This concept is capable of capturing the information that includes some degree of hesitation and applicable in various fields of research .For example , in decision making problems, particularly in the case of medial of medical diagnosis ,sales analysis ,new product marketing , financial services, etc. Atanassov et.al [2,3] have widely applied theory of intuitionistic sets in logic programming, Szmidt and Kacprzyk [4] in group decision making, De et al [5] in medical diagnosis etc. Therefore in various engineering application, intuitionstic fuzzy sets techniques have been more popular than fuzzy sets techniques in recent years. After defining a lot of operations over Intuitionstic fuzzy sets during last ten years [6] ,in 2011, Atanassov [7, 8] constructed two new operations based on the First Zadeh's IF-implication which are the first Zadeh's conjunction and disjunction, after that, in 2013, Atanassov[9] introduced the second type of Zadeh s conjunction and disjunction based on the Second Zadeh's IF-implication.

Another important concept that addresses uncertain information is the soft set theory originated by Molodtsov [10]. This concept is free from the parameterization inadequacy syndrome of fuzzy set theory, rough set theory, probability theory. Molodtsov has successfully applied the soft set theory in many different fields such as smoothness of functions, game theory, operations research, Riemann integration, Perron integration, and probability. In recent years, soft set theory has been received much attention since its appearance. There are many papers devoted to fuzzify the concept of soft set theory which leads to a series of mathematical models such as fuzzy soft set [11,12,13,14,15], generalized fuzzy soft set [16,17], possibility fuzzy soft set [18] and so on. Thereafter, Maji and his coworker [19] introduced the notion of intuitionistic fuzzy soft set which is based on a combination of the intuitionistic fuzzy sets and soft set models and studied the properties of intuitionistic fuzzy soft set. Later, a lot of extensions of intuitionistic fuzzy soft are appeared such as generalized intuitionistic fuzzy soft set [20], possibility Intuitionistic fuzzy soft set [21] etc.

In this paper, our aim is to extend the three new operations introduced by Atanassov to the case of intuitionistic fuzzy soft and study its properties. This paper is arranged in the following manner. In Section 2, some definitions and notion about soft set, fuzzy soft set and intuitionistic fuzzy soft set and some properties of its. These definitions will help us in later section . In Section 3, we discusses the three operations of intuitionistic fuzzy soft such as first Zadeh’s implication, First Zadeh’s intuitionistic fuzzy conjunction and first Zadeh intuitionistic fuzzy disjunction. Section 4 concludes the paper.

. Preliminaries

In this section, some definitions and notions about soft sets and intuitionistic fuzzy soft set are given. These will be useful in later sections

Let U be an initial universe, and E be the set of all possible parameters under consideration with respect to U . The set of all subsets of U , i.e. the power set of U is denoted by $P(U)$ and the set of all intuitionistic fuzzy subsets of U is denoted by IFU . Let A be a subset of E .

Definition .1 .A pair (F, A) is called a soft set over U , where F is a mapping given by $F : A \rightarrow P(U)$.

In other words, a soft set over U is a parameterized family of subsets of the universe U . For $e \in A$, $F(e)$ may be considered as the set of e -approximate elements of the soft set (F, A) .

Definition . . Let U be an initial universe set and E be the set of parameters. Let IFU^U denote the collection of all intuitionistic fuzzy subsets of U . Let $A \subseteq E$ pair (F, A) is called an intuitionistic fuzzy soft set over U where F is a mapping given by $F: A \rightarrow IFU^U$.

Definition . . Let $F: A \rightarrow IFU^U$ then F is a function defined as

$$F(\varepsilon) = \{ x, \mu_{F(\varepsilon)}(x), \nu_{F(\varepsilon)}(x) : x \in U \}$$

where μ, ν denote the degree of membership and degree of non-membership respectively.

Definition . . . For two intuitionistic fuzzy soft sets (F, A) and (G, B) over a common universe U , we say that (F, A) is an intuitionistic fuzzy soft subset of (G, B) if

- (1) $A \subseteq B$ and
- (2) $F(\varepsilon) \subseteq G(\varepsilon)$ for all $\varepsilon \in A$. i.e $\mu_{F(\varepsilon)}(x) \leq \mu_{G(\varepsilon)}(x)$, $\nu_{F(\varepsilon)}(x) \geq \nu_{G(\varepsilon)}(x)$ for all $\varepsilon \in E$ and

We write $(F,A) \subseteq (G, B)$.

In this case (G, B) is said to be a soft super set of (F, A) .

Definition . . . Two soft sets (F, A) and (G, B) over a common universe U are said to be soft equal if (F, A) is a soft subset of (G, B) and (G, B) is a soft subset of (F, A) .

Definition . . . Let U be an initial universe, E be the set of parameters, and $A \subseteq E$.

(a) (F, A) is called a relative null soft set (with respect to the parameter set A), denoted by \emptyset_A , if $F(a) = \emptyset$ for all $a \in A$.

(b) (G, A) is called a relative whole soft set (with respect to the parameter set A), denoted by U_A , if $G(e) = U$ for all $e \in A$.

Definition . . . Let (F, A) and (G, B) be two IFSSs over the same universe U . Then the union of (F,A) and (G,B) is denoted by $(F,A) \cup (G,B)$ and is defined by $(F,A) \cup (G,B) = (H,C)$, where $C = A \cup B$ and the truth-membership, falsity-membership of (H,C) are as follows:

$$H(\varepsilon) = \begin{cases} \{(\mu_{F(\varepsilon)}(x), \nu_{F(\varepsilon)}(x) : x \in U)\} , & \text{if } \varepsilon \in A - B, \\ \{(\mu_{G(\varepsilon)}(x), \nu_{G(\varepsilon)}(x) : x \in U)\} , & \text{if } \varepsilon \in B - A \\ \{\max(\mu_{F(\varepsilon)}(x), \mu_{G(\varepsilon)}(x)), \min(\nu_{F(\varepsilon)}(x), \nu_{G(\varepsilon)}(x)) : x \in U\} & \text{if } \varepsilon \in A \cap B \end{cases}$$

Where $\mu_{H(\varepsilon)}(x) = \max(\mu_{F(\varepsilon)}(x), \mu_{G(\varepsilon)}(x))$ and $\nu_{H(\varepsilon)}(x) = \min(\nu_{F(\varepsilon)}(x), \nu_{G(\varepsilon)}(x))$

Definition . . . Let (F, A) and (G, B) be two IFSS over the same universe U such that $A \cap B \neq \emptyset$. Then the intersection of (F, A) and (G, B) is denoted by $(F, A) \cap (G, B)$ and is defined by $(F, A) \cap (G, B) = (K, C)$, where $C = A \cap B$ and the truth-membership, falsity-membership of (K, C) are related to those of (F, A) and (G, B) by:

$$K(\varepsilon) = \begin{cases} \{(\mu_{F(\varepsilon)}(x), \nu_{F(\varepsilon)}(x) : x \in U)\} , & \text{if } \varepsilon \in A - B, \\ \{(\mu_{G(\varepsilon)}(x), \nu_{G(\varepsilon)}(x) : x \in U)\} , & \text{if } \varepsilon \in B - A \\ \{\min(\mu_{F(\varepsilon)}(x), \mu_{G(\varepsilon)}(x)), \max(\nu_{F(\varepsilon)}(x), \nu_{G(\varepsilon)}(x)) : x \in U\} & \text{if } \varepsilon \in A \cap B \end{cases}$$

Where $\mu_{K(\varepsilon)}(x) = \min(\mu_{F(\varepsilon)}(x), \mu_{G(\varepsilon)}(x))$ and $\nu_{K(\varepsilon)}(x) = \max(\nu_{F(\varepsilon)}(x), \nu_{G(\varepsilon)}(x))$

. New Operations on Intuitionistic Fuzzy Soft Sets Based on First Zadeh s Logical Operators

.1 First Zadeh s Implication of Intuitionistic Fuzzy Soft Sets

Definition .1.1. Let (F, A) and (G, B) are two intuitionistic fuzzy soft set s over (U,E) .We define the First Zadeh’s intuitionistic fuzzy soft set implication $(F, A) \xrightarrow{z,1}(G,B)$ is defined by $(F, A) \xrightarrow{z,1}(G,B) = [\max \{ \nu_{F(\varepsilon)}(x) , \min (\mu_{F(\varepsilon)}(x) , \mu_{G(\varepsilon)}(x)) \} , \min (\mu_{F(\varepsilon)}(x) , \nu_{G(\varepsilon)}(x))]$

Proposition .1. . Let $(F, A) ,(G, B)$ and (H, C) are three intuitionistic fuzzy soft set s over (U,E) . Then the following results hold

- (i) $(F, A) \cap (G,B) \xrightarrow{z,1}(H, C) \supseteq [(F, A) \xrightarrow{z,1}(H, C)] \cap [(G, B) \xrightarrow{z,1}(H, C)]$
- (ii) $(F, A) \cup (G,B) \xrightarrow{z,1}(H, C) \supseteq [(F, A) \xrightarrow{z,1}(H, C)] \cup [(G, B) \xrightarrow{z,1}(H, C)]$
- (iii) $(F, A) \cap (G,B) \xrightarrow{z,1}(H, C) \supseteq [(F, A) \xrightarrow{z,1}(H, C)] \cup [(G, B) \xrightarrow{z,1}(H, C)]$
- (iv) $(F, A) \xrightarrow{z,1}(F, A)^c = (F, A)^c$
- (v) $(F, A) \xrightarrow{z,1}(\varphi, A) = (F, A)^c$

Proof.

$$(i) \quad (F, A) \cap (G,B) \xrightarrow{z,1}(H, C) = \left[\begin{array}{l} \{ \min (\mu_{F(\varepsilon)}(x), \mu_{G(\varepsilon)}(x)) , \max (\nu_{F(\varepsilon)}(x), \nu_{G(\varepsilon)}(x)) \} \xrightarrow{z,1} (\mu_{H(\varepsilon)}(x) , \nu_{H(\varepsilon)}(x)) \\ \left[\begin{array}{l} \text{MAX} \left\{ \max (\nu_{F(\varepsilon)}(x), \nu_{G(\varepsilon)}(x)) , \min (\min (\mu_{F(\varepsilon)}(x), \mu_{G(\varepsilon)}(x)) , \mu_{H(\varepsilon)}(x)) \right\} , \\ \text{MIN} \left\{ \min (\mu_{F(\varepsilon)}(x), \mu_{G(\varepsilon)}(x)) , \nu_{H(\varepsilon)}(x) \right\} \end{array} \right] \end{array} \right] \quad (1)$$

$$\begin{aligned} & [(F, A) \xrightarrow{z,1}(H, C)] \cap [(G, B) \xrightarrow{z,1}(H, C)] \\ & [\max \{ \nu_{F(\varepsilon)} , \min (\mu_{F(\varepsilon)} , \mu_{H(\varepsilon)}) \} , \min (\mu_{F(\varepsilon)} , \nu_{H(\varepsilon)})] \cap \\ & [\max \{ \nu_{G(\varepsilon)} , \min (\mu_{G(\varepsilon)} , \mu_{H(\varepsilon)}) \} , \min (\mu_{G(\varepsilon)} , \nu_{H(\varepsilon)})] \\ & \left[\begin{array}{l} \text{MIN} \left\{ \max (\nu_{F(\varepsilon)}(x), \min (\mu_{F(\varepsilon)}(x), \mu_{H(\varepsilon)}(x))) , \max (\nu_{G(\varepsilon)}(x), \min (\mu_{G(\varepsilon)}(x), \mu_{H(\varepsilon)}(x))) \right\} , \\ \text{MAX} \left\{ \min (\mu_{F(\varepsilon)}(x), \nu_{H(\varepsilon)}(x)) , \min (\mu_{G(\varepsilon)}(x), \nu_{H(\varepsilon)}(x)) \right\} \end{array} \right] \quad (2) \end{aligned}$$

From (1) and (2) it is clear that $(F, A) \cap (G,B) \xrightarrow{z,1}(H, C) \supseteq [(F, A) \xrightarrow{z,1}(H, C)] \cap [(G, B) \xrightarrow{z,1}(H, C)]$

(ii) And (iii) the proof is similar to (i)

$$(iv) \quad (F, A) \xrightarrow{z,1}(F, A)^c = (F, A)^c = \left[\begin{array}{l} \text{Max} \left\{ \nu_{F(\varepsilon)}(x), \min (\mu_{F(\varepsilon)}(x), \nu_{F(\varepsilon)}(x)) \right\} , \\ \text{MIN} \left\{ \mu_{F(\varepsilon)}(x), \mu_{F(\varepsilon)}(x) \right\} \end{array} \right]$$

$$(\nu_{F(\varepsilon)}(x), \mu_{F(\varepsilon)}(x))$$

It is shown that the first Zadeh's intuitionistic fuzzy soft implication generate the complement of intuitionistic fuzzy soft set.

(v) The proof is straightforward .

Example .1. .

$$\begin{aligned} (F ,A) & \{F(e_1) (a , 0.3 , 0.2)\} \\ (G ,B) & \{G(e_1) (a , 0.4 , 0.5)\} \\ (H ,C) & \{H(e_1) (a , 0.3 , 0.6)\} \end{aligned}$$

$$\begin{aligned} (F, A) \cap (G,B) & \xrightarrow{z,1} (H, C) \\ [\max \{ (\max (0.2, \min (0.3,0.4)) , 0.3 \} , \min \min (0.3,0.5), 0.6))\} & (0.5, 0.3) \\ (F, A) \cap (G,B) & \{(a ,0.3 ,0.5)\} \end{aligned}$$

. . First Zadeh s Intuitionistic Fuzzy Conjunction of Intuitionistic Fuzzy Soft Set

Definition . .1. Let (F, A) and (G, B) are two intuitionistic fuzzy soft sets over (U,E) .We define the first Zadeh's intuitionistic fuzzy conjunction of (F, A) and (G,B) as the intuitionistic fuzzy soft set (H,C) over (U,E), written as (F, A) $\tilde{\wedge}_{z,1}$ (G,B) (H ,C). Where $C = A \cap B \neq \emptyset$ and $\forall \varepsilon \in C, x \in U,$

$$\begin{aligned} \mu_{H(\varepsilon)}(x) & MIN(\mu_{F(\varepsilon)}(x) , \mu_{G(\varepsilon)}(x)) \\ \nu_{H(\varepsilon)}(x) & Max \{ \nu_{F(\varepsilon)}(x) , \min(\mu_{F(\varepsilon)}(x) , \nu_{G(\varepsilon)}(x)) \} \end{aligned}$$

Example

Let $U = \{a, b, c\}$ and $E = \{e_1, e_2, e_3, e_4\}$, $A = \{e_1, e_2, e_4\} \subseteq E, B = \{e_1, e_2, e_3\} \subseteq E$

$$\begin{aligned} (F, A) & \{ F(e_1) \{ (a, 0.5, 0.1), (b, 0.1, 0.8), (c, 0.2, 0.5) \}, \\ & F(e_2) \{ (a, 0.7, 0.1), (b, 0, 0.8), (c, 0.3, 0.5) \}, \\ & F(e_4) \{ (a, 0.6, 0.3), (b, 0.1, 0.7), (c, 0.9, 0.1) \} \} \end{aligned}$$

$$\begin{aligned} (G, B) & \{ G(e_1) \{ (a, 0.2, 0.6), (b, 0.7, 0.1), (c, 0.8, 0.1) \}, \\ & G(e_2) \{ (a, 0.4, 0.1), (b, 0.5, 0.3), (c, 0.4, 0.5) \}, \\ & G(e_3) \{ (a, 0, 0.6), (b, 0, 0.8), (c, 0.1, 0.5) \} \} \end{aligned}$$

Let $(F, A) \tilde{\wedge}_z (G,B) = (H ,C)$,where $C = A \cap B = \{e_1, e_2\}$

$$\begin{aligned} (H, C) & \{ H (e_1) \{ (a, \min(0.5, 0.2), \max(0.1, \min(0.5, 0.6))) \\ & (b, \min(0.1, 0.7), \max(0.8, \min(0.1, 0.1))) \\ & (c, \min(0.2, 0.8), \max(0.5, \min(0.2, 0.1))) \}, \\ & H (e_2) \{ (a, \min(0.7, 0.4), \max(0.1, \min(0.7, 0.1))) \\ & (b, \min(0, 0.5), \max(0.8, \min(0, 0.3))) \\ & (c, \min(0.3, 0.4), \max(0.5, \min(0.3, 0.5))) \} \} \end{aligned}$$

$$\begin{aligned} (H, C) & \{ H (e_1) \{ (a, \min(0.5, 0.2), \max(0.1, 0.5)), \\ & (b, \min(0.1, 0.7), \max(0.8, 0.1)), \end{aligned}$$

$$H(e_2) = \{(c, \min(0.2, 0.8), \max(0.5, 0.1)), \\ (a, \min(0.7, 0.4), \max(0.1, 0.1)), \\ (b, \min(0, 0.5), \max(0, 0.8)), \\ (c, \min(0.3, 0.4), \max(0.5, 0.3))\}$$

$$(H, C) = \{H(e_1) = \{(a, 0.2, 0.5), (b, 0.1, 0.8), (c, 0.2, 0.5)\}, \\ H(e_2) = \{(a, 0.4, 0.1), (b, 0, 0), (c, 0.3, 0.5)\}\}$$

Proposition . . . Let (F, A), (G, B) and (H, C) are three intuitionistic fuzzy soft sets over (U, E). Then the following result holds

$$(F, A) \tilde{\wedge}_{z,1} (G, B) \rightarrow (H, C) \supseteq [(F, A) \rightarrow_{z,1} (H, C)] \tilde{\wedge}_{z,1} [(G, B) \rightarrow_{z,1} (H, C)]$$

Proof. Let (F, A), (G, B) and (H, C) are three intuitionistic fuzzy soft sets, then $(F, A) \tilde{\wedge}_{z,1} (G, B) \rightarrow_{z,1} (H, C)$

$$\left[\begin{array}{l} \text{Max} \left\{ \max \left(v_{F(\varepsilon)}(x), \min \left(\mu_{F(\varepsilon)}(x), v_{G(\varepsilon)}(x) \right) \right), \min \left(\min \left(\mu_{F(\varepsilon)}(x), \mu_{G(\varepsilon)}(x) \right), \mu_{H(\varepsilon)}(x) \right) \right\}, \\ \text{MIN} \left\{ \min \left(\mu_{F(\varepsilon)}(x), \mu_{G(\varepsilon)}(x) \right), v_{H(\varepsilon)}(x) \right\} \end{array} \right] \quad (1)$$

$$\text{Let } [(F, A) \rightarrow_{z,1} (H, C)] \tilde{\wedge}_{z,1} [(G, B) \rightarrow_{z,1} (H, C)]$$

$$(F, A) \rightarrow_{z,1} (H, C) = \left[\begin{array}{l} \text{MAX} \left\{ v_{F(\varepsilon)}(x), \min \left(\mu_{F(\varepsilon)}(x), \mu_{H(\varepsilon)}(x) \right) \right\}, \\ \text{MIN} \left\{ \mu_{F(\varepsilon)}(x), v_{H(\varepsilon)}(x) \right\} \end{array} \right]$$

$$[(G, B) \rightarrow_{z,1} (H, C)] = \left[\begin{array}{l} \text{MAX} \left\{ v_{G(\varepsilon)}(x), \min \left(\mu_{G(\varepsilon)}(x), \mu_{H(\varepsilon)}(x) \right) \right\}, \\ \text{MIN} \left\{ \mu_{G(\varepsilon)}(x), v_{H(\varepsilon)}(x) \right\} \end{array} \right]$$

$$\text{Then } [(F, A) \rightarrow_{z,1} (H, C)] \tilde{\wedge}_{z,1} [(G, B) \rightarrow_{z,1} (H, C)]$$

$$\left[\begin{array}{l} \text{MIN} \left(\max \left\{ v_{F(\varepsilon)}(x), \min \left(\mu_{F(\varepsilon)}(x), v_{H(\varepsilon)}(x) \right) \right\}, \max \left\{ v_{G(\varepsilon)}(x), \min \left(\mu_{G(\varepsilon)}(x), \mu_{H(\varepsilon)}(x) \right) \right\} \right), \\ \text{MAX} \left(\min \left\{ \mu_{F(\varepsilon)}(x), v_{H(\varepsilon)}(x) \right\}, \min \left\{ \max \left(v_{G(\varepsilon)}(x), \min \left(\mu_{G(\varepsilon)}(x), \mu_{H(\varepsilon)}(x) \right) \right), \min \left(\mu_{G(\varepsilon)}(x), v_{H(\varepsilon)}(x) \right) \right\} \right) \end{array} \right] \quad (2)$$

From (1) and (2) it is clear that

$$(F, A) \tilde{\wedge}_{z,1} (G, B) \rightarrow_{z,1} (H, C) \supseteq [(F, A) \rightarrow_{z,1} (H, C)] \tilde{\wedge}_{z,1} [(G, B) \rightarrow_{z,1} (H, C)]$$

. . . The First Zadeh's Intuitionistic Fuzzy Disjunction of Intuitionistic Fuzzy Soft Set

Definition . . . 1. Let (F, A) and (G, B) are two intuitionistic fuzzy soft sets over (U, E). We define the first Zadeh's intuitionistic fuzzy disjunction of (F, A) and (G, B) as the intuitionistic fuzzy soft set (H, C) over (U, E), written as $(F, A) \tilde{\vee}_{z,1} (G, B) = (H, C)$. Where $C = A \cap B \neq \emptyset$ and $\forall \varepsilon \in A, x \in U$

$$\mu_{H(\varepsilon)}(x) = \text{Max} \left\{ \mu_{F(\varepsilon)}(x), \min \left(v_{F(\varepsilon)}(x), \mu_{G(\varepsilon)}(x) \right) \right\}$$

$$v_{H(\varepsilon)}(x) = \text{Min}(v_{F(\varepsilon)}(x), v_{G(\varepsilon)}(x))$$

Example . . . Let $U = \{a, b, c\}$ and $E = \{e_1, e_2, e_3, e_4\}$, $A = \{e_1, e_2, e_4\} \subseteq E$,
 $B = \{e_1, e_2, e_3\} \subseteq E$

$$(F, A) \left\{ \begin{aligned} F(e_1) & \{ (a, 0.5, 0.1), (b, 0.1, 0.8), (c, 0.2, 0.5) \}, \\ F(e_2) & \{ (a, 0.7, 0.1), (b, 0, 0.8), (c, 0.3, 0.5) \}, \\ F(e_4) & \{ (a, 0.6, 0.3), (b, 0.1, 0.7), (c, 0.9, 0.1) \} \end{aligned} \right\}$$

$$(G, A) \left\{ \begin{aligned} G(e_1) & \{ (a, 0.2, 0.6), (b, 0.7, 0.1), (c, 0.8, 0.1) \}, \\ G(e_2) & \{ (a, 0.4, 0.1), (b, 0.5, 0.3), (c, 0.4, 0.5) \}, \\ G(e_3) & \{ (a, 0, 0.6), (b, 0, 0.8), (c, 0.1, 0.5) \} \end{aligned} \right\}$$

Let $(F, A) \tilde{V}_{z,1} (G, B) = (H, C)$, where $C = A \cap B = \{e_1, e_2\}$

$$(H, C) \left\{ \begin{aligned} H(e_1) & \{ (a, \max(0.5, \min(0.1, 0.2)), \min(0.1, 0.6)) \\ & (b, \max(0.1, \min(0.8, 0.7)), \min(0.8, 0.1)) \\ & (c, \max(0.2, \min(0.5, 0.8)), \min(0.5, 0.1)) \}, \\ H(e_2) & \{ (a, \max(0.7, \min(0.1, 0.4)), \min(0.1, 0.1)) \\ & (b, \max(0, \min(0.8, 0.5)), \min(0.8, 0.3)) \\ & (c, \max(0.3, \min(0.5, 0.4)), \min(0.5, 0.5)) \} \end{aligned} \right\}$$

$$(H, C) \left\{ \begin{aligned} H(e_1) & \{ (a, \max(0.5, 0.1), \min(0.1, 0.6)), \\ & (b, \max(0.1, 0.7), \min(0.8, 0.1)), \\ & (c, \max(0.2, 0.5), \min(0.5, 0.1)) \}, \\ H(e_2) & \{ (a, \max(0.7, 0.1), \min(0.1, 0.1)), \\ & (b, \max(0, 0.5), \min(0.8, 0.3)), \\ & (c, \max(0.3, 0.4), \min(0.5, 0.5)) \} \end{aligned} \right\}$$

$$(H, C) \left\{ \begin{aligned} H(e_1) & \{ (a, 0.5, 0.1), (b, 0.7, 0.1), (c, 0.5, 0.1) \}, \\ H(e_2) & \{ (a, 0.7, 0.1), (b, 0.5, 0.3), (c, 0.4, 0.5) \} \end{aligned} \right\}$$

Proposition . . .

- (i) $(\varphi, A) \tilde{\Lambda}_{z,1} (U, A) = (\varphi, A)$
- (ii) $(\varphi, A) \tilde{V}_{z,1} (U, A) = (U, A)$
- (iii) $(F, A) \tilde{V}_{z,1} (\varphi, A) = (F, A)$

Proof.

(i) Let $(\varphi, A) \tilde{\Lambda}_{z,1} (U, A) = (H, A)$, where For all $\varepsilon \in A, x \in U$, we have

$$\begin{aligned} \mu_{H(\varepsilon)}(x) &= \min(0, 1) = 0 \\ \nu_{H(\varepsilon)}(x) &= \max(1, \min(0, 0)) = \max(1, 0) = 1 \end{aligned}$$

Therefore $(H, A) = (0, 1)$, For all $\varepsilon \in A, x \in U$

It follows that $((\varphi, A) \tilde{\Lambda}_{z,1} (U, A) = (\varphi, A)$

(ii) Let $(\varphi, A) \tilde{V}_{z,1} (U, A) = (H, A)$, where For all $\varepsilon \in A, x \in U$, we have

$$\begin{aligned} \mu_{H(\varepsilon)}(x) &= \max(0, \min(1, 1)) = \max(0, 1) = 1 \\ \nu_{H(\varepsilon)}(x) &= \min(1, 0) = 0 \end{aligned}$$

Therefore $(H, A) = (1, 0)$, For all $\varepsilon \in A, x \in U$

It follows that $((\varphi, A) \tilde{\lambda}_{z,1}(U, A) = (U, A)$

(iii) Let $(F, A) \tilde{V}_{z,1}(\varphi, A) = (H, A)$, where For all $\varepsilon \in A, x \in U$, we have

$$\begin{aligned} \mu_{H(\varepsilon)}(x) &= \max(\mu_{F(\varepsilon)}(x), \min(\nu_{F(\varepsilon)}(x), 0)) = \max(\mu_{F(\varepsilon)}(x), 0) = \mu_{F(\varepsilon)}(x) \\ \nu_{H(\varepsilon)}(x) &= \min(\nu_{H(\varepsilon)}(x), 1) = \nu_{H(\varepsilon)}(x) \end{aligned}$$

Therefore $(H, A) = (\mu_{F(\varepsilon)}(x), \nu_{H(\varepsilon)}(x))$, For all $\varepsilon \in A, x \in U$

It follows that $(F, A) \tilde{V}_{z,1}(\varphi, A) = (F, A)$

Proposition . . .

$$(F, A) \tilde{V}_{z,1}(G, B) \underset{z,1}{-} (H, C) \supseteq [(F, A) \underset{z,1}{-} (H, C)] \tilde{V}_{z,1} [(G, B) \underset{z,1}{-} (H, C)]$$

Proof. The proof is similar as in proposition 3.2.3

Proposition . . .

- (i) $[(F, A) \tilde{\lambda}_{z,1}(G, B)]^c = (F, A)^c \tilde{V}_{z,1}(G, B)^c$
- (ii) $[(F, A) \tilde{V}_{z,1}(G, B)]^c = (F, A)^c \tilde{\lambda}_{z,1}(G, B)^c$
- (iii) $[(F, A)^c \tilde{\lambda}_{z,1}(G, B)^c]^c = (F, A) \tilde{V}_{z,1}(G, B)$

Proof.

(i) Let $[(F, A) \tilde{\lambda}_{z,1}(G, B)]^c = (H, C)$, where For all $\varepsilon \in C, x \in U$, we have

$$\begin{aligned} [(F, A) \tilde{\lambda}_{z,1}(G, B)]^c &= \left[\begin{array}{c} \text{MIN}\{\mu_{F(\varepsilon)}(x), \mu_{G(\varepsilon)}(x)\}, \\ \text{MAX}\{\nu_{F(\varepsilon)}(x), \min(\mu_{F(\varepsilon)}(x), \nu_{G(\varepsilon)}(x))\} \end{array} \right]^c \\ &= \left[\begin{array}{c} \text{MAX}\{\nu_{F(\varepsilon)}(x), \min(\mu_{F(\varepsilon)}(x), \nu_{G(\varepsilon)}(x))\}, \\ \text{MIN}\{\mu_{F(\varepsilon)}(x), \mu_{G(\varepsilon)}(x)\} \end{array} \right] \\ &= (F, A)^c \tilde{V}_{z,1}(G, B)^c \end{aligned}$$

(ii) Let $[(F, A) \tilde{V}_{z,1}(G, B)]^c = (H, C)$, where For all $\varepsilon \in C, x \in U$, we have

$$\begin{aligned} [(F, A) \tilde{V}_{z,1}(G, B)]^c &= \left[\begin{array}{c} \text{MAX}\{\mu_{F(\varepsilon)}(x), \min(\nu_{F(\varepsilon)}(x), \mu_{G(\varepsilon)}(x))\}, \\ \text{MIN}\{\nu_{F(\varepsilon)}(x), \nu_{G(\varepsilon)}(x)\} \end{array} \right]^c \\ &= \left[\begin{array}{c} \text{MIN}\{\nu_{F(\varepsilon)}(x), \nu_{G(\varepsilon)}(x)\}, \\ \text{MAX}\{\mu_{F(\varepsilon)}(x), \min(\nu_{F(\varepsilon)}(x), \mu_{G(\varepsilon)}(x))\} \end{array} \right]^c \\ &= (F, A)^c \tilde{\lambda}_{z,1}(G, B)^c \end{aligned}$$

(iii) The proof is straightforward.

The following equalities are not valid.

$$\begin{aligned} (F, A) \tilde{V}_{z,1}(G, B) &= (G, B) \tilde{V}_{z,1}(F, A) \\ (F, A) \tilde{\Lambda}_{z,1}(G, B) &= (G, B) \tilde{\Lambda}_{z,1}(F, A) \\ [(F, A) \tilde{\Lambda}_{z,1}(G, B)] \tilde{\Lambda}_{z,1}(K, C) &= (F, A) \tilde{\Lambda}_{z,1} [(G, B) \tilde{\Lambda}_{z,1}(K, C)] \\ [(F, A) \tilde{V}_{z,1}(G, B)] \tilde{V}_{z,1}(K, C) &= (F, A) \tilde{V}_{z,1} [(G, B) \tilde{V}_{z,1}(K, C)] \\ [(F, A) \tilde{\Lambda}_{z,1}(G, B)] \tilde{V}_{z,1}(K, C) &= [(F, A) \tilde{V}_{z,1}(G, B)] \tilde{\Lambda}_{z,1} [(G, B) \tilde{V}_{z,1}(K, C)] \\ [(F, A) \tilde{V}_{z,1}(G, B)] \tilde{\Lambda}_{z,1}(K, C) &= [(F, A) \tilde{\Lambda}_{z,1}(G, B)] \tilde{V}_{z,1} [(G, B) \tilde{\Lambda}_{z,1}(K, C)] \end{aligned}$$

Example . . . Let $U = \{a, b, c\}$ and $E = \{e_1, e_2, e_3, e_4\}$, $A = \{e_1, e_2, e_4\} \subseteq E$, $B = \{e_1, e_2, e_3\} \subseteq E$

$$\begin{aligned} (F, A) &= \{F(e_1) = \{(a, 0.5, 0.1), (b, 0.1, 0.8), (c, 0.2, 0.5)\}, \\ &F(e_2) = \{(a, 0.7, 0.1), (b, 0, 0.8), (c, 0.3, 0.5)\}, \\ &F(e_4) = \{(a, 0.6, 0.3), (b, 0.1, 0.7), (c, 0.9, 0.1)\}\} \end{aligned}$$

$$\begin{aligned} (G, A) &= \{G(e_1) = \{(a, 0.2, 0.6), (b, 0.7, 0.1), (c, 0.8, 0.1)\}, \\ &G(e_2) = \{(a, 0.4, 0.1), (b, 0.5, 0.3), (c, 0.4, 0.5)\}, \\ &G(e_3) = \{(a, 0, 0.6), (b, 0, 0.8), (c, 0.1, 0.5)\}\} \end{aligned}$$

Let $(F, A) \tilde{\Lambda}_{z,1}(G, B) = (H, C)$, where $C = A \cap B = \{e_1, e_2\}$

$$\begin{aligned} \text{Then } (F, A) \tilde{\Lambda}_{z,1}(G, B) &= (H, C) = \{H(e_1) = \{(a, 0.2, 0.5), (b, 0.1, 0.8), (c, 0.2, 0.5)\}, \\ &H(e_2) = \{(a, 0.4, 0.1), (b, 0, 0), (c, 0.3, 0.5)\}\} \end{aligned}$$

For $(G, B) \tilde{\Lambda}_{z,1}(F, A) = (K, C)$, where $K = A \cap B = \{e_1, e_2\}$

$$\begin{aligned} (K, C) &= \{K(e_1) = \{(a, \min(0.2, 0.5), \max(0.6, \min(0.2, 0.1))) \\ &\quad (b, \min(0.7, 0.1), \max(0.1, \min(0.7, 0.8))) \\ &\quad (c, \min(0.8, 0.2), \max(0.1, \min(0.8, 0.5)))\}, \\ &K(e_2) = \{(a, \min(0.7, 0.4), \max(0.1, \min(0.4, 0.1))) \\ &\quad (b, \min(0.5, 0), \max(0.3, \min(0.5, 0.8))) \\ &\quad (c, \min(0.4, 0.3), \max(0.5, \min(0.4, 0.5)))\}\} \end{aligned}$$

$$\begin{aligned} (K, C) &= \{K(e_1) = \{(a, \min(0.2, 0.5), \max(0.6, 0.1)), \\ &\quad (b, \min(0.7, 0.1), \max(0.1, 0.7)), \\ &\quad (c, \min(0.8, 0.2), \max(0.1, 0.5))\}, \\ &K(e_2) = \{(a, \min(0.4, 0.7), \max(0.1, 0.1)), \\ &\quad (b, \min(0.5, 0), \max(0.3, 0.5)), \\ &\quad (c, \min(0.4, 0.3), \max(0.5, 0.4))\}\} \end{aligned}$$

$$\begin{aligned} (K, C) &= \{K(e_1) = \{(a, 0.2, 0.6), (b, 0.1, 0.7), (c, 0.2, 0.5)\}, \\ &K(e_2) = \{(a, 0.4, 0.1), (b, 0, 0.5), (c, 0.3, 0.5)\}\} \end{aligned}$$

$$\begin{aligned} \text{Then } (G, B) \tilde{\Lambda}_{z,1}(F, A) &= (K, C) = \{K(e_1) = \{(a, 0.2, 0.6), (b, 0.1, 0.7), (c, 0.2, 0.5)\}, \\ &K(e_2) = \{(a, 0.4, 0.1), (b, 0, 0.5), (c, 0.3, 0.5)\}\} \end{aligned}$$

It is obviously that $(F, A) \tilde{\lambda}_{z,1} (G, B) \neq (G, B) \tilde{\lambda}_{z,1} (F, A)$

Conclusion

In this paper, three new operations have been introduced on intuitionistic fuzzy soft sets. They are based on First Zadeh's implication, conjunction and disjunction operations on intuitionistic fuzzy sets. Some examples of these operations were given and a few important properties were also studied. In our following papers, we will extend the following three operations such as second zadeh's IF-implication, second zadeh's conjunction and second zadeh's disjunction to the intuitionistic fuzzy soft set. We hope that the findings, in this paper will help researcher enhance the study on the intuitionistic soft set theory.

References

- [1] K.T. Atanassov, "Intuitionistic Fuzzy Set". Fuzzy Sets and Systems, vol. 20(1), pp.87-86, 1986.
- [2] K.T. Atanassov and G. Gargov, "Intuitionistic Fuzzy Logic", C.R Academy of Bulgarian Society, Vol. 53, pp.9-12, 1990
- [3] K.T. Atanassov, and G.Gargov, "Intuitionistic Fuzzy Prolog", Fuzzy Sets and Systems, Vol. 4(3), pp.121-128, 1993
- [4] E.Szmidt and J.Kacprzyk, "Intuitionistic Fuzzy Sets in group decision making", Notes on IFS 2, pp.11-14, 1996
- [5] S.K.De, R. Biswas and A.Roy, "An Application of Intuitionistic Fuzzy set in medical diagnosis", Fuzzy Sets and Systems, vol. 117, pp.209-213, 2001.
- [6] K.T. Atanassov, "Intuitionistic Fuzzy Sets", Springer Physica-Verlag, Heidelberg, 1999.
- [7] K.T. Atanassov, "On Some Intuitionistic Fuzzy Implication. Comptes Rendus de l'Academie bulgare des Sciences, Tome 59, 2006, No.1, 19-24
- [8] K.T. Atanassov. "On Zadeh's intuitionistic Fuzzy Disjunction and Conjunction. Notes on Intuitionistic Fuzzy Sets, Vol. 1, 2011, No1, 1-4.
- [9] K.T. Atanassov. "Second Zadeh's Intuitionistic Fuzzy Implication. Notes on Intuitionistic Fuzzy Sets, Vol. 17, 2011, No3 (in press)
- [10] D. A. Molodtsov, "Soft Set Theory - First Result", Computers and Mathematics with Applications, Vol. 37, (1999), pp. 19-31.
- [11] P. K. Maji, R. Biswas and A.R. Roy, "Fuzzy Soft Sets", Journal of Fuzzy Mathematics, Vol 9, no.3, (2001), pp.-589-602.
- [12] B. Ahmad, and A. Kharal, "On Fuzzy Soft Sets", Hindawi Publishing Corporation, Advances in Fuzzy Systems, volume Article ID 586507, (2009), 6 pages doi: 10.1155/2009/586507.
- [13] P. K. Maji, A. R. Roy and R. Biswas, "Fuzzy Soft Sets", Journal of Fuzzy Mathematics. 9 (3), (2001), pp.589-602.

- [14] T. J. Neog and D. K. Sut, "On Fuzzy Soft Complement and Related Properties", Accepted for publication in International, Journal of Energy, Information and communications (IJEIC).
- [15] M. Borah, T. J. Neog and D. K. Sut," A Study on some Operations of Fuzzy Soft Sets", International Journal of Modern Engineering Research (IJMER), Vol.2, Issue. 2,(2012), pp. 157-168.
- [16] H. L. Yang, "Notes On Generalized Fuzzy Soft Sets", Journal of Mathematical Research and Exposition, Vol 31, No. 3, (2011), pp.567-570.
- [17] P. Majumdar, S. K. Samanta, "Generalized Fuzzy Soft Sets", Computers and Mathematics with Applications,59(2010), pp.1425-1432.
- [18] S. Alkhalaleh, A. R. Salleh, and N. Hassan," Possibility Fuzzy Soft Set", Advances in Decision Sciences,Vol 2011, Article ID 479756,18pages,doi:10.1155/2011/479756.
- [19] P. K. Maji, R. Biswas, A. R. Roy, "Intuitionistic Fuzzy Soft Sets", The journal of fuzzy mathematics 9(3)(2001), pp.677-692.
- [20] K.V .Babitha and J. J. Sunil," Generalized Intuitionistic Fuzzy Soft Sets and Its Applications ",Gen. Math. Notes, ISSN 2219-7184; Copyright ICSRS Publication, (2011), Vol. 7, No. 2, (2011), pp.1-14.
- [21] M.Bashir, A.R. Salleh, and S. Alkhalaleh," Possibility Intuitionistic Fuzzy Soft Set", Advances in Decision Sciences Volume 2012 (2012), Article ID 404325, 24 pages, doi:10.1155/2012/404325.

On neutrosophic refined sets and their applications in medical diagnosis

Irfan Deli, Said Broumi, Florentin Smarandache

Irfan Deli, Said Broumi, Florentin Smarandache (2015). On neutrosophic refined sets and their applications in medical diagnosis. *Journal of New Theory* 6, 88-98

Abstract – In this paper, we present some definitions of neutrosophic refined sets such as; union, intersection, convex and strongly convex in a new way to handle the indeterminate information and inconsistent information. Also we have examined some desired properties of neutrosophic refined sets based on these definitions. Then, we give distance measures of neutrosophic refined sets with properties. Finally, an application of neutrosophic refined set is given in medical diagnosis problem (heart disease diagnosis problem) to illustrate the advantage of the proposed approach.

Keywords – *Neutrosophic sets, neutrosophic refined sets, distance measures, decision making*

1 Introduction

Recently, several theories have been proposed to deal with uncertainty, imprecision and vagueness. Theory of probability, fuzzy set theory [46], intuitionistic fuzzy sets [7], rough set theory [27] etc. are consistently being utilized as efficient tools for dealing with diverse types of uncertainties and imprecision embedded in a system. However, all these above theories failed to deal with indeterminate and inconsistent information which exist in beliefs system. In 1995, Smarandache [39] developed a new concept called neutrosophic set (NS) which generalizes probability set, fuzzy set and intuitionistic fuzzy set. NS can be described by membership degree, indeterminacy degree and non-membership degree. This theory and their hybrid structures has proven useful in many different fields such as control theory [1], databases [3, 2],

medical diagnosis problem [4], decision making problem [5, 6, 9, 10, 11, 13, 12, 14, 17, 19, 20, 23, 25], physics [28], topology [24] etc.

Yager [43] firstly introduced a new theory, is called theory of bags, which is a multiset. Then, the concept of multisets were originally proposed by Blizard [8] and Calude et al. [15], as useful structures arising in many area of mathematics and computer sciences such as database queries. Several authors from time to time made a number of generalization of set theory. Since then, several researcher [18, 26, 35, 36, 37, 41, 42] discussed more properties on fuzzy multiset. Shinoj and John [38] made an extension of the concept of fuzzy multisets by an intuitionistic fuzzy set, which called intuitionistic fuzzy multisets (IFMS). Since then in the study on IFMS, a lot of excellent results have been achieved by researcher [22, 29, 30, 31, 32, 33, 34]. The concepts of FMS and IFMS fails to deal with indeterminacy. Therefore, Smarandache[40] give n-valued refined neutrosophic logic and its applications. Then, Ye and Ye [44] gave single valued neutrosophic sets and operations laws. Ye et al. [45] presented generalized distance measure and its similarity measures between single valued neutrosophic multi sets. Also they applied the measure to a medical diagnosis problem with incomplete, indeterminate and inconsistent information. Chatterjee et al.[16] developed single valued neutrosophic multi sets in detail.

Combining neutrosophic set models with other mathematical models has attracted the attention of many researchers. Maji et al. presented the concept of neutrosophic soft set [25] which is based on a combination of the neutrosophic set and soft set models. Broumi and Smarandache introduced the concept of the intuitionistic neutrosophic soft set [9, 12] by combining the intuitionistic neutrosophic set and soft set.

This paper is arranged in the following manner. In section 2, some definitions and notion about intuitionistic fuzzy set, intuitionistic fuzzy multisets and neutrosophic set theory. These definitions will help us in later section. In section 3 we study the concept of neutrosophic refined (multi) sets and their operations. In section 4, we present an application of neutrosophic multisets in medical diagnosis. Finally we conclude the paper.

2 Preliminary

In this section, we give the basic definitions and results of intuitionistic fuzzy set [7], intuitionistic fuzzy multiset [29] and neutrosophic set theory [39] that are useful for subsequent discussions.

Definition 2.1. [7] Let E be a universe. An intuitionistic fuzzy set I on E can be defined as follows:

$$I = \{ \langle x, \mu_I(x), \gamma_I(x) \rangle : x \in E \}$$

where, $\mu_I : E \rightarrow [0, 1]$ and $\gamma_I : E \rightarrow [0, 1]$ such that $0 \leq \mu_I(x) + \gamma_I(x) \leq 1$ for any $x \in E$.

Definition 2.2. [29] Let E be a universe. An intuitionistic fuzzy multiset K on E can be defined as follows:

$$K = \{ \langle x, (\mu_K^1(x), \mu_K^2(x), \dots, \mu_K^P(x)), (\gamma_K^1(x), \gamma_K^2(x), \dots, \gamma_K^P(x)) \rangle : x \in E \}$$

where, $\mu_K^1(x), \mu_K^2(x), \dots, \mu_K^P(x) : E \rightarrow [0, 1]$ and $\gamma_K^1(x), \gamma_K^2(x), \dots, \gamma_K^P(x) : E \rightarrow [0, 1]$ such that $0 \leq \mu_K^i(x) + \gamma_K^i(x) \leq 1 (i = 1, 2, \dots, P)$ and $\mu_K^1(x) \leq \mu_K^2(x) \leq \dots \leq \mu_K^P(x)$ for any $x \in E$.

Here, $(\mu_K^1(x), \mu_K^2(x), \dots, \mu_K^P(x))$ and $(\gamma_K^1(x), \gamma_K^2(x), \dots, \gamma_K^P(x))$ is the membership sequence and non-membership sequence of the element x , respectively.

We arrange the membership sequence in decreasing order but the corresponding non membership sequence may not be in decreasing or increasing order.

Definition 2.3. [39] Let U be a space of points (objects), with a generic element in U denoted by u . A neutrosophic set (N-set) A in U is characterized by a truth-membership function T_A , an indeterminacy-membership function I_A and a falsity-membership function F_A . $T_A(x)$, $I_A(x)$ and $F_A(x)$ are real standard or nonstandard subsets of $[0, 1]$. It can be written as

$$A = \{ \langle u, (T_A(x), I_A(x), F_A(x)) \rangle : x \in E, T_A(x), I_A(x), F_A(x) \in [0, 1] \}.$$

There is no restriction on the sum of $T_A(x)$; $I_A(x)$ and $F_A(x)$, so $0 \leq T_A(x) + I_A(x) + F_A(x) \leq 3$.

Definition 2.4. [21] t -norms are associative, monotonic and commutative two valued functions t that map from $[0, 1] \times [0, 1]$ into $[0, 1]$. These properties are formulated with the following conditions: $\forall a, b, c, d \in [0, 1]$,

1. $t(0, 0) = 0$ and $t(a, 1) = t(1, a) = a$,
2. If $a \leq c$ and $b \leq d$, then $t(a, b) \leq t(c, d)$
3. $t(a, b) = t(b, a)$
4. $t(a, t(b, c)) = t(t(a, b), c)$

Definition 2.5. [21] t -conorms (s -norm) are associative, monotonic and commutative two placed functions s which map from $[0, 1] \times [0, 1]$ into $[0, 1]$. These properties are formulated with the following conditions: $\forall a, b, c, d \in [0, 1]$,

1. $s(1, 1) = 1$ and $s(a, 0) = s(0, a) = a$,
2. if $a \leq c$ and $b \leq d$, then $s(a, b) \leq s(c, d)$
3. $s(a, b) = s(b, a)$
4. $s(a, s(b, c)) = s(s(a, b), c)$

t -norm and t -conorm are related in a sense of logical duality. Typical dual pairs of non parametrized t -norm and t -conorm are complied below:

1. Drastic product:

$$t_w(a, b) = \begin{cases} \min\{a, b\}, & \max\{ab\} = 1 \\ 0, & \text{otherwise} \end{cases}$$

2. Drastic sum:

$$s_w(a, b) = \begin{cases} \max\{a, b\}, & \min\{ab\} = 0 \\ 1, & \text{otherwise} \end{cases}$$

3. Bounded product:

$$t_1(a, b) = \max\{0, a + b - 1\}$$

4. Bounded sum:

$$s_1(a, b) = \min\{1, a + b\}$$

5. Einstein product:

$$t_{1.5}(a, b) = \frac{a.b}{2 - [a + b - a.b]}$$

6. Einstein sum:

$$s_{1.5}(a, b) = \frac{a + b}{1 + a.b}$$

7. Algebraic product:

$$t_2(a, b) = a.b$$

8. Algebraic sum:

$$s_2(a, b) = a + b - a.b$$

9. Hamacher product:

$$t_{2.5}(a, b) = \frac{a.b}{a + b - a.b}$$

10. Hamacher sum:

$$s_{2.5}(a, b) = \frac{a + b - 2.a.b}{1 - a.b}$$

11. Minumum:

$$t_3(a, b) = \min\{a, b\}$$

12. Maximum:

$$s_3(a, b) = \max\{a, b\}$$

3 Neutrosophic Refined Sets

In this section, we present some definitions of neutrosophic refined sets with operations. Also we have examined some desired properties of neutrosophic refined sets based on these definitions and operations. Some of it is quoted from [29, 32, 38, 39, 40].

In the following, some definition and operatios on intuitionistic fuzzy multiset defined in [18, 29], we extend this definition to NRS by using [20, 40].

Definition 3.1. [40, 44] Let E be a universe. A neutrosophic refined set (NRS) A on E can be defined as follows:

$$A = \{ \langle x, (T_A^1(x), T_A^2(x), \dots, T_A^P(x)), (I_A^1(x), I_A^2(x), \dots, I_A^P(x)), (F_A^1(x), F_A^2(x), \dots, F_A^P(x)) \rangle : x \in E \}$$

where, $T_A^1(x), T_A^2(x), \dots, T_A^P(x) : E \rightarrow [0, 1]$, $I_A^1(x), I_A^2(x), \dots, I_A^P(x) : E \rightarrow [0, 1]$ and $F_A^1(x), F_A^2(x), \dots, F_A^P(x) : E \rightarrow [0, 1]$ such that $0 \leq T_A^i(x) + I_A^i(x) + F_A^i(x) \leq 3 (i = 1, 2, \dots, P)$ and $T_A^1(x) \leq T_A^2(x) \leq \dots \leq T_A^P(x)$ for any $x \in E$. $(T_A^1(x), T_A^2(x), \dots, T_A^P(x))$,

$(I_A^1(x), I_A^2(x), \dots, I_A^P(x))$ and $(F_A^1(x), F_A^2(x), \dots, F_A^P(x))$ is the truth membership sequence, indeterminacy membership sequence and falsity membership sequence of the element x , respectively. Also, P is called the dimension of NRS A .

In [44] truth membership sequences are increase and other sequences (indeterminacy membership, falsity membership) are not increase or decrease. But throughout this paper the truth membership sequences, indeterminacy membership sequences, falsity membership sequences are not increase or decrease. The set of all Neutrosophic refined sets on E is denoted by $NRS(E)$.

Definition 3.2. [44] Let $A, B \in NRS(E)$. Then,

1. A is said to be NM subset of B is denoted by $A \tilde{\subseteq} B$ if $T_A^i(x) \leq T_B^i(x), I_A^i(x) \geq I_B^i(x), F_A^i(x) \geq F_B^i(x), \forall x \in E$.
2. A is said to be neutrosophic equal of B is denoted by $A = B$ if $T_A^i(x) = T_B^i(x), I_A^i(x) = I_B^i(x), F_A^i(x) = F_B^i(x), \forall x \in E$.
3. the complement of A denoted by $A^{\tilde{c}}$ and is defined by

$$A^{\tilde{c}} = \{ \langle x, (F_A^1(x), F_A^2(x), \dots, F_A^P(x)), (1 - I_A^1(x), 1 - I_A^2(x), \dots, 1 - I_A^P(x)), (T_A^1(x), T_A^2(x), \dots, T_A^P(x)) \rangle : x \in E \}$$

In the following, some definitions and operations with properties on neutrosophic multi set defined in [16, 44, 45], we generalized these definitions.

Definition 3.3. Let $A, B \in NRS(E)$. Then,

1. If $T_A^i(x) = 0$ and $I_A^i(x) = F_A^i(x) = 1$ for all $x \in E$ and $i = 1, 2, \dots, P$ then A is called null ns -set and denoted by $\tilde{\Phi}$.
2. If $T_A^i(x) = 1$ and $I_A^i(x) = F_A^i(x) = 0$ for all $x \in E$ and $i = 1, 2, \dots, P$, then A is called universal ns -set and denoted by \tilde{E} .

Definition 3.4. Let $A, B \in NRS(E)$. Then,

1. the union of A and B is denoted by $A \tilde{\cup} B = C_1$ and is defined by

$$C = \{ \langle x, (T_C^1(x), T_C^2(x), \dots, T_C^P(x)), (I_C^1(x), I_C^2(x), \dots, I_C^P(x)), (F_C^1(x), F_C^2(x), \dots, F_C^P(x)) \rangle : x \in E \}$$

where $T_C^i = s\{T_A^i(x), T_B^i(x)\}, I_C^i = t\{I_A^i(x), I_B^i(x)\}, F_C^i = t\{F_A^i(x), F_B^i(x)\}, \forall x \in E$ and $i = 1, 2, \dots, P$.

2. the intersection of A and B is denoted by $A \tilde{\cap} B = D$ and is defined by

$$D = \{ \langle x, (T_D^1(x), T_D^2(x), \dots, T_D^P(x)), (I_D^1(x), I_D^2(x), \dots, I_D^P(x)), (F_D^1(x), F_D^2(x), \dots, F_D^P(x)) \rangle : x \in E \}$$

where $T_D^i = t\{T_A^i(x), T_B^i(x)\}, I_D^i = s\{I_A^i(x), I_B^i(x)\}, F_D^i = s\{F_A^i(x), F_B^i(x)\}, \forall x \in E$ and $i = 1, 2, \dots, P$.

Proposition 3.5. Let $A, B, C \in NRS(E)$. Then,

1. $A \tilde{\cup} B = B \tilde{\cup} A$ and $A \tilde{\cap} B = B \tilde{\cap} A$

$$2. A\tilde{U}(B\tilde{U}C) = (A\tilde{U}B)\tilde{U}C \text{ and } A\tilde{\cap}(B\tilde{\cap}C) = (A\tilde{\cap}B)\tilde{\cap}C$$

Proof: The proofs can be easily made.

Proposition 3.6. Let $A, B, C \in NRS(E)$. Then,

1. $A\tilde{U}A = A$ and $A\tilde{\cap}A = A$
2. $A\tilde{\cap}\Phi = \tilde{\Phi}$ and $A\tilde{\cap}E = A$
3. $A\tilde{U}\Phi = A$ and $A\tilde{U}E = \tilde{E}$
4. $A\tilde{\cap}(B\tilde{U}C) = (A\tilde{\cap}B)\tilde{U}(A\tilde{\cap}C)$ and $A\tilde{U}(B\tilde{\cap}C) = (A\tilde{U}B)\tilde{\cap}(A\tilde{U}C)$
5. $(A^{\tilde{c}})^{\tilde{c}} = A$.

Proof. It is clear from Definition 3.3-3.4.

Theorem 3.7. Let $A, B \in NRS(E)$. Then, De Morgan's law is valid.

1. $(A\tilde{U}B)^{\tilde{c}} = A^{\tilde{c}}\tilde{\cap}B^{\tilde{c}}$
2. $(A\tilde{\cap}B)^{\tilde{c}} = A^{\tilde{c}}\tilde{U}B^{\tilde{c}}$

Proof. $A, B \in NRS(E)$ is given. From Definition 3.2 and Definition 3.4, we have

1.

$$\begin{aligned} (A\tilde{U}B)^{\tilde{c}} &= \{ \langle x, (s\{T_A^1(x), T_B^1(x)\}, s\{T_A^2(x), T_B^2(x)\}, \dots, s\{T_A^P(x), T_B^P(x)\}), \\ &\quad (t\{I_A^1(x), I_B^1(x)\}, t\{I_A^2(x), I_B^2(x)\}, \dots, t\{I_A^P(x), I_B^P(x)\}), \\ &\quad (t\{F_A^1(x), F_B^1(x)\}, t\{F_A^2(x), F_B^2(x)\}, \dots, t\{F_A^P(x), F_B^P(x)\}) \rangle : x \in E \}^{\tilde{c}} \\ &= \{ \langle x, (, t\{F_A^1(x), F_B^1(x)\}, t\{F_A^2(x), F_B^2(x)\}, \dots, t\{F_A^P(x), F_B^P(x)\}) \\ &\quad (1 - t\{I_A^1(x), I_B^1(x)\}, 1 - t\{I_A^2(x), I_B^2(x)\}, \dots, 1 - t\{I_A^P(x), I_B^P(x)\}), \\ &\quad (s\{T_A^1(x), T_B^1(x)\}, s\{T_A^2(x), T_B^2(x)\}, \dots, s\{T_A^P(x), T_B^P(x)\}) \rangle : x \in E \} \\ &= \{ \langle x, (, t\{F_A^1(x), F_B^1(x)\}, t\{F_A^2(x), F_B^2(x)\}, \dots, t\{F_A^P(x), F_B^P(x)\}) \\ &\quad (s\{1 - I_A^1(x), 1 - I_B^1(x)\}, s\{1 - I_A^2(x), 1 - I_B^2(x)\}, \dots, \\ &\quad s\{1 - I_A^P(x), 1 - I_B^P(x)\}), \\ &\quad (s\{T_A^1(x), T_B^1(x)\}, s\{T_A^2(x), T_B^2(x)\}, \dots, s\{T_A^P(x), T_B^P(x)\}) \rangle : x \in E \} \\ &= A^{\tilde{c}}\tilde{\cap}B^{\tilde{c}}. \end{aligned}$$

2.

$$\begin{aligned}
 (A\tilde{\cap}B)^{\tilde{c}} &= \{ \langle x, (t\{T_A^1(x), T_B^1(x)\}, t\{T_A^2(x), T_B^2(x)\}, \dots, t\{T_A^P(x), T_B^P(x)\}), \\
 &\quad (s\{I_A^1(x), I_B^1(x)\}, s\{I_A^2(x), I_B^2(x)\}, \dots, s\{I_A^P(x), I_B^P(x)\}), \\
 &\quad (s\{F_A^1(x), F_B^1(x)\}, s\{F_A^2(x), F_B^2(x)\}, \dots, s\{F_A^P(x), F_B^P(x)\}) \rangle : x \in E \}^{\tilde{c}} \\
 &= \{ \langle x, (, s\{F_A^1(x), F_B^1(x)\}, s\{F_A^2(x), F_B^2(x)\}, \dots, s\{F_A^P(x), F_B^P(x)\}) \\
 &\quad (1 - s\{I_A^1(x), I_B^1(x)\}, 1 - s\{I_A^2(x), I_B^2(x)\}, \dots, 1 - s\{I_A^P(x), I_B^P(x)\}), \\
 &\quad (t\{T_A^1(x), T_B^1(x)\}, t\{T_A^2(x), T_B^2(x)\}, \dots, t\{T_A^P(x), T_B^P(x)\}) \rangle : x \in E \} \\
 &= \{ \langle x, (, s\{F_A^1(x), F_B^1(x)\}, s\{F_A^2(x), F_B^2(x)\}, \dots, s\{F_A^P(x), F_B^P(x)\}) \\
 &\quad (t\{1 - I_A^1(x), 1 - I_B^1(x)\}, t\{1 - I_A^2(x), 1 - I_B^2(x)\}, \dots, \\
 &\quad t\{1 - I_A^P(x), 1 - I_B^P(x)\}), \\
 &\quad (t\{T_A^1(x), T_B^1(x)\}, t\{T_A^2(x), T_B^2(x)\}, \dots, t\{T_A^P(x), T_B^P(x)\}) \rangle : x \in E \} \\
 &= A^{\tilde{c}}\tilde{\cap}B^{\tilde{c}}.
 \end{aligned}$$

Theorem 3.8. Let P be the power set of all NRS defined in the universe E . Then $(P, \tilde{\cap}, \tilde{\cup})$ is a distributive lattice.

Proof: The proofs can be easily made by showing properties; idempotency, commutativity, associativity and distributivity

Definition 3.9. Let E is a real Euclidean space E^n . Then, a NRS A is convex if and only if

$$\begin{aligned}
 T_A^i(ax + (1 - a)y) &\geq T_A^i(x) \wedge T_A^i(y), I_A^i(ax + (1 - a)y) \leq I_A^i(x) \vee I_A^i(y) \\
 F_A^i(ax + (1 - a)y) &\leq F_A^i(x) \vee F_A^i(y)
 \end{aligned}$$

for every $x, y \in E, a \in I$ and $i = 1, 2, \dots, P$.

Definition 3.10. Let E is a real Euclidean space E^n . Then, a NRS A is strongly convex if and only if

$$\begin{aligned}
 T_A^i(ax + (1 - a)y) &> T_A^i(x) \wedge T_A^i(y), I_A^i(ax + (1 - a)y) < I_A^i(x) \vee I_A^i(y) \\
 F_A^i(ax + (1 - a)y) &< F_A^i(x) \vee F_A^i(y)
 \end{aligned}$$

for every $x, y \in E, a \in I$ and $i = 1, 2, \dots, P$.

Theorem 3.11. Let $A, B \in NRS(E)$. Then, $A\tilde{\cap}B$ is a convex(strongly convex) when both A and B are convex(strongly convex).

Proof. It is clear from Definition 3.9-3.10.

Definition 3.12. [16] Let $A, B \in NRS(E)$. Then,

1. Hamming distance $d_{HD}(A, B)$ between A and B , defined by;

$$d_{HD}(A, B) = \sum_{j=1}^P \sum_{i=1}^n (|T_A^j(x_i) - T_B^j(x_i)| + |I_A^j(x_i) - I_B^j(x_i)| + |F_A^j(x_i) - F_B^j(x_i)|)$$

2. Normalized hamming distance $d_{NHD}(A, B)$ between A and B , defined by;

$$d_{NHD}(A, B) = \frac{1}{3nP} \sum_{j=1}^P \sum_{i=1}^n (|T_A^j(x_i) - T_B^j(x_i)| + |I_A^j(x_i) - I_B^j(x_i)| + |F_A^j(x_i) - F_B^j(x_i)|)$$

3. Euclidean distance $d_{ED}(A, B)$ between A and B, defined by;

$$d_{ED}(A, B) = \sum_{j=1}^P \sum_{i=1}^n \sqrt{(T_A^j(x_i) - T_B^j(x_i))^2 + (I_A^j(x_i) - I_B^j(x_i))^2 + (F_A^j(x_i) - F_B^j(x_i))^2}$$

4. Normalized euclidean distance $d_{NED}(A, B)$ between A and B, defined by;

$$d_{NED}(A, B) = \frac{1}{3n.P} \sum_{j=1}^P \sum_{i=1}^n \sqrt{(T_A^j(x_i) - T_B^j(x_i))^2 + (I_A^j(x_i) - I_B^j(x_i))^2 + (F_A^j(x_i) - F_B^j(x_i))^2}$$

4 Medical Diagnosis Via NRS Theory

In the following, the example on intuitionistic fuzzy multiset given in [18, 31, 33, 38], we extend this definition to NRS.

Let $P=\{P_1,P_2,P_3,P_4\}$ be a set of patients, $D=\{\text{Viral Fever, Tuberculosis, Typhoid, Throat disease}\}$ be a set of diseases and $S=\{\text{Temperature, cough, throat pain,headache, body pain}\}$ be a set of symptoms. In Table I each symptom S_i is described by three numbers: Membership T, non-membership F and indeterminacy I.

	Viral Fever	Tuberculosis	Typhoid	Throat disease
Temperature	(0.8,0.2,0.1)	(0.3,0.4,0.2)	(0.4,0.6,0.3)	(0.5,0.7,0.1)
Cough	(0.2,0.3,0.7)	(0.2,0.5,0.3)	(0.4,0.5,0.4)	(0.8,0.3,0.2)
Throat Pain	(0.3,0.4,0.5)	(0.4,0.4,0.3)	(0.3,0.6,0.4)	(0.6,0.5,0.4)
Headache	(0.5,0.3,0.3)	(0.5,0.2,0.3)	(0.5,0.6,0.2)	(0.4,0.3,0.5)
Body Pain	(0.5,0.2,0.4)	(0.4,0.5,0.3)	(0.6,0.5,0.3)	(0.2,0.6,0.4)

Table I -NRS R: The relation among Symptoms and Diseases

The results obtained different time intervals such as: 8:00 am 12:00 am and 4:00 pm in a day as Table II;

	Temperature	Cough	Throat pain	Headache	Body Pain
P ₁	(0.1, 0.3, 0.7)	(0.3, 0.2, 0.6)	(0.8, 0.5, 0)	(0.3, 0.3, 0.6)	(0.4, 0.4, 0.4)
	(0.2, 0.4, 0.6)	(0.2, 0.4, 0)	(0.7, 0.6, 0.1)	(0.2, 0.4, 0.7)	(0.3, 0.2, 0.7)
	(0.1, 0.1, 0.9)	(0.1, 0.3, 0.7)	(0.8, 0.3, 0.1)	(0.2, 0.3, 0.6)	(0.2, 0.3, 0.7)
P ₂	(0.5, 0.3, 0.3)	(0.7, 0.3, 0.6)	(0.8, 0.6, 0.1)	(0.4, 0.2, 0.6)	(0.6, 0.2, 0.4)
	(0.3, 0.4, 0.5)	(0.6, 0.4, 0.3)	(0.6, 0.3, 0.1)	(0.5, 0.4, 0.7)	(0.5, 0.4, 0.6)
	(0.4, 0.2, 0.6)	(0.4, 0.1, 0.7)	(0.7, 0.5, 0.1)	(0.4, 0.3, 0.6)	(0.6, 0.3, 0.6)
P ₃	(0.7, 0.4, 0.6)	(0.7, 0.2, 0.5)	(0.5, 0.8, 0.4)	(0.6, 0.3, 0.4)	(0.6, 0.3, 0.3)
	(0.4, 0.5, 0.3)	(0.6, 0.5, 0.1)	(0.6, 0.4, 0.4)	(0.5, 0.3, 0.4)	(0.6, 0.5, 0.4)
	(0.3, 0.3, 0.5)	(0.4, 0.2, 0.2)	(0.7, 0.6, 0.3)	(0.4, 0.4, 0.5)	(0.6, 0.2, 0.8)
P ₄	(0.3, 0.4, 0.6)	(0.5, 0.4, 0.4)	(0.5, 0.6, 0.31)	(0.7, 0.4, 0.2)	(0.3, 0.3, 0.5)
	(0.6, 0.3, 0.3)	(0.6, 0.5, 0.3)	(0.7, 0.5, 0.6)	(0.4, 0.3, 0.4)	(0.7, 0.5, 0.2)
	(0.4, 0.2, 0.5)	(0.4, 0.2, 0.2)	(0.8, 0.5, 0.3)	(0.3, 0.6, 0.5)	(0.3, 0.5, 0.4)

Table II -NRS Q: the relation Between Patient and Symptoms.

The normalized Hamming distance between Q and R is computed as;

	Viral Fever	Tuberculosis	Typhoid	Throat disease
P_1	0.266	0.23	0.28	0.25
P_2	0.213	0.202	0.206	0.19
P_3	0.206	0.173	0.16	0.166
P_4	0.22	0.155	0.146	0.157

Table III :The normalized Hamming distance between Q and R

The lowest distance from the table III gives the proper medical diagnosis. Patient P_1 suffers from Tuberculosis, Patient P_2 suffers from Throat diseases, Patient P_3 suffers from Typhoid disease and Patient P_4 suffers from Typhoid

5 Conclusion

In this paper, we firstly defined some definitions on neutrosophic refined sets and investigated some of their basic properties. The concept of neutrosophic refined (NRS) generalizes the fuzzy multisets and intuitionistic fuzzy multisets. Then, an application of NRS in medical diagnosis is discussed. In the proposed method, we measured the distances of each patient from each diagnosis by considering the symptoms of that particular disease.

References

- [1] S. Aggarwal, R. Biswas and A. Q. Ansari, Neutrosophic Modeling and Control, Computer and Communication Technology (2010) 718–723.
- [2] M. Arora and R. Biswas, Deployment of Neutrosophic Technology to Retrieve Answers for Queries Posed in Natural Language, 3. Int. Conf. on Comp. Sci. and Inform. Tech. (2010) 435–439.
- [3] M. Arora, R. Biswas and U.S. Pandey, Neutrosophic Relational Database Decomposition, International Journal of Advanced Computer Science and Applications, 2(8) (2011) 121–125.
- [4] A.Q. Ansari, R. Biswas and S. Aggarwal, Proposal for Applicability of Neutrosophic Set Theory in Medical AI, International Journal of Computer Applications, 27/5 (2011) 5–11.
- [5] A.Q. Ansari, R. Biswas and S. Aggarwal, Neutrosophic classifier:An extension of fuzzy classifier, Applied Soft Computing 13 (2013) 563–573.
- [6] C. Ashbacher, Introduction to Neutrosophic Logic, American Research Press Rehoboth 2002.
- [7] K. T. Atanassov, Intuitionistic Fuzzy Set. Fuzzy Sets and Systems, 20(1), 87–86, 1986.
- [8] W. D. Blizard, Multiset theory, Notre Dame Journal of Formal Logic 30(1)(1989) 36–66.
- [9] S. Broumi and F. Smarandache, Intuitionistic Neutrosophic Soft Set, Journal of Information and Computing Science, 8(2) (2013) 130–140.
- [10] S. Broumi, Generalized Neutrosophic Soft Set, International Journal of Computer Science, Engineering and Information Technology 3(2) (2013) 17–30.

- [11] S. Broumi, F. Smarandache, Several Similarity Measures of Neutrosophic Sets, *Neutrosophic Sets and Systems*, 1 (2013) 54–62.
- [12] S. Broumi, F. Smarandache, More on Intuitionistic Neutrosophic Soft Sets, *Computer Science and Information Technology* 1(4) (2013) 257-268.
- [13] S. Broumi, I. Deli and F. Smarandache, Relations on Interval Valued Neutrosophic Soft Sets, *Journal of New Results in Science*, 5 (2014) 1–20
- [14] S. Broumi, I. Deli, F. Smarandache Neutrosophic Parametrized Soft Set theory and its decision making problem, *italian journal of pure and applied mathematics* 32 (2014) 1-12.
- [15] C. S. Calude, G. Paun, G. Rozenberg, A. Salomaa, *Lecture notes in computer science: Multiset Processing Mathematical, Computer Science, and Molecular Computing Points of View*, 2235, (2001) Springer-New York.
- [16] R. Chatterjee, P. Majumdar, S. K. Samanta, Single valued neutrosophic multisets, *Annals of Fuzzy Mathematics and Informatics*, x/x (2015) xx–xx.
- [17] P. Chi and L. Peide, An Extended TOPSIS Method for the Multiple Attribute Decision Making Problems Based on Interval Neutrosophic, *Neutrosophic Sets and Systems* 1 (2013) 63-70.
- [18] S. Das, M. B. Kar and S. Kar, Group multi-criteria decision making using intuitionistic multi-fuzzy sets, *Journal of Uncertainty Analysis and Applications* 10(1) (2013) 1-16.
- [19] I. Deli, Interval-valued neutrosophic soft sets and its decision making <http://arxiv.org/abs/1402.3130>.
- [20] I. Deli, S. Broumi, Neutrosophic Soft Matrices and NSM-decision Making, *Journal of Intelligent and Fuzzy Systems*, Doi: 10.3233/IFS-141505.
- [21] D. Dubois, and H. Prade, *Fuzzy Set and Systems: Theory and Applications*, Academic Press, New York, 1980.
- [22] P. A. Ejegwa, J. A. Awolola, Intuitionistic Fuzzy Multiset (IFMS) In Binomial Distributions, *International Journal Of Scientific and Technology Research* 3(4) (2014) 335-337.
- [23] A. Kharal, *A Neutrosophic Multicriteria Decision Making Method*, New Mathematics and Natural Computation, Creighton University, USA, 2013.
- [24] F. G. Lupiáñez, On neutrosophic topology, *Kybernetes*, 37(6) (2008) 797–800.
- [25] P.K. Maji, Neutrosophic soft set, *Annals of Fuzzy Mathematics and Informatics*, 5/1 (2013) 157-168.
- [26] R. Muthuraj and S. Balamurugan, Multi-Fuzzy Group and its Level Subgroups, *Gen. Math. Notes* 17(1) (2013) 74-81.
- [27] Z. Pawlak, Rough sets, *Int. J. Comput. Inform. Sci.*, 11 (1982) 341–356.
- [28] D. Rabounski F. Smarandache L. Borissova *Neutrosophic Methods in General Relativity*, *Hexis*, no:10 (2005).
- [29] P. Rajarajeswari and N. Uma, On Distance and Similarity Measures of Intuitionistic Fuzzy Multi Set, *IOSR Journal of Mathematics* 5(4) (2013) 19–23.

- [30] P. Rajarajeswari and N. Uma, A Study of Normalized Geometric and Normalized Hamming Distance Measures in Intuitionistic Fuzzy Multi Sets, *International Journal of Science and Research, Engineering and Technology* 2(11) (2013) 76–80.
- [31] P. Rajarajeswari and N. Uma, Normalized Hamming Similarity Measure for Intuitionistic Fuzzy Multi Sets and Its Application in Medical diagnosis, *International Journal of Mathematics Trends and Technology* 5(3) (2014) 219-225.
- [32] P. Rajarajeswari, N. Uma, Intuitionistic Fuzzy Multi Relations, *International Journal of Mathematical Archives* 4(10) (2013) 244-249.
- [33] P. Rajarajeswari and N. Uma, Zhang and Fu's Similarity Measure on Intuitionistic Fuzzy Multi Sets, *International Journal of Innovative Research in Science, Engineering and Technology* 3(5) (2014) 12309–12317.
- [34] P. Rajarajeswari, N. Uma, Correlation Measure For Intuitionistic Fuzzy Multi Sets, *International Journal of Research in Engineering and Technology* 3(1) (2014) 611-617.
- [35] S. Sebastian and T. V. Ramakrishnan, Multi-fuzzy Subgroups, *Int. J. Contemp. Math. Sciences* 6(8) (2011) 365–372.
- [36] S. Sebastian and T. V. Ramakrishnan, Multi-fuzzy extension of crisp functions using bridge functions, *Annals of Fuzzy Mathematics and Informatics* 2(1) (2011) 1–8.
- [37] S. Sebastian and T. V. Ramakrishnan, Multi-Fuzzy Sets, *International Mathematical Forum* 5(50) (2010) 2471–2476.
- [38] T. K. Shinoj and S. J. John, Intuitionistic fuzzy multisets and its application in medical diagnosis, *World Academy of Science, Engineering and Technology* 6 (2012) 01–28.
- [39] F. Smarandache, *A Unifying Field in Logics. Neutrosophy: Neutrosophic Probability, Set and Logic*, Rehoboth: American Research Press (1998).
- [40] F. Smarandache, n-Valued Refined Neutrosophic Logic and Its Applications in Physics, *Progress in Physics*, 143-146, Vol. 4, 2013.
- [41] A. Syropoulos, On generalized fuzzy multisets and their use in computation, *Iranian Journal Of Fuzzy Systems* 9(2) (2012) 113–125.
- [42] A. S. Thomas and S. J. John, Multi-fuzzy rough sets and relations, *Annals of Fuzzy Mathematics and Informatics* x/x (2013) xx-xxx.
- [43] R. R. Yager, On the theory of bags (Multi sets), *Int. Joun. Of General System*, 13 (1986) 23–37.
- [44] S. Ye, J. Ye, Dice similarity measure between single valued neutrosophic multisets and its application in medical diagnosis, *Neutrosophic Sets and Systems* 6 (2014) 48–52.
- [45] S. Ye, J. Fu, and J. Ye, Medical Diagnosis Using Distance- Based Similarity Measures of Single Valued Neutrosophic Multisets,
- [46] L. A. Zadeh, Fuzzy Sets, *Inform. and Control*, 8 (1965) 338-353.

On Neutrosophic Semi Alpha Open Set

Qays Hatem Imran, F. Smarandache, Riad K. Al-Hamido, R. Dhavaseelan

Qays Hatem Imran, F. Smarandache, Riad K. Al-Hamido, R. Dhavaseelan (2017). On Neutrosophic Semi Alpha Open Set. *Neutrosophic Sets and Systems* 18, 37-42

Abstract. In this paper, we presented another concept of neutrosophic open sets called neutrosophic semi- α -open sets and studied their fundamental properties in neutrosophic topological spaces. We also present neutrosophic semi- α -interior and neutrosophic semi- α - closure and study some of their fundamental properties.

Keywords: Neutrosophic semi- α -open sets, neutrosophic semi- α -closed sets, neutrosophic semi- α -interior and neutrosophic semi- α -closure.

1. Introduction

In 2000, G.B. Navalagi [4] presented the idea of semi- α -open sets in topological spaces. The concept of neutrosophic set was first given by F. Smarandache [2,3]. A.A. Salama and S.A. Alblowi [1] presented the concept of neutrosophic topological space (briefly NTS). The objective of this paper is to present the concept of neutrosophic semi- α -open sets and study their fundamental properties in neutrosophic topological spaces. We also present neutrosophic semi- α -interior and neutrosophic semi- α -closure and obtain some of its properties.

2. Preliminaries

Throughout this paper, (U, T) (or simply U) always mean a neutrosophic topological space. The complement of a neutrosophic open set (briefly N-OS) is called a neutrosophic closed set (briefly N-CS) in (U, T) . For a neutrosophic set \mathcal{A} in a neutrosophic topological space (U, T) , $Ncl(\mathcal{A})$, $Nint(\mathcal{A})$ and \mathcal{A}^c denote the neutrosophic closure of \mathcal{A} , the neutrosophic interior of \mathcal{A} and the neutrosophic complement of \mathcal{A} respectively.

Definition 2.1:

A neutrosophic subset \mathcal{A} of a neutrosophic topological space (U, T) is said to be:

(i) A neutrosophic pre-open set (briefly NP-OS) [7] if $\mathcal{A} \subseteq Nint(Ncl(\mathcal{A}))$. The complement of a NP-OS is called a neutrosophic pre-closed set (briefly NP-CS) in (U, T) . The

family of all NP-OS (resp. NP-CS) of U is denoted by $NPO(U)$ (resp. $NPc(U)$).

(ii) A neutrosophic semi-open set (briefly NS-OS) [6] if $\mathcal{A} \subseteq Ncl(Nint(\mathcal{A}))$. The complement of a NS-OS is called a neutrosophic semi-closed set (briefly NS-CS) in (U, T) . The family of all NS-OS (resp. NS-CS) of U is denoted by $NSO(U)$ (resp. $NSC(U)$).

(iii) A neutrosophic α -open set (briefly $N\alpha$ -OS) [5] if $\mathcal{A} \subseteq Nint(Ncl(Nint(\mathcal{A})))$. The complement of a $N\alpha$ -OS is called a neutrosophic α -closed set (briefly $N\alpha$ -CS) in (U, T) . The family of all $N\alpha$ -OS (resp. $N\alpha$ -CS) of U is denoted by $N\alpha O(U)$ (resp. $N\alpha C(U)$).

Definition 2.2:

(i) The neutrosophic pre-interior of a neutrosophic set \mathcal{A} of a neutrosophic topological space (U, T) is the union of all NP-OS contained in \mathcal{A} and is denoted by $PNint(\mathcal{A})$ [7].

(ii) The neutrosophic semi-interior of a neutrosophic set \mathcal{A} of a neutrosophic topological space (U, T) is the union of all NS-OS contained in \mathcal{A} and is denoted by $SNint(\mathcal{A})$ [6].

(iii) The neutrosophic α -interior of a neutrosophic set \mathcal{A} of a neutrosophic topological space (U, T) is the union of all $N\alpha$ -OS contained in \mathcal{A} and is denoted by $aNint(\mathcal{A})$ [5].

Definition 2.3:

(i) The neutrosophic pre-closure of a neutrosophic set \mathcal{A} of a neutrosophic topological space (U, T) is the intersection of all NP-CS that contain \mathcal{A} and is denoted by $PNcl(\mathcal{A})$ [7].

(ii) The neutrosophic semi-closure of a neutrosophic set \mathcal{A} of a neutrosophic topological space (U, T) is the

intersection of all NS-CS that contain \mathcal{A} and is denoted by $SNcl(\mathcal{A})$ [6].

(iii) The neutrosophic α -closure of a neutrosophic set \mathcal{A} of a neutrosophic topological space (\mathcal{U}, T) is the intersection of all $N\alpha$ -CS that contain \mathcal{A} and is denoted by $\alpha Ncl(\mathcal{A})$ [5].

Proposition 2.4 [5]:

In a neutrosophic topological space (\mathcal{U}, T) , then the following statements hold, and the equality of each statement are not true:

- (i) Every N-OS (resp. N-CS) is a $N\alpha$ -OS (resp. $N\alpha$ -CS).
- (ii) Every $N\alpha$ -OS (resp. $N\alpha$ -CS) is a NS-OS (resp. NS-CS).
- (iii) Every $N\alpha$ -OS (resp. $N\alpha$ -CS) is a NP-OS (resp. NP-CS).

Proposition 2.5 [5]:

A neutrosophic subset \mathcal{A} of a neutrosophic topological space (\mathcal{U}, T) is a $N\alpha$ -OS iff \mathcal{A} is a NS-OS and NP-OS.

Lemma 2.6:

- (i) If \mathcal{K} is a N-OS, then $SNcl(\mathcal{K}) = Nint(Ncl(\mathcal{K}))$.
- (ii) If \mathcal{A} is a neutrosophic subset of a neutrosophic topological space (\mathcal{U}, T) , then $SNint(Ncl(\mathcal{A})) = Ncl(Nint(Ncl(\mathcal{A})))$.

Proof: This follows directly from the definition 2.1) and proposition (2.4).

3. Neutrosophic Semi- α -Open Sets

In this section, we present and study the neutrosophic semi- α -open sets and some of its properties.

Definition 3.1:

A neutrosophic subset \mathcal{A} of a neutrosophic topological space (\mathcal{U}, T) is called neutrosophic semi- α -open set (briefly NS α -OS) if there exists a $N\alpha$ -OS \mathcal{H} in \mathcal{U} such that $\mathcal{H} \subseteq \mathcal{A} \subseteq Ncl(\mathcal{H})$ or equivalently if $\mathcal{A} \subseteq Ncl(\alpha Nint(\mathcal{A}))$. The family of all NS α -OS of \mathcal{U} is denoted by NS $\alpha O(\mathcal{U})$.

Definition 3.2:

The complement of NS α -OS is called a neutrosophic semi- α -closed set (briefly NS α -CS). The family of all NS α -CS of \mathcal{U} is denoted by NS $\alpha C(\mathcal{U})$.

Proposition 3.3:

It is evident by definitions that in a neutrosophic topological space (\mathcal{U}, T) , the following hold:

- (i) Every N-OS (resp. N-CS) is a NS α -OS (resp. NS α -CS).
- (ii) Every $N\alpha$ -OS (resp. $N\alpha$ -CS) is a NS α -OS (resp. NS α -CS).

The converse of the above proposition need not be true as seen from the following example.

Example 3.4:

Let $\mathcal{U} = \{u\}$, $\mathcal{A} = \{u, 0.5, 0.5, 0.4\}: u \in \mathcal{U}$,

$\mathcal{B} = \{u, 0.4, 0.5, 0.8\}: u \in \mathcal{U}$, $\mathcal{C} = \{u, 0.5, 0.6, 0.4\}: u \in \mathcal{U}$, $\mathcal{D} = \{u, 0.4, 0.6, 0.8\}: u \in \mathcal{U}$.

Then $T = \{0_N, \mathcal{A}, \mathcal{B}, \mathcal{C}, \mathcal{D}, 1_N\}$ is a neutrosophic topology on \mathcal{U} .

(i) Let $\mathcal{H} = \{u, 0.5, 0.1, 0.3\}: u \in \mathcal{U}$, $\mathcal{A} \subseteq \mathcal{H} \subseteq Ncl(\mathcal{A}) = \{u, 0.6, 0.4, 0.2\}$, the neutrosophic set \mathcal{H} is a NS α -OS but is not N-OS. It is clear that $\mathcal{H}^c = \{u, 0.5, 0.9, 0.7\}: u \in \mathcal{U}$ is a NS α -CS but is not N-CS.

(ii) Let $\mathcal{K} = \{u, 0.5, 0.1, 0.2\}: u \in \mathcal{U}$, $\mathcal{A} \subseteq \mathcal{K} \subseteq Ncl(\mathcal{A}) = \{u, 0.6, 0.4, 0.2\}$, the neutrosophic set \mathcal{K} is a NS α -OS, $\mathcal{K} \not\subseteq Nint(Ncl(Nint(\mathcal{K}))) = Nint(Ncl(\{u, 0.5, 0.5, 0.4\})) = Nint(\{u, 0.6, 0.4, 0.2\}) = \{u, 0.5, 0.5, 0.4\}$, the neutrosophic set \mathcal{K} is not $N\alpha$ -OS. It is clear that $\mathcal{K}^c = \{u, 0.5, 0.9, 0.8\}: u \in \mathcal{U}$ is a NS α -CS but is not $N\alpha$ -CS.

Remark 3.5:

The concepts of NS α -OS and NP-OS are independent, as the following examples shows.

Example 3.6:

In example (3.4), then the neutrosophic set $\mathcal{H} = \{u, 0.5, 0.1, 0.3\}: u \in \mathcal{U}$ is a NS α -OS but is not NP-OS, because $\mathcal{H} \not\subseteq Nint(Ncl(\mathcal{H})) = Nint(\{u, 0.6, 0.4, 0.2\}) = \{u, 0.5, 0.5, 0.4\}$.

Example 3.7:

Let $\mathcal{U} = \{a, b\}$, $\mathcal{A} = \{0.4, 0.8, 0.9\}, \{0.7, 0.5, 0.3\}$, $\mathcal{B} = \{0.5, 0.8, 0.6\}, \{0.8, 0.4, 0.3\}$, $\mathcal{C} = \{0.4, 0.7, 0.9\}, \{0.6, 0.4, 0.4\}$, $\mathcal{D} = \{0.5, 0.7, 0.5\}, \{0.8, 0.4, 0.6\}$.

Then $T = \{0_N, \mathcal{A}, \mathcal{B}, \mathcal{C}, \mathcal{D}, 1_N\}$ is a neutrosophic topology on \mathcal{U} .

Then the neutrosophic set $\mathcal{K} = \{1, 1, 0.3\}, \{0.7, 0.3, 0.6\}$ is a NP-OS but is not NS α -OS.

Remark 3.8:

- (i) If every N-OS is a N-CS and every nowhere neutrosophic dense set is N-CS in any neutrosophic topological space (\mathcal{U}, T) , then every NS α -OS is a N-OS.
- (ii) If every N-OS is a N-CS in any neutrosophic topological space (\mathcal{U}, T) , then every NS α -OS is a $N\alpha$ -OS.

Remark 3.9:

- (i) It is clear that every NS-OS and NP-OS of any neutrosophic topological space (\mathcal{U}, T) is a NS α -OS (by proposition (2.5) and proposition (3.3) (ii)).
- (ii) A NS α -OS in any neutrosophic topological space (\mathcal{U}, T) is a NP-OS if every N-OS of \mathcal{U} is a N-CS (from proposition (2.4) (iii) and remark (3.8) (ii)).

Theorem 3.10:

For any neutrosophic subset \mathcal{A} of a neutrosophic topological space (\mathcal{U}, T) , $\mathcal{A} \in N\alpha O(\mathcal{U})$ iff there exists a N-OS \mathcal{H} such that $\mathcal{H} \subseteq \mathcal{A} \subseteq Nint(Ncl(\mathcal{H}))$.

Proof: Let \mathcal{A} be a $N\alpha$ -OS. Hence $\mathcal{A} \subseteq Nint(Ncl(Nint(\mathcal{A})))$, so let $\mathcal{H} = Nint(\mathcal{A})$, we get $Nint(\mathcal{A}) \subseteq \mathcal{A} \subseteq Nint(Ncl(Nint(\mathcal{A})))$. Then there exists a N-OS $Nint(\mathcal{A})$ such that $\mathcal{H} \subseteq \mathcal{A} \subseteq Nint(Ncl(\mathcal{H}))$, where $\mathcal{H} = Nint(\mathcal{A})$.
 Conversely, suppose that there is a N-OS \mathcal{H} such that $\mathcal{H} \subseteq \mathcal{A} \subseteq Nint(Ncl(\mathcal{H}))$.
 To prove $\mathcal{A} \in N\alpha O(\mathcal{U})$.
 $\mathcal{H} \subseteq Nint(\mathcal{A})$ (since $Nint(\mathcal{A})$ is the largest N-OS contained in \mathcal{A}).
 Hence $Ncl(\mathcal{H}) \subseteq Nint(Ncl(\mathcal{A}))$, then $Nint(Ncl(\mathcal{H})) \subseteq Nint(Ncl(Nint(\mathcal{A})))$.
 But $\mathcal{H} \subseteq \mathcal{A} \subseteq Nint(Ncl(\mathcal{H}))$ (by hypothesis). Then $\mathcal{A} \subseteq Nint(Ncl(Nint(\mathcal{A})))$.
 Therefore, $\mathcal{A} \in N\alpha O(\mathcal{U})$.

Theorem 3.11:

For any neutrosophic subset \mathcal{A} of a neutrosophic topological space (\mathcal{U}, T) . The following properties are equivalent:
 (i) $\mathcal{A} \in NS\alpha O(\mathcal{U})$.
 (ii) There exists a N-OS say \mathcal{H} such that $\mathcal{H} \subseteq \mathcal{A} \subseteq Ncl(Nint(Ncl(\mathcal{H})))$.
 (iii) $\mathcal{A} \subseteq Ncl(Nint(Ncl(Nint(\mathcal{A}))))$.

Proof:

(i) \Rightarrow (ii) Let $\mathcal{A} \in NS\alpha O(\mathcal{U})$. Then there exists $\mathcal{K} \in N\alpha O(\mathcal{U})$, such that $\mathcal{K} \subseteq \mathcal{A} \subseteq Ncl(\mathcal{K})$. Hence there exists \mathcal{H} N-OS such that $\mathcal{H} \subseteq \mathcal{K} \subseteq Nint(Ncl(\mathcal{H}))$ (by theorem (3.10)). Therefore, $Ncl(\mathcal{H}) \subseteq Ncl(\mathcal{K}) \subseteq Ncl(Nint(Ncl(\mathcal{H})))$, implies that $Ncl(\mathcal{K}) \subseteq Ncl(Nint(Ncl(\mathcal{H})))$. Then $\mathcal{H} \subseteq \mathcal{K} \subseteq \mathcal{A} \subseteq Ncl(\mathcal{K}) \subseteq Ncl(Nint(Ncl(\mathcal{H})))$. Therefore, $\mathcal{H} \subseteq \mathcal{A} \subseteq Ncl(Nint(Ncl(\mathcal{H})))$, for some \mathcal{H} N-OS.
 (ii) \Rightarrow (iii) Suppose that there exists a N-OS \mathcal{H} such that $\mathcal{H} \subseteq \mathcal{A} \subseteq Ncl(Nint(Ncl(\mathcal{H})))$. We know that $Nint(\mathcal{A}) \subseteq \mathcal{A}$. On the other hand, $\mathcal{H} \subseteq Nint(\mathcal{A})$ (since $Nint(\mathcal{A})$ is the largest N-OS contained in \mathcal{A}). Hence $Ncl(\mathcal{H}) \subseteq Ncl(Nint(\mathcal{A}))$, then $Nint(Ncl(\mathcal{H})) \subseteq Nint(Ncl(Nint(\mathcal{A})))$, therefore $Ncl(Nint(Ncl(\mathcal{H}))) \subseteq Ncl(Nint(Ncl(Nint(\mathcal{A}))))$.
 But $\mathcal{A} \subseteq Ncl(Nint(Ncl(\mathcal{H})))$ (by hypothesis). Hence $\mathcal{A} \subseteq Ncl(Nint(Ncl(\mathcal{H}))) \subseteq Ncl(Nint(Ncl(Nint(\mathcal{A}))))$, then $\mathcal{A} \subseteq Ncl(Nint(Ncl(Nint(\mathcal{A}))))$.
 (iii) \Rightarrow (i) Let $\mathcal{A} \subseteq Ncl(Nint(Ncl(Nint(\mathcal{A}))))$.
 To prove $\mathcal{A} \in NS\alpha O(\mathcal{U})$. Let $\mathcal{K} = Nint(\mathcal{A})$; we know that $Nint(\mathcal{A}) \subseteq \mathcal{A}$. To prove $\mathcal{A} \subseteq Ncl(Nint(\mathcal{A}))$.
 Since $Nint(Ncl(Nint(\mathcal{A}))) \subseteq Ncl(Nint(\mathcal{A}))$. Hence, $Ncl(Nint(Ncl(Nint(\mathcal{A})))) \subseteq Ncl(Ncl(Nint(\mathcal{A}))) = Ncl(Nint(\mathcal{A}))$. But $\mathcal{A} \subseteq Ncl(Nint(Ncl(Nint(\mathcal{A}))))$ (by hypothesis). Hence, $\mathcal{A} \subseteq Ncl(Nint(Ncl(Nint(\mathcal{A})))) \subseteq Ncl(Nint(\mathcal{A})) \Rightarrow \mathcal{A} \subseteq Ncl(Nint(\mathcal{A}))$. Hence, there exists a N-OS say \mathcal{K} , such that $\mathcal{K} \subseteq \mathcal{A} \subseteq Ncl(\mathcal{A})$. On the other hand, \mathcal{K} is a $N\alpha$ -OS (since \mathcal{K} is a N-OS). Hence $\mathcal{A} \in NS\alpha O(\mathcal{U})$.

Corollary 3.12:

For any neutrosophic subset \mathcal{A} of a neutrosophic topological space (\mathcal{U}, T) , the following properties are equivalent:

- (i) $\mathcal{A} \in NS\alpha C(\mathcal{U})$.
- (ii) There exists a N-CS \mathcal{F} such that $Nint(Ncl(Nint(\mathcal{F}))) \subseteq \mathcal{A} \subseteq \mathcal{F}$.
- (iii) $Nint(Ncl(Nint(Ncl(\mathcal{A})))) \subseteq \mathcal{A}$.

Proof:

(i) \Rightarrow (ii) Let $\mathcal{A} \in NS\alpha C(\mathcal{U})$, then $\mathcal{A}^c \in NS\alpha O(\mathcal{U})$. Hence there is \mathcal{H} N-OS such that $\mathcal{H} \subseteq \mathcal{A}^c \subseteq Ncl(Nint(Ncl(\mathcal{H})))$ (by theorem (3.11)). Hence $(Ncl(Nint(Ncl(\mathcal{H}))))^c \subseteq \mathcal{A}^{cc} \subseteq \mathcal{H}^c$, i.e., $Nint(Ncl(Nint(\mathcal{H}^c))) \subseteq \mathcal{A} \subseteq \mathcal{H}^c$. Let $\mathcal{H}^c = \mathcal{F}$, where \mathcal{F} is a N-CS in \mathcal{U} . Then $Nint(Ncl(Nint(\mathcal{F}))) \subseteq \mathcal{A} \subseteq \mathcal{F}$, for some \mathcal{F} N-CS.
 (ii) \Rightarrow (iii) Suppose that there exists \mathcal{F} N-CS such that $Nint(Ncl(Nint(\mathcal{F}))) \subseteq \mathcal{A} \subseteq \mathcal{F}$, but $Ncl(\mathcal{A})$ is the smallest N - CS containing \mathcal{A} . Then $Ncl(\mathcal{A}) \subseteq \mathcal{F}$, and therefore: $Nint(Ncl(\mathcal{A})) \subseteq Nint(\mathcal{F}) \Rightarrow Ncl(Nint(Ncl(\mathcal{A}))) \subseteq Ncl(Nint(\mathcal{F})) \Rightarrow Nint(Ncl(Nint(Ncl(\mathcal{A})))) \subseteq Nint(Ncl(Nint(\mathcal{F}))) \subseteq \mathcal{A} \Rightarrow Nint(Ncl(Nint(Ncl(\mathcal{A})))) \subseteq \mathcal{A}$.
 (iii) \Rightarrow (i) Let $Nint(Ncl(Nint(Ncl(\mathcal{A})))) \subseteq \mathcal{A}$.
 To prove $\mathcal{A} \in NS\alpha C(\mathcal{U})$, i.e., to prove $\mathcal{A}^c \in NS\alpha O(\mathcal{U})$.
 Then $\mathcal{A}^c \subseteq (Nint(Ncl(Nint(Ncl(\mathcal{A}))))^c = Ncl(Nint(Ncl(Nint(\mathcal{A}^c))))$, but $(Nint(Ncl(Nint(Ncl(\mathcal{A}))))^c = Ncl(Nint(Ncl(Nint(\mathcal{A}^c))))$.
 Hence $\mathcal{A}^c \subseteq Ncl(Nint(Ncl(Nint(\mathcal{A}^c))))$, and therefore $\mathcal{A}^c \in NS\alpha O(\mathcal{U})$, i.e., $\mathcal{A} \in NS\alpha C(\mathcal{U})$.

Proposition 3.13:

The union of any family of $N\alpha$ -OS is a $N\alpha$ -OS.

Proof: Let $\{\mathcal{A}_i\}_{i \in \Lambda}$ be a family of $N\alpha$ -OS of \mathcal{U} .

To prove $\bigcup_{i \in \Lambda} \mathcal{A}_i$ is a $N\alpha$ -OS, i.e., $\bigcup_{i \in \Lambda} \mathcal{A}_i \subseteq Nint(Ncl(Nint(\bigcup_{i \in \Lambda} \mathcal{A}_i)))$.
 Then $\mathcal{A}_i \subseteq Nint(Ncl(Nint(\mathcal{A}_i)))$, $\forall i \in \Lambda$.
 Since $\bigcup_{i \in \Lambda} Nint(\mathcal{A}_i) \subseteq Nint(\bigcup_{i \in \Lambda} \mathcal{A}_i)$ and $\bigcup_{i \in \Lambda} Ncl(\mathcal{A}_i) \subseteq Ncl(\bigcup_{i \in \Lambda} \mathcal{A}_i)$ hold for any neutrosophic topology.

$$\begin{aligned} \text{We have } \bigcup_{i \in \Lambda} \mathcal{A}_i &\subseteq \bigcup_{i \in \Lambda} Nint(Ncl(Nint(\mathcal{A}_i))) \\ &\subseteq Nint(\bigcup_{i \in \Lambda} Ncl(Nint(\mathcal{A}_i))) \\ &\subseteq Nint(Ncl(\bigcup_{i \in \Lambda} (Nint(\mathcal{A}_i)))) \\ &\subseteq Nint(Ncl(Nint(\bigcup_{i \in \Lambda} \mathcal{A}_i))). \end{aligned}$$

Hence $\bigcup_{i \in \Lambda} \mathcal{A}_i$ is a $N\alpha$ -OS.

Theorem 3.14:

The union of any family of $NS\alpha$ -OS is a $NS\alpha$ -OS.

Proof: Let $\{\mathcal{A}_i\}_{i \in \Lambda}$ be a family of $NS\alpha$ -OS. To prove $\bigcup_{i \in \Lambda} \mathcal{A}_i$ is a $NS\alpha$ -OS. Since $\mathcal{A}_i \in NS\alpha O(\mathcal{U})$. Then there is a $N\alpha$ -OS \mathcal{B}_i such that $\mathcal{B}_i \subseteq \mathcal{A}_i \subseteq Ncl(\mathcal{B}_i)$, $\forall i \in \Lambda$. Hence $\bigcup_{i \in \Lambda} \mathcal{B}_i \subseteq \bigcup_{i \in \Lambda} \mathcal{A}_i \subseteq \bigcup_{i \in \Lambda} Ncl(\mathcal{B}_i) \subseteq Ncl(\bigcup_{i \in \Lambda} \mathcal{B}_i)$.
 But $\bigcup_{i \in \Lambda} \mathcal{B}_i \in N\alpha O(\mathcal{U})$ (by proposition (3.13)).
 Hence $\bigcup_{i \in \Lambda} \mathcal{A}_i \in NS\alpha O(\mathcal{U})$.

Corollary 3.15:

The intersection of any family of NS α -CS is a NS α -CS.
Proof: This follows directly from the theorem (3.14).

Remark 3.16:

The following diagram shows the relations among the different types of weakly neutrosophic open sets that were studied in this section:

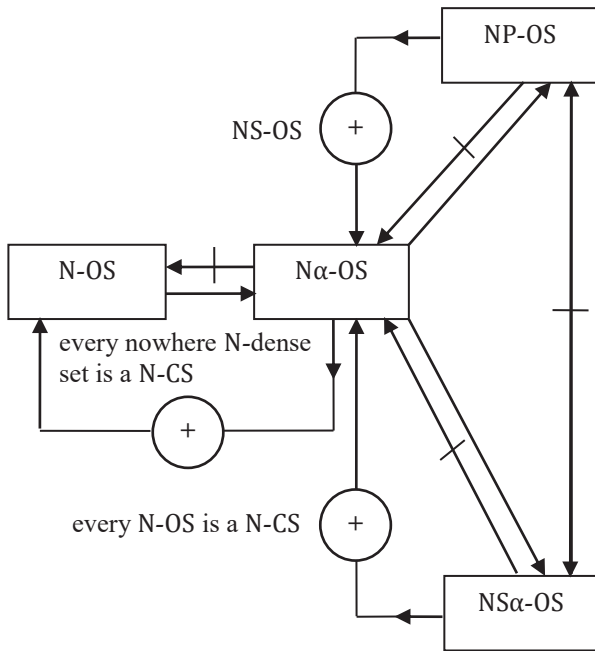

Diagram (3.1)

4. Neutrosophic Semi- α -Interior and Neutrosophic Semi- α -Closure

We present neutrosophic semi- α -interior and neutrosophic semi- α -closure and obtain some of its properties in this section.

Definition 4.1:

The union of all NS α -OS in a neutrosophic topological space (U, T) contained in \mathcal{A} is called neutrosophic semi- α -interior of \mathcal{A} and is denoted by $SaNint(\mathcal{A})$, $SaNint(\mathcal{A}) = \cup\{\mathcal{B} : \mathcal{B} \subseteq \mathcal{A}, \mathcal{B} \text{ is a NS}\alpha\text{-OS}\}$.

Definition 4.2:

The intersection of all NS α - CS in a neutrosophic topological space (U, T) containing \mathcal{A} is called neutrosophic semi- α -closure of \mathcal{A} and is denoted by $SaNcl(\mathcal{A})$, $SaNcl(\mathcal{A}) = \cap\{\mathcal{B} : \mathcal{A} \subseteq \mathcal{B}, \mathcal{B} \text{ is a NS}\alpha\text{-CS}\}$.

Proposition 4.3:

Let \mathcal{A} be any neutrosophic set in a neutrosophic topological space (U, T) , the following properties are true:
 (i) $SaNint(\mathcal{A}) = \mathcal{A}$ iff \mathcal{A} is a NS α -OS.
 (ii) $SaNcl(\mathcal{A}) = \mathcal{A}$ iff \mathcal{A} is a NS α -CS.
 (iii) $SaNint(\mathcal{A})$ is the largest NS α -OS contained in \mathcal{A} .

(iv) $SaNcl(\mathcal{A})$ is the smallest NS α -CS containing \mathcal{A} .

Proof: (i), (ii), (iii) and (iv) are obvious.

Proposition 4.4:

Let \mathcal{A} be any neutrosophic set in a neutrosophic topological space (U, T) , the following properties are true:
 (i) $SaNint(1_N - \mathcal{A}) = 1_N - (SaNcl(\mathcal{A}))$,
 (ii) $SaNcl(1_N - \mathcal{A}) = 1_N - (SaNint(\mathcal{A}))$.

Proof: (i) By definition, $SaNcl(\mathcal{A}) = \cap\{\mathcal{B} : \mathcal{A} \subseteq \mathcal{B}, \mathcal{B} \text{ is a NS}\alpha\text{-CS}\}$
 $1_N - (SaNcl(\mathcal{A})) = 1_N - \cap\{\mathcal{B} : \mathcal{A} \subseteq \mathcal{B}, \mathcal{B} \text{ is a NS}\alpha\text{-CS}\}$
 $= \cup\{1_N - \mathcal{B} : \mathcal{A} \subseteq \mathcal{B}, \mathcal{B} \text{ is a NS}\alpha\text{-CS}\}$
 $= \cup\{\mathcal{H} : \mathcal{H} \subseteq 1_N - \mathcal{A}, \mathcal{H} \text{ is a NS}\alpha\text{-OS}\}$
 $= SaNint(1_N - \mathcal{A})$.

(ii) The proof is similar to (i).

Theorem 4.5:

Let \mathcal{A} and \mathcal{B} be two neutrosophic sets in a neutrosophic topological space (U, T) . The following properties hold:
 (i) $SaNint(0_N) = 0_N$, $SaNint(1_N) = 1_N$.
 (ii) $SaNint(\mathcal{A}) \subseteq \mathcal{A}$.
 (iii) $\mathcal{A} \subseteq \mathcal{B} \Rightarrow SaNint(\mathcal{A}) \subseteq SaNint(\mathcal{B})$.
 (iv) $SaNint(\mathcal{A} \cap \mathcal{B}) \subseteq SaNint(\mathcal{A}) \cap SaNint(\mathcal{B})$.
 (v) $SaNint(\mathcal{A}) \cup SaNint(\mathcal{B}) \subseteq SaNint(\mathcal{A} \cup \mathcal{B})$.
 (vi) $SaNint(SaNint(\mathcal{A})) = SaNint(\mathcal{A})$.
Proof: (i), (ii), (iii), (iv), (v) and (vi) are obvious.

Theorem 4.6:

Let \mathcal{A} and \mathcal{B} be two neutrosophic sets in a neutrosophic topological space (U, T) . The following properties hold:
 (i) $SaNcl(0_N) = 0_N$, $SaNcl(1_N) = 1_N$.
 (ii) $\mathcal{A} \subseteq SaNcl(\mathcal{A})$.
 (iii) $\mathcal{A} \subseteq \mathcal{B} \Rightarrow SaNcl(\mathcal{A}) \subseteq SaNcl(\mathcal{B})$.
 (iv) $SaNcl(\mathcal{A} \cap \mathcal{B}) \subseteq SaNcl(\mathcal{A}) \cap SaNcl(\mathcal{B})$.
 (v) $SaNcl(\mathcal{A}) \cup SaNcl(\mathcal{B}) \subseteq SaNcl(\mathcal{A} \cup \mathcal{B})$.
 (vi) $SaNcl(SaNcl(\mathcal{A})) = SaNcl(\mathcal{A})$.

Proof: (i) and (ii) are evident.

(iii) By part (ii), $\mathcal{B} \subseteq SaNcl(\mathcal{B})$. Since $\mathcal{A} \subseteq \mathcal{B}$, we have $\mathcal{A} \subseteq SaNcl(\mathcal{B})$. But $SaNcl(\mathcal{B})$ is a NS α - CS . Thus $SaNcl(\mathcal{B})$ is a NS α -CS containing \mathcal{A} . Since $SaNcl(\mathcal{A})$ is the smallest NS α -CS containing \mathcal{A} , we have $SaNcl(\mathcal{A}) \subseteq SaNcl(\mathcal{B})$. Hence, $\mathcal{A} \subseteq \mathcal{B} \Rightarrow SaNcl(\mathcal{A}) \subseteq SaNcl(\mathcal{B})$.
 (iv) We know that $\mathcal{A} \cap \mathcal{B} \subseteq \mathcal{A}$ and $\mathcal{A} \cap \mathcal{B} \subseteq \mathcal{B}$. Therefore, by part (iii), $SaNcl(\mathcal{A} \cap \mathcal{B}) \subseteq SaNcl(\mathcal{A})$ and $SaNcl(\mathcal{A} \cap \mathcal{B}) \subseteq SaNcl(\mathcal{B})$. Hence $SaNcl(\mathcal{A} \cap \mathcal{B}) \subseteq SaNcl(\mathcal{A}) \cap SaNcl(\mathcal{B})$.

(v) Since $\mathcal{A} \subseteq \mathcal{A} \cup \mathcal{B}$ and $\mathcal{B} \subseteq \mathcal{A} \cup \mathcal{B}$, it follows from part (iii) that $SaNcl(\mathcal{A}) \subseteq SaNcl(\mathcal{A} \cup \mathcal{B})$ and $SaNcl(\mathcal{B}) \subseteq SaNcl(\mathcal{A} \cup \mathcal{B})$. Hence $SaNcl(\mathcal{A}) \cup SaNcl(\mathcal{B}) \subseteq SaNcl(\mathcal{A} \cup \mathcal{B})$.
 (vi) Since $SaNcl(\mathcal{A})$ is a NS α -CS, we have by proposition (4.3) part (ii), $SaNcl(SaNcl(\mathcal{A})) = SaNcl(\mathcal{A})$.

Proposition 4.7:

For any neutrosophic subset \mathcal{A} of a neutrosophic topological space (U, T) , then:

- (i) $Nint(\mathcal{A}) \subseteq \alpha Nint(\mathcal{A}) \subseteq SaNint(\mathcal{A}) \subseteq SaNcl(\mathcal{A}) \subseteq \alpha Ncl(\mathcal{A}) \subseteq Ncl(\mathcal{A})$.
- (ii) $Nint(SaNint(\mathcal{A})) = SaNint(Nint(\mathcal{A})) = Nint(\mathcal{A})$.
- (iii) $\alpha Nint(SaNint(\mathcal{A})) = SaNint(\alpha Nint(\mathcal{A})) = \alpha Nint(\mathcal{A})$.
- (iv) $Ncl(SaNcl(\mathcal{A})) = SaNcl(Ncl(\mathcal{A})) = Ncl(\mathcal{A})$.
- (v) $\alpha Ncl(SaNcl(\mathcal{A})) = SaNcl(\alpha Ncl(\mathcal{A})) = \alpha Ncl(\mathcal{A})$.
- (vi) $SaNcl(\mathcal{A}) = \mathcal{A} \cup Nint(Ncl(Nint(Ncl(\mathcal{A}))))$.
- (vii) $SaNint(\mathcal{A}) = \mathcal{A} \cap Ncl(Nint(Ncl(Nint(\mathcal{A}))))$.
- (viii) $Nint(Ncl(\mathcal{A})) \subseteq SaNint(SaNcl(\mathcal{A}))$.

Proof: We shall prove only (ii), (iii), (iv), (vii) and (viii).

(ii) To prove $Nint(SaNint(\mathcal{A})) = SaNint(Nint(\mathcal{A})) = Nint(\mathcal{A})$. Since $Nint(\mathcal{A})$ is a N-OS, then $Nint(\mathcal{A})$ is a NS α -OS. Hence $Nint(\mathcal{A}) = SaNint(Nint(\mathcal{A}))$ (by proposition (4.3)). Therefore:

$$Nint(\mathcal{A}) = SaNint(Nint(\mathcal{A})) \dots \dots \dots (1)$$

Since $Nint(\mathcal{A}) \subseteq SaNint(\mathcal{A}) \Rightarrow Nint(Nint(\mathcal{A})) \subseteq Nint(SaNint(\mathcal{A})) \Rightarrow Nint(\mathcal{A}) \subseteq Nint(SaNint(\mathcal{A}))$.

Also, $SaNint(\mathcal{A}) \subseteq \mathcal{A} \Rightarrow Nint(SaNint(\mathcal{A})) \subseteq Nint(\mathcal{A})$. Hence:

$$Nint(\mathcal{A}) = Nint(SaNint(\mathcal{A})) \dots \dots \dots (2)$$

Therefore by (1) and (2), we get $Nint(SaNint(\mathcal{A})) = SaNint(Nint(\mathcal{A})) = Nint(\mathcal{A})$.

(iii) To prove $\alpha Nint(SaNint(\mathcal{A})) = SaNint(\alpha Nint(\mathcal{A})) = \alpha Nint(\mathcal{A})$. Since $\alpha Nint(\mathcal{A})$ is N α -OS, therefore $\alpha Nint(\mathcal{A})$ is NS α -OS. Therefore by proposition (4.3): $\alpha Nint(\mathcal{A}) = SaNint(\alpha Nint(\mathcal{A})) \dots \dots \dots (1)$

Now, to prove $\alpha Nint(\mathcal{A}) = \alpha Nint(SaNint(\mathcal{A}))$. Since $\alpha Nint(\mathcal{A}) \subseteq SaNint(\mathcal{A}) \Rightarrow \alpha Nint(\alpha Nint(\mathcal{A})) \subseteq \alpha Nint(SaNint(\mathcal{A})) \Rightarrow \alpha Nint(\mathcal{A}) \subseteq \alpha Nint(SaNint(\mathcal{A}))$.

Also, $SaNint(\mathcal{A}) \subseteq \mathcal{A} \Rightarrow \alpha Nint(SaNint(\mathcal{A})) \subseteq \alpha Nint(\mathcal{A})$. Hence:

$$\alpha Nint(\mathcal{A}) = \alpha Nint(SaNint(\mathcal{A})) \dots \dots \dots (2)$$

Therefore by (1) and (2), we get $\alpha Nint(SaNint(\mathcal{A})) = SaNint(\alpha Nint(\mathcal{A})) = \alpha Nint(\mathcal{A})$.

(iv) To prove $Ncl(SaNcl(\mathcal{A})) = SaNcl(Ncl(\mathcal{A})) = Ncl(\mathcal{A})$. We know that $Ncl(\mathcal{A})$ is a N-CS, so it is NS α -CS. Hence by proposition (4.3), we have:

$$Ncl(\mathcal{A}) = SaNcl(Ncl(\mathcal{A})) \dots \dots \dots (1)$$

To prove $Ncl(\mathcal{A}) = Ncl(SaNcl(\mathcal{A}))$.

Since $SaNcl(\mathcal{A}) \subseteq Ncl(\mathcal{A})$ (by part (i)).

Then $Ncl(SaNcl(\mathcal{A})) \subseteq Ncl(Ncl(\mathcal{A})) = Ncl(\mathcal{A}) \Rightarrow Ncl(SaNcl(\mathcal{A})) \subseteq Ncl(\mathcal{A})$. Since $\mathcal{A} \subseteq SaNcl(\mathcal{A}) \subseteq Ncl(SaNcl(\mathcal{A}))$, then $\mathcal{A} \subseteq Ncl(SaNcl(\mathcal{A}))$. Hence

$$Ncl(\mathcal{A}) \subseteq Ncl(Ncl(SaNcl(\mathcal{A}))) = Ncl(SaNcl(\mathcal{A})) \Rightarrow Ncl(\mathcal{A}) \subseteq Ncl(SaNcl(\mathcal{A})) \text{ and therefore: } Ncl(\mathcal{A}) = Ncl(SaNcl(\mathcal{A})) \dots \dots \dots (2)$$

Now, by (1) and (2), we get that $Ncl(SaNcl(\mathcal{A})) = SaNcl(Ncl(\mathcal{A}))$.

Hence $Ncl(SaNcl(\mathcal{A})) = SaNcl(Ncl(\mathcal{A})) = Ncl(\mathcal{A})$.

(vii) To prove $SaNint(\mathcal{A}) = \mathcal{A} \cap Ncl(Nint(Ncl(Nint(\mathcal{A}))))$. Since $SaNint(\mathcal{A}) \in NS\alpha O(\mathcal{U}) \Rightarrow SaNint(\mathcal{A}) \subseteq Ncl(Nint(Ncl(Nint(SaNint(\mathcal{A}))))$
 $= Ncl(Nint(Ncl(Nint(\mathcal{A}))))$ (by part (ii)).

Hence $SaNint(\mathcal{A}) \subseteq Ncl(Nint(Ncl(Nint(\mathcal{A}))))$, also $SaNint(\mathcal{A}) \subseteq \mathcal{A}$. Then:

$$SaNint(\mathcal{A}) \subseteq \mathcal{A} \cap Ncl(Nint(Ncl(Nint(\mathcal{A})))) \dots \dots \dots (1)$$

To prove $\mathcal{A} \cap Ncl(Nint(Ncl(Nint(\mathcal{A}))))$ is a NS α -OS contained in \mathcal{A} .

It is clear that $\mathcal{A} \cap Ncl(Nint(Ncl(Nint(\mathcal{A})))) \subseteq Ncl(Nint(Ncl(Nint(\mathcal{A}))))$ and also it is clear that $Nint(\mathcal{A}) \subseteq Ncl(Nint(\mathcal{A})) \Rightarrow Nint(Nint(\mathcal{A})) \subseteq Nint(Ncl(Nint(\mathcal{A}))) \Rightarrow Nint(\mathcal{A}) \subseteq Nint(Ncl(Nint(\mathcal{A}))) \Rightarrow Ncl(Nint(\mathcal{A})) \subseteq Ncl(Nint(Ncl(Nint(\mathcal{A})))$ and $Nint(\mathcal{A}) \subseteq Ncl(Nint(\mathcal{A})) \Rightarrow Nint(\mathcal{A}) \subseteq Ncl(Nint(Ncl(Nint(\mathcal{A}))))$ and $Nint(\mathcal{A}) \subseteq \mathcal{A} \Rightarrow Nint(\mathcal{A}) \subseteq \mathcal{A} \cap Ncl(Nint(Ncl(Nint(\mathcal{A}))))$.

We get $Nint(\mathcal{A}) \subseteq \mathcal{A} \cap Ncl(Nint(Ncl(Nint(\mathcal{A})))) \subseteq Ncl(Nint(Ncl(Nint(\mathcal{A}))))$.

Hence $\mathcal{A} \cap Ncl(Nint(Ncl(Nint(\mathcal{A}))))$ is a NS α -OS (by proposition (4.3)). Also, $\mathcal{A} \cap Ncl(Nint(Ncl(Nint(\mathcal{A}))))$ is contained in \mathcal{A} . Then $\mathcal{A} \cap Ncl(Nint(Ncl(Nint(\mathcal{A})))) \subseteq SaNint(\mathcal{A})$ (since $SaNint(\mathcal{A})$ is the largest NS α -OS contained in \mathcal{A}). Hence:

$$\mathcal{A} \cap Ncl(Nint(Ncl(Nint(\mathcal{A})))) \subseteq SaNint(\mathcal{A}) \dots \dots \dots (2)$$

By (1) and (2), $SaNint(\mathcal{A}) = \mathcal{A} \cap Ncl(Nint(Ncl(Nint(\mathcal{A}))))$.

(viii) To prove that $Nint(Ncl(\mathcal{A})) \subseteq SaNint(SaNcl(\mathcal{A}))$.

Since $SaNcl(\mathcal{A})$ is a NS α -CS, therefore $Nint(Ncl(Nint(Ncl(SaNcl(\mathcal{A})))) \subseteq SaNcl(\mathcal{A})$ (by corollary (3.12)). Hence $Nint(Ncl(\mathcal{A})) \subseteq Nint(Ncl(Nint(Ncl(\mathcal{A}))) \subseteq SaNcl(\mathcal{A})$ (by part (iv)).

Therefore, $SaNint(Nint(Ncl(\mathcal{A}))) \subseteq$

$$SaNint(SaNcl(\mathcal{A})) \Rightarrow$$

$$Nint(Ncl(\mathcal{A})) \subseteq SaNint(SaNcl(\mathcal{A})) \text{ (by part (ii)).}$$

Theorem 4.8:

For any neutrosophic subset \mathcal{A} of a neutrosophic topological space (\mathcal{U}, T) . The following properties are equivalent:

- (i) $\mathcal{A} \in NS\alpha O(\mathcal{U})$.
- (ii) $\mathcal{H} \subseteq \mathcal{A} \subseteq Ncl(Nint(Ncl(\mathcal{H})))$, for some N-OS \mathcal{H} .
- (iii) $\mathcal{H} \subseteq \mathcal{A} \subseteq SNint(Ncl(\mathcal{H}))$, for some N-OS \mathcal{H} .
- (iv) $\mathcal{A} \subseteq SNint(Ncl(Nint(\mathcal{A})))$.

Proof:

(i) \Rightarrow (ii) Let $\mathcal{A} \in NS\alpha O(\mathcal{U})$, then $\mathcal{A} \subseteq Ncl(Nint(Ncl(Nint(\mathcal{A}))))$ and $Nint(\mathcal{A}) \subseteq \mathcal{A}$. Hence $\mathcal{H} \subseteq \mathcal{A} \subseteq Ncl(Nint(Ncl(\mathcal{H})))$, where $\mathcal{H} = Nint(\mathcal{A})$.
 (ii) \Rightarrow (iii) Suppose $\mathcal{H} \subseteq \mathcal{A} \subseteq Ncl(Nint(Ncl(\mathcal{H})))$, for some N-OS \mathcal{H} .

But $SNint(Ncl(\mathcal{H})) = Ncl(Nint(Ncl(\mathcal{H})))$ (by lemma (2.6)).

Then $\mathcal{H} \subseteq \mathcal{A} \subseteq SNint(Ncl(\mathcal{H}))$, for some N-OS \mathcal{H} .

(iii) \Rightarrow (iv) Suppose that $\mathcal{H} \subseteq \mathcal{A} \subseteq SNint(Ncl(\mathcal{H}))$, for some N-OS \mathcal{H} . Since \mathcal{H} is a N-OS contained in \mathcal{A} .

Then $\mathcal{H} \subseteq Nint(\mathcal{A}) \Rightarrow Ncl(\mathcal{H}) \subseteq Ncl(Nint(\mathcal{A}))$

$\Rightarrow SNint(Ncl(\mathcal{H})) \subseteq SNint(Ncl(Nint(\mathcal{A})))$.

But $\mathcal{A} \subseteq SNint(Ncl(\mathcal{H}))$ (by hypothesis), then

$\mathcal{A} \subseteq SNint(Ncl(Nint(\mathcal{A})))$.

(iv) \Rightarrow (i) Let $\mathcal{A} \subseteq SNint(Ncl(Nint(\mathcal{A})))$. But

$SNint(Ncl(Nint(\mathcal{A}))) = Ncl(Nint(Ncl(Nint(\mathcal{A}))))$

(by lemma (2.6)). Hence $\mathcal{A} \subseteq Ncl(Nint(Ncl(Nint(\mathcal{A}))))$

$\Rightarrow \mathcal{A} \in NS\alpha O(\mathcal{U})$.

Corollary 4.9:

For any neutrosophic subset \mathcal{B} of a neutrosophic topological space (\mathcal{U}, T) , the following properties are equivalent:

(i) $\mathcal{B} \in NS\alpha C(\mathcal{U})$.

(ii) $Nint(Ncl(Nint(\mathcal{F}))) \subseteq \mathcal{B} \subseteq \mathcal{F}$, for some \mathcal{F} N-CS.

(iii) $SNcl(Nint(\mathcal{F})) \subseteq \mathcal{B} \subseteq \mathcal{F}$, for some \mathcal{F} N-CS.

(iv) $SNcl(Nint(Ncl(\mathcal{B}))) \subseteq \mathcal{B}$.

Proof:

(i) \Rightarrow (ii) Let $\mathcal{B} \in NS\alpha C(\mathcal{U}) \Rightarrow$

$Nint(Ncl(Nint(Ncl(\mathcal{B})))) \subseteq \mathcal{B}$ (by corollary (3.12))

and $\mathcal{B} \subseteq Ncl(\mathcal{B})$. Hence we get

$Nint(Ncl(Nint(Ncl(\mathcal{B})))) \subseteq \mathcal{B} \subseteq Ncl(\mathcal{B})$.

Therefore $Nint(Ncl(Nint(\mathcal{F}))) \subseteq \mathcal{B} \subseteq \mathcal{F}$, where $\mathcal{F} = Ncl(\mathcal{B})$.

(ii) \Rightarrow (iii) Let $Nint(Ncl(Nint(\mathcal{F}))) \subseteq \mathcal{B} \subseteq \mathcal{F}$, for some \mathcal{F} N-CS. But $Nint(Ncl(Nint(\mathcal{F}))) = SNcl(Nint(\mathcal{F}))$ (by lemma (2.6)). Hence $SNcl(Nint(\mathcal{F})) \subseteq \mathcal{B} \subseteq \mathcal{F}$, for some \mathcal{F} N-CS.

(iii) \Rightarrow (iv) Let $SNcl(Nint(\mathcal{F})) \subseteq \mathcal{B} \subseteq \mathcal{F}$, for some \mathcal{F} N-CS. Since $\mathcal{B} \subseteq \mathcal{F}$ (by hypothesis), hence $Ncl(\mathcal{B}) \subseteq \mathcal{F} \Rightarrow Nint(Ncl(\mathcal{B})) \subseteq Nint(\mathcal{F}) \Rightarrow SNcl(Nint(Ncl(\mathcal{B}))) \subseteq SNcl(Nint(\mathcal{F})) \subseteq \mathcal{B} \Rightarrow SNcl(Nint(Ncl(\mathcal{B}))) \subseteq \mathcal{B}$.

(iv) \Rightarrow (i) Let $SNcl(Nint(Ncl(\mathcal{B}))) \subseteq \mathcal{B}$.

But $SNcl(Nint(Ncl(\mathcal{B}))) = Nint(Ncl(Nint(Ncl(\mathcal{B}))))$ (by lemma (2.6)). Hence $Nint(Ncl(Nint(Ncl(\mathcal{B})))) \subseteq \mathcal{B} \Rightarrow \mathcal{B} \in NS\alpha C(\mathcal{U})$.

5. Conclusion

In this work, we have defined new class of neutrosophic open sets called neutrosophic semi- α -open sets and studied their fundamental properties in neutrosophic topological spaces. The neutrosophic semi- α -open sets can be used to derive a new decomposition of neutrosophic continuity, neutrosophic compactness, and neutrosophic connectedness.

References

[1] A.A. Salama and S.A. Alblowi. Neutrosophic set and neutrosophic topological spaces. IOSR Journal of Mathematics,3 (4). 2012), .31-35.

[2] F. Smarandache, A unifying field in logics: Neutrosophic Logic. Neutrosophy, neutrosophic set, neutrosophic probability. American Research Press, Rehoboth, NM, (1999).

[3] F. Smarandache. Neutrosophy and neutrosophic logic. In: F. Smarandache (Ed.), Neutrosophy, neutrosophic logic, set, probability, and statistics. Proceedings of the International Conference, University of New Mexico, Gallup, NM 87301, USA (2002).

[4] G.B. Navalagi. Definition bank in general topology. Topology Atlas Preprint 449, 2000.

[5] I. Arokiarani, R. Dhavaseelan, S. Jafari and M. Parimala. On some new notions and functions in neutrosophic topological spaces. Neutrosophic Sets and Systems, 16(2017), 16-19.

[6] P. Iswarya and K. Bageerathi, On neutrosophic semi-open sets in neutrosophic topological spaces, International Journal of Mathematics Trends and Technology, 37(3) (2016),214-223.

[7] V. Venkateswara Rao and Y. Srinivasa Rao, Neutrosophic Pre-open sets and pre-closed sets in neutrosophic topology, International Journal of ChemTech Research, 10 (10) (2017),449-458.

On Neutrosophic $\alpha\psi$ -Closed Sets

Mani Parimala, Florentin Smarandache, Saeid Jafari, Ramalingam Udhayakumar

Mani Parimala, Florentin Smarandache, Saeid Jafari, Ramalingam Udhayakumar (2018).
On Neutrosophic $\alpha\psi$ -Closed Sets. *Information* 2018, 9, 103; DOI: 10.3390/info9050103

Abstract: The aim of this paper is to introduce the concept of $\alpha\psi$ -closed sets in terms of neutrosophic topological spaces. We also study some of the properties of neutrosophic $\alpha\psi$ -closed sets. Further, we introduce continuity and contra continuity for the introduced set. The two functions and their relations are studied via a neutrosophic point set.

Keywords: neutrosophic topology; neutrosophic $\alpha\psi$ -closed set; neutrosophic $\alpha\psi$ -continuous function; neutrosophic contra $\alpha\psi$ -continuous mappings

1. Introduction

Zadeh [1] introduced and studied truth (t), the degree of membership, and defined the fuzzy set theory. The falsehood (f), the degree of nonmembership, was introduced by Atanassov [2–4] in an intuitionistic fuzzy set. Coker [5] developed intuitionistic fuzzy topology. Neutrality (i), the degree of indeterminacy, as an independent concept, was introduced by Smarandache [6,7] in 1998. He also defined the neutrosophic set on three components $(t, f, i) = (\text{truth}, \text{falsehood}, \text{indeterminacy})$. The Neutrosophic crisp set concept was converted to neutrosophic topological spaces by Salama et al. in [8]. This opened up a wide range of investigation in terms of neutrosophic topology and its application in decision-making algorithms. Arokiarani et al. [9] introduced and studied α -open sets in neutrosophic topological spaces. Devi et al. [10–12] introduced $\alpha\psi$ -closed sets in general topology, fuzzy topology, and intuitionistic fuzzy topology. In this article, the neutrosophic $\alpha\psi$ -closed sets are introduced in neutrosophic topological space. Moreover, we introduce and investigate neutrosophic $\alpha\psi$ -continuous and neutrosophic contra $\alpha\psi$ -continuous mappings.

2. Preliminaries

Let neutrosophic topological space (NTS) be (X, τ) . Each neutrosophic set (NS) in (X, τ) is called a neutrosophic open set (NOS), and its complement is called a neutrosophic open set (NOS).

We provide some of the basic definitions in neutrosophic sets. These are very useful in the sequel.

Definition 1. [6] A neutrosophic set (NS) A is an object of the following form

$$U = \{ \langle x, \mu_U(x), \nu_U(x), \omega_U(x) \rangle : x \in X \}$$

where the mappings $\mu_U : X \rightarrow I$, $\nu_U : X \rightarrow I$, and $\omega_U : X \rightarrow I$ denote the degree of membership (namely $\mu_U(x)$), the degree of indeterminacy (namely $\nu_U(x)$), and the degree of nonmembership (namely $\omega_U(x)$) for each element $x \in X$ to the set U , respectively, and $0 \leq \mu_U(x) + \nu_U(x) + \omega_U(x) \leq 3$ for each $a \in X$.

Definition 2. [6] Let U and V be NSs of the form $U = \{\langle a, \mu_U(x), \nu_U(x), \omega_U(x) \rangle : a \in X\}$ and $V = \{\langle x, \mu_V(x), \nu_V(x), \omega_V(x) \rangle : x \in X\}$. Then

- (i) $U \subseteq V$ if and only if $\mu_U(x) \leq \mu_V(x)$, $\nu_U(x) \geq \nu_V(x)$ and $\omega_U(x) \geq \omega_V(x)$;
- (ii) $\bar{U} = \{\langle x, \nu_U(x), \mu_U(x), \omega_U(x) \rangle : x \in X\}$;
- (iii) $U \cap V = \{\langle x, \mu_U(x) \wedge \mu_V(x), \nu_U(x) \vee \nu_V(x), \omega_U(x) \vee \omega_V(x) \rangle : x \in X\}$;
- (iv) $U \cup V = \{\langle x, \mu_U(x) \vee \mu_V(x), \nu_U(x) \wedge \nu_V(x), \omega_U(x) \wedge \omega_V(x) \rangle : x \in X\}$.

We will use the notation $U = \langle x, \mu_U, \nu_U, \omega_U \rangle$ instead of $U = \{\langle x, \mu_U(x), \nu_U(x), \omega_U(x) \rangle : x \in X\}$. The NSs 0_{\sim} and 1_{\sim} are defined by $0_{\sim} = \{\langle x, 0, 1, 1 \rangle : x \in X\}$ and $1_{\sim} = \{\langle x, 1, 0, 0 \rangle : x \in X\}$.

Let $r, s, t \in [0, 1]$ such that $r + s + t \leq 3$. A neutrosophic point (NP) $p_{(r,s,t)}$ is neutrosophic set defined by

$$p_{(r,s,t)}(x) = \begin{cases} (r, s, t)(x) & \text{if } x = p \\ (0, 1, 1) & \text{otherwise.} \end{cases}$$

Let f be a mapping from an ordinary set X into an ordinary set Y . If $V = \{\langle y, \mu_V(y), \nu_V(y), \omega_V(y) \rangle : y \in Y\}$ is an NS in Y , then the inverse image of V under f is an NS defined by

$$f^{-1}(V) = \{\langle x, f^{-1}(\mu_V)(x), f^{-1}(\nu_V)(x), f^{-1}(\omega_V)(x) \rangle : x \in X\}.$$

The image of NS $U = \{\langle y, \mu_U(y), \nu_U(y), \omega_U(y) \rangle : y \in Y\}$ under f is an NS defined by $f(U) = \{\langle y, f(\mu_U)(y), f(\nu_U)(y), f(\omega_U)(y) \rangle : y \in Y\}$ where

$$f(\mu_U)(y) = \begin{cases} \sup_{x \in f^{-1}(y)} \mu_U(x), & \text{if } f^{-1}(y) \neq \emptyset \\ 0 & \text{otherwise} \end{cases}$$

$$f(\nu_U)(y) = \begin{cases} \inf_{x \in f^{-1}(y)} \nu_U(x), & \text{if } f^{-1}(y) \neq \emptyset \\ 1 & \text{otherwise} \end{cases}$$

$$f(\omega_U)(y) = \begin{cases} \inf_{x \in f^{-1}(y)} \omega_U(x), & \text{if } f^{-1}(y) \neq \emptyset \\ 1 & \text{otherwise} \end{cases}$$

for each $y \in Y$.

Definition 3. [8] A neutrosophic topology (NT) in a nonempty set X is a family τ of NSs in X satisfying the following axioms:

- (NT1) $0_{\sim}, 1_{\sim} \in \tau$;
- (NT2) $G_1 \cap G_2 \in \tau$ for any $G_1, G_2 \in \tau$;
- (NT3) $\cup G_i \in \tau$ for any arbitrary family $\{G_i : i \in J\} \subseteq \tau$.

Definition 4. [8] Let U be an NS in NTS X . Then

$Nint(U) = \cup \{O : O \text{ is an NOS in } X \text{ and } O \subseteq U\}$ is called a neutrosophic interior of U ;

$Ncl(U) = \cap \{O : O \text{ is an NCS in } X \text{ and } O \supseteq U\}$ is called a neutrosophic closure of U .

Definition 5. [8] Let $p_{(r,s,t)}$ be an NP in NTS X . An NS U in X is called a neutrosophic neighborhood (NN) of $p_{(r,s,t)}$ if there exists an NOS V in X such that $p_{(r,s,t)} \in V \subseteq U$.

Definition 6. [9] A subset U of a neutrosophic space (X, τ) is called

1. a neutrosophic pre-open set if $U \subseteq Nint(Ncl(U))$, and a neutrosophic pre-closed set if $Ncl(Nint(U)) \subseteq U$,
2. a neutrosophic semi-open set if $U \subseteq Ncl(Nint(U))$, and a neutrosophic semi-closed set if $Nint(Ncl(U)) \subseteq U$,
3. a neutrosophic α -open set if $U \subseteq Nint(Ncl(Nint(U)))$, and a neutrosophic α -closed set if $Ncl(Nint(Ncl(U))) \subseteq U$.

The pre-closure (respectively, semi-closure and α -closure) of a subset U of a neutrosophic space (X, τ) is the intersection of all pre-closed (respectively, semi-closed, α -closed) sets that contain U and is denoted by $Npcl(U)$ (respectively, $Nscl(U)$ and $Nacl(U)$).

Definition 7. A subset A of a neutrosophic topological space (X, τ) is called

1. a neutrosophic semi-generalized closed (briefly, Nsg -closed) set if $Nscl(U) \subseteq G$ whenever $U \subseteq G$ and G is neutrosophic semi-open in (X, τ) ;
2. a neutrosophic $N\psi$ -closed set if $Nscl(U) \subseteq G$ whenever $U \subseteq G$ and G is Nsg -open in (X, τ) .

3. On Neutrosophic $\alpha\psi$ -Closed Sets

Definition 8. A neutrosophic $\alpha\psi$ -closed ($N\alpha\psi$ -closed) set is defined as if $N\psi cl(U) \subseteq G$ whenever $U \subseteq G$ and G is an $N\alpha$ -open set in (X, τ) . Its complement is called a neutrosophic $\alpha\psi$ -open ($N\alpha\psi$ -open) set.

Definition 9. Let U be an NS in NTS X . Then

$N\alpha\psi int(U) = \cup \{O : O \text{ is an } N\alpha\psi OS \text{ in } X \text{ and } O \subseteq U\}$ is said to be a neutrosophic $\alpha\psi$ -interior of U ;
 $N\alpha\psi cl(U) = \cap \{O : O \text{ is an } N\alpha\psi CS \text{ in } X \text{ and } O \supseteq U\}$ is said to be a neutrosophic $\alpha\psi$ -closure of U .

Theorem 1. All $N\alpha$ -closed sets and N -closed sets are $N\alpha\psi$ -closed sets.

Proof. Let U be an $N\alpha$ -closed set, then $U = Nacl(U)$. Let $U \subseteq G$, where G is $N\alpha$ -open. Since U is $N\alpha$ -closed, $N\psi cl(U) \subseteq Nacl(U) \subseteq G$. Thus, U is $N\alpha\psi$ -closed. \square

Theorem 2. Every N semi-closed set in a neutrosophic set is an $N\alpha\psi$ -closed set.

Proof. Let U be an N semi-closed set in (X, τ) , then $U = Nscl(U)$. Let $U \subseteq G$, where G is $N\alpha$ -open in (X, τ) . Since U is N semi-closed, $N\psi cl(U) \subseteq Nscl(U) \subseteq G$. This shows that U is $N\alpha\psi$ -closed set.

The converses of the above theorems are not true, as can be seen by the following counter example. \square

Example 1. Let $X = \{u, v, w\}$ and neutrosophic sets G_1, G_2, G_3, G_4 be defined by

$$\begin{aligned} G_1 &= \langle x, (\frac{u}{0.3}, \frac{v}{0.4}, \frac{w}{0.2}), (\frac{u}{0.5}, \frac{v}{0.1}, \frac{w}{0.2}), (\frac{u}{0.2}, \frac{v}{0.5}, \frac{w}{0.6}) \rangle \\ G_2 &= \langle x, (\frac{u}{0.6}, \frac{v}{0.3}, \frac{w}{0.4}), (\frac{u}{0.1}, \frac{v}{0.5}, \frac{w}{0.1}), (\frac{u}{0.3}, \frac{v}{0.2}, \frac{w}{0.5}) \rangle \\ G_3 &= \langle x, (\frac{u}{0.6}, \frac{v}{0.4}, \frac{w}{0.4}), (\frac{u}{0.1}, \frac{v}{0.1}, \frac{w}{0.1}), (\frac{u}{0.2}, \frac{v}{0.2}, \frac{w}{0.5}) \rangle \\ G_4 &= \langle x, (\frac{u}{0.3}, \frac{v}{0.3}, \frac{w}{0.2}), (\frac{u}{0.5}, \frac{v}{0.5}, \frac{w}{0.2}), (\frac{u}{0.3}, \frac{v}{0.5}, \frac{w}{0.6}) \rangle \\ G_5 &= \langle x, (\frac{u}{0.3}, \frac{v}{0.3}, \frac{w}{0.3}), (\frac{u}{0.5}, \frac{v}{0.5}, \frac{w}{0.4}), (\frac{u}{0.3}, \frac{v}{0.5}, \frac{w}{0.3}) \rangle \\ G_6 &= \langle x, (\frac{u}{0.6}, \frac{v}{0.4}, \frac{w}{0.5}), (\frac{u}{0.1}, \frac{v}{0.3}, \frac{w}{0.1}), (\frac{u}{0.3}, \frac{v}{0.3}, \frac{w}{0.4}) \rangle \\ G_7 &= \langle x, (\frac{u}{0.2}, \frac{v}{0.3}, \frac{w}{0.3}), (\frac{u}{0.5}, \frac{v}{0.5}, \frac{w}{0.2}), (\frac{u}{0.3}, \frac{v}{0.3}, \frac{w}{0.5}) \rangle. \end{aligned}$$

Let $\tau = \{0_{\sim}, G_1, G_2, G_3, G_4, 1_{\sim}\}$. Here, G_6 is an $N\alpha$ open set, and $N\psi cl(G_5) \subseteq G_6$. Then G_5 is $N\alpha\psi$ -closed in (X, τ) but is not $N\alpha$ -closed; thus, it is not N -closed and G_7 is $N\alpha\psi$ -closed in (X, τ) , but not N semi-closed.

Theorem 3. Let (X, τ) be an NTS and let $U \in NS(X)$. If U is an $N\alpha\psi$ -closed set and $U \subseteq V \subseteq N\psi cl(U)$, then V is an $N\alpha\psi$ -closed set.

Proof. Let G be an $N\alpha$ -open set such that $V \subseteq G$. Since $U \subseteq V$, then $U \subseteq G$. But U is $N\alpha\psi$ -closed, so $N\psi cl(U) \subseteq G$, since $V \subseteq N\psi cl(U)$ and $N\psi cl(V) \subseteq N\psi cl(U)$ and hence $N\psi cl(V) \subseteq G$. Therefore V is an $N\alpha\psi$ -closed set. \square

Theorem 4. Let U be an $N\alpha\psi$ -open set in X and $N\psi int(U) \subseteq V \subseteq U$, then V is $N\alpha\psi$ -open.

Proof. Suppose U is $N\alpha\psi$ -open in X and $N\psi int(U) \subseteq V \subseteq U$. Then \bar{U} is $N\alpha\psi$ -closed and $\bar{U} \subseteq \bar{V} \subseteq N\psi cl(\bar{U})$. Then \bar{U} is an $N\alpha\psi$ -closed set by Theorem 3.5. Hence, V is an $N\alpha\psi$ -open set in X . \square

Theorem 5. An NS U in an NTS (X, τ) is an $N\alpha\psi$ -open set if and only if $V \subseteq N\psi int(U)$ whenever V is an $N\alpha$ -closed set and $V \subseteq U$.

Proof. Let U be an $N\alpha\psi$ -open set and let V be an $N\alpha$ -closed set such that $V \subseteq U$. Then $\bar{U} \subseteq \bar{V}$ and hence $N\psi cl(\bar{U}) \subseteq \bar{V}$, since \bar{U} is $N\alpha\psi$ -closed. But $N\psi cl(\bar{U}) = \overline{N\psi int(U)}$, so $V \subseteq N\psi int(U)$. Conversely, suppose that the condition is satisfied. Then $\overline{N\psi int(U)} \subseteq \bar{V}$ whenever \bar{V} is an $N\alpha$ -open set and $\bar{U} \subseteq \bar{V}$. This implies that $N\psi cl(\bar{U}) \subseteq \bar{V} = G$, where G is $N\alpha$ -open and $\bar{U} \subseteq G$. Therefore, \bar{U} is $N\alpha\psi$ -closed and hence U is $N\alpha\psi$ -open. \square

Theorem 6. Let U be an $N\alpha\psi$ -closed subset of (X, τ) . Then $N\psi cl(U) - U$ does not contain any non-empty $N\alpha\psi$ -closed set.

Proof. Assume that U is an $N\alpha\psi$ -closed set. Let F be a non-empty $N\alpha\psi$ -closed set, such that $F \subseteq N\psi cl(U) - U = N\psi cl(U) \cap \bar{U}$. i.e., $F \subseteq N\psi cl(U)$ and $F \subseteq \bar{U}$. Therefore, $U \subseteq \bar{F}$. Since \bar{F} is an $N\alpha\psi$ -open set, $N\psi cl(U) \subseteq \bar{F} \Rightarrow F \subseteq (N\psi cl(U) - U) \cap \overline{N\psi cl(U)} \subseteq N\psi cl(U) \cap \overline{N\psi cl(U)}$. i.e., $F \subseteq \emptyset$. Therefore, F is empty. \square

Corollary 1. Let U be an $N\alpha\psi$ -closed set of (X, τ) . Then $N\psi cl(U) - U$ does not contain any non-empty N -closed set.

Proof. The proof follows from the Theorem 3.9. \square

Theorem 7. If U is both $N\psi$ -open and $N\alpha\psi$ -closed, then U is $N\psi$ -closed.

Proof. Since U is both an $N\psi$ -open and $N\alpha\psi$ -closed set in X , then $N\psi cl(U) \subseteq U$. We also have $U \subseteq N\psi cl(U)$. Thus, $N\psi cl(U) = U$. Therefore, U is an $N\psi$ -closed set in X . \square

4. On Neutrosophic $\alpha\psi$ -Continuity and Neutrosophic Contra $\alpha\psi$ -Continuity

Definition 10. A function $f : X \rightarrow Y$ is said to be a neutrosophic $\alpha\psi$ -continuous (briefly, $N\alpha\psi$ -continuous) function if the inverse image of every open set in Y is an $N\alpha\psi$ -open set in X .

Theorem 8. Let $g : (X, \tau) \rightarrow (Y, \sigma)$ be a function. Then the following conditions are equivalent.

- (i) g is $N\alpha\psi$ -continuous;
- (ii) The inverse $f^{-1}(U)$ of each N -open set U in Y is $N\alpha\psi$ -open set in X .

Proof. The proof is obvious, since $g^{-1}(\bar{U}) = \overline{g^{-1}(U)}$ for each N -open set U of Y . \square

Theorem 9. If $g : (X, \tau) \rightarrow (Y, \sigma)$ is an $N\alpha\psi$ -continuous mapping, then the following statements hold:

- (i) $g(N\alpha\psi Ncl(U)) \subseteq Ncl(g(U))$, for all neutrosophic sets U in X ;

(ii) $N\alpha\psi Ncl(g^{-1}(V)) \subseteq g^{-1}(Ncl(V))$, for all neutrosophic sets V in Y .

Proof.

- (i) Since $Ncl(g(U))$ is a neutrosophic closed set in Y and g is $N\alpha\psi$ -continuous, then $g^{-1}(Ncl(g(U)))$ is $N\alpha\psi$ -closed in X . Now, since $U \subseteq g^{-1}(Ncl(g(U)))$, $N\alpha\psi cl(U) \subseteq g^{-1}(Ncl(g(U)))$. Therefore, $g(N\alpha\psi Ncl(U)) \subseteq Ncl(g(U))$.
- (ii) By replacing U with V in (i), we obtain $g(N\alpha\psi cl(g^{-1}(V))) \subseteq Ncl(g(g^{-1}(V))) \subseteq Ncl(V)$. Hence, $N\alpha\psi cl(g^{-1}(V)) \subseteq g^{-1}(Ncl(V))$.

□

Theorem 10. Let g be a function from an NTS (X, τ) to an NTS (Y, σ) . Then the following statements are equivalent.

- (i) g is a neutrosophic $\alpha\psi$ -continuous function;
- (ii) For every NP $p_{(r,s,t)} \in X$ and each NN U of $g(p_{(r,s,t)})$, there exists an $N\alpha\psi$ -open set V such that $p_{(r,s,t)} \in V \subseteq g^{-1}(U)$.
- (iii) For every NP $p_{(r,s,t)} \in X$ and each NN U of $g(p_{(r,s,t)})$, there exists an $N\alpha\psi$ -open set V such that $p_{(r,s,t)} \in V$ and $g(V) \subseteq U$.

Proof. (i) \Rightarrow (ii). If $p_{(r,s,t)}$ is an NP in X and if U is an NN of $g(p_{(r,s,t)})$, then there exists an NOS W in Y such that $g(p_{(r,s,t)}) \in W \subset U$. Thus, g is neutrosophic $\alpha\psi$ -continuous, $V = g^{-1}(W)$ is an $N\alpha\psi$ Oset, and

$$p_{(r,s,t)} \in g^{-1}(g(p_{(r,s,t)})) \subseteq g^{-1}(W) = V \subseteq g^{-1}(U).$$

Thus, (ii) is a valid statement.

(ii) \Rightarrow (iii). Let $p_{(r,s,t)}$ be an NP in X and let U be an NN of $g(p_{(r,s,t)})$. Then there exists an $N\alpha\psi$ Oset V such that $p_{(r,s,t)} \in V \subseteq g^{-1}(U)$ by (ii). Thus, we have $p_{(r,s,t)} \in V$ and $g(V) \subseteq g(g^{-1}(U)) \subseteq U$. Hence, (iii) is valid.

(iii) \Rightarrow (i). Let V be an NO set in Y and let $p_{(r,s,t)} \in g^{-1}(V)$. Then $g(p_{(r,s,t)}) \in g(g^{-1}(V)) \subset V$. Since V is an NOS, it follows that V is an NN of $g(p_{(r,s,t)})$. Therefore, from (iii), there exists an $N\alpha\psi$ Oset U such that $p_{(r,s,t)} \in U$ and $g(U) \subseteq V$. This implies that

$$p_{(r,s,t)} \in U \subseteq g^{-1}(g(U)) \subseteq g^{-1}(V).$$

Therefore, we know that $g^{-1}(V)$ is an $N\alpha\psi$ Oset in X . Thus, g is neutrosophic $\alpha\psi$ -continuous. □

Definition 11. A function is said to be a neutrosophic contra $\alpha\psi$ -continuous function if the inverse image of each NOS V in Y is an $N\alpha\psi$ C set in X .

Theorem 11. Let $g : (X, \tau) \rightarrow (Y, \sigma)$ be a function. Then the following assertions are equivalent:

- (i) g is a neutrosophic contra $\alpha\psi$ -continuous function;
- (ii) $g^{-1}(V)$ is an $N\alpha\psi$ C set in X , for each NOS V in Y .

Proof. (i) \Rightarrow (ii) Let g be any neutrosophic contra $\alpha\psi$ -continuous function and let V be any NOS in Y . Then \bar{V} is an NCS in Y . Based on these assumptions, $g^{-1}(\bar{V})$ is an $N\alpha\psi$ Oset in X . Hence, $g^{-1}(V)$ is an $N\alpha\psi$ Cset in X .

The converse of the theorem can be proved in the same way. □

Theorem 12. Let $g : (X, \tau) \rightarrow (Y, \sigma)$ be a bijective mapping from an NTS (X, T) into an NTS (Y, T) . The mapping g is neutrosophic contra $\alpha\psi$ -continuous, if $Ncl(g(U)) \subseteq g(N\alpha\psi int(U))$, for each NS U in X .

Proof. Let V be any NCS in X . Then $Ncl(V) = V$, and g is onto, by assumption, which shows that $g(N\alpha\psi int(g^{-1}(V))) \supseteq Ncl(g(g^{-1}(V))) = Ncl(V) = V$. Hence, $g^{-1}(g(N\alpha\psi int(g^{-1}(V)))) \supseteq g^{-1}(V)$. Since g is an into mapping, we have $N\alpha\psi int(g^{-1}(V)) = g^{-1}(g(N\alpha\psi int(g^{-1}(V)))) \supseteq g^{-1}(V)$. Therefore, $N\alpha\psi int(g^{-1}(V)) = g^{-1}(V)$, so $g^{-1}(V)$ is an $N\alpha\psi O$ set in X . Hence, g is a neutrosophic contra $\alpha\psi$ -continuous mapping. \square

Theorem 13. Let $g : (X, \tau) \rightarrow (Y, \sigma)$ be a mapping. Then the following statements are equivalent:

- (i) g is a neutrosophic contra $\alpha\psi$ -continuous mapping;
- (ii) for each NP $p_{(r,s,t)}$ in X and NCS V containing $g(p_{(r,s,t)})$ there exists an $N\alpha\psi O$ set U in X containing $p_{(r,s,t)}$ such that $A \subseteq f^{-1}(B)$;
- (iii) for each NP $p_{(r,s,t)}$ in X and NCS V containing $p_{(r,s,t)}$ there exists an $N\alpha\psi O$ set U in X containing $p_{(r,s,t)}$ such that $g(U) \subseteq V$.

Proof. (i) \Rightarrow (ii) Let g be a neutrosophic contra $\alpha\psi$ -continuous mapping, let V be any NCS in Y and let $p_{(r,s,t)}$ be an NP in X and such that $g(p_{(r,s,t)}) \in V$. Then $p_{(r,s,t)} \in g^{-1}(V) = N\alpha\psi int(g^{-1}(V))$. Let $U = N\alpha\psi int(g^{-1}(V))$. Then U is an $N\alpha\psi O$ set and $U = N\alpha\psi int(g^{-1}(V)) \subseteq g^{-1}(V)$.

(ii) \Rightarrow (iii) The results follow from evident relations $g(U) \subseteq g(g^{-1}(V)) \subseteq V$.

(iii) \Rightarrow (i) Let V be any NCS in Y and let $p_{(r,s,t)}$ be an NP in X such that $p_{(r,s,t)} \in g^{-1}(V)$. Then $g(p_{(r,s,t)}) \in V$. According to the assumption, there exists an $N\alpha\psi O$ set U in X such that $p_{(r,s,t)} \in U$ and $g(U) \subseteq V$. Hence, $p_{(r,s,t)} \in U \subseteq g^{-1}(g(U)) \subseteq g^{-1}(V)$. Therefore, $p_{(r,s,t)} \in U = \alpha\psi int(U) \subseteq N\alpha\psi int(g^{-1}(V))$. Since $p_{(r,s,t)}$ is an arbitrary NP and $g^{-1}(V)$ is the union of all NPs in $g^{-1}(V)$, we obtain that $g^{-1}(V) \subseteq N\alpha\psi int(g^{-1}(V))$. Thus, g is a neutrosophic contra $N\alpha\psi$ -continuous mapping. \square

Corollary 2. Let X, X_1 and X_2 be NTS sets, $p_1 : X \rightarrow X_1 \times X_2$ and $p_2 : X \rightarrow X_1 \times X_2$ are the projections of $X_1 \times X_2$ onto $X_i, (i = 1, 2)$. If $g : X \rightarrow X_1 \times X_2$ is a neutrosophic contra $\alpha\psi$ -continuous, then $p_i g$ are also neutrosophic contra $\alpha\psi$ -continuous mapping.

Proof. This proof follows from the fact that the projections are all neutrosophic continuous functions. \square

Theorem 14. Let $g : (X_1, \tau) \rightarrow (Y_1, \sigma)$ be a function. If the graph $h : X_1 \rightarrow X_1 \times Y_1$ of g is neutrosophic contra $\alpha\psi$ -continuous, then g is neutrosophic contra $\alpha\psi$ -continuous.

Proof. For every NOS, V in Y_1 holds $g^{-1}(V) = 1 \wedge g^{-1}(V) = h^{-1}(1 \times V)$. Since h is a neutrosophic contra $\alpha\psi$ -continuous mapping and $1 \times V$ is an NOS in $X_1 \times Y_1, g^{-1}(V)$ is an $N\alpha\psi C$ set in X_1 , so g is a neutrosophic contra $\alpha\psi$ -continuous mapping. \square

References

1. Zadeh, L.A. Fuzzy Sets. *Inf. Control* **1965**, *8*, 338–353.
2. Atanassov, K. Intuitionistic fuzzy sets. *Fuzzy Sets Syst.* **1986**, *20*, 87–96.
3. Atanassov, K. *Review and New Results on Intuitionistic Fuzzy Sets*; Preprint IM-MFAIS-1-88; Mathematical Foundations of Artificial Intelligence Seminar: Sofia, Bulgaria, 1988.

4. Atanassov, K.; Stoeva, S. Intuitionistic fuzzy sets. In Proceedings of the Polish Symposium on Interval and Fuzzy Mathematics, Poznan, Poland, 26–29 August 1983; pp. 23–26.
5. Coker, D. An introduction to intuitionistic fuzzy topological spaces. *Fuzzy Sets Syst.* **1997**, *88*, 81–89.
6. Smarandache, F. *Neutrosophy and Neutrosophic Logic, First International Conference on Neutrosophy, Neutrosophic Logic, Set, Probability and Statistics*; University of New Mexico: Gallup, NM, USA, 2002.
7. Smarandache, F. *A Unifying Field in Logics: Neutrosophic Logic. Neutrosophy, Neutrosophic Set, Neutrosophic Probability*; American Research Press: Rehoboth, NM, USA, 1999.
8. Salama, A.A.; Alblowi, S.A. Neutrosophic Set and Neutrosophic Topological Spaces. *IOSR J. Math.* **2012**, *3*, 31–35.
9. Arokiarani, I.; Dhavaseelan, R.; Jafari, S.; Parimala, M. On some new notions and functions in neutrosophic topological spaces. *Neutrosophic Sets Syst.* **2017**, *16*, 16–19.
10. Devi, R.; Parimala, M. On Quasi $\alpha\psi$ -Open Functions in Topological Spaces. *Appl. Math. Sci.* **2009**, *3*, 2881–2886.
11. Parimala, M.; Devi, R. Fuzzy $\alpha\psi$ -closed sets. *Ann. Fuzzy Math. Inform.* **2013**, *6*, 625–632.
12. Parimala, M.; Devi, R. Intuitionistic fuzzy $\alpha\psi$ -connectedness between intuitionistic fuzzy sets. *Int. J. Math. Arch.* **2012**, *3*, 603–607.

New Multigranulation Neutrosophic Rough Set with Applications

Chunxin Bo, Xiaohong Zhang, Songtao Shao, Florentin Smarandache

Chunxin Bo, Xiaohong Zhang, Songtao Shao, Florentin Smarandache (2018). New Multigranulation Neutrosophic Rough Set with Applications. *Symmetry* 10, 578; DOI: 10.3390/sym10110578

Abstract: After the neutrosophic set (NS) was proposed, NS was used in many uncertainty problems. The single-valued neutrosophic set (SVNS) is a special case of NS that can be used to solve real-world problems. This paper mainly studies multigranulation neutrosophic rough sets (MNRSs) and their applications in multi-attribute group decision-making. Firstly, the existing definition of neutrosophic rough set (we call it type-I neutrosophic rough set (NRS_I) in this paper) is analyzed, and then the definition of type-II neutrosophic rough set (NRS_{II}), which is similar to NRS_I , is given and its properties are studied. Secondly, a type-III neutrosophic rough set (NRS_{III}) is proposed and its differences from NRS_I and NRS_{II} are provided. Thirdly, single granulation NRSs are extended to multigranulation NRSs, and the type-I multigranulation neutrosophic rough set ($MNRS_I$) is studied. The type-II multigranulation neutrosophic rough set ($MNRS_{II}$) and type-III multigranulation neutrosophic rough set ($MNRS_{III}$) are proposed and their different properties are outlined. We found that the three kinds of MNRSs generate corresponding NRSs when all the NRs are the same. Finally, $MNRS_{III}$ in two universes is proposed and an algorithm for decision-making based on $MNRS_{III}$ is provided. A car ranking example is studied to explain the application of the proposed model.

Keywords: inclusion relation; neutrosophic rough set; multi-attribute group decision-making (MAGDM); multigranulation neutrosophic rough set (MNRS); two universes

1. Introduction

Many theories have been applied to solve problems with imprecision and uncertainty. Fuzzy set (FS) theories [1–3] use the degree of membership to solve the fuzziness. Rough set (RS) theories [4–7] deal with uncertainty by lower and upper approximation (LUA). Soft set theories [8–10] deal with uncertainty by using a parametrized set. However, all these theories have their own restrictions. Smarandache proposed the concept of the neutrosophic set (NS) [11], which was a generalization of the intuitionistic fuzzy set (IFS). To address real-world uncertainty problems, Wang et al. proposed the single-valued neutrosophic set (SVNS) [12]. Many theories about neutrosophic sets were studied and extended single-valued neutrosophic set [13–15]. Zhang et al. [16] analyzed two kinds of inclusion relations of the NS and then proposed the type-3 inclusion relation of NS. The combinations of the FS and RS are popular and produce many interesting results [17]. Broumi and Smarandache [18] combined the RS and NS, then produced a rough NS and studied its qualities. Yang et al. [19] combined the SVNS and RS, then produced the SVNRS (single-valued neutrosophic rough set) and studied its qualities.

From the view point of granular computing, the RS uses upper and lower approximations to solve uncertainty problems, shown by single granularity. However, with the complexity of

real-word problems, we often encounter multiple relationship concepts. Qian and Liang [20] proposed a multigranularity rough set (MGRS). Many scholars have generalized MGRS and acquired some interesting consequences [21–26]. Zhang et al. [27] proposed non-dual MGRSs and investigated their qualities.

Few articles have been published about the combination of NSs and multigranulation rough sets. In this paper, we study three kinds of neutrosophic rough sets (NRSs) and multigranulation neutrosophic rough sets (MNRSs) that are based on three kinds of inclusion relationships of NS and corresponding union and intersection relationships [11,12,16]. Their different properties are discussed. We found that MNRSs degenerate to corresponding NRSs when the NRs are the same. Yang et al. [19] defined the NRS_I and considered its properties. Bo et al. [28] proposed $MNRS_I$ and discussed its properties. In this paper, we study NRS_{II} and $MNRS_{II}$. We also study NRS_{III} and $MNRS_{III}$, which are based on a type-3 inclusion relationship and corresponding union and intersection relationships. Finally, we use $MNRS_{III}$ on two universes to solve multi-attribute group decision-making (MAGDM) problems.

The structure of this article is as follows: In Section 2, some basic notions and operations of NRS_I and NRS_{II} are introduced. In Section 3, the definition of NRS_{III} is proposed and its qualities are investigated, and the differences between NRS_I , NRS_{II} , and NRS_{III} are illustrated using an example. In Section 4, $MNRS_I$ and $MNRS_{II}$ are discussed. In Section 5, $MNRS_{III}$ is proposed and its differences from $MNRS_I$ and $MNRS_{II}$ are studied. In Section 6, $MNRS_{III}$ on two universes is proposed and an application to solve the MAGDM problem is outlined. Finally, Section 7 provides our conclusions and outlook.

2. Preliminary

In this chapter, we look back at several basic concepts of type-I NRS, then propose the definition and properties of type-II NRS.

Definition 1. [12] A single valued neutrosophic set A in X is denoted by:

$$A = \{(x, T_A(x), I_A(x), F_A(x)) | x \in X\}, \tag{1}$$

where $T_A(x), I_A(x), F_A(x) \in [0, 1]$ for each point x in X and satisfies the condition $0 \leq T_A(x) + I_A(x) + F_A(x) \leq 3$. For convenience, “SVNS” is abbreviated to “NS” later. Here, $NS(X)$ denotes the set of all SVNS in X .

Definition 2. [29] A neutrosophic relation (NR) is a neutrosophic fuzzy subset of $X \times Y$, that is, $\forall x \in X, y \in Y$,

$$R(x, y) = (T_R, I_R, F_R), \tag{2}$$

where $T_R: X \times Y \rightarrow [0, 1]$, $I_R: X \times Y \rightarrow [0, 1]$, and $F_R: X \times Y \rightarrow [0, 1]$ and satisfies $0 \leq T_R + I_R + F_R \leq 3$. $NR(X \times Y)$ denotes all the NRs in $X \times Y$.

Definition 3. [19] Suppose (U, R) is a neutrosophic approximation space (NAS). $\forall A \in NS(U)$, the LUA of A , denoted by $\underline{R}(A)$ and $\overline{R}(A)$, is defined as: $\forall x \in U$,

$$\underline{R}(A) = \bigcap_{y \in U} (R^c(x, y) \cup A(y)), \quad \overline{R}(A) = \bigcup_{y \in U} (R(x, y) \cap A(y)). \tag{3}$$

The pair $(\underline{R}(A), \overline{R}(A))$ is called the SVNRS of A . In this paper, we called it type-I neutrosophic rough set (NRS_I). Because the definition of NRS_I is based on the type-1 operator of NS, the definition can be written as:

$$\underline{NRS}_I(A) = \bigcap_1 (R^c(x, y) \cup_1 A(y)), \quad \overline{NRS}_I(A) = \bigcup_1 (R(x, y) \cap_1 A(y)). \tag{4}$$

Proposition 1. [19] Suppose (U, R) is an NAS. $\forall A, B \in NS(U)$, we have:

- (1) If $A \subseteq_1 B$, then $\underline{NRS}_I(A) \subseteq_1 \underline{NRS}_I(B)$ and $\overline{NRS}_I(A) \subseteq_1 \overline{NRS}_I(B)$.
- (2) $\underline{NRS}_I(A \cap_1 B) = \underline{NRS}_I(A) \cap_1 \underline{NRS}_I(B)$, $\overline{NRS}_I(A \cup_1 B) = \overline{NRS}_I(A) \cup_1 \overline{NRS}_I(B)$.
- (3) $\underline{NRS}_I(A) \cup_1 \underline{NRS}_I(B) \subseteq_1 \underline{NRS}_I(A \cup_1 B)$, $\overline{NRS}_I(A \cap_1 B) \subseteq_1 \overline{NRS}_I(A) \cap_1 \overline{NRS}_I(B)$.

According to the \underline{NRS}_I , we can get the definition and properties of \underline{NRS}_{II} , which is based on the type-2 operator of NS.

Definition 4. Suppose (U, R) is an NAS. $\forall A \in NS(U)$, the type-II LUA of A , is defined as:

$$\underline{NRS}_{II}(A) = \bigcap_{y \in U} (R^c(x, y) \cup_2 A(y)), \quad \overline{NRS}_{II}(A) = \bigcup_{y \in U} (R(x, y) \cap_2 A(y)) \quad (5)$$

The pair $(\underline{NRS}_{II}(A), \overline{NRS}_{II}(A))$ is called \underline{NRS}_{II} of A .

Proposition 2. Suppose (U, R) is an NAS. $\forall A, B \in NS(U)$, we have:

- (1) If $A \subseteq_2 B$, then $\underline{NRS}_{II}(A) \subseteq_2 \underline{NRS}_{II}(B)$, $\overline{NRS}_{II}(A) \subseteq_2 \overline{NRS}_{II}(B)$.
- (2) $\underline{NRS}_{II}(A \cap_2 B) = \underline{NRS}_{II}(A) \cap_2 \underline{NRS}_{II}(B)$, $\overline{NRS}_{II}(A \cup_2 B) = \overline{NRS}_{II}(A) \cup_2 \overline{NRS}_{II}(B)$.
- (3) $\underline{NRS}_{II}(A) \cup_2 \underline{NRS}_{II}(B) \subseteq_2 \underline{NRS}_{II}(A \cup_2 B)$, $\overline{NRS}_{II}(A \cap_2 B) \subseteq_2 \overline{NRS}_{II}(A) \cap_2 \overline{NRS}_{II}(B)$.

Definition 5. [22] Suppose A, B are two NSs, then the Hamming distance between A and B is defined as:

$$d_N(A, B) = \sum_{i=1}^n \{|T_A(x_i) - T_B(x_i)| + |I_A(x_i) - I_B(x_i)| + |F_A(x_i) - F_B(x_i)|\}. \quad (6)$$

3. Type-III NRS

In this chapter, we introduce a new NRS, type-III NRS (\underline{NRS}_{III}). We provide the differences between the three kinds of NRSs. The properties of \underline{NRS}_{III} are also given.

Definition 6. Suppose (U, R) is an NAS. $\forall A \in NS(U)$, the type-III LUA of A , is defined as:

$$\underline{NRS}_{III}(A) = \bigcap_{y \in U} (R^c(x, y) \cup_3 A(y)), \quad \overline{NRS}_{III}(A) = \bigcup_{y \in U} (R(x, y) \cap_3 A(y)).$$

The pair $(\underline{NRS}_{III}(A), \overline{NRS}_{III}(A))$ is called \underline{NRS}_{III} of A .

Proposition 3. Suppose (U, R) is an NAS. $\forall A, B \in NS(U)$, we have:

- (1) If $A \subseteq_3 B$, then $\underline{NRS}_{III}(A) \subseteq_3 \underline{NRS}_{III}(B)$, $\overline{NRS}_{III}(A) \subseteq_3 \overline{NRS}_{III}(B)$.
- (2) $\underline{NRS}_{III}(A \cap_3 B) \subseteq_3 \underline{NRS}_{III}(A) \cap_3 \underline{NRS}_{III}(B)$, $\overline{NRS}_{III}(A) \cup_3 \overline{NRS}_{III}(B) \subseteq_3 \overline{NRS}_{III}(A \cup_3 B)$.
- (3) $\overline{NRS}_{III}(A \cap_3 B) \subseteq_3 \overline{NRS}_{III}(A) \cap_3 \overline{NRS}_{III}(B)$, $\underline{NRS}_{III}(A) \cup_3 \underline{NRS}_{III}(B) \subseteq_3 \underline{NRS}_{III}(A \cup_3 B)$.

Proof. (1) Assume $A \subseteq_3 B$,

Case 1: If $T_A(x) < T_B(x)$, $F_A(x) \geq F_B(x)$, then:

$$T_{\underline{NRS}_{III}(A)}(x) = \bigwedge_{y \in U} [F_R(x, y) \vee T_A(y)] \leq \bigwedge_{y \in U} [F_R(x, y) \vee T_B(y)] = T_{\underline{NRS}_{III}(B)}(x)$$

$$F_{\underline{NRS}_{III}(A)}(x) = \bigvee_{y \in U} [T_R(x, y) \wedge F_A(y)] \geq \bigvee_{y \in U} [T_R(x, y) \wedge F_B(y)] = F_{\underline{NRS}_{III}(B)}(x).$$

Hence,

$$\underline{NRS}_{III}(A) \subseteq_3 \underline{NRS}_{III}(B).$$

Case 2: If $T_A(x) = T_B(x)$, $F_A(x) > F_B(x)$, then:

$$\begin{aligned} T_{\underline{NRS}_{III}(A)}(x) &= \bigwedge_{y \in U} [F_R(x, y) \vee T_A(y)] = \bigwedge_{y \in U} [F_R(x, y) \vee T_B(y)] = T_{\underline{NRS}_{III}(B)}(x) \\ F_{\underline{NRS}_{III}(A)}(x) &= \bigvee_{y \in U} [T_R(x, y) \wedge F_A(y)] \geq \bigvee_{y \in U} [T_R(x, y) \wedge F_B(y)] = F_{\underline{NRS}_{III}(B)}(x). \end{aligned}$$

Hence,

$$\underline{NRS}_{III}(A) \subseteq_3 \underline{NRS}_{III}(B).$$

Case 3: suppose $T_A(x) = T_B(x)$, $F_A(x) = F_B(x)$ and $I_A(x) \leq I_B(x)$, then:

$$\begin{aligned} T_{\underline{NRS}_{III}(A)}(x) &= \bigwedge_{y \in U} [F_R(x, y) \vee T_A(y)] = \bigwedge_{y \in U} [F_R(x, y) \vee T_B(y)] = T_{\underline{NRS}_{III}(B)}(x) \\ F_{\underline{NRS}_{III}(A)}(x) &= \bigvee_{y \in U} [T_R(x, y) \wedge F_A(y)] = \bigvee_{y \in U} [T_R(x, y) \wedge F_B(y)] = F_{\underline{NRS}_{III}(B)}(x) \\ I_{\underline{NRS}_{III}(A)}(x) &= \begin{cases} I_A(y_j), & R^c(x, y_j) \subseteq_3 A(y_j) \subseteq_3 A(y_k), y_k, y_j \in U \\ I_{R^c}(x, y_j), & A(y_j) \subseteq_3 R^c(x, y_j) \\ 1, & \text{else} \end{cases} \\ I_{\underline{MNRS}_{III}^o(B)}(x) &= \begin{cases} I_B(y_j), & R_i^c(x, y_j) \subseteq_3 B(y_j) \subseteq_3 B(y_k), y_k, y_j \in U \\ I_{R_i^c}(x, y_j), & B(y_j) \subseteq_3 R_i^c(x, y_j) \\ 1, & \text{else} \end{cases}. \end{aligned}$$

Hence, $I_{\underline{NRS}_{III}(A)}(x) \leq I_{\underline{NRS}_{III}(B)}(x)$. So $\underline{NRS}_{III}(A) \subseteq_3 \underline{NRS}_{III}(B)$.

Summing up the above, if $A \subseteq_3 B$, then $\underline{NRS}_{III}(A) \subseteq_3 \underline{NRS}_{III}(B)$.

Similarly, we can get $\underline{NRS}_{III}(A) \subseteq_3 \underline{NRS}_{III}(B)$.

(2) According the Definition 6, we have:

$$\begin{aligned} \underline{NRS}_{III}(A \cap_3 B) &= \bigcap_{y \in U} [R^c(x, y) \cup_3 (A \cap_3 B)(y)] \\ &\subseteq_3 \left[\bigcap_{y \in U} (R^c(x, y) \cup_3 A(y)) \right] \cap_3 \left[\bigcap_{y \in U} (R^c(x, y) \cup_3 B(y)) \right] \\ &= \underline{NRS}_{III}(A) \cap_3 \underline{NRS}_{III}(B). \end{aligned}$$

Similarly,

$$\begin{aligned} \underline{NRS}_{III}(A) \cup_3 \underline{NRS}_{III}(B) &= \left[\bigcap_{y \in U} (R^c(x, y) \cup_3 A(y)) \right] \cup_3 \left[\bigcap_{y \in U} (R^c(x, y) \cup_3 B(y)) \right] \\ &\subseteq_3 \bigcap_{y \in U} [R^c(x, y) \cup_3 (A \cup_3 B)(y)] \\ &= \underline{NRS}_{III}(A \cup_3 B). \end{aligned}$$

(3) The proof is similar to that of Case 2. \square

Example 1. Define NAS (U, R) , where $U = \{x_1, x_2\}$ and R is given in Table 1.

Table 1. A neutrosophic relation R.

R	x_1	x_2
x_1	(0.4, 0.6, 0.7)	(0.2, 0.2, 0.9)
x_2	(0.7, 0.1, 0.4)	(0.8, 0.8, 0.6)

Suppose A is an NS and $A = \{(x_1, 0.8, 0.2, 0.1), (x_2, 0.4, 0.9, 0.5)\}$. Then, by Definitions 3, 4 and 6, we can get:

$$\begin{aligned} \underline{NRS}_I(A)(x_1) &= (0.8, 0.8, 0.2), \quad \overline{NRS}_I(A)(x_2) = (0.6, 0.2, 0.5), \\ \underline{NRS}_I(A)(x_2) &= (0.4, 0.6, 0.7), \quad \overline{NRS}_I(A)(x_1) = (0.7, 0.2, 0.4), \\ \underline{NRS}_{II}(A)(x_1) &= (0.8, 0.4, 0.2), \quad \overline{NRS}_{II}(A)(x_2) = (0.6, 0.9, 0.5), \\ \underline{NRS}_{II}(A)(x_2) &= (0.4, 0.2, 0.7), \quad \overline{NRS}_{II}(A)(x_1) = (0.7, 0.8, 0.4), \\ \underline{NRS}_{III}(A)(x_1) &= (0.8, 1, 0.2), \quad \overline{NRS}_{III}(A)(x_2) = (0.6, 0, 0.5), \\ \underline{NRS}_{III}(A)(x_2) &= (0.4, 0.6, 0.7), \quad \overline{NRS}_{III}(A)(x_1) = (0.7, 0.1, 0.4). \end{aligned}$$

4. Type-I and Type-II MNRS

We have proposed a kind of multigranulation neutrosophic rough set [30] (we called it type-I multigranulation neutrosophic rough set in this paper). $MNRS_I$ is based on a type-1 operator of NRs. In this chapter, we define the type-II multigranulation neutrosophic rough set ($MNRS_{II}$), which is based on a type-2 operator of NRs.

Definition 7. [28] Suppose U is a non-empty finite universe, and R_i ($1 \leq i \leq m$) is a binary NR on U . We call the tuple ordered set (U, R_i) the multigranulation neutrosophic approximation space (MNAS).

Definition 8. [28] Suppose (U, R_i) is an MNAS. $\forall A \in NS(U)$, the type-I optimistic LUA of A , represented by $\underline{MNRS}_I^o(A)$ and $\overline{MNRS}_I^o(A)$, is defined as:

$$\begin{aligned} \underline{MNRS}_I^o(A)(x) &= \bigcup_{i=1}^m \left(\bigcap_{y \in U} (R_i^c(x, y) \cup_1 A(y)) \right) \\ \overline{MNRS}_I^o(A)(x) &= \bigcap_{i=1}^m \left(\bigcup_{y \in U} (R_i(x, y) \cap_1 A(y)) \right). \end{aligned}$$

Then, A is named a definable NS when $\underline{MNRS}_I^o(A) = \overline{MNRS}_I^o(A)$. Alternatively, we name the pair $(\underline{MNRS}_I^o(A), \overline{MNRS}_I^o(A))$ an optimistic $MNRS_I$.

Definition 9. [30] Suppose (U, R_i) is an MNAS. $\forall A \in NS(U)$, the type-I pessimistic LUA of A , represented by $\underline{MNRS}_I^p(A)$ and $\overline{MNRS}_I^p(A)$, is defined as:

$$\begin{aligned} \underline{MNRS}_I^p(A)(x) &= \bigcap_{i=1}^m \left(\bigcap_{y \in U} (R_i^c(x, y) \cup_1 A(y)) \right) \\ \overline{MNRS}_I^p(A)(x) &= \bigcup_{i=1}^m \left(\bigcup_{y \in U} (R_i(x, y) \cap_1 A(y)) \right). \end{aligned}$$

Similarly, A is named a definable NS when $\underline{MNRS}_I^p(A) = \overline{MNRS}_I^p(A)$. Alternatively, we name the pair $(\underline{MNRS}_I^p(A), \overline{MNRS}_I^p(A))$ a pessimistic $MNRS_I$.

Definition 10. Suppose (U, R_i) is an MNAS. $\forall A \in NS(U)$, the type-II optimistic LUA of A , represented by $\underline{MNRS}_{II}^o(A)$ and $\overline{MNRS}_{II}^o(A)$, is defined as:

$$\begin{aligned} \underline{MNRS}_{II}^o(A)(x) &= \bigcup_{i=1}^m \left(\bigcap_{y \in U} (R_i^c(x, y) \cup_2 A(y)) \right) \\ \overline{MNRS}_{II}^o(A)(x) &= \bigcap_{i=1}^m \left(\bigcup_{y \in U} (R_i(x, y) \cap_2 A(y)) \right). \end{aligned}$$

Then, A is named a definable NS when $\underline{MNRS}_{II}^o(A) = \overline{MNRS}_{II}^o(A)$. Alternatively, we name the pair $(\underline{MNRS}_{II}^o(A), \overline{MNRS}_{II}^o(A))$ an optimistic $MNRS_{II}$.

Definition 11. Suppose (U, R_i) is an MNAS. $\forall A \in NS(U)$, the type-II pessimistic LUA of A , represented by $\underline{MNRS}_{II}^p(A)$ and $\overline{MNRS}_{II}^p(A)$, is defined as:

$$\underline{MNRS}_{II}^p(A)(x) = \bigcap_{i=1}^m \left(\bigcap_{y \in U} (R_i^c(x, y) \cup_2 A(y)) \right)$$

$$\overline{MNRS}_{II}^p(A)(x) = \bigcup_{i=1}^m \left(\bigcup_{y \in U} (R_i(x, y) \cap_2 A(y)) \right).$$

Similarly, A is named a definable NS when $\underline{MNRS}_{II}^p(A) = \overline{MNRS}_{II}^p(A)$. Alternatively, we name the pair $(\underline{MNRS}_{II}^p(A), \overline{MNRS}_{II}^p(A))$ a pessimistic $MNRS_{II}$.

Proposition 4. Suppose (U, R_i) is an MNAS. $\forall A, B \in NS(U)$, then:

- (1) $\underline{MNRS}_{II}^o(A) = \sim \overline{MNRS}_{II}^o(\sim A)$, $\underline{MNRS}_{II}^p(A) = \sim \overline{MNRS}_{II}^p(\sim A)$.
- (2) $\overline{MNRS}_{II}^o(A) = \sim \underline{MNRS}_{II}^o(\sim A)$, $\overline{MNRS}_{II}^p(A) = \sim \underline{MNRS}_{II}^p(\sim A)$.
- (3) $\underline{MNRS}_{II}^o(A \cap_2 B) = \underline{MNRS}_{II}^o(A) \cap_2 \underline{MNRS}_{II}^o(B)$, $\underline{MNRS}_{II}^p(A \cap_2 B) = \underline{MNRS}_{II}^p(A) \cap_2 \underline{MNRS}_{II}^p(B)$.
- (4) $\overline{MNRS}_{II}^o(A \cup_2 B) = \overline{MNRS}_{II}^o(A) \cup_2 \overline{MNRS}_{II}^o(B)$, $\overline{MNRS}_{II}^p(A \cup_2 B) = \overline{MNRS}_{II}^p(A) \cup_2 \overline{MNRS}_{II}^p(B)$.
- (5) $A \subseteq_2 B \Rightarrow \underline{MNRS}_{II}^o(A) \subseteq_2 \underline{MNRS}_{II}^o(B)$, $\underline{MNRS}_{II}^p(A) \subseteq_2 \underline{MNRS}_{II}^p(B)$.
- (6) $A \subseteq_2 B \Rightarrow \overline{MNRS}_{II}^o(A) \subseteq_2 \overline{MNRS}_{II}^o(B)$, $\overline{MNRS}_{II}^p(A) \subseteq_2 \overline{MNRS}_{II}^p(B)$.
- (7) $\underline{MNRS}_{II}^o(A) \cup_2 \underline{MNRS}_{II}^o(B) \subseteq_2 \underline{MNRS}_{II}^o(A \cup_2 B)$, $\underline{MNRS}_{II}^p(A) \cup_2 \underline{MNRS}_{II}^p(B) \subseteq_2 \underline{MNRS}_{II}^p(A \cup_2 B)$.
- (8) $\overline{MNRS}_{II}^o(A \cap_2 B) \subseteq_2 \overline{MNRS}_{II}^o(A) \cap_2 \overline{MNRS}_{II}^o(B)$, $\overline{MNRS}_{II}^p(A \cap_2 B) \subseteq_2 \overline{MNRS}_{II}^p(A) \cap_2 \overline{MNRS}_{II}^p(B)$.

Proof. Equations (1), (2), (5), and (6) are obviously according to Definitions 10 and 11. Next, we will prove Equations (3), (4), (7), and (8).

(3) By Definition 10,

$$\begin{aligned} \underline{MNRS}_{II}^o(A \cap_2 B)(x) &= \bigcup_{i=1}^m \left(\bigcap_{y \in U} (R_i^c(x, y) \cup_2 (A \cap_2 B)(y)) \right) \\ &= \bigcup_{i=1}^m \left(\bigcap_{y \in U} ((R_i^c(x, y) \cup_2 A(y)) \cap (R_i^c(x, y) \cup_2 B(y))) \right) \\ &= \left(\bigcup_{i=1}^m \left(\bigcap_{y \in U} (R_i^c(x, y) \cup_2 A(y)) \right) \right) \cap_2 \left(\bigcup_{i=1}^m \left(\bigcap_{y \in U} (R_i^c(x, y) \cup_2 B(y)) \right) \right) \\ &= \underline{MNRS}_{II}^o A(x) \cap_2 \underline{MNRS}_{II}^o B(y). \end{aligned}$$

Similarly, from Definition 11, we can get the following:

$$\underline{MNRS}_{II}^p(A \cap_2 B) = \underline{MNRS}_{II}^p(A) \cap_2 \underline{MNRS}_{II}^p(B).$$

(4) The proof is similar to that of Equation (3).

(7) By Definition 10, we can get:

$$\begin{aligned} T_{\underline{MNRS}_{II}^o(A \cup_2 B)}(x) &= \max_{i=1}^m \min_{y \in U} \{ \max [F_{R_i}(x, y), (\max(T_A(y), T_B(y)))] \} \\ &= \max_{i=1}^m \min_{y \in U} \{ \max [(\max(F_{R_i}(x, y), T_A(y))), (\max(F_{R_i}(x, y), T_B(y)))] \} \\ &\geq \max \left\{ \left[\max_{i=1}^m \min_{y \in U} (\max(F_{R_i}(x, y), T_A(y))) \right], \left[\max_{i=1}^m \min_{y \in U} (\max(F_{R_i}(x, y), T_B(y))) \right] \right\} \\ &= \max \left(T_{\underline{MNRS}_{II}^o(A)}(x), T_{\underline{MNRS}_{II}^o(B)}(x) \right). \end{aligned}$$

$$\begin{aligned} I_{\underline{MNRS}_{II}^o(A \cup_2 B)}(x) &= \max_{i=1}^m \min_{y \in U} \{ \max [(1 - I_{R_i}(x, y)), (\max(I_A(y), I_B(y)))] \} \\ &= \max_{i=1}^m \min_{y \in U} \{ \max [(\max((1 - I_{R_i}(x, y)), I_A(y))), (\max((1 - I_{R_i}(x, y)), I_B(y)))] \} \\ &\geq \max \left\{ \left[\max_{i=1}^m \min_{y \in U} (\max((1 - I_{R_i}(x, y)), I_A(y))) \right], \left[\max_{i=1}^m \min_{y \in U} (\max((1 - I_{R_i}(x, y)), I_B(y))) \right] \right\} \\ &= \max \left(I_{\underline{MNRS}_{II}^o(A)}(x), I_{\underline{MNRS}_{II}^o(B)}(x) \right). \end{aligned}$$

$$\begin{aligned} F_{\underline{MNRS}_{II}^o(A \cup_2 B)}(x) &= \min_{i=1}^m \max_{y \in U} \{ \min [T_{R_i}(x, y), (\min(F_A(y), F_B(y)))] \} \\ &= \min_{i=1}^m \max_{y \in U} \{ \min [\min(T_{R_i}(x, y), F_A(y)), [\min(T_{R_i}(x, y), F_B(y))]] \} \\ &\leq \min \left\{ \left[\min_{i=1}^m \max_{y \in U} (\min(T_{R_i}(x, y), F_A(y))) \right], \left[\min_{i=1}^m \max_{y \in U} (\min(T_{R_i}(x, y), F_B(y))) \right] \right\} \\ &= \min \left(F_{\underline{MNRS}_{II}^o(A)}(x), F_{\underline{MNRS}_{II}^o(B)}(x) \right). \end{aligned}$$

Hence, $\underline{MNRS}_{II}^o(A) \cup_2 \underline{MNRS}_{II}^o(B) \subseteq_2 \underline{MNRS}_{II}^o(A \cup_2 B)$.

Additionally, according to Definition 11, we can get $\underline{MNRS}_{II}^p(A) \cup_2 \underline{MNRS}_{II}^p(B) \subseteq_2 \underline{MNRS}_{II}^p(A \cup_2 B)$.

(8) The proof is similar to that of Equation (7). \square

Remark 1. Note that if the NRs are the same one, then the optimistic (pessimistic) \underline{MNRS}_{II} degenerates into \underline{NRS}_{II} in Section 2.

5. Type-III MNRS

In this chapter, \underline{MNRS}_{III} , which is based on a type-3 inclusion relation and corresponding union and intersection relations, is proposed and their characterizations are provided.

Definition 12. Suppose (U, R_i) is an MNAS. $\forall A \in NS(U)$, the type-III optimistic LUA of A , represented by $\underline{MNRS}_{III}^o(A)$ and $\overline{MNRS}_{III}^o(A)$, is defined as:

$$\begin{aligned} \underline{MNRS}_{III}^o(A)(x) &= \bigcup_{i=1}^m \left(\bigcap_{y \in U} (R_i^c(x, y) \cup_3 A(y)) \right) \\ \overline{MNRS}_{III}^o(A)(x) &= \bigcap_{i=1}^m \left(\bigcup_{y \in U} (R_i(x, y) \cap_3 A(y)) \right). \end{aligned}$$

Then, A is named a definable NS when $\underline{MNRS}_{III}^o(A) = \overline{MNRS}_{III}^o(A)$. Alternatively, we name the pair $(\underline{MNRS}_{III}^o(A), \overline{MNRS}_{III}^o(A))$ an optimistic \underline{MNRS}_{III} .

Definition 13. Suppose (U, R_i) is an MNAS. $\forall A \in NS(U)$, the type-III pessimistic LUA of A , represented by $\underline{MNRS}_{III}^p(A)$ and $\overline{MNRS}_{III}^p(A)$, is defined as:

$$\underline{MNRS}_{III}^p(A)(x) = \bigcap_{i=1}^m \left(\bigcap_{y \in U} (R_i^c(x, y) \cup_3 A(y)) \right)$$

$$\overline{MNRS_{III}^p}(A)(x) = \bigcup_{i=1}^m \left(\bigcup_{y \in U} (R_i(x, y) \cap_3 A(y)) \right).$$

Similarly, A is named a definable NS when $\underline{MNRS_{III}^p}(A) = \overline{MNRS_{III}^p}(A)$. Alternatively, we name the pair $(\underline{MNRS_{III}^p}(A), \overline{MNRS_{III}^p}(A))$ a pessimistic $MNRS_{III}$.

Proposition 5. Suppose (U, R_i) is an MNAS. $\forall A, B \in NS(U)$, then:

- (1) $\underline{MNRS_{III}^o}(A) = \sim \overline{MNRS_{III}^o}(\sim A), \underline{MNRS_{III}^p}(A) = \sim \overline{MNRS_{III}^p}(\sim A)$.
- (2) $\overline{MNRS_{III}^o}(A) = \sim \underline{MNRS_{III}^o}(\sim A), \overline{MNRS_{III}^p}(A) = \sim \underline{MNRS_{III}^p}(\sim A)$.
- (3) $A \subseteq_3 B \Rightarrow \underline{MNRS_{III}^o}(A) \subseteq_3 \underline{MNRS_{III}^o}(B), \underline{MNRS_{III}^p}(A) \subseteq_3 \underline{MNRS_{III}^p}(B)$.
- (4) $A \subseteq_3 B \Rightarrow \overline{MNRS_{III}^o}(A) \subseteq_3 \overline{MNRS_{III}^o}(B), \overline{MNRS_{III}^p}(A) \subseteq_3 \overline{MNRS_{III}^p}(B)$.
- (5) $\underline{MNRS_{III}^o}(A \cap_3 B) \subseteq_3 \underline{MNRS_{III}^o}(A) \cap_3 \underline{MNRS_{III}^o}(B), \underline{MNRS_{III}^p}(A \cap_3 B) \subseteq_3 \underline{MNRS_{III}^p}(A) \cap_3 \underline{MNRS_{III}^p}(B)$.
- (6) $\overline{MNRS_{III}^o}(A) \cup_3 \overline{MNRS_{III}^o}(B) \subseteq_3 \overline{MNRS_{III}^o}(A \cup_3 B), \overline{MNRS_{III}^p}(A) \cup_3 \overline{MNRS_{III}^p}(B) \subseteq_3 \overline{MNRS_{III}^p}(A \cup_3 B)$.
- (7) $\underline{MNRS_{III}^o}(A) \cup_3 \underline{MNRS_{III}^o}(B) \subseteq_3 \underline{MNRS_{III}^o}(A \cup_3 B), \underline{MNRS_{III}^p}(A) \cup_3 \underline{MNRS_{III}^p}(B) \subseteq_3 \underline{MNRS_{III}^p}(A \cup_3 B)$.
- (8) $\overline{MNRS_{III}^o}(A \cap_3 B) \subseteq_3 \overline{MNRS_{III}^o}(A) \cap_3 \overline{MNRS_{III}^o}(B), \overline{MNRS_{III}^p}(A \cap_3 B) \subseteq_3 \overline{MNRS_{III}^p}(A) \cap_3 \overline{MNRS_{III}^p}(B)$.

Proof. Equations (1) and (2) can be directly derived from Definitions 12 and 13. We only provide the proof of Equations (3)–(8).

(3) Suppose $A \subseteq_3 B$, then:

Case 1: If $T_A(x) < T_B(x), F_A(x) \geq F_B(x)$, then:

$$T_{\underline{MNRS_{III}^o}(A)}(x) = \bigvee_{i=1}^m \bigwedge_{y \in U} [F_{R_i}(x, y) \vee T_A(y)] \leq \bigvee_{i=1}^m \bigwedge_{y \in U} [F_{R_i}(x, y) \vee T_B(y)] = T_{\underline{MNRS_{III}^o}(B)}(x)$$

$$F_{\underline{MNRS_{III}^o}(A)}(x) = \bigwedge_{i=1}^m \bigvee_{y \in U} [T_{R_i}(x, y) \wedge F_A(y)] \geq \bigwedge_{i=1}^m \bigvee_{y \in U} [T_{R_i}(x, y) \wedge F_B(y)] = F_{\underline{MNRS_{III}^o}(B)}(x).$$

Hence, $\underline{MNRS_{III}^o}(A) \subseteq_3 \underline{MNRS_{III}^o}(B)$.

Case 2: If $T_A(x) = T_B(x), F_A(x) > F_B(x)$, then:

$$T_{\underline{MNRS_{III}^o}(A)}(x) = \bigvee_{i=1}^m \bigwedge_{y \in U} [F_{R_i}(x, y) \vee T_A(y)] = \bigvee_{i=1}^m \bigwedge_{y \in U} [F_{R_i}(x, y) \vee T_B(y)] = T_{\underline{MNRS_{III}^o}(B)}(x)$$

$$F_{\underline{MNRS_{III}^o}(A)}(x) = \bigwedge_{i=1}^m \bigvee_{y \in U} [T_{R_i}(x, y) \wedge F_A(y)] \geq \bigwedge_{i=1}^m \bigvee_{y \in U} [T_{R_i}(x, y) \wedge F_B(y)] = F_{\underline{MNRS_{III}^o}(B)}(x).$$

Hence, $\underline{MNRS_{III}^o}(A) \subseteq_3 \underline{MNRS_{III}^o}(B)$.

Case 3: suppose $T_A(x) = T_B(x), F_A(x) = F_B(x)$ and $I_A(x) \leq I_B(x)$, then:

$$T_{\underline{MNRS_{III}^o}(A)}(x) = \bigvee_{i=1}^m \bigwedge_{y \in U} [F_{R_i}(x, y) \vee T_A(y)] = \bigvee_{i=1}^m \bigwedge_{y \in U} [F_{R_i}(x, y) \vee T_B(y)] = T_{\underline{MNRS_{III}^o}(B)}(x)$$

$$F_{\underline{MNRS_{III}^o}(A)}(x) = \bigwedge_{i=1}^m \bigvee_{y \in U} [T_{R_i}(x, y) \wedge F_A(y)] \geq \bigwedge_{i=1}^m \bigvee_{y \in U} [T_{R_i}(x, y) \wedge F_B(y)] = F_{\underline{MNRS_{III}^o}(B)}(x)$$

$$I_{\underline{MNRS_{III}^o}(A)}(x) = \begin{cases} I_A(y_j), R_i^c(x, y_j) \subseteq_3 A(y_j) \subseteq_3 A(y_k), y_k, y_j \in U \\ I_{R_i^c}(x, y_j), A(y_j) \subseteq_3 R_i^c(x, y_j) \\ 0, \text{ else} \end{cases}$$

$$I_{\underline{MNRS}_{III}^o(B)}(x) = \begin{cases} I_B(y_j), R_i^c(x, y_j) \subseteq_3 B(y_j) \subseteq_3 B(y_k), y_k, y_j \in U \\ I_{R_i^c(x, y_j), B(y_j)} \subseteq_3 R_i^c(x, y_j) \\ 0, \text{ else} \end{cases}.$$

Hence, $I_{\underline{MNRS}_{III}^o(A)}(x) \leq I_{\underline{MNRS}_{III}^o(B)}(x)$. So, $\underline{MNRS}_{III}^o(A) \subseteq_3 \underline{MNRS}_{III}^o(B)$.

Summing up the above, if $A \subseteq_3 B$, then $\underline{MNRS}_{III}^o(A) \subseteq_3 \underline{MNRS}_{III}^o(B)$.

Similarly, we can get $\underline{MNRS}_{III}^p(A) \subseteq_3 \underline{MNRS}_{III}^p(B)$.

(4) The proof is similar to that of Equation (3).

(5) From Definition 12, we have:

$$\begin{aligned} \underline{MNRS}_{III}^o(A \cap_3 B) &= \bigcup_{i=1}^m \left(\bigcap_{y \in U} (R_i^c(x, y) \cup_3 (A(y) \cap_3 B(y))) \right) \\ &\subseteq_3 \bigcup_{i=1}^m \left(\bigcap_{y \in U} ((R_i^c(x, y) \cup_3 A(y)) \cap_3 (R_i^c(x, y) \cup_3 B(y))) \right) \\ &\subseteq_3 \left(\bigcup_{i=1}^m \left(\bigcap_{y \in U} (R_i^c(x, y) \cup_3 A(y)) \right) \right) \cap_3 \left(\bigcup_{i=1}^m \left(\bigcap_{y \in U} (R_i^c(x, y) \cup_3 B(y)) \right) \right) \\ &= \underline{MNRS}_{III}^o(A) \cap_3 \underline{MNRS}_{III}^o(B). \end{aligned}$$

Similarly, from Definition 13, we can get $\underline{MNRS}_{III}^p(A \cap_3 B) \subseteq_3 \underline{MNRS}_{III}^p(A) \cap_3 \underline{MNRS}_{III}^p(B)$.

(6) From Definition 12, we have:

$$\begin{aligned} \overline{MNRS}_{III}^o(A) \cup_3 \overline{MNRS}_{III}^o(B) &= \left(\bigcap_{i=1}^m \left(\bigcup_{y \in U} (R_i(x, y) \cap_3 A(y)) \right) \right) \cup_3 \left(\bigcap_{i=1}^m \left(\bigcup_{y \in U} (R_i(x, y) \cap_3 B(y)) \right) \right) \\ &\subseteq_3 \bigcap_{i=1}^m \left(\bigcup_{y \in U} ((R_i(x, y) \cap_3 A(y)) \cup_3 (R_i(x, y) \cap_3 B(y))) \right) \\ &\subseteq_3 \bigcap_{i=1}^m \left(\bigcup_{y \in U} (R_i(x, y) \cap_3 (A(y) \cup_3 B(y))) \right) \\ &= \overline{MNRS}_{III}^o(A \cup_3 B). \end{aligned}$$

Similarly, from Definition 13, we can get $\overline{MNRS}_{III}^p(A \cup_3 B) = \overline{MNRS}_{III}^p(A) \cup_3 \overline{MNRS}_{III}^p(B)$.

(7) From Definition 12, we have:

$$\begin{aligned} \underline{MNRS}_{III}^o(A \cup_3 B) &= \bigcup_{i=1}^m \left(\bigcap_{y \in U} (R_i^c(x, y) \cup_3 (A \cup_3 B)(y)) \right) \\ &= \bigcup_{i=1}^m \left(\bigcap_{y \in U} (R_i^c(x, y) \cup_3 (A(y) \cup_3 B(y))) \right) \\ &\supseteq_3 \bigcup_{i=1}^m \left(\left(\left[\bigcap_{y \in U} (R_i^c(x, y) \cup_3 A(y)) \right] \cup_3 \left[\bigcap_{y \in U} (R_i^c(x, y) \cup_3 B(y)) \right] \right) \right) \\ &= \left(\bigcup_{i=1}^m \left[\bigcap_{y \in U} (R_i^c(x, y) \cup_3 A(y)) \right] \right) \cup_3 \left(\bigcup_{i=1}^m \left[\bigcap_{y \in U} (R_i^c(x, y) \cup_3 B(y)) \right] \right) \\ &= \underline{MNRS}_{III}^o(A) \cup_3 \underline{MNRS}_{III}^o(B). \end{aligned}$$

Hence, $\underline{MNRS}_{III}^o(A) \cup_3 \underline{MNRS}_{III}^o(B) \subseteq_3 \underline{MNRS}_{III}^o(A \cup_3 B)$.

Additionally, from Definition 13, we can get $\underline{MNRS}_{III}^p(A) \cup_3 \underline{MNRS}_{III}^p(B) \subseteq_3 \underline{MNRS}_{III}^p(A \cup_3 B)$.

(8) From Definition 12, we have:

$$\begin{aligned} \overline{MNRS_{III}^o}(A \cap_3 B) &= \bigcap_{i=1}^m \left(\bigcup_{y \in U} (R_i(x, y) \cap_3 (A \cap_3 B)(y)) \right) \\ &= \bigcap_{i=1}^m \left(\bigcup_{y \in U} (R_i(x, y) \cap_3 (A(y) \cap_3 B(y))) \right) \\ &\subseteq_3 \bigcap_{i=1}^m \left(\left[\bigcup_{y \in U} (R_i(x, y) \cap_3 A(y)) \right] \cap_3 \left[\bigcup_{y \in U} (R_i(x, y) \cap_3 B(y)) \right] \right) \\ &= \left(\bigcap_{i=1}^m \left[\bigcup_{y \in U} (R_i(x, y) \cap_3 A(y)) \right] \right) \cap_3 \left(\bigcap_{i=1}^m \left[\bigcup_{y \in U} (R_i(x, y) \cap_3 B(y)) \right] \right) \\ &= \overline{MNRS_{III}^o}(A) \cap_3 \overline{MNRS_{III}^o}(B). \end{aligned}$$

Hence, $\overline{MNRS_{III}^o}(A \cap_3 B) \subseteq_3 \overline{MNRS_{III}^o}(A) \cap_3 \overline{MNRS_{III}^o}(B)$.

Similarly, from Definition 13, we can get $\overline{MNRS_{III}^p}(A \cap_3 B) \subseteq_3 \overline{MNRS_{III}^p}(A) \cap_3 \overline{MNRS_{III}^p}(B)$.

□

Remark 2. Note that if the NRs are the same one, then the optimistic (pessimistic) $MNRS_{III}$ degenerates into NRS_{III} in Section 3.

6. Type-III MNRS in Two Universes with Its Applications

In this chapter, we propose the concept of $MNRS_{III}$ in two universes and use it to deal with the MAGDM problem.

Definition 14. [28] Suppose U, V are two non-empty finite universes, and $R_i \in NS(U \times V)$ ($1 \leq i \leq m$) is a binary NR. We call (U, V, R_i) the MNAS in two universes.

Definition 15. Suppose (U, V, R_i) is an MNAS in two universes. $\forall A \in NS(V)$ and $x \in U$, the type-III optimistic LUA of A in (U, V, R_i) , represented by $\underline{MNRS_{III}^o}(A)$ and $\overline{MNRS_{III}^o}(A)$, is defined as:

$$\begin{aligned} \underline{MNRS_{III}^o}(A)(x) &= \bigcup_{i=1}^m \left(\bigcap_{y \in V} (R_i^c(x, y) \cup_3 A(y)) \right) \\ \overline{MNRS_{III}^o}(A)(x) &= \bigcap_{i=1}^m \left(\bigcup_{y \in V} (R_i(x, y) \cap_3 A(y)) \right). \end{aligned}$$

Then, A is named a definable NS in two universes when $\underline{MNRS_{III}^o}(A) = \overline{MNRS_{III}^o}(A)$. Alternatively, we name the pair $(\underline{MNRS_{III}^o}(A), \overline{MNRS_{III}^o}(A))$ an optimistic $MNRS_{III}$ in two universes.

Definition 16. Suppose (U, V, R_i) is an MNAS in two universes. $\forall A \in NS(V)$ and $x \in U$, the type-III pessimistic LUA of A in (U, V, R_i) , denoted by $\underline{MNRS_{III}^p}(A)$ and $\overline{MNRS_{III}^p}(A)$, is defined as follows:

$$\begin{aligned} \underline{MNRS_{III}^p}(A)(x) &= \bigcap_{i=1}^m \left(\bigcap_{y \in V} (R_i^c(x, y) \cup_3 A(y)) \right) \\ \overline{MNRS_{III}^p}(A)(x) &= \bigcup_{i=1}^m \left(\bigcup_{y \in V} (R_i(x, y) \cap_3 A(y)) \right). \end{aligned}$$

Similarly, A is named a definable NS when $\underline{MNRS_{III}^p}(A) = \overline{MNRS_{III}^p}(A)$. Alternatively, we name the pair $(\underline{MNRS_{III}^p}(A), \overline{MNRS_{III}^p}(A))$ a pessimistic $MNRS_{III}$ in two universes.

Remark 3. Note that if the two domains are the same, then the optimistic (pessimistic) MNRS_{III} in two universes degenerates into the optimistic (pessimistic) MNRS_{III} in a single universe in Section 5.

The MAGDM problem is becoming more and more generally present in our daily life. MAGDM means to select or rank all the feasible alternatives in various criterions. There are many ways to solve the MAGDM problem, but we use MNRS to solve it in this paper. Next, we give the basic description of the considered MAGDM problem.

For the car-ranking question, suppose $U = \{x_1, x_2, \dots, x_n\}$ is the decision set and $V = \{y_1, y_2, \dots, y_m\}$ is the criteria set in which x_1 represents “very popular”, x_2 represents “popular”, x_3 represents “less popular”, \dots , x_n represents “not popular”, y_1 represents the vehicle type”, y_2 represents the size of the space, y_3 represents the ride height, y_4 represents quality, and \dots , y_m represents length of durability. Then, l selection experts make evaluations about the criteria sets according to their own experiences. Here, the evaluations were shown by NRs. Next, we calculate the degree of popularity for a given car. Therefore, we need to use MGNRS to solve the above problem. For the MAGDM problem under a multigranulation neutrosophic environment, the optimistic lower approximation can be regarded as an optimistic risk decision, and the optimistic upper approximation can be regarded as an optimistic conservative decision. Additionally, the pessimistic lower approximation can be regarded as a pessimistic risk decision and the pessimistic upper approximation can be regarded as a pessimistic conservative decision. According to the distance of neutrosophic sets, we define the difference function $d_N(A, B)(x_i) = (1/3)(|T_A(x_i) - T_B(x_i)| + |I_A(x_i) - I_B(x_i)| + |F_A(x_i) - F_B(x_i)|)$. We used the difference function to represent the distance of optimistic (pessimistic) upper and lower approximation. The smaller the value of the distance is, the better the alternative x_i is, because the risk decision and the conservative decision are close. By comparing the distance value, all alternatives can be ranked and we can choose the optimal alternative. In this paper, we only used three kinds of optimistic upper and lower approximation to decision-making.

Next, we show the process of the above car-ranking question based on MGNRSs over two universes. Let $R_l \in NR(U \times V)$ be NRs from U to V , where $\forall(x_i, y_j) \in U \times V$, $R_l(x_i, y_j)$ denotes the degree of popularity for criteria set y_j ($y_j \in V$). R_l can be obtained according to experts’ experience. Given a car A , according to the unconventional questionnaire (suppose there are three options—“like”, “not like”, and “neutral” to choose for each of the criteria sets, and everyone can choose one or more options), then we can get the popularity of every criterion as described by an NS A in the universe V according to the questionnaire. By use of the following Algorithm 1, we can determine the degree of popularity of the given car A .

Algorithm 1 Decision algorithm

Input Multigranulation neutrosophic decision information systems (U, V, \mathbf{R}) .

Output The degree of popularity of the given car.

Step 1 Computing three kinds of optimistic multigranulation LUA $\underline{MNRS}_I^o(A)$, $\overline{MNRS}_I^o(A)$, $\underline{MNRS}_{II}^o(A)$, $\overline{MNRS}_{II}^o(A)$, $\underline{MNRS}_{III}^o(A)$, $\overline{MNRS}_{III}^o(A)$.

Step 2 Calculate $d(\underline{MNRS}_I^o(x_i), \overline{MNRS}_I^o(x_i))$, $d(\underline{MNRS}_{II}^o(x_i), \overline{MNRS}_{II}^o(x_i))$ and $d(\underline{MNRS}_{III}^o(x_i), \overline{MNRS}_{III}^o(x_i))$.

Step 3 The best choice is to select x_h (which means that the most welcome degree is x_h) if $d(\underline{MNRS}^o(x_h), \overline{MNRS}^o(x_h)) = \min_{i \in \{1, 2, \dots, n\}} d(\underline{MNRS}^o(x_i), \overline{MNRS}^o(x_i))$.

Step 4 If h has two or more values, then each x_h will be the best choice. In this case, the car may have two or more popularities and each x_k will be regarded as the most possible popularity; otherwise, we use other methods to make a decision.

Next, we use an example to explain the algorithm.

Let $U = \{x_1, x_2, x_3, x_4\}$ be the decision set, in which x_1 denotes “very popular”, x_2 denotes “popular”, x_3 denotes “less popular”, and x_4 denotes “not popular”. Let $V = \{y_1, y_2, y_3, y_4, y_5\}$ be

criteria sets, in which y_1 denotes the vehicle type, y_2 denotes the size of the space, y_3 denotes the ride height, y_4 denotes quality, and y_5 denotes length of durability.

Suppose that $R_1, R_2,$ and R_3 are given by three invited experts. They provide their evaluations for all criteria y_j with respect to decision set elements x_i . The evaluation $R_1, R_2,$ and R_3 are NRs between attribute set V and decision evaluation set U , that is., there are $R_1, R_2, R_3 \in NR(U \times V)$.

Suppose three experts present their judgment (the neutrosophic relation $R_1, R_2,$ and R_3) for the attribute and decision sets in Tables 2–4:

Table 2. Neutrosophic relation R_1 .

R_1	y_1	y_2	y_3	y_4	y_5
x_1	(0.8, 0.6, 0.5)	(0.2, 0.3, 0.9)	(0, 0, 1)	(0.7, 0.5, 0.6)	(0, 0, 1)
x_2	(0.6, 0.4, 0.6)	(0.9, 0.3, 0.4)	(1, 0, 0)	(0, 0, 1)	(0.3, 0.6, 0.7)
x_3	(0.2, 0.5, 0.9)	(0.6, 0.7, 0.5)	(0.8, 0.7, 0.8)	(0, 0, 1)	(1, 0, 0)
x_4	(0.6, 0.4, 0.7)	(0, 0, 1)	(0, 0, 1)	(0.9, 0.8, 0.1)	(0, 0, 1)

Table 3. Neutrosophic relation R_2 .

R_2	y_1	y_2	y_3	y_4	y_5
x_1	(0.9, 0.3, 0.6)	(0, 0, 1)	(0, 0, 1)	(0.5, 0.6, 0.5)	(0.2, 0.3, 0.9)
x_2	(0.3, 0.7, 0.8)	(0.7, 0.5, 0.6)	(0.9, 0.1, 0.1)	(0, 0, 1)	(0.4, 0.5, 0.8)
x_3	(0.1, 0.6, 0.8)	(0.3, 0.6, 0.5)	(0.7, 0.3, 0.6)	(0, 0, 1)	(1, 0, 0)
x_4	(0.7, 0.5, 0.6)	(0, 0, 1)	(0, 0, 1)	(1, 0, 0)	(0, 0, 1)

Table 4. Neutrosophic relation R_3 .

R_3	y_1	y_2	y_3	y_4	y_5
x_1	(0.6, 0.9, 0.4)	(0.1, 0.1, 0.8)	(0.1, 0, 0.9)	(0.8, 0.4, 0.8)	(0, 0, 1)
x_2	(0.5, 0.6, 0.6)	(0.6, 0.2, 0.7)	(1, 0, 0)	(0, 0, 1)	(0, 0, 1)
x_3	(0.1, 0.4, 0.7)	(0.2, 0.2, 0.7)	(0.5, 0.7, 0.6)	(0, 0, 1)	(0.9, 0.1, 0.2)
x_4	(0.6, 0.3, 0.4)	(0, 0, 1)	(0, 0, 1)	(0.7, 0.5, 0.4)	(0, 0, 1)

Suppose A is a car and each criterion in V is as follows:

$$A = \{(y_1, 0.9, 0.2, 0.2), (y_2, 0.2, 0.7, 0.8), (y_3, 0, 1, 0.3), (y_4, 0.7, 0.6, 0.3), (y_5, 0.1, 0.8, 0.9)\}.$$

Then, we can calculate the three kinds of optimistic LUAs of A as follow:

$$\begin{aligned} \underline{MNRS}_I^o(A)(x_1) &= (0.8, 1, 0.3), \underline{MNRS}_I^o(A)(x_2) = (0.1, 0.9, 0.6), \\ \underline{MNRS}_I^o(A)(x_3) &= (0.2, 0.8, 0.9), \underline{MNRS}_I^o(A)(x_4) = (0.7, 1, 0.3), \\ \overline{MNRS}_I^o(A)(x_1) &= (0.7, 0.6, 0.5), \overline{MNRS}_I^o(A)(x_2) = (0.3, 0.6, 0.3), \\ \overline{MNRS}_I^o(A)(x_3) &= (0.2, 0.6, 0.8), \overline{MNRS}_I^o(A)(x_4) = (0.7, 0.5, 0.4), \\ \underline{MNRS}_{II}^o(A)(x_1) &= (0.8, 0.6, 0.3), \underline{MNRS}_{II}^o(A)(x_2) = (0.1, 0.6, 0.6), \\ \underline{MNRS}_{II}^o(A)(x_3) &= (0.2, 0.6, 0.9), \underline{MNRS}_{II}^o(A)(x_4) = (0.7, 0.6, 0.3), \\ \overline{MNRS}_{II}^o(A)(x_1) &= (0.7, 0.4, 0.5), \overline{MNRS}_{II}^o(A)(x_2) = (0.3, 0.2, 0.3), \\ \overline{MNRS}_{II}^o(A)(x_3) &= (0.2, 0.6, 0.8), \overline{MNRS}_{II}^o(A)(x_4) = (0.7, 0.2, 0.4), \\ \underline{MNRS}_{III}^o(A)(x_1) &= (0.8, 0, 0.3), \underline{MNRS}_{III}^o(A)(x_2) = (0.1, 0, 0.6), \\ \underline{MNRS}_{III}^o(A)(x_3) &= (0.2, 0.9, 0.9), \underline{MNRS}_{III}^o(A)(x_4) = (0.7, 0.6, 0.3), \\ \overline{MNRS}_{III}^o(A)(x_1) &= (0.7, 1, 0.5), \overline{MNRS}_{III}^o(A)(x_2) = (0.3, 0, 0.3), \\ \overline{MNRS}_{III}^o(A)(x_3) &= (0.2, 0.7, 0.8) \overline{MNRS}_{III}^o(A)(x_4) = (0.7, 0.5, 0.4). \end{aligned}$$

Therefore, we can get:

$$\begin{aligned}d(\underline{MNRS}_I^o(x_1), \overline{MNRS}_I^o(x_1)) &= 0.7/3, d(\underline{MNRS}_I^o(x_2), \overline{MNRS}_I^o(x_2)) = 0.8/3, \\d(\underline{MNRS}_I^o(x_3), \overline{MNRS}_I^o(x_3)) &= 0.1, d(\underline{MNRS}_I^o(x_4), \overline{MNRS}_I^o(x_4)) = 0.2, \\d(\underline{MNRS}_{II}^o(x_1), \overline{MNRS}_{II}^o(x_1)) &= 0.5/3, d(\underline{MNRS}_{II}^o(x_2), \overline{MNRS}_{II}^o(x_2)) = 0.3, \\d(\underline{MNRS}_{II}^o(x_3), \overline{MNRS}_{II}^o(x_3)) &= 0.1/3, d(\underline{MNRS}_{II}^o(x_4), \overline{MNRS}_{II}^o(x_4)) = 0.5/3, \\d(\underline{MNRS}_{III}^o(x_1), \overline{MNRS}_{III}^o(x_1)) &= 1.3/3, d(\underline{MNRS}_{III}^o(x_2), \overline{MNRS}_{III}^o(x_2)) = 0.5/3, \\d(\underline{MNRS}_{III}^o(x_3), \overline{MNRS}_{III}^o(x_3)) &= 0.1, d(\underline{MNRS}_{III}^o(x_4), \overline{MNRS}_{III}^o(x_4)) = 0.2/3.\end{aligned}$$

Thus, for the type-I and type-II MNRS, the optimistic best choice is to select x_3 , that is, this car is less popular; for the type-III MNRS, the optimistic best choice is to select x_4 , that is, this car is not popular.

7. Conclusions

NRS and MNRS are extensions of the Pawlak rough set theory. In this paper, we analysed the NRS_I and NRS_{II} , we proposed model NRS_{III} , and used an example to outline the differences between the three kinds of NRS. We gave the definition of $MNRS_{III}$, which is based on the type-3 operator relation of NS, and considered their properties. Furthermore, we proposed $MNRS_{III}$ in two universes and we presented an algorithm of the MAGDM problem based on it.

In the future, we will be researching other types of fusions of MGRSs and NSs. We will also study the applications of concepts in this paper to some algebraic systems (for example, pseudo-BCI algebras, neutrosophic triplet groups, see [30,31]).

References

1. Atanassov, K.T. Type-1 Fuzzy Sets and Intuitionistic Fuzzy Sets. *Algorithms* **2017**, *10*, 106. [CrossRef]
2. Bisht, K.; Joshi, D.K.; Kumar, S. Dual Hesitant Fuzzy Set-Based Intuitionistic Fuzzy Time Series Forecasting. In Proceedings of the International Conference on Recent Advancement in Computer, Communication and Computational Sciences, Ajmer, India, 2–3 September 2017; Springer: Singapore, 2018; pp. 317–329.
3. Kumar, K.; Garg, H. TOPSIS method based on the connection number of set pair analysis under interval-valued intuitionistic fuzzy set environment. *Comput. Appl. Math.* **2018**, *37*, 1319–1329. [CrossRef]
4. Jia, X.; Shang, L.; Zhou, B.; Yao, Y. Generalized attribute reduct in rough set theory. *Knowl. Based Syst.* **2016**, *91*, 204–218. [CrossRef]
5. Maji, P. Advances in Rough Set Based Hybrid Approaches for Medical Image Analysis. In Proceedings of the International Joint Conference, Olsztyn, Poland, 3–7 July 2017; Springer: Cham, Switzerland, 2017; pp. 25–33.
6. Yao, Y.; She, Y. Rough set models in multigranulation spaces. *Inf. Sci.* **2016**, *327*, 40–56. [CrossRef]
7. Zhan, J.; Liu, Q.; Herawan, T. A novel soft rough set: Soft rough hemirings and corresponding multicriteria group decision-making. *Appl. Soft Comput.* **2017**, *54*, 393–402. [CrossRef]
8. Ma, X.L.; Zhan, J.M.; Ali, M.I. A survey of decision making methods based on two classes of hybrid soft set models. *Artif. Intell. Rev.* **2018**, *49*, 511–529. [CrossRef]
9. Zhang, X.H.; Bo, C.X.; Smarandache, F.; Park, C. New operations of totally dependent-neutrosophic sets and totally dependent-neutrosophic soft sets. *Symmetry* **2018**, *10*. [CrossRef]
10. Zhang, X.; Park, C.; Wu, S. Soft set theoretical approach to pseudo-BCI algebras. *J. Intell. Fuzzy Syst.* **2018**, *34*, 559–568. [CrossRef]
11. Smarandache, F. Neutrosophic set—A generalization of the intuitionistics fuzzy sets. *Int. J. Pure Appl. Math.* **2005**, *24*, 287–297.

12. Wang, H.B.; Smarandache, F.; Zhang, Y.; Sunderraman, R. Single valued neutrosophic sets. *Multispace Multistructure* **2010**, *4*, 410–413.
13. Singh, P.K. Three-way fuzzy concept lattice representation using neutrosophic set. *Int. J. Mach. Learn. Cybern.* **2017**, *8*, 69–79. [[CrossRef](#)]
14. Peng, X.; Liu, C. Algorithms for neutrosophic soft decision making based on EDAS, new similarity measure and level soft set. *J. Intell. Fuzzy Syst.* **2017**, *32*, 955–968. [[CrossRef](#)]
15. Ye, J. A multicriteria decision-making method using aggregation operators for simplified neutrosophic sets. *J. Intell. Fuzzy Syst.* **2014**, *26*, 2459–2466.
16. Zhang, X.; Bo, C.X.; Smarandache, F.; Dai, J.H. New inclusion relation of neutrosophic sets with applications and related lattice structure. *Int. J. Mach. Learn. Cybern.* **2018**, *9*, 1753–1763. [[CrossRef](#)]
17. Dubois, D.; Prade, H. Rough fuzzy sets and fuzzy rough sets. *Inter. J. General Syst.* **1990**, *17*, 191–209. [[CrossRef](#)]
18. Broumi, S.; Smarandache, F.; Dhar, M. Rough neutrosophic sets. *Neut. Sets Syst.* **2014**, *3*, 62–67.
19. Yang, H.L.; Zhang, C.L.; Guo, Z.L.; Liu, Y.L.; Liao, X. A hybrid model of single valued neutrosophic sets and rough sets: Single valued neutrosophic rough set model. *Soft Comput.* **2017**, *21*, 6253–6267. [[CrossRef](#)]
20. Qian, Y.H.; Liang, J.Y.; Yao, Y.Y.; Dang, C.Y. MGRS: A multi-granulation rough set. *Inf. Sci.* **2010**, *180*, 949–970. [[CrossRef](#)]
21. Kumar, S.S.; Inbarani, H.H. Optimistic multi-granulation rough set based classification for medical diagnosis. *Procedia Comput. Sci.* **2015**, *47*, 374–382. [[CrossRef](#)]
22. Majumdar, P.; Samanta, S.K. On similarity and entropy of neutrosophic sets. *J. Intell. Fuzzy Syst.* **2014**, *26*, 1245–1252.
23. Kang, Y.; Wu, S.; Li, Y.; Liu, J.; Chen, B. A variable precision grey-based multi-granulation rough set model and attribute reduction. *Knowl. Based Syst.* **2018**, *148*, 131–145. [[CrossRef](#)]
24. Sun, B.Z.; Ma, W.M.; Qian, Y.H. Multigranulation fuzzy rough set over two universes and its application to decision making. *Knowl. Based Syst.* **2017**, *123*, 61–74. [[CrossRef](#)]
25. Pan, W.; She, K.; Wei, P. Multi-granulation fuzzy preference relation rough set for ordinal decision system. *Fuzzy Sets Syst.* **2017**, *312*, 87–108. [[CrossRef](#)]
26. Huang, B.; Guo, C.; Zhuang, Y.; Li, H.; Zhou, X. Intuitionistic fuzzy multi-granulation rough sets. *Inf. Sci.* **2014**, *277*, 299–320. [[CrossRef](#)]
27. Zhang, X.; Miao, D.; Liu, C.; Le, M. Constructive methods of rough approximation operators and multi-granulation rough sets. *Knowl. Based Syst.* **2016**, *91*, 114–125. [[CrossRef](#)]
28. Bo, C.X.; Zhang, X.; Shao, S.T.; Smarandache, F. Multi-granulation neutrosophic rough sets on a single domain and dual domains with applications. *Symmetry* **2018**. accepted. [[CrossRef](#)]
29. Yang, H.L.; Guo, Z.L.; She, Y.; Liao, X.W. On single valued neutrosophic relations. *J. Intell. Fuzzy Syst.* **2016**, *30*, 1045–1056. [[CrossRef](#)]
30. Zhang, X.H. Fuzzy anti-grouped filters and fuzzy normal filters in pseudo-BCI algebras. *J. Intell. Fuzzy Syst.* **2017**, *33*, 1767–1774. [[CrossRef](#)]
31. Zhang, X.H.; Smarandache, F.; Liang, X.L. Neutrosophic duplet semi-group and cancellable neutrosophic triplet groups. *Symmetry* **2017**, *9*. [[CrossRef](#)]

True-False Set is a particular case of the Refined Neutrosophic Set

Florentin Smarandache, Said Broumi

Florentin Smarandache, Said Broumi (2020). True-False Set is a particular case of the Refined Neutrosophic Set. *International Journal of Neutrosophic Science* 12(1), 9-12; DOI: 10.5281/zenodo.4247831

Abstract

Borzooei, Mohseni Takallo, and Jun recently proposed a new type of set, called True-False Set [1], and they claimed it is a generalization of Neutrosophic Set [2]. We prove that this assertion is untrue. Actually it's the opposite, the True-False Set is a particular case of the Refined Neutrosophic Set..

Keywords : Refined Neutrosophic Set, True-False Set, Neutrosophic Set, Indeterminacy.

1. Definition of True -False Set [1]

A True-False set (TF-set), on a none-empty set X , is a structure of the form:

$$A_{TFS} = \{x; t_A(x), T_A(x), f_A(x), F_A(x) | x \in X\};$$

the index "TFS" stands for True-False Set;

where $t_A: X \rightarrow [0, 1]$; t_A represents the single-valued truth function;

$T_A: X \rightarrow I([0, 1])$, where $I([0, 1])$ is the set of all subintervals of $[0, 1]$; T_A represents the interval-valued truth function;

$$f_A: X \rightarrow [0, 1]; f_A \text{ represents the single-valued falsehood function;}$$

$$F_A: X \rightarrow I([0, 1]); F_A \text{ represents the interval-valued falsehood function.}$$

It is not clear why two truth-functions and two falsehood-functions are needed for the same element x . There is no justification.

2. Definition of neutrosophic set [2]

We try to use similar notations and language in order to make easy comparison between the two types of sets.

Let X be a non-empty universe of discourse.

A Neutrosophic Set on X is a structure of the form:

$$A_{NS} = \{x; T_A(x), I_A(x), F_A(x) | x \in X\},$$

where $T_A, I_A, F_A: X \rightarrow \mathcal{P}]\!-\!0, 1^+[$, where $\mathcal{P}]\!-\!0, 1^+[$ is the set of all standard or nonstandard subsets of the non-standard interval $]\!-\!0, 1^+[$.

3. Distinctions between True-False Set and Neutrosophic Set

1) Clearly $\mathcal{P}]\!-\!0, 1^+[\supsetneq I([0, 1])$. From this point of view, the neutrosophic set is larger than the True-False Set.

$\mathcal{P}]\!-\!0, 1^+[$ includes not only standard subintervals of $[0, 1]$ as $I([0, 1])$, but any standard subsets of $[0, 1]$.

2) $\mathcal{P}]\!-\!0, 1^+[$ also includes non-standard subsets of $]\!-\!0, 1^+[$, left and right monads, binads from non-standard analysis, that help make a distinction between absolute truth (truth in all possible worlds, according to Leibniz), whose truth-value is $T_A(x) = 1^+$, where $1^+ = 1 + \varepsilon > 1$ and ε is a positive infinitesimal number.

Similarly for absolute / relative indeterminacy and respectively falsehood.

The True-False Set cannot make distinctions between absolute and relative truth/falsehood.

3) Neutrosophic Set is much more complex as structure than the True-False Set; Neutrosophic Set has been further extended Neutrosophic Overset (where the neutrosophic components could be ≥ 1), Neutrosophic Underset (where the neutrosophic components could be ≤ 0), and Neutrosophic Offset (where the neutrosophic components could be ≥ 1 and ≤ 0) in 2007 & 2016 ([3], [4]).

4. Transformation of a Single-Valued Neutrosophic Set to a True-False Set [1]

The authors of [1] considered only the simplest form of the Neutrosophic Set, i.e. when the neutrosophic components T, I, F are single (crisp) numbers in $[0, 1]$, while the general definition [2] of neutrosophic set stated since 1998 that T, I, F can be any subsets of $[0, 1]$, or any nonstandard subsets of the non-standard unit interval $]\!-\!0, 1^+[$.

They considered the single-valued neutrosophic set:

$$A_{NS} = \{x; T_{NS}(x), I_{NS}(x), F_{NS}(x) | x \in X\},$$

where $T_{NS}, I_{NS}, F_{NS}: X \rightarrow [0, 1]$ are single-valued truth, indeterminacy, and falsehood functions respectively. The index “NS” stands for Neutrosophic Set (we adjusted their Greek letter notations to Latin ones, in order to exactly match the common use notations of the neutrosophic set).

They transformed it to a True-False Set in the following way:

$$t(x) = T_{NS}(x);$$

$$f(x) = F_{NS}(x);$$

$$T_{TFS}(x) = \begin{cases} [T_{NS}(x), I_{NS}(x)], & \text{if } T_{NS}(x) \leq I_{NS}(x); \\ [I_{NS}(x), T_{NS}(x)], & \text{if } I_{NS}(x) \leq T_{NS}(x); \end{cases}$$

$$F_{TFS}(x) = \begin{cases} [F_{NS}(x), I_{NS}(x)], & \text{if } F_{NS}(x) \leq I_{NS}(x); \\ [I_{NS}(x), F_{NS}(x)], & \text{if } I_{NS}(x) \leq F_{NS}(x). \end{cases}$$

And they formed the following True-False Set:

$$A_{TFS} = \{x; t(x), T_{TFS}(x), f(x), F_{TFS}(x) | x \in X\} = \{x; T_{NS}(x), T_{TFS}(x), F_{NS}(x), F_{TFS}(x) | x \in X\}.$$

This True-False Set, A_{TFS} , has two truth-functions and two-falsehood functions, but no indeterminacy (neutrality) function (they removed it).

Transforming the neutrosophic set A_{NS} into a true-false set A_{TFS} is just a mathematical artifact. It is not proven that A_{NS} is equivalent to A_{TFS} . Actually, we'll prove below that they are not.

Other mathematical transformations can be designed as well, constructing new intervals, or combining the neutrosophic functions in other ways, etc. But the equivalence, if any, should be proven.

5. Indeterminacy (Neutrality)

The indeterminacy (neutrality) is the quintessence (the flavor) of neutrosophic set, that stringently distinguishes it from previous types of sets.

By eliminating the indeterminacy (or neutrality) from the neutrosophic set A_{NS} , when constructing a true-false set A_{TFS} , the true-false set A_{TFS} becomes deficient, incapable of characterizing the neutrosophic triads of the form $(\langle A \rangle, \langle \text{neut}A \rangle, \langle \text{anti}A \rangle)$, where $\langle A \rangle$ is an item (idea, proposition, attribute, concept, etc.), $\langle \text{anti}A \rangle$ is its opposite, and $\langle \text{neut}A \rangle$ is the neutral between these opposites.

For example, in games we have such triads (where $\langle A \rangle =$ winning): winning, tie game, losing .

6. Numerical Counter-Example of Transforming a Single-Valued Neutrosophic set to a True-False Set

Let's take only one element from a single valued neutrosophic set (for the other elements it will be similar):

$$x_{NS}(0.3, 0.4, 0.2), \text{ hence } T_{NS}(x) = 0.3, I_{NS}(x) = 0.4, F_{NS}(x) = 0.2.$$

Let's transform it into a true-false set's element according to [1]:

$$x_{TFS}(0.3, [0.3, 0.4], 0.2, [0.2, 0.4]), \text{ hence } t_{TFS}(x) = 0.3, T_{TFS}(x) = [0.3, 0.4], f_{TFS}(x) = 0.2, F_{TFS}(x) = [0.2, 0.4].$$

The indeterminacy $I_{NS}(x) = 0.4$ into the neutrosophic set has been replaced into the true-false set by an interval-value truth $T_{TFS}(x) = [0.3, 0.4]$ and an interval-value falsehood $F_{TFS}(x) = [0.2, 0.4]$. But these are a totally different results.

If, with respect to an element, the indeterminacy-membership is 0.4, this is not equivalent with element's truth-membership be equal to $[0.3, 0.4]$ and its false-membership be equal to $[0.2, 0.4]$.

7. Other Counter -Examples

Let $x_{NS}(0.3, 0.4, 0.2)$ represent, with respect to the player x in a game where he plays against others, that his degree of winning ($T_{NS} = 0.3$), his degree of tie game ($I_{NS} = 0.4$), and his degree of losing ($F_{NS} = 0.2$).

By transforming x_{NS} to $x_{TFS}(0.3, [0.3, 0.4], 0.2, [0.2, 0.4])$, we get that with respect to the same player x , his degree of winning is 0.3 or $[0.3, 0.4]$, and his degree of losing is 0.2 or $[0.2, 0.4]$.

7.1. Therefore, the true-false set does not provide any degree of “tie game”, so this type of set is incomplete. The true-false set does not catch the middle side (neutrality, or indeterminacy) in between opposites.

7.2. Another drawback is that TFS increases the imprecision of the truth function: for $T_{NS} = 0.3$, it gets $T_{TFS} = 0.3$ or $[0.3, 0.4]$, so the truth value becomes vaguer after the TFS transformation.

TFS increases the imprecision of the falsehood function as well: for $F_{NS} = 0.2$, it gets $F_{TFS} = 0.2$ or $[0.2, 0.4]$, so the falsehood value becomes vaguer after the TFS transformation.

8. The True -False Set is a parti cular case of the Refined Neutrosophic Set

In the Refined Neutrosophic Set (Logic, Probability), T can be split into subcomponents T_1, T_2, \dots, T_p , and I into I_1, I_2, \dots, I_r , and F into F_1, F_2, \dots, F_s , where $p, r, s \in \{0, 1, 2, \dots\}$ and $p + r + s = n \in \{0, 1, 2, \dots\}$. By index $i = 0$, of a neutrosophic component T, I, or F, or any of their subcomponents, we denote the empty set, i.e. $T_0 = \emptyset, I_0 = \emptyset, F_0 = \emptyset$. The case (T_0, I_0, F_0) is the most degenerated one. See [4].

From (T, I, F) , where T, I, F are any subsets of $[0, 1]$, we replace $I_0 = \emptyset$ (empty set), and refine/split T into T_1 (single-valued truth component) and T_2 (as an interval-valued truth component), while F is similarly refined/split into F_1 (as a single-valued falsehood component) and F_2 (as an interval-valued falsehood component). Therefore, we replaced $p = 2, r = 0$, and $s = 2$ into the general form of the Refined Neutrosophic Set, and we found the True-False Set $(T_1, T_2, I_0 = \emptyset, F_1, F_2)$.

9. Conclusion

We proved that the transformation of the Neutrosophic Set into a True-False Set does not give equivalent results by using several counter-examples. Also, we proved that the True-False Set is a particular case of Refined Neutrosophic Set.

References

- [1] R. A Borzooei, M. Mohseni Taakallo, Y. B. Yun: True-False Sets, 2020 8th Iranian Joint Congress on Fuzzy and Intelligent Systems (FIS), September 204, 2020, Mashad, Iran, 5 pages.
- [2] F. Smarandache: Neutrosophy. Neutrosophic Probability, Set, and Logic. Rehoboth: American Research Press, 1998; <http://fs.unm.edu/eBook-Neutrosophics6.pdf>
- [3] F. Smarandache, Neutrosophic Overset, Neutrosophic Underset, and Neutrosophic Offset. Similarly for Neutrosophic Over-/Under-/Off- Logic, Probability, and Statistics, 168 p., Pons Editions, Bruxelles, Belgique, 2016; <https://arxiv.org/ftp/arxiv/papers/1607/1607.00234.pdf>, <https://hal.archives-ouvertes.fr/hal-01340830>
- [4] F. Smarandache: n-Valued Refined Neutrosophic Logic and Its Applications to Physics. Progress in Physics, 143-146, Vol. 4, 2013; arXiv:1407.1041 [cs.AI] 2013; <http://fs.unm.edu/RefinedNeutrosophicSet.pdf>

Neutrosophic Biminimal α -Open Sets

Selvaraj Ganesan, Florentin Smarandache

Selvaraj Ganesan, Florentin Smarandache (2021). Neutrosophic Biminimal α -Open Sets. *Bulletin of the International Mathematical Virtual Institute* 11(3), 545-553; DOI: 10.7251/BIMVI2103545G

ABSTRACT. In this article, we have introduced the notions of N_{mX}^j - α -open sets, α -interior and α -closure operators in neutrosophic biminimal structures. We investigate some basic properties and theorems of such notions. Also we have introduced the notion of N_{mX}^j - α -continuous maps and study characterizations of N_{mX}^j - α -continuous maps by using the α -interior and α -closure operators in neutrosophic biminimal structures.

1. Introduction

Zadehs [14] Fuzzy set laid the foundation of many theories such as intuitionistic fuzzy set and neutrosophic set, rough sets etc. Later, researchers developed K. T. Atanassovs [1] intuitionistic fuzzy set theory in many fields such as differential equations, topology, computer science and so on. F. Smarandache [12, 13] found that some objects have indeterminacy or neutral other than membership and non-membership. So he coined the notion of neutrosophy. Q. H. Imran et al [6] introduced and studied neutrosophic semi- α -open sets. R. Dhavaseelan et al [2] introduced and studied neutrosophic α^m -continuity. C. Maheswari and S. Chandrasekar [8] introduced and studied neutrosophic gb-closed sets and neutrosophic gb-continuity. Q. H. Imran et al [7] introduced and studied neutrosophic generalized alpha generalized continuity. M. H. Page and Q. H. Imran [9] introduced and studied neutrosophic generalized homeomorphism. The concept of minimal structure (in short, m-structure) was introduced by V. Popa and T. Noiri [10] in 2000. Also they introduced the notion of m_x -open set and m_x -closed set and characterize those sets using m_x -closure and m_x -interior operators respectively. Further they

introduced \mathcal{M} -continuous functions and studied some of its basic properties. S. Ganesan et al [4] introduced and studied the notion of neutrosophic biminimal structure spaces and also applications of neutrosophic biminimal structure spaces. S. Ganesan and F. Smarandache [5] introduced and studied neutrosophic biminimal semi-open sets. The main objective of this study is to introduce a new hybrid intelligent structure called neutrosophic biminimal α -open set. The significance of introducing hybrid structures is that the computational techniques, based on any one of these structures alone, will not always yield the best results but a fusion of two or more of them can often give better results. The rest of this article is organized as follows. Some preliminary concepts required in our work are briefly recalled in section 2. In section 3, the concept of N_{mX}^J - α -open set is investigated some properties with suitable example.

2. Preliminaries

DEFINITION 2.1. ([10]) A subfamily m_x of the power set $\wp(X)$ of a nonempty set X is called a minimal structure (in short, m-structure) on X if $\emptyset \in m_x$ and $X \in m_x$. By (X, m_x) , we denote a nonempty set X with a minimal structure m_x on X and call it an m-space. Each member of m_x is said to be m_x -open (or in short, m-open) and the complement of an m_x -open set is said to be m_x -closed (or in short, m-closed).

DEFINITION 2.2. ([12, 13]) A neutrosophic set (in short ns) K on a set $X \neq \emptyset$ is defined by $K = \{\prec a, P_K(a), Q_K(a), R_K(a) \succ : a \in X\}$ where $P_K : X \rightarrow [0,1]$, $Q_K : X \rightarrow [0,1]$ and $R_K : X \rightarrow [0,1]$ denotes the membership of an object, indeterminacy and non-membership of an object, for each $a \in X$ to K , respectively and $0 \leq P_K(a) + Q_K(a) + R_K(a) \leq 3$ for each $a \in X$.

DEFINITION 2.3. ([11]) Let $K = \{\prec a, P_K(a), Q_K(a), R_K(a) \succ : a \in X\}$ be a ns.

(1) A ns K is an empty set i.e., $K = 0_{\sim}$ if 0 is membership of an object and 0 is an indeterminacy and 1 is a non-membership of an object respectively. i.e., $0_{\sim} = \{x, (0, 0, 1) : x \in X\}$;

(2) A ns K is a universal set i.e., $K = 1_{\sim}$ if 1 is membership of an object and 1 is an indeterminacy and 0 is a non-membership of an object respectively. $1_{\sim} = \{x, (1, 1, 0) : x \in X\}$;

(3) $K_1 \cup K_2 = \{a, \max\{P_{K_1}(a), P_{K_2}(a)\}, \max\{Q_{K_1}(a), Q_{K_2}(a)\}, \min\{R_{K_1}(a), R_{K_2}(a)\} : a \in X\}$;

(4) $K_1 \cap K_2 = \{a, \min\{P_{K_1}(a), P_{K_2}(a)\}, \min\{Q_{K_1}(a), Q_{K_2}(a)\}, \max\{R_{K_1}(a), R_{K_2}(a)\} : a \in X\}$;

(5) $K^C = \{\prec a, R_K(a), 1 - Q_K(a), P_K(a) \succ : a \in X\}$.

DEFINITION 2.4. ([11]) A neutrosophic topology (nt) in Salamas sense on a nonempty set X is a family τ of ns in X satisfying three axioms:

- (1) Empty set (0_{\sim}) and universal set (1_{\sim}) are members of τ ;
- (2) $K_1 \cap K_2 \in \tau$ where $K_1, K_2 \in \tau$;

(3) $\cup K_\delta \in \tau$ for every $\{K_\delta : \delta \in \Delta\} \leq \tau$.

Each ns in nt are called neutrosophic open sets. Its complements are called neutrosophic closed sets.

DEFINITION 2.5. ([4]) Let X be a nonempty set and N_{mX}^1, N_{mX}^2 be nms on X . A triple (X, N_{mX}^1, N_{mX}^2) is called a neutrosophic biminimal structure space (in short, nbims)

DEFINITION 2.6. [4] Let (X, N_{mX}^1, N_{mX}^2) be a nbims and S be any neutrosophic set. Then

- (1) Every $S \in N_{mX}^j$ is open and its complement is closed, respectively, for $j = 1, 2$.
- (2) $N_{mcl_j}(S) = \min \{L : L \text{ is } N_{mX}^j\text{-closed set and } L \geq S\}$, respectively, for $j = 1, 2$.
- (3) $N_{mint_j}(S) = \max \{T : T \text{ is } N_{mX}^j\text{-open set and } T \leq S\}$, respectively, for $j = 1, 2$.

PROPOSITION 2.1 ([4]). Let (X, N_{mX}^1, N_{mX}^2) be a nbims and $A \leq X$. Then

- (1) $N_{mint_j}(0_\sim) = 0_\sim$
- (2) $N_{mint_j}(1_\sim) = 1_\sim$
- (3) $N_{mint_j}(A) \leq A$.
- (4) If $A \leq B$, then $N_{mint_j}(A) \leq N_{mint_j}(B)$.
- (5) A is N_{mX}^j -open if and only if $N_{mint_j}(A) = A$.
- (6) $N_{mint_j}(N_{mint_j}(A)) = N_{mint_j}(A)$.
- (7) $N_{mcl_j}(X - A) = X - N_{mint_j}(A)$ and $N_{mint_j}(X - A) = X - N_{mcl_j}(A)$.
- (8) $N_{mcl_j}(0_\sim) = 0_\sim$
- (9) $N_{mcl_j}(1_\sim) = 1_\sim$
- (10) $A \leq N_{mcl_j}(A)$.
- (11) If $A \leq B$, then $N_{mcl_j}(A) \leq N_{mcl_j}(B)$.
- (12) F is N_{mX}^j -closed if and only if $N_{mcl_j}(F) = F$.
- (13) $N_{mcl_j}(N_{mcl_j}(A)) = N_{mcl_j}(A)$.

DEFINITION 2.7. ([4]) Let (X, N_{mX}^1, N_{mX}^2) be a nbims and A be a subset of X . Then A is $N_{mX}^1 N_{mX}^2$ -closed if and only if $N_{mcl_1}(A) = A$ and $N_{mcl_2}(A) = A$.

PROPOSITION 2.2 ([4]). Let N_{mX}^1 and N_{mX}^2 be nms on X satisfying (Union Property). Then A is a $N_{mX}^1 N_{mX}^2$ -closed subset of a nbims (X, N_{mX}^1, N_{mX}^2) if and only if A is both N_{mX}^1 -closed and N_{mX}^2 -closed.

PROPOSITION 2.3 ([4]). Let (X, N_{mX}^1, N_{mX}^2) be a nbims. If A and B are $N_{mX}^1 N_{mX}^2$ -closed subsets of (X, N_{mX}^1, N_{mX}^2) , then $A \wedge B$ is $N_{mX}^1 N_{mX}^2$ -closed.

PROPOSITION 2.4 ([4]). Let (X, N_{mX}^1, N_{mX}^2) be a nbims. If A and B are $N_{mX}^1 N_{mX}^2$ -open subsets of (X, N_{mX}^1, N_{mX}^2) , then $A \vee B$ is $N_{mX}^1 N_{mX}^2$ -open.

DEFINITION 2.8. ([5]) A map $f : (X, N_{mX}^1, N_{mX}^2) \rightarrow (Y, N_{mY}^1, N_{mY}^2)$ is called N_{mX}^j -continuous map if and only if $f^{-1}(V) \in N_{mX}^j$ -open whenever $V \in N_{mY}^j$.

THEOREM 2.1 ([5]). *Let $f : X \rightarrow Y$ be a map on two nbims (X, N_{mX}^1, N_{mX}^2) and (Y, N_{mY}^1, N_{mY}^2) . Then the following statements are equivalent:*

- (1) *Identity map from (X, N_{mX}^1, N_{mX}^2) to (Y, N_{mY}^1, N_{mY}^2) is a nbims map.*
- (2) *Any constant map which map from (X, N_{mX}^1, N_{mX}^2) to (Y, N_{mY}^1, N_{mY}^2) is a nbims map.*

DEFINITION 2.9. ([5]) Let (X, N_{mX}^1, N_{mX}^2) be a nbims and $A \leq X$. A subset A of X is called an $N_{mX}^1 N_{mX}^2$ -semi-open (in short, N_{mX}^j -semi-open) set if $A \leq N_m cl_j(N_m int_j(A))$, respectively, for $j = 1, 2$.

The complement of an N_{mX}^j -semi-open set is called an N_{mX}^j -semi-closed set.

DEFINITION 2.10. ([5]) A map $f : (X, N_{mX}^1, N_{mX}^2) \rightarrow (Y, N_{mY}^1, N_{mY}^2)$ is called N_{mX}^j -semi-continuous map if and only if $f^{-1}(V) \in N_{mX}^j$ -semi-open whenever $V \in N_{mY}^j$.

3. $N_{mX}^1 N_{mX}^2$ - α -open sets

DEFINITION 3.1. Let (X, N_{mX}^1, N_{mX}^2) be a nbims and $A \leq X$. A subset A of X is called an $N_{mX}^1 N_{mX}^2$ - α -open (in short, N_{mX}^j - α -open) set if

$$A \leq N_m int_j(N_m cl_j(N_m int_j(A))), \text{ respectively, for } j = 1, 2.$$

The complement of an N_{mX}^j - α -open set is called an N_{mX}^j - α -closed set.

REMARK 3.1. Let (X, N_{mX}) be a nms and $A \leq X$. A is called an N_m - α -open set [3] if $A \leq N_m int(N_m cl(N_m int(A)))$. If the nms N_{mX} is a topology, clearly an N_{mX}^j - α -open set is N_m - α -open.

From Definition of 3.1, obviously the following statement are obtained.

LEMMA 3.1. *Let (X, N_{mX}^1, N_{mX}^2) be a nbims. Then*

- (1) *Every N_{mX}^j -open set is N_{mX}^j - α -open.*
- (2) *A is an N_{mX}^j - α -open set if and only if $A \leq N_m int_j(N_m cl_j(N_m int_j(A)))$.*
- (3) *Every N_{mX}^j -closed set is N_{mX}^j - α -closed.*
- (4) *A is an N_{mX}^j - α -closed set if and only if $N_m cl_j(N_m int_j(N_m cl_j(A))) \leq A$.*

THEOREM 3.1. *Let (X, N_{mX}^1, N_{mX}^2) be a nbims. Any union of N_{mX}^j - α -open sets is N_{mX}^j - α -open.*

PROOF. Let A_δ be an N_{mX}^j - α -open set for $\delta \in \Delta$. From Definition 3.1 and Proposition 2.1(4), it follows

$$A_\delta \leq N_m int_j(N_m cl_j(N_m int_j(A_\delta))) \leq N_m int_j(N_m cl_j(N_m int_j(\bigcup A_\delta))).$$

This implies

$$\bigcup A_\delta \leq N_m int_j(N_m cl_j(N_m int_j(\bigcup A_\delta))).$$

Hence $\bigcup A_\delta$ is an N_{mX}^j - α -open set. □

REMARK 3.2. Let (X, N_{mX}^1, N_{mX}^2) be a nbims. The intersection of any two N_{mX}^j - α -open sets may not be N_{mX}^j - α -open set as shown in the next example.

EXAMPLE 3.1. Let $X = \{a, b, c\}$ with

$$N_{mX}^1 = \{0_{\sim}, U, 1_{\sim}\}, (N_{mX}^1)^C = \{1_{\sim}, V, 0_{\sim}\} \text{ and}$$

$$N_{mX}^2 = \{0_{\sim}, O, 1_{\sim}\}, (N_{mX}^2)^C = \{1_{\sim}, P, 0_{\sim}\}$$

where

$$U = \prec (0.7, 0.4, 0.9), (0, 0.8, 0.2), (0.4, 0.6, 0.7) \succ$$

$$O = \prec (0.5, 0.6, 0.8), (0.2, 0.4, 0.6), (0.7, 0.5, 0) \succ$$

$$V = \prec (0.9, 0.6, 0.7), (0.2, 0.2, 0), (0.7, 0.4, 0.4) \succ$$

$$P = \prec (0.8, 0.4, 0.5), (0.6, 0.2, 0.2), (0, 0.5, 0.3) \succ$$

We know that

$$0_{\sim} = \{\prec x, 0, 0, 1 \succ : x \in X\}, 1_{\sim} = \{\prec x, 1, 1, 0 \succ : x \in X\}$$

and

$$0_{\sim}^C = \{\prec x, 1, 1, 0 \succ : x \in X\}, 1_{\sim}^C = \{\prec x, 0, 0, 1 \succ : x \in X\}.$$

Now we define the two N_{mX}^j - α -open sets as follows:

$$R_1 = \prec (0.7, 0.5, 0.6), (0.4, 0.8, 0.2), (0.8, 0.7, 0.5) \succ$$

$$R_2 = \prec (0.6, 0.3, 0.4), (0, 0.2, 0.1), (0.6, 0.6, 0.4) \succ$$

Here $N_{mint_j}(N_{mcl_j}(N_{mint_j}(R_1))) = 0_{\sim}$ and $N_{mint_j}(N_{mcl_j}(N_{mint_j}(R_2))) = 0_{\sim}$. But $R_1 \wedge R_2 = \prec (0.6, 0.3, 0.6), (0, 0.2, 0.2), (0.6, 0.6, 0.5) \succ$ is not a N_{mX}^j - α -open set in X . □

PROPOSITION 3.1. Let (X, N_{mX}^1, N_{mX}^2) be a nbims. If A is a N_{mX}^j - α -open set then it is a N_{mX}^j -semi-open set.

PROOF. The proof is straightforward from the definitions. □

DEFINITION 3.2. Let (X, N_{mX}^1, N_{mX}^2) be a nbims and S be any neutrosophic set. Then

- (1) Every $S \in N_{mX}^j$ is α -open and its complement is α -closed, respectively, for $j = 1, 2$.
- (2) $N_{m\alpha cl_j}(S) = \min\{L : L \text{ is } N_{mX}^j\text{-}\alpha\text{-closed set and } L \geq S\}$, respectively, for $j = 1, 2$.
- (3) $N_{m\alpha int_j}(S) = \max\{T : T \text{ is } N_{mX}^j\text{-}\alpha\text{-open set and } T \leq S\}$, respectively, for $j = 1, 2$.

THEOREM 3.2. Let (X, N_{mX}^1, N_{mX}^2) be a nbims and $A \leq X$. Then:

- (1) $N_{m\alpha int_j}(0_{\sim}) = 0_{\sim}$;
- (2) $N_{m\alpha int_j}(1_{\sim}) = 1_{\sim}$;
- (3) $N_{m\alpha int_j}(A) \leq A$;
- (4) If $A \leq B$, then $N_{m\alpha int_j}(A) \leq N_{m\alpha int_j}(B)$;
- (5) A is N_{mX}^j - α -open if and only if $N_{m\alpha int_j}(A) = A$;
- (6) $N_{m\alpha int_j}(N_{m\alpha int_j}(A)) = N_{m\alpha int_j}(A)$;
- (7) $N_{m\alpha cl_j}(X - A) = X - N_{m\alpha int_j}(A)$.

PROOF. (1), (2), (3), (4) Obvious.

(5) It follows from Theorem 3.1.

(6) It follows from (5).

(7) For $A \leq X$, we have

$$\begin{aligned} X - N_m \alpha \text{int}_j(A) &= X - \max\{U : U \leq A, U \text{ is } N_{mX}^j - \alpha - \text{open}\} \\ &= \min\{X - U : U \leq A, U \text{ is } N_{mX}^j - \alpha - \text{open}\} \\ &= \min\{XU : X - A \leq X - U, U \text{ is } N_{mX}^j - \alpha - \text{open}\} = N_m \alpha \text{cl}_j(X - A). \quad \square \end{aligned}$$

THEOREM 3.3. Let (X, N_{mX}^1, N_{mX}^2) be a nbims and $A \leq X$. Then:

- (1) $N_m \alpha \text{cl}_j(0_\sim) = 0_\sim$;
- (2) $N_m \alpha \text{cl}_j(1_\sim) = 1_\sim$;
- (3) $A \leq N_m \alpha \text{cl}_j(A)$;
- (4) If $A \leq B$, then $N_m \alpha \text{cl}_j(A) \leq N_m \alpha \text{cl}_j(B)$;
- (5) F is $N_{mX}^j - \alpha$ -closed if and only if $N_m \alpha \text{cl}_j(F) = F$;
- (6) $N_m \alpha \text{cl}_j(N_m \alpha \text{cl}_j(A)) = N_m \alpha \text{cl}_j(A)$;
- (7) $N_m \alpha \text{int}_j(X - A) = X - N_m \alpha \text{cl}_j(A)$.

PROOF. It is similar to the proof of Theorem 3.2. □

THEOREM 3.4. Let (X, N_{mX}^1, N_{mX}^2) be a nbims and $A \leq X$. Then:

- (1) $x \in N_m \alpha \text{cl}_j(A)$ if and only if $A \cap V \neq \emptyset$ for every $N_{mX}^j - \alpha$ -open set V containing x .
- (2) $x \in N_m \alpha \text{int}_j(A)$ if and only if there exists an $N_{mX}^j - \alpha$ -open set U such that $U \leq A$.

PROOF. (1) Suppose there is an $N_{mX}^j - \alpha$ -open set V containing x such that $A \cap V = \emptyset$. Then $X - V$ is an $N_{mX}^j - \alpha$ -closed set such that $A \leq X - V$, $x \notin X - V$. This implies $x \notin N_m \alpha \text{cl}_j(A)$. The reverse relation is obvious.

(2) Obvious. □

LEMMA 3.2. Let (X, N_{mX}^1, N_{mX}^2) be a nbims and $A \leq X$. Then

- (1) $N_m \text{cl}_j(N_m \text{int}_j(N_m \text{cl}_j(A))) \leq N_m \text{cl}_j(N_m \text{int}_j(N_m \text{cl}_j(N_m \alpha \text{cl}_j(A)))) \leq N_m \alpha \text{cl}_j(A)$.
- (2) $N_m \alpha \text{int}_j(A) \leq N_m \text{int}_j(N_m \text{cl}_j(N_m \text{int}_j(N_m \alpha \text{int}_j(A)))) \leq N_m \text{int}_j(N_m \text{cl}_j(N_m \text{int}_j(A)))$.

PROOF. (1) For $A \leq X$, by Theorem 3.3, $N_m \alpha \text{cl}_j(A)$ is an $N_{mX}^j - \alpha$ -closed set. Hence from Lemma 3.1, we have

$$N_m \text{cl}_j(N_m \text{int}_j(N_m \text{cl}_j(A))) \leq N_m \text{cl}_j(N_m \text{int}_j(N_m \text{cl}_j(N_m \alpha \text{cl}_j(A)))) \leq N_m \alpha \text{cl}_j(A).$$

(2) It is similar to the proof of (1). □

DEFINITION 3.3. A map $f : (X, N_{mX}^1, N_{mX}^2) \rightarrow (Y, N_{mY}^1, N_{mY}^2)$ is called $N_{mX}^j - \alpha$ -continuous map if and only if $f^{-1}(V) \in N_{mX}^j - \alpha$ -open whenever $V \in N_{mY}^j$.

THEOREM 3.5. (1) Every N_{mX}^j -continuous is N_{mX}^j - α -continuous but the conversely.

(2) Every N_{mX}^j - α -continuous is N_{mX}^j -semi-continuous but not conversely.

PROOF. (1) The proof follows from Lemma 3.1 (1).

(2) The proof follows from Proposition 3.1. □

THEOREM 3.6. Let $f : X \rightarrow Y$ be a map on two nbims (X, N_{mX}^1, N_{mX}^2) and (Y, N_{mY}^1, N_{mY}^2) . Then the following statements are equivalent:

- (1) f is N_{mX}^j - α -continuous.
- (2) $f^{-1}(V)$ is an N_{mX}^j - α -open set for each N_{mX}^j -open set V in Y .
- (3) $f^{-1}(B)$ is an N_{mX}^j - α -closed set for each N_{mX}^j -closed set B in Y .
- (4) $f(N_m\alpha cl_j(A)) \leq N_m cl_j(f(A))$ for $A \leq X$.
- (5) $N_m\alpha cl_j(f^{-1}(B)) \leq f^{-1}(N_m cl_j(B))$ for $B \leq Y$.
- (6) $f^{-1}(N_m int_j(B)) \leq N_m\alpha int_j(f^{-1}(B))$ for $B \leq Y$.

PROOF. (1) \Rightarrow (2) Let V be an N_{mX}^j -open set in Y and $x \in f^{-1}(V)$. By hypothesis, there exists an N_{mX}^j - α -open set U_x containing x such that $f(U_x) \leq V$. This implies $x \in U_x \leq f^{-1}(V)$ for all $x \in f^{-1}(V)$. Hence by Theorem 3.1, $f^{-1}(V)$ is N_{mX}^j - α -open.

(2) \Rightarrow (3) Obvious.

(3) \Rightarrow (4) For $A \leq X$, $f^{-1}(N_m cl_j(f(A))) = f^{-1}(\min\{F \leq Y : f(A) \leq F \text{ and } F \text{ is } N_{mX}^j\text{-closed}\}) = \min\{f^{-1}(F) \leq X : A \leq f^{-1}(F) \text{ and } F \text{ is } N_{mX}^j\text{-}\alpha\text{-closed}\} \geq \min\{K \leq X : A \leq K \text{ and } K \text{ is } N_{mX}^j\text{-}\alpha\text{-closed}\} = N_m\alpha cl_j(A)$. Hence $f(N_m\alpha cl_j(A)) \leq N_m cl_j(f(A))$.

(4) \Rightarrow (5) For $A \leq X$, from (4), it follows

$$f(N_m\alpha cl_j(f^{-1}(A))) \leq N_m cl_j(f(f^{-1}(A))) \leq N_m cl_j(A).$$

Hence, we get (5).

(5) \Rightarrow (6) For $B \leq Y$, from $N_m int_j(B) = Y - N_m cl_j(Y - B)$ and (5), it follows $f^{-1}(N_m int_j(B)) = f^{-1}(Y - N_m cl_j(Y - B)) = X - f^{-1}(N_m cl_j(Y - B)) \leq X - N_m\alpha cl_j(f^{-1}(Y - B)) = N_m\alpha int_j(f^{-1}(B))$. Hence (6) is obtained.

(6) \Rightarrow (1) Let $x \in X$ and V an N_{mX}^j -open set containing $f(x)$. Then from (6) and Proposition 2.1, it follows

$$x \in f^{-1}(V) = f^{-1}(N_m int_j(V)) \leq N_m\alpha int_j(f^{-1}(V)).$$

So from Theorem 3.4, we can say that there exists an N_{mX}^j - α -open set U containing x such that $x \in U \leq f^{-1}(V)$. Hence, f is N_{mX}^j - α -continuous. □

THEOREM 3.7. Let $f : X \rightarrow Y$ be a map on two nbims (X, N_{mX}^1, N_{mX}^2) and (Y, N_{mY}^1, N_{mY}^2) . Then the following statements are equivalent:

- (1) f is N_{mX}^j - α -continuous.
- (2) $f^{-1}(V) \leq N_m cl_j(N_m int_j(f^{-1}(V)))$ for each N_{mX}^j -open set V in Y .
- (3) $N_m cl_j(N_m int_j(N_m cl_j(f^{-1}(F)))) \leq f^{-1}(F)$ for each N_{mX}^j -closed set F in Y .

- (4) $f(N_m cl_j(N_m int_j(N_m cl_j(A))) \leq N_m cl_j(f(A))$ for $A \leq X$.
- (5) $N_m cl_j(N_m int_j(N_m cl_j(f^{-1}(B)))) \leq f^{-1}(N_m cl_j(B))$ for $B \leq Y$.
- (6) $f^{-1}(N_m int_j(B)) \leq N_m int_j(N_m cl_j(N_m int_j(f^{-1}(B))))$ for $B \leq Y$.

PROOF. (1) \Leftrightarrow (2) It follows from Theorem 3.6 and Definition of N_{mX}^j - α -open sets.

(1) \Leftrightarrow (3) It follows from Theorem 3.6 and Lemma 3.1.

(3) \Rightarrow (4) Let $A \leq X$. Then from Theorem 3.6(4) and Lemma 3.2, it follows $N_m cl_j(N_m int_j(N_m cl_j(A))) \leq N_m \alpha cl_j(A) \leq f^{-1}(N_m cl_j(f(A)))$. Hence

$$f(N_m cl_j(N_m int_j(N_m cl_j(A)))) \leq N_m cl_j(f(A)).$$

(4) \Rightarrow (5) Obvious.

(5) \Rightarrow (6) From (5) and Proposition 2.1, it follows: $f^{-1}(N_m int_j(B)) = f^{-1}(Y - N_m cl_j(Y - B)) = X - f^{-1}(N_m cl_j(Y - B)) \leq X - N_m cl_j(N_m int_j(N_m cl_j(f^{-1}(Y - B)))) = N_m int_j(N_m cl_j(N_m int_j(f^{-1}(B))))$. Hence, (6) is obtained.

(6) \Rightarrow (1) Let V be an N_{mX}^j -open set in Y . Then by (6) and Proposition 2.1, we have $f^{-1}(V) = f^{-1}(N_m int_j(V)) \leq N_m int_j(N_m cl_j(N_m int_j(f^{-1}(V))))$. This implies $f^{-1}(V)$ is an N_{mX}^j - α -open set. Hence by (2), f is N_{mX}^j - α -continuous. \square

4. Conclusion

Neutrosophic set is a general formal framework, which generalizes the concept of classic set, fuzzy set, interval valued fuzzy set, intuitionistic fuzzy set, and interval intuitionistic fuzzy set. Since the world is full of indeterminacy, the neutrosophic biminimal structures found its place into contemporary research world. This article can be further developed into several possible such as Geographical Information Systems (GIS) field including remote sensing, object reconstruction from airborne laser scanner, real time tracking, routing applications and modeling cognitive agents. In GIS there is a need to model spatial regions with indeterminate boundary and under indeterminacy. Hence this N_{mX}^j - α -open set can also be extended to a neutrosophic spatial region.

References

- [1] K. T. Atanassov. Intuitionistic fuzzy sets. *Fuzzy Sets Syst.*, **20**(1)(1986), 87–96.
- [2] R. Dhavaseelan, R. Narmada Devi, S. Jafari and Q. H. Imran. Neutrosophic α^m -continuity. *Neutrosophic Sets and Systems*, **27**(2019), 171–179.
- [3] S. Ganesan and F. Smarandache. On N_{mX} - α -open sets in neutrosophic minimal structure spaces. *Journal of Mathematics and computational intelligence (JMCI)* (Submitted).
- [4] S. Ganesan and C. Alexander. Neutrosophic biminimal structure spaces. *Journal of Mathematics and computational intelligence (JMCI)* (Accepted).
- [5] S. Ganesan and F. Smarandache. Neutrosophic biminimal semi-open sets. (*communicated*).
- [6] Q. H. Imran, F. Smarandache, R. K. Al-Hamido and R. Dhavaseelan. On neutrosophic semi- α -open sets. *Neutrosophic Sets and Systems*, **18**(2017), 37–42.

- [7] Q. H. Imran, R. Dhavaseelan, A. H. M. Al-Obaidi and M. H. Page. On neutrosophic generalized alpha generalized continuity. *Neutrosophic Sets and Systems*, **35**(2020), 511–521.
- [8] C. Maheswari and S. Chandrasekar. Neutrosophic gb-closed sets and neutrosophic gb-continuity. *Neutrosophic Sets and Systems*, **29**(2019), 89–100.
- [9] M. H. Page and Q. H. Imran. Neutrosophic generalized homeomorphism. *Neutrosophic Sets and Systems*, **35**(2020), 340–346.
- [10] V. Popa and T. Noiri. On \mathcal{M} -continuous functions. *Anal. Univ. "Dunarea de Jos" Galati, Ser. Mat. Fiz. Mec. Teor., Fasc. II*, **18**(23)(2000), 31–41.
- [11] A. A. Salama and S. A. Alblowi. Neutrosophic set and neutrosophic topological spaces. *IOSR J. Math.*, **3**(2012), 31–35.
- [12] F. Smarandache. Neutrosophy and neutrosophic logic. *First International Conference on Neutrosophy, Neutrosophic Logic Set, Probability and Statistics, University of New Mexico, Gallup, NM, USA*(2002).
- [13] F. Smarandache. A Unifying Field in Logics: Neutrosophic logic. *Neutrosophy, neutrosophic set, neutrosophic probability*. American Research Press: Rehoboth, NM, USA(1999).
- [14] L. A. Zadeh. Fuzzy Sets. *Information and control*, **18**(1965), 338-353.

On Neutrosophic Generalized Semi Generalized Closed Sets

Qays Hatem Imran, Ali H. M. Al-Obaidi, Florentin Smarandache, Said Broumi

Qays Hatem Imran, Ali H. M. Al-Obaidi, Florentin Smarandache, Said Broumi (2022). On Neutrosophic Generalized Semi Generalized Closed Sets. *International Journal of Neutrosophic Science* 18(3), 10-20; DOI: 10.54216/IJNS.18030101

Abstract

The article considers a new generalization of closed sets in neutrosophic topological space. This generalization is called neutrosophic gsg -closed set. Moreover, we discuss its essential features in neutrosophic topological spaces. Furthermore, we extend the research by displaying new related definitions such as neutrosophic gsg -closure and neutrosophic gsg -interior and debating their powerful characterizations and relationships.

Keywords: $Neu^{gsg}CS$, $Neu^{gsg}OS$, Neu^{gsg} -closure and Neu^{gsg} -interior.

1. Introduction

The neutrosophic set theory was contributed by Smarandache in [1,2]. The neutrosophic topological space (simply Neu^{TS}) was offered by Salama et al. in [3]. The definition of semi- α -open sets in neutrosophic topological spaces was displayed by Imran et al. in [4]. The neutrosophic generalized homeomorphism was submitted by PAGE et al. in [5]. The class of generalized neutrosophic closed sets was given by Dhavaseelan et al. in [6]. The concepts of neutrosophic generalized αg -closed sets and neutrosophic generalized αg -continuous functions were provided by Imran et al. in [7]. The objective of this article is to show the sense of neutrosophic gsg -closed set (briefly $Neu^{gsg}CS$) and investigate their main characteristics in Neu^{TS} . Moreover, we argue neutrosophic gsg -closure (in word Neu^{gsg} -closure) and neutrosophic gsg -interior (fleetingly Neu^{gsg} -interior) with revealing several of their vital spots.

. Preliminaries

In this work, (\mathcal{U}, ζ) (or simply \mathcal{U}) always mean Neu^{TS} . Let \mathfrak{P} be a neutrosophic set in a $Neu^{TS}(\mathcal{U}, \zeta)$, we denote the neutrosophic closure, the neutrosophic interior, and the neutrosophic complement of \mathfrak{P} by $NeuCl(\mathfrak{P})$, $NeuInt(\mathfrak{P})$ and $\mathfrak{P}^c = 1_{Neu} - \mathfrak{P}$, respectively.

Definition 2.1: [3]

The family ζ of neutrosophic subsets of a non-empty neutrosophic set $\mathcal{U} \neq \emptyset$ is called a neutrosophic topology (in short, Neu^T) on \mathcal{U} if it satisfies the below axioms:

- (i) $0_{Neu}, 1_{Neu} \in \zeta$,
- (ii) $\mathfrak{P}_1 \cap \mathfrak{P}_2 \in \zeta$ being $\mathfrak{P}_1, \mathfrak{P}_2 \in \zeta$,
- (iii) $\cup \mathfrak{P}_i \in \zeta$ for arbitrary family $\{\mathfrak{P}_i | i \in \Lambda\} \subseteq \zeta$.

In this case, we signified Neu^{TS} by (\mathcal{U}, ζ) or \mathcal{U} . Moreover, the neutrosophic set in ζ is named neutrosophic open (in short, $NeuOS$). Furthermore, for any $NeuOS$ \mathfrak{P} , then \mathfrak{P}^c is titled neutrosophic closed set (briefly, $NeuCS$) in \mathcal{U} .

Definition 2.2:

Let \mathfrak{P} be a neutrosophic subset of a $Neu^{TS}(\mathcal{U}, \zeta)$, then it is called to be:

- (i) a neutrosophic semi-open set and denoted by Neu^sOS if $\mathfrak{P} \subseteq NeuCl(NeuInt(\mathfrak{P}))$. [8]
- (ii) a neutrosophic semi-closed set and denoted by Neu^sCS if $NeuInt(NeuCl(\mathfrak{P})) \subseteq \mathfrak{P}$. The intersection of entire Neu^sCS s, including \mathfrak{P} is named a neutrosophic semi-closure, and it is symbolized by $Neu^sCl(\mathfrak{P})$. [8]
- (iii) a neutrosophic α -open set and denoted by $Neu^\alpha OS$ if $\mathfrak{P} \subseteq NeuInt(NeuCl(NeuInt(\mathfrak{P})))$. [9]
- (iv) a neutrosophic α -closed set and denoted by $Neu^\alpha CS$ if $NeuCl(NeuInt(NeuCl(\mathfrak{P}))) \subseteq \mathfrak{P}$. The intersection of the whole $Neu^\alpha CS$ s including \mathfrak{P} is named neutrosophic α -closure, and it is symbolized by $Neu^\alpha Cl(\mathfrak{P})$. [9]

Definition 2.3:

Let \mathfrak{P} be a neutrosophic subset of a $Neu^{TS}(\mathcal{U}, \zeta)$, and let \mathfrak{M} be a $NeuOS$ in (\mathcal{U}, ζ) such that $\mathfrak{P} \subseteq \mathfrak{M}$ then \mathfrak{P} is called to be:

- (i) a neutrosophic generalized closed set, and it is denoted by Neu^gCS if $NeuCl(\mathfrak{P}) \subseteq \mathfrak{M}$. The complement of a Neu^gCS is a Neu^gOS in (\mathcal{U}, ζ) . [10]
- (ii) a neutrosophic αg -closed set, and it is denoted by $Neu^{\alpha g}CS$ if $Neu^\alpha Cl(\mathfrak{P}) \subseteq \mathfrak{M}$. The complement of a $Neu^{\alpha g}CS$ is a $Neu^{\alpha g}OS$ in (\mathcal{U}, ζ) . [11]
- (iii) a neutrosophic $g\alpha$ -closed set, and it is denoted by $Neu^{g\alpha}CS$ if $Neu^\alpha Cl(\mathfrak{P}) \subseteq \mathfrak{M}$. The complement of a $Neu^{g\alpha}CS$ is a $Neu^{g\alpha}OS$ in (\mathcal{U}, ζ) . [12]
- (iv) a neutrosophic sg -closed set, and it is denoted by $Neu^{sg}CS$ if $Neu^sCl(\mathfrak{P}) \subseteq \mathfrak{M}$. The complement of a $Neu^{sg}CS$ is a $Neu^{sg}OS$ in (\mathcal{U}, ζ) . [13]
- (v) a neutrosophic gs -closed set, and it is denoted by $Neu^{gs}CS$ if $Neu^gCl(\mathfrak{P}) \subseteq \mathfrak{M}$. The complement of a $Neu^{gs}CS$ is a $Neu^{gs}OS$ in (\mathcal{U}, ζ) . [14]

Proposition 2.4:[9,10]

In a $Neu^{TS}(\mathcal{U}, \zeta)$, then the next arguments stand, and the opposite of every argument is not valid:

- (i) Each $NeuOS$ (resp. $NeuCS$) is a $Neu^\alpha OS$ (resp. $Neu^\alpha CS$).
- (ii) Each $NeuOS$ (resp. $NeuCS$) is a Neu^gOS (resp. Neu^gCS).

(iii) Each $Neu^\alpha OS$ (resp. $Neu^\alpha CS$) is a $Neu^s OS$ (resp. $Neu^s CS$).

Proposition 2.5:[11,12]

In a $Neu^{TS}(\mathcal{U}, \zeta)$, then the next arguments stand, and the opposite of every argument is not valid:

- (i) Each $Neu^\theta OS$ (resp. $Neu^\theta CS$) is a $Neu^{\alpha\theta} OS$ (resp. $Neu^{\alpha\theta} CS$).
- (ii) Each $Neu^\alpha OS$ (resp. $Neu^\alpha CS$) is a $Neu^{\theta\alpha} OS$ (resp. $Neu^{\theta\alpha} CS$).
- (iii) Each $Neu^{\theta\alpha} OS$ (resp. $Neu^{\theta\alpha} CS$) is a $Neu^{\alpha\theta} OS$ (resp. $Neu^{\alpha\theta} CS$).

Proposition 2.6:[13-15]

In a $Neu^{TS}(\mathcal{U}, \zeta)$, then the next arguments stand, and the opposite of every argument is not valid:

- (i) Each $Neu^\theta OS$ (resp. $Neu^\theta CS$) is a $Neu^{\theta s} OS$ (resp. $Neu^{\theta s} CS$).
- (ii) Each $Neu^s OS$ (resp. $Neu^s CS$) is a $Neu^{s\theta} OS$ (resp. $Neu^{s\theta} CS$).
- (iii) Each $Neu^{s\theta} OS$ (resp. $Neu^{s\theta} CS$) is a $Neu^{\theta s} OS$ (resp. $Neu^{\theta s} CS$).
- (iv) Each $Neu^{\theta\alpha} OS$ (resp. $Neu^{\theta\alpha} CS$) is a $Neu^{\theta s} OS$ (resp. $Neu^{\theta s} CS$).

3. Neutrosophic Generalized sg -Closed Sets

In this sector, we present and analyse the neutrosophic generalized sg -closed sets and some of their features.

Definition 3.1:

Suppose that \mathfrak{B} is a neutrosophic set in a $Neu^{TS}(\mathcal{U}, \zeta)$ and assume that \mathfrak{M} is a $Neu^{sg} OS$ in (\mathcal{U}, ζ) where $\mathfrak{B} \sqsubseteq \mathfrak{M}$. The set \mathfrak{B} is termed as a neutrosophic generalized sg -closed set, and it is signified by $Neu^{sg} CS$ if $NeuCl(\mathfrak{B}) \sqsubseteq \mathfrak{M}$. The collection of all $Neu^{sg} CS$ s in a $Neu^{TS}(\mathcal{U}, \zeta)$ is signified by $Neu^{sg} C(\mathcal{U})$.

Theorem 3.2:

In a $Neu^{TS}(\mathcal{U}, \zeta)$, the subsequent arguments are valid:

- (i) Each $NeuCS$ is a $Neu^{sg} CS$.
- (ii) Each $Neu^{sg} CS$ is a $Neu^\theta CS$.

Proof:

(i) Let $NeuCS \mathfrak{B}$ and $Neu^{sg} OS \mathfrak{M}$ be in a $Neu^{TS}(\mathcal{U}, \zeta)$ where $\mathfrak{B} \sqsubseteq \mathfrak{M}$. Then $NeuCl(\mathfrak{B}) = \mathfrak{B} \sqsubseteq \mathfrak{M}$. Therefore \mathfrak{B} is a $Neu^{sg} CS$.

(ii) Let $Neu^{sg} CS \mathfrak{B}$ and $NeuOS \mathfrak{M}$ be in a $Neu^{TS}(\mathcal{U}, \zeta)$ where $\mathfrak{B} \sqsubseteq \mathfrak{M}$. Because each $NeuOS$ is a $Neu^{sg} OS$, we get $NeuCl(\mathfrak{B}) \sqsubseteq \mathfrak{M}$. Consequently, \mathfrak{B} is a $Neu^\theta CS$. ■

The reverse of the above theorem is inaccurate, as displayed in the subsequent instances.

Example 3.3:

Suppose that $\mathcal{U} = \{u_1, u_2\}$ is a set and assume that $\zeta = \{0_{Neu}, \mathfrak{P}_1, \mathfrak{P}_2, 1_{Neu}\}$ is a Neu^T defined on \mathcal{U} . Suppose that we have the sets $\mathfrak{P}_1 = \langle u, (0.6, 0.7), (0.1, 0.1), (0.4, 0.2) \rangle$ and $\mathfrak{P}_2 = \langle u, (0.1, 0.2), (0.1, 0.1), (0.8, 0.8) \rangle$ are given. Then the neutrosophic set $\mathfrak{P}_3 = \langle u, (0.2, 0.2), (0.1, 0.1), (0.6, 0.7) \rangle$ is a $Neu^{sg} CS$. However, this latter set is not a $NeuCS$.

Example 3.4:

Suppose that $\mathcal{U} = \{u_1, u_2, u_3\}$ is a set and assume that $\zeta = \{0_{Neu}, \mathfrak{P}_1, \mathfrak{P}_2, 1_{Neu}\}$ is a Neu^T defined on \mathcal{U} . Suppose that we have the following sets $\mathfrak{P}_1 = \langle u, (0.5, 0.5, 0.4), (0.7, 0.5, 0.5), (0.4, 0.5, 0.5) \rangle$ and $\mathfrak{P}_2 =$

$\langle u, (0.3,0.4,0.4), (0.4,0.5,0.5), (0.3,0.4,0.6) \rangle$ are given. Then the neutrosophic set $\mathfrak{P}_3 = \langle u, (0.4,0.6,0.5), (0.4,0.3,0.5), (0.5,0.6,0.4) \rangle$ is a $Neu^{\mathcal{G}}CS$. However, this latter set is not a $Neu^{\mathcal{G}^s\mathcal{G}}CS$.

Theorem 3.5:

In a $Neu^{T^S}(\mathcal{U}, \zeta)$, the subsequent arguments are valid:

- (i) Each $Neu^{\mathcal{G}^s\mathcal{G}}CS$ is a $Neu^{\alpha\mathcal{G}}CS$.
- (ii) Each $Neu^{\mathcal{G}^s\mathcal{G}}CS$ is a $Neu^{\mathcal{G}^{\alpha}}CS$.
- (iii) Each $Neu^{\mathcal{G}^s\mathcal{G}}CS$ is a $Neu^{\mathcal{G}^s}CS$.
- (iv) Each $Neu^{\mathcal{G}^s\mathcal{G}}CS$ is a $Neu^{\mathcal{G}^s}CS$.

Proof:

- (i) Let $Neu^{\mathcal{G}^s\mathcal{G}}CS \mathfrak{P}$ and $NeuOS \mathfrak{M}$ be in a $Neu^{T^S}(\mathcal{U}, \zeta)$ where $\mathfrak{P} \sqsubseteq \mathfrak{M}$. Because each $NeuOS$ is a $Neu^{\alpha\mathcal{G}}CS$, we get $Neu^{\alpha}Cl(\mathfrak{P}) \sqsubseteq NeuCl(\mathfrak{P}) \sqsubseteq \mathfrak{M}$. The latter implies $Neu^{\alpha}Cl(\mathfrak{P}) \sqsubseteq \mathfrak{M}$. Consequently, \mathfrak{P} is a $Neu^{\alpha\mathcal{G}}CS$.
- (ii) Let $Neu^{\mathcal{G}^s\mathcal{G}}CS \mathfrak{P}$ and $Neu^{\alpha}OS \mathfrak{M}$ be in a $Neu^{T^S}(\mathcal{U}, \zeta)$ where $\mathfrak{P} \sqsubseteq \mathfrak{M}$. Because each $Neu^{\alpha}OS$ is a Neu^sOS , which is a $Neu^{\mathcal{G}^s}OS$, we get $Neu^{\alpha}Cl(\mathfrak{P}) \sqsubseteq NeuCl(\mathfrak{P}) \sqsubseteq \mathfrak{M}$. The latter implies $Neu^{\alpha}Cl(\mathfrak{P}) \sqsubseteq \mathfrak{M}$. Consequently, \mathfrak{P} is a $Neu^{\mathcal{G}^{\alpha}}CS$.
- (iii) Let $Neu^{\mathcal{G}^s\mathcal{G}}CS \mathfrak{P}$ and $Neu^sOS \mathfrak{M}$ be in a $Neu^{T^S}(\mathcal{U}, \zeta)$ where $\mathfrak{P} \sqsubseteq \mathfrak{M}$. Because each Neu^sOS is a $Neu^{\mathcal{G}^s}OS$, we get $Neu^sCl(\mathfrak{P}) \sqsubseteq NeuCl(\mathfrak{P}) \sqsubseteq \mathfrak{M}$. The latter implies $Neu^sCl(\mathfrak{P}) \sqsubseteq \mathfrak{M}$. Consequently, \mathfrak{P} is a $Neu^{\mathcal{G}^s}CS$.
- (iv) Let $Neu^{\mathcal{G}^s\mathcal{G}}CS \mathfrak{P}$ and $NeuOS \mathfrak{M}$ be in a $Neu^{T^S}(\mathcal{U}, \zeta)$ where $\mathfrak{P} \sqsubseteq \mathfrak{M}$. Because each $NeuOS$ is a $Neu^{\mathcal{G}^s}OS$, we get $Neu^sCl(\mathfrak{P}) \sqsubseteq NeuCl(\mathfrak{P}) \sqsubseteq \mathfrak{M}$. That implies $Neu^sCl(\mathfrak{P}) \sqsubseteq \mathfrak{M}$. Consequently, \mathfrak{P} is a $Neu^{\mathcal{G}^s}CS$. ■

The reverse of the above theorem is inaccurate, as displayed in the subsequent instances.

Example 3.6:

Let $\mathcal{U} = \{u_1, u_2\}$ be a set and assume that $\zeta = \{0_{Neu}, \mathfrak{P}_1, \mathfrak{P}_2, 1_{Neu}\}$ is a Neu^T defined on \mathcal{U} . Suppose that we have the following sets $\mathfrak{P}_1 = \langle u, (0.5,0.6), (0.3,0.2), (0.4,0.1) \rangle$ and $\mathfrak{P}_2 = \langle u, (0.4,0.4), (0.4,0.3), (0.5,0.4) \rangle$ are given. Then the neutrosophic set $\mathfrak{P}_3 = \langle u, (0.5,0.4), (0.4,0.4), (0.4,0.5) \rangle$ is a $Neu^{\alpha\mathcal{G}}CS$ and hence $Neu^{\mathcal{G}^{\alpha}}CS$ but not a $Neu^{\mathcal{G}^s\mathcal{G}}CS$.

Example 3.7:

Let $\mathcal{U} = \{u_1, u_2\}$ and let $\zeta = \{0_{Neu}, \mathfrak{P}_1, 1_{Neu}\}$ be a Neu^T on \mathcal{U} . Take $\mathfrak{P}_1 = \langle u, (0.3,0.4,0.6), (0.6,0.6,0.4) \rangle$. Then the neutrosophic set $\mathfrak{P}_2 = \langle u, (0.3,0.2,0.5), (0.6,0.6,0.8) \rangle$ is a $Neu^{\mathcal{G}^s}CS$ but not a $Neu^{\mathcal{G}^s\mathcal{G}}CS$.

Example 3.8:

Let $\mathcal{U} = \{u_1, u_2\}$ and let $\zeta = \{0_{Neu}, \mathfrak{P}_1, 1_{Neu}\}$ be a Neu^T on \mathcal{U} . Where $\mathfrak{P}_1 = \langle u, (0.3,0.2,0.3), (0.8,0.6,0.7) \rangle$. Then the neutrosophic set $\mathfrak{P}_2 = \langle u, (0.3,0.2,0.6), (0.8,0.9,0.8) \rangle$ is a $Neu^{\mathcal{G}^s}CS$. However, this latter set is not a $Neu^{\mathcal{G}^s\mathcal{G}}CS$.

Remark 3.9:

The $Neu^{\mathcal{G}^s\mathcal{G}}CS$ are independent of $Neu^{\alpha}CS$ and Neu^sCS .

Definition 3.10:

A neutrosophic subset \mathfrak{P} of a $Neu^{T^S}(\mathcal{U}, \zeta)$ is called a neutrosophic generalized $s\mathcal{G}$ -open set (in short, $Neu^{\mathcal{G}^s\mathcal{G}}OS$) iff $1_{Neu} - \mathfrak{P}$ is a $Neu^{\mathcal{G}^s\mathcal{G}}CS$. The collection of entire $Neu^{\mathcal{G}^s\mathcal{G}}OS$ s of a $Neu^{T^S}(\mathcal{U}, \zeta)$ is signified by $Neu^{\mathcal{G}^s\mathcal{G}}O(\mathcal{U})$.

Proposition 3.11:

Let \mathfrak{P} be a $NeuOS$ in $Neu^{T^S}(\mathcal{U}, \zeta)$, then this set \mathfrak{P} is $Neu^{\mathcal{G}^s\mathcal{G}}OS$ in the space (\mathcal{U}, ζ) .

Proof:

Let \mathfrak{P} be a *NeuOS* in a $Neu^{TS}(\mathcal{U}, \zeta)$, then $1_{Neu} - \mathfrak{P}$ is a *NeuCS* in (\mathcal{U}, ζ) . According to theorem (3.2), point (i), $1_{Neu} - \mathfrak{P}$ is a *Neu^{gsg}CS*. Therefore, \mathfrak{P} is a *Neu^{gsg}OS* in (\mathcal{U}, ζ) . ■

Proposition 3.12:

Let \mathfrak{P} be a *Neu^{gsg}OS* in $Neu^{TS}(\mathcal{U}, \zeta)$, then this set \mathfrak{P} is *Neu^gOS* in the space (\mathcal{U}, ζ) .

Proof:

Let \mathfrak{P} be a *Neu^{gsg}OS* in a $Neu^{TS}(\mathcal{U}, \zeta)$, then $1_{Neu} - \mathfrak{P}$ is a *Neu^{gsg}CS* in (\mathcal{U}, ζ) . According to theorem (3.2), point (ii), $1_{Neu} - \mathfrak{P}$ is a *Neu^gCS*. Therefore, \mathfrak{P} is a *Neu^gOS* in (\mathcal{U}, ζ) . ■

Theorem 3.13:

In a $Neu^{TS}(\mathcal{U}, \zeta)$, the subsequent arguments are valid:

(i) Each *Neu^{gsg}OS* is a *Neu^{αg}OS* and *Neu^{gα}OS*.

(ii) Each *Neu^{gsg}OS* is a *Neu^{sg}OS* and *Neu^{gs}OS*.

Proof:

Similar to above proposition. ■

Proposition 3.14:

If \mathfrak{P} and \mathfrak{Q} are *Neu^{gsg}CSs* in a $Neu^{TS}(\mathcal{U}, \zeta)$, then $\mathfrak{P} \sqcup \mathfrak{Q}$ is a *Neu^{gsg}CS*.

Proof:

Let \mathfrak{P} and \mathfrak{Q} be two *Neu^{gsg}CSs* in a $Neu^{TS}(\mathcal{U}, \zeta)$ and let \mathfrak{M} be any *Neu^{sg}OS* in \mathcal{U} such that $\mathfrak{P} \sqsubseteq \mathfrak{M}$ and $\mathfrak{Q} \sqsubseteq \mathfrak{M}$. Then we have $\mathfrak{P} \sqcup \mathfrak{Q} \sqsubseteq \mathfrak{M}$. Since \mathfrak{P} and \mathfrak{Q} are *Neu^{gsg}CSs* in \mathcal{U} , $NeuCl(\mathfrak{P}) \sqsubseteq \mathfrak{M}$ and $NeuCl(\mathfrak{Q}) \sqsubseteq \mathfrak{M}$. Now, $NeuCl(\mathfrak{P} \sqcup \mathfrak{Q}) = NeuCl(\mathfrak{P}) \sqcup NeuCl(\mathfrak{Q}) \sqsubseteq \mathfrak{M}$ and so $NeuCl(\mathfrak{P} \sqcup \mathfrak{Q}) \sqsubseteq \mathfrak{M}$. Hence $\mathfrak{P} \sqcup \mathfrak{Q}$ is a *Neu^{gsg}CS* in \mathcal{U} . ■

Proposition 3.15:

If \mathfrak{P} is a *Neu^{gsg}CS* in a $Neu^{TS}(\mathcal{U}, \zeta)$, then $NeuCl(\mathfrak{P}) - \mathfrak{P}$ does not include non-empty *NeuCS* in (\mathcal{U}, ζ) .

Proof:

Let \mathfrak{P} be a *Neu^{gsg}CS* in a $Neu^{TS}(\mathcal{U}, \zeta)$ and let \mathfrak{F} be any *NeuCS* in (\mathcal{U}, ζ) such that $\mathfrak{F} \sqsubseteq NeuCl(\mathfrak{P}) - \mathfrak{P}$. Since \mathfrak{P} is a *Neu^{gsg}CS*, we have $NeuCl(\mathfrak{P}) \sqsubseteq 1_{Neu} - \mathfrak{F}$. This implies $\mathfrak{F} \sqsubseteq 1_{Neu} - NeuCl(\mathfrak{P})$. Then $\mathfrak{F} \sqsubseteq NeuCl(\mathfrak{P}) \cap (1_{Neu} - NeuCl(\mathfrak{P})) = 0_{Neu}$. Thus, $\mathfrak{F} = 0_{Neu}$. Hence $NeuCl(\mathfrak{P}) - \mathfrak{P}$ does not include non-empty *NeuCS* in (\mathcal{U}, ζ) . ■

Proposition 3.16:

A neutrosophic set \mathfrak{P} is *Neu^{gsg}CS* in a $Neu^{TS}(\mathcal{U}, \zeta)$ iff $NeuCl(\mathfrak{P}) - \mathfrak{P}$ does not include non-empty *Neu^{sg}CS* in (\mathcal{U}, ζ) .

Proof:

Let \mathfrak{P} be a *Neu^{gsg}CS* in a $Neu^{TS}(\mathcal{U}, \zeta)$ and let \mathfrak{R} be any *Neu^{sg}CS* in (\mathcal{U}, ζ) such that $\mathfrak{R} \sqsubseteq NeuCl(\mathfrak{P}) - \mathfrak{P}$. Since \mathfrak{P} is a *Neu^{gsg}CS*, we have $NeuCl(\mathfrak{P}) \sqsubseteq 1_{Neu} - \mathfrak{R}$. This implies $\mathfrak{R} \sqsubseteq 1_{Neu} - NeuCl(\mathfrak{P})$. Then $\mathfrak{R} \sqsubseteq NeuCl(\mathfrak{P}) \cap (1_{Neu} - NeuCl(\mathfrak{P})) = 0_{Neu}$. Thus, \mathfrak{R} is empty.

Conversely, suppose that $NeuCl(\mathfrak{P}) - \mathfrak{P}$ does not include non-empty *Neu^{sg}CS* in (\mathcal{U}, ζ) . Let $\mathfrak{P} \sqsubseteq \mathfrak{M}$ and \mathfrak{M} is *Neu^{sg}OS*. If $NeuCl(\mathfrak{P}) \sqsubseteq \mathfrak{M}$ then $NeuCl(\mathfrak{P}) \cap (1_{Neu} - \mathfrak{M})$ is non-empty. Since $NeuCl(\mathfrak{P})$ is *NeuCS* and $1_{Neu} - \mathfrak{M}$ is *Neu^{sg}CS*, we have $NeuCl(\mathfrak{P}) \cap (1_{Neu} - \mathfrak{M})$ is not empty *Neu^{sg}CS* of $NeuCl(\mathfrak{P}) - \mathfrak{P}$, which is a contradiction. Therefore $NeuCl(\mathfrak{P}) \not\sqsubseteq \mathfrak{M}$. Hence \mathfrak{P} is a *Neu^{gsg}CS*. ■

Proposition 3.17:

If \mathfrak{F} is a $Neu^{gsg}CS$ in a $Neu^{TS}(\mathcal{U}, \zeta)$ and $\mathfrak{F} \sqsubseteq \mathfrak{Q} \sqsubseteq NeuCl(\mathfrak{F})$, then \mathfrak{Q} is a $Neu^{gsg}CS$ in (\mathcal{U}, ζ) .

Proof:

Assume the set \mathfrak{F} is a $Neu^{gsg}CS$ in a $Neu^{TS}(\mathcal{U}, \zeta)$. Suppose the set \mathfrak{M} is a $Neu^{sg}OS$ in (\mathcal{U}, ζ) where $\mathfrak{Q} \sqsubseteq \mathfrak{M}$. So, $\mathfrak{F} \sqsubseteq \mathfrak{M}$. Because \mathfrak{F} is a $Neu^{gsg}CS$, it observes that $NeuCl(\mathfrak{F}) \sqsubseteq \mathfrak{M}$. Currently, $\mathfrak{Q} \sqsubseteq NeuCl(\mathfrak{F})$ suggests $NeuCl(\mathfrak{Q}) \sqsubseteq NeuCl(NeuCl(\mathfrak{F})) = NeuCl(\mathfrak{F})$. Thus, $NeuCl(\mathfrak{Q}) \sqsubseteq \mathfrak{M}$. Hence \mathfrak{Q} is a $Neu^{gsg}CS$. ■

Proposition 3.18:

Let $\mathfrak{F} \sqsubseteq \mathfrak{D} \sqsubseteq \mathcal{U}$ and if \mathfrak{F} is a $Neu^{gsg}CS$ in \mathcal{U} then \mathfrak{F} is a $Neu^{gsg}CS$ relative to \mathfrak{D} .

Proof:

$\mathfrak{F} \sqsubseteq \mathfrak{D} \sqcap \mathfrak{M}$ where \mathfrak{M} is a $Neu^{sg}OS$ in \mathcal{U} . Then $\mathfrak{F} \sqsubseteq \mathfrak{M}$ and hence $NeuCl(\mathfrak{F}) \sqsubseteq \mathfrak{M}$. This implies that $\mathfrak{D} \sqcap NeuCl(\mathfrak{F}) \sqsubseteq \mathfrak{D} \sqcap \mathfrak{M}$. Thus \mathfrak{F} is a $Neu^{gsg}CS$ relative to \mathfrak{D} . ■

Proposition 3.19:

If \mathfrak{F} is a $Neu^{sg}OS$ and a $Neu^{gsg}CS$ in a $Neu^{TS}(\mathcal{U}, \zeta)$, then \mathfrak{F} is a $NeuCS$ in (\mathcal{U}, ζ) .

Proof:

Suppose that \mathfrak{F} is a $Neu^{sg}OS$ and a $Neu^{gsg}CS$ in a $Neu^{TS}(\mathcal{U}, \zeta)$, then $NeuCl(\mathfrak{F}) \sqsubseteq \mathfrak{F}$ and since $\mathfrak{F} \sqsubseteq NeuCl(\mathfrak{F})$. Thus, $NeuCl(\mathfrak{F}) = \mathfrak{F}$. Hence \mathfrak{F} is a $NeuCS$. ■

Theorem 3.20:

For each $u \in \mathcal{U}$ either $\langle u, (0.1, 0.1) \rangle$ is a $Neu^{sg}CS$ or $1_{Neu} - \langle u, (0.1, 0.1) \rangle$ is a $Neu^{gsg}CS$ in \mathcal{U} .

Proof:

If $\langle u, (0.1, 0.1) \rangle$ is not a $Neu^{sg}CS$ in \mathcal{U} then $1_{Neu} - \langle u, (0.1, 0.1) \rangle$ is not a $Neu^{sg}OS$ and the only $Neu^{sg}OS$ containing $1_{Neu} - \langle u, (0.1, 0.1) \rangle$ is the space \mathcal{U} itself. Therefore $NeuCl(1_{Neu} - \langle u, (0.1, 0.1) \rangle) \sqsubseteq 1_{Neu}$ and so $1_{Neu} - \langle u, (0.1, 0.1) \rangle$ is a $Neu^{gsg}CS$ in \mathcal{U} . ■

Proposition 3.21:

If \mathfrak{F} and \mathfrak{Q} are $Neu^{gsg}OSs$ in a $Neu^{TS}(\mathcal{U}, \zeta)$, then $\mathfrak{F} \sqcap \mathfrak{Q}$ is a $Neu^{gsg}OS$.

Proof:

Let \mathfrak{F} and \mathfrak{Q} be $Neu^{gsg}OSs$ in a $Neu^{TS}(\mathcal{U}, \zeta)$. Then $1_{Neu} - \mathfrak{F}$ and $1_{Neu} - \mathfrak{Q}$ are $Neu^{gsg}CSs$. By proposition (3.14), $(1_{Neu} - \mathfrak{F}) \sqcup (1_{Neu} - \mathfrak{Q})$ is a $Neu^{gsg}CS$. Since $(1_{Neu} - \mathfrak{F}) \sqcup (1_{Neu} - \mathfrak{Q}) = 1_{Neu} - (\mathfrak{F} \sqcap \mathfrak{Q})$. Hence $\mathfrak{F} \sqcap \mathfrak{Q}$ is a $Neu^{gsg}OS$. ■

Theorem 3.22:

A neutrosophic set \mathfrak{F} is $Neu^{gsg}OS$ iff $\mathfrak{S} \sqsubseteq NeuInt(\mathfrak{F})$ where \mathfrak{S} is a $Neu^{gsg}CS$ and $\mathfrak{S} \sqsubseteq \mathfrak{F}$.

Proof:

Suppose that $\mathfrak{S} \sqsubseteq NeuInt(\mathfrak{F})$ where \mathfrak{S} is a $Neu^{gsg}CS$ and $\mathfrak{S} \sqsubseteq \mathfrak{F}$. Then $1_{Neu} - \mathfrak{F} \sqsubseteq 1_{Neu} - \mathfrak{S}$ and $1_{Neu} - \mathfrak{S}$ is a $Neu^{sg}OS$ by theorem (3.13) part (ii). Now, $NeuCl(1_{Neu} - \mathfrak{F}) = 1_{Neu} - NeuInt(\mathfrak{F}) \sqsubseteq 1_{Neu} - \mathfrak{S}$. Then $1_{Neu} - \mathfrak{F}$ is a $Neu^{gsg}CS$. Hence \mathfrak{F} is a $Neu^{gsg}OS$.

Conversely, let \mathfrak{F} be a $Neu^{gsg}OS$ and \mathfrak{S} be a $Neu^{gsg}CS$ and $\mathfrak{S} \sqsubseteq \mathfrak{F}$. Then $1_{Neu} - \mathfrak{F} \sqsubseteq 1_{Neu} - \mathfrak{S}$. Since $1_{Neu} - \mathfrak{F}$ is a $Neu^{gsg}CS$ and $1_{Neu} - \mathfrak{S}$ is a $Neu^{sg}OS$, we have $NeuCl(1_{Neu} - \mathfrak{F}) \sqsubseteq 1_{Neu} - \mathfrak{S}$. Then $\mathfrak{S} \sqsubseteq NeuInt(\mathfrak{F})$. ■

Theorem 3.23:

If $\mathfrak{F} \sqsubseteq \mathfrak{Q} \sqsubseteq \mathcal{U}$ where \mathfrak{F} is a $Neu^{gsg}OS$ relative to \mathfrak{Q} and \mathfrak{Q} is a $Neu^{gsg}OS$ in \mathcal{U} , then \mathfrak{F} is a $Neu^{gsg}OS$ in \mathcal{U} .

Proof:

Let \mathfrak{F} be a $Neu^{sg}CS$ in \mathfrak{U} and suppose that $\mathfrak{F} \sqsubseteq \mathfrak{P}$. Then $\mathfrak{F} = \mathfrak{F} \cap \mathfrak{Q}$ is a $Neu^{sg}CS$ in \mathfrak{Q} . But \mathfrak{P} is a $Neu^{gsg}OS$ relative to \mathfrak{Q} . Therefore $\mathfrak{F} \sqsubseteq NeuInt_{\mathfrak{Q}}(\mathfrak{P})$. Since $NeuInt_{\mathfrak{Q}}(\mathfrak{P})$ is a $NeuOS$ relative to \mathfrak{Q} . We have $\mathfrak{F} \sqsubseteq \mathfrak{M} \cap \mathfrak{Q} \sqsubseteq \mathfrak{P}$, for some $NeuOS$ \mathfrak{M} in \mathfrak{U} . Since \mathfrak{Q} is a $Neu^{gsg}OS$ in \mathfrak{U} , we have $\mathfrak{F} \sqsubseteq NeuInt(\mathfrak{Q}) \sqsubseteq \mathfrak{Q}$. Therefore $\mathfrak{F} \sqsubseteq NeuInt(\mathfrak{Q}) \cap \mathfrak{M} \sqsubseteq \mathfrak{Q} \cap \mathfrak{M} \sqsubseteq \mathfrak{P}$. It follows that $\mathfrak{F} \sqsubseteq NeuInt(\mathfrak{P})$. Thus, \mathfrak{P} is a $Neu^{gsg}OS$ in \mathfrak{U} . ■

Theorem 3.24:

If \mathfrak{P} is a $Neu^{gsg}OS$ in a $Neu^{TS}(\mathfrak{U}, \zeta)$ and $NeuInt(\mathfrak{P}) \sqsubseteq \mathfrak{Q} \sqsubseteq \mathfrak{P}$, then \mathfrak{Q} is a $Neu^{gsg}OS$ in (\mathfrak{U}, ζ) .

Proof:

Suppose that \mathfrak{P} is a $Neu^{gsg}OS$ in a $Neu^{TS}(\mathfrak{U}, \zeta)$ and $NeuInt(\mathfrak{P}) \sqsubseteq \mathfrak{Q} \sqsubseteq \mathfrak{P}$. Then $1_{Neu} - \mathfrak{P}$ is a $Neu^{gsg}CS$ and $1_{Neu} - \mathfrak{P} \sqsubseteq 1_{Neu} - \mathfrak{Q} \sqsubseteq NeuCl(1_{Neu} - \mathfrak{P})$. Then $1_{Neu} - \mathfrak{Q}$ is a $Neu^{gsg}CS$ by proposition (3.17). Hence, \mathfrak{Q} is a $Neu^{gsg}OS$. ■

Theorem 3.25:

For a neutrosophic subset \mathfrak{P} of a $Neu^{TS}(\mathfrak{U}, \zeta)$, the following statements are equivalent:

- (i) \mathfrak{P} is a $Neu^{gsg}CS$.
- (ii) $NeuCl(\mathfrak{P}) - \mathfrak{P}$ contains no non-empty $Neu^{sg}CS$.
- (iii) $NeuCl(\mathfrak{P}) - \mathfrak{P}$ is a $Neu^{gsg}OS$.

Proof:

Follows from proposition (3.16) and proposition (3.18). ■

Remark 3.26:

The subsequent illustration reveals the relative among the diverse kinds of $NeuCS$:

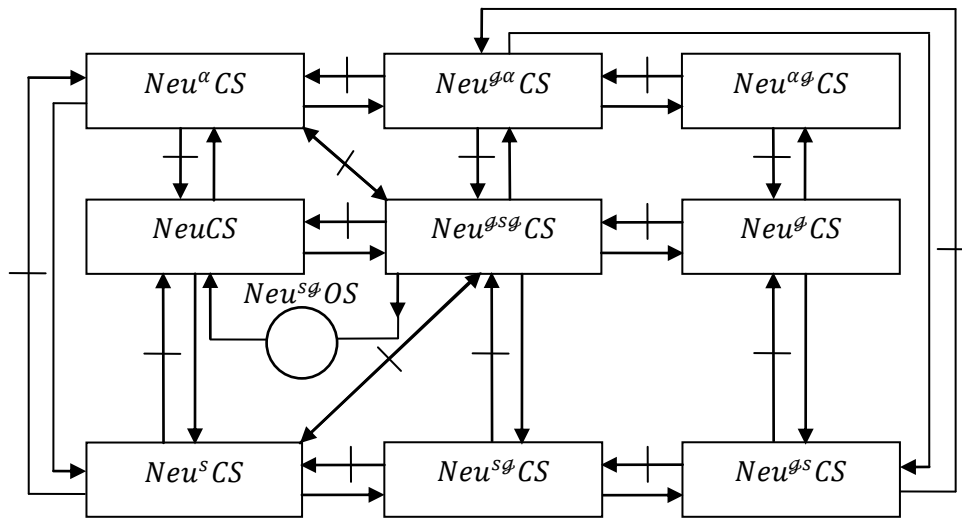

Fig. 3.1

4. Neutrosophic gsg -Closure and Neutrosophic gsg -Interior

We present neutrosophic gsg -closure and neutrosophic gsg -interior and obtain some of its properties in this section.

Definition 4.1:

The intersection of all $Neu^{gsg}CS$ s in a $Neu^{TS}(\mathcal{U}, \zeta)$ containing \mathfrak{F} is called neutrosophic gsg -closure of \mathfrak{F} and is denoted by $Neu^{gsg}Cl(\mathfrak{F})$.

Definition 4.2:

The union of all $Neu^{gsg}OS$ s in a $Neu^{TS}(\mathcal{U}, \zeta)$ contained in \mathfrak{F} is called neutrosophic gsg -interior of \mathfrak{F} and is denoted by $Neu^{gsg}Int(\mathfrak{F})$.

Proposition 4.3:

Let \mathfrak{F} be any neutrosophic set in a $Neu^{TS}(\mathcal{U}, \zeta)$. Then the following properties hold:

- (i) $Neu^{gsg}Int(\mathfrak{F}) = \mathfrak{F}$ iff \mathfrak{F} is a $Neu^{gsg}OS$.
- (ii) $Neu^{gsg}Cl(\mathfrak{F}) = \mathfrak{F}$ iff \mathfrak{F} is a $Neu^{gsg}CS$.
- (iii) $Neu^{gsg}Int(\mathfrak{F})$ is the largest $Neu^{gsg}OS$ contained in \mathfrak{F} .
- (iv) $Neu^{gsg}Cl(\mathfrak{F})$ is the smallest $Neu^{gsg}CS$ containing \mathfrak{F} .

Proof:

(i), (ii), (iii) and (iv) are obvious. ■

Proposition 4.4:

Let \mathfrak{F} be any neutrosophic set in a $Neu^{TS}(\mathcal{U}, \zeta)$. Then the following properties hold:

- (i) $Neu^{gsg}Int(1_{Neu} - \mathfrak{F}) = 1_{Neu} - (Neu^{gsg}Cl(\mathfrak{F}))$,
- (ii) $Neu^{gsg}Cl(1_{Neu} - \mathfrak{F}) = 1_{Neu} - (Neu^{gsg}Int(\mathfrak{F}))$.

Proof:

- (i) By definition, $Neu^{gsg}Cl(\mathfrak{F}) = \bigcap \{ \mathfrak{Q} : \mathfrak{F} \subseteq \mathfrak{Q}, \mathfrak{Q} \text{ is a } Neu^{gsg}CS \}$
 $1_{Neu} - (Neu^{gsg}Cl(\mathfrak{F})) = 1_{Neu} - \bigcap \{ \mathfrak{Q} : \mathfrak{F} \subseteq \mathfrak{Q}, \mathfrak{Q} \text{ is a } Neu^{gsg}CS \}$
 $= \bigcup \{ 1_{Neu} - \mathfrak{Q} : \mathfrak{F} \subseteq \mathfrak{Q}, \mathfrak{Q} \text{ is a } Neu^{gsg}CS \}$
 $= \bigcup \{ \mathfrak{M} : \mathfrak{M} \subseteq 1_{Neu} - \mathfrak{F}, \mathfrak{M} \text{ is a } Neu^{gsg}OS \}$
 $= Neu^{gsg}Int(1_{Neu} - \mathfrak{F})$.

(ii) The evidence is analogous to (i). ■

Theorem 4.5:

Let \mathfrak{F} and \mathfrak{Q} be two neutrosophic sets in a $Neu^{TS}(\mathcal{U}, \zeta)$. Then the following properties hold:

- (i) $Neu^{gsg}Cl(0_{Neu}) = 0_{Neu}$, $Neu^{gsg}Cl(1_{Neu}) = 1_{Neu}$.
- (ii) $\mathfrak{F} \subseteq Neu^{gsg}Cl(\mathfrak{F})$.
- (iii) $\mathfrak{F} \subseteq \mathfrak{Q} \Rightarrow Neu^{gsg}Cl(\mathfrak{F}) \subseteq Neu^{gsg}Cl(\mathfrak{Q})$.
- (iv) $Neu^{gsg}Cl(\mathfrak{F} \cap \mathfrak{Q}) \subseteq Neu^{gsg}Cl(\mathfrak{F}) \cap Neu^{gsg}Cl(\mathfrak{Q})$.
- (v) $Neu^{gsg}Cl(\mathfrak{F} \cup \mathfrak{Q}) = Neu^{gsg}Cl(\mathfrak{F}) \cup Neu^{gsg}Cl(\mathfrak{Q})$.
- (vi) $Neu^{gsg}Cl(Neu^{gsg}Cl(\mathfrak{F})) = Neu^{gsg}Cl(\mathfrak{F})$.

Proof:

(i) and (ii) are obvious.

(iii) By part (ii), $\mathfrak{Q} \subseteq Neu^{gsg}Cl(\mathfrak{Q})$. Since $\mathfrak{F} \subseteq \mathfrak{Q}$, we have $\mathfrak{F} \subseteq Neu^{gsg}Cl(\mathfrak{Q})$. But $Neu^{gsg}Cl(\mathfrak{Q})$ is a $Neu^{gsg}CS$. Thus $Neu^{gsg}Cl(\mathfrak{Q})$ is a $Neu^{gsg}CS$ containing \mathfrak{F} . Since $Neu^{gsg}Cl(\mathfrak{F})$ is the smallest $Neu^{gsg}CS$ containing \mathfrak{F} , we have $Neu^{gsg}Cl(\mathfrak{F}) \subseteq Neu^{gsg}Cl(\mathfrak{Q})$.

(iv) We know that $\mathfrak{F} \cap \mathfrak{Q} \subseteq \mathfrak{F}$ and $\mathfrak{F} \cap \mathfrak{Q} \subseteq \mathfrak{Q}$. Therefore, by part (iii), $Neu^{gsg}Cl(\mathfrak{F} \cap \mathfrak{Q}) \subseteq Neu^{gsg}Cl(\mathfrak{F})$ and $Neu^{gsg}Cl(\mathfrak{F} \cap \mathfrak{Q}) \subseteq Neu^{gsg}Cl(\mathfrak{Q})$. Hence $Neu^{gsg}Cl(\mathfrak{F} \cap \mathfrak{Q}) \subseteq Neu^{gsg}Cl(\mathfrak{F}) \cap Neu^{gsg}Cl(\mathfrak{Q})$.

(v) Since $\mathfrak{F} \subseteq \mathfrak{F} \cup \mathfrak{Q}$ and $\mathfrak{Q} \subseteq \mathfrak{F} \cup \mathfrak{Q}$, it follows from part (iii) that $Neu^{gsg}Cl(\mathfrak{F}) \subseteq Neu^{gsg}Cl(\mathfrak{F} \cup \mathfrak{Q})$ and $Neu^{gsg}Cl(\mathfrak{Q}) \subseteq Neu^{gsg}Cl(\mathfrak{F} \cup \mathfrak{Q})$. Hence $Neu^{gsg}Cl(\mathfrak{F}) \cup Neu^{gsg}Cl(\mathfrak{Q}) \subseteq Neu^{gsg}Cl(\mathfrak{F} \cup \mathfrak{Q})$ (1)

Since $Neu^{gs\phi}Cl(\mathfrak{P})$ and $Neu^{gs\phi}Cl(\mathfrak{Q})$ are $Neu^{gs\phi}CSs$, $Neu^{gs\phi}Cl(\mathfrak{P})\sqcup Neu^{gs\phi}Cl(\mathfrak{Q})$ is also $Neu^{gs\phi}CS$ by proposition (3.14). Also $\mathfrak{P} \sqsubseteq Neu^{gs\phi}Cl(\mathfrak{P})$ and $\mathfrak{Q} \sqsubseteq Neu^{gs\phi}Cl(\mathfrak{Q})$ implies that $\mathfrak{P}\sqcup\mathfrak{Q} \sqsubseteq Neu^{gs\phi}Cl(\mathfrak{P})\sqcup Neu^{gs\phi}Cl(\mathfrak{Q})$. Thus $Neu^{gs\phi}Cl(\mathfrak{P})\sqcup Neu^{gs\phi}Cl(\mathfrak{Q})$ is a $Neu^{gs\phi}CS$ containing $\mathfrak{P}\sqcup\mathfrak{Q}$. Since $Neu^{gs\phi}Cl(\mathfrak{P}\sqcup\mathfrak{Q})$ is the smallest $Neu^{gs\phi}CS$ containing $\mathfrak{P}\sqcup\mathfrak{Q}$, we have $Neu^{gs\phi}Cl(\mathfrak{P}\sqcup\mathfrak{Q}) \sqsubseteq Neu^{gs\phi}Cl(\mathfrak{P})\sqcup Neu^{gs\phi}Cl(\mathfrak{Q})\dots\dots\dots (2)$

From (1) and (2), we have $Neu^{gs\phi}Cl(\mathfrak{P}\sqcup\mathfrak{Q}) = Neu^{gs\phi}Cl(\mathfrak{P})\sqcup Neu^{gs\phi}Cl(\mathfrak{Q})$.

(vi) Since $Neu^{gs\phi}Cl(\mathfrak{P})$ is a $Neu^{gs\phi}CS$, we have by proposition (4.3) part (ii), $Neu^{gs\phi}Cl(Neu^{gs\phi}Cl(\mathfrak{P})) = Neu^{gs\phi}Cl(\mathfrak{P})$. ■

Theorem 4.6:

Let \mathfrak{P} and \mathfrak{Q} be two neutrosophic sets in a $Neu^{TS}(\mathfrak{U}, \zeta)$. Then the following properties hold:

- (i) $Neu^{gs\phi}Int(0_{Neu}) = 0_{Neu}$, $Neu^{gs\phi}Int(1_{Neu}) = 1_{Neu}$.
- (ii) $Neu^{gs\phi}Int(\mathfrak{P}) \sqsubseteq \mathfrak{P}$.
- (iii) $\mathfrak{P} \sqsubseteq \mathfrak{Q} \Rightarrow Neu^{gs\phi}Int(\mathfrak{P}) \sqsubseteq Neu^{gs\phi}Int(\mathfrak{Q})$.
- (iv) $Neu^{gs\phi}Int(\mathfrak{P}\cap\mathfrak{Q}) = Neu^{gs\phi}Int(\mathfrak{P})\cap Neu^{gs\phi}Int(\mathfrak{Q})$.
- (v) $Neu^{gs\phi}Int(\mathfrak{P}\sqcup\mathfrak{Q}) \supseteq Neu^{gs\phi}Int(\mathfrak{P})\sqcup Neu^{gs\phi}Int(\mathfrak{Q})$.
- (vi) $Neu^{gs\phi}Int(Neu^{gs\phi}Int(\mathfrak{P})) = Neu^{gs\phi}Int(\mathfrak{P})$.

Proof:

(i), (ii), (iii), (iv), (v) and (vi) are obvious. ■

Definition 4.7:

A $Neu^{TS}(\mathfrak{U}, \zeta)$ is called a neutrosophic $T_{\frac{1}{2}}$ -space (in short, $NeuT_{\frac{1}{2}}$ -space) if each $Neu^{\phi}CS$ in this space is a $NeuCS$.

Definition 4.8:

A $Neu^{TS}(\mathfrak{U}, \zeta)$ is called a neutrosophic $T_{gs\phi}$ -space (in short, $NeuT_{gs\phi}$ -space) if each $Neu^{gs\phi}CS$ in this space is a $NeuCS$.

Proposition 4.9:

Every $NeuT_{\frac{1}{2}}$ -space is a $NeuT_{gs\phi}$ -space.

Proof:

Let (\mathfrak{U}, ζ) be a $NeuT_{\frac{1}{2}}$ -space and let \mathfrak{P} be a $Neu^{gs\phi}CS$ in \mathfrak{U} . Then \mathfrak{P} is a $Neu^{\phi}CS$, by theorem (3.2) part (ii). Since (\mathfrak{U}, ζ) is a $NeuT_{\frac{1}{2}}$ -space, then \mathfrak{P} is a $NeuCS$ in \mathfrak{U} . Hence (\mathfrak{U}, ζ) is a $NeuT_{gs\phi}$ -space. ■

Theorem 4.10:

For a $Neu^{TS}(\mathfrak{U}, \zeta)$, the following statements are equivalent:

- (i) (\mathfrak{U}, ζ) is a $NeuT_{gs\phi}$ -space.
- (ii) Every singleton of a $Neu^{TS}(\mathfrak{U}, \zeta)$ is either $Neu^{s\phi}CS$ or $NeuOS$.

Proof:

(i) \Rightarrow (ii) Assume that for some $u \in \mathfrak{U}$ the neutrosophic set $\langle u, (0.1, 0.1) \rangle$ is not a $Neu^{s\phi}CS$ in a $Neu^{TS}(\mathfrak{U}, \zeta)$. Then the only $Neu^{s\phi}OS$ containing $1_{Neu} - \langle u, (0.1, 0.1) \rangle$ is the space \mathfrak{U} itself and $1_{Neu} - \langle u, (0.1, 0.1) \rangle$ is a $Neu^{gs\phi}CS$ in (\mathfrak{U}, ζ) . By assumption $1_{Neu} - \langle u, (0.1, 0.1) \rangle$ is a $NeuCS$ in (\mathfrak{U}, ζ) or equivalently $\langle u, (0.1, 0.1) \rangle$ is a $NeuOS$.

(ii) \Rightarrow (i) Let \mathfrak{P} be a $Neu^{s\#}CS$ in (\mathcal{U}, ζ) and let $u \in NeuCl(\mathfrak{P})$. By assumption $\langle u, (0.1, 0.1) \rangle$ is either $Neu^{s\#}CS$ or $NeuOS$.

Case(1). Suppose $\langle u, (0.1, 0.1) \rangle$ is a $Neu^{s\#}CS$. If $u \notin \mathfrak{P}$ then $NeuCl(\mathfrak{P}) - \mathfrak{P}$ contains a non-empty $Neu^{s\#}CS$ $u, (0.1, 0.1)$ which is a contradiction to proposition (3.18). Therefore $u \in \mathfrak{P}$.

Case(2). Suppose $\langle u, (0.1, 0.1) \rangle$ is a $NeuOS$. Since $u \in NeuCl(\mathfrak{P})$, $\langle u, (0.1, 0.1) \rangle \cap \mathfrak{P} \neq 0_{Neu}$ and therefore $NeuCl(\mathfrak{P}) \sqsubseteq \mathfrak{P}$ or equivalently \mathfrak{P} is a $NeuCS$ in a $Neu^{TS}(\mathcal{U}, \zeta)$. ■

5. Conclusion

The concept of $Neu^{s\#}CS$ identified utilizing $Neu^{s\#}CS$ constructs a neutrosophic topology and sits between the concept of $NeuCS$ and the concept of $Neu^{\#}CS$. The $Neu^{s\#}CS$ can be used to derive a new decomposition of $Neu^{s\#}$ -continuity and new $Neu^{s\#}$ -separation axioms.

Funding: This research received no external funding.

Acknowledgements: The authors are highly grateful to the Referees for their constructive suggestions.

Conflicts of Interest: The authors declare no conflict of interest.

References

1. F. Smarandache, A unifying field in logics: neutrosophic logic, neutrosophy, neutrosophic set, neutrosophic probability. American Research Press, Rehoboth, NM, (1999).
2. F. Smarandache, Neutrosophy and neutrosophic logic, first international conference on neutrosophy, neutrosophic logic, set, probability, and statistics, University of New Mexico, Gallup, NM 87301, USA (2002).
3. A. Salama and S. A. Alblowi, Neutrosophic set and neutrosophic topological spaces. IOSR Journal of Mathematics, 3(2012), 31-35.
4. Q. H. Imran, F. Smarandache, R. K. Al-Hamido and R. Dhavaseelan, On neutrosophic semi- α -open sets. Neutrosophic Sets and Systems, 18(2017), 37-42.
5. Md. Hanif PAGE and Q. H. Imran, Neutrosophic generalized homeomorphism. Neutrosophic Sets and Systems, 35(2020), 340-346.
6. R. Dhavaseelan and S. Jafari, Generalized Neutrosophic closed sets. New trends in Neutrosophic theory and applications, 2(2018), 261-273.
7. Q. H. Imran, R. Dhavaseelan, A. H. M. Al-Obaidi and M. H. Page, On neutrosophic generalized alpha generalized continuity. Neutrosophic Sets and Systems, 35(2020), 511-521.
8. P. Iswarya and Dr. K. Bageerathi, On neutrosophic semi-open sets in neutrosophic topological spaces. International Journal of Mathematics Trends and Technology (IJMTT), Vol.37, No.3 (2016), 24-33.
9. I. Arokiarani, R. Dhavaseelan, S. Jafari and M. Parimala, On Some New Notions and Functions in Neutrosophic Topological Spaces. Neutrosophic Sets and Systems, 16(2017), 16-19.
10. A. Pushpalatha and T. Nandhini, Generalized closed sets via neutrosophic topological spaces. Malaya Journal of Matematik, 7(1), (2019), 50-54.
11. D. Jayanthi, α Generalized Closed Sets in Neutrosophic Topological Spaces. International Journal of Mathematics Trends and Technology (IJMTT)- Special Issue ICRMIT March (2018), 88-91.

12. D. Sreeja and T. Sarankumar, Generalized Alpha Closed sets in Neutrosophic topological spaces. *Journal of Applied Science and Computations*, 5(11), (2018), 1816-1823.
13. P. Iswarya and Dr. K. Bageerathi, A study on neutrosophic semi generalized closed sets in neutrosophic topological spaces. *Acta Ciencia Indica*, Vol. XLIII M, No.4, (2017), 239-245.
14. V. K. Shanthi, S. Chandrasekar and K. Safina Begam, Neutrosophic generalized semi closed sets in neutrosophic topological spaces. *International Journal of Research in Advent Technology*, Vol.6, No.7, (2018), 1739-1743.
15. P. Iswarya and Dr. K. Bageerathi, A study on neutrosophic generalized semi closed sets in neutrosophic topological spaces. *Journal of Emerging Technologies and Innovative Research (JETIR)*, Volume 6, Issue 2, (2019), 452-457.

HYPERSOFT SETS

Introduction to the IndetermSoft Set and IndetermHyperSoft Set

Florentin Smarandache

Florentin Smarandache (2022). Introduction to the IndetermSoft Set and IndetermHyperSoft Set. *Neutrosophic Sets and Systems* 50, 629-650

Abstract: In this paper one introduces for the first time the *IndetermSoft Set*, as extension of the classical (determinate) Soft Set, that deals with indeterminate data, and similarly the HyperSoft Set extended to *IndetermHyperSoft Set*, where 'Indeterm' stands for 'Indeterminate' (uncertain, conflicting, not unique outcome). They are built on an *IndetermSoft Algebra* that is an algebra dealing with *IndetermSoft Operators* resulted from our real world. Afterwards, the corresponding Fuzzy / Intuitionistic Fuzzy / Neutrosophic / and other fuzzy-extension IndetermSoft Set & IndetermHyperSoft Set are presented together with their applications.

Keywords: Soft Set; HyperSoft Set; IndetermSoft Set; IndetermHyperSoft Set; IndetermSoft Operators; IndetermSoft Algebra.

1. Introduction

The classical Soft Set is based on a determinate function (whose values are certain, and unique), but in our world there are many sources that, because of lack of information or ignorance, provide indeterminate (uncertain, and not unique – but hesitant or alternative) information.

They can be modelled by operators having some degree of indeterminacy due to the imprecision of our world.

The paper recalls the definitions of the classical Soft Set and HyperSoft Set, then shows the distinction between determinate and indeterminate soft functions.

The neutrosophic triplets $\langle \text{Function}, \text{NeuroFunction}, \text{AntiFunction} \rangle$ and $\langle \text{Operator}, \text{NeuroOperator}, \text{AntiOperator} \rangle$ are brought into discussion, as parts of the $\langle \text{Algebra}, \text{NeuroAlgebra}, \text{AntiAlgebra} \rangle$ (Smarandache, 2019).

Similarly, distinctions between determinate and indeterminate operators are taken into consideration.

Afterwards, an IndetermSoft Algebra is built, using a determinate soft operator (*joinAND*), and three indeterminate soft operators (*disjoinOR*, *exclusivOR*, *NOT*), whose properties are further on studied.

IndetermSoft Algebra and IndetermHyperSoft Algebra are subclasses of the IndetermAlgebra.

The IndetermAlgebra is introduced as an algebra whose space or operators have some degree of indeterminacy ($I > 0$), and it is a subclass of the NeutroAlgebra.

It was proved that the IndetermSoft Algebra and IndetermHyperSoft Algebra are non-Boolean Algebras, since many Boolean Laws fail.

2. Definition of Classical Soft Set

Let U be a universe of discourse, H a non-empty subset of U , with $P(H)$ the powerset of H , and a an attribute, with its set of attribute values denoted by A . Then the pair (F, H) , where $F: A \rightarrow P(H)$, is called a Classical Soft Set over H .

Molodtsov [1] has defined in 1999 the Soft Set, and Maji [2] the Neutrosophic Soft Set in 2013.

3. Definition of the Determinate (Classical) Soft Function

The above function $F: A \rightarrow P(H)$, where for each $x \in A, f(x) \in P(H)$, and $f(x)$ is certain and unique, is called a Determinate (Classical) Function.

4. Definition of the IndetermSoft Function

One introduces it for the first time. Let U be a universe of discourse, H a non-empty subset of U , and $P(H)$ the powerset of H . Let a be an attribute, and A be a set of this attribute values.

A function $F: A \rightarrow P(H)$ is called an *IndetermSoft Function* if:

- i. the set A has some indeterminacy;
- ii. or $P(H)$ has some indeterminacy;
- iii. or there exist at least an attribute value $v \in A$, such that $F(v) = \text{indeterminate}$ (unclear, uncertain, or not unique);
- iv. or any two or all three of the above situations.

The IndetermSoft Function has some degree of indeterminacy, and as such it is a particular case of the NeuroFunction [6, 7], defined in 2014 – 2015, that one recalls below.

5. <Function, NeuroFunction, AntiFunction>

We have formed the above neutrosophic triplet [10, 11].

- i. **(Classical) Function**, which is a function well-defined (inner-defined) for all elements in its domain of definition, or $(T, I, F) = (1, 0, 0)$.
- ii. **NeuroFunction** (or Neutrosophic Function), which is a function partially well-defined (degree of truth T), partially indeterminate (degree of indeterminacy I), and partially outer-defined (degree of falsehood F) on its domain of definition, where $(T, I, F) \notin \{(1, 0, 0), (0, 0, 1)\}$.
- iii. **AntiFunction**, which is a function outer-defined for all the elements in its domain of definition, or $(T, I, F) = (0, 0, 1)$.

6. Applications of the Soft Set

A detective must find the criminal(s) out of a crowd of suspects. He uses the testimonies of several witnesses.

Let the crowd of suspects be the set $S = \{s_1, s_2, s_3, s_4, s_5\} \cup \{\emptyset\}$, where $\{\emptyset\}$ is the empty (null) element, and the attribute $c = \text{criminal}$,

which has two attribute-values $C = \{\text{yes}, \text{no}\}$.

- i. Let the function $F_1: C \rightarrow P(S)$, where $P(S)$ is the powerset of S , represent the information provided by the witness W_1 .

For example,

$F_1(\text{yes}) = s_3$, which means that, according to the witness W_1 , the suspect s_3 is the criminal,

and $F_1(\text{no}) = s_4$, which similarly means, according to the witness W_1 , that the suspect s_4 is not the criminal.

These are determined (exact) information, provided by witness W_1 , therefore this is a classical Soft Set.

- ii. Further on, let the function $F_2 : C \rightarrow P(S)$, where $P(S)$ is the powerset of S , represent the information provided by the witness W_2 .

For example,

$F_2(\text{yes}) = \{\emptyset\}$, the null-element, which means that according to the witness W_2 , none of the suspects in the set S is the criminal. This is also a determinate information as in classical Soft Set.

7. Indeterminate Operator as Extension of the Soft Set

- iii. Again, let the function $F_3 : C \rightarrow P(S)$, where $P(S)$ is the powerset of S , represent the information provided by the witness W_3 .

This witness is not able to provide a certain and unique information, but some indeterminate (uncertain, not unique but alternative) information.

For example:

$$F_3(\text{yes}) = \text{NOT}(s_2)$$

and $F_3(\text{no}) = s_3 \text{ OR } s_4$

The third source (W_3) provides indeterminate (unclear, not unique) information, since $\text{NOT}(s_2)$ means that s_2 is not the criminal, then consequently: either one, or two, or more suspects from the remaining set of suspects $\{s_1, s_3, s_4, s_5\}$ may be the criminal(s), or $\{\emptyset\}$ (none of the remaining suspects is the criminal), whence one has:

$C_4^1 + C_4^2 + C_4^3 + C_4^4 + 1 = 2^4 = 16$ possibilities (alternatives, or outcomes), resulted from a single input, to chose from, where C_n^m means combinations of n elements taken into groups of m elements, for integers $0 \leq m \leq n$.

Indeterminate information again, since:

$s_3 \text{ OR } s_4$ means: either $\{s_3 \text{ yes, and } s_4 \text{ no}\}$, or $\{s_3 \text{ no, and } s_4 \text{ yes}\}$, or $\{s_3 \text{ yes, and } s_4 \text{ yes}\}$,

therefore 3 possible (alternatives) outcomes to chose from.

Thus, $F_3 : C \rightarrow P(S)$ is an Indeterminate Soft Function (or renamed/contracted as IndetermSoft Function).

8. Indeterminate Attribute-Value Extension of the Soft Set

Let's extend the previous Applications of the Soft Set with the crowd of suspects being the set $S = \{s_1, s_2, s_3, s_4, s_5\} \cup \{\emptyset\}$, where $\{\emptyset\}$ is the empty (null) element, and the attribute $c = \text{criminal}$, but the attribute c has this time three attribute-values $K = \{\text{yes, no, maybe}\}$, as in the new branch of philosophy, called neutrosophy, where between the opposites $\langle A \rangle = \text{yes}$, and $\langle \text{anti}A \rangle = \text{no}$, there is the indeterminacy (or neutral) $\langle \text{neut}A \rangle = \text{maybe}$.

And this is provided by witness W_4 and defined as:

$$F_4 : K \rightarrow P(S)$$

For example: $F_4(\text{maybe}) = s_5$, which means that the criminal is maybe s_5 .

There also is some indeterminacy herein as well because the attribute-value "maybe" means unsure, uncertain.

One can transform this one into a Fuzzy (or Intuitionistic Fuzzy, or Neutrosophic, or other Fuzzy-Extension) Soft Sets in the following ways:

$$F_4(\text{maybe}) = s_5 \text{ is approximately equivalent to } F_4(\text{yes}) = s_5(\text{some appurtenance degree})$$

or

$$F_4(\text{maybe}) = s_5 \text{ is approximately equivalent to } F_4(\text{no}) = s_5(\text{some non-appurtenance degree})$$

Let's consider the bellow example.

Fuzzy Soft Set as:

$F_4(\text{maybe}) = s_5$ is approximately equivalent to $F_4(\text{yes}) = s_5(0.6)$, or the chance that s_5 be a criminal is 60%;

Intuitionistic Fuzzy Soft Set as:

$F_4(\text{maybe}) = s_5$ is approximately equivalent to $F_4(\text{yes}) = s_5(0.6, 0.3)$, or the chance that s_5 be a criminal is 60%, and chance that s_5 not be a criminal is 30%;

Neutrosophic Soft Set as:

$F_4(\text{maybe}) = s_5$ is approximately equivalent to $F_4(\text{yes}) = s_5(0.6, 0.2, 0.3)$, or the chance that s_5 is a criminal is 60%, indeterminate-chance of criminal-noncriminal is 20%, and chance that s_5 not be a criminal is 30%.

And similarly for other *Fuzzy-Extension Soft Set*.

Or, equivalently, employing the attribute-value “no”, one may consider:

Fuzzy Soft Set as:

$F_4(\text{maybe}) = s_5$ is approximately equivalent to $F_4(\text{no}) = s_5(0.4)$, or the chance that s_5 is not a criminal is 40%;

Intuitionistic Fuzzy Soft Set as:

$F_4(\text{maybe}) = s_5$ is approximately equivalent to $F_4(\text{no}) = s_5(0.3, 0.6)$, or the chance that s_5 is not a criminal is 30%, and chance that s_5 is a criminal is 60%;

Neutrosophic Soft Set as:

$F_4(\text{maybe}) = s_5$ is approximately equivalent to $F_4(\text{no}) = s_5(0.3, 0.2, 0.6)$, or the chance that s_5 is not a criminal is 30%, indeterminate-chance of criminal-noncriminal is 20%, and chance that s_5 is a criminal is 60%.

And similarly for other *Fuzzy-Extension Soft Set*.

9. HyperSoft Set

Smarandache has extended in 2018 the Soft Set to the HyperSoft Set [3, 4] by transforming the function F from a uni-attribute function into a multi-attribute function.

9.1. Definition of HyperSoft Set

Let \mathcal{U} be a universe of discourse, H a non-empty set included in U , and $P(H)$ the powerset of H . Let a_1, a_2, \dots, a_n , where $n \geq 1$, be n distinct attributes, whose corresponding attribute values are respectively the sets A_1, A_2, \dots, A_n , with $A_i \cap A_j = \emptyset$ for $i \neq j$, and $i, j \in \{1, 2, \dots, n\}$. Then the pair $(F, A_1 \times A_2 \times \dots \times A_n)$, where $A_1 \times A_2 \times \dots \times A_n$ represents a Cartesian product, with

$$F: A_1 \times A_2 \times \dots \times A_n \rightarrow P(H)$$

is called a HyperSoft Set.

For example,

let

$$(e_1, e_2, \dots, e_n) \in A_1 \times A_2 \times \dots \times A_n$$

then

$$F(e_1, e_2, \dots, e_n) = G \in P(H)$$

9.2. Classification of HyperSoft Sets

With respect to the types of sets, such as: classical, fuzzy, intuitionistic fuzzy, neutrosophic, plithogenic, and all other fuzzy-extension sets, one respectively gets: the Crisp HyperSoft Set, Fuzzy HyperSoft Set, Intuitionistic Fuzzy HyperSoft Set, Neutrosophic HyperSoft Set, Plithogenic HyperSoft Set, and all other fuzzy-extension HyperSoft Sets [3, 5-9].

The HyperSoft degrees of T = truth, I = indeterminacy, F = falsehood, H = hesitancy, N = neutral etc. assigned to these Crisp HyperSoft Set, Fuzzy HyperSoft Set, Intuitionistic Fuzzy HyperSoft Set, Neutrosophic HyperSoft Set, Plithogenic HyperSoft Set, and all other fuzzy-extension HyperSoft Sets verify the same conditions of inclusion and inequalities as in their corresponding fuzzy and fuzzy-extension sets.

9.3. *Applications of HyperSoft Set and its corresponding Fuzzy / Intuitionistic Fuzzy / Neutrosophic HyperSoft Set*

Let $H = \{h_1, h_2, h_3, h_4\}$ be a set of four houses, and two attributes:

$s = \text{size}$, whose attribute values are $S = \{\text{small, medium, big}\}$,

and $l = \text{location}$, whose attribute values are $L = \{\text{central, peripheral}\}$.

Then $F : S \times L \rightarrow P(H)$ is a HyperSoft Set.

i. For example, $F(\text{small, peripheral}) = \{h_2, h_3\}$, which means that the houses that are *small and peripheral* are h_2 and h_3 .

ii. A Fuzzy HyperSoft Set may assign some fuzzy degrees, for example:

$F(\text{small, peripheral}) = \{h_2(0.7), h_3(0.2)\}$, which means that with respect to the attributes' values *small and peripheral all together*, h_2 meets the requirements of being both small and peripheral in a fuzzy degree of 70%, while h_3 in a fuzzy degree of 20%.

iii. Further on, a Intuitionistic Fuzzy HyperSoft Set may assign some intuitionistic fuzzy degrees, for example:

$F(\text{small, peripheral}) = \{h_2(0.7, 0.1), h_3(0.2, 0.6)\}$, which means that with respect to the attributes' values *small and peripheral all together*, h_2 meets the requirements of being both small and peripheral in a intuitionistic fuzzy degree of 70%, and does not meet it in a intuitionistic fuzzy degree of 10%; and similarly for h_3 .

iv. Further on, a Neutrosophic HyperSoft Set may assign some neutrosophic degrees, for example:

$F(\text{small, peripheral}) = \{h_2(0.7, 0.5, 0.1), h_3(0.2, 0.3, 0.6)\}$, which means that with respect to the attributes' values *small and peripheral all together*, h_2 meets the requirements of being both small and peripheral in a neutrosophic degree of 70%, the indeterminate-requirement in a neutrosophic degree of 50%, and does not meet the requirement in a neutrosophic degree of 10%. And similarly, for h_3 .

v. In the same fashion for other fuzzy-extension HyperSoft Sets.

10. Operator, NeutroOperator, AntiOperator

Let U be a universe of discourse and H a non-empty subset of U .

Let $n \geq 1$ be an integer, and ω be an operator defined as:

$$\omega : H^n \rightarrow H$$

Let's take a random n -tuple $(x_1, x_2, \dots, x_n) \in H^n$.

There are three possible cases:

i. $\omega(x_1, x_2, \dots, x_n) \in H$ and $\omega(x_1, x_2, \dots, x_n)$ is a determinate (clear, certain, unique) output; this is called degree of well-defined (inner-defined), or degree of Truth (T).

ii. $\omega(x_1, x_2, \dots, x_n)$ is an indeterminate (unclear, uncertain, undefined, not unique) output; this is called degree of Indeterminacy (I).

iii. $\omega(x_1, x_2, \dots, x_n) \in U - H$; this is called degree of outer-defined (since the output is outside of H), or degree of Falsehood (F).

Consequently, one has a Neutrosophic Triplet of the form

$$\langle \text{Operator, NeutroOperator, AntiOperator} \rangle$$

defined as follows [12, 13, 14]:

10.1. (Classical) Operator

For any n -tuple $(x_1, x_2, \dots, x_n) \in H^n$, one has $\omega(x_1, x_2, \dots, x_n) \in H$ and $\omega(x_1, x_2, \dots, x_n)$ is a determinate (clear, certain, unique) output. Therefore $(T, I, F) = (1, 0, 0)$.

10.2. NeutroOperator

There are some n -tuples $(x_1, x_2, \dots, x_n) \in H^n$ such that $\omega(x_1, x_2, \dots, x_n) \in H$ and $\omega(x_1, x_2, \dots, x_n)$ are determinate (clear, certain, unique) outputs (degree of truth T);

other n -tuples $(y_1, y_2, \dots, y_n) \in H^n$ such that $\omega(y_1, y_2, \dots, y_n) \in H$ and $\omega(y_1, y_2, \dots, y_n)$ are indeterminate (unclear, uncertain, not unique) output (degree of indeterminacy I);

and other n -tuples $(z_1, z_2, \dots, z_n) \in H^n$ such that $\omega(z_1, z_2, \dots, z_n) \in U - H$ (degree of falsehood F);

where $(T, I, F) \neq \{(1, 0, 0), (0, 0, 1)\}$ that represent the first (Classical Operator), and respectively the third case (AntiOperator).

10.3. AntiOperator

For any n -tuple $(x_1, x_2, \dots, x_n) \in H^n$, one has $\omega(x_1, x_2, \dots, x_n) \in U - H$. Therefore $(T, I, F) = (0, 0, 1)$.

11. Particular Cases of Operators

11.1. Determinate Operator

A *Determinate Operator* is an operator whose degree of indeterminacy $I = 0$, while the degree of truth $T = 1$ and degree of falsehood $F = 0$.

Therefore, only the Classical Operator is a Determinate Operator.

11.2. IndetermOperator

As a subclass of the above NeutroOperator, there is the *IndetermOperator* (*Indeterminate Operator*), which is an operator that has some degree of indeterminacy ($I > 0$).

12. Applications of the IndetermOperators to the Soft Sets

Let H be a set of finite number of houses (or, in general, objects, items, etc.):

$$H = \{h_1, h_2, \dots, h_n\} \cup \{\emptyset\}, 1 \leq n < \infty,$$

where $h_1 = \text{house1}$, $h_2 = \text{house2}$, etc.

and \emptyset is the empty (or null) element (no house).

13. Determinate and Indeterminate Soft Operators

Let us define four soft operators on H .

13.1. joinAND

joinAND, or put together, denoted by \mathbb{A} , defined as:

$x \mathbb{A} y = x$ and y , or put together x and y ; herein the conjunction "and" has the common sense from the natural language.

$x \text{ \& } y = \{x, y\}$ is a set of two objects.

For example:

$h_1 \text{ \& } h_2 = \text{house1 \& house2} = \text{house1 and house2}$

= put together *house1* and *house2* = $\{\text{house1}, \text{house2}\} = \{h_1, h_2\}$.

joinAND is a Determinate Soft Operator since one gets one clear (certain) output.

13.2. *disjoinOR*

disjoinOR, or separate in parts, denoted by \forall , defined as:

$x \text{ disjoinOR } y = x \forall y = \{x\}, \text{ or } \{y\}, \text{ or both } \{x, y\}$

= x , or y , or both x and y ;

herein, similarly, the disjunction “or” (and the conjunction “and” as well) have the common sense from the natural language.

But there is some indeterminacy (uncertainty) to choose among three alternatives.

For example:

$h_1 \forall h_2 = \text{house1 } \forall \text{house2} = \text{house1, or house2, or both houses together } \{\text{house1 and house2}\}$.

disjoinOR is an IndetermSoft Operator, since it does not have a clear unique output, but three possible alternative outputs to choose from.

13.3. *exclusiveOR*

exclusiveOR, meaning either one, or the other; it is an IndetermSoft Operator (to choose among two alternatives).

$h_1 \forall_E h_2 = \text{either } h_1, \text{ or } h_2, \text{ and no both } \{h_1, h_2\}$.

13.4. *NOT*

NOT, or no, or sub-negation/sub-complement, denoted by \Rightarrow , where

$\text{NOT}(h) = \Rightarrow h = \text{no } h$, in other words all elements from H , except h , either single elements, or two elements, ..., or $n - 1$ elements from $H - \{h\}$, or the empty element \emptyset .

The “not” negation has the common sense from the natural language; when we say “not John” that means “someone else” or “many others”.

13.4.1. Theorem 1

Let the cardinal of the set $H - \{h\}$ be $|H - \{h\}| = m \geq 1$.

Then $\text{NOT}(h) = \{x, x \in P(H - \{h\})\}$ and the cardinal $|\text{NOT}(h)| = 2^{n-1}$.

Proof:

Because $\text{NOT}(h)$ means all elements from H , except h , either by single elements, or by two elements, ..., or by $n - 1$ elements from $H - \{h\}$, or the empty element \emptyset , then one obtains:

$C_{n-1}^1 + C_{n-1}^2 + \dots + C_{n-1}^{n-1} + 1 = (2^{n-1} - 1) + 1 = 2^{n-1}$ possibilities (alternatives to h).

The *NOT* operator has as output a multitude of sub-negations (or sub-complements).

NOT is also an IndetermSoft Operator.

13.4.2. Example

Let $H = \{x_1, x_2, x_3, x_4\}$

Then,

$\text{NOT}(x_1) = \Rightarrow x_1 = \text{either } x_2, \text{ or } x_3, \text{ or } x_4,$

or $\{x_2, x_3\}, \text{ or } \{x_2, x_4\}, \text{ or } \{x_3, x_4\},$

or $\{x_2, x_3, x_4\}$,
 or \emptyset ;
 therefore $C_3^1 + C_3^2 + C_3^3 + 1 = 3 + 3 + 1 + 1 = 8 = 2^3$ possibilities/alternatives.
 Graphic representations:

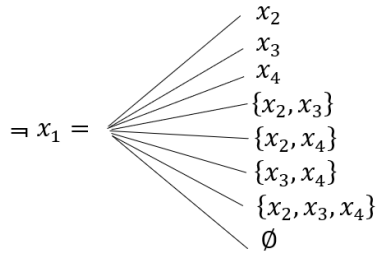

Or another representation (equivalent to the above) is below:

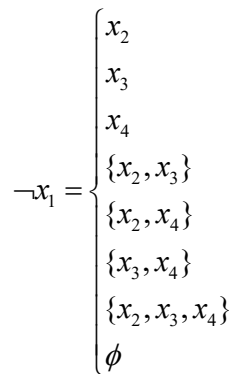

The NOT operator is equivalent to $(2^{n-1} - 1)$ OR disjunctions (from the natural language).

14. Similarities between IndetermSoft Operators and Classical Operators

(i) joinAND is similar to the classical logic AND operator (\wedge) in the following way.

Let A, B, C be propositions, where $C = A \wedge B$.

Then the proposition C is true, if both: $A = \text{true}$, and $B = \text{true}$.

(ii) disjoinOR is also similar to the classical logic OR operator (\vee) in the following way.

Let A, B, D be propositions, where $D = A \vee B$.

Then the proposition D is true if:

- either $A = \text{true}$,
- or $B = \text{true}$,
- or both $A = \text{true}$ and $B = \text{true}$

(therefore, one has three possibilities).

(iii) exclusiveOR is also similar to the classical logic exclusive OR operator (\vee_E) in the following way.

Let A, B, D be propositions, where $D = A \vee_E B$

Then the proposition D is true if:

- either $A = \text{true}$,
- or $B = \text{true}$,
- and not both A and B are true simultaneously

(therefore, one has two possibilities).

(iv) NOT resembles the classical set, or complement operator (\neg), in the following way.

Let A, B, C, D be four sets, whose intersections two by two are empty, from the universe of discourse $\mathcal{U} = A \cup B \cup C \cup D$.

Then $\neg A = \text{Not}A = \mathcal{U} \setminus A$ = the complement of A with respect to \mathcal{U} .

While $\neg A$ has only one exact output ($\mathcal{U} \setminus A$) in the classical set theory, the NOT operator $\Rightarrow A$ has 8 possible outcomes: either the empty set (\emptyset), or B , or C , or D , or $\{B, C\}$, or $\{B, D\}$, or $\{C, D\}$, or or $\{B, C, D\}$.

15. Properties of Operators

Let $x, y, z \in H(\mathbb{A}, \mathbb{V}, \mathbb{V}_E, \Rightarrow)$.

15.1. Well-Defined Operators

Let consider the set H closed under these four operators: $H(\mathbb{A}, \mathbb{V}, \mathbb{V}_E, \Rightarrow)$.

Therefore, for any $x, y \in H$ one has:

$x \mathbb{A} y \in H(\mathbb{A}, \mathbb{V}, \mathbb{V}_E, \Rightarrow)$, because $\{x, y\} \in H(\mathbb{A}, \mathbb{V}, \mathbb{V}_E, \Rightarrow)$,

and $x \mathbb{V} y \in H(\mathbb{A}, \mathbb{V}, \mathbb{V}_E, \Rightarrow)$, because each of $\{x\}, \{y\}, \{x, y\} \in H(\mathbb{A}, \mathbb{V}, \mathbb{V}_E, \Rightarrow)$,

also $x \mathbb{V}_E y \in H(\mathbb{A}, \mathbb{V}, \mathbb{V}_E, \Rightarrow)$, because each of $\{x\}, \{y\} \in H(\mathbb{A}, \mathbb{V}, \mathbb{V}_E, \Rightarrow)$,

Then the NOT operator is also well-defined because it is equivalent to a multiple of disjoinOR operators.

Thus:

$$\mathbb{A} : H^2 \rightarrow H(\mathbb{A}, \mathbb{V}, \mathbb{V}_E, \Rightarrow)$$

$$\mathbb{V} : H^2 \rightarrow H(\mathbb{A}, \mathbb{V}, \mathbb{V}_E, \Rightarrow)$$

$$\mathbb{V}_E : H^2 \rightarrow H(\mathbb{A}, \mathbb{V}, \mathbb{V}_E, \Rightarrow)$$

$$\Rightarrow : H \rightarrow H(\mathbb{A}, \mathbb{V}, \mathbb{V}_E, \Rightarrow)$$

15.2. Commutativity

$x \mathbb{A} y = y \mathbb{A} x$, and $x \mathbb{V} y = y \mathbb{V} x$, and $x \mathbb{V}_E y = y \mathbb{V}_E x$

Proof

$$x \mathbb{A} y = \{x, y\} = \{y, x\} = y \mathbb{A} x$$

$$x \mathbb{V} y = (\{x\}, \text{or } \{y\}, \text{or } \{x, y\}) = (\{y\} \text{ or } \{x\}, \text{or } \{y, x\}) = y \mathbb{V} x$$

$$x \mathbb{V}_E y = (\text{either } \{x\}, \text{ or } \{y\}, \text{ but not both } x \text{ and } y) =$$

$$= (\text{either } \{y\}, \text{ or } \{x\}, \text{ but not both } y \text{ and } x) = y \mathbb{V}_E x.$$

15.3. Associativity

$$x \mathbb{A} (y \mathbb{A} z) = (x \mathbb{A} y) \mathbb{A} z,$$

and $x \mathbb{V} (y \mathbb{V} z) = (x \mathbb{V} y) \mathbb{V} z$, and $x \mathbb{V}_E (y \mathbb{V}_E z) = (x \mathbb{V}_E y) \mathbb{V}_E z$

Proof

$$\begin{aligned} x \mathbb{A} (y \mathbb{A} z) &= \{x, y \mathbb{A} z\} = \{x, \{y, z\}\} \\ &= \{x, y, z\} = \{\{x, y\}, z\} \\ &= (x \mathbb{A} y) \mathbb{A} z. \end{aligned}$$

$$x \mathbb{V} (y \mathbb{V} z) = (x \mathbb{V} y) \mathbb{V} z$$

$$x \text{ or } (y \text{ or } z) = x \text{ or } \begin{pmatrix} y \\ z \\ y \text{ or } z \end{pmatrix} = x \text{ or } \begin{pmatrix} y \\ z \\ y \text{ or } z \end{pmatrix} \begin{pmatrix} y \\ z \\ \{y, z\} \end{pmatrix}$$

$$\begin{aligned}
 & x \text{ or } y = \begin{cases} x \\ y \\ \{x, y\} \end{cases} \\
 & x \text{ or } z = \begin{cases} x \\ z \\ \{x, z\} \end{cases} \\
 = & \begin{matrix} x \text{ or } y \\ x \text{ or } z \end{matrix} \\
 & \left(\begin{matrix} x \\ x \text{ or } \{y, z\} \end{matrix} \right) = \begin{cases} x \\ \{y, z\} \\ \{x, y, z\} \end{cases} \\
 = & x, y, z, \{x, y\}, \{x, z\}, \{y, z\}, \{x, y, z\}. \\
 & x \text{ or } z \begin{cases} x \\ z \\ \{x, z\} \end{cases} \\
 (x \text{ or } y) \text{ or } z = \begin{cases} x \\ y \\ \{x, y\} \end{cases} \text{ or } z = \begin{matrix} y \text{ or } z \\ \begin{cases} y \\ z \\ \{y, z\} \end{cases} \\ \begin{matrix} \{x, z\} \text{ or } z \\ \begin{cases} \{x, y\} \\ z \\ \{x, y, z\} \end{cases} \end{matrix} \\
 = & x, y, z, \{x, y\}, \{x, z\}, \{y, z\}, \{x, y, z\}.
 \end{aligned}$$

Therefore, $(x \text{ or } y) \text{ or } z = x \text{ or } (y \text{ or } z) = x, y, z, \{x, y\}, \{y, z\}, \{z, x\}, \{x, y, z\}$ with $2^3 - 1 = 8 - 1 = 7$ possibilities.

$x \text{ } \forall_E (y \text{ } \forall_E z) =$
 either x , or $(y \text{ } \forall_E z)$, and no both x and $(y \text{ } \forall_E z) =$ either x , or $(y, \text{ or } z, \text{ and no both } y \text{ and } z)$, and no both x and $(\text{either } y \text{ or } z) =$ either x , or y , or z , and no both $\{y, z\}$, and $(\text{no } x \text{ and no } (\text{either } y \text{ or } z)) =$ either x , or y , or z , and no $\{y, z\}$, no $\{x, y\}$, no $\{x, z\} = (x \text{ } \forall_E y) \text{ } \forall_E z$

15.4. Distributivity of joinAND over disjoinOR and exclusiveOR

$$x \text{ } \wedge (y \text{ } \vee z) = (x \text{ } \wedge y) \text{ } \vee (x \text{ } \wedge z)$$

P roof

$$\begin{aligned}
 & x \text{ } \wedge (y \text{ } \vee z) = x \text{ and } (y \text{ or } z) = x \text{ and } (y, \text{ or } z, \text{ or } \{y, z\}) \\
 & = x \text{ and } y, \text{ or } x \text{ and } z, \text{ or } x \text{ and } \{y, z\} \\
 & = \{x, y\}, \text{ or } \{x, z\}, \text{ or } \{x, y, z\} \\
 & = \{z, y\}, \{x, z\}, \{x, y, z\}. \\
 & (x \text{ } \wedge y) \text{ } \vee (x \text{ } \wedge z) = \{x, y\} \\
 & \text{or } \{x, z\} = \{x, y\}, \{x, z\}, \{x, y, x, z\} = \{x, y\}, \{x, z\}, \{x, y, z\}.
 \end{aligned}$$

$$\begin{aligned}
 & x \text{ } \wedge (y \text{ } \forall_E z) = x \text{ and } (\text{either } y, \text{ or } z, \text{ and no both } \{y, z\}) = \text{either } x \text{ and } y, \text{ or } x \text{ and } z, \\
 & \text{and } x \text{ and no both } \{y, z\} = \text{either } \{x, y\}, \text{ or } \{x, z\}, \text{ and } \{x, \text{ no } \{y, z\}\} = \\
 & = \text{either } \{x, y\}, \text{ or } \{x, z\}, \text{ and no } \{x, y, z\} = (x \text{ } \wedge y) \text{ } \forall_E (x \text{ } \wedge z)
 \end{aligned}$$

15.5. No distributivity of disjoinOR and exclusiveOR over joinAND

$$\begin{aligned}
 & x \text{ } \vee (y \text{ } \wedge z) \neq (x \text{ } \vee y) \text{ } \wedge (x \text{ } \vee z) \\
 & x \text{ } \vee (y \text{ } \wedge z) = x \text{ or } (y \text{ and } z) = x \text{ or } \{y, z\} = x, \{y, z\}, \{x, y, z\}
 \end{aligned}$$

But

$$\begin{aligned}
 & (x \text{ } \vee y) \text{ } \wedge (x \text{ } \vee z) = (x, y, \{x, y\}) \text{ and } (x, z, \{x, z\}) \\
 & = \{x, x\}, \{x, z\}, \{x, z\}, \{y, z\}, \{y, x\}, \{x, y, z\}, \{x, y\}, \{x, y, z\}, \{x, y, z\} \\
 & = x, \{x, y\}, \{x, z\}, \{y, z\}, \{x, y, z\}.
 \end{aligned}$$

Whence in general $x, \{y, z\}, \{x, y, z\} \neq x, \{x, y\}, \{x, z\}, \{y, z\}, \{x, y, z\}$.

While in classical Boolean Algebra the distribution of or over and is valid:

$$x \vee (y \wedge z) = (x \vee y) \wedge (x \vee z).$$

$$\begin{aligned} x \mathbb{W}_E (y \mathbb{A} z) &= \text{either } x, \text{ or } \{y, z\}, \text{ and no } \{x, y, z\} \neq \\ &\neq (x \mathbb{W}_E y) \mathbb{A} (x \mathbb{W}_E z) = (\text{either } x, \text{ or } y, \text{ and no } \{x, y\}) \text{ and } (\text{either } x, \text{ or } z, \text{ and no } \{x, z\}) \end{aligned}$$

15.6. Idempotence

$$\begin{aligned} x \mathbb{A} x &= \{x, x\} = x \\ x \mathbb{V} x &= \text{either } x, \text{ or } x, \text{ or } \{x, x\} \\ &= x, \text{ or } x, \text{ or } x \\ &= x. \\ x \mathbb{W}_E x &= \text{either } x, \text{ or } x, \text{ and no } \{x, x\} = \text{impossible.} \end{aligned}$$

15.6.1. Theorem 2

Let $x_1, x_2, \dots, x_n \in (H, \mathbb{A}, \mathbb{V}, \mathbb{W}_E)$, for $n \geq 2$. Then:

(i) $x_1 \mathbb{A} x_2 \mathbb{A} \dots \mathbb{A} x_n = \{x_1, x_2, \dots, x_n\}$,

and

(ii) $x_1 \mathbb{V} x_2 \mathbb{V} \dots \mathbb{V} x_n = x_1, x_2, \dots, x_n,$

$\{x_1, x_2\}, \{x_1, x_3\}, \dots, \{x_{n-1}, x_n\},$

$\{x_1, x_2, x_3\}, \dots$

$\dots \dots \dots \dots \dots \dots$

$\{x_1, x_2, \dots, x_{n-1}\}, \dots$

$\{x_1, x_2, \dots, x_{n-1}, x_n\}.$

There are: $C_n^1 + C_n^2 + \dots + C_n^{n-1} + C_n^n = 2^n - 1$ possibilities/alternatives.

The bigger is n , the bigger the indeterminacy.

(iii) $x_1 \mathbb{W}_E x_2 \mathbb{W}_E \dots \mathbb{W}_E x_n = x_1, x_2, \dots, x_n =$

$= \text{either } x_1, \text{ or } x_2, \dots, \text{ or } x_n,$

and no two or more variables be true simultaneously.

There are: $C_n^1 = n$ possibilities.

The bigger is n , the bigger the indeterminacy due to many alternatives.

Proof

(i) The joinAND equality is obvious.

(ii) The disjoinOR outputs from the fact that for the disjunction of n proposition to be true, it is enough to have at least one which is true. As such, we may have only one proposition true, or only two propositions true, and so on, only $n - 1$ propositions true, up to all n propositions true.

(iii) It is obvious.

15.7. The classical Boolean Absorption Law1

$x \wedge (x \vee y) = x$ does not work in this structure, since $x \mathbb{A} (x \mathbb{V} y) \neq x$.

Proof

$$\begin{aligned} x \mathbb{A} (x \mathbb{V} y) &= x \text{ and } (x \text{ or } y) \\ &= x \text{ and } \begin{cases} x \\ y \\ \{x, y\} \end{cases} \\ &= \{x, x\} \text{ or } \{x, y\} \text{ or } \{x, x, y\} \\ &= x \text{ or } \{x, y\} \text{ or } \{x, y\} \\ &= x \text{ or } \{x, y\} \end{aligned}$$

$$= \begin{matrix} x \\ \{x, y\} \\ \{x, x, y\} \end{matrix} = \begin{matrix} x \\ \{x, y\} \\ \{x, y\} \end{matrix} = \begin{matrix} x \\ \{x, y\} \end{matrix} \neq x.$$

But this one work:

$$x \text{ \textcircled{A} } (x \text{ \textcircled{V} } y) = x \text{ and (either } x, \text{ or } y, \text{ and no } \{x, y\}) = \\ = (x \text{ and } x), \text{ or } (x \text{ and } y), \text{ and } (x \text{ and no}\{x, y\}) = x.$$

15.8. The classical Boolean Absorption Law2

$x \vee (x \wedge y) = x$ does not work in this structure, since $x \vee (x \text{ \textcircled{A} } y) \neq x$.

Proof

$$x \text{ \textcircled{A} } (x \text{ \textcircled{V} } y) = x \text{ and } (x \text{ or } y) \\ x \text{ or } (x \text{ and } y) = x \text{ or } \{x, y\} \\ = \begin{matrix} x \\ \{x, y\} \\ \{x, x, y\} \end{matrix} = \begin{matrix} x \\ \{x, y\} \\ \{x, y\} \end{matrix} \\ = \begin{matrix} x \\ \{x, y\} \end{matrix} \neq x.$$

But this one work:

$$x \text{ \textcircled{V} } (x \text{ \textcircled{A} } y) = (\text{either } x), \text{ or } \{x, y\}, \text{ and } (\text{no } \{x, y\}) = x.$$

15.9. Annihilators and Identities for IndetermSoft Algebra

While 0 is an annihilator for conjunction \wedge in the classical Boolean Algebra, $x \wedge 0 = 0$, in IndetermSoft Algebra \emptyset is an identity for $\text{ \textcircled{A} }$, while for the others it does not work.

Proof

$$x \text{ \textcircled{A} } \emptyset = x \text{ and } \emptyset \\ = x \text{ and nothing} \\ = x \text{ put together with nothing} \\ = x.$$

15.10. \emptyset is neither an identity, nor an annihilator for disjoinOR nor for exclusiveOR

While 0 is an identity for the \vee in the classical Boolean Algebra, $x \vee 0 = x$ in IndetermAlgebra \emptyset is neither an identity, nor an annihilator.

Proof

$$x \text{ \textcircled{V} } \emptyset = x, \text{ or } \emptyset \text{ (nothing), or } \{x, \emptyset\} \\ = x, \text{ or } \emptyset, \text{ or } x \\ = x, \text{ or } \emptyset. \\ x \text{ \textcircled{V} } \emptyset = \text{either } x, \text{ or } \emptyset, \text{ and no } \{x, \emptyset\}.$$

15.11. The negation of \emptyset has multiple solutions

While in the classical Boolean Algebra the negation of 0 is 1 (one solution only), $\neg 0 = 1$, in IndetermAlgebra the negation of \emptyset has multiple solutions.

Proof

$$\Rightarrow \emptyset = NOT(\emptyset), \\ = \text{not nothing} \\ = \text{one or more elements from the set that the operator } \Rightarrow \text{ is defined upon.}$$

Example

$$\text{Let } H = \{x_1, x_2, x_3\} \cup \emptyset. \\ \text{Then, } \Rightarrow \emptyset = x_1, \text{ or } x_2, \text{ or } x_3, \text{ or } \{x_1, x_2\}, \text{ or } \{x_1, x_3\}, \text{ or } \{x_2, x_3\}, \text{ or } \{x_1, x_2, x_3\},$$

therefore 7 alternative solutions.

15.12. *The Double Negation is invalid on IndetermSoft Algebra*

While in the classical Boolean Algebra the Double Negation Law is valid: $\neg(\neg x) = x$, in IndetermAlgebra it is not true:

In general, $\Rightarrow (\Rightarrow x) \neq x$.

Proof

A counter-example:

Let $H = \{x_1, x_2, x_3\} \cup \emptyset$.

$\Rightarrow x_1 =$ what is not x_1 or does not contain x_1
 $= x_2, x_3, \{x_2, x_3\}, \emptyset$.

Thus one has 4 different values of the negation of x_1 .

Let us choose $\Rightarrow x_1 = x_2$; then $\Rightarrow (\Rightarrow x_1) = x_2 = (x_1, x_3, \{x_1, x_3\}, \emptyset) \neq x_1$.

Similarly for taking other values of $\Rightarrow x_1$.

Let $H = \{x_1, x_2, \dots, x_n\} \cup \emptyset, n \geq 2$. Let $x \in H$.

Minimum and Maximum elements with respect to the relation of inclusion are:

$\emptyset =$ the empty (null) element

and respectively

$x_1 \overset{\text{notation}}{\wedge} x_2 \wedge \dots \wedge x_n = \{x_1, x_2, \dots, x_n\} = H$,
 but in the Boolean Algebra they are 0 and 1 respectively.

15.13. *The whole set H is an annihilator for joinAND*

While in the classical Boolean Algebra the identity for \wedge is 1, since $x \wedge 1 = x$, in the IndetermSoft Algebra for \wedge there is an annihilator H, since $x \wedge H = H$, since $x \wedge H = \{x_1, x_2, \dots, x_n, x\} = H$, because $x \in H$ so x is one of x_1, x_2, \dots, x_n .

16. The maximum (H) is neither annihilator nor identity

While in the classical Boolean Algebra the annihilator for \vee is 1, because $x \vee 1 = 1$, in the IndetermSoft Algebra for \vee the maximum H is neither annihilator nor identity,

$x \vee H = x$ or $H = x, H, \{x, H\} = x, H, H = x, H$.

$x \vee_E H =$ either x , or H , and (no x and no H).

17. Complementation1

In the classical Boolean Algebra, Complementation1 is: $x \wedge \neg x = 0$.

In the IndetermSoft Algebra, $x \wedge (\Rightarrow x) \neq \emptyset$, and $x \wedge (\Rightarrow x) \neq H$.

Counter-Example

$M = \{x_1, x_2, x_3\} \cup \emptyset$
 $\Rightarrow x_1 = x_2, x_3, \{x_2, x_3\}, \emptyset$
 $x_1 \wedge (\Rightarrow x_1) = x_1 \wedge (x_2, x_3, \{x_2, x_3\}, \emptyset) =$
 $= (x_1 \text{ and } x_2) \text{ or } (x_1 \text{ or } x_3)$
 $\text{or } (x_1 \text{ and } \{x_2, x_3\})$
 $\text{or } (x_1 \text{ and } \emptyset) =$
 $= (x_1, \{x_1, x_2\}, \{x_1, x_3\}, \{x_1, x_2, x_3\}) \neq \emptyset \neq M$.

18. Complementation2

In the classical Boolean Algebra, Complementation2 is: $x \vee \neg x = 1$.

In the IndetermSoft Algebra, $x \forall \Rightarrow x \neq H$, and $x \forall \Rightarrow x \neq \emptyset$.

Counter-Example

The above $H = \{x_1, x_2, x_3\} \cup \emptyset$

and $\Rightarrow x_1 = x_2, x_3, \{x_2, x_3\}, \emptyset$, then

$$x_1 \forall \Rightarrow x_1 = x_1 \forall (x_2, x_3, \{x_2, x_3\}, \emptyset) = \begin{cases} x_1 \\ x_2, x_3, \{x_2, x_3\}, \emptyset \\ x_1, x_2, x_3, \{x_2, x_3\}, \emptyset \end{cases}$$

$$= x_1, \text{ or } (x_2, x_3, \{x_2, x_3\}, \emptyset), \text{ or } (x_1, x_2, x_3, \{x_2, x_3\}, \emptyset)$$

which is different from H and from \emptyset .

And:

$$x_1 \forall_E \Rightarrow x_1 = x_1 \forall_E (x_2, x_3, \{x_2, x_3\}, \emptyset) = \left\{ \begin{matrix} x_1 \\ x_2, x_3, \{x_2, x_3\}, \emptyset \end{matrix} \right\} \text{ and no } (x_1, x_2, x_3, \{x_2, x_3\}, \emptyset),$$

which is different from H and from \emptyset .

19. De Morgan Law1 in the IndetermSoft Algebra

De Morgan Law1 from Classical Boolean Algebra is:

$$\neg(x \vee y) = (\neg x) \wedge (\neg y)$$

is also true in the IndetermSoft Algebra:

$$\Rightarrow (x \forall y) = (\Rightarrow x) \wedge (\Rightarrow y)$$

Proof

$$\begin{aligned} \Rightarrow (x \forall y) &= \Rightarrow (x, \text{ or } y, \text{ or } \{x \text{ and } y\}) \\ &= \Rightarrow x, \text{ and } \Rightarrow y, \text{ and } \Rightarrow \{x_1 \text{ and } y\} \\ &= \Rightarrow x_1, \text{ and } \Rightarrow y, \text{ and } (\Rightarrow x, \text{ or } \Rightarrow y) \\ &= \Rightarrow x, \text{ and } \Rightarrow y \\ &= (\Rightarrow x) \wedge (\Rightarrow y). \end{aligned}$$

Example

$$\begin{aligned} M &= \{x_1, x_2, x_3\} \cup \emptyset \\ \Rightarrow (x_1 \forall x_2) &= \Rightarrow (x_1, \text{ or } x_2, \text{ or } \{x_1 \text{ and } x_2\}) \\ &= \Rightarrow x_1, \text{ and } \Rightarrow x_2, \text{ and } (\Rightarrow x_1 \text{ or } \Rightarrow x_2) \\ &= \Rightarrow x_1, \text{ and } \Rightarrow x_2 \\ &= (\Rightarrow x_1) \wedge (\Rightarrow x_2). \\ \Rightarrow x_1 &= (x_2, x_3, \{x_2, x_3\}, \emptyset) \\ \Rightarrow x_2 &= (x_1, x_3, \{x_1, x_3\}, \emptyset) \\ (\Rightarrow x_1) \wedge (\Rightarrow x_2) &= (x_2, x_3, \{x_2, x_3\}, \emptyset) \wedge (x_1, x_3, \{x_1, x_3\}, \emptyset) \\ &= x_1, x_2, x_3, \{x_1, x_3\}, \{x_2, x_3\}, \emptyset. \end{aligned}$$

20. De Morgan Law2 in the IndetermSoft Algebra

De Morgan Law2 in the classical Boolean Algebra is

$$\neg(x \wedge y) = (\neg x) \vee (\neg y)$$

is also true in the new structure called IndetermSoft Algebra:

$$\Rightarrow (x \wedge y) = (\Rightarrow x) \forall (\Rightarrow y)$$

Proof

$$\Rightarrow (x \wedge y) = \Rightarrow (\{x \text{ and } y\}) = \Rightarrow x, \text{ or } \Rightarrow y, \text{ or } \{\Rightarrow x, \text{ and } \Rightarrow y\} = (\Rightarrow x) \forall (\Rightarrow y)$$

Example

$$\begin{aligned} \Rightarrow (x_1 \wedge x_2) &= \Rightarrow (\{x_1, x_2\}) \\ &= (\Rightarrow x_1, \text{ or } \Rightarrow x_2, \text{ or } (\Rightarrow x_1 \text{ and } \Rightarrow x_2)) \\ &= (x_2, x_3, \{x_2, x_3\}, \emptyset) = \end{aligned}$$

$$\begin{aligned}
 & \text{OR } (x_2, x_3, \{x_2, x_3\}, \emptyset) \\
 & \text{OR } (x_1, x_3, \{x_1, x_3\}, \emptyset) \\
 & \text{OR } (x_1, x_2, x_3, \{x_1, x_3\}, \{x_2, x_3\}, \emptyset) = \\
 & = (x_1, x_2, x_3, \{x_1, x_3\}, \{x_2, x_3\}, \emptyset) \\
 (\Rightarrow x_1) \vee (\Rightarrow x_2) & \Rightarrow x_1, \text{ OR } \Rightarrow x_2, \text{ OR } (\Rightarrow x_1 \wedge \Rightarrow x_2) = \\
 & (x_2, x_3, \{x_2, x_3\}, \emptyset) \\
 & \text{OR } (x_1, x_3, \{x_1, x_3\}, \emptyset) \\
 & \text{OR } (x_1, x_2, x_3, \{x_1, x_3\}, \{x_2, x_3\}, \emptyset) \\
 & = (x_1, x_2, x_3, \{x_1, x_3\}, \{x_2, x_3\}, \emptyset) \\
 & \Rightarrow (x_1 \wedge x_2)
 \end{aligned}$$

*

This IndetermSoft Algebra is not a Boolean Algebra because many of Boolean Laws do not work, such as:

- Identity for \wedge
- Identity for \vee
- Identity for \vee_E
- Annihilator for \wedge
- Annihilator for \vee
- Annihilator for \vee_E
- Absorption1 $[x \wedge (x \vee y) = x]$
- Absorption2 $[x \vee (x \wedge y) = x]$
- Double Negation
- Complementation1 $[x \wedge \Rightarrow x = \emptyset]$
- Complementation2 $\{ [x \vee \Rightarrow x = H] \text{ and } [x \vee_E \Rightarrow x = H] \}$

21. Practical Applications of Soft Set and IndetermSoft Set

Let $H = \{h_1, h_2, h_3, h_4\}$ a set of four houses, and the attribute $a = color$, whose values are $A = \{white, green, blue, red\}$.

21.1. Soft Set

The function

$$F: A \rightarrow \mathcal{P}(H)$$

where $\mathcal{P}(H)$ is the powerset of H ,

is called a classical Soft Set.

For example,

$F(\text{white}) = h_3$, i.e. the house h_3 is painted white;

$F(\text{green}) = \{h_1, h_2\}$, i.e. both houses h_1 and h_2 are painted green;

$F(\text{blue}) = h_4$, i.e. the house h_4 is painted blue;

$F(\text{red}) = \emptyset$, i.e. no house is painted red.

Therefore, the information about the houses' colors is well-known, certain.

21.2. IndetermSoft Set

But there are many cases in our real life when the information about the attributes' values of the objects (or items – in general) is unclear, uncertain.

That is why we need to extend the classical (Determinate) Soft Set to an Indeterminate Soft Set.

The determinate (exact) soft function

$$F: A \rightarrow \mathcal{P}(H)$$

is extended to an indeterminate soft function

$$F: A \rightarrow H(\mathbb{A}, \mathbb{V}, \mathbb{V}_E, \mathbb{=}),$$

where $(\mathbb{A}, \mathbb{V}, \mathbb{V}_E, \mathbb{=})$ is a set closed under \mathbb{A} , \mathbb{V} , \mathbb{V}_E , and $\mathbb{=}$, and $f(x)$ is not always determinate.

For example,

$$F(\text{white}) = h_3 \mathbb{V} h_4,$$

means the houses h_3 or h_4 are white, but we are not sure which one,

whence one has three possibilities/outcomes/alternatives:

- either h_3 is white (and h_4 is not),
- or h_4 is white (and h_3 is not),
- or both h_3 and h_4 are white.

This is an indeterminate information.

We may also simply write:

$$F(\text{white}) = \begin{cases} h_3 \\ h_4 \\ \{h_3, h_4\} \end{cases}$$

$$\text{or } F(\text{white}) = h_3, h_4, \{h_3, h_4\},$$

where $\{h_3, h_4\}$ means $\{h_3 \text{ and } h_4\}$,

that we read as: either h_3 , or h_4 , or $\{h_3 \text{ and } h_4\}$.

Another example:

$$F(\text{blue}) = \mathbb{=} h_2, \text{ or the house } h_2 \text{ is not blue,}$$

therefore other houses amongst $\{h_1, h_3, h_4\}$ may be blue,

or no house (\emptyset) may be blue.

This is another indeterminate information.

The negation of h_2 (denoted as $\text{NOT}(h_2) = \mathbb{=} h_2$) is not equal to the classical complement of $C(h_2)$ of the element h_2 with respect to the set H , since

$$C(h_2) = H \setminus \{h_2\} = \{h_1, h_3, h_4\},$$

but $\mathbb{=} h_2$ may be any subset of $H \setminus \{h_2\}$, or any sub-complement of $C(h_2)$,

again many (in this example 8) possible outcomes to choose from:

$$\begin{aligned} \mathbb{=} h_2 &= h_1, h_3, h_4, \{h_1, h_3\}, \{h_1, h_4\}, \{h_3, h_4\}, \{h_1, h_3, h_4\}, \emptyset = \\ &= \text{either } h_1, \text{ or } h_3, \text{ or } h_4, \\ &\text{or } \{h_1 \text{ and } h_3\}, \{h_1 \text{ and } h_4\}, \{h_3 \text{ and } h_4\}, \\ &\text{or } \{h_1 \text{ and } h_3 \text{ and } h_4\}, \\ &\text{or } \emptyset \text{ (null element, i.e. no other house is blue).} \end{aligned}$$

The negation ($\mathbb{=} h_2$) produces a higher degree of indeterminacy than the previous unions: $(h_3 \mathbb{V} h_4)$ and respectively $(h_3 \mathbb{V}_E h_4)$.

The intersection (\mathbb{A}) is a determinate (certain) operator.

For example,

$$F(\text{green}) = h_1 \mathbb{A} h_2, \text{ which is equal to } \{h_1, h_2\}, \text{ i.e. } h_1 \text{ and } h_2 \text{ put together, } \{h_1 \text{ and } h_2\}.$$

A combination of these operators may occur, so the indeterminate (uncertain) soft function becomes more complex.

Example again.

$$F(\text{green}) = h_1 \mathbb{A} (\mathbb{=} h_4), \text{ where of course } \mathbb{=} h_4 \neq h_1, \text{ which means that:}$$

the house h_1 is green,

and other houses amongst $\{h_2, h_3\}$ may be blue,

or \emptyset (no other house is blue).

$$\begin{aligned} h_1 \mathbb{A} (\mathbb{=} h_4) &= h_1 \text{ and } (\text{NOT}h_4) \\ &= h_1 \text{ and } (h_1, h_2, h_3, \{h_1, h_2\}, \{h_1, h_3\}, \{h_2, h_3\}, \{h_1, h_2, h_3\}, \emptyset) \\ &[\text{one cuts } h_1 \text{ since } \mathbb{=} h_4 \text{ suppose to be different from } h_1] \end{aligned}$$

$$\begin{aligned}
 &= h_1 \text{ and } (h_2, h_3, \{h_2, h_3\}, \emptyset) \\
 &= (h_1 \text{ and } h_2) \text{ or } (h_1 \text{ and } h_3) \\
 &\quad \text{or } (h_1 \text{ and } \{h_2, h_3\}) \\
 &\quad \text{or } \emptyset \\
 &= (h_1 \text{ and } h_2) \text{ or } (h_1 \text{ and } h_3) \text{ or } (h_1 \text{ and } h_2 \text{ and } h_3) \text{ or } \emptyset \\
 &\textit{notation} \\
 &= \{h_1, h_2\}, \{h_1, h_3\}, \{h_1, h_2, h_3\}, \emptyset.
 \end{aligned}$$

Thus, 4 possibilities.

22. Definitions of <Algebra, NeutroAlgebra, AntiAlgebra>

Let \mathcal{U} be a universe of discourse, and H a non-empty set included in \mathcal{U} . Also, H is endowed with some operations and axioms.

22.1. Algebra

An algebraic structure whose all operations are well-defined, and all axioms are totally true, is called a classical Algebraic Structure (or **Algebra**). Whence $(T, I, F) = (1, 0, 0)$.

22.2. NeutroAlgebra

If at least one operation or one axiom has some degree of truth (T), some degree of indeterminacy (I), and some degree of falsehood (F), where $(T, I, F) \notin \{(1, 0, 0), (0, 0, 1)\}$, and no other operation or axiom is totally false ($F = 1$), then this is called a NeutroAlgebra.

22.3. AntiAlgebra

An algebraic structure that has at least one operation that is totally outer-defined ($F = 1$) or at least one axiom that is totally false ($F = 0$), is called AntiAlgebra.

23. Definition of IndetermAlgebra

We introduce now for the first time the concept of IntermAlgebra (= Indeterminate Algebra), as a subclass of NeutroAlgebra.

IndetermAlgebra results from real applications, as it will be seen further.

Let \mathcal{U} be a universe of discourse, and H a non-empty set included in \mathcal{U} .

If at least one operation or one axiom has some degree of indeterminacy ($I > 0$), the degree of falsehood $F = 0$, and all other operations and axioms are totally true, then H is an IndetermAlgebra.

24. Definition of IndetermSoft Algebra

The set $H(\mathbb{A}, \mathbb{V}, \mathbb{V}_E, \mathbb{=})$ closed under the following operators:

joinAND (denoted by \mathbb{A}), which is a determinate operator;

disjoinOR (denoted by \mathbb{V}), which is an indeterminate operator;

exclusiveOR (denoted by \mathbb{V}_E), which is an indeterminate operator,

and sub-negation/sub-complement *NOT* (denoted by $\mathbb{=}$), which is an indeterminate operator; is called an IndetermSoft Algebra.

The IndetermSoft Algebra extends the classical Soft Set Algebra.

The IndetermSoft Algebra is a particular case of the IndetermAlgebra, and of the NeutroAlgebra.

The operator *joinAND*

$$\mathbb{A}: H^2 \rightarrow H(\mathbb{A}, \mathbb{V}, \mathbb{V}_E, \mathbb{=})$$

is determinate (in the classical sense):

$$\forall x, y \in H, x \neq y, x \wedge y = x \text{ joinAND } y = \{x, y\} \in H(\wedge, \vee, \vee_E, \Rightarrow)$$

therefore, the aggregation of x and y by using the operator \wedge gives a clear and unique output, i.e. the classical set of two elements: $\{x, y\}$.

But the operator *disjoinOR*

$$\vee: H^2 \rightarrow H(\wedge, \vee, \vee_E, \Rightarrow)$$

is indeterminate because:

$$\forall x, y \in H, x \neq y, x \vee y = x \text{ disjoinOR } y = \begin{cases} \text{either } x \\ \text{or } y \\ \text{or both } \{x \text{ and } y\} \end{cases} = \begin{cases} x \\ y \\ \{x, y\} \end{cases}$$

Thus, the aggregation of x and y by using the operator \vee gives an unclear output, with three possible alternative solutions (either x , or y , or $\{x$ and $y\}$).

The exclusiveOR operator is also indeterminate:

$$\forall x, y \in H, x \neq y, x \vee_E y = x \text{ exclusiveOR } y = \text{either } x, \text{ or } y, \text{ and no } \{x, y\},$$

therefore two possible solutions:

$$\vee_E: H^2 \rightarrow H(\wedge, \vee, \vee_E, \Rightarrow).$$

Similarly, the operator sub-negation / sub-complement NOT

$$\Rightarrow: H \rightarrow H(\wedge, \vee, \vee_E, \Rightarrow)$$

is indeterminate because of many elements $x \in H$,

$$\begin{aligned} NOT(x) = \Rightarrow x &= \text{a part of the complement of } x \text{ with respect to } H \\ &= \text{a subset of } H \setminus \{x\}. \end{aligned}$$

But there are many subsets of $H \setminus \{x\}$, therefore there is an unclear (uncertain, ambiguous) output, with multiple possible alternative solutions.

25. Definition of IndetermSoft Set

Let U be a universe of discourse, H a non-empty subset of U , and $H(\wedge, \vee, \vee_E, \Rightarrow)$ the IndetermSoft Algebra generated by closing the set H under the operators \wedge, \vee, \vee_E , and \Rightarrow .

Let a be an attribute, with its set of attribute values denoted by A . Then the pair (F, A) , where $F: A \rightarrow H(\wedge, \vee, \vee_E, \Rightarrow)$, is called an IndetermSoft Set over H .

26. Fuzzy / Intuitionistic Fuzzy / Neutrosophic / and other fuzzy-extension / IndetermSoft Set

One may associate fuzzy / intuitionistic fuzzy / neutrosophic etc. degrees and extend the IndetermSoft Set to some **Fuzzy / Intuitionistic Fuzzy / Neutrosophic / and other fuzzy-extension / IndetermSoft Set**.

26.1. Applications of (Fuzzy/ Intuitionistic Fuzzy / Neutrosophic / and other fuzzy-extension) IndetermSoft Set

Let $H = \{h_1, h_2, h_3, h_4\}$ be a set of four houses, and the IndetermSoft Algebra generated by closing the set H under the previous soft operators, $H(\wedge, \vee, \vee_E, \Rightarrow)$.

Let the attribute $c = \text{color}$, and its attribute values be the set $C = \{\text{white, green, blue}\}$.

The IndetermSoft Function $F: A \rightarrow H(\wedge, \vee, \vee_E, \Rightarrow)$ forms an IndetermSoft Set.

Let an element $h \in H$, and one denotes by:

$d^\circ(h)$ = any type of degree (either fuzzy, or intuitionistic fuzzy, or neutrosophic, or any other fuzzy-extension) of the element h .

We extend the soft operators $\wedge, \vee, \vee_E, \Rightarrow$ by assigning some degree $d^0(.) \in [0, 1]^p$, where:

$p = 1$ for classical and fuzzy degree, $p = 2$ for intuitionistic fuzzy degree, $p = 3$ for neutrosophic degree, and so on $p = n$ for n -valued refined neutrosophic degree, to the elements involved in the

operators, where \wedge, \vee, \neg represent the conjunction, disjunction, and negation respectively of these degrees in their corresponding fuzzy-extension sets or logics.

For examples:

i. From $F(\text{white}) = h_1 \mathbb{A} h_2$ as in IndetermSoft Set, one extends to:

$F(\text{white}) = h_1(d_1^\circ) \mathbb{A} h_2(d_2^\circ)$, which means the degree (chance) that h_1 be white is d_1° and the degree (chance) that h_2 be white is d_2° , whence:

$$F(\text{white}) = h_1(d_1^\circ) \mathbb{A} h_2(d_2^\circ) = \{h_1, h_2\}(d_1^\circ \wedge d_2^\circ)$$

As such, the degree of both houses $\{h_1, h_2\} = \{h_1 \text{ and } h_2\}$ be white is $d_1^\circ \wedge d_2^\circ$.

ii. Similarly, $F(\text{white}) = h_1(d_1^\circ) \mathbb{V} h_2(d_2^\circ) = \{h_1 \text{ or } h_2\}(d_1^\circ \vee d_2^\circ)$,

or the degree of at least one house $\{h_1 \text{ or } h_2\}$ be white is $(d_1^\circ \vee d_2^\circ)$.

iii. $F(\text{white}) = h_1(d_1^\circ) \mathbb{V}_E h_2(d_2^\circ) =$

$$= \{h_1 \text{ and (no } h_2)\}, \text{ or } \{(no \ h_1) \text{ and } h_2\}, \text{ and } \{(no \ h_1) \text{ and (no } h_2)\}$$

$$= (\text{either } h_1 \text{ is white, or } h_2 \text{ is white, and [no both } \{h_1, h_2\} \text{ are white simultaneously]})$$

has the degree of $(d_1^\circ \vee d_2^\circ) - (d_1^\circ \wedge d_2^\circ)$.

iv. $F(\text{white}) = (\neg h_1)(d_1^\circ)$, which means that the degree (chance) for h_1 not to be white is d_1° .

$$\begin{aligned} (\neg h_1 = \text{NOT}(h_1) = \text{either } h_2, \text{ or } h_3, \text{ or } h_4, \\ \text{or } \{h_2, h_3\}, \{h_2, h_4\}, \{h_3, h_4\}, \\ \text{or } \{h_2, h_3, h_4\}, \\ \text{or } \phi \text{ (no house)}). \end{aligned}$$

There are 8 alternatives, thus $\text{NOT}(h_1)$ is one of them.

Let's assume that $\text{NOT}(h_1) = \{h_3, h_4\}$. Then the degree of both houses $\{h_3, h_4\}$ be white is $\neg d_1^\circ$.

27. Definition of IndetermHyperSoft Set

Let U be a universe of discourse, H a non-empty subset of U , and $H(\mathbb{A}, \mathbb{V}, \mathbb{V}_E, \Rightarrow)$ the IndetermSoft Algebra generated by closing the set H under the operators $\mathbb{A}, \mathbb{V}, \mathbb{V}_E$, and \Rightarrow .

Let a_1, a_2, \dots, a_n , where $n \geq 1$, be n distinct attributes, whose corresponding attribute values are respectively the sets A_1, A_2, \dots, A_n , with $A_i \cap A_j = \emptyset$ for $i \neq j$, and $i, j \in \{1, 2, \dots, n\}$. Then the pair $(F, A_1 \times A_2 \times \dots \times A_n)$, where $A_1 \times A_2 \times \dots \times A_n$ represents a Cartesian product, with

$$F: A_1 \times A_2 \times \dots \times A_n \rightarrow H(\mathbb{A}, \mathbb{V}, \mathbb{V}_E, \Rightarrow),$$

is called an IndetermHyperSoft Set. Similarly, one may associate fuzzy / intuitionistic fuzzy / neutrosophic etc. degrees and extend the IndetermHyperSoft Set to some Fuzzy / Intuitionistic Fuzzy / Neutrosophic etc. IndetermHyperSoft Set.

28. Applications of the IndetermHyperSoft Set

Let's again $H = \{h_1, h_2, h_3, h_4\}$ be a set of four houses, and the attribute $c = \text{color}$, whose values are $C = \{\text{white, green, blue, red}\}$, and another attribute $p = \text{price}$, whose values are $P = \{\text{cheap, expensive}\}$.

The function

$$F: C \times P \rightarrow \mathcal{P}(H)$$

where $\mathcal{P}(H)$ is the powerset of H , is a HyperSoft Set.

$$F: C \times P \rightarrow H(\mathbb{A}, \mathbb{V}, \mathbb{V}_E, \Rightarrow),$$

is called an IndetermHyperSoft Set.

Examples:
 $F(\text{white, cheap}) = h_2 \mathbb{V} h_4$

$$F(\text{green, expensive}) = h_1 \mathbb{V}_E h_2$$

$$F(\text{red, expensive}) = \Rightarrow h_3$$

For a Neutrosophic IndetermHyperSoft Set one has neutrosophic degrees, for example:

$$F(\text{white, cheap}) = h_2(0.4, 0.2, 0.3) \vee h_4(0.5, 0.1, 0.4)$$

In the same way as above (Section 26.1), one extends the HyperSoft operators $\mathbb{A}, \mathbb{V}, \mathbb{V}_E, \mathbb{I}$ by assigning some degree $d^0(.) \in [0, 1]^p$, where: $p = 1$ for classical and fuzzy degree, $p = 2$ for intuitionistic fuzzy degree, $p = 3$ for neutrosophic degree, and so on $p = n$ for n -valued refined neutrosophic degree, to the elements involved in the operators, where \wedge, \vee, \neg represent the conjunction, disjunction, and negation respectively of these degrees in their corresponding fuzzy-extension sets or logics.

29. Definition of Neutrosophic Triplet Commutative Group

Let \mathcal{U} be a universe of discourse, and $(H, *)$ a non-empty set included in \mathcal{U} , where $*$ is a binary operation (law) on H .

(i) The operation $*$ on H is well-defined, associative, and commutative.

(ii) For each element $x \in H$ there exist an element $y \in H$, called the neutral of x , such that y is different from the unit element (if any), with $x * y = y * x = x$, and there exist an element

$z \in H$, called the inverse of x , such that $x * z = z * x = y$, then $\langle x, y, z \rangle$ is called a neutrosophic triplet.

Then $(H, *)$ is Neutrosophic Triplet Commutative Group.

In general, a Neutrosophic Triplet Algebra is different from a Classical Algebra.

29.1. Theorem 3

The joinAND Algebra (H, \mathbb{A}) and the disjoinOR Algebra (H, \mathbb{V}) are Neutrosophic Triplet Commutative Groups.

Proof

We have previously proved that the operators \mathbb{A} and \mathbb{V} are each of them: well-defined, associative, and commutative.

We also proved that the two operators are idempotent:

$$\forall x \in H, x \mathbb{A} x = x \text{ and } x \mathbb{V} x = x.$$

Therefore, for (H, \mathbb{A}) and respectively (H, \mathbb{V}) one has neutrosophic triplets of the form: $\langle x, x, x \rangle$.

30. Enriching the IndetermSoft Set and IndetermHyperSoft Set

The readers are invited to extend this research, since more determinate and indeterminate soft operators may be added to the IndetermSoft Algebra or IndetermHyperSoft Algebra, resulted from, or needed to, various real applications - as such one gets stronger soft and hypersoft structures.

A few suggestions:

$F(\text{white}) = \text{at least } k \text{ houses};$

or $F(\text{white}) = \text{at most } k \text{ houses};$

or $F(\text{green, small}) = \text{between } k_1 \text{ and } k_2 \text{ houses};$

where k, k_1 and k_2 are positive integers, with $k_1 \leq k_2$.

Etc.

31. Conclusions

The indeterminate soft operators, presented in this paper, have resulted from our real-world applications. An algebra closed under such operators was called an indeterminate soft algebra.

IndetermSoft Set and IndetermHyperSoft Set, and their corresponding Fuzzy / Intuitionistic Fuzzy / Neutrosophic forms, constructed on this indeterminate algebra, are introduced for the first time as extensions of the classical Soft Set and HyperSoft Set.

Many applications and examples are showed up.

References

1. Molodtsov, D. (1999) Soft Set Theory First Results. *Computer Math. Applic.* 37, 19-31.
2. Maji, P. K. (2013) Neutrosophic Soft Set. *Annals of Fuzzy Mathematics and Informatics* 5 (1), 157-168.
3. Smarandache, F. (2018) Extension of Soft Set to Hypersoft Set, and then to Plithogenic Hypersoft Set, *Neutrosophic Sets and Systems* 22, 168-170.
DOI: 10.5281/zenodo.2159754, <http://fs.unm.edu/NSS/ExtensionOfSoftSetToHypersoftSet.pdf>
4. Smarandache, F. (2019) Extension of Soft Set to Hypersoft Set, and then to Plithogenic Hypersoft Set (revisited). *Octagon Mathematical Magazine*, 27(1), 413-418.
5. Shazia Rana; Madiha Qayyum; Muhammad Saeed; Florentin Smarandache; Bakhtawar Ali Khan (2019). Plithogenic Fuzzy Whole Hypersoft Set, Construction of Operators and their Application in Frequency Matrix Multi Attribute Decision Making Technique. *Neutrosophic Sets and Systems* 28, <http://fs.unm.edu/neut/PlithogenicFuzzyWholeHypersoftSet.pdf>
6. Nivetha Martin, Florentin Smarandache (2020). Introduction to Combined Plithogenic Hypersoft Sets. *Neutrosophic Sets and Systems* 35, 8 p.
<http://fs.unm.edu/neut/IntroductionToCombinedPlithogenic.pdf>
7. Mujahid Abbas; Ghulam Murtaza, Florentin Smarandache (2020). Basic operations on hypersoft sets and hypersoft point. *Neutrosophic Sets and Systems*, 35, 2020, 15 p.
<http://fs.unm.edu/neut/BasicOperationsOnHypersoft.pdf>
8. Muhammad Ihsan; Muhammad Saeed; Atiqe Ur Rahman; Florentin Smarandache (2022). An Inclusive Study on Fundamentals of Hypersoft Expert Set with Application, *Punjab University Journal of Mathematics* 54(5), 315-332, <https://doi.org/10.52280/pujm.2022.540503>
9. Muhammad Saqlain; Muhammad Riaz; Muhammad Adeel Saleem; Miin-Shen Yang. Distance and Similarity Measures for Neutrosophic HyperSoft Set (NHSS) with Construction of NHSS-TOPSIS and Applications. *IEEE Access*, 14;
DOI: 10.1109/ACCESS.2021.3059712, <http://fs.unm.edu/neut/DistanceAndSimilarityNHSSTOPIS.pdf>
10. Smarandache, F. (2015). Neutrosophic Function, 14-15, in *Neutrosophic Precalculus and Neutrosophic Calculus*, EuropaNova, Brussels, <http://fs.unm.edu/NeutrosophicPrecalculusCalculus.pdf>
11. Smarandache, F. (2014). Neutrosophic Function, in *Introduction to Neutrosophic Statistics*, Sitech & Education Publishing, 74-75; <http://fs.unm.edu/NeutrosophicStatistics.pdf>.
12. Smarandache, F. (2019). Introduction to NeutroAlgebraic Structures and AntiAlgebraic Structures [<http://fs.unm.edu/NA/NeutroAlgebraicStructures-chapter.pdf>], in *Advances of Standard and Nonstandard Neutrosophic Theories*, Pons Publishing House, Brussels, Belgium, Chapter 6, 240-265;
<http://fs.unm.edu/AdvancesOfStandardAndNonstandard.pdf>
<http://fs.unm.edu/NA/NeutroAlgebra.htm>
13. Smarandache, F. (2020). NeutroAlgebra is a Generalization of Partial Algebra. *International Journal of Neutrosophic Science* 2, 8-17; DOI: <http://doi.org/10.5281/zenodo.3989285>
<http://fs.unm.edu/NeutroAlgebra.pdf>
14. Smarandache, F.; Al-Tahan, Madeline (eds.) (2022). Theory and Applications of NeutroAlgebras as Generalizations of Classical Algebras. IGI Global, USA, 333 p.; <https://www.igi-global.com/book/theory-applications-neutroalgebras-generalizations-classical/284563>

Introducción a los conjuntos IndetermSoft e IndetermHyperSoft

Florentin Smarandache

Florentin Smarandache (2022). Introducción a los conjuntos IndetermSoft e IndetermHyperSoft Sets. *Neutrosophic Computing and Machine Learning* 22, 1-22

Resumen: En este artículo se presenta por primera vez el *Conjunto IndetermSoft*, como extensión del Soft Set clásico (determinado), que opera con datos indeterminados, y de manera similar el Conjunto HyperSoft extendido al *Conjunto IndetermHyperSoft*, donde 'Indeterm' significa 'Indeterminado' (resultado incierto, conflictivo, no único). Estos son construidos sobre un *Álgebra IndetermSoft* que es un álgebra que trata con *Operadores IndetermSoft* resultantes de nuestro mundo real. Posteriormente, se presentan los Conjuntos IndetermSoft e IndetermHyperSoft y sus extensiones Difusa/Intuicionista Difusa/Neutrosófica y otras extensiones difusas así como sus aplicaciones.

Palabras clave: Soft Set; conjunto HyperSoft; Conjunto IndetermSoft; Conjunto IndetermHyperSoft; Operadores IndetermSoft; Álgebra IndetermSoft.

Abstract: This paper presents for the first time the IndetermSoft Set, as an extension of the classical (determinate) Soft Set, which operates on indeterminate data, and similarly the HyperSoft Set extended to the IndetermHyperSoft Set, where 'Indeterm' means 'Indeterminate' (uncertain, conflicting, non-unique result). They are built on an IndetermSoft Algebra which is an algebra dealing with IndetermSoft Operators resulting from our real world. Subsequently, the IndetermSoft and IndetermHyperSoft Sets and their Fuzzy/Fuzzy Intuitionistic/Neutrosophic and other fuzzy extensions and their applications are presented.

Keywords: Soft Set; HyperSoft set; IndetermSoft set; IndetermHyperSoft set; IndetermSoft operators; IndetermSoft algebra.

1. Introducción

El Soft Set clásico se basa en una función determinada (cuyos valores son ciertos y únicos), pero en nuestro mundo hay muchas fuentes que, por falta de información o ignorancia, proporcionan información indeterminada (incierto y no única, sino vacilante o alternativa).

Pueden ser modelados por operadores que tengan cierto grado de indeterminación debido a la imprecisión de nuestro mundo.

El artículo menciona las definiciones de los Conjuntos Soft e HyperSoft clásicos, luego muestra la distinción entre funciones suaves determinadas e indeterminadas.

Las tripletas neutrosóficas Función, NeutroFunción, AntiFunción y Operador, NeutroOperador, AntiOperador se discuten como partes del Álgebra, Neutro Álgebra, Anti Álgebra (Smarandache, 2019).

De manera similar, se toman en consideración las distinciones entre operadores determinados e indeterminados.

Posteriormente, se construye un Álgebra IndetermSoft, utilizando un operador suave determinado (joinAND), y tres operadores suaves indeterminados (disjoinOR, exclusiveOR, NOT), cuyas propiedades se estudian más adelante.

Las Álgebras IndetermSoft e IndetermHyperSoft son subclases del Indeterm Álgebra.

El Indeterm Álgebra se presenta como un Álgebra cuyo espacio u operadores tienen algún grado de indeterminación ($I \neq 0$), y es una subclase de Neutro Álgebra.

Se demostró que el Álgebra IndetermSoft y el Álgebra IndetermHyperSoft son Álgebras no Booleanas, ya que muchas Leyes Booleanas no se cumplen.

2. Definición de Soft Set Clásico

Sea U un universo de discurso, H un subconjunto no vacío de U , con $P(H)$ el conjunto potencia de H , y a un atributo, con su conjunto de valores de atributos denotados por A . Entonces el par (F, H) , donde $F: A \rightarrow P(H)$, se llama Soft Set clásico sobre H .

Molodtsov [1] definió el Soft Set en 1999, y Maji [2] el Soft Set Neutrosófico en 2013.

3. Definición de la Función Suave Determinada (Clásica)

La función anterior $F: A \rightarrow P(H)$, donde para cada $x \in A$, $f(x) \in P(H)$, y $f(x)$ es cierta y única, se llama Función Determinada (Clásica).

4. Definición de la Función IndetermSoft

Se presenta por primera vez. Sea U un universo de discurso, H un subconjunto no vacío de U y $P(H)$ el conjunto potencia de H . Sea a un atributo, y sea A un conjunto de valores de este atributo.

Una función $F: A \rightarrow P(H)$ se llama *Función IndetermSoft* si:

- i. el conjunto A tiene alguna indeterminación;
- ii. o $P(H)$ tiene alguna indeterminación;
- iii. o existe al menos un valor de atributo $v \in A$, tal que $F(v)$ indeterminado (poco claro, incierto o no único);
- iv. o cualquiera de las dos o las tres situaciones anteriores.

La Función IndetermSoft tiene cierto grado de indeterminación, y como tal es un caso particular de la NeutroFunción [6, 7], definida en 2014 – 2015, que se recuerda a continuación.

5. <Función, NeutroFunción, AntiFunción>

Se ha formado la tripleta neutrosófica anterior [10, 11].

- i. **Función (clásica)**, que es una función bien definida (definida internamente) para todos los elementos en su dominio de definición, o $(T, I, F) = (1, 0, 0)$.
- ii. **NeutroFunción** (o función neutrosófica), que es una función parcialmente bien definida (grado de verdad T), parcialmente indeterminada (grado de indeterminación I) y parcialmente definida externamente (grado de falsedad F) en su dominio de definición, donde $(T, I, F) \notin \{(1, 0, 0), (0, 0, 1)\}$.

- iii. **Antifunci n**, que es una funci3n definida externamente para todos los elementos en su dominio de definici3n, o (T, I, F) (0, 0, 1).

6. Aplicaciones del Soft Set

Un detective debe encontrar a los criminales entre una multitud de sospechosos. Para ello utiliza los testimonios de varios testigos.

Sea $S = \{s_1, s_2, s_3, s_4, s_5\} \cup \{\emptyset\}$ el conjunto de la multitud de sospechosos, d3nde $\{\emptyset\}$ es el elemento vaci3o (nulo), y c el atributo criminal, que tiene dos valores de atributo $C = \{\text{s3, no}\}$.

- i. La funci3n $F_1 : C \rightarrow P(S)$, d3nde $P(S)$ es el conjunto potencia de S , representa la informaci3n proporcionada por el testigo W_1 .

Por ejemplo,

$F_1(\text{s3}) = s_3$, lo que significa que, seg3n el testigo W_1 , el sospechoso s_3 es el criminal,

y $F_1(\text{no}) = s_4$, lo que significa igualmente, seg3n el testigo W_1 , que el sospechoso s_4 no es el criminal.

Estas son informaci3nes determinadas (exactas), provistas por el testigo W_1 , por lo que se trata de un Soft Set cl3sico.

- ii. M3s adelante, la funci3n $F_2 : C \rightarrow P(S)$, d3nde $P(S)$ es el conjunto potencia de S , representa la informaci3n proporcionada por el testigo W_2 .

Por ejemplo,

$F_2(\text{s3}) = \{\emptyset\}$, el elemento nulo, lo que significa que, seg3n el testigo W_2 , ninguno de los sospechosos del conjunto S es el criminal. Esta es tambi3n una informaci3n determinada como en el Soft Set cl3sico.

. Operador indeterminado como extensi3n del Soft Set

- iii. Nuevamente, la funci3n $F_3 : C \rightarrow P(S)$, d3nde $P(S)$ es el conjunto potencia de S , representa la informaci3n proporcionada por el testigo W_3 .

Este testigo no puede proporcionar una informaci3n cierta y3nica, sino una informaci3n indeterminada (incierto, no3nica sino alternativa).

Por ejemplo:

$$F_3(\text{s3}) = NOT(s_2)$$

$$\text{y } F_3(\text{no}) = s_3 \text{ OR } s_4$$

La tercera fuente (W_3) proporciona informaci3n indeterminada (poco clara, no3nica), dado que $NOT(s_2)$ significa que s_2 no es el criminal, entonces, en consecuencia: uno, dos o m3s sospechosos del conjunto restante de sospechosos $\{s_1, s_3, s_4, s_5\}$ pueden ser el (los) criminal(es), o $\{\emptyset\}$ (ninguno de los sospechosos restantes es el criminal), de donde se tiene:

$C_4^1 + C_4^2 + C_4^3 + C_4^4 + 1 = 2^4 = 16$ posibilidades (alternativas o resultados), resultantes de una sola entrada, para elegir, donde C_n^m significa combinaciones de n elementos tomados en grupos de m elementos, para n m3ros enteros $0 \leq m \leq n$.

Informaci3n indeterminada de nuevo, ya que:

$s_3 \text{ OR } s_4$ significa: $\{s_3 \text{ s3, y } s_4 \text{ no}\}$, o $\{s_3 \text{ no, y } s_4 \text{ s3}\}$, o $\{s_3 \text{ s3, y } s_4 \text{ s3}\}$,

por lo tanto, 3 posibles resultados (alternativos) de donde elegir.

De este modo, $F_3 : C \rightarrow P(S)$ es una funci3n suave indeterminada (o renombrada/contratada como funci3n suave indeterminada).

8. Extensión de valor de atributo indeterminado del Soft Set

Para extender las aplicaciones anteriores del Soft Set, siendo la multitud de sospechosos el conjunto $S = \{s_1, s_2, s_3, s_4, s_5\} \cup \{\emptyset\}$, donde $\{\emptyset\}$ es el elemento vacío (nulo), y el atributo $c = \text{criminal}$, pero el atributo c tiene esta vez

tres valores de atributo $K = \{\text{sí}, \text{no}, \text{tal vez}\}$, como en la nueva rama de la filosofía, llamada Neutrosofía, donde entre los opuestos $\langle A \rangle = \text{sí}$, y $\langle \text{anti}A \rangle = \text{no}$, existe la indeterminación (o neutral) $\langle \text{neut}A \rangle = \text{tal vez}$.

Y esto lo proporciona el testigo W_4 y se define como:

$$F_4 : K \rightarrow P(S)$$

Por ejemplo: $F_4(\text{tal vez}) = s_5$, lo que significa que el criminal es tal vez s_5 .

También hay cierta indeterminación aquí porque el valor del atributo tal vez significa algo inseguro o incierto.

Se puede transformar este en un Soft Set Difuso (o Intuicionista Difuso, o Neutrosófico, u otra extensión Difusa) de las siguientes maneras:

$$F_4(\text{quizás}) = s_5 \text{ es aproximadamente equivalente a } F_4(\text{sí}) = s_5 \text{ (algún grado de pertenencia)}$$

o

$$F_4(\text{quizás}) = s_5 \text{ es aproximadamente equivalente a } F_4(\text{no}) = s_5 \text{ (algún grado de no pertenencia)}$$

Considerando el siguiente ejemplo.

El *Soft Set Difuso* como:

$F_4(\text{quizás}) = s_5$ es aproximadamente equivalente a $F_4(\text{sí}) = s_5(0,6)$, o la probabilidad de que s_5 sea un criminal es del 60 % ;

El *Soft Set Intuicionista Difuso* como:

$F_4(\text{quizás}) = s_5$ es aproximadamente equivalente a $F_4(\text{sí}) = s_5(0,6, 0,3)$, o la probabilidad de que s_5 sea un criminal es del 60 %, y la probabilidad de que s_5 no sea un criminal es del 30 % ;

El *Soft Set Neutrosófico* como:

$F_4(\text{quizás}) = s_5$ es aproximadamente equivalente a $F_4(\text{sí}) = s_5(0.6, 0.2, 0.3)$, o la posibilidad de que s_5 sea un criminal es del 60 %, la posibilidad indeterminada de que no sea un criminal es del 20 % y la posibilidad de que s_5 no sea un criminal es 30 % .

Y de manera similar para otros *Soft Sets de Extensión Difusa*.

O, de manera equivalente, empleando el valor de atributo “no”, se puede considerar:

El *Soft Set Difuso* como:

$F_4(\text{quizás}) = s_5$ es aproximadamente equivalente a $F_4(\text{no}) = s_5(0.4)$, o la probabilidad de que s_5 no sea un criminal es del 40 % ;

El *Soft Set Intuicionista Difuso* como:

$F_4(\text{quizás}) = s_5$ es aproximadamente equivalente a $F_4(\text{no}) = s_5(0.3, 0.6)$, o la probabilidad de que s_5 no sea un criminal es del 30 %, y la probabilidad de que s_5 sea un criminal es del 60 % ;

El *Soft Set Neutrosófico* como:

$F_4(\text{quizás}) = s_5$ es aproximadamente equivalente a $F_4(\text{no}) = s_5(0.3, 0.2, 0.6)$, o la probabilidad de que s_5 no sea un criminal es del 30 %, la probabilidad indeterminada de criminal-no criminal es del 20 % y la probabilidad de que s_5 sea un criminal es 60 % .

Y de manera similar para otros *Soft Sets de Extensión Difusa*.

9. Conjunto HyperSoft

Smarandache extendió en 2018 el Soft Set al Conjunto HyperSoft [3, 4] transformando la función F de una función uni-atributo en una función multi-atributo.

9.1. Definición de Conjunto HyperSoft

Sea \mathcal{U} un universo de discurso, H un conjunto no vacío incluido en U , y $P(H)$ el conjunto potencia de H . Sea a_1, a_2, \dots, a_n , donde $n \geq 1$, n atributos distintos, cuyos valores de atributo correspondientes sean respectivamente los conjuntos A_1, A_2, \dots, A_n , con $A_i \cap A_j = \emptyset$ para $i \neq j$ y $i, j \in \{1, 2, \dots, n\}$. Entonces el par $(F, A_1 \times A_2 \times \dots \times A_n)$, donde $A_1 \times A_2 \times \dots \times A_n$ representa un producto Cartesiano, con

$$F: A_1 \times A_2 \times \dots \times A_n \rightarrow P(H)$$

se llama Conjunto HyperSoft.

Por ejemplo,

sea

$$(e_1, e_2, \dots, e_n) \in A_1 \times A_2 \times \dots \times A_n$$

entonces

$$F(e_1, e_2, \dots, e_n) = G \in P(H)$$

9.2. Clasificación de conjuntos HyperSoft

Con respecto a los tipos de conjuntos, tales como: el sico, difuso, intuicionista difuso, neutrosófico, plitog nico y todos los demás conjuntos de extensión difusa, se tienen respectivamente: Conjunto HyperSoft Cl sico, Conjunto HyperSoft Difuso, Conjunto HyperSoft Intuicionista Difuso, Conjunto HyperSoft Neutrosófico, Conjunto HyperSoft plitog nico y todos los demás conjuntos HyperSoft de extensión difusa [3, 5-9].

Los grados HyperSoft de T verdad, I indeterminación, F falsedad, H indecisión, N neutralidad, etc. asignados a estos Conjuntos HyperSoft Cl sicos, Conjuntos HyperSoft Difusos, Conjuntos HyperSoft Intuicionista Difusos, Conjuntos HyperSoft Neutrosóficos, Conjuntos HyperSoft Plitog nicos y todos los demás conjuntos HyperSoft de extensión difusa verifican las mismas condiciones de inclusión y desigualdades que en sus correspondientes conjuntos difusos y de extensión difusa.

9.3. Aplicaciones de Conjunto HyperSoft y su correspondiente Conjunto HyperSoft Difuso / Intuicionista Difuso / Neutrosófico.

Sea $H = \{h_1, h_2, h_3, h_4\}$ un conjunto de cuatro casas y dos atributos:

$s = \text{tamaño}$, cuyos valores de atributo son $S = \{\text{pequeña, mediana, grande}\}$,

y $l = \text{ubicación}$, cuyos valores de atributo son $L = \{\text{central, periférica}\}$.

Entonces $F: S \times L \rightarrow P(H)$ es un Conjunto HyperSoft.

- i. Por ejemplo, $F(\text{pequeña, periférica}) = \{h_2, h_3\}$, lo que significa que las casas que son *pequeñas* y *periféricas* son h_2 y h_3 .
- ii. Un Conjunto HyperSoft Difuso puede asignar algunos grados difusos, por ejemplo:
 $F(\text{pequeña, periférica}) = \{h_2(0.7), h_3(0.2)\}$, lo que significa que con respecto a los valores de los atributos *pequeña* y *periférica* en conjunto, h_2 cumple con los requisitos de ser tanto *pequeña* como *periférica* en un grado difuso del 70%, mientras que h_3 en un grado difuso del 20%.
- iii. Subsecuentemente, un Conjunto HyperSoft Intuicionista Difuso puede asignar algunos grados intuicionistas difusos, por ejemplo:
 $F(\text{pequeña, periférica}) = \{h_2(0.7, 0.1), h_3(0.2, 0.6)\}$, lo que significa que con respecto a los valores de los atributos *pequeña* y *periférica* en conjunto, h_2 cumple con los requisitos de ser tanto *pequeña* como *periférica* en un grado difuso intuicionista del 70%, y no lo cumple en un grado difuso intuicionista del 10%; y de manera similar para h_3 .
- iv. Asimismo, un Conjunto HyperSoft Neutrosófico puede asignar algunos grados neutrosóficos, por ejemplo:

$F(\text{pequeña, periférica}) = \{h_2(0.7, 0.5, 0.1), h_3(0.2, 0.3, 0.6)\}$, lo que significa que con respecto a los valores de los atributos *pequeña* y *periférica* en conjunto, h_2 cumple con los requisitos de ser pequeña y periférica en un grado neutrosófico del 70, el requisito indeterminado en un grado neutrosófico del 50, y no cumple el requerimiento en un grado neutrosófico del 10. Y de manera similar, para h_3 .

v. Del mismo modo para otros Conjuntos HyperSoft de extensión difusa.

10. Operador, NeutroOperador, AntiOperador

Sea U un universo de discurso y H un subconjunto no vacío de U .

Sea $n \geq 1$ un número entero, y ω un operador definido como:

$$\omega : H^n \rightarrow H$$

Tomando una n -tupla aleatoria $(x_1, x_2, \dots, x_n) \in H^n$.

Hay tres casos posibles:

- i. $\omega(x_1, x_2, \dots, x_n) \in H$ y $\omega(x_1, x_2, \dots, x_n)$ es una salida determinada (clara, cierta, nica); esto se llama grado bien definido (definido internamente), o grado de Verdad (T).
- ii. $\omega(x_1, x_2, \dots, x_n)$ es una salida indeterminada (poco clara, incierta, indefinida, no nica); esto se llama grado de Indeterminación (I).
- iii. $\omega(x_1, x_2, \dots, x_n) \in U - H$; esto se denomina grado de definición externa (ya que la salida está fuera de H), o grado de falsedad (F).

En consecuencia, se tiene una Triplete Neutrosófica de la forma

$$\langle \text{Operador, NeutroOperador, AntiOperador} \rangle$$

definida como sigue [12, 13, 14]:

10.1. Operador (clásico)

Para cualquier n -tupla $(x_1, x_2, \dots, x_n) \in H^n$, se tiene que $\omega(x_1, x_2, \dots, x_n) \in H$ y $\omega(x_1, x_2, \dots, x_n)$ es una salida determinada (clara, cierta, nica). Por lo tanto $(T, I, F) = (1, 0, 0)$.

10.2. NeutroOperador

Hay algunas n -tuplas $(x_1, x_2, \dots, x_n) \in H^n$ tales que $\omega(x_1, x_2, \dots, x_n) \in H$ y $\omega(x_1, x_2, \dots, x_n)$ son salidas determinadas (claras, ciertas, nicas) (grado de verdad T);

otras n -tuplas $(y_1, y_2, \dots, y_n) \in H^n$ tales que $\omega(y_1, y_2, \dots, y_n) \in H$ y $\omega(y_1, y_2, \dots, y_n)$ son salidas indeterminadas (poco claras, inciertas, no nicas) (grado de indeterminación I);

y otras n -tuplas $(z_1, z_2, \dots, z_n) \in H^n$ tales que $\omega(z_1, z_2, \dots, z_n) \in U - H$ (grado de falsedad F);

donde $(T, I, F) \neq \{(1, 0, 0), (0, 0, 1)\}$ que representan respectivamente el primer (Operador Clásico) y el tercer caso (AntiOperador).

10.3. AntiOperador

Para cualquier n -tupla $(x_1, x_2, \dots, x_n) \in H^n$, se tiene $\omega(x_1, x_2, \dots, x_n) \in U - H$. Por lo tanto $(T, I, F) = (0, 0, 1)$.

11. Casos Particulares de Operadores

11.1. Operador determinado

Un *Operador Determinado* es un operador cuyo grado de indeterminación $I = 0$, mientras que el grado de verdad $T = 1$ y el grado de falsedad $F = 0$.

Por tanto, sólo el Operador Clásico es un Operador Determinado.

11.2. Indeterminado

Como subclase del NeutroOperador anterior, existe el Indeterminado (Operador indeterminado), que es un operador que tiene cierto grado de indeterminación ($I > 0$).

12. Aplicaciones de los Indeterminados a los Soft Sets

Sea H un conjunto de número finito de casas (o, en general, objetos, artículos, etc.):

$$H = \{h_1, h_2, \dots, h_n\} \cup \{\emptyset\}, 1 \leq n < \infty,$$

donde h_1 = casa1, h_2 = casa2, etc.

y \emptyset es el elemento vacío (o nulo) (ninguna casa).

13. Operadores Soft determinados e indeterminados

Se definen cuatro operadores Soft en H .

13.1. joinAND

joinAND, o juntos, denotado por \mathbb{A} , definido como:

$x \mathbb{A} y = x$ e y , o sumando x e y ; aquí la conjunción “and” tiene el sentido común del lenguaje natural.

$x \mathbb{A} y = \{x, y\}$ es un conjunto de dos objetos.

Por ejemplo:

$$h_1 \mathbb{A} h_2 = \text{casa1} \mathbb{A} \text{casa2} = \text{casa1 y casa2}$$

$$\text{juntar casa1 y casa2} = \{\text{casa1}, \text{casa2}\} = \{h_1, h_2\}.$$

joinAND es un Operador Soft Determinado ya que se obtiene una salida clara (cierta).

13.2. disjoinOR

disjoinOR, o separados en partes, denotado por \mathbb{V} , definido como:

$x \text{ disjoinOR } y = x \mathbb{V} y = \{x\}$, o $\{y\}$, o ambos $\{x, y\}$

x , o y , o ambos x e y ;

aquí, igualmente, la disyunción “or” (y la conjunción “and” también) tienen el sentido común del lenguaje natural.

Pero existe cierta indeterminación (incertidumbre) para elegir entre tres alternativas.

Por ejemplo:

$$h_1 \mathbb{V} h_2 = \text{casa1} \mathbb{V} \text{casa2} = \text{casa1, o casa2, o ambas casas juntas } \{\text{casa1 y casa2}\}.$$

disjoinOR es un Operador Indeterminado Soft, ya que no tiene una salida única clara, sino tres posibles salidas alternativas a elegir.

13.3. exclusiveOR

exclusiveOR, que significa uno u el otro; es un Operador Indeterminado Soft (a elegir entre dos alternativas).

$$h_1 \mathbb{V}_E h_2 \text{ ya sea } h_1 \text{ o } h_2, \text{ y no ambos } \{h_1, h_2\}.$$

1 . . NOT

NOT, o no, o subnegación/subcomplemento, indicado por \Rightarrow , donde

$NOT(h) \Rightarrow h = no\ h$, en otras palabras, todos los elementos de H , excepto h , ya sea elementos individuales, o dos elementos, o $n - 1$ elementos de $H - \{h\}$, o el elemento vacío \emptyset .

La negación del “no” tiene el sentido com n del lenguaje natural; cuando se dice “no Juan” eso significa “alguien m s” o “muchos otros”.

13.4.1. Teorema 1

Sea $|H - \{h\}| = m \geq 1$ el cardinal del conjunto $H - \{h\}$.

Entonces $NOT(h) = \{x, x \in P(H - \{h\})\}$ y el cardinal $NOT(h) = 2^{m-1}$.

Prueba:

Ya que $NOT(H)$ significa todos los elementos de H , excepto h ,

ya sea por elementos simples, o por dos elementos, o por $n - 1$ elementos de $H - \{h\}$, o el elemento vacío

\emptyset , entonces se obtiene:

$$C_{n-1}^1 + C_{n-1}^2 + \dots + C_{n-1}^{n-1} + 1 = (2^{n-1} - 1) + 1 = 2^{n-1} \text{ posibilidades (alternativas de } h).$$

El operador NOT tiene como salida una multitud de subnegaciones (o subcomplementos).

NOT también es un Operador IndetermSoft.

13.4.2. Ejemplo

Sea $H = \{x_1, x_2, x_3, x_4\}$

Entonces,

$NOT(x_1) \Rightarrow x_1 =$ ya sea x_2 , o x_3 , o x_4 ,

o $\{x_2, x_3\}$, o $\{x_2, x_4\}$, o $\{x_3, x_4\}$,

o $\{x_2, x_3, x_4\}$,

o \emptyset ;

por lo tanto $C_3^1 + C_3^2 + C_3^3 + 1 = 3 + 3 + 1 + 1 = 8 = 2^3$ posibilidades/alternativas.

Representaciones gráficas:

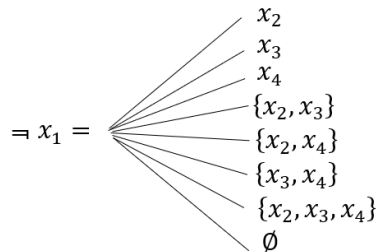

U otra representación (equivalente a la anterior) es la siguiente:

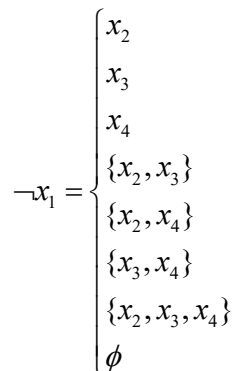

El operador NOT es equivalente a $(2^{n-1} - 1)$ disyunciones OR (del lenguaje natural).

1 . Similitudes entre Operadores Indeterminados y Operadores Clásicos

(i) joinAND es similar al operador AND lógico clásico (\wedge) de la siguiente manera.

Sean A, B, C proposiciones, donde $C = A \wedge B$.

Entonces la proposición C es verdadera, si ambos: $A =$ verdadero y $B =$ verdadero.

(ii) disjoinOR también es similar al operador lógico clásico OR (\vee) de la siguiente manera.

Sean A, B, D proposiciones, donde $D = A \vee B$.

Entonces la proposición D es verdadera si:

- ya sea A verdadero,
- o B verdadero,
- o ambos A verdadero y B verdadero

(por lo tanto, se tienen tres posibilidades).

(iii) exclusiveOR también es similar al operador OR exclusivo de lógica clásica (\vee_E) de la siguiente manera.

Sean A, B, D proposiciones, donde $D = A \vee_E B$

Entonces la proposición D es verdadera si:

- ya sea A verdadero,
- o B verdadero,
- y tanto A como B no son verdaderos simultáneamente

(por lo tanto, se tienen dos posibilidades).

(iv) NOT se parece al operador de conjunto clásico, o complemento (\neg), de la siguiente manera.

Sean A, B, C, D cuatro conjuntos, cuyas intersecciones de dos en dos son vacías, del universo del discurso $\mathcal{U} = A \cup B \cup C \cup D$.

Entonces $\neg A = \text{Not}A = \mathcal{U} \setminus A$ el complemento de A con respecto a \mathcal{U} .

Si bien tiene solo una salida exacta ($\mathcal{U} \setminus A$) en la teoría clásica de conjuntos, el operador NOT ($\neg A$) tiene 8 resultados posibles: el conjunto vacío (\emptyset), o B , o C , o D , o $\{B, C\}$, o $\{B, D\}$, o $\{C, D\}$, o $\{B, C, D\}$.

1 . Propiedades de los Operadores

Sea $x, y, z \in H(\wedge, \vee, \vee_E, \Rightarrow)$.

1 .1. Operadores bien definidos

Considerando el conjunto H cerrado bajo estos cuatro operadores: $H(\wedge, \vee, \vee_E, \Rightarrow)$.

Por lo tanto, para cualquier $x, y \in H$ se tiene:

$x \wedge y \in H(\wedge, \vee, \vee_E, \Rightarrow)$, ya que $\{x, y\} \in H(\wedge, \vee, \vee_E, \Rightarrow)$,

y $x \vee y \in H(\wedge, \vee, \vee_E, \Rightarrow)$, ya que cada $\{x\}, \{y\}, \{x, y\} \in H(\wedge, \vee, \vee_E, \Rightarrow)$,

además $x \vee_E y \in H(\wedge, \vee, \vee_E, \Rightarrow)$, ya que cada $\{x\}, \{y\} \in H(\wedge, \vee, \vee_E, \Rightarrow)$,

Entonces el operador NOT también está bien definido porque es equivalente a un múltiplo de los operadores disjoinOR.

De este modo:

$\wedge : H^2 \rightarrow H(\wedge, \vee, \vee_E, \Rightarrow)$

$\vee : H^2 \rightarrow H(\wedge, \vee, \vee_E, \Rightarrow)$

$\vee_E : H^2 \rightarrow H(\wedge, \vee, \vee_E, \Rightarrow)$

$\Rightarrow : H \rightarrow H(\wedge, \vee, \vee_E, \Rightarrow)$

1 . . Conmutatividad

$$x \wedge y = y \wedge x, y \vee x = x \vee y, y \vee x \vee y = y \vee x, y \vee x \vee y \vee x = y \vee x$$

Prueba

$$x \wedge y = \{x, y\} = \{y, x\} = y \wedge x$$

$$x \vee y = (\{x\}, o \{y\}, o \{x, y\}) = (\{y\} o \{x\}, o \{y, x\}) = y \vee x$$

$$x \vee y \vee x \text{ (ya sea } \{x\}, o \{y\}, \text{ pero no ambos } x \text{ e } y)$$

$$\text{(ya sea } \{y\}, o \{x\}, \text{ pero no ambos } y \text{ y } x) = y \vee x.$$

1 . . Asociatividad

$$x \wedge (y \wedge z) = (x \wedge y) \wedge z,$$

$$y \vee (x \vee z) = (y \vee x) \vee z, y \vee x \vee z = (y \vee x) \vee z = (x \vee y) \vee z$$

Prueba

$$\begin{aligned} x \wedge (y \wedge z) &= \{x, y \wedge z\} = \{x, \{y, z\}\} \\ &= \{x, y, z\} = \{\{x, y\}, z\} \\ &= (x \wedge y) \wedge z. \end{aligned}$$

$$x \vee (y \vee z) = (x \vee y) \vee z$$

$$\begin{aligned} x \vee (y \vee z) &= x \vee \left\{ \begin{matrix} y \\ z \\ y \vee z \end{matrix} \right\} = x \vee \left\{ \begin{matrix} y \\ z \\ \{y, z\} \end{matrix} \right\} \\ &= \left\{ \begin{matrix} x \\ y \\ \{x, y\} \end{matrix} \right\} \vee \left\{ \begin{matrix} z \\ \{x, z\} \end{matrix} \right\} \\ &= \left\{ \begin{matrix} x \\ y \\ \{x, y\} \\ z \\ \{x, z\} \\ \{x, y, z\} \end{matrix} \right\} \\ &= x, y, z, \{x, y\}, \{x, z\}, \{y, z\}, \{x, y, z\}. \end{aligned}$$

$$\begin{aligned} (x \vee y) \vee z &= \left\{ \begin{matrix} x \\ y \\ \{x, y\} \end{matrix} \right\} \vee \left\{ \begin{matrix} z \\ \{x, z\} \end{matrix} \right\} \\ &= \left\{ \begin{matrix} y \\ z \\ \{y, z\} \end{matrix} \right\} \vee \left\{ \begin{matrix} x \\ \{x, y\} \\ \{x, z\} \end{matrix} \right\} \\ &= \left\{ \begin{matrix} \{x, y\} \\ z \\ \{x, y, z\} \end{matrix} \right\} \\ &= x, y, z, \{x, y\}, \{x, z\}, \{y, z\}, \{x, y, z\}. \end{aligned}$$

Por lo tanto, $(x \vee y) \vee z = x \vee (y \vee z) = x, y, z, \{x, y\}, \{y, z\}, \{z, x\}, \{x, y, z\}$ con $2^3 - 1 = 8 - 1 = 7$ posibilidades.

$$x \vee (y \vee z)$$

$ya\ sea\ x,\ o\ (y\ \forall_E\ z),\ y\ no\ ambos\ x\ y\ (y\ \forall_E\ z) = ya\ sea\ x,\ o\ (y,\ o\ z,\ y\ no\ ambos\ y\ y\ z),\ y\ no\ ambos\ x\ y\ (no\ y\ o\ z) = ya\ sea\ x,\ o\ y,\ o\ z,\ y\ no\ ambos\ \{y,\ z\},\ y\ (no\ x\ y\ no\ (no\ y\ o\ z)) = ya\ sea\ x,\ o\ y,\ o\ z,\ y\ no\ \{y,\ z\},\ no\ \{x,\ y\},\ no\ \{x,\ z\} = (x\ \forall_E\ y)\ \forall_E\ z$

1 . . Distributividad de joinAND con respecto a disjoinOR y exclusiveOR

$$x \wedge (y \vee z) = (x \wedge y) \vee (x \wedge z)$$

Prueba

$$\begin{aligned} x \wedge (y \vee z) &= x\ y\ (y\ o\ z) = x\ y\ (y,\ or\ z,\ or\ \{y,\ z\}) \\ &= x\ e\ y,\ o\ x\ y\ z,\ o\ x\ y\ \{y,\ z\} \\ &= \{x,\ y\},\ o\ \{x,\ z\},\ o\ \{x,\ y,\ z\} \\ &= \{z,\ y\},\ \{x,\ z\},\ \{x,\ y,\ z\}. \\ (x \wedge y) \vee (x \wedge z) &= \{x,\ y\} \\ o\ \{x,\ z\} &= \{x,\ y\},\ \{x,\ z\},\ \{x,\ y,\ x,\ z\} = \{x,\ y\},\ \{x,\ z\},\ \{x,\ y,\ z\}. \end{aligned}$$

$$\begin{aligned} x \wedge (y\ \forall_E\ z) &= x\ y\ (ya\ sea\ y,\ o\ z,\ y\ no\ ambos\ \{y,\ z\}) = ya\ sea\ x\ e\ y,\ o\ x\ y\ z, \\ y\ x\ y\ no\ ambos\ \{y,\ z\} &= ya\ sea\ \{x,\ y\},\ o\ \{x,\ z\},\ y\ \{x,\ no\ \{y,\ z\}\} = \\ &= ya\ sea\ \{x,\ y\},\ o\ \{x,\ z\},\ y\ no\ \{x,\ y,\ z\} = (x \wedge y)\ \forall_E\ (x \wedge z) \end{aligned}$$

1 . . No distributividad de disjoinOR y exclusiveOR con respecto a joinAND

$$\begin{aligned} x \vee (y \wedge z) &\neq (x \vee y) \wedge (x \vee z) \\ x \vee (y \wedge z) &= x\ o\ (y\ y\ z) = x\ o\ \{y,\ z\} = x,\ \{y,\ z\},\ \{x,\ y,\ z\} \end{aligned}$$

Pero

$$\begin{aligned} (x \vee y) \wedge (x \vee z) &= (x,\ y,\ \{x,\ y\})\ y\ (x,\ z,\ \{x,\ z\}) \\ &= \{x,\ x\},\ \{x,\ z\},\ \{x,\ z\},\ \{y,\ z\},\ \{y,\ x\},\ \{x,\ y,\ z\},\ \{x,\ y\},\ \{x,\ y,\ z\},\ \{x,\ y,\ z\} \\ &= x,\ \{x,\ y\},\ \{x,\ z\},\ \{y,\ z\},\ \{x,\ y,\ z\}. \end{aligned}$$

De donde en general $x,\ \{y,\ z\},\ \{x,\ y,\ z\} \neq x,\ \{x,\ y\},\ \{x,\ z\},\ \{y,\ z\},\ \{x,\ y,\ z\}$.

Mientras que en el Algebra Booleana clasica la distribución de or con respecto a and es valida:

$$x \vee (y \wedge z) = (x \vee y) \wedge (x \vee z).$$

$$\begin{aligned} x\ \forall_E\ (y \wedge z) &= ya\ sea\ x,\ o\ \{y,\ z\},\ y\ no\ \{x,\ y,\ z\} \neq \\ &\neq (x\ \forall_E\ y) \wedge (x\ \forall_E\ z) = (ya\ sea\ x,\ o\ y,\ y\ no\ \{x,\ y\})\ y\ (no\ x,\ o\ z,\ y\ no\ \{x,\ z\}) \end{aligned}$$

1 . . Idempotencia

$$\begin{aligned} x \wedge x &= \{x,\ x\} = x \\ x \vee x &= ya\ sea\ x,\ o\ x,\ o\ \{x,\ x\} \\ &= x,\ o\ x,\ o\ x \\ &= x. \\ x\ \forall_E\ x &= ya\ sea\ x,\ o\ x,\ y\ no\ \{x,\ x\} \quad \text{imposible.} \end{aligned}$$

1 . .1. Teorema

Sea $x_1, x_2, \dots, x_n \in (H, \wedge, \vee, \Rightarrow)$, para $n \geq 2$. Entonces:

- (i) $x_1 \wedge x_2 \wedge \dots \wedge x_n = \{x_1, x_2, \dots, x_n\}$,
- y
- (ii) $x_1 \vee x_2 \vee \dots \vee x_n = x_1, x_2, \dots, x_n,$

$$\{x_1, x_2\}, \{x_1, x_3\}, \dots, \{x_{n-1}, x_n\},$$

$$\{x_1, x_2, x_3\},$$

$$\{x_1, x_2, \dots, x_{n-1}\},$$

$$\{x_1, x_2, \dots, x_{n-1}, x_n\}.$$

Existen: $C_n^1 + C_n^2 + \dots + C_n^{n-1} + C_n^n = 2^n - 1$ posibilidades/alternativas.

Cuanto mayor es n , mayor es la indeterminación.

$$((iii) x_1 \vee_E x_2 \vee_E \dots \vee_E x_n = x_1, x_2, \dots, x_n =$$

$$= \text{ya sea } x_1, \text{ o } x_2, \dots, \text{ o } x_n,$$

y no dos o más variables sean verdaderas simultáneamente.

Existen: $C_n^1 = n$ posibilidades.

Cuanto mayor sea n , mayor es la indeterminación por haber muchas alternativas.

Prueba

(i) La igualdad joinAND es obvia.

(ii) La disjoinOR resulta del hecho de que para que la disyunción de n proposiciones sea verdadera, basta con tener al menos una que sea verdadera. Como tal, se puede tener solo una proposición verdadera, o solo dos proposiciones verdaderas, y así sucesivamente, solo $n - 1$ proposiciones verdaderas, hasta todas las n proposiciones verdaderas.

(iii) Es obvio.

1 . . Ley clásica de Absorción Booleana 1

$x \wedge (x \vee y) = x$ no funciona en esta estructura, ya que $x \wedge (x \vee y) \neq x$.

Prueba

$$x \wedge (x \vee y) = x y (x \circ y)$$

$$x y \left\{ \begin{array}{l} x \\ y \\ \{x, y\} \end{array} \right.$$

$$\{x, x\} \circ \{x, y\} \circ \{x, x, y\}$$

$$x \circ \{x, y\} \circ \{x, y\}$$

$$x \circ \{x, y\}$$

$$\left\{ \begin{array}{l} x \\ \{x, y\} \\ \{x, x, y\} \end{array} \right. = \left\{ \begin{array}{l} x \\ \{x, y\} \\ \{x, y\} \end{array} \right. \quad \left\{ \begin{array}{l} x \\ \{x, y\} \end{array} \right. \neq x.$$

Pero esto sí funciona:

$$x \wedge (x \vee_E y) = x y \text{ (ya sea } x, \text{ o } y, \text{ y no } \{x, y\}) =$$

$$= (x y x), \text{ o } (x e y), \text{ y } (x y \text{ no } \{x, y\}) = x.$$

1 . . Ley clásica de Absorción Booleana

$x \vee (x \wedge y) = x$ no funciona en esta estructura, ya que $x \vee (x \wedge y) \neq x$.

Prueba

$$x \vee (x \wedge y) = x y (x \circ y)$$

$$x \text{ or } (x e y) = x \text{ or } \{x, y\}$$

$$\left\{ \begin{array}{l} x \\ \{x, y\} \\ \{x, x, y\} \end{array} \right. = \left\{ \begin{array}{l} x \\ \{x, y\} \\ \{x, y\} \end{array} \right.$$

$$\left\{ \begin{array}{l} x \\ \{x, y\} \end{array} \right. \neq x.$$

Pero esto sí es válido:

$$x \vee_E (x \wedge y) = (\text{ya sea } x), \text{ o } \{x, y\}, \text{ y } (\text{no } \{x, y\}) = x.$$

1 . . Aniquiladores e Identidades para el lgebra IndetermSoft

Mientras que 0 es un aniquilador para la conjunción \wedge en el lgebra Booleana cl sica, $x \wedge 0 = 0$, en el lgebra IndetermSoft \emptyset es una identidad para \mathbb{A} , mientras que para los dem s no funciona.

Prueba

$$x \mathbb{A} \emptyset = x \text{ y } \emptyset$$

x y nada

x junto con nada

x.

1 .1 . \emptyset no es una identidad, ni un aniquilador para disjointOR ni para exclusiveOR

Mientras que 0 es una identidad para el \vee en el lgebra booleana cl sica, $x \vee 0 = x$, en Indeterm lgebra, \emptyset no es ni una identidad ni un aniquilador.

Prueba

$$x \vee \emptyset = x, \text{ o (nada), o } \emptyset\{x, \emptyset\}$$

x, o \emptyset , or x

= x, o \emptyset .

x $\vee_E \emptyset$ ya sea x, o \emptyset , y no $\{x, \emptyset\}$.

1 .11. La negaci n de \emptyset tiene m ltiples soluciones

Mientras que en el lgebra booleana cl sica la negaci n de 0 es 1 (una sola soluci n), $\neg 0 = 1$, en IndetermAlgebra la negaci n de \emptyset tiene m ltiples soluciones.

Prueba

$$\Rightarrow \emptyset = NOT(\emptyset),$$

no nada

uno o m s elementos del conjunto sobre el que se define el operador \Rightarrow .

Ejemplo

$$\text{Sea } H = \{x_1, x_2, x_3\} \cup \emptyset.$$

Entonces, $\Rightarrow \emptyset = x_1, \text{ o } x_2, \text{ o } x_3, \text{ o } \{x_1, x_2\}, \text{ o } \{x_1, x_3\}, \text{ o } \{x_2, x_3\}, \text{ o } \{x_1, x_2, x_3\}$,

por lo tanto 7 soluciones alternativas.

1 .1 . La Doble Negaci n no es v lida en el Algebra IndetermSoft

Mientras que en el lgebra Booleana cl sica es v lida la Ley de la Doble Negaci n: $\neg(\neg x) = x$, en el Indeterm lgebra no ocurre as:

En general, $\Rightarrow (\Rightarrow x) \neq x$.

Prueba

Un contraejemplo:

$$\text{Sea } H = \{x_1, x_2, x_3\} \cup \emptyset.$$

$\Rightarrow x_1 =$ lo que no es x_1 o no contiene x_1

$x_2, x_3, \{x_2, x_3\}, \emptyset$.

As: se tienen 4 valores diferentes de la negaci n de x_1 .

Eligiendo $\Rightarrow x_1 = x_2$; entonces $\Rightarrow (\Rightarrow x_1) = x_2 = (x_1, x_3, \{x_1, x_3\}, \emptyset) \neq x_1$.

De manera similar para tomar otros valores de $\Rightarrow x_1$.

Sea $H = \{x_1, x_2, \dots, x_n\} \cup \emptyset, n \geq 2$. Sea $x \in H$.

Elementos m nimos y m ximos con respecto a la relaci n de inclusi n son:

$\emptyset =$ el elemento vac o (nulo) y respectivamente

notation

$$x_1 \wedge x_2 \wedge \dots \wedge x_n = \{x_1, x_2, \dots, x_n\} = H,$$

pero en el lgebra Booleana son 0 y 1 respectivamente.

1 .1 . Todo el conjunto H es un aniquilador para joinAND

Mientras que en el lgebra Booleana cl sica la identidad para \wedge es 1, ya que $x \wedge 1 = x$, en el lgebra IndetermSoft para \wedge hay un aniquilador H, ya que $x \wedge H = H$, dado que $x \wedge H = \{x_1, x_2, \dots, x_n, x\} = H$, porque $x \in H$ entonces x es uno de x_1, x_2, \dots, x_n .

1 . El m ximo (H) no es ni aniquilador ni identidad

Mientras que en el lgebra Booleana cl sica el aniquilador para \vee es 0, porque $x \vee 0 = x$, en el lgebra IndetermSoft para \vee el m ximo H no es ni aniquilador ni identidad,
 $x \vee H = x \circ H = x, H, \{x, H\} = x, H, H = x, H.$
 $x \vee_E H = \text{ya sea } x, \text{ o } H, \text{ y (no } x \text{ y no } H).$

1 . Complementaci n1

En el lgebra Booleana cl sica, Complementaci3n1 es: $x \wedge \neg x = 0$.
 En el lgebra IndetermSoft, $x \wedge (\neg x) \neq \emptyset$, y $x \wedge (\neg x) \neq H$.

Contraejemplo

$$\begin{aligned} MM &= \{x_1, x_2, x_3\} \cup \emptyset \\ \Rightarrow x_1 &= x_2, x_3, \{x_2, x_3\}, \emptyset \\ x_1 \wedge (\neg x_1) &= x_1 \wedge (x_2, x_3, \{x_2, x_3\}, \emptyset) = \\ &= (x_1 \vee x_2) \quad \circ (x_1 \circ x_3) \\ &\quad \circ (x_1 \vee \{x_2, x_3\}) \\ &\quad \circ (x_1 \vee \emptyset) \\ &= (x_1, \{x_1, x_2\}, \{x_1, x_3\}, \{x_1, x_2, x_3\}) \neq \emptyset \neq M. \end{aligned}$$

1 . Complementaci n

En el lgebra Booleana cl sica, Complementaci3n2 es: $x \vee \neg x = 1$.
 En el lgebra IndetermSoft, $x \vee \neg x \neq H$, y $x \vee \neg x \neq \emptyset$.

Contraejemplo

Lo anterior $H = \{x_1, x_2, x_3\} \cup \emptyset$
 y $\Rightarrow x_1 = x_2, x_3, \{x_2, x_3\}, \emptyset$ entonces

$$x_1 \vee \neg x_1 = x_1 \vee (x_2, x_3, \{x_2, x_3\}, \emptyset) = \begin{cases} x_1 \\ x_2, x_3, \{x_2, x_3\}, \emptyset \\ x_1, x_2, x_3, \{x_2, x_3\}, \emptyset \end{cases}$$

$$= x_1, \text{ or } (x_2, x_3, \{x_2, x_3\}, \emptyset), \text{ or } (x_1, x_2, x_3, \{x_2, x_3\}, \emptyset)$$

lo cual es diferente de H y de \emptyset .

Y:

$$x_1 \vee_E \neg x_1 = x_1 \vee_E (x_2, x_3, \{x_2, x_3\}, \emptyset) \left\{ \begin{matrix} x_1 \\ x_2, x_3, \{x_2, x_3\}, \emptyset \end{matrix} \right\} \text{ y no } (x_1, x_2, x_3, \{x_2, x_3\}, \emptyset),$$

lo cual es diferente de H y de \emptyset .

1 . Primera Ley de De Morgan en el lgebra IndetermSoft

La Primera Ley de De Morgan del lgebra booleana cl sica es:

$$\neg(x \vee y) = (\neg x) \wedge (\neg y)$$

eso tambi n es cierto en el lgebra IndetermSoft:

$$\Rightarrow (x \vee y) = (\Rightarrow x) \wedge (\Rightarrow y)$$

Prueba

$$\begin{aligned} \Rightarrow (x \vee y) &= \Rightarrow (x, o y, o \{x e y\}) \\ &= \Rightarrow x, y = y, y = \{x_1 e y\} \\ &= \Rightarrow x_1, y = y, y (\Rightarrow x, o \Rightarrow y) \\ &= \Rightarrow x, y = y \\ &= (\Rightarrow x) \wedge (\Rightarrow y). \end{aligned}$$

Ejemplo

$$M = \{x_1, x_2, x_3\} \cup \emptyset$$

$$\begin{aligned} \Rightarrow (x_1 \vee x_2) &= \Rightarrow (x_1, o x_2, o \{x_1 y x_2\}) \\ &= \Rightarrow x_1, y = x_2, y (\Rightarrow x_1 \text{ or } \Rightarrow x_2) \\ &= \Rightarrow x_1, y = x_2 \\ &= (\Rightarrow x_1) \wedge (\Rightarrow x_2). \end{aligned}$$

$$\Rightarrow x_1 = (x_2, x_3, \{x_2, x_3\}, \emptyset)$$

$$\Rightarrow x_2 = (x_1, x_3, \{x_1, x_3\}, \emptyset)$$

$$\begin{aligned} (\Rightarrow x_1) \wedge (\Rightarrow x_2) &= (x_2, x_3, \{x_2, x_3\}, \emptyset) \wedge (x_1, x_3, \{x_1, x_3\}, \emptyset) \\ &= x_1, x_2, x_3, \{x_1, x_3\}, \{x_2, x_3\}, \emptyset. \end{aligned}$$

. Segunda Ley de De Morgan en el lgebra IndetermSoft

La Segunda ley de De Morgan en el lgebra booleana cl sica es

$$\neg(x \wedge y) = (\neg x) \vee (\neg y)$$

tambi n es cierto en la nueva estructura llamada lgebra IndetermSoft:

$$\Rightarrow (x \wedge y) = (\Rightarrow x) \vee (\Rightarrow y)$$

Prueba

$$\Rightarrow (x \wedge y) = \Rightarrow (\{x e y\}) = \Rightarrow x, o \Rightarrow y, o \{\Rightarrow x, e \Rightarrow y\} = (\Rightarrow x) \vee (\Rightarrow y)$$

Ejemplo

$$\begin{aligned} \Rightarrow (x_1 \wedge x_2) &= \Rightarrow (\{x_1, x_2\}) \\ &= (\Rightarrow x_1, o \Rightarrow x_2, o (\Rightarrow x_1 y \Rightarrow x_2)) \\ &= (x_2, x_3, \{x_2, x_3\}, \emptyset) \\ &= o(x_2, x_3, \{x_2, x_3\}, \emptyset) \\ &= o(x_1, x_3, \{x_1, x_3\}, \emptyset) \\ &= o(x_1, x_2, x_3, \{x_1, x_3\}, \{x_2, x_3\}, \emptyset) = \\ &= (x_1, x_2, x_3, \{x_1, x_3\}, \{x_2, x_3\}, \emptyset) \\ (\Rightarrow x_1) \vee (\Rightarrow x_2) &= \Rightarrow x_1, o \Rightarrow x_2 o (\Rightarrow x_1 \wedge \Rightarrow x_2) = \\ &= (x_2, x_3, \{x_2, x_3\}, \emptyset) \\ &= o(x_1, x_3, \{x_1, x_3\}, \emptyset) \\ &= o(x_1, x_2, x_3, \{x_1, x_3\}, \{x_2, x_3\}, \emptyset) \\ &= (x_1, x_2, x_3, \{x_1, x_3\}, \{x_2, x_3\}, \emptyset) \\ &= \Rightarrow (x_1 \wedge x_2) \end{aligned}$$

Este lgebra IndetermSoft no es un lgebra Booleana porque muchas de las Leyes Booleanas no se cumplen, como por ejemplo:

- Identidad para \wedge
- Identidad para \vee
- Identidad para \vee_E
- Aniquilador para \wedge
- Aniquilador para \vee
- Aniquilador para \vee_E
- Absorción1 $[x \wedge (x \vee y) = x]$
- Absorción2 $[x \vee (x \wedge y) = x]$
- Doble negación
- Complementación1 $[x \wedge \Rightarrow x = \emptyset]$
- Complementación2 $\{ [x \vee \Rightarrow x = H] \text{ y } [x \vee_E \Rightarrow x = H] \}$

1. Aplicaciones prácticas del Soft Set e IndetermSoft Set

Sea $H = \{h_1, h_2, h_3, h_4\}$ un conjunto de cuatro casas, y el atributo $a = color$, cuyos valores son $A = \{blanco, verde, azul, rojo\}$.

1.1. Conjunto Soft

La función

$$F: A \rightarrow \mathcal{P}(H)$$

donde $\mathcal{P}(H)$ es el conjunto potencia de H , se llama Soft Set clásico.

Por ejemplo,

$F(\text{blanco}) = h_3$, es decir, la casa h_3 está pintada de blanco;

$F(\text{verde}) = \{h_1, h_2\}$, es decir, ambas casas h_1 y h_2 están pintadas de verde;

$F(\text{azul}) = h_4$, es decir, la casa h_4 está pintada de azul;

$F(\text{rojo}) = \emptyset$, es decir, ninguna casa está pintada de rojo.

Por lo tanto, la información sobre los colores de las casas es conocida, cierta.

1.2. Conjunto IndetermSoft

Pero hay muchos casos en nuestra vida real cuando la información sobre los valores de los atributos de los objetos (o artículos, en general) es poco clara, incierta.

Es por eso que se necesita extender el Soft Set clásico (Determinado) a un Soft Set Indeterminado.

La función suave determinada (exacta)

$$F: A \rightarrow \mathcal{P}(H)$$

se extiende a una función suave indeterminada

$$F: A \rightarrow H(\wedge, \vee, \vee_E, \Rightarrow),$$

dónde $(\wedge, \vee, \vee_E, \Rightarrow)$ es un conjunto cerrado bajo \wedge, \vee, \vee_E , y \Rightarrow , y $f(x)$ no siempre está determinada.

Por ejemplo,

$$F(\text{blanco}) = h_3 \vee h_4,$$

significa que las casas h_3 o h_4 son blancas, pero no hay certeza de cuál,

de donde uno tiene tres posibilidades/resultados/alternativas:

o h_3 es blanco (y h_4 no lo es),

o h_4 es blanco (y h_3 no lo es),

o ambos h_3 y h_4 son blancos.

Esta es una información indeterminada.

También se puede simplemente escribir:

$$F(\text{blanco}) \left\{ \begin{array}{l} h_3 \\ h_4 \\ \{h_3, h_4\} \end{array} \right.$$

o F(blanco) $h_3, h_4, \{h_3, h_4\}$,
 donde $\{h_3, h_4\}$ significa $\{h_3 \text{ y } h_4\}$,
 que se lee como: o h_3 , o h_4 , o $\{h_3 \text{ y } h_4\}$.

Otro ejemplo:

$F(\text{azul}) = h_2$, o la casa h_2 no es azul,
 por lo tanto, otras casas entre $\{h_1, h_3, h_4\}$ pueden ser azules,
 o ninguna casa (\emptyset) puede ser azul.

Esta es otra información indeterminada.

La negación de h_2 (denotada como $\text{NOT}(h_2)$) no es igual al complemento clásico de $C(h_2)$ del elemento h_2 con respecto al conjunto H , ya que

$$C(h_2) = H \setminus \{h_2\} = \{h_1, h_3, h_4\},$$

pero puede ser cualquier subconjunto de $H \setminus \{h_2\}$, o cualquier subcomplemento de $C(h_2)$, de nuevo muchos posibles resultados (en este ejemplo 8) para elegir:

$$\begin{aligned} = h_2 &= h_1, h_3, h_4, \{h_1, h_3\}, \{h_1, h_4\}, \{h_3, h_4\}, \{h_1, h_3, h_4\}, \emptyset = \\ &\text{ya sea } h_1 \text{ o } h_3 \text{ o } h_4, \\ &\text{o } \{h_1 \text{ y } h_3\}, \text{o } \{h_1 \text{ y } h_4\}, \text{o } \{h_3 \text{ y } h_4\} \\ &\text{o } \{h_1 \text{ y } h_3 \text{ y } h_4\}, \\ &\text{o } \emptyset \text{ (elemento nulo, es decir, ninguna otra casa es azul).} \end{aligned}$$

La negación ($= h_2$) produce un mayor grado de indeterminación que las uniones anteriores: $(h_3 \vee h_4)$ y respectivamente $(h_3 \vee_E h_4)$.

La intersección (\wedge) es un operador determinado (cierto).

Por ejemplo,

$F(\text{verde}) = h_1 \wedge h_2$, que es igual a $\{h_1, h_2\}$, es decir, juntos, $\{h_1, h_2\} h_1 \text{ y } h_2 \{h_1 \text{ and } h_2\}$.

Puede ocurrir una combinación de estos operadores, por lo que la función suave indeterminada (incierto) se vuelve más compleja.

Otro ejemplo.

$F(\text{verde}) = h_1 \wedge (= h_4)$, donde por supuesto $= h_4 \neq h_1$, lo que significa que:

la casa h_1 es verde,

y otras casas entre $\{h_2, h_3\}$ pueden ser azules,

o \emptyset (ninguna otra casa es azul).

$$h_1 \wedge (= h_4) = h_1 \text{ y } (\text{NOT } h_4)$$

$$\begin{aligned} &h_1 \text{ y } (h_1, h_2, h_3, \{h_1, h_2\}, \{h_1, h_3\}, \{h_2, h_3\}, \{h_1, h_2, h_3\}, \emptyset) \\ &[h_1 \text{ se quita ya que } = h_4 \text{ se supone que es diferente de } h_1] \\ &h_1 \text{ y } (h_2, h_3, \{h_2, h_3\}, \emptyset) \\ &(h_1 \text{ y } h_2) \text{ o } (h_1 \text{ y } h_3) \\ &\text{o } (h_1 \text{ y } \{h_2, h_3\}) \\ &\text{o } \emptyset \\ &(h_1 \text{ y } h_2) \text{ o } (h_1 \text{ y } h_3) \text{ o } (h_1 \text{ y } h_2 \text{ y } h_3), \emptyset \\ &\text{notation } \{h_1, h_2\}, \{h_1, h_3\}, \{h_1, h_2, h_3\}, \emptyset \\ &= \end{aligned}$$

De este modo, hay 4 posibilidades.

. Definiciones de Álgebra, Neutro Álgebra, Anti Álgebra

Sea \mathcal{U} un universo de discurso, y H un conjunto no vacío incluido en \mathcal{U} . Además, H está dotado de algunas operaciones y axiomas.

.1. Álgebra

Una estructura algebraica cuyas operaciones están bien definidas y todos los axiomas son totalmente ciertos se denomina estructura algebraica clásica (o álgebra). De donde $(T, I, F) = (1, 0, 0)$.

. . Neutro Álgebra

Si al menos una operación o un axioma tiene algún grado de verdad (T), algún grado de indeterminación (I) y algún grado de falsedad (F), donde $(V, I, F) \notin \{(1, 0, 0), (0, 0, 1)\}$, y ninguna otra operación o axioma es totalmente falso ($F = 1$), entonces esto se llama Neutro Álgebra.

. . AntiÁlgebra

Una estructura algebraica que tiene al menos una operación que está totalmente definida externamente ($F = 1$) o al menos un axioma que es totalmente falso ($F = 0$), se llama AntiÁlgebra.

. Definición de Indetermin Álgebra

Se introduce ahora por primera vez el concepto de Inter Álgebra (Álgebra Indeterminada), como una subclase de Neutro Álgebra.

Inter Álgebra se obtiene de aplicaciones reales, como se verá más adelante.

Sea \mathcal{U} un universo de discurso, y H un conjunto no vacío incluido en \mathcal{U} .

Si al menos una operación o un axioma tiene algún grado de indeterminación ($I > 0$), el grado de falsedad $F = 0$, y todas las demás operaciones y axiomas son totalmente ciertos, entonces H es un Álgebra Indeterminada.

. Definición de Álgebra IndetermSoft

El conjunto $H(\mathbb{A}, \mathbb{V}, \mathbb{VE}, \Rightarrow)$ cerrado mediante los siguientes operadores:

joinAND (denotado por \mathbb{A}), que es un operador determinado;

disjoinOR (denotado por \mathbb{V}), que es un operador indeterminado;

exclusiveOR (denotado por \mathbb{VE}), que es un operador indeterminado,

y subnegación/subcomplemento NOT (indicado por \Rightarrow), que es un operador indeterminado;

entonces se llama Álgebra IndetermSoft.

El Álgebra IndetermSoft amplía el Álgebra clásica de Soft Sets.

El Álgebra IndetermSoft es un caso particular de Indeterm Álgebra, y de Neutro Álgebra.

El operador *joinAND*

$$\mathbb{A}: H^2 \rightarrow H(\mathbb{A}, \mathbb{V}, \mathbb{VE}, \Rightarrow)$$

es determinado (en el sentido clásico):

$$\forall x, y \in H, x \neq y, x \mathbb{A} y = x \text{ unionAND } y = xy = \{x, y\} \in H(\mathbb{A}, \mathbb{V}, \mathbb{VE}, \Rightarrow)$$

por lo tanto, la agregación de x e y utilizando el operador \mathbb{A} da un resultado claro y único, es decir, el conjunto clásico de dos elementos: $\{x, y\}$

Pero el operador *disjoinOR*

$$\mathbb{V}: H^2 \rightarrow H(\mathbb{A}, \mathbb{V}, \mathbb{VE}, \Rightarrow)$$

es indeterminado porque:

$$\forall x, y \in H, x \neq y, \text{disjoinOR } y = \begin{cases} \text{ya sea } x \\ \text{o } y \\ \text{o ambos } \{x \text{ e } y\} \end{cases} \begin{cases} x \\ y \\ \{x, y\} \end{cases}$$

Por lo tanto, la agregación de x e y usando el operador \forall da un resultado poco claro, con tres posibles soluciones alternativas (ya sea x , o y , o $\{x \text{ e } y\}$).

El operador exclusiveOR también es indeterminado:

$\forall x, y \in H, x \neq y, x \neq y \forall e$ y exclusiveOR ya sea x , o y , y no $\{x, y\}$,

por lo tanto dos posibles soluciones:

$\forall E: H^2 \rightarrow H(\wedge, \forall, \forall E, \Rightarrow)$.

De manera similar, el operador subnegación/subcomplemento NOT

$\Rightarrow: H \rightarrow H(\wedge, \forall, \forall E, \Rightarrow)$

es indeterminado debido a muchos elementos $x \in H$,

$NOT(x)$ x una parte del complemento de x con respecto a $H \Rightarrow x$
un subconjunto de $H \setminus \{x\}$.

Pero hay muchos subconjuntos de $H \setminus \{x\}$, por lo tanto, hay una salida poco clara (incierto, ambigua), con múltiples soluciones alternativas posibles.

. Definición de Conjunto IndetermSoft

Sea U un universo de discurso, H un subconjunto no vacío de U , y $H(\wedge, \forall, \forall E, \Rightarrow)$ el álgebra IndetermSoft generada al cerrar el conjunto H bajo los operadores $\wedge, \forall, \forall E, \Rightarrow$.

Sea a un atributo, con su conjunto de valores de atributos denotados por A . Entonces el par

(F, A) , donde $F: A \rightarrow H(\wedge, \forall, \forall E, \Rightarrow)$, se llama Conjunto IndetermSoft sobre H .

. Conjunto IndetermSoft Difuso Intuicionista Difuso Neutrosófico y otras extensiones difusas

Se pueden asociar grados difusos/intuicionistas difusos/neutrosóficos, etc. y extender el Conjunto IndetermSoft a Conjunto IndetermSoft Difuso/Intuicionista Difuso/Neutrosófico/y otras extensiones difusas.

.1. Aplicaciones del conjunto IndetermSoft (Difuso Intuicionista Difuso Neutrosófico y otras extensiones difusas)

Sea $H = \{h_1, h_2, h_3, h_4\}$ un conjunto de cuatro casas, y el álgebra IndetermSoft generada al cerrar el conjunto H mediante los operadores suaves anteriores, $H(\wedge, \forall, \forall E, \Rightarrow)$.

Sea el atributo $c = color$, y sus valores de atributo sean el conjunto $C = \{blanca, verde, azul\}$.

La función IndetermSoft $F: A \rightarrow H(\wedge, \forall, \forall E, \Rightarrow)$ forma un Conjunto IndetermSoft.

Sea un elemento $h \in H$, y se denota por:

$d^\circ(h)$ cualquier tipo de grado (ya sea difuso, o intuicionista difuso, o neutrosófico, o cualquier otra extensión difusa) del elemento h .

Se extienden los operadores suaves $\wedge, \forall, \forall E, \Rightarrow$ asignando algún grado $d^0(\cdot) \in [0, 1]^p$, donde:

$p = 1$ para el grado clásico y difuso, $p = 2$ para el grado difuso intuicionista, $p = 3$ para el grado neutrosófico, y así sucesivamente $p = n$ para el grado neutrosófico refinado de valor n , hasta los elementos involucrados en los

operadores, donde \wedge, \vee, \neg representan la conjunción, la disyunción y la negación, respectivamente, de estos grados en sus correspondientes conjuntos o lógicas de extensión difusa.

Por ejemplo:

i. De $F(blanco) = h_1 \wedge h_2$ como en el conjunto IndetermSoft, se extiende a:

$F(blanca) = h_1(d_1^\circ) \wedge h_2(d_2^\circ)$, lo que significa que el grado (oportunidad) de que h_1 sea blanco es d_1° y el grado (oportunidad) de que h_2 sea blanca es d_2° , de donde:

$$F(blanca) = h_1(d_1^\circ) \wedge h_2(d_2^\circ) = \{h_1, h_2\}(d_1^\circ \wedge d_2^\circ)$$

Como tal, el grado en que ambas casas $\{h_1, h_2\} = \{h_1 \text{ y } h_2\}$ sean blancas es $d_1^\circ \wedge d_2^\circ$.

$$\text{ii. Similarmente, } F(\text{blanca}) = h_1(d_1^\circ) \vee h_2(d_2^\circ) \quad \{h_1 \text{ o } h_2\} (d_1^\circ \vee d_2^\circ),$$

o el grado de al menos una casa $\{h_1 \text{ o } h_2\}$ sea blanca es $(d_1^\circ \vee d_2^\circ)$.

$$\text{iii. } F(\text{blanca}) = h_1(d_1^\circ) \vee_E h_2(d_2^\circ)$$

$\{h_1 \text{ y (no } h_2)\}, \text{ o o } \{(\text{no } h_1) \text{ y } h_2\}, \text{ y } \{(\text{no } h_1) \text{ y (no } h_2)\}$

$= (h_1 \text{ es blanco, o } h_2 \text{ es blanco, y [no ambos } \{h_1, h_2\}\text{ son blancos simultáneamente})$ tiene el grado de $(d_1^\circ \vee d_2^\circ) - (d_1^\circ \wedge d_2^\circ)$.

iv. $F(\text{blanca}) = (\Rightarrow h_1)(d_1^\circ)$, lo que significa que el grado (probabilidad) de que h_1 no sea blanco

es $(\Rightarrow h_1 = NO(h_1) = \text{ya sea } h_2, \text{ o } h_3, \text{ o } h_4,$

$\text{o } \{h_2, h_3\}, \{h_2, h_4\}, \{h_3, h_4\},$

$\text{o } \{h_2, h_3, h_4\},$

$\text{o } \emptyset \text{ (ninguna casa).}$

Hay 8 alternativas, por lo que $NOT(h_1)$ es una de ellas.

Suponiendo que $NOT(h_1) = \{h_3, h_4\}$. Entonces el grado de que ambas casas $\{h_3, h_4\}$ sean blancas es $\neg d_1^\circ$.

. Definición de conjunto IndetermHyperSoft

Sea U un universo de discurso, H un subconjunto no vacío de U y $H(\mathbb{A}, \mathbb{V}, \forall E, \Rightarrow)$ el álgebra IndetermSoft generado al cerrar el conjunto H bajo los operadores $\mathbb{A}, \mathbb{V}, \forall E, \text{ y } \Rightarrow$.

Sea a_1, a_2, \dots, a_n , donde $n \geq 1$, n atributos distintos, cuyos valores de atributo correspondientes sean respectivamente los conjuntos A_1, A_2, \dots, A_n , con $A_i \cap A_j = \emptyset$ para $i \neq j$, y $i, j \in \{1, 2, \dots, n\}$. Entonces el par $(F, A_1 \times A_2 \times \dots \times A_n)$, donde $A_1 \times A_2 \times \dots \times A_n$ representa un producto cartesiano, con

$F: A_1 \times A_2 \times \dots \times A_n \rightarrow H(\mathbb{A}, \mathbb{V}, \forall E, \Rightarrow)$, se denomina Conjunto IndetermHyperSoft.

De manera similar, se puede asociar grados difusos/intuicionistas difusos/neutrosóficos, etc. y extender el Conjunto IndetermHyperSoft a algún Conjunto IndetermHyperSoft Difuso/Intuicionista Difuso/Neutrosófico, etc.

. Aplicaciones del Conjunto IndetermHyperSoft

Sea nuevamente $H = \{h_1, h_2, h_3, h_4\}$ un conjunto de cuatro casas, y el atributo $c = \text{color}$, cuyos valores son $C = \{\text{blanca, verde, azul, roja}\}$, y otro atributo $p = \text{precio}$, cuyos valores son $P = \{\text{barata, cara}\}$.

La función

$$F: C \times P \rightarrow \mathcal{P}(H)$$

donde $\mathcal{P}(H)$ es el conjunto potencia de H , es un Conjunto HyperSoft.

$F: C \times P \rightarrow H(\mathbb{A}, \mathbb{V}, \forall E, \Rightarrow)$, se denomina Conjunto IndetermHyperSoft.

Ejemplos:

$$F(\text{blanca, barata}) = h_2 \vee h_4$$

$$F(\text{verde, cara}) = h_1 \vee_E h_2$$

$$F(\text{roja, cara}) = h_3 \Rightarrow$$

Para un conjunto IndetermHyperSoft Neutrosófico se tienen grados neutrosóficos, por ejemplo:

$$F(\text{blanco, barato}) = h_2(0.4, 0.2, 0.3) \vee h_4(0.5, 0.1, 0.4)$$

De la misma manera que arriba (Sección 26.1), se extienden los operadores de HyperSoft $\mathbb{A}, \mathbb{V}, \forall E, \Rightarrow$ asignando algún grado $d^0(\cdot) \in [0, 1]^p$, donde: $p = 1$ para grado clásico y difuso, $p = 2$ para grado difuso intuicionista, $p = 3$ para grado neutrosófico, y así sucesivamente $p = n$ para grado neutrosófico refinado de n -valor, a los elementos involucrados en los operadores, donde \wedge, \vee, \neg representan la conjunción, la disyunción y la negación, respectivamente, de estos grados en sus correspondientes conjuntos o lógicas de extensión difusa.

. Definición de Grupo Conmutativo de Tripletas Neutrosóficas

Sea \mathcal{U} un universo de discurso, y $(H, *)$ un conjunto no vacío incluido en \mathcal{U} , donde $*$ es una operación binaria (ley) sobre H .

(i) La operación $*$ sobre H es bien definida, asociativa y conmutativa.

(ii) Para cada elemento $x \in H$ existe un elemento $y \in H$, llamado neutro de x , tal que y es diferente del elemento unidad (si lo hay), con $x * y = y * x = x$, y existe un elemento $z \in H$, llamado el inverso de x , tal que $x * z = z * x = y$, entonces a (x, y, z) se le llama tripleta neutrosófica.

Entonces $(H, *)$ es el Grupo Conmutativo de Tripletas Neutrosóficas.

En general, el Álgebra de Tripletas Neutrosóficas es diferente del Álgebra Clásica.

.1. Teorema

El Álgebra de join AND (H, \wedge) y el Álgebra de disjoinOR (H, \vee) , son Grupos Conmutativos de Tripletas Neutrosóficas.

Prueba

Anteriormente se ha probado que los operadores \wedge y \vee son cada uno de ellos: bien definidos, asociativos y conmutativos.

También se probó que los dos operadores son idempotentes:

$$\forall x \in H, x \wedge x = x \text{ y } x \vee x = x.$$

Por lo tanto, para (H, \wedge) y (H, \vee) respectivamente se tienen tripletas neutrosóficas de la forma: (x, x, x) .

. Enriquecimiento de los Conjuntos IndetermSoft e IndetermHyperSoft

Se invita a los lectores a ampliar esta investigación, ya que se pueden agregar más operadores suaves determinados e indeterminados a las Álgebras IndetermSoft o IndetermHyperSoft, resultantes de (o necesarios para) varias aplicaciones reales, y como tal, se obtienen estructuras Soft e HyperSoft más fuertes.

Algunas sugerencias:

$F(\text{blanca}) = \text{al menos } k \text{ casas};$

o $F(\text{blanca}) = \text{como mucho } k \text{ casas};$

o $F(\text{verde, pequeña}) = \text{entre } k_1 \text{ y } k_2 \text{ casas};$

donde k, k_1 y k_2 son números enteros positivos, con $k_1 \leq k_2$.

Etc.

1. Conclusiones

Los operadores suaves indeterminados, presentados en este documento, son el resultado de aplicaciones de nuestro mundo real. Un Álgebra definida mediante tales operadores se denominaba Álgebra suave indeterminada.

Los conjuntos IndetermSoft e IndetermHyperSoft, y sus correspondientes formas Difusa/Intuicionista Difusa/Neutrosófica, construidas sobre esta Álgebra indeterminada, se presentan por primera vez como extensiones de los Conjuntos Soft e HyperSoft clásicos.

Se muestran muchas aplicaciones y ejemplos.

Agradecimientos

El autor quiere agradecer a Muhammad Saeed, Atiqe Ur Rahman y Muhammad Ihsan por sus comentarios sobre este artículo.

1. Molodtsov, D. (1999) Soft Set Theory First Results. *Computer Math. Applic.* 37, 19-31.
2. Maji, P. K. (2013) Neutrosophic Soft Set. *Annals of Fuzzy Mathematics and Informatics* 5 (1), 157-168.

3. Smarandache, F. (2018) Extension of Soft Set to Hypersoft Set, and then to Plithogenic Hypersoft Set, *Neutrosophic Sets and Systems* 22, 168-170.
DOI: 10.5281/zenodo.2159754, <http://fs.unm.edu/NSS/ExtensionOfSoftSetToHypersoftSet.pdf>
4. Smarandache, F. (2019) Extension of Soft Set to Hypersoft Set, and then to Plithogenic Hypersoft Set (revisited). *Octagon Mathematical Magazine*, 27(1), 413-418.
5. Shazia Rana; Madiha Qayyum; Muhammad Saeed; Florentin Smarandache; Bakhtawar Ali Khan (2019). Plithogenic Fuzzy Whole Hypersoft Set, Construction of Operators and their Application in Frequency Matrix Multi Attribute Decision Making Technique. *Neutrosophic Sets and Systems* 28, <http://fs.unm.edu/neut/PlithogenicFuzzyWholeHypersoftSet.pdf>
6. Nivetha Martin, Florentin Smarandache (2020). Introduction to Combined Plithogenic Hypersoft Sets. *Neutrosophic Sets and Systems* 35, 8 p.
<http://fs.unm.edu/neut/IntroductionToCombinedPlithogenic.pdf>
7. Mujahid Abbas; Ghulam Murtaza, Florentin Smarandache (2020). Basic operations on hypersoft sets and hypersoft point. *Neutrosophic Sets and Systems*, 35, 2020, 15 p.
<http://fs.unm.edu/neut/BasicOperationsOnHypersoft.pdf>
8. Muhammad Ihsan; Muhammad Saeed; Atiqe Ur Rahman; Florentin Smarandache (2022). An Inclusive Study on Fundamentals of Hypersoft Expert Set with Application, *Punjab University Journal of Mathematics* 54(5), 315-332, <https://doi.org/10.52280/pujm.2022.540503>
9. Muhammad Saqlain; Muhammad Riaz; Muhammad Adeel Saleem; Miin-Shen Yang. Distance and Similarity Measures for Neutrosophic HyperSoft Set (NHSS) with Construction of NHSS-TOPSIS and Applications. *IEEE Access*, 14;
DOI: 10.1109/ACCESS.2021.3059712, <http://fs.unm.edu/neut/DistanceAndSimilarityNHSSTOP SIS.pdf>
10. Smarandache, F. (2015). Neutrosophic Function, 14-15, in *Neutrosophic Precalculus and Neutrosophic Calculus*, EuropaNova, Brussels, <http://fs.unm.edu/NeutrosophicPrecalculusCalculus.pdf>
11. Smarandache, F. (2014). Neutrosophic Function, in *Introduction to Neutrosophic Statistics*, Sitech & Education Publishing, 74-75; <http://fs.unm.edu/NeutrosophicStatistics.pdf>.
12. Smarandache, F. (2019). Introduction to NeutroAlgebraic Structures and AntiAlgebraic Structures [<http://fs.unm.edu/NA/NeutroAlgebraicStructures-chapter.pdf>], in *Advances of Standard and Nonstandard Neutrosophic Theories*, Pons Publishing House, Brussels, Belgium, Chapter 6, 240-265;
<http://fs.unm.edu/AdvancesOfStandardAndNonstandard.pdf>
<http://fs.unm.edu/NA/NeutroAlgebra.htm>
13. Smarandache, F. (2020). NeutroAlgebra is a Generalization of Partial Algebra. *International Journal of Neutrosophic Science* 2, 8-17; DOI: <http://doi.org/10.5281/zenodo.3989285>
<http://fs.unm.edu/NeutroAlgebra.pdf>
14. Smarandache, F.; Al-Tahan, Madeline (eds.) (2022). Theory and Applications of NeutroAlgebras as Generalizations of Classical Algebras. IGI Global, USA, 333 p.; <https://www.igi-global.com/book/theory-applications-neutroalgebras-generalizations-classical/284563>

An Inclusive Study on Fundamentals of Hypersoft Expert Set with Application

Muhammad Ihsan, Muhammad Saeed, Atiqe Ur Rahman, Florentin Smarandache

Muhammad Ihsan, Muhammad Saeed, Atiqe Ur Rahman, Florentin Smarandache (2022). An Inclusive Study on Fundamentals of Hypersoft Expert Set with Application. Punjab University Journal of Mathematics 54(5), 315-332; DOI: 10.52280/pujm.2022.540503

Abstract.: Soft set deals with single set of attributes whereas its extension hypersoft set deals with multi attribute-valued disjoint sets corresponding to distinct attributes. Many researchers have created some models based on soft set to solve problems in decision-making, but most of these models deal with only one expert. This causes a problem with the users, especially with those who use questionnaires in their work. Therefore we present a novel model hypersoft expert set which not only addresses this limitation of soft-like models with the emphasis on the opinion of all experts but also resolves the inadequacy of soft set for attribute-valued disjoint sets corresponding to distinct attributes. In this study, the existing concept of hypersoft expert set is modified and some fundamental properties i.e. subset, not set and equal set, whole set, absolute set, relative null set, relative absolute set; results i.e. commutative, associative, distributive and De Morgan's Laws and set-theoretic operations i.e. complement, union intersection, restricted union, extended intersection, AND, and OR are developed. An algorithm is proposed to solve decision-making problem and applied to recruitment process for hiring "right person for the right job".

Key Words: Soft Set, Soft Expert Set, Hypersoft Set, Hypersoft Expert Set, Recruitment Process.

1. INTRODUCTION

Molodtsov [22] conceptualized soft set (s-set) as it deals with the single approximate functions. The s-set also regarded as a new parameterized family of subsets of the universe of discourse as it transforms the single attribute-valued set into subsets of the universe of discourse. Chen et al. [9] introduced the parameter reduction of s-set and applied in

application of different areas. Maji et al. [20] worked on s -set and initiated its different characteristics like equality, union and intersection of two or more s -sets, null and absolute s -sets and some generalized operations especially AND and OR. They also verified certain results as well. After introducing fundamentals of s -sets, Maji [21] applied successfully this theory in decision-making problems (DMPs) by giving its an application using rough mathematics. Ali et al. [7] developed characteristics like restricted union, intersection, difference and extended intersection. Babitha et al. [8] introduced some relations and functions on s -set. Fatimah et al. [11] developed N -soft sets and discussed their decision-making algorithms with applications. Akram et al. [2] have made great contributions by introducing group like methods using hesitant N -soft sets with numerical cases in DMPs. Deli [10] introduced the concept of convexity using structures of s -set and fuzzy soft set (fs -set). He proved some important results by using operations like union, intersection and complement. Later on Majeed [19] introduced the concept of convex hull and cone for s -set to meet the demand of computational geometry with uncertain and vague information. Rahman et al. [24, 25] introduced the concept of (m, n) -convexity cum concavity by defining first and second senses on s -set. They discussed the various properties of convexity cum concavity under fs -set and s -set. The s -set has been constructed for the opinion of single expert in a single model. But certain circumstances demand opinions of more than one experts using single model. To address this scarcity, soft expert set (se -set) has been constructed. Alkhazaleh et al. [3] converted successfully the structure of s -set to se -set by combining s -set and expert set. They characterized its necessary characteristics i.e. complement, intersection, AND, OR etc., and successfully applied the concept in DMPs. Alkhazaleh et al. [4, 5, 6] extended the work of se -set and developed the theories of soft multi sets and possibility fuzzy s -set to adequate their already proposed structures for other scenarios. Ihsan et al. [12, 13] extended the work of convexity cum concavity on se -set, fuzzy se -set and discussed its several properties with numerical cases.

1.1. Research Gap and Motivation. Following points are provided to explain the research gap and motivation behind the choice of proposed structure:

- (1) The s -set is usually useful for single argument approximate functions but it fails when functions are of multi-argument nature. To solve this kind of issue, Smarandache took initiative and brought about a new type of model hypersoft set (hs -set). Smarandache [38] made extension of s -set by introducing hs -set. He made use of multi-attribute valued functions in replace of single attribute-valued functions. Saeed et al. [36] introduced several fundamentals of hs -set for its applicability in various other fields of study. Abbas et al. [1] introduced basic notions of hs -set points and discussed its certain properties in topological structures. They also verified certain results with the help of examples. Rahman et al. [26] developed the hybrids of hs -set with different structures and discussed its theoretic operations with generalized results. Rahman et al. [28] introduced decision-making application based on neutrosophic parameterized hypersoft set theory. Rahman et al. [29] conceptualized possibility neutrosophic hypersoft sets with application in diagnosis of heart diseases. Rahman et al. [30] introduced new structure of bijective hypersoft set with application in decision-making. Rahman et al. [31] applied decision-making application based on aggregations of complex fuzzy hypersoft

set and developed interval-valued complex fuzzy hypersoft set. Rahman et al. [32] also presented decision-making algorithmic approaches based on parameterization of neutrosophic set under hypersoft set environment with fuzzy, intuitionistic fuzzy and neutrosophic settings. Rahman et al. [33] worked on decision-making algorithmic techniques based on aggregation operations and similarity measures of possibility intuitionistic fuzzy hypersoft sets. Rahman et al. [34] made use of theoretical and analytical approach to the conceptual framework of convexity cum concavity on fuzzy hypersoft sets with some generalized properties. Rahman et al. [35] introduced the multi-attribute decision-support system based on aggregations of interval-valued complex neutrosophic hypersoft set. Saqlain et al. [37] gave the idea of aggregation operators for neutrosophic hypersoft set. Yolcu & Öztürk [39] introduced the concept of fuzzy hypersoft set with its fundamental operators and applied them in decision-making. Yolcu et al. [40] also conceptualized intuitionistic fuzzy hypersoft set and discussed its applications in decision-making problems. Öztürk & Yolcu [23] redefined the operations of neutrosophic hypersoft topological spaces and discussed its basic properties.

- (2) It can be viewed that the s-set like models deal with opinion of only single expert. But in real life, there are certain situations where we need different opinions of different experts in one model. To tackle this situation, se-set has been developed. However, there are also certain situations when features are farther classified into their relevant numerical-characteristics disjoint sets. Ihsan et al. [27] made extension of hs-set and introduced a new structure called hypersoft expert set (hse-set) and then the researchers [14, 15, 16, 17] made contributions by developing fuzzy hse-set, single valued neutrosophic hse-set and bijective hse-set respectively with applications in DMPs.
- (3) Having motivation from [3, 36], fundamentals of hse-set are developed and a new method is adopted to explain an application in DMPs.

The paper is written in this order: section 2 has definitions of s-sets, se-set and hs-set. Section 3 contains the basic notions of hse-set with properties. Section 4 contains a numerical case of of main structure in DMPs. In section 5 conclusion has been described.

2. PRELIMINARIES

In first part of the paper, some necessary definitions are described from the literature to support the main study. Now some important symbols are mentioned that will be used throughout the paper: $P(\tilde{\Omega})$ for the power set of $\tilde{\Omega}$ (universe of discourse), \mathcal{A} for the collection of parameters, \mathcal{E} for the collection of experts and \mathcal{C} for the set of conclusions, $T = \mathcal{A} \times \mathcal{E} \times \mathcal{C}$ with $\mathcal{S} \subseteq T$.

Definition 1. [22]

A soft set is a collection of pairs $(\Upsilon_M, \mathcal{A})$ with Υ_M is a mapping defined by $\Upsilon_M : \mathcal{A} \rightarrow P(\tilde{\Omega})$ where \mathcal{A} is a set of parameters.

Definition 2. [20]

The union of two s-sets $(\Gamma_1, \mathcal{A}_1)$ and $(\Gamma_2, \mathcal{A}_2)$ over $\tilde{\Omega}$ is a s-set $(\Gamma_3, \mathcal{A}_3)$ with $\mathcal{A}_3 \doteq$

$\mathbb{A}_1 \cup \mathbb{A}_2$, and $\forall o \in \mathbb{A}_3$,

$$\Gamma_3(o) = \begin{cases} \Gamma_1(o) & ; o \in \mathbb{A}_1 \setminus \mathbb{A}_2 \\ \Gamma_2(o) & ; o \in \mathbb{A}_2 \setminus \mathbb{A}_1 \\ \Gamma_1(o) \cup \Gamma_2(o) & ; o \in \mathbb{A}_1 \cap \mathbb{A}_2. \end{cases}$$

Definition 3. [2]

The intersection of two s-sets $(\vec{\Theta}_1, \mathbb{A}_1)$ and $(\vec{\Theta}_2, \mathbb{A}_2)$ is a s-set $(\vec{\Theta}_3, \mathbb{A}_3)$ with $\mathbb{A}_3 \doteq \mathbb{A}_1 \cup \mathbb{A}_2$, for all $o \in \mathbb{A}_3$,

$$\vec{\Theta}_3(o) = \begin{cases} \vec{\Theta}_1(o) & ; o \in \mathbb{A}_1 \setminus \mathbb{A}_2 \\ \vec{\Theta}_2(o) & ; o \in \mathbb{A}_2 \setminus \mathbb{A}_1 \\ \vec{\Theta}_1(o) \cup \vec{\Theta}_2(o) & ; o \in \mathbb{A}_1 \cap \mathbb{A}_2. \end{cases}$$

Definition 4. [10]

A collection of pairs $(\tilde{h}_A, \mathcal{S})$ is called a soft expert set over $\tilde{\Omega}$ with \tilde{h}_A is a mapping given by $\tilde{h}_A : \mathcal{S} \rightarrow P(\tilde{\Omega})$ where $\mathcal{S} \subseteq T = \downarrow \times \mathbb{S} \times \vec{\delta}$ and \downarrow stands for set of parameters, \mathbb{S} is the set of experts and $\vec{\delta}$ is the set of conclusions. For simplicity, $\{0 = agree, 1 = disagree\}$ is being used as of set of conclusion.

Definition 5. [10]

A soft expert set $(\check{\alpha}_1, \check{\delta})$ will be subset of $(\check{\alpha}_2, \check{\delta})$ over $\tilde{\Omega}$, if $\check{\alpha}_1 \subseteq \check{\alpha}_2, \forall o \in \check{\delta}, \check{\alpha}_1(o) \subseteq \check{\alpha}_2(o)$. Moreover $(\check{\alpha}_2, \check{\delta})$ is a superset of $(\check{\alpha}_1, \check{\delta})$.

Definition 6. [38]

Suppose $\mathcal{U}_1, \mathcal{U}_2, \mathcal{U}_3, \dots, \mathcal{U}_\alpha$, for $\alpha \geq 1$, be α disjoint attributes, while the sets $\mathcal{L}_1, \mathcal{L}_2, \mathcal{L}_3, \dots, \mathcal{L}_\alpha$, are corresponding attribute valued sets with $\mathcal{L}_m \cap \mathcal{L}_n = \emptyset$ for $m \neq n$ and $m, n \in \{1, 2, 3, \dots, \alpha\}$. Then the pair (η, \mathfrak{G}) while $\mathfrak{G} = \mathcal{L}_1 \times \mathcal{L}_2 \times \mathcal{L}_3 \times \dots \times \mathcal{L}_\alpha$ and $\eta : \mathfrak{G} \rightarrow P(\tilde{\Omega})$ is called a hypersoft set over $\tilde{\Omega}$.

3. FUNDAMENTALS OF HYPERSOFT EXPERT SET

In this section, the definition of hypersoft expert set and its fundamental properties (subset, equal set, not set, complement of a set, relative complement, relative null set, relative whole set, agree and disagree set etc.) are presented with examples.

Definition 7. [14] *Hypersoft Expert set* (hse-set): A pair $(\underbrace{\Psi}_{\mathfrak{S}}, \mathcal{S})$ is named as a hypersoft expert set over $\tilde{\Omega}$ with $\underbrace{\Psi}_{\mathfrak{S}} : \mathcal{S} \rightarrow P(\tilde{\Omega})$ where $\mathcal{S} \subseteq T = \mathfrak{S} \times \mathbb{S} \times \vec{\delta}$; $\mathfrak{S} = \mathfrak{S}_1 \times \mathfrak{S}_2 \times \mathfrak{S}_3 \times \dots \times \mathfrak{S}_n$ with $\mathfrak{S}_1, \mathfrak{S}_2, \mathfrak{S}_3, \dots, \mathfrak{S}_n$ are disjoint attributes sets corresponding to n disjoint attributes $\partial_1, \partial_2, \partial_3, \dots, \partial_n$; \mathbb{S} represents the set of experts and $\vec{\delta}$ represents the set of conclusion.

Example 3.1. Assume that a multi-national manufacturing company plans to assess its manufactured items through external evaluators. Let $\tilde{\Omega} = \{v_1, v_2, v_3, v_4\}$ be a set of items and $\Lambda_1 = \{g_{11}, g_{12}\}, \Lambda_2 = \{g_{21}, g_{22}\}, \Lambda_3 = \{g_{31}, g_{32}\}$, be disjoint parametric valued sets for distinct attributes $g_1 =$ simple to utilize, $g_2 =$ nature, $g_3 =$ modest. Now $\Lambda = \Lambda_1 \times \Lambda_2 \times \Lambda_3$

$$\Lambda = \left\{ \begin{array}{l} \eta_1 = (g_{11}, g_{21}, g_{31}), \eta_2 = (g_{11}, g_{21}, g_{32}), \eta_3 = (g_{11}, g_{22}, g_{31}), \eta_4 = (g_{11}, g_{22}, g_{32}), \\ \eta_5 = (g_{12}, g_{21}, g_{31}), \eta_6 = (g_{12}, g_{21}, g_{32}), \eta_7 = (g_{12}, g_{22}, g_{31}), \eta_8 = (g_{12}, g_{22}, g_{32}) \end{array} \right\}.$$

Now $\Pi = \Lambda \times \Upsilon \times \Gamma$

$$\Pi = \left\{ \begin{array}{l} (\eta_1, q, 0), (\eta_1, s, 1), (\eta_1, t, 0), (\eta_1, t, 1), (\eta_1, u, 0), (\eta_1, u, 1), (\eta_8, s, 0), \\ (\eta_2, s, 0), (\eta_2, s, 1), (\eta_2, t, 0), (\eta_2, t, 1), (\eta_2, u, 0), (\eta_2, u, 1), (\eta_8, s, 1), \\ (\eta_3, s, 0), (\eta_3, s, 1), (\eta_3, t, 0), (\eta_3, t, 1), (\eta_3, u, 0), (\eta_3, u, 1), (\eta_8, t, 0), \\ (\eta_4, s, 0), (\eta_4, s, 1), (\eta_4, t, 0), (\eta_4, t, 1), (\eta_4, u, 0), (\eta_4, u, 1), (\eta_8, t, 1), \\ (\eta_5, s, 0), (\eta_5, s, 1), (\eta_5, t, 0), (\eta_5, t, 1), (\eta_5, u, 0), (\eta_5, u, 1), (\eta_8, u, 0), \\ (\eta_6, s, 0), (\eta_6, s, 1), (\eta_6, t, 0), (\eta_6, t, 1), (\eta_6, u, 0), (\eta_6, u, 1), (\eta_8, u, 1) \\ (\eta_7, s, 0), (\eta_7, s, 1), (\eta_7, t, 0), (\eta_7, t, 1), (\eta_7, u, 0), (\eta_7, u, 1), \end{array} \right\}.$$

Let

$$F = \left\{ \begin{array}{l} (\eta_1, q, 0), (\eta_1, s, 1), (\eta_1, t, 0), (\eta_1, t, 1), (\eta_1, u, 0), (\eta_1, u, 1), \\ (\eta_3, s, 0), (\eta_3, s, 1), (\eta_3, t, 0), (\eta_3, t, 1), (\eta_3, u, 0), (\eta_3, u, 1), \\ (\eta_5, s, 0), (\eta_5, s, 1), (\eta_5, t, 0), (\eta_5, t, 1), (\eta_5, u, 0), (\eta_5, u, 1) \end{array} \right\}$$

be a subset of Π and $\Upsilon = \{s, t, u\}$ represents a set of specialists and $\Gamma = \{0 = agree, 1 = disagree\}$ represents a set of conclusion. Following are the approximations of prescribed attributes with respect to selected evaluators:

$$\begin{aligned} \mathcal{U}_1 &= \mathcal{U}(\eta_1, s, 1) = \{v_1, v_2, v_4\}, \mathcal{U}_2 = \mathcal{U}(\eta_1, t, 1) = \{v_3, v_4\}, \mathcal{U}_3 = \mathcal{U}(\eta_1, u, 1) = \{v_3, v_4\}, \\ \mathcal{U}_4 &= \mathcal{U}(\eta_3, s, 1) = \{v_4\}, \mathcal{U}_5 = \mathcal{U}(\eta_3, t, 1) = \{v_1, v_3\}, \\ \mathcal{U}_6 &= \mathcal{U}(\eta_3, u, 1) = \{v_1, v_2, v_4\}, \mathcal{U}_7 = \mathcal{U}(\eta_5, s, 1) = \{v_3, v_4\}, \mathcal{U}_8 = \mathcal{U}(\eta_5, t, 1) = \{v_1, v_2\}, \\ \mathcal{U}_9 &= \mathcal{U}(\eta_5, u, 1) = \{v_4\}, \\ \mathcal{U}_{10} &= \mathcal{U}(\eta_1, s, 0) = \{v_3\}, \mathcal{U}_{11} = \mathcal{U}(\eta_1, t, 0) = \{v_2, v_3\}, \mathcal{U}_{12} = \mathcal{U}(\eta_1, u, 0) = \{v_1, v_2\}, \\ \mathcal{U}_{13} &= \mathcal{U}(\eta_3, s, 0) = \{v_1, v_2, v_3\}, \mathcal{U}_{14} = \mathcal{U}(\eta_3, t, 0) = \{v_2, v_4\}, \mathcal{U}_{15} = \mathcal{U}(\eta_3, u, 0) = \{v_3\}, \\ \mathcal{U}_{16} &= \mathcal{U}(\eta_5, s, 0) = \{v_1, v_2\}, \mathcal{U}_{17} = \mathcal{U}(\eta_5, t, 0) = \{v_3, v_4\}, \mathcal{U}_{18} = \mathcal{U}(\eta_5, u, 0) = \{v_1, v_2, v_3\}. \end{aligned}$$

The hypersoft expert set is

$$(\mathcal{U}, F) = \left\{ \begin{array}{l} ((\eta_1, s, 1), \{v_1, v_2, v_4\}), ((\eta_1, t, 1), \{v_1, v_4\}), ((\eta_1, u, 1), \{v_3, v_4\}), \\ ((\eta_3, s, 1), \{v_4\}), ((\eta_3, t, 1), \{v_1, v_3\}), ((\eta_3, u, 1), \{v_1, v_2, v_4\}), \\ ((\eta_5, s, 1), \{v_3, v_4\}), ((\eta_5, t, 1), \{v_1, v_2\}), ((\eta_5, u, 1), \{v_4\}), \\ ((\eta_1, s, 0), \{v_3\}), ((\eta_1, t, 0), \{v_2, v_3\}), ((\eta_1, u, 0), \{v_1, v_2\}), \\ ((\eta_3, s, 0), \{v_1, v_2, v_3\}), ((\eta_3, t, 0), \{v_2, v_4\}), ((\eta_3, u, 0), \{v_3\}), \\ ((\eta_5, s, 0), \{v_1, v_2\}), ((\eta_5, t, 0), \{v_3, v_4\}), ((\eta_5, u, 0), \{v_1, v_2, v_3\}) \end{array} \right\}.$$

Definition 8. Hypersoft Expert Subset

A hse-set $(\mathcal{U}_1, F) \subseteq (\mathcal{U}_2, \overline{\mathcal{T}})$ over $\tilde{\Omega}$, if

(i) $F \subseteq \overline{\mathcal{T}}$, (ii) $\forall o \in F, \mathcal{U}_1(o) \subseteq \mathcal{U}_2(o)$ and shown by $(\mathcal{U}_1, F) \subseteq (\mathcal{U}_2, \overline{\mathcal{T}})$.

Example 3.2. Considering Example 3.1, suppose

$$\mathcal{E}_1 = \{ (\eta_1, s, 1), (\eta_3, s, 0), (\eta_1, t, 1), (\eta_3, t, 1), (\eta_3, t, 0), (\eta_1, u, 0), (\eta_3, u, 1) \}$$

$$\mathcal{E}_2 = \left\{ \begin{array}{l} (\eta_1, s, 1), (\eta_3, s, 0), (\eta_3, s, 1), (\eta_1, t, 1), (\eta_3, t, 1), \\ (\eta_5, t, 0), (\eta_3, t, 0), (\eta_1, u, 0), (\eta_3, u, 1), (\eta_5, u, 1) \end{array} \right\}.$$

$\Rightarrow \mathbb{A}_1 \subset \mathbb{A}_2$. Suppose $(\mathcal{U}_1, \mathbb{A}_1)$ and $(\mathcal{U}_2, \mathbb{A}_2)$ be two hse-sets

$$(\mathcal{U}_1, \mathbb{A}_1) = \left\{ \begin{array}{l} ((\eta_1, s, 1), \{v_1, v_2\}), ((\eta_1, t, 1), \{v_1\}), \\ ((\eta_3, t, 1), \{v_1, v_3\}), ((\eta_3, u, 1), \{v_1, v_2\}), \\ ((\eta_1, u, 0), \{v_1\}), ((\eta_3, s, 0), \{v_1, v_2\}), \\ ((\eta_3, t, 0), \{v_2, v_4\}) \end{array} \right\}$$

$$(\mathcal{U}_2, \mathbb{A}_2) = \left\{ \begin{array}{l} ((\eta_1, s, 1), \{v_1, v_2, v_4\}), ((\eta_1, t, 1), \{v_1, v_4\}), \\ ((\eta_3, s, 1), \{v_4\}), ((\eta_3, t, 1), \{v_1, v_3\}), \\ ((\eta_5, u, 1), \{v_4\}), ((\eta_3, u, 1), \{v_1, v_2, v_4\}), \\ ((\eta_1, u, 0), \{v_1, v_2\}), ((\eta_5, t, 0), \{v_3, v_4\}), \\ ((\eta_3, s, 0), \{v_1, v_2, v_3\}), ((\eta_3, t, 0), \{v_2, v_4\}) \end{array} \right\}$$

$\Rightarrow (\mathcal{U}_1, \mathbb{A}_1) \subseteq (\mathcal{U}_2, \mathbb{A}_2)$.

Definition 9. Two hse-sets $(\mathcal{U}_1, \delta_1)$ and $(\mathcal{U}_2, \delta_2)$ will be equal if $(\mathcal{U}_1, \delta_1) \subseteq (\mathcal{U}_2, \delta_2)$ and $(\mathcal{U}_2, \delta_2) \subseteq (\mathcal{U}_1, \delta_1)$.

Definition 10. The NOT set of $\Pi = \Lambda \times \Upsilon \times \Gamma$ denoted by $\sim \Lambda$, is shown as $\sim \Lambda = \{(\sim o_i, a_j, v_k) \forall i, j, k\}$ with $\sim o_i$ is not o_i .

Definition 11. Let (\mathcal{U}, F) be a hse-set, then its compliment is defined by $(\mathcal{U}, F)^c = (\mathcal{U}^c, \sim F)$ such that $\mathcal{U}^c : \sim F \rightarrow P(\tilde{\Omega})$ is represented by $\mathcal{U}^c(o) = \tilde{\Omega} - \mathcal{U}(\sim o)$, for $o \in \sim F$.

Example 3.3. We can find the compliment of hse-set in Example 3.1, as

$$(\mathcal{U}, F)^c = \left\{ \begin{array}{l} ((\sim \eta_1, s, 1), \{v_3\}), ((\sim \eta_1, t, 1), \{v_2, v_3\}), ((\sim \eta_1, u, 1), \{v_1, v_2\}), \\ ((\sim \eta_3, s, 1), \{v_1, v_2, v_3\}), ((\sim \eta_3, t, 1), \{v_2, v_4\}), ((\sim \eta_3, u, 1), \{v_1, v_2, v_4\}), \\ ((\sim \eta_5, s, 1), \{v_1, v_2\}), ((\sim \eta_5, t, 1), \{v_3, v_4\}), ((\sim \eta_5, u, 1), \{v_1, v_2, v_3\}), \\ ((\sim \eta_1, s, 0), \{v_1, v_2, v_4\}), ((\sim \eta_1, t, 0), \{v_1, v_4\}), ((\sim \eta_1, u, 0), \{v_1, v_2\}), \\ ((\sim \eta_3, s, 0), \{v_4\}), ((\sim \eta_3, t, 0), \{v_1, v_3\}), ((\sim \eta_3, u, 0), \{v_3\}), \\ ((\sim \eta_5, s, 0), \{v_3, v_4\}), ((\sim \eta_5, t, 0), \{v_1, v_3\}), ((\sim \eta_5, u, 0), \{v_4\}) \end{array} \right\}.$$

Definition 12. Let (\mathcal{U}, F) is a hse-set, then its relative compliment is $(\mathcal{U}, F)^* = (\mathcal{U}^*, F)$ with $\mathcal{U}^* : F \rightarrow P(\tilde{\Omega})$, as well as $\mathcal{U}^*(o) = \tilde{\Omega} - \mathcal{U}(o)$ for all $o \in F$.

Example 3.4. We can find the relative compliment of hse-set in Example 3.1, as

$$(\mathcal{U}, F)^* = \left\{ \begin{array}{l} ((\eta_1, s, 1), \{v_3\}), ((\eta_1, t, 1), \{v_2, v_3\}), ((\eta_1, u, 1), \{v_1, v_2\}), \\ ((\eta_3, s, 1), \{v_1, v_2, v_3\}), ((\eta_3, t, 1), \{v_2, v_4\}), ((\eta_3, u, 1), \{v_1, v_2, v_4\}), \\ ((\eta_5, s, 1), \{v_1, v_2\}), ((\eta_5, t, 1), \{v_3, v_4\}), ((\eta_5, u, 1), \{v_1, v_2, v_3\}), \\ ((\eta_1, s, 0), \{v_1, v_2, v_4\}), ((\eta_1, t, 0), \{v_1, v_4\}), ((\eta_1, u, 0), \{v_1, v_2\}), \\ ((\eta_3, s, 0), \{v_4\}), ((\eta_3, t, 0), \{v_1, v_3\}), ((\eta_3, u, 0), \{v_3\}), \\ ((\eta_5, s, 0), \{v_3, v_4\}), ((\eta_5, t, 0), \{v_1, v_3\}), ((\eta_5, u, 0), \{v_4\}) \end{array} \right\}.$$

Definition 13. Suppose (\mathcal{U}, F) be a hse-set, then the following properties hold:

- (1) $((\mathcal{U}, F)^c)^c = (\mathcal{U}, F)$
- (2) $((\mathcal{U}, F)^*)^* = (\mathcal{U}, F)$
- (3) $((\mathcal{U}_1, F_1)_{\tilde{\Omega}})^c = (\mathcal{U}_1, F_1)_{\Phi} = ((\mathcal{U}_1, F_1)_{\tilde{\Omega}})^*$ with $F_1 \subseteq F$.
- (4) $((\mathcal{U}_1, F_1)_{\Phi})^c = (\mathcal{U}_1, F_1)_{\tilde{\Omega}} = ((\mathcal{U}_1, F_1)_{\Phi})^*$ with $F_1 \subseteq F$.

Definition 14. A hse-set (\mathcal{U}, F_1) is called a relative null hse-set with respect to $F_1 \subset F$, denoted by $(\mathcal{U}, F_1)_{\tilde{\Omega}}$, if $\mathcal{U}(o) = \emptyset, \forall o \in F_1$.

Example 3.5. Taking Example 3.2, if $(\mathcal{U}, F_1)_{\tilde{\Omega}} = \{((\eta_1, s, 1), \emptyset), ((\eta_1, t, 1), \emptyset), ((\eta_1, u, 1), \emptyset)\}$, where $F_1 \subseteq F$.

Definition 15. A hse-set (\mathcal{U}, F_2) is called a relative whole hse-set with respect to $F_2 \subset F$, denoted by $(\mathcal{U}, F_2)_{\tilde{\Omega}}$, if $\mathcal{U}(o) = \tilde{\Omega}, \forall o \in F_2$.

Example 3.6. Taking Example 3.2, if $(\mathcal{U}, F_2)_{\tilde{\Omega}} = \{((\eta_2, s, 1), \tilde{\Omega}), ((\eta_2, t, 1), \tilde{\Omega}), ((\eta_2, u, 1), \tilde{\Omega})\}$, where $F_2 \subseteq F$.

Definition 16. A hse-set (\mathcal{U}, F) is called absolute whole hse-set shown by $(\mathcal{U}, F)_{\tilde{\Omega}}$, if $\mathcal{U}(o) = \tilde{\Omega}, \forall o \in F$.

Example 3.7. Taking Example 3.2, if $(\mathcal{U}, F)_{\tilde{\Omega}} =$

$$\left\{ \begin{array}{l} \left((\eta_1, s, 1), \tilde{\Omega} \right), \left((\eta_1, t, 1), \tilde{\Omega} \right), \left((\eta_1, u, 1), \tilde{\Omega} \right), \left((\eta_3, s, 1), \tilde{\Omega} \right), \left((\eta_3, t, 1), \tilde{\Omega} \right), \left((\eta_3, u, 1), \tilde{\Omega} \right), \\ \left((\eta_5, s, 1), \tilde{\Omega} \right), \left((\eta_5, t, 1), \tilde{\Omega} \right), \left((\eta_5, u, 1), \tilde{\Omega} \right), \left((\eta_1, s, 0), \tilde{\Omega} \right), \left((\eta_1, t, 0), \tilde{\Omega} \right), \left((\eta_1, u, 0), \tilde{\Omega} \right), \\ \left((\eta_3, s, 0), \tilde{\Omega} \right), \left((\eta_3, t, 0), \tilde{\Omega} \right), \left((\eta_3, u, 0), \tilde{\Omega} \right), \left((\eta_5, s, 0), \tilde{\Omega} \right), \left((\eta_5, t, 0), \tilde{\Omega} \right), \left((\eta_5, u, 0), \tilde{\Omega} \right) \end{array} \right\}.$$

Proposition 3.8. Suppose $(\mathcal{U}_1, F_1)_{\tilde{\Omega}}, (\mathcal{U}_2, F_2)_{\tilde{\Omega}}, (\mathcal{U}_3, F_3)_{\tilde{\Omega}}$, be three hse-sets over $\tilde{\Omega}$, then following properties hold:

- (1) $(\mathcal{U}_1, F_1) \subset (\mathcal{U}_2, F_2)_{\tilde{\Omega}}$
- (2) $(\mathcal{U}_1, F_1)_{\Phi} \subset (\mathcal{U}_1, F_1)$
- (3) $(\mathcal{U}_1, F_1) \subset (\mathcal{U}_1, F_1)$
- (4) If $(\mathcal{U}_1, F_1) \subset (\mathcal{U}_2, F_2)$, and $(\mathcal{U}_2, F_2) \subset (\mathcal{U}_3, F_3)$, then $(\mathcal{U}_1, F_1) \subset (\mathcal{U}_3, F_3)$
- (5) If $(\mathcal{U}_1, F_1) = (\mathcal{U}_2, F_2)$, and $(\mathcal{U}_2, F_2) = (\mathcal{U}_3, F_3)$, then $(\mathcal{U}_1, F_1) = (\mathcal{U}_3, F_3)$.

Definition 17. An Agree-hse-set $(\mathcal{U}, F)_{ag}$ is a hse-subset of (\mathcal{U}, F) and is characterized as $(\mathcal{U}, F)_{ag} = \{\mathcal{U}_{ag}(o) : o \in \Lambda \times \Upsilon \times \{1\}\}$.

Example 3.9. We can find Agree-hse-set using Example 3.1, we get

$$(\mathcal{U}, F) = \left\{ \begin{array}{l} ((\eta_1, s, 1), \{v_1, v_2, v_4\}), ((\eta_1, t, 1), \{v_1, v_4\}), ((\eta_1, u, 1), \{v_3, v_4\}), \\ ((\eta_3, s, 1), \{v_4\}), ((\eta_3, t, 1), \{v_1, v_3\}), ((\eta_3, u, 1), \{v_1, v_2, v_4\}), \\ ((\eta_5, s, 1), \{v_3, v_4\}), ((\eta_5, t, 1), \{v_1, v_2\}), ((\eta_5, u, 1), \{v_4\}) \end{array} \right\}.$$

Definition 18. A Disagree-hse-set $(\mathcal{U}, F)_{dag}$ over $\tilde{\Omega}$, is a hse-subset of (\mathcal{U}, F) and is characterized as $(\mathcal{U}, F)_{dag} = \{\mathcal{U}_{dag}(o) : o \in \Lambda \times \Upsilon \times \{0\}\}$.

Example 3.10. We can find Disagree-hse-set in Example 3.1,

$$(\mathcal{U}, F) = \left\{ \begin{array}{l} ((\eta_1, s, 0), \{v_3\}), ((\eta_1, t, 0), \{v_2, v_3\}), ((\eta_1, u, 0), \{v_1, v_2\}), \\ ((\eta_3, s, 0), \{v_1, v_2, v_3\}), ((\eta_3, t, 0), \{v_2, v_4\}), ((\eta_3, u, 0), \{v_3\}), \\ ((\eta_5, s, 0), \{v_1, v_2\}), ((\eta_5, t, 0), \{v_3, v_4\}), ((\eta_5, u, 0), \{v_1, v_2, v_3\}) \end{array} \right\}.$$

Proposition 3.11. Consider a hse-subset (\mathcal{U}, F) on $\tilde{\Omega}$, then following properties hold:

- (1) $((\mathcal{U}, F)^c)^c = (\mathcal{U}, F)$
- (2) $(\mathcal{U}, F)_{ag}^c = (\mathcal{U}, F)_{dag}$
- (3) $(\mathcal{U}, F)_{dag}^c = (\mathcal{U}, F)_{ag}$.

Definition 19. The union of (\mathcal{U}_1, F) and (\mathcal{U}_2, \neg) over $\tilde{\Omega}$ is $(\mathcal{U}_3, \sqsupset)$ with $\sqsupset = F \cup \neg$, defined as

$$\mathcal{U}_3(o) = \begin{cases} \mathcal{U}_1(o) & ; o \in F - \neg \\ \mathcal{U}_2(o) & ; o \in \neg - F \\ \mathcal{U}_1(o) \cup \mathcal{U}_2(o) & ; o \in F \cap \neg. \end{cases}$$

Example 3.12. Taking Example 3.1, and two sets

$$\mathcal{A}_1 = \left\{ (\eta_1, s, 1), (a_3, s, 0), (a_3, s, 1), (\eta_1, t, 1), (a_3, t, 1), \right. \\ \left. (a_5, t, 0), (a_3, t, 0), (\eta_1, u, 0), (a_3, u, 1), (a_5, u, 1) \right\}$$

$$\mathcal{A}_2 = \{ (\eta_1, s, 1), (a_3, s, 0), (a_3, s, 1), (\eta_1, t, 1), (a_3, t, 1), (a_5, t, 0), (a_3, t, 0), (\eta_1, u, 0), (a_3, u, 1) \}.$$

Consider two two hse-sets $(\mathcal{U}_1, \mathcal{A}_1)$ and $(\mathcal{U}_2, \mathcal{A}_2)$ on $\tilde{\Omega}$

$$(\mathcal{U}_1, \mathcal{A}_1) = \left\{ \begin{array}{l} ((\eta_1, s, 1), \{v_1, v_2\}), ((\eta_1, t, 1), \{v_1\}), ((\eta_3, t, 1), \{v_1, v_3\}), \\ ((\eta_3, u, 1), \{v_1, v_2\}), ((\eta_1, u, 0), \{v_1\}), ((\eta_3, s, 0), \{v_1, v_2\}), \\ ((\eta_3, t, 0), \{v_2, v_4\}) \end{array} \right\}$$

$$(\mathcal{U}_2, \mathcal{A}_2) = \left\{ \begin{array}{l} ((\eta_1, s, 1), \{v_1, v_2, v_4\}), ((\eta_1, t, 1), \{v_1, v_4\}), ((\eta_3, s, 1), \{v_4\}), ((\eta_3, t, 1), \{v_1, v_3\}), \\ ((\eta_5, u, 1), \{v_4\}), ((\eta_3, u, 1), \{v_1, v_2, v_4\}), ((\eta_1, u, 0), \{v_1, v_2\}), ((\eta_5, t, 0), \{v_3, v_4\}), \\ ((\eta_3, s, 0), \{v_1, v_2, v_3\}), ((\eta_3, t, 0), \{v_2, v_4\}) \end{array} \right\}.$$

Then $(\mathcal{U}_1, \mathcal{A}_1) \cup (\mathcal{U}_2, \mathcal{A}_2) = (\mathcal{U}_3, \mathcal{A}_3)$

$$\left\{ \begin{array}{l} ((\eta_1, s, 1), \{v_1, v_2, v_4\}), ((\eta_1, t, 1), \{v_1, v_4\}), ((\eta_3, s, 1), \{v_4\}), ((\eta_3, t, 1), \{v_1, v_3\}), \\ ((\eta_5, u, 1), \{v_4\}), ((\eta_3, u, 1), \{v_1, v_2, v_4\}), ((\eta_1, u, 0), \{v_1, v_2\}), ((\eta_5, t, 0), \{v_3, v_4\}), \\ ((\eta_3, s, 0), \{v_1, v_2, v_3\}), ((\eta_3, t, 0), \{v_2, v_4\}) \end{array} \right\}.$$

Definition 20. Restricted Union of two hse-sets $(\mathcal{U}_1, \mathcal{A}_1)$, $(\mathcal{U}_2, \mathcal{A}_2)$ over $\tilde{\Omega}$ is $(\mathcal{U}_3, \mathcal{C})$ with $\mathcal{C} = \mathcal{A}_1 \cap \mathcal{A}_2$, defined as $\mathcal{U}_3(o) = \mathcal{U}_1(o) \cup_R \mathcal{U}_2(o)$ for all $o \in \mathcal{A}_1 \cap \mathcal{A}_2$.

Example 3.13. Dealing Example 3.1 with two sets

$$\mathcal{A}_1 = \left\{ (\eta_1, s, 1), (\eta_3, s, 0), (\eta_3, s, 1), (\eta_1, t, 1), (\eta_3, t, 1), \right. \\ \left. (\eta_5, t, 0), (\eta_3, t, 0), (\eta_1, u, 0), (\eta_3, u, 1), (\eta_5, u, 1) \right\}$$

$$\mathcal{A}_2 = \left\{ (\eta_1, s, 1), (\eta_3, s, 0), (\eta_3, s, 1), (\eta_1, t, 1), (\eta_3, t, 1), \right. \\ \left. (\eta_5, t, 0), (\eta_3, t, 0), (\eta_1, u, 0), (\eta_3, u, 1) \right\}.$$

Consider two hse-sets

$$(\mathcal{U}_1, \mathcal{A}_1) = \left\{ \begin{array}{l} ((\eta_1, s, 1), \{v_1, v_2\}), ((\eta_1, t, 1), \{v_1\}), ((\eta_3, t, 1), \{v_1, v_3\}), \\ ((\eta_3, u, 1), \{v_1, v_2\}), ((\eta_1, u, 0), \{v_1\}), ((\eta_3, s, 0), \{v_1, v_2\}), \\ ((\eta_3, t, 0), \{v_2, v_4\}), ((\eta_5, u, 1), \{v_4\}), ((\eta_5, t, 0), \{v_3\}) \\ ((\eta_3, s, 1), \{v_3, v_4\}) \end{array} \right\}$$

$$(\mathcal{U}_2, \mathcal{A}_2) = \left\{ \begin{array}{l} ((\eta_1, s, 1), \{v_1, v_2, v_4\}), ((\eta_1, t, 1), \{v_1, v_4\}), \\ ((\eta_3, s, 1), \{v_4\}), ((\eta_3, t, 1), \{v_1, v_3\}), \\ ((\eta_3, u, 1), \{v_1, v_2, v_4\}), ((\eta_1, u, 0), \{v_1, v_2\}), ((\eta_5, t, 0), \{v_3, v_4\}), \\ ((\eta_3, s, 0), \{v_1, v_2, v_3\}), ((\eta_3, t, 0), \{v_2, v_4\}) \end{array} \right\}.$$

Then $(\mathcal{U}_1, \mathcal{A}_1) \cup_R (\mathcal{U}_2, \mathcal{A}_2) = (\mathcal{U}_3, \mathcal{E})$

$$(\mathcal{U}_3, \mathcal{E}) = \left\{ \begin{array}{l} ((\eta_1, s, 1), \{v_1, v_2, v_4\}), ((\eta_1, t, 1), \{v_1, v_4\}), \\ ((\eta_3, s, 1), \{v_4\}), ((\eta_3, t, 1), \{v_1, v_3\}), \\ ((\eta_3, u, 1), \{v_1, v_2, v_4\}), \\ ((\eta_1, u, 0), \{v_1, v_2\}), ((\eta_5, t, 0), \{v_3, v_4\}), \\ ((\eta_3, s, 0), \{v_1, v_2, v_3\}), ((\eta_3, t, 0), \{v_2, v_4\}) \end{array} \right\}.$$

Proposition 3.14. Consider three hse-sets $(\mathcal{U}_1, \mathcal{A}_1), (\mathcal{U}_2, \mathcal{A}_2)$ and $(\mathcal{U}_3, \mathcal{A}_3)$ on $\tilde{\Omega}$, then

- (1) $(\mathcal{U}_1, \mathcal{A}_1) \cup (\mathcal{U}_2, \mathcal{A}_2) = (\mathcal{U}_2, \mathcal{A}_2) \cup (\mathcal{U}_1, \mathcal{A}_1)$
- (2) $((\mathcal{U}_1, \mathcal{A}_1) \cup (\mathcal{U}_2, \mathcal{A}_2)) \cup (\mathcal{U}_3, \mathcal{A}_3) = (\mathcal{U}_1, \mathcal{A}_1) \cup ((\mathcal{U}_2, \mathcal{A}_2) \cup (\mathcal{U}_3, \mathcal{A}_3)).$

Definition 21. The intersection of $(\mathcal{U}_1, \mathcal{A}_1)$ and $(\mathcal{U}_2, \mathcal{A}_2)$ over $\tilde{\Omega}$ is $(\mathcal{U}_3, \mathcal{E})$ with $\mathcal{E} = \mathcal{A}_1 \cap \mathcal{A}_2$, defined as $\mathcal{U}_3(o) = \mathcal{U}_1(o) \cap \mathcal{U}_2(o)$ for all $o \in \mathcal{A}_1 \cap \mathcal{A}_2$.

Example 3.15. Dealing Example 3.1, and following two sets

$$\mathcal{A}_1 = \left\{ (\eta_1, s, 1), (\eta_3, s, 0), (\eta_3, s, 1), (\eta_1, t, 1), (\eta_3, t, 1), (\eta_5, t, 0), (\eta_3, t, 0), (\eta_1, u, 0), (\eta_3, u, 1), (\eta_5, u, 1) \right\}$$

$$\mathcal{A}_2 = \left\{ (\eta_1, s, 1), (\eta_3, s, 0), (\eta_3, s, 1), (\eta_1, t, 1), (\eta_3, t, 1), (\eta_5, t, 0), (\eta_3, t, 0), (\eta_1, u, 0), (\eta_3, u, 1) \right\}.$$

Consider two hse-sets over $\tilde{\Omega}$, then

$$(\mathcal{U}_1, \mathcal{A}_1) = \left\{ \begin{array}{l} ((\eta_1, s, 1), \{v_1, v_2\}), ((\eta_1, t, 1), \{v_1\}), ((\eta_3, t, 1), \{v_1, v_3\}), \\ ((\eta_3, u, 1), \{v_1, v_2\}), ((\eta_1, u, 0), \{v_1\}), ((\eta_3, s, 0), \{v_1, v_2\}), \\ ((\eta_3, t, 0), \{v_2, v_4\}), ((\eta_5, u, 1), \{v_4\}), ((\eta_5, t, 0), \{v_3\}) \\ ((\eta_3, s, 1), \{v_3, v_4\}) \end{array} \right\}$$

$$(\mathcal{U}_2, \mathcal{A}_2) = \left\{ \begin{array}{l} ((\eta_1, s, 1), \{v_1, v_2, v_4\}), ((\eta_1, t, 1), \{v_1, v_4\}), \\ ((\eta_3, s, 1), \{v_4\}), ((\eta_3, t, 1), \{v_1, v_3\}), ((\eta_3, u, 1), \{v_1, v_2, v_4\}) \\ ((\eta_1, u, 0), \{v_1, v_2\}), ((\eta_5, t, 0), \{v_3, v_4\}), \\ ((\eta_3, s, 0), \{v_1, v_2, v_3\}), ((\eta_3, t, 0), \{v_2, v_4\}) \end{array} \right\}.$$

Then $(\mathcal{U}_1, \mathcal{A}_1) \cap (\mathcal{U}_2, \mathcal{A}_2) = (\mathcal{U}_3, \mathcal{A}_3)$

$$\left\{ \begin{array}{l} ((\eta_1, s, 1), \{v_1, v_2\}), ((\eta_1, t, 1), \{v_1\}), ((\eta_3, t, 1), \{v_1, v_3\}), ((\eta_3, u, 1), \{v_1, v_2\}), \\ ((\eta_1, u, 0), \{v_1\}), ((\eta_3, s, 0), \{v_1, v_2\}), ((\eta_3, t, 0), \{v_2, v_4\}), ((\eta_3, s, 1), \{v_4\}) \\ ((\eta_5, t, 0), \{v_3\}), \end{array} \right\}.$$

Definition 22. Extended intersection of two hse-sets (\mathcal{U}_1, F) and $(\mathcal{U}_2, \mathcal{T})$ is $(\mathcal{U}_3, \mathcal{Q})$ with $\mathcal{Q} = F \cup \mathcal{T}$, and

$$\mathcal{U}_3(o) = \left\{ \begin{array}{ll} \mathcal{U}_1(o) & ; o \in F - \mathcal{T} \\ \mathcal{U}_2(o) & ; o \in \mathcal{T} - F \\ \mathcal{U}_1(o) \cap \mathcal{U}_2(o) & ; o \in F \cap \mathcal{T}. \end{array} \right.$$

Example 3.16. By utilizing Example 3.1, and with two sets

$$\mathcal{A}_1 = \left\{ (\eta_1, s, 1), (\eta_3, s, 0), (\eta_3, s, 1), (\eta_1, t, 1), (\eta_3, t, 1), (\eta_5, t, 0), (\eta_3, t, 0), (\eta_1, u, 0), (\eta_3, u, 1), (\eta_5, u, 1) \right\}$$

$$\mathbb{A}_2 = \left\{ \begin{array}{l} (\eta_1, s, 1), (\eta_3, s, 0), (\eta_3, s, 1), (\eta_1, t, 1), (\eta_3, t, 1), \\ (\eta_5, t, 0), (\eta_3, t, 0), (\eta_1, u, 0), (\eta_3, u, 1) \end{array} \right\}$$

Suppose $(\mathcal{U}_1, \mathbb{A}_1)$ and $(\mathcal{U}_2, \mathbb{A}_2)$ are two hse-sets

$$(\mathcal{U}_1, \mathbb{A}_1) = \left\{ \begin{array}{l} ((\eta_1, s, 1), \{v_1, v_2\}), ((\eta_1, t, 1), \{v_1\}), ((\eta_3, t, 1), \{v_1, v_3\}), \\ ((\eta_3, u, 1), \{v_1, v_2\}), ((\eta_1, u, 0), \{v_1\}), ((\eta_3, s, 0), \{v_1, v_2\}), \\ ((\eta_3, t, 0), \{v_2, v_4\}), ((\eta_5, u, 1), \{v_4\}), ((\eta_5, t, 0), \{v_3\}) \\ ((\eta_3, s, 1), \{v_3, v_4\}) \end{array} \right\}$$

$$(\mathcal{U}_2, \mathbb{A}_2) = \left\{ \begin{array}{l} ((\eta_1, s, 1), \{v_1, v_2\}), ((\eta_1, t, 1), \{v_1\}), ((\eta_5, t, 0), \{v_3, v_4\}), \\ ((\eta_3, s, 1), \{v_4\}), ((\eta_3, t, 1), \{v_1, v_3\}), \\ ((\eta_3, u, 1), \{v_1, v_2, v_4\}), ((\eta_1, u, 0), \{v_1, v_2\}), \\ ((\eta_3, s, 0), \{v_1, v_2, v_3\}), ((\eta_3, t, 0), \{v_2, v_4\}) \end{array} \right\}$$

Then $(\mathcal{U}_1, \mathbb{A}_1) \cap_E (\mathcal{U}_2, \mathbb{A}_2) = (\mathcal{U}_3, \mathcal{A})$

$$\left\{ \begin{array}{l} ((\eta_1, s, 1), \{v_1, v_2\}), ((\eta_1, t, 1), \{v_1\}), ((\eta_3, t, 1), \{v_1, v_3\}), ((\eta_3, u, 1), \{v_1, v_2\}), \\ ((\eta_1, u, 0), \{v_1\}), ((\eta_3, s, 0), \{v_1, v_2\}), ((\eta_3, t, 0), \{v_2, v_4\}), ((\eta_5, t, 0), \{v_3\}), \\ ((\eta_5, u, 1), \{v_4\}), ((\eta_3, s, 1), \{v_4\}) \end{array} \right\}.$$

Proposition 3.17. Consider three hse-sets $(\mathcal{U}_1, \mathbb{A}_1), (\mathcal{U}_2, \mathbb{A}_2)$ and $(\mathcal{U}_3, \mathbb{A}_3)$ over $\tilde{\Omega}$, then

- (1) $(\mathcal{U}_1, \mathbb{A}_1) \cap (\mathcal{U}_2, \mathbb{A}_2) = (\mathcal{U}_2, \mathbb{A}_2) \cap (\mathcal{U}_1, \mathbb{A}_1)$
- (2) $((\mathcal{U}_1, \mathbb{A}_1) \cap (\mathcal{U}_2, \mathbb{A}_2)) \cap (\mathcal{U}_3, \mathbb{A}_3) = (\mathcal{U}_1, \mathbb{A}_1) \cap ((\mathcal{U}_2, \mathbb{A}_2) \cap (\mathcal{U}_3, \mathbb{A}_3)).$

Proposition 3.18. Consider three hse-sets $(\mathcal{U}_1, \mathbb{A}_1), (\mathcal{U}_2, \mathbb{A}_2)$ and $(\mathcal{U}_3, \mathbb{A}_3)$ over $\tilde{\Omega}$, then

- (1) $(\mathcal{U}_1, \mathbb{A}_1) \cup ((\mathcal{U}_2, \mathbb{A}_2) \cap (\mathcal{U}_3, \mathbb{A}_3)) = ((\mathcal{U}_1, \mathbb{A}_1) \cup ((\mathcal{U}_2, \mathbb{A}_2)) \cap ((\mathcal{U}_1, \mathbb{A}_1) \cup (\mathcal{U}_3, \mathbb{A}_3))$
- (2) $(\mathcal{U}_1, \mathbb{A}_1) \cap ((\mathcal{U}_2, \mathbb{A}_2) \cup (\mathcal{U}_3, \mathbb{A}_3)) = ((\mathcal{U}_1, \mathbb{A}_1) \cap ((\mathcal{U}_2, \mathbb{A}_2)) \cup ((\mathcal{U}_1, \mathbb{A}_1) \cap (\mathcal{U}_3, \mathbb{A}_3)).$

Definition 23. Let $(\mathcal{U}_1, \mathbb{A}_1)$ and $(\mathcal{U}_2, \mathbb{A}_2)$ are two hse-sets then $(\mathcal{U}_1, \mathbb{A}_1)$ AND $(\mathcal{U}_2, \mathbb{A}_2)$ shown as $(\mathcal{U}_1, \mathbb{A}_1) \wedge (\mathcal{U}_2, \mathbb{A}_2)$ and can be defined as $(\mathcal{U}_1, \mathbb{A}_1) \wedge (\mathcal{U}_2, \mathbb{A}_2) = (\mathcal{U}_3, \mathbb{A}_1 \times \mathbb{A}_2)$, with $\mathcal{U}_3(\beta, \gamma) = \mathcal{U}_1(\beta) \cap \mathcal{U}_2(\gamma), \forall (\beta, \gamma) \in \mathbb{A}_1 \times \mathbb{A}_2$.

Example 3.19. Taking Example 3.1, let two sets

$$\mathbb{A}_1 = \{ (\eta_1, s, 1), (\eta_1, t, 1), (\eta_3, s, 1), (\eta_3, s, 0) \}, \mathbb{A}_2 = \{ (\eta_1, s, 1), (\eta_3, s, 0), (\eta_3, s, 1) \}.$$

Consider two hse-sets

$$(\mathcal{U}_1, \mathbb{A}_1) = \{ ((\eta_1, s, 1), \{v_1, v_2\}), ((\eta_1, t, 1), \{v_1\}), ((\eta_3, s, 1), \{v_4\}), ((\eta_3, s, 0), \{v_1, v_2\}), \}$$

and

$$(\mathcal{U}_2, \mathbb{A}_2) = \{ ((\eta_1, s, 1), \{v_1, v_2, v_4\}), ((\eta_3, s, 0), \{v_1, v_2, v_3\}) \}$$

Then $(\mathcal{U}_1, \mathbb{A}_1) \wedge (\mathcal{U}_2, \mathbb{A}_2) = (\mathcal{U}_3, \mathbb{A}_1 \times \mathbb{A}_2)$

$$\left\{ \begin{array}{l} (((\eta_1, s, 1), (\eta_1, s, 1)), \{v_1, v_2\}), (((\eta_1, s, 1), (\eta_3, s, 0)), \{v_1, v_2\}), \\ (((\eta_1, t, 1), (\eta_1, s, 1)), \{v_1\}), (((\eta_1, t, 1), (\eta_3, s, 0)), \{v_1\}), \\ (((\eta_3, s, 1), (\eta_1, s, 1)), \{v_4\}), (((\eta_3, s, 1), (\eta_3, s, 0)), \phi), \\ (((\eta_3, s, 0), (\eta_1, s, 1)), \{v_1, v_2\}), (((\eta_3, s, 0), (\eta_3, s, 0)), \{v_1, v_2\}), \end{array} \right\}.$$

Definition 24. Consider two hse-sets $(\mathcal{U}_1, \mathcal{A}_1)$ and $(\mathcal{U}_2, \mathcal{A}_2)$, then $(\mathcal{U}_1, \mathcal{A}_1)$ OR $(\mathcal{U}_2, \mathcal{A}_2)$ shown as $(\mathcal{U}_1, \mathcal{A}_1) \vee (\mathcal{U}_2, \mathcal{A}_2)$ can be defined as $(\mathcal{U}_1, \mathcal{A}_1) \vee (\mathcal{U}_2, \mathcal{A}_2) = (\mathcal{U}_3, \mathcal{A}_1 \times \mathcal{A}_2)$, with $\mathcal{U}_3(\beta, \gamma) = \mathcal{U}_1(\beta) \cup \mathcal{U}_2(\gamma), \forall (\beta, \gamma) \in \mathcal{A}_1 \times \mathcal{A}_2$.

Example 3.20. Dealing Example 3.1, and with sets

$$\mathcal{A}_1 = \{ (\eta_1, s, 1), (\eta_1, t, 1), (a_3, s, 1), (a_3, s, 0) \}, \mathcal{A}_2 = \{ (\eta_1, s, 1), (a_3, s, 0), (a_3, s, 1) \}.$$

Consider two hse-sets

$$(\mathcal{U}_1, \mathcal{A}_1) = \{ ((a_1, s, 1), \{v_1, v_2\}), ((a_1, t, 1), \{v_1\}), ((a_3, s, 1), \{v_4\}), ((a_3, s, 0), \{v_1, v_2\}) \}$$

and

$$(\mathcal{U}_2, \mathcal{A}_2) = \{ ((a_1, s, 1), \{v_1, v_2, v_4\}), ((a_3, s, 0), \{v_1, v_2, v_3\}) \}$$

Then $(\mathcal{U}_1, \mathcal{A}_1) \vee (\mathcal{U}_2, \mathcal{A}_2) = (\mathcal{U}_3, \mathcal{A}_1 \times \mathcal{A}_2)$

$$\left\{ \begin{array}{l} ((a_1, s, 1), (a_1, s, 1)), \{v_1, v_2, v_4\}, ((a_1, s, 1), (a_3, s, 0)), \{v_1, v_2, v_3\}, \\ ((a_1, t, 1), (a_1, s, 1)), \{v_1, v_2, v_4\}, ((a_1, t, 1), (a_3, s, 0)), \{v_1, v_2\}, \\ ((a_3, s, 1), (a_1, s, 1)), \{v_1, v_2, v_4\}, ((a_3, s, 1), (a_3, s, 0)), \{v_1, v_2, v_3, v_4\}, \\ ((a_3, s, 0), (a_1, s, 1)), \{v_1, v_2, v_4\}, ((a_3, s, 0), (a_3, s, 0)), \{v_1, v_2, v_3\}. \end{array} \right\}.$$

Definition 25. Restricted Difference of two hse-sets $(\partial_1, \mathcal{A}_1)$ and $(\partial_2, \mathcal{A}_2)$ over $\tilde{\Omega}$, shown by $(\partial_1, \mathcal{A}_1) \setminus_R (\mathcal{U}_2, \mathcal{A}_2)$, is a hse-set $(\partial_3, \mathcal{A}_3)$ with $\mathcal{A}_3 = \mathcal{A}_1 \cap \mathcal{A}_2$
 $\partial_3(o) = \partial_1(o) \setminus \partial_2(o)$ for $o \in \mathcal{A}_3$.

Example 3.21. Dealing Example 3.1, and with sets

$$\mathcal{A}_1 = \{ (\eta_1, s, 1), (\eta_1, t, 1), (a_3, s, 1), (a_3, s, 0) \}, \mathcal{A}_2 = \{ (\eta_1, s, 1), (a_3, s, 0) \}.$$

Consider two hse-sets $(\mathcal{U}_1, \mathcal{A}_1)$ and $(\mathcal{U}_2, \mathcal{A}_2)$, then

$$(\mathcal{U}_1, \mathcal{A}_1) = \{ ((a_1, s, 1), \{v_1, v_2, v_4\}), ((a_1, t, 1), \{v_1\}), ((a_3, s, 1), \{v_4\}), ((a_3, s, 0), \{v_1, v_2, v_3\}), \}$$

$$(\mathcal{U}_2, \mathcal{A}_2) = \{ ((a_1, s, 1), \{v_1, v_2\}), ((a_3, s, 0), \{v_1, v_2\}) \}.$$

$$(\mathcal{U}_1, \mathcal{A}_1) \setminus_R (\mathcal{U}_2, \mathcal{A}_2) = (\mathcal{U}_3, \mathcal{A}_3)$$

$$(\mathcal{U}_3, \mathcal{A}_3) = \{ ((a_1, s, 1), \{v_4\}), ((a_3, s, 0), \{v_3\}) \}.$$

Definition 26. Restricted Symmetric Difference of two hse-sets $(\mathcal{U}_1, \mathcal{A}_1)$ and $(\mathcal{U}_2, \mathcal{A}_2)$ on $\tilde{\Omega}$, shown by $(\mathcal{U}_1, \mathcal{A}_1) \star (\mathcal{U}_2, \mathcal{A}_2)$, is a hse-set $(\mathcal{U}_3, \mathcal{A}_3)$ characterized by $(\mathcal{U}_3, \mathcal{A}_3) = \{((\mathcal{U}_1, \mathcal{A}_1) \cup_R (\mathcal{U}_2, \mathcal{A}_2)) \setminus_R ((\mathcal{U}_1, \mathcal{A}_1) \cap (\mathcal{U}_2, \mathcal{A}_2))\}$.

Example 3.22. Dealing Example 3.1, with sets

$$\mathcal{A}_1 = \{ (\eta_1, s, 1), (\eta_1, t, 1), (\eta_3, s, 1), (\eta_3, s, 0) \}, \mathcal{A}_2 = \{ (\eta_1, s, 1), (\eta_3, s, 0) \}.$$

Consider three hse-sets $(\mathcal{U}_1, \mathcal{A}_1)$ and $(\mathcal{U}_2, \mathcal{A}_2)$ over $\tilde{\Omega}$, then

$$(\mathcal{U}_1, \mathcal{A}_1) = \left\{ \begin{array}{l} ((\eta_1, s, 1), \{v_1, v_2, v_4\}), ((\eta_1, t, 1), \{v_1\}), \\ ((\eta_3, s, 1), \{v_4\}), ((\eta_3, s, 0), \{v_1, v_2, v_3\}), \end{array} \right\}$$

$$(\mathcal{U}_2, \mathcal{A}_2) = \{ ((\eta_1, s, 1), \{v_1, v_2\}), ((\eta_3, s, 0), \{v_1, v_2\}) \}$$

$$(\mathcal{U}_1, \mathcal{A}_1) \cup_R (\mathcal{U}_2, \mathcal{A}_2) = ((\eta_1, s, 1), \{v_1, v_2, v_4\}), ((\eta_3, s, 0), \{v_1, v_2, v_3\}), \text{ and}$$

$$\{(\mathcal{U}_1, \mathcal{A}_1) \cap (\mathcal{U}_2, \mathcal{A}_2)\} = \{((\eta_1, s, 1), \{v_1, v_2\}), ((\eta_3, s, 0), \{v_1, v_2\})\}$$

$$\text{then } (\mathcal{U}_3, \mathcal{A}_3) = \{((\eta_1, s, 1), \{v_4\}), ((\eta_3, s, 0), \{v_3\})\}.$$

Proposition 3.23. Consider three hse-sets $(\mathcal{U}_1, \mathcal{A}_1), (\mathcal{U}_2, \mathcal{A}_2)$ and $(\mathcal{U}_3, \mathcal{A}_3)$, then

$$(1) ((\mathcal{U}_1, \mathcal{A}_1) \wedge (\mathcal{U}_2, \mathcal{A}_2))^c = ((\mathcal{U}_1, \mathcal{A}_1))^c \vee ((\mathcal{U}_2, \mathcal{A}_2))^c$$

$$(2) ((\mathcal{U}_1, \mathcal{A}_1) \vee (\mathcal{U}_2, \mathcal{A}_2))^c = ((\mathcal{U}_1, \mathcal{A}_1))^c \wedge ((\mathcal{U}_2, \mathcal{A}_2))^c.$$

Proposition 3.24. Consider three hse-sets $(\mathcal{U}_1, \mathcal{A}_1)$, $(\mathcal{U}_2, \mathcal{A}_2)$ and $(\mathcal{U}_3, \mathcal{A}_3)$, then

- (1) $((\mathcal{U}_1, \mathcal{A}_1) \wedge (\mathcal{U}_2, \mathcal{A}_2)) \wedge (\mathcal{U}_3, \mathcal{A}_3) = (\mathcal{U}_1, \mathcal{A}_1) \wedge ((\mathcal{U}_2, \mathcal{A}_2) \wedge (\mathcal{U}_3, \mathcal{A}_3))$
- (2) $((\mathcal{U}_1, \mathcal{A}_1) \vee (\mathcal{U}_2, \mathcal{A}_2)) \vee (\mathcal{U}_3, \mathcal{A}_3) = (\mathcal{U}_1, \mathcal{A}_1) \vee ((\mathcal{U}_2, \mathcal{A}_2) \vee (\mathcal{U}_3, \mathcal{A}_3))$
- (3) $(\mathcal{U}_1, \mathcal{A}_1) \vee ((\mathcal{U}_2, \mathcal{A}_2) \wedge (\mathcal{U}_3, \mathcal{A}_3)) = ((\mathcal{U}_1, \mathcal{A}_1) \vee (\mathcal{U}_2, \mathcal{A}_2)) \wedge ((\mathcal{U}_1, \mathcal{A}_1) \vee (\mathcal{U}_3, \mathcal{A}_3))$
- (4) $(\mathcal{U}_1, \mathcal{A}_1) \wedge ((\mathcal{U}_2, \mathcal{A}_2) \vee (\mathcal{U}_3, \mathcal{A}_3)) = ((\mathcal{U}_1, \mathcal{A}_1) \wedge (\mathcal{U}_2, \mathcal{A}_2)) \vee ((\mathcal{U}_1, \mathcal{A}_1) \wedge (\mathcal{U}_3, \mathcal{A}_3)).$

4. BASIC PROPERTIES AND LAWS

In this section of the paper, some properties like exclusion, contraction and laws like idempotent, identity, domination etc. are described.

(1) **Idempotent Laws**

- (2) $(\Xi, \vartheta) \cup (\Xi, \vartheta) = (\Xi, \vartheta) = (\Xi, \vartheta) \cup_R (\Xi, \vartheta)$
- (3) $(\Xi, \vartheta) \cap (\Xi, \vartheta) = (\Xi, \vartheta) = (\Xi, \vartheta) \cap_\varepsilon (\Xi, \vartheta).$

(1) **Identity Laws**

- (2) $(\Xi, \vartheta) \cup (\Xi, \vartheta)_\Phi = (\Xi, \vartheta) = (\Xi, \vartheta) \cup_R (\Xi, \vartheta)_\Phi$
- (3) $(\Xi, \vartheta) \cap (\Xi, \vartheta)_U = (\Xi, \vartheta) = (\Xi, \vartheta) \cap_\varepsilon (\Xi, \vartheta)_U$
- (4) $(\Xi, \vartheta) \setminus_R (\Xi, \vartheta)_\Phi = (\Xi, \vartheta) = (\Xi, \vartheta) \star (\Xi, \vartheta)_\Phi$
- (5) $(\Xi, \vartheta) \setminus_R (\Xi, \vartheta) = (\Xi, \vartheta)_\Phi = (\Xi, \vartheta) \star (\Xi, \vartheta).$

(1) **Domination Laws**

- (2) $(\Xi, \vartheta) \cup (\Xi, \vartheta)_U = (\Xi, \vartheta)_U = (\Xi, \vartheta) \cup_R (\Xi, \vartheta)_U$
- (3) $(\Xi, \vartheta) \cap (\Xi, \vartheta)_\Phi = (\Xi, \vartheta)_\Phi = (\Xi, \vartheta) \cap_\varepsilon (\Xi, \vartheta)_\Phi.$

(1) **Property of Exclusion**

- (2) $(\Xi, \vartheta) \cup (\Xi, \vartheta)^* = (\Xi, \vartheta)_U = (\Xi, \vartheta) \cup_R (\Xi, \vartheta)^*.$

(1) **Property of Contradiction**

- (2) $(\Xi, \vartheta) \cap (\Xi, \vartheta)^* = (\Xi, \vartheta)_\Phi = (\Xi, \vartheta) \cap_\varepsilon (\Xi, \vartheta)^*.$

(1) **Absorption Laws**

- (2) $(\check{\mathcal{D}}, \mathcal{H}_1) \cup ((\check{\mathcal{D}}, \mathcal{H}_1) \cap (\check{\mathcal{D}}, \mathcal{H}_1)) = (\check{\mathcal{D}}, \mathcal{H}_1)$
- (3) $(\check{\mathcal{D}}, \mathcal{H}_1) \cap ((\check{\mathcal{D}}, \mathcal{H}_1) \cup (\check{\mathcal{D}}, \mathcal{H}_1)) = (\check{\mathcal{D}}, \mathcal{H}_1)$
- (4) $(\check{\mathcal{D}}, \mathcal{H}_1) \cup_R ((\check{\mathcal{D}}, \mathcal{H}_1) \cap_\varepsilon (\check{\mathcal{D}}, \mathcal{H}_1)) = (\check{\mathcal{D}}, \mathcal{H}_1)$
- (5) $(\check{\mathcal{D}}, \mathcal{H}_1) \cap_\varepsilon ((\check{\mathcal{D}}, \mathcal{H}_1) \cup_R (\check{\mathcal{D}}, \mathcal{H}_1)) = (\check{\mathcal{D}}, \mathcal{H}_1).$

(1) **Absorption Laws**

- (2) $((\check{\mathcal{C}}, \mathcal{C}_1) \cup (\check{\mathcal{C}}, \mathcal{C}_2)) = ((\check{\mathcal{C}}, \mathcal{C}_1) \cup (\check{\mathcal{C}}, \mathcal{C}_2))$
- (3) $((\check{\mathcal{C}}, \mathcal{C}_1) \cup_R (\check{\mathcal{C}}, \mathcal{C}_2)) = ((\check{\mathcal{C}}, \mathcal{C}_1) \cup_R (\check{\mathcal{C}}, \mathcal{C}_2))$
- (4) $((\check{\mathcal{C}}, \mathcal{C}_1) \cap (\check{\mathcal{C}}, \mathcal{C}_2)) = ((\check{\mathcal{C}}, \mathcal{C}_1) \cap (\check{\mathcal{C}}, \mathcal{C}_2))$
- (5) $((\check{\mathcal{C}}, \mathcal{C}_1) \cap_\varepsilon (\check{\mathcal{C}}, \mathcal{C}_2)) = ((\check{\mathcal{C}}, \mathcal{C}_1) \cap_\varepsilon (\check{\mathcal{C}}, \mathcal{C}_2))$
- (6) $((\check{\mathcal{C}}, \mathcal{C}_1) \star (\check{\mathcal{C}}, \mathcal{C}_2)) = ((\check{\mathcal{C}}, \mathcal{C}_1) \star (\check{\mathcal{C}}, \mathcal{C}_2)).$

(1) **Associative Laws**

- (2) $(\Upsilon, \mathcal{C}_1) \cup ((\Upsilon, \mathcal{C}_2) \cup (\omega, \mathcal{C}_3)) = ((\Upsilon, \mathcal{C}_1) \cup (\Upsilon, \mathcal{C}_2)) \cup (\omega, \mathcal{C}_3)$
- (3) $(\Upsilon, \mathcal{C}_1) \cup_R ((\Upsilon, \mathcal{C}_2) \cup_R (\omega, \mathcal{C}_3)) = ((\Upsilon, \mathcal{C}_1) \cup_R (\Upsilon, \mathcal{C}_2)) \cup_R (\omega, \mathcal{C}_3)$
- (4) $(\Upsilon, \mathcal{C}_1) \cap ((\Upsilon, \mathcal{C}_2) \cap (\omega, \mathcal{C}_3)) = ((\Upsilon, \mathcal{C}_1) \cap (\Upsilon, \mathcal{C}_2)) \cap (\omega, \mathcal{C}_3)$
- (5) $(\Upsilon, \mathcal{C}_1) \cap_\varepsilon ((\Upsilon, \mathcal{C}_2) \cap_\varepsilon (\omega, \mathcal{C}_3)) = ((\Upsilon, \mathcal{C}_1) \cap_\varepsilon (\Upsilon, \mathcal{C}_2)) \cap_\varepsilon (\omega, \mathcal{C}_3)$
- (6) $(\Upsilon, \mathcal{C}_1) \vee ((\Upsilon, \mathcal{C}_2) \vee (\omega, \mathcal{C}_3)) = ((\Upsilon, \mathcal{C}_1) \vee (\Upsilon, \mathcal{C}_2)) \vee (\omega, \mathcal{C}_3)$

$$(7) (\Upsilon, \mathcal{L}_1) \wedge ((\Upsilon, \mathcal{L}_2) \wedge (\omega, \mathcal{L}_3)) = ((\Upsilon, \mathcal{L}_1) \wedge (\Upsilon, \mathcal{L}_2)) \wedge (\omega, \mathcal{L}_3).$$

(1) De Morgan's Laws

- (2) $((\Theta, \mathcal{L}_1) \cup (\Theta, \mathcal{L}_2))^c = (\Theta, \mathcal{L}_1)^c \cap_{\varepsilon} (\Theta, \mathcal{L}_2)^c$
- (3) $((\Theta, \mathcal{L}_1) \cap_{\varepsilon} (\Theta, \mathcal{L}_2))^c = (\Theta, \mathcal{L}_1)^c \cup (\Theta, \mathcal{L}_2)^c$
- (4) $((\Theta, \mathcal{L}_1) \cup_R (\Theta, \mathcal{L}_2))^* = (\Theta, \mathcal{L}_1)^* \cap (\Theta, \mathcal{L}_2)^*$
- (5) $((\Theta, \mathcal{L}_1) \cap (\Theta, \mathcal{L}_2))^* = (\Theta, \mathcal{L}_1)^* \cup_R (\Theta, \mathcal{L}_2)^*$
- (6) $((\Theta, \mathcal{L}_1) \vee (\Theta, \mathcal{L}_2))^c = (\Theta, \mathcal{L}_1)^c \wedge (\Theta, \mathcal{L}_2)^c$
- (7) $((\Theta, \mathcal{L}_1) \wedge (\Theta, \mathcal{L}_2))^c = (\Theta, \mathcal{L}_1)^c \vee (\Theta, \mathcal{L}_2)^c$
- (8) $((\Theta, \mathcal{L}_1) \vee (\Theta, \mathcal{L}_2))^* = (\Theta, \mathcal{L}_1)^* \wedge (\Theta, \mathcal{L}_2)^*$
- (9) $((\Theta, \mathcal{L}_1) \wedge (\Theta, \mathcal{L}_2))^* = (\Theta, \mathcal{L}_1)^* \vee (\Theta, \mathcal{L}_2)^*.$

(1) Distributive Laws

- (2) $(\Theta, \mathcal{L}_1) \cup ((\Theta, \mathcal{L}_2) \cap (\omega, \mathcal{L}_3)) = ((\Theta, \mathcal{L}_1) \cup (\Theta, \mathcal{L}_2)) \cap ((\Theta, \mathcal{L}_1) \cup (\omega, \mathcal{L}_3))$
- (3) $(\Theta, \mathcal{L}_1) \cap ((\Theta, \mathcal{L}_2) \cup (\omega, \mathcal{L}_3)) = ((\Theta, \mathcal{L}_1) \cap (\Theta, \mathcal{L}_2)) \cup ((\Theta, \mathcal{L}_1) \cap (\omega, \mathcal{L}_3))$
- (4) $(\Theta, \mathcal{L}_1) \cup_R ((\Theta, \mathcal{L}_2) \cap_{\varepsilon} (\omega, \mathcal{L}_3)) = ((\Theta, \mathcal{L}_1) \cup_R (\Theta, \mathcal{L}_2)) \cap_{\varepsilon} ((\Theta, \mathcal{L}_1) \cup_R (\omega, \mathcal{L}_3))$
- (5) $(\Theta, \mathcal{L}_1) \cap_{\varepsilon} ((\Theta, \mathcal{L}_2) \cup_R (\omega, \mathcal{L}_3)) = ((\Theta, \mathcal{L}_1) \cap_{\varepsilon} (\Theta, \mathcal{L}_2)) \cup_R ((\Theta, \mathcal{L}_1) \cap_{\varepsilon} (\omega, \mathcal{L}_3))$
- (6) $(\Theta, \mathcal{L}_1) \cup_R ((\Theta, \mathcal{L}_2) \cap (\omega, \mathcal{L}_3)) = ((\Theta, \mathcal{L}_1) \cup_R (\Theta, \mathcal{L}_2)) \cap ((\Theta, \mathcal{L}_1) \cup_R (\omega, \mathcal{L}_3))$
- (7) $(\Theta, \mathcal{L}_1) \cap ((\Theta, \mathcal{L}_2) \cup_R (\omega, \mathcal{L}_3)) = ((\Theta, \mathcal{L}_1) \cap (\Theta, \mathcal{L}_2)) \cup_R ((\Theta, \mathcal{L}_1) \cap (\omega, \mathcal{L}_3)).$

5. AN APPLICATION TO HYPERSOFT EXPERT SET

In this section, the application of hse-set theory in decision-making problem is presented.

Statement of the problem

An assembling organization advertises an "open position" to fill its an empty position. Its primary trademark is "the perfect individual for the right post". Eight applications got from the appropriate applicants and the experts need to finish this employing system through the choice leading group of certain specialists for certain recommended ascribes..

Proposed Algorithm

The following is the algorithm which is adopted for the solution of the problem.

Step-1

Let universe of discourse $\tilde{\Omega} = \{C_1, C_2, C_3, C_4, C_5, C_6, C_7, C_8\}$ consists of eight candidates and $X = \{E_1, E_2, E_3\}$ is representing a set of experts. Attributes with corresponding attribute-valued sets are given as:

- $\mathcal{O}_1 = Qualification = \{\Delta_1 = M.phil, \Delta_2 = Ph.D\}$
- $\mathcal{O}_2 = Experience = \{\Delta_3 = 5years, \Delta_4 = 10years\}$
- $\mathcal{O}_3 = ComputerKnowledge = \{\Delta_5 = Yes, \Delta_6 = No\}$
- $\mathcal{O}_4 = Confidence = \{\Delta_7 = Low, \Delta_8 = High\}$
- $\mathcal{O}_5 = Skills = \{\Delta_9 = Good, \Delta_{10} = Excellent\}$

and then $H = \mathcal{O}_1 \times \mathcal{O}_2 \times \mathcal{O}_3 \times \mathcal{O}_4 \times \mathcal{O}_5, H =$

$$\left\{ \begin{array}{l} (\Delta_1, \Delta_3, \Delta_5, \Delta_7, \Delta_9), (\Delta_1, \Delta_3, \Delta_5, \Delta_7, \Delta_{10}), (\Delta_1, \Delta_3, \Delta_5, \Delta_8, \Delta_9), (\Delta_1, \Delta_3, \Delta_5, \Delta_8, \Delta_{10}), \\ (\Delta_1, \Delta_3, \Delta_6, \Delta_7, \Delta_9), (\Delta_1, \Delta_3, \Delta_6, \Delta_7, \Delta_{10}), (\Delta_1, \Delta_3, \Delta_6, \Delta_8, \Delta_9), (\Delta_1, \Delta_3, \Delta_6, \Delta_8, \Delta_{10}), \\ (\Delta_1, \Delta_4, \Delta_5, \Delta_7, \Delta_9), (\Delta_1, \Delta_4, \Delta_5, \Delta_7, \Delta_{10}), (\Delta_1, \Delta_4, \Delta_5, \Delta_8, \Delta_9), (\Delta_1, \Delta_4, \Delta_5, \Delta_8, \Delta_{10}), \\ (\Delta_1, \Delta_4, \Delta_6, \Delta_7, \Delta_9), (\Delta_1, \Delta_4, \Delta_6, \Delta_7, \Delta_{10}), (\Delta_1, \Delta_4, \Delta_6, \Delta_8, \Delta_9), (\Delta_1, \Delta_4, \Delta_6, \Delta_8, \Delta_{10}), \\ (\Delta_2, \Delta_3, \Delta_5, \Delta_7, \Delta_9), (\Delta_2, \Delta_3, \Delta_5, \Delta_7, \Delta_{10}), (\Delta_2, \Delta_3, \Delta_5, \Delta_8, \Delta_9), (\Delta_2, \Delta_3, \Delta_5, \Delta_8, \Delta_{10}), \\ (\Delta_2, \Delta_3, \Delta_6, \Delta_7, \Delta_9), (\Delta_2, \Delta_3, \Delta_6, \Delta_7, \Delta_{10}), (\Delta_2, \Delta_3, \Delta_6, \Delta_8, \Delta_9), (\Delta_2, \Delta_3, \Delta_6, \Delta_8, \Delta_{10}), \\ (\Delta_2, \Delta_4, \Delta_5, \Delta_7, \Delta_9), (\Delta_2, \Delta_4, \Delta_5, \Delta_7, \Delta_{10}), (\Delta_2, \Delta_4, \Delta_5, \Delta_8, \Delta_9), (\Delta_2, \Delta_4, \Delta_5, \Delta_8, \Delta_{10}), \\ (\Delta_2, \Delta_4, \Delta_6, \Delta_7, \Delta_9), (\Delta_2, \Delta_4, \Delta_6, \Delta_7, \Delta_{10}), (\Delta_2, \Delta_4, \Delta_6, \Delta_8, \Delta_9), (\Delta_2, \Delta_4, \Delta_6, \Delta_8, \Delta_{10}) \end{array} \right\}$$

and now take $\Omega \subseteq H$ as $\Omega = \{S_1 = (\Delta_1, \Delta_3, \Delta_5, \Delta_7, \Delta_9), S_2 = (\Delta_1, \Delta_3, \Delta_6, \Delta_7, \Delta_{10}), S_3 =$

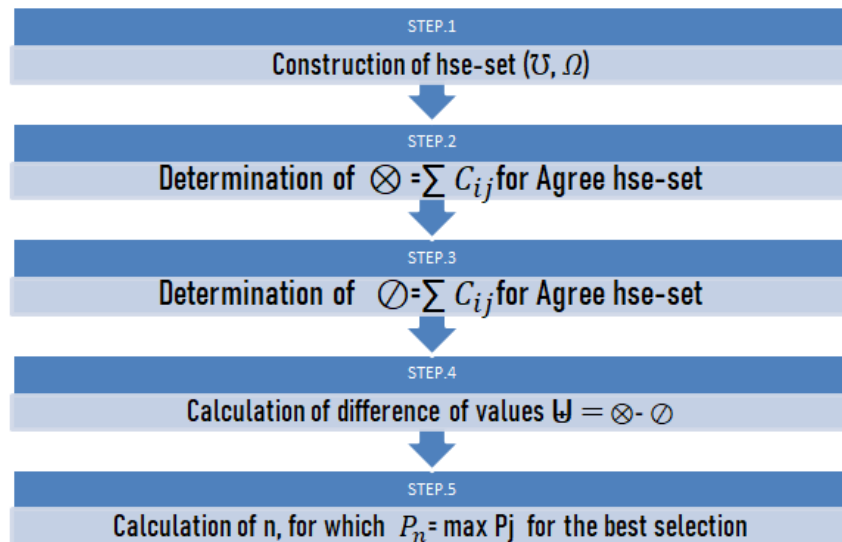

FIGURE 1. Algorithm for recruitment process

$$(\Delta_1, \Delta_4, \Delta_6, \Delta_8, \Delta_9), S_4 = (\Delta_2, \Delta_3, \Delta_6, \Delta_8, \Delta_9), S_5 = (\Delta_2, \Delta_4, \Delta_6, \Delta_7, \Delta_{10}) \} \text{ and } (U, \Omega) = \left\{ \begin{array}{l} ((S_1, E_1, 1) = \{C_1, C_2, C_4, C_7, C_8\}), ((S_1, E_2, 1) = \{C_1, C_4, C_5, C_8\}), \\ ((S_1, E_3, 1) = \{C_1, C_3, C_4, C_5, C_6, C_7, C_8\}), ((S_5, E_3, 0) = \{C_2, C_4, C_6\}) \\ ((S_2, E_1, 1) = \{C_3, C_5, C_8\}), ((S_2, E_2, 1) = \{C_1, C_3, C_4, C_5, C_6, C_8\}), \\ ((S_2, E_3, 1) = \{C_1, C_2, C_4, C_7, C_8\}), ((S_3, E_3, 1) = \{C_1, C_7, C_8\}), \\ ((S_3, E_1, 1) = \{C_3, C_4, C_5, C_7\}), ((S_3, E_2, 1) = \{C_1, C_2, C_5, C_8\}), \\ ((S_4, E_1, 1) = \{C_1, C_7, C_8\}), ((S_4, E_2, 1) = \{C_5, C_1, C_4, C_8\}), \\ ((S_4, E_3, 1) = \{C_1, C_6, C_7, C_8\}), ((S_5, E_3, 1) = \{C_1, C_3, C_4, C_5, C_7, C_8\}), \\ ((S_5, E_1, 1) = \{C_1, C_3, C_4, C_5, C_7, C_8\}), ((S_5, E_2, 1) = \{C_1, C_4, C_5, C_8\}), \\ ((S_1, E_1, 0) = \{C_3, C_5, C_6\}), ((S_1, E_2, 0) = \{C_2, C_3, C_6, C_7\}), \\ ((S_1, E_3, 0) = \{C_2, C_5\}), ((S_2, E_3, 0) = \{C_2, C_3, C_4, C_5, C_6\}), \\ ((S_2, E_1, 0) = \{C_1, C_2, C_4, C_5, C_6, C_7\}), ((S_2, E_2, 0) = \{C_2, C_7\}), \\ ((S_3, E_1, 0) = \{C_1, C_2, C_6, C_8\}), ((S_3, E_2, 0) = \{C_3, C_4, C_6, C_7\}), \\ ((S_3, E_3, 0) = \{C_2, C_3, C_4, C_5, C_7\}), ((S_4, E_3, 0) = \{C_2, C_3, C_4, C_5\}), \\ ((S_4, E_1, 0) = \{C_2, C_3, C_3, C_4, C_5, C_7\}), ((S_4, E_2, 0) = \{C_2, C_3, C_6, C_7\}), \\ ((S_5, E_1, 0) = \{C_4, C_6, C_7\}), ((S_5, E_2, 0) = \{C_2, C_3, C_6, C_7\}), \end{array} \right\}$$

is a hypersoft expert set.

Step-2 Agree-hse-set and Disagree-hse-set have been presented in Tables 1 and 2 respectively in such way when $C_i \in F_1(o)$ then $C_{ij} = \uparrow = 1$ otherwise $C_{ij} = \downarrow = 0$, and when $C_i \in F_0(o)$ then $C_{ij} = \uparrow = 1$ otherwise $C_{ij} = \downarrow = 0$.

Step-(3-6)

The $\otimes_i = \sum_i C_{ij}$ for Agree-hse-set and $\oslash_j = \sum_j C_{ij}$ for Disagree-hse-set have been shown in Table 3, then $\uplus_j = \otimes_j - \oslash_j$ is calculated so that decision can be made.

Decision

TABLE 1. Agree-hse-set

v	C_1	C_2	C_3	C_4	C_5	C_6	C_8	C_7
(S_1, E_1)	↑	↑	↓	↑	↓	↓	↑	↑
(S_2, E_1)	↓	↓	↑	↓	↑	↓	↓	↑
(S_3, E_1)	↓	↓	↑	↑	↑	↓	↑	↓
(S_4, E_1)	↑	↓	↓	↓	↑	↓	↑	↑
(S_5, E_1)	↑	↑	↑	↓	↑	↓	↓	↑
(S_1, E_2)	↑	↓	↓	↑	↓	↓	↓	↑
(S_2, E_2)	↑	↓	↑	↑	↑	↑	↓	↑
(S_3, E_2)	↓	↓	↑	↑	↑	↓	↑	↓
(S_4, E_2)	↑	↓	↓	↑	↑	↓	↓	↑
(S_5, E_2)	↑	↓	↓	↑	↑	↓	↓	↑
(S_1, E_3)	↑	↓	↑	↑	↓	↑	↑	↑
(S_2, E_3)	↑	↑	↓	↑	↓	↓	↑	↑
(S_3, E_3)	↑	↓	↓	↓	↓	↓	↑	↑
(S_4, E_3)	↑	↓	↓	↓	↓	↑	↑	↑
(S_5, E_3)	↑	↓	↑	↓	↑	↓	↑	↑
$\otimes_j = \sum_i C_{ij}$	$\otimes_1 = 12$	$\otimes_2 = 3$	$\otimes_3 = 7$	$\otimes_4 = 9$	$\otimes_5 = 9$	$\otimes_6 = 3$	$\otimes_7 = 9$	$\otimes_8 = 13$

TABLE 2. Disagree-hse-set

V	C_1	C_2	C_3	C_4	C_5	C_6	C_7	C_8
(\emptyset_1, E_1)	↓	↓	↑	↓	↓	↑	↓	↓
(S_2, E_1)	↑	↑	↓	↑	↓	↑	↑	↓
(S_3, E_1)	↑	↑	↓	↓	↓	↑	↓	↑
(S_4, E_1)	↓	↑	↑	↑	↑	↑	↓	↓
(S_5, E_1)	↓	↓	↓	↑	↓	↑	↑	↓
(S_1, E_2)	↓	↑	↑	↓	↓	↑	↑	↓
(S_2, E_2)	↓	↑	↓	↓	↓	↓	↑	↓
(S_3, E_2)	↑	↑	↓	↓	↓	↑	↓	↑
(S_4, E_2)	↓	↑	↑	↓	↓	↑	↑	↓
(S_5, E_2)	↓	↑	↑	↓	↓	↑	↑	↓
(S_1, E_3)	↓	↑	↓	↓	↑	↓	↓	↓
(S_2, E_3)	↓	↓	↑	↓	↑	↑	↓	↓
(S_3, E_3)	↓	↑	↑	↑	↑	↑	↓	↓
(S_4, E_3)	↓	↑	↑	↑	↑	↓	↓	↓
(S_5, E_3)	↓	↑	↓	↑	↓	↑	↓	↓
$\oslash_i = \sum_j C_{ij}$	$\oslash_1 = 3$	$\oslash_2 = 12$	$\oslash_3 = 8$	$\oslash_4 = 6$	$\oslash_5 = 5$	$\oslash_6 = 12$	$\oslash_7 = 6$	$\oslash_8 = 2$

As \oslash_8 is getting best position in table, so candidate C_8 will be selected. Then $\max \oslash_8$, so the committee will decide to select applicant C_8 for the job.

6. COMPARATIVE ANALYSIS

The performance of hypersoft expert model outperforms all other existing models. Such a model is popular in decision-making problems. This can be seen by comparing hypersoft expert set with the others models like soft set, soft expert set and hypersoft set This proposed model is more useful to

TABLE 3. Optimal

$\otimes_i = \sum_i C_{ij}$	$\oslash_i = \sum_i C_{ij}$	$\uplus_j = \otimes_j - \oslash_j$
$\otimes_1 = 12$	$\oslash_1 = 3$	$\uplus_1 = 9$
$\otimes_2 = 3$	$\oslash_2 = 12$	$\uplus_2 = -9$
$\otimes_3 = 7$	$\oslash_3 = 8$	$\uplus_3 = -1$
$\otimes_4 = 9$	$\oslash_4 = 6$	$\uplus_4 = 3$
$\otimes_5 = 9$	$\oslash_5 = 5$	$\uplus_5 = 4$
$\otimes_6 = 3$	$\oslash_6 = 12$	$\uplus_6 = -9$
$\otimes_7 = 9$	$\oslash_7 = 6$	$\uplus_7 = 3$
$\otimes_8 = 13$	$\oslash_8 = 2$	$\uplus_8 = 11$

others as it contains the multi argument approximate function, which is highly effective in decision-making problems. Comparison analysis has been shown in Table 4. From the Table 4, it is clear that

TABLE 4. Comparison Analysis

Features	soft set	soft expert set	hypersoft set	Pro. Structure
Multi Decisive Opinion	No	Yes	No	Yes
Multi Argument Apro.Function	No	No	Yes	Yes
Single Ar. Apro.Function	Yes	Yes	Yes	Yes
Ranking	No	Yes	No	Yes

our proposed model is more generalized than the above described models.

7. CONCLUSIONS

In this study, fundamental properties, aggregation operations, and basic set laws are characterized under hypersoft expert set environment. Moreover, an algorithm is proposed for the solution of a decision-making problem. Future work may include the development of hybrids of hypersoft expert set with fuzzy set, rough set, cubic set etc. and algebraic structures like hypersoft expert topological spaces, hypersoft expert functional spaces, hypersoft expert groups, hypersoft expert vector spaces, hypersoft expert ring, hypersoft expert measure etc.

REFERENCES

- [1] M. Abbas, G. Murtaza and F. Smarandache, Basic operations on hypersoft sets and hypersoft point, *Neutrosophic Sets Syst.*, **35**(2020) 407-421.
- [2] M. Akram, A. Adeel and J. C. R. Alcantud, Group decision-making methods based on hesitant N-soft sets, *Expert Systems with Applications*, **115**(2019) 95-105.
- [3] S. Alkhazaleh, and A. R. Salleh, Soft Expert Sets, *Advances in Decision Sciences*, **2011**(2011) 757868-1.
- [4] S. Alkhazaleh, A. R. Salleh and N. Hassan, Soft multi sets theory, *Applied Mathematical Sciences*, **5**(72)(2011) 3561-3573.
- [5] S. Alkhazaleh, A. R. Salleh and N. Hassan, Possibility fuzzy soft set, *Advances in Decision Sciences*, **2011** (2011) 1-18, Article ID 479756.
- [6] S. Alkhazaleh, A. R. Salleh and N. Hassan, Fuzzy parameterized interval-valued fuzzy soft set, *Applied Mathematical Sciences*, **5**(67)(2011) 3335-3346.
- [7] M. I. Ali, F. Feng, X. Liu, W. K. Min and M. Shabir, On some new operations in soft set theory, *Computers and Mathematics with Applications*, **57**(9)(2009) 1547-1553.
- [8] K. V. Babitha and J. Sunil, Soft set relations and functions, *Computers & Mathematics with Applications*, **60**(7)(2010) 1840-1849.

- [9] D. Chen, E. C. C. Tsang, D. S. Yeung and X. Wang, The parameterization reduction of soft sets and its applications, *Computers and Mathematics with Applications*, **49**(5-6)(2005) 757-763.
- [10] I. Deli, Convex and Concave Sets Based on Soft Sets and Fuzzy Soft Sets, *Journal of New Theory*, **29**(2019) 101-110.
- [11] F. Fatimah, D. Rosadi, R. F. Hakim and J. C. R. Alcantud, N-soft sets and their decision making algorithms, *Soft Computing*, **22**(12)(2018) 3829-3842.
- [12] M. Ihsan, M. Saeed and A. U. Rahman, A rudimentary approach to develop context for convexity cum concavity on soft expert set with some generalized results, *Punjab University Journal of Mathematics*, **53**(9)(2021) 621-629.
- [13] M. Ihsan, A. U. Rahman, M. Saeed and Khalifa, H. A. E. W., Convexity-cum-concavity on fuzzy soft expert set with certain properties, *International Journal of Fuzzy Logic and Intelligent Systems*, **21**(3)(2021) 233-242.
- [14] M. Ihsan, A. U. Rahman and M. Saeed, Hypersoft expert set with application in decision making for recruitment process, *Neutrosophic Sets and Systems*, **42**(2021) 191-207.
- [15] M. Ihsan, M. Saeed and A. U. Rahman, Fuzzy hypersoft expert set with application in decision making for the best selection of product, *Neutrosophic Sets and Systems*, **46**(2021) 318-335.
- [16] M. Ihsan, M. Saeed and A. U. Rahman, Single valued neutrosophic hypersoft expert set with application in decision making, *Neutrosophic Sets and Systems*, **47**(2021) 451-471.
- [17] M. Ihsan, M. Saeed, A. Alburaihan and H. A. E. W. Khalifa, Product evaluation through multi-criteria decision making based on fuzzy parameterized Pythagorean fuzzy hypersoft expert set, *AIMS Mathematics*, **7**(6)(2022) 11024-11052.
- [18] M. Ihsan, M. Saeed and A. U. Rahman, Multi-attribute decision support model based on bijective hypersoft expert set, *Punjab University Journal of Mathematics*, **54**(1)(2021) 55-73.
- [19] S. N. Majeed, Some notions on convex soft sets, *Annals of Fuzzy Mathematics and Informatics*, **12**(4)(2016) 517-526.
- [20] P. K. Maji, R. Biswas and A. R. Roy, Soft set theory, *Computers and Mathematics with Applications*, **45**(4-5)(2005) 555-562.
- [21] P. K. Maji, A. R. Roy and R. Biswas, An application of soft sets in a decision making problem, *Computers and Mathematics with Applications*, **44**(8-9)(2002) 1077-1083.
- [22] D. Molodtsov, Soft set theory first results, *Computers and Mathematics with Applications*, **37**(4-5)(1999) 19-31.
- [23] T. Y. Öztürk and A. Yolcu, On neutrosophic hypersoft topological spaces, in *Theory and Application of Hypersoft Set*, (2021) 215-234.
- [24] A. U. Rahman, M. Saeed, M. Ihsan, M. Arshad and S. Ayaz, A conceptual framework of m-convex and m-concave sets under soft set environment with properties, *Transactions in Mathematical and Computational Sciences*, **1**(1)(2021) 50-60.
- [25] A. U. Rahman, M. Saeed, M. Arshad, M. Ihsan and M. R. Ahmad, (m, n)-convexity-cum-concavity on fuzzy soft set with applications in first and second sense, *Punjab University Journal of Mathematics*, **53**(1)(2021) 19-33.
- [26] A. U. Rahman, M. Saeed, F. Smarandache and M. R. Ahmad, Development of hybrids of hypersoft set with complex fuzzy set, complex intuitionistic fuzzy set and complex neutrosophic set, *Neutrosophic Sets and Syst*, **38**(2020) 335-354.
- [27] A. U. Rahman, M. Saeed and F. Smarandache, Convex and concave hypersoft sets with some properties, *Neutrosophic Sets Syst*, **38**(2020) 497-508.
- [28] A. U. Rahman, M. Saeed and A. Dhital, Decision making application based on neutrosophic parameterized hypersoft set theory, *Neutrosophic Sets and Systems*, **41**(2021) 1-14.
- [29] A. U. Rahman, M. Saeed, M. A. Mohammed, S. Krishnamoorthy, S. Kadry and F. Eid, An integrated algorithmic MADM approach for heart diseases diagnosis based on neutrosophic hypersoft set with possibility degree-based setting, *Life*, **12**(5)(2022) 729.
- [30] A. U. Rahman, M. Saeed and A. Hafeez, theory of bijective hypersoft set with application in decision making, *Punjab University Journal of Mathematics*, **53**(7)(2021) 511-526..
- [31] A. U. Rahman, M. Saeed, A. Khalid, M. R., Ahmad and S. Ayaz, Decision-making application based on aggregations of complex fuzzy hypersoft set and development of interval-valued complex fuzzy hypersoft set, *Neutrosophic Sets and Systems*, **46**(1)(2021) 300-317.

- [32] A. U. Rahman, M. Saeed, S. S., Alodhaibi and H. Abd, Decision making algorithmic approaches based on parameterization of neutrosophic set under hypersoft set environment with fuzzy, intuitionistic fuzzy and neutrosophic settings, *CMES-Computer Modeling in Engineering & Sciences*, **128**(2)(2021) 743-777.
- [33] A. U. Rahman, M. Saeed, H. A. E. W., Khalifa and W. A. Afifi, Decision making algorithmic techniques based on aggregation operations and similarity measures of possibility intuitionistic fuzzy hypersoft sets, *AIMS Mathematics*, **7**(3)(2022) 3866-3895.
- [34] A. U. Rahman, M. Saeed and F. Smarandache, A theoretical and analytical approach to the conceptual framework of convexity cum concavity on fuzzy hypersoft sets with some generalized properties, *Soft Computing*, **26**(9)(2022) 4123-4139.
- [35] A. U. Rahman, M. Saeed, M. Arshad and S. El-Morsy, Multi-Attribute Decision-Support System Based on Aggregations of Interval-Valued Complex Neutrosophic Hypersoft Set, *Applied Computational Intelligence and Soft Computing*, **2021** (2021).
- [36] M. Saeed, A. U. Rahman, M. Ahsan and F. Smarandache, An inclusive study on fundamentals of hypersoft set, in *Theory and Application of Hypersoft Set*, Pons Publishing House, Brussels, (2021) 1-23.
- [37] M. Saqlain, S. Moin, M. N. Jafar, M. Saeed and F. Smarandache, Aggregate operators of neutrosophic hypersoft set, *Neutrosophic Sets and Systems*, **32**(2020) 294-306.
- [38] F. Smarandache, Extension of soft set to hypersoft set, and then to plithogenic hypersoft set, *Neutrosophic Sets Syst*, **22**(2018) 168-170.
- [39] A. Yolcu, F. Smarandache and T. Y. Öztürk, Intuitionistic fuzzy hypersoft sets, *Communications Faculty of Sciences University of Ankara Series A1 Mathematics and Statistics*, **70**(1)(2021) 443-455.
- [40] A. Yolcu and T. Y. Öztürk, Fuzzy hypersoft sets and its application to decision-making, in *Theory and Application of Hypersoft Set*, (2021) 50-64.

NEUTROSOPHIC SEMIGROUPS

Neutrosophic Bi-LA-Semigroup and Neutrosophic N-LA-Semigroup

Mumtaz Ali, Florentin Smarandache, Muhammad Shabir, Munazza Naz

Madad Khan, Saima Anis, Florentin Smarandache, Young Bae Jun (2017). Neutrosophic N-structures and their applications in semigroups. *Annals of Fuzzy Mathematics and Informatics* 14(6), 583-598

Abstract. In this paper we define neutrosophic bi-LA-semigroup and neutrosophic N-LA-semigroup. Infact this paper is an extension of our previous paper neutrosophic left almost semigroup shortly neutrosophic LA-semigroup. We also extend the neutrosophic ideal to neutrosophic biideal and neutrosophic N-ideal. We also find

some new type of neutrosophic ideal which is related to the strong or pure part of neutrosophy. We have given sufficient amount of examples to illustrate the theory of neutrosophic bi-LA-semigroup, neutrosophic N-LA-semigroup and display many properties of them this paper.

Keywords: Neutrosophic LA-semigroup, neutrosophic ideal, neutrosophic bi-LA-semigroup, neutrosophic biideal, neutrosophic N-LA-semigroup, neutrosophic N-ideal.

1 Introduction

Neutrosophy is a new branch of philosophy which studies the origin and features of neutralities in the nature. Florentin Smarandache in 1980 firstly introduced the concept of neutrosophic logic where each proposition in neutrosophic logic is approximated to have the percentage of truth in a subset T, the percentage of indeterminacy in a subset I, and the percentage of falsity in a subset F so that this neutrosophic logic is called an extension of fuzzy logic. In fact neutrosophic set is the generalization of classical sets, conventional fuzzy set [1], intuitionistic fuzzy set [2] and interval valued fuzzy set [3]. This mathematical tool is used to handle problems like imprecise, indeterminacy and inconsistent data etc. By utilizing neutrosophic theory, Vasantha Kandasamy and Florentin Smarandache dig out neutrosophic algebraic structures in [11]. Some of them are neutrosophic fields, neutrosophic vector spaces, neutrosophic groups, neutrosophic bigroups, neutrosophic N-groups, neutrosophic semigroups, neutrosophic bisemigroups, neutrosophic N-semigroup, neutrosophic loops, neutrosophic biloops, neutrosophic N-loop, neutrosophic groupoids, and neutrosophic bigroupoids and so on.

A left almost semigroup abbreviated as LA-semigroup is an algebraic structure which was introduced by M.A.

Kazim and M. Naseeruddin [3] in 1972. This structure is basically a midway structure between a groupoid and a commutative semigroup. This structure is also termed as Able-Grassmann's groupoid abbreviated as AG-groupoid [6]. This is a non associative and non commutative algebraic structure which closely resemble to commutative semigroup. The generalization of semigroup theory is an LA-semigroup and this structure has wide applications in collaboration with semigroup.

We have tried to develop the ideal theory of LA-semigroups in a logical manner. Firstly, preliminaries and basic concepts are given for neutrosophic LA-semigroup. Then we presented the newly defined notions and results in neutrosophic bi-LA-semigroups and neutrosophic N-LA-semigroups. Various types of neutrosophic biideals and neutrosophic N-ideal are defined and elaborated with the help of examples.

Preliminaries

Definition 1. Let $(S, *)$ be an LA-semigroup and let $\langle S \cup I \rangle = \{a + bI : a, b \in S\}$. The neutrosophic LA-semigroup is generated by S and I under $*$ denoted as $N(S) = \{\langle S \cup I \rangle, *\}$, where I is called the neutrosophic element with property $I^2 = I$. For an integer n , $n + I$ and nI are neutrosophic elements and

$0.I = 0.I^{-1}$, the inverse of I is not defined and hence does not exist.

Similarly we can define neutrosophic RA-semigroup on the same lines.

Definition . Let $N(S)$ be a neutrosophic LA-semigroup and $N(H)$ be a proper subset of $N(S)$. Then $N(H)$ is called a neutrosophic sub LA-semigroup if $N(H)$ itself is a neutrosophic LA-semigroup under the operation of $N(S)$.

Definition . A neutrosophic sub LA-semigroup $N(H)$ is called strong neutrosophic sub LA-semigroup or pure neutrosophic sub LA-semigroup if all the elements of $N(H)$ are neutrosophic elements.

Definition . Let $N(S)$ be a neutrosophic LA-semigroup and $N(K)$ be a subset of $N(S)$. Then $N(K)$ is called Left (right) neutrosophic ideal of $N(S)$ if $N(S)N(K) \subseteq N(K)$ ($N(K)N(S) \subseteq N(K)$). If $N(K)$ is both left and right neutrosophic ideal, then $N(K)$ is called a two sided neutrosophic ideal or simply a neutrosophic ideal.

Definition . A neutrosophic ideal $N(K)$ is called strong neutrosophic ideal or pure neutrosophic ideal if all of its elements are neutrosophic elements.

3 Neutrosophic Bi-LA-Semigroup

Definition . Let $(BN(S), *, \circ)$ be a non-empty set with two binary operations $*$ and \circ . $(BN(S), *, \circ)$ is said to be a neutrosophic bi-LA-semigroup if $BN(S) = P_1 \cup P_2$ where atleast one of $(P_1, *)$ or (P_2, \circ) is a neutrosophic LA-semigroup and other is just an LA- semigroup. P_1 and P_2 are proper subsets of $BN(S)$.

Similarly we can define neutrosophic bi-RA-semigroup on the same lines.

Theorem 1. All neutrosophic bi-LA-semigroups contains the corresponding bi-LA-semigroups.

Example 1. Let $BN(S) = \{\langle S_1 \cup I \rangle \cup \langle S_2 \cup I \rangle\}$ be a neutrosophic bi-LA-semigroup where

$\langle S_1 \cup I \rangle = \{1, 2, 3, 4, 1I, 2I, 3I, 4I\}$ is a neutrosophic LA-semigroup with the following table.

	1	2	3	4	1I	2I	3I	4I
1	1	4	2	3	1I	4I	2I	3I
2	3	2	4	1	3I	2I	4I	1I
3	4	1	3	2	4I	1I	3I	2I
4	2	3	1	4	2I	3I	1I	4I
1I	1I	4I	2I	3I	1I	4I	2I	3I
2I	3I	2I	4I	1I	3I	2I	4I	1I
3I	4I	1I	3I	2I	4I	1I	3I	2I
4I	2I	3I	1I	4I	2I	3I	1I	4I

$\langle S_2 \cup I \rangle = \{1, 2, 3, 1I, 2I, 3I\}$ be another neutrosophic bi-LA-semigroup with the following table.

	1	2	3	1I	2I	3I
1	3	3	3	3I	3I	3I
2	3	3	3	3I	3I	3I
3	1	3	3	1I	3I	3I
1I	3I	3I	3I	3I	3I	3I
2I	3I	3I	3I	3I	3I	3I
3I	1I	3I	3I	1I	3I	3I

Definition . Let $(BN(S) = P_1 \cup P_2; *, \circ)$ be a neutrosophic bi-LA-semigroup. A proper subset $(T, \circ, *)$ is said to be a neutrosophic sub bi-LA-semigroup of $BN(S)$ if

- $T = T_1 \cup T_2$ where $T_1 = P_1 \cap T$ and $T_2 = P_2 \cap T$ and
- At least one of (T_1, \circ) or $(T_2, *)$ is a neutrosophic LA-semigroup.

Example : $BN(S)$ be a neutrosophic bi-LA-semigroup in Example 1. Then $P = \{1, 1I\} \cup \{3, 3I\}$ and $Q = \{2, 2I\} \cup \{1, 1I\}$ are neutrosophic sub bi-LA-semigroups of $BN(S)$.

Theorem . Let $BN(S)$ be a neutrosophic bi-LA-semigroup and $N(H)$ be a proper subset of $BN(S)$. Then $N(H)$ is a neutrosophic sub bi-LA-semigroup of $BN(S)$ if $N(H).N(H) \subseteq N(H)$.

Definition . Let $(BN(S) = P_1 \cup P, *, \circ)$ be any neutrosophic bi-LA-semigroup. Let J be a proper subset of $BN(S)$ such that $J_1 = J \cap P_1$ and $J_2 = J \cap P_2$ are ideals of P_1 and P_2 respectively. Then J is called the neutrosophic biideal of $BN(S)$.

Example . Let $BN(S) = \{ \langle S_1 \cup I \rangle \cup \langle S_2 \cup I \rangle \}$ be a neutrosophic bi-LA-semigroup, where

$\langle S_1 \cup I \rangle = \{1, 2, 3, 1I, 2I, 3I\}$ be another neutrosophic bi-LA-semigroup with the following table.

	1	2	3	1I	2I	3I
1	3	3	3	3I	3I	3I
2	3	3	3	3I	3I	3I
3	1	3	3	1I	3I	3I
1I	3I	3I	3I	3I	3I	3I
2I	3I	3I	3I	3I	3I	3I
3I	1I	3I	3I	1I	3I	3I

And $\langle S_2 \cup I \rangle = \{1, 2, 3, I, 2I, 3I\}$ be another neutrosophic LA-semigroup with the following table.

.	1	2	3	I	2I	3I
1	3	3	2	3I	3I	2I
2	2	2	2	2I	2I	2I
3	2	2	2	2I	2I	2I
I	3I	3I	2I	3I	3I	2I
2I	2I	2I	2I	2I	2I	2I
3I	2I	2I	2I	2I	2I	2I

Then $P = \{1, 1I, 3, 3I\} \cup \{2, 2I\}$,

$Q = \{1, 3, 1I, 3I\} \cup \{2, 3, 2I, 3I\}$ are neutrosophic biideals of $BN(S)$.

Proposition 1. Every neutrosophic biideal of a neutrosophic bi-LA-semigroup is trivially a Neutrosophic sub bi-LA-semigroup but the converse is not true in general. One can easily see the converse by the help of example.

3 Neutrosophic Strong Bi-LA-Semigroup

Definition : If both $(P_1, *)$ and (P_2, \circ) in the Definition 6. are neutrosophic strong LA-semigroups then we call $(BN(S), *, \circ)$ is a neutrosophic strong bi-LA-semigroup.

Definition 1 . Let $(BN(S) = P_1 \cup P, *, \circ)$ be a neutrosophic bi-LA-semigroup. A proper subset $(T, \circ, *)$ is said to be a neutrosophic strong sub bi-LA-semigroup of $BN(S)$ if

1. $T = T_1 \cup T_2$ where $T_1 = P_1 \cap T$ and $T_2 = P_2 \cap T$ and
2. (T_1, \circ) and $(T_2, *)$ are neutrosophic strong LA-semigroups.

Example . Let $BN(S)$ be a neutrosophic bi-LA-semigroup in Example 3. Then $P = \{1I, 3I\} \cup \{2I\}$, and $Q = \{1I, 3I\} \cup \{2I, 3I\}$ are neutrosophic strong sub bi-LA-semigroup of $BN(S)$.

Theorem : Every neutrosophic strong sub bi-LA-semigroup is a neutrosophic sub bi-LA-semigroup.

Definition 11. Let $(BN(S), *, \circ)$ be a strong neutrosophic bi-LA-semigroup where $BN(S) = P_1 \cup P_2$ with $(P_1, *)$ and (P_2, \circ) be any two neutrosophic LA-semigroups. Let J be a proper subset of $BN(S)$ where $I = I_1 \cup I_2$ with $I_1 = I \cap P_1$ and $I_2 = I \cap P_2$ are neutrosophic ideals of the neutrosophic LA-semigroups P_1 and P_2 respectively. Then I is called or defined as the

neutrosophic strong biideal of $BN(S)$.

Theorem : Every neutrosophic strong biideal is trivially a neutrosophic sub bi-LA-semigroup.

Theorem : Every neutrosophic strong biideal is a neutrosophic strong sub bi-LA-semigroup.

Theorem : Every neutrosophic strong biideal is a neutrosophic biideal.

Example . Let $BN(S)$ be a neutrosophic bi-LA semigroup in Example (). Then $P = \{1I, 3I\} \cup \{2I\}$, and $Q = \{1I, 3I\} \cup \{2I, 3I\}$ are neutrosophic strong biideal of $BN(S)$.

4 Neutrosophic N-LA-Semigroup

Definition 1 . Let $\{S(N), *_1, \dots, *_2\}$ be a non-empty set with N -binary operations defined on it. We call $S(N)$ a neutrosophic N -LA-semigroup (N a positive integer) if the following conditions are satisfied.

- 1) $S(N) = S_1 \cup \dots \cup S_N$ where each S_i is a proper subset of $S(N)$ i.e. $S_i \subset S_j$ or $S_j \subset S_i$ if $i \neq j$.
- 2) $(S_i, *_i)$ is either a neutrosophic LA-semigroup or an LA-semigroup for $i = 1, 2, 3, \dots, N$.

Example . Let $S(N) = \{S_1 \cup S_2 \cup S_3, *_1, *_2, *_3\}$ be a neutrosophic 3-LA-semigroup where $S_1 = \{1, 2, 3, 4, 1I, 2I, 3I, 4I\}$ is a neutrosophic LA-semigroup with the following table.

	1	2	3	4	1I	2I	3I	4I
1	1	4	2	3	1I	4I	2I	3I
2	3	2	4	1	3I	2I	4I	1I
3	4	1	3	2	4I	1I	3I	2I
4	2	3	1	4	2I	3I	1I	4I
1I	1I	4I	2I	3I	1I	4I	2I	3I
2I	3I	2I	4I	1I	3I	2I	4I	1I
3I	4I	1I	3I	2I	4I	1I	3I	2I
4I	2I	3I	1I	4I	2I	3I	1I	4I

$S_2 = \{1, 2, 3, 1I, 2I, 3I\}$ be another neutrosophic bi-LA-

semigroup with the following table.

	1	2	3	1I	2I	3I
1	3	3	3	3I	3I	3I
2	3	3	3	3I	3I	3I
3	1	3	3	1I	3I	3I
1I	3I	3I	3I	3I	3I	3I
2I	3I	3I	3I	3I	3I	3I
3I	1I	3I	3I	1I	3I	3I

And $S_3 = \{1, 2, 3, I, 2I, 3I\}$ is another neutrosophic LA-semigroup with the following table.

.	1	2	3	I	2I	3I
1	3	3	2	3I	3I	2I
2	2	2	2	2I	2I	2I
3	2	2	2	2I	2I	2I
I	3I	3I	2I	3I	3I	2I
2I	2I	2I	2I	2I	2I	2I
3I	2I	2I	2I	2I	2I	2I

Theorem All neutrosophic N-LA-semigroups contains the corresponding N-LA-semigroups.

Definition 1 . Let $S(N) = \{S_1 \cup S_2 \cup \dots \cup S_N, *_1, *_2, \dots, *_N\}$ be a neutrosophic N -LA-semigroup. A proper subset $P = \{P_1 \cup P_2 \cup \dots \cup P_N, *_1, *_2, \dots, *_N\}$ of $S(N)$ is said to be a neutrosophic sub N -LA-semigroup if $P_i = P \cap S_i, i = 1, 2, \dots, N$ are sub LA-semigroups of S_i in which atleast some of the sub LA-semigroups are neutrosophic sub LA-semigroups.

Example : Let $S(N) = \{S_1 \cup S_2 \cup S_3, *_1, *_2, *_3\}$ be a neutrosophic 3-LA-semigroup in above Example 6. Then clearly $P = \{1, 1I\} \cup \{2, 3, 3I\} \cup \{2, 2I\}$, $Q = \{2, 2I\} \cup \{1, 3, 1I, 3I\} \cup \{2, 3, 2I, 3I\}$, and

$R = \{4, 4I\} \cup \{1I, 3I\} \cup \{2I, 3I\}$ are neutrosophic sub 3-LA-semigroups of $S(N)$.

Theorem 1 . Let $N(S)$ be a neutrosophic N-LA-semigroup and $N(H)$ be a proper subset of $N(S)$. Then $N(H)$ is a neutrosophic sub N-LA-semigroup of $N(S)$ if $N(H) \cdot N(H) \subseteq N(H)$.

Definition 1 . Let

$S(N) = \{S_1 \cup S_2 \cup \dots \cup S_N, *_{1, *_{2, \dots, *_{N}}}\}$ be a neutrosophic N -LA-semigroup. A proper subset $P = \{P_1 \cup P_2 \cup \dots \cup P_N, *_{1, *_{2, \dots, *_{N}}}\}$ of $S(N)$ is said to be a neutrosophic N -ideal, if the following conditions are true,

1. P is a neutrosophic sub N -LA-semigroup of $S(N)$.
2. Each $P_i = S \cap P_i, i = 1, 2, \dots, N$ is an ideal of S_i .

Example . Consider Example 6.

Then $I_1 = \{1, 1I\} \cup \{3, 3I\} \cup \{2, 2I\}$, and

$I_2 = \{2, 2I\} \cup \{1I, 3I\} \cup \{2, 3, 3I\}$ are neutrosophic 3-ideals of $S(N)$.

Theorem 1 : Every neutrosophic N-ideal is trivially a neutrosophic sub N-LA-semigroup but the converse is not true in general.

One can easily see the converse by the help of example.

5 Neutrosophic Strong N-LA-Semigroup

Definition 1 : If all the N -LA-semigroups $(S_i, *_{i})$ in Definition () are neutrosophic strong LA-semigroups (i.e. for $i = 1, 2, 3, \dots, N$) then we call $S(N)$ to be a neutrosophic strong N -LA-semigroup.

Definition 1 . Let

$S(N) = \{S_1 \cup S_2 \cup \dots \cup S_N, *_{1, *_{2, \dots, *_{N}}}\}$ be a neutrosophic strong N -LA-semigroup. A proper subset $T = \{T_1 \cup T_2 \cup \dots \cup T_N, *_{1, *_{2, \dots, *_{N}}}\}$ of $S(N)$ is said to be a neutrosophic strong sub N -LA-semigroup if each $(T_i, *_{i})$ is a neutrosophic strong sub LA-semigroup of $(S_i, *_{i})$ for $i = 1, 2, \dots, N$ where $T_i = S_i \cap T$.

Theorem 11: Every neutrosophic strong sub N-LA-semigroup is a neutrosophic sub N-LA-semigroup.

Definition 1 . Let

$S(N) = \{S_1 \cup S_2 \cup \dots \cup S_N, *_{1, *_{2, \dots, *_{N}}}\}$ be a neutrosophic strong N -LA-semigroup. A proper subset $J = \{J_1 \cup J_2 \cup \dots \cup J_N, *_{1, *_{2, \dots, *_{N}}}\}$ where $J_i = J \cap S_i$ for $t = 1, 2, \dots, N$ is said to be a neutrosophic strong N -ideal of $S(N)$ if the following conditions are satisfied.

- 1) Each it is a neutrosophic sub LA-semigroup of $S_i, t = 1, 2, \dots, N$ i.e. It is a neutrosophic strong N-sub LA-semigroup of $S(N)$.
- 2) Each it is a two sided ideal of S_i for $t = 1, 2, \dots, N$.

Similarly one can define neutrosophic strong N -left ideal or neutrosophic strong right ideal of $S(N)$.

A neutrosophic strong N -ideal is one which is both a neutrosophic strong N -left ideal and N -right ideal of $S(N)$.

Theorem 1 : Every neutrosophic strong Nideal is trivially a neutrosophic sub N-LA-semigroup.

Theorem 1 : Every neutrosophic strong N-ideal is a neutrosophic strong sub N-LA-semigroup.

Theorem 1 : Every neutrosophic strong N-ideal is a N-ideal.

Conclusion

In this paper we extend neutrosophic LA-semigroup to neutrosophic bi-LA-semigroup and neutrosophic N-LA-semigroup. The neutrosophic ideal theory of neutrosophic LA-semigroup is extend to neutrosophic biideal and neutrosophic N-ideal. Some new type of neutrosophic ideals are discovered which is strongly neutrosophic or purely neutrosophic. Related examples are given to illustrate neutrosophic bi-LA-semigroup, neutrosophic N-LA-semigroup and many theorems and properties are discussed.

References

- [1] M. Ali, M. Shabir, M. Naz and F. Smarandache, Neutrosophic Left Almost Semigroup, Neutrosophic Sets and Systems, 3 (2014), 18-28.
- [2] Florentin Smarandache, A Unifying Field in Logics. Neutrosophy, Neutrosophic Probability, Set and Logic. Rehoboth: American Research Press, (1999).
- [3] W. B. Vasantha Kandasamy & Florentin Smarandache, Some Neutrosophic Algebraic Structures and Neutrosophic N-Algebraic Structures, 219 p., Hexis, 2006.

- [4] W. B. Vasantha Kandasamy & Florentin Smarandache, N-Algebraic Structures and S-N-Algebraic Structures, 209 pp., Hexis, Phoenix, 2006.
- [5] W. B. Vasantha Kandasamy & Florentin Smarandache, Basic Neutrosophic Algebraic Structures and their Applications to Fuzzy and Neutrosophic Models, Hexis, 149 pp., 2004.
- [6] P. Holgate: Groupoids satisfying a simple invertive law, *The Math. Student* 61 (1992).
- [7] M. Kazim and M. Naseeruddin: On almost semigroups, *Alig. Bull. Math.*2 (1972).
- [8] Q. Mushtaq and M. S. Kamran: On left almost groups, *Proc. Pak. Acad. Sci.* 331 (1996), 53-55.
- [9] M. Shabir, S. Naz, Pure spectrum of an ag-groupoid with left identity and zero, *World Applied Sciences Journal* 17 (2012) 1759-1768.
- [10] Protic, P.V and N. Stevanovic, AG-test and some general properties of Abel-grassmann's groupoids, *PU. M. A.*, 4,6 (1995), 371 – 383.
- [11] Madad Khan and N. Ahmad, Characterizations of left almost semigroups by their ideals, *Journal of Advanced Research in Pure mathematics*, 2 (2010), 61 – 73.
- [12] Q. Mushtaq and M. Khan, Ideals in left almost semigroups, *Proceedings of 4th International Pure mathematics Conference*, 2003, 65 – 77.

Neutrosophic LA-Semigroup Rings

Mumtaz Ali, Muhammad Shabir, Florentin Smarandache, Luige Vladareanu

Mumtaz Ali, Muhammad Shabir, Florentin Smarandache, Luige Vladareanu (2015). Neutrosophic LA-Semigroup Rings. *Neutrosophic Sets and Systems* 7, 81-88

Abstract. Neutrosophic LA-semigroup is a midway structure between a neutrosophic groupoid and a commutative neutrosophic semigroup. Rings are the old concept in algebraic structures. We combine the neutrosophic

LA-semigroup and ring together to form the notion of neutrosophic LA-semigroup ring. Neutrosophic LA-semigroup ring is defined analogously to neutrosophic group ring and neutrosophic semigroup ring.

Keywords: Neutrosophic LA-semigroup, ring, neutrosophic LA-semigroup ring.

1. Introduction

Smarandache [13] in 1980 introduced neutrosophy which is a branch of philosophy that studies the origin and scope of neutralities with ideational spectra. The concept of neutrosophic set and logic came into being due to neutrosophy, where each proposition is approximated to have the percentage of truth in a subset T, the percentage of indeterminacy in a subset I, and the percentage of falsity in a subset F. This mathematical tool is used to handle problems with imprecise, indeterminate, incomplete and inconsistent etc. Kandasamy and Smarandache apply this concept in algebraic structures in a slight different manner by using the indeterminate/unknown element I, which they call neutrosophic element. The neutrosophic element I is then combine to the elements of the algebraic structure by taking union and link with respect to the binary operation of the algebraic stucutre. Therefore, a neutrosophic algebraic structure is generated in this way. They studied several neutrosophic algebraic structure [3,4,5,6]. Some of them are neutrosophic fields, neutrosophic vector spaces, neutrosophic groups, neutrosophic bigroups, neutrosophic N-groups, neutrosophic semigroups, neutrosophic bisemigroups, neutrosophic N-semigroup, neutrosophic loops, neutrosophic biloops, neutrosophic N-loop, neutrosophic groupoids, and neutrosophic bigroupoids and so on.

A left almost semigroup denoted as LA-semigroup is an algebraic structure which was studied by Kazim and Naseeruddin [7] in 1972. An LA-semigroup is basically a midway structure between a groupoid and a commutative semigroup. It is also termed as Able-Grassmann's groupoid shortly *AG*-groupoid [11]. LA-semigroup is a

non-associative and non-commutative algebraic structure which closely matching with commutative semigroup. LA-semigroup is a generalization to semigroup theory which has wide applications in collaboration with semigroup. Mumtaz et al.[1] introduced neutrosophic left almost semigroup in short neutrosophic LA-semigroup which is basically generated by an LA-semigroup and the neutrosophic element I. Mumtaz et al.[1] also studied their generalization and other properties. Neutrosophic group rings [5] and neutrosophic semigroup rings [5] are defined analogously to group rings and semigroup rings respectively. In fact these are generalization of group ring and semigroup ring ring. The notion of neutrosophic matrix ring have been successfully applied and used in the neutrosophic models such as neutrosophic cognitive maps (NCMs), neutrosophic relational maps (NRMs) etc.

In this paper, we introduced neutrosophic LA-semigroup rings owing to neutrosophic semigroup rings. Neutrosophic LA-semigroup rings are generalization of neutrosophic semigroup rings. These neutrosophic LA-semigroup rings are defined analogously to neutrosophic group rings and neutrosophic semigroup rings. We also studied some of their basic properties and other related notions in this paper. In section 2, we after reviewing the literature, we presented some basic concepts of neutrosophic LA-semigroup and rings. In section 3, neutrosophic LA-semigroup rings are introduced and studied some of their properties.

2. Basic Concepts

Definition .1 1 : Let $(S, *)$ be an LA-semigroup and let $\langle S \cup I \rangle = \{a + bI : a, b \in S\}$. The neutrosophic

LA-semigroup is generated by S and I under the operation $*$ which is denoted as $N(S) = \{\langle S \cup I \rangle, *\}$, where I is called the neutrosophic element with property $I^2 = I$. For an integer n , $n + I$ and nI are neutrosophic elements and $0.I = 0$.

I^{-1} , the inverse of I is not defined and hence does not exist.

Definition . 1 : Let $N(S)$ be a neutrosophic LA-semigroup and $N(H)$ be a proper subset of $N(S)$. Then $N(H)$ is called a neutrosophic sub LA-semigroup if $N(H)$ itself is a neutrosophic LA-semigroup under the operation of $N(S)$.

Definition . 1 : Let $N(S)$ be a neutrosophic LA-semigroup and $N(K)$ be a subset of $N(S)$. Then $N(K)$ is called Left (right) neutrosophic ideal of $N(S)$ if

$$N(S)N(K) \subseteq N(K), \{N(K)N(S) \subseteq N(K)\}.$$

If $N(K)$ is both left and right neutrosophic ideal, then $N(K)$ is called a two sided neutrosophic ideal or simply a neutrosophic ideal.

Definition . : Let $(R, +, \cdot)$ be a set with two binary operations $+$ and \cdot . Then $(R, +, \cdot)$ is called a ring if the following conditions are hold.

1. $(R, +)$ is a commutative group under the operation of $+$.
2. (R, \cdot) is a semigroup under the operation of \cdot .
3. $a(b + c) = ab + ac$ and $(b + c)a = ba + ca$ for all $a, b, c \in R$.

Definition . : Let $(R, +, \cdot)$ be a ring and $(R_1, +, \cdot)$ be a proper subset of $(R, +, \cdot)$. Then $(R_1, +, \cdot)$ is called a subring if $(R_1, +, \cdot)$ itself is a ring under the operation of R .

Definition . : Let R be a ring. The neutrosophic ring $\langle R \cup I \rangle$ is also a ring generated by R and I under the operation of R , where I is called the neutrosophic element with property $I^2 = I$. For an integer n , $n + I$ and nI are neutrosophic elements and $0.I = 0$. I^{-1} , the inverse of I is not defined and hence does not exist.

Example . : Let \mathbb{Z} be the ring of integers. Then $\langle \mathbb{Z} \cup I \rangle$ is the neutrosophic ring of integers.

Definition . : Let $\langle R \cup I \rangle$ be a neutrosophic ring. A proper subset P of $\langle R \cup I \rangle$ is called a neutrosophic subring if P itself a neutrosophic ring under the operation of $\langle R \cup I \rangle$.

Definition . : Let $\langle R \cup I \rangle$ be a neutrosophic ring. A non-empty set P of $\langle R \cup I \rangle$ is called a neutrosophic ideal of $\langle R \cup I \rangle$ if the following conditions are satisfied.

1. P is a neutrosophic subring of $\langle R \cup I \rangle$, and
2. For every $p \in P$ and $r \in \langle R \cup I \rangle$, pr and $rp \in P$.

3. Neutrosophic LA-semigroup Rings

In this section, we introduced neutrosophic LA-semigroup rings and studied some of their basic properties and types.

Definition 3.1: Let $\langle S \cup I \rangle$ be any neutrosophic LA-semigroup. R be any ring with 1 which is commutative or field. We define the neutrosophic LA-semigroup ring $R\langle S \cup I \rangle$ of the neutrosophic LA-semigroup $\langle S \cup I \rangle$ over the ring R as follows:

1. $R\langle S \cup I \rangle$ consists of all finite formal sum of the form $\alpha = \sum_{i=1}^n r_i g_i$, $n < \infty$, $r_i \in R$ and $g_i \in \langle S \cup I \rangle$ ($\alpha \in R\langle S \cup I \rangle$).
2. Two elements $\alpha = \sum_{i=1}^n r_i g_i$ and $\beta = \sum_{i=1}^m s_i g_i$ in $R\langle S \cup I \rangle$ are equal if and only if $r_i = s_i$ and $n = m$.
3. Let $\alpha = \sum_{i=1}^n r_i g_i, \beta = \sum_{i=1}^m s_i g_i \in R\langle S \cup I \rangle$;
 $\alpha + \beta = \sum_{i=1}^n (\alpha_i + \beta_i) g_i \in R\langle S \cup I \rangle$, as $\alpha_i, \beta_i \in R$, so $\alpha_i + \beta_i \in R$ and $g_i \in \langle S \cup I \rangle$.
4. $0 = \sum_{i=1}^n 0 g_i$ serve as the zero of $R\langle S \cup I \rangle$.
5. Let $\alpha = \sum_{i=1}^n r_i g_i \in R\langle S \cup I \rangle$ then $-\alpha = \sum_{i=1}^n (-\alpha_i) g_i$ is such that
 $\alpha + (-\alpha) = 0$
 $= \sum_{i=1}^n (\alpha_i + (-\alpha_i)) g_i$
 $= \sum 0 g_i$

Thus we see that $R\langle S \cup I \rangle$ is an abelian group under $+$.

6. The product of two elements α, β in $R\langle S \cup I \rangle$ is follows:

Let $\alpha = \sum_{i=1}^n \alpha_i g_i$ and $\beta = \sum_{j=1}^m \beta_j h_j$. Then

$$\alpha \cdot \beta = \sum_{\substack{1 \leq i \leq n \\ 1 \leq j \leq m}} \alpha_i \cdot \beta_j g_i h_j = \sum_k y_k t_k$$

where $y_k = \sum \alpha_i \beta_j$ with $g_i h_j = t_k$, $t_k \in \langle S \cup I \rangle$ and $y_k \in R$.

Clearly $\alpha \cdot \beta \in R\langle S \cup I \rangle$.

$$7. \text{ Let } \alpha = \sum_{i=1}^n \alpha_i g_i \text{ and } \beta = \sum_{j=1}^m \beta_j h_j \text{ and } \gamma = \sum_{k=1}^p \delta_k l_k.$$

Then clearly $\alpha(\beta + \gamma) = \alpha\beta + \alpha\gamma$ and $(\beta + \gamma)\alpha = \beta\alpha + \gamma\alpha$ for all $\alpha, \beta, \gamma \in R\langle S \cup I \rangle$, that is the distributive law holds.

Hence $R\langle S \cup I \rangle$ is a ring under the binary operations $+$ and \cdot . We call $R\langle S \cup I \rangle$ as the neutrosophic LA-semigroup ring.

Similarly on the same lines, we can define neutrosophic Right Almost semigroup ring abbreviated as neutrosophic RA-semigroup ring.

Example . : Let \mathbb{R} be the ring of real numbers and let $N(S) = \{1, 2, 3, 4, 1I, 2I, 3I, 4I\}$ be a

neutrosophic LA-semigroup with the following table.

	1	2	3	4	1I	2I	3I	4I
1	1	4	2	3	1I	4I	2I	3I
2	3	2	4	1	3I	2I	4I	1I
3	4	1	3	2	4I	1I	3I	2I
4	2	3	1	4	2I	3I	1I	4I
1I	1I	4I	2I	3I	1I	4I	2I	3I
2I	3I	2I	4I	1I	3I	2I	4I	1I
3I	4I	1I	3I	2I	4I	1I	3I	2I
4I	2I	3I	1I	4I	2I	3I	1I	4I

Then $\mathbb{R}\langle S \cup I \rangle$ is a neutrosophic LA-semigroup ring.

Theorem . : Let $\langle S \cup I \rangle$ be a neutrosophic LA-semigroup and $R\langle S \cup I \rangle$ be a neutrosophic LA-semigroup ring such that $R\langle S \cup I \rangle$ is a neutrosophic LA-semigroup ring over R . Then $\langle S \cup I \rangle \subseteq R\langle S \cup I \rangle$.

Proposition . : Let $R\langle S \cup I \rangle$ be a neutrosophic LA-semigroup ring over the ring R . Then $R\langle S \cup I \rangle$ has non-trivial idempotents.

Remark . : The neutrosophic LA-semigroup ring $R\langle S \cup I \rangle$ is commutative if and only if $\langle S \cup I \rangle$ is commutative neutrosophic LA-semigroup.

Remark . : The neutrosophic LA-semigroup ring $R\langle S \cup I \rangle$ has finite number of elements if both R and $\langle S \cup I \rangle$ are of finite order.

Example . : Let $R\langle S \cup I \rangle$ be a neutrosophic LA-semigroup ring in Example (1). Then $R\langle S \cup I \rangle$ is a neutrosophic LA-semigroup ring of infinite order.

Example . : Let $\langle S \cup I \rangle = \{1, 2, 3, 4, 5, 1I, 2I, 3I, 4I, 5I\}$ with left identity 4, defined by the following multiplication table.

.	1	2	3	4	5	1I	2I	3I	4I	5I
1	4	5	1	2	3	4I	5I	1I	2I	3I
2	3	4	5	1	2	3I	4I	5I	1I	2I
3	2	3	4	5	1	2I	3I	4I	5I	1I
4	1	2	3	4	5	1I	2I	3I	4I	5I
5	5	1	2	3	4	5I	1I	2I	3I	4I
1I	4I	5I	1I	2I	3I	4I	5I	1I	2I	3I
2I	3I	4I	5I	1I	2I	3I	4I	5I	1I	2I
3I	2I	3I	4I	5I	1I	2I	3I	4I	5I	1I
4I	1I	2I	3I	4I	5I	1I	2I	3I	4I	5I
5I	5I	1I	2I	3I	4I	5I	1I	2I	3I	4I

Let \mathbb{Z}_2 be the ring of two elements. Then $\mathbb{Z}_2\langle S \cup I \rangle$ is a neutrosophic LA-semigroup ring of finite order.

Theorem . : Every neutrosophic LA-semigroup ring $R\langle S \cup I \rangle$ contains atleast one proper subset which is an LA-semigroup ring.

Proof: Let $R\langle S \cup I \rangle$ be a neutrosophic LA-semigroup ring. Then clearly $RS \subseteq R\langle S \cup I \rangle$. Thus $R\langle S \cup I \rangle$ contains an LA-semigroup ring.

Definition .1 : Let $R\langle S \cup I \rangle$ be a neutrosophic LA-semigroup ring and let P be a proper subset of $R\langle S \cup I \rangle$. Then P is called a subneutrosophic LA-semigroup ring of $R\langle S \cup I \rangle$ if $P = R\langle H \cup I \rangle$ or $Q\langle S \cup I \rangle$ or $T\langle H \cup I \rangle$. In $P = R\langle H \cup I \rangle$, R is a ring and $\langle H \cup I \rangle$ is a proper neutrosophic sub LA-semigroup of $\langle S \cup I \rangle$ or in $Q\langle S \cup I \rangle$, Q is a proper subring with 1 of R and $\langle S \cup I \rangle$ is a neutrosophic LA-semigroup and if $P = T\langle H \cup I \rangle$, T is a subring of R with unity and $\langle H \cup I \rangle$ is a proper neutrosophic sub LA-semigroup of $\langle S \cup I \rangle$.

Example .11: Let $\langle S \cup I \rangle$ and $\mathbb{R}\langle S \cup I \rangle$ be as in Example 3.2. Let $H_1 = \{1, 3\}$, $H_2 = \{1, 1I\}$ and $H_3 = \{1, 3, 1I, 3I\}$ are neutrosophic sub LA-semigroups. Then $\mathbb{Q}\langle S \cup I \rangle$, $\mathbb{R}H_1$, $\mathbb{Z}\langle H_2 \cup I \rangle$ and $\mathbb{Q}\langle H_3 \cup I \rangle$ are all subneutrosophic LA-semigroup rings of $\mathbb{R}\langle S \cup I \rangle$.

Definition .1 : Let $R\langle S \cup I \rangle$ be a neutrosophic LA-semigroup ring. A proper subset P of $R\langle S \cup I \rangle$ is called a neutrosophic subring if $P = \langle S_1 \cup I \rangle$ where S_1 is a subring of RS or R .

Example .1 : Let $R\langle S \cup I \rangle = \mathbb{Z}_2\langle S \cup I \rangle$ be a neutrosophic LA-semigroup ring in Example 3.8. Then clearly $\langle \mathbb{Z}_2 \cup I \rangle$ is a neutrosophic subring of $\mathbb{Z}_2\langle S \cup I \rangle$.

Theorem .1 : Let $R\langle S \cup I \rangle$ be a neutrosophic LA-semigroup ring of the neutrosophic LA-semigroup over the

ring R . Then $R\langle S \cup I \rangle$ always has a nontrivial neutrosophic subring.

Proof: Let $\langle R \cup I \rangle$ be the neutrosophic ring which is generated by R and I . Clearly $\langle R \cup I \rangle \subseteq R\langle S \cup I \rangle$ and this guaranteed the proof.

Definition .1 : Let $R\langle S \cup I \rangle$ be a neutrosophic LA-semigroup ring. A proper subset T of $R\langle S \cup I \rangle$ which is a pseudo neutrosophic subring. Then we call T to be a pseudo neutrosophic subring of $R\langle S \cup I \rangle$.

Example .1 : Let $\mathbb{Z}_6\langle S \cup I \rangle$ be a neutrosophic LA-semigroup ring of the neutrosophic LA-semigroup $\langle S \cup I \rangle$ over \mathbb{Z}_6 . Then $T = \{0, 3I\}$ is a proper subset of $\mathbb{Z}_6\langle S \cup I \rangle$ which is a pseudo neutrosophic subring of $\mathbb{Z}_6\langle S \cup I \rangle$.

Definition .1 : Let $R\langle S \cup I \rangle$ be a neutrosophic LA-semigroup ring. A proper subset P of $R\langle S \cup I \rangle$ is called a sub LA-semigroup ring if $P = R_1H$ where R_1 is a subring of R and H is a sub LA-semigroup of S . SH is the LA-semigroup ring of the sub LA-semigroup H over the subring R_1 .

Theorem .1 : All neutrosophic LA-semigroup rings have proper sub LA-semigroup rings.

Definition .1 : Let $R\langle S \cup I \rangle$ be a neutrosophic LA-semigroup ring. A proper subset P of $R\langle S \cup I \rangle$ is called a subring but P should not have the LA-semigroup ring structure and is defined to be a subring of $R\langle S \cup I \rangle$.

Definition . : Let $R\langle S \cup I \rangle$ be a neutrosophic LA-semigroup ring. A proper subset P of $R\langle S \cup I \rangle$ is called a neutrosophic ideal of $R\langle S \cup I \rangle$,

1. if P is a neutrosophic subring or subneutrosophic LA-semigroup ring of $R\langle S \cup I \rangle$.
2. For all $p \in P$ and $\alpha \in R\langle S \cup I \rangle$, αp and $p\alpha \in P$.

One can easily define the notions of left or right neutrosophic ideal of the neutrosophic LA-semigroup ring $R\langle S \cup I \rangle$.

Example . 1: Let $\langle S \cup I \rangle = \{1, 2, 3, 1I, 2I, 3I\}$ be a neutrosophic LA-semigroup with the following table.

*	1	2	3	1I	2I	3I
1	3	3	3	3I	3I	3I
2	3	3	3	3I	3I	3I
3	1	3	3	1I	3I	3I
1I	3I	3I	3I	3I	3I	3I
2I	3I	3I	3I	3I	3I	3I
3I	1I	3I	3I	1I	3I	3I

Let $R = \mathbb{Z}$ be the ring of integers. Then $\mathbb{Z}\langle S \cup I \rangle$ is a neutrosophic LA-semigroup ring of the neutrosophic LA-semigroup over the ring \mathbb{Z} . Thus clearly

$P = 2\mathbb{Z}\langle S \cup I \rangle$ is a neutrosophic ideal of $R\langle S \cup I \rangle$.

Definition . : Let $R\langle S \cup I \rangle$ be a neutrosophic LA-semigroup ring. A proper subset P of $R\langle S \cup I \rangle$ is called a pseudo neutrosophic ideal of $R\langle S \cup I \rangle$

1. if P is a pseudo neutrosophic subring or pseudo subneutrosophic LA-semigroup ring of $R\langle S \cup I \rangle$.
2. For all $p \in P$ and $\alpha \in R\langle S \cup I \rangle$, αp and $p\alpha \in P$.

Definition . : Let $R\langle S \cup I \rangle$ be a neutrosophic LA-semigroup ring and let R_1 be any subring (neutrosophic or otherwise). Suppose there exist a subring P in $R\langle S \cup I \rangle$ such that R_1 is an ideal over P i.e,

$rs, sr \in R_1$ for all $p \in P$ and $r \in R$. Then we call R_1 to be a quasi neutrosophic ideal of $R\langle S \cup I \rangle$ relative to P .

If R_1 only happens to be a right or left ideal, then we call R_1 to be a quasi neutrosophic right or left ideal of $R\langle S \cup I \rangle$.

Definition . : Let $R\langle S \cup I \rangle$ be a neutrosophic LA-semigroup ring. If for a given R_1 , we have only one P such that R_1 is a quasi neutrosophic ideal relative to P and for no other P . Then R_1 is termed as loyal quasi neutrosophic ideal relative to P .

Definition . : Let $R\langle S \cup I \rangle$ be a neutrosophic LA-semigroup. If every subring R_1 of $R\langle S \cup I \rangle$ happens to be a loyal quasi neutrosophic ideal relative to a unique P . Then we call the neutrosophic LA-semigroup ring $R\langle S \cup I \rangle$ to be a loyal neutrosophic LA-semigroup ring.

Definition . : Let $R\langle S \cup I \rangle$ be a neutrosophic LA-semigroup ring. If for R_1 , a subring P is another subring ($R_1 \neq P$) such that R_1 is a quasi neutrosophic ideal relative to P . In short P happens to be a quasi neutrosophic ideal relative to R_1 . Then we call (P, R_1) to be a bounded quasi neutrosophic ideal of the neutrosophic LA-semigroup ring $R\langle S \cup I \rangle$.

Similarly we can define bounded quasi neutrosophic right ideals or bounded quasi neutrosophic left ideals.

Definition . : Let $R\langle S \cup I \rangle$ be a neutrosophic LA-semigroup ring and let R_1 be any subring (neutrosophic or otherwise). Suppose there exist a subring P in $R\langle S \cup I \rangle$ such that R_1 is an ideal over P i.e, $rs, sr \in R_1$ for all $p \in P$ and $r \in R$. Then we call R_1

to be a quasi neutrosophic ideal of $R\langle S \cup I \rangle$ relative to P . If R_1 only happens to be a right or left ideal, then we call R_1 to be a quasi neutrosophic right or left ideal of $R\langle S \cup I \rangle$.

Definition . : Let $R\langle S \cup I \rangle$ be a neutrosophic LA-semigroup ring. If for a given R_1 , we have only one P such that R_1 is a quasi neutrosophic ideal relative to P and for no other P . Then R_1 is termed as loyal quasi neutrosophic ideal relative to P .

Definition: Let $R\langle S \cup I \rangle$ be a neutrosophic LA-semigroup. If every subring R_1 of $R\langle S \cup I \rangle$ happens to be a loyal quasi neutrosophic ideal relative to a unique P . Then we call the neutrosophic LA-semigroup ring $R\langle S \cup I \rangle$ to be a loyal neutrosophic LA-semigroup ring.

Definition . : Let $R\langle S \cup I \rangle$ be a neutrosophic LA-semigroup ring. If for R_1 , a subring P is another subring ($R_1 \neq P$) such that R_1 is a quasi neutrosophic ideal relative to P . In short P happens to be a quasi neutrosophic ideal relative to R_1 . Then we call (P, R_1) to be a bounded quasi neutrosophic ideal of the neutrosophic LA-semigroup ring $R\langle S \cup I \rangle$.

Similarly we can define bounded quasi neutrosophic right ideals or bounded quasi neutrosophic left ideals.

One can define pseudo quasi neutrosophic ideal, pseudo loyal quasi neutrosophic ideal and pseudo bounded quasi neutrosophic ideals of a neutrosophic LA-semigroup ring $R\langle S \cup I \rangle$.

. LA-semigroup Neutrosophic Ring

In this section, LA-semigroup Neutrosophic ring is introduced and studied some of their basic properties.

Definition .1: Let S be an LA-semigroup and $\langle R \cup I \rangle$ be a commutative neutrosophic ring with unity.

$\langle R \cup I \rangle[S]$ is defined to be the LA-semigroup neutrosophic ring which consist of all finite formal sums of the form $\sum_{i=1}^n r_i s_i$; $n < \infty$, $r_i \in \langle R \cup I \rangle$ and $s_i \in S$. This

LA-semigroup neutrosophic ring is defined analogous to the group ring or semigroup ring.

Example . : Let $\langle \mathbb{Z}_2 \cup I \rangle = \{0, 1, I, 1 + I\}$ be the neutrosophic ring and let $S = \{1, 2, 3\}$ be an LA-semigroup with the following table:

*	1	2	3
1	1	1	1
2	3	3	3
3	1	1	1

Then $\langle \mathbb{Z}_2 \cup I \rangle[S]$ is an LA-semigroup neutrosophic ring.

Definition . : Let $\langle S \cup I \rangle$ be a neutrosophic LA-semigroup and $\langle K \cup I \rangle$ be a neutrosophic field or a commutative neutrosophic ring with unity.

$\langle K \cup I \rangle[\langle S \cup I \rangle]$ is defined to be the neutrosophic LA-semigroup neutrosophic ring which consist of all finite formal sums of the form $\sum_{i=1}^n r_i s_i$; $n < \infty$, $r_i \in \langle K \cup I \rangle$ and $s_i \in S$.

Example . : Let $\langle \mathbb{Z} \cup I \rangle$ be the ring of integers and let $N(S) = \{1, 2, 3, 4, 1I, 2I, 3I, 4I\}$ be a neutrosophic LA-semigroup with the following table.

	1	2	3	4	1I	2I	3I	4I
1	1	4	2	3	1I	4I	2I	3I
2	3	2	4	1	3I	2I	4I	1I
3	4	1	3	2	4I	1I	3I	2I
4	2	3	1	4	2I	3I	1I	4I

1I	1I	4I	2I	3I	1I	4I	2I	3I
2I	3I	2I	4I	1I	3I	2I	4I	1I
3I	4I	1I	3I	2I	4I	1I	3I	2I
4I	2I	3I	1I	4I	2I	3I	1I	4I

Then $\langle \mathbb{Z} \cup I \rangle \langle S \cup I \rangle$ is a neutrosophic LA-semigroup neutrosophic ring.

Theorem . : Every neutrosophic LA-semigroup neutrosophic ring contains a proper subset which is a neutrosophic LA-semigroup ring.

Proof: Let $\langle R \cup I \rangle \langle S \cup I \rangle$ be a neutrosophic LA-semigroup neutrosophic ring and let $T = R \langle S \cup I \rangle$ be a proper subset of $\langle R \cup I \rangle \langle S \cup I \rangle$. Thus clearly $T = R \langle S \cup I \rangle$ is a neutrosophic LA-semigroup ring.

Conclusion

In this paper, we introduced neutrosophic LA-semigroup rings which are more general concept than neutrosophic semigroup rings. These neutrosophic LA-semigroup rings are defined analogously to neutrosophic semigroup rings. We have studied several properties of neutrosophic LA-semigroup rings and also define different kind of neutrosophic LA-semigroup rings.

References

- [1] M. Ali, M. Shabir, M. Naz and F. Smarandache, Neutrosophic Left Almost Semigroup, Neutrosophic Sets and Systems, 3 (2014), 18-28.
- [2] P. Holgate: Groupoids satisfying a simple invertive law, The Math. Student 61 (1992).
- [3] W. B. V. Kandasamy, and F. Smarandache, Some Neutrosophic Algebraic Structures and Neutrosophic N-Algebraic Structures, 219 p., Hexis, 2006.
- [4] W. B. V. Kandasamy, and F. Smarandache, N-Algebraic Structures and S-N-Algebraic Structures, 209 pp., Hexis, Phoenix, 2006.
- [5] W. B. V. Kandasamy, and F. Smarandache, Neutrosophic Rings, Hexis, Phoenix, 2006.

- [6] W. B. V. Kandasamy, and F. Smarandache, Basic Neutrosophic Algebraic Structures and their Applications to Fuzzy and Neutrosophic Models, Hexis, 149 pp., 2004.
- [7] M. Kazim and M. Naseeruddin: On almost semigroups, *Alig. Bull. Math.*2 (1972).
- [8] M. Khan and N. Ahmad, Characterizations of left almost semigroups by their ideals, *Journal of Advanced Research in Pure mathematics*, 2 (2010), 61 – 73.
- [9] Q. Mushtaq and M. S. Kamran: On left almost groups, *Proc. Pak. Acad. Sci.* 331 (1996), 53-55.
- [10] Q. Mushtaq and M. Khan, Ideals in left almost semigroups, *Proceedings of 4th International Pure mathematics Conference*, 2003, 65 – 77.
- [11] P. V. Protic, and N. Stevanovic, AG-test and some general properties of Abel-grassmann's groupoids, *PU. M. A*, 4,6 (1995), 371 – 383.
- [12] M. Shabir, S. Naz, Pure spectrum of an ag-groupoid with left identity and zero, *World Applied Sciences Journal* 17 (2012) 1759-1768.
- [13] F. Smarandache, *A Unifying Field in Logics. Neutrosophy, Neutrosophic Probability, Set and Logic.* Rehoboth: American Research Press, (1999).

Neutrosophic Set Approach for Characterizations of Left Almost Semigroups

Madad Khan, Florentin Smarandache, Sania Afzal

Madad Khan, Florentin Smarandache, Sania Afzal (2016). Neutrosophic Set Approach for Characterizations of Left Almost Semigroups. *Neutrosophic Sets and Systems* 11, 79-94

Abstract. In this paper we have defined neutrosophic ideals, neutrosophic interior ideals, neutrosophic quasi-ideals and neutrosophic bi-ideals (neutrosophic generalized bi-ideals) and proved some results related to them. Furthermore, we have done some characterization of a neutrosophic LA-semigroup by the properties of its neutrosophic ideals. It has been proved that in a

neutrosophic intra-regular LA-semigroup neutrosophic left, right, two-sided, interior, bi-ideal, generalized bi-ideal and quasi-ideals coincide and we have also proved that the set of neutrosophic ideals of a neutrosophic intra-regular LA-semigroup forms a semilattice structure.

Keywords: Neutrosophic LA-semigroup; neutrosophic intra-regular LA-semigroup; neutrosophic left invertive law; neutrosophic ideal.

Introduction

It is well known fact that common models with their limited and restricted boundaries of truth and falsehood are insufficient to detect the reality so there is a need to discover and introduce some other phenomenon that address the daily life problems in a more appropriate way. In different fields of life many problems arise which are full of uncertainties and classical methods are not enough to deal and solve them. In fact, reality of real life problems cannot be represented by models with just crisp assumptions with only yes or no because of such certain assumptions may lead us to completely wrong solutions. To overcome this problem, Lotfi A.Zadeh in 1965 introduced the idea of a fuzzy set which help to describe the behaviour of systems that are too complex or are ill-defined to admit precise mathematical analysis by classical methods. He discovered the relationships of probability and fuzzy set theory which has appropriate approach to deal with uncertainties. According to him every set is not crisp and fuzzy set is one of the example that is not crisp. This fuzzy set help us to reduce the chances of failures in modelling.. Many authors have applied the fuzzy set theory to generalize the basic theories of Algebra. Mordeson et al. has discovered the grand exploration of fuzzy semigroups, where theory of fuzzy semigroups is explored along with the applications of fuzzy semigroups in fuzzy coding, fuzzy finite state mechanics and fuzzy languages etc.

Zadeh introduced the degree of membership/truth (t) in 1965 and defined the fuzzy set. Atanassov introduced the degree of nonmembership/falsehood (f) in 1986 and defined the intuitionistic fuzzy set. Smarandache introduced the degree of indeterminacy/neutrality (i) as

independent component in 1995 (published in 1998) and defined the neutrosophic set. He has coined the words neutrosophy and neutrosophic. In 2013 he refined the neutrosophic set to n components: $t_1, t_2, \dots ; i_1, i_2, \dots ;$

f_1, f_2, \dots . The words neutrosophy and neutrosophic were coined/invented by F. Smarandache in his 1998 book. Etymologically, neutro-sophy (noun) [French neutre Latin neuter, neutral, and Greek sophia, skill/wisdom] means knowledge of neutral thought. While neutrosophic (adjective), means having the nature of, or having the characteristic of Neutrosophy.

Recently, several theories have been presented to dispute with uncertainty, vagueness and imprecision. Theory of probability, fuzzy set theory, intuitionistic fuzzy sets, rough set theory etc., are consistently being used as actively operative tools to deal with multiform uncertainties and imprecision enclosed in a system. But all these above theories failed to deal with indeterminate and inconsistent information. Therefore, due to the existence of indeterminacy in various world problems, neutrosophy finds its way into the modern research. Neutrosophy was developed in attempt to generalize fuzzy logic. Neutrosophy is a Latin word neuter - neutral, Greek sophia - skill/wisdom). Neutrosophy is a branch of philosophy, introduced by Florentin Smarandache which studies the origin, nature, and scope of neutralities, as well as their interactions with different ideational spectra. Neutrosophy considers a proposition, theory, event, concept, or entity, A in relation to its opposite, Anti- A and that which is not A , Non- A , and that which is neither A nor Anti- A , denoted by Neut- A . Neutrosophy is

the basis of neutrosophic logic, neutrosophic probability, neutrosophic set, and neutrosophic statistics.

Inspiring from the realities of real life phenomenons like sport games (winning/ tie/ defeating), votes (yes/ NA/ no) and decision making (making a decision/ hesitating/ not making), F. Smrandache introduced a new concept of a neutrosophic set (NS in short) in 1995, which is the generalization of a fuzzy sets and intuitionistic fuzzy set. NS is described by membership degree, indeterminate degree and non-membership degree. The idea of NS generates the theory of neutrosophic sets by giving representation to indeterminates. This theory is considered as complete representation of almost every model of all real-world problems. Therefore, if uncertainty is involved in a problem we use fuzzy theory while dealing indeterminacy, we need neutrosophic theory. In fact this theory has several applications in many different fields like control theory, databases, medical diagnosis problem and decision making problems.

Using Neutrosophic theory, Vasantha Kandasmy and Florentin Smarandache introduced the concept of neutrosophic algebraic structures in 2003. Some of the neutrosophic algebraic structures introduced and studied including neutrosophic fields, neutrosophic vector spaces, neutrosophic groups, neutrosophic bigroups, neutrosophic N-groups, neutrosophic bisemigroups, neutrosophic N-semigroup, neutrosophic loops, neutrosophic biloops, neutrosophic N-loop, neutrosophic groupoids, neutrosophic bigroupoids and neutrosophic AG-groupoids. Madad Khan et al., for the first time introduced the idea of a neutrosophic AG-groupoid in [13].

1 Preliminaries

Abel-Grassmann's Groupoid (abbreviated as an AG-groupoid or LA-semigroup) was first introduced by Naseeruddin and Kazim in 1972. LA-semigroup is a groupoid S whose elements satisfy the left invertive law $(ab)c = (cb)a$ for all $a, b, c \in S$. LA-semigroup generalizes the concept of commutative semigroups and have an important application within the theory of flocks. In addition to applications, a variety of properties have been studied for AG-groupoids and related structures. An LA-semigroup is a non-associative algebraic structure that is generally considered as a midway between a groupoid and a commutative semigroup but is very close to commutative semigroup because most of their properties are similar to commutative semigroup. Every commutative semigroup is an AG-groupoid but not vice versa. Thus AG-groupoids can also be non-associative, however, they do not necessarily have the Latin square property. An LA-semigroup S can have left identity e (unique) i.e $ea = a$ for all $a \in S$ but it cannot have a right identity because if it has, then S becomes a commutative semigroup. An

element s of LA-semigroup S is called idempotent if $s^2 = s$ and if holds for all elements of S then S is called idempotent LA-semigroup.

Since the world is full of indeterminacy, the neutrosophics found their place into contemporary research. In 1995, Florentin Smarandache introduced the idea of neutrosophy. Neutrosophic logic is an extension of fuzzy logic. In 2003 W.B Vasantha Kandasamy and Florentin Smarandache introduced algebraic structures (such as neutrosophic semigroup, neutrosophic ring, etc.). Madad Khan et al., for the first time introduced the idea of a neutrosophic LA-semigroup in [Madad Saima]. Moreover $SUI = \{a + bI : \text{where } a, b \in S \text{ and } I \text{ is literal indeterminacy such that } I^2 = I\}$ becomes neutrosophic LA-semigroup under the operation defined as:

$(a + bI) * (c + dI) = ac + bdl$ for all $(a + bI), (c + dI) \in SUI$. That is $(SUI, *)$ becomes neutrosophic LA-semigroup. They represented it by $N(S)$.

$[(a_1 + a_2I)(b_1 + b_2I)](c_1 + c_2I) = [(c_1 + c_2I)(b_1 + b_2I)](a_1 + a_2I)$, holds for all $(a_1 + a_2I), (b_1 + b_2I), (c_1 + c_2I) \in N(S)$.

It is since then called the neutrosophic left invertive law. A neutrosophic groupoid satisfying the left invertive law is called a neutrosophic left almost semigroup and is abbreviated as neutrosophic LA-semigroup.

In a neutrosophic LA-semigroup $N(S)$ medial law holds i.e

$[(a_1 + a_2I)(b_1 + b_2I)][(c_1 + c_2I)(d_1 + d_2I)] = [(a_1 + a_2I)(c_1 + c_2I)][(b_1 + b_2I)(d_1 + d_2I)]$, holds

for all $(a_1 + a_2I), (b_1 + b_2I), (c_1 + c_2I), (d_1 + d_2I) \in N(S)$.

There can be a unique left identity in a neutrosophic LA-semigroup. In a neutrosophic LA-semigroup $N(S)$ with left identity $(e + eI)$ the following laws hold for all $(a_1 + a_2I), (b_1 + b_2I), (c_1 + c_2I), (d_1 + d_2I) \in N(S)$.

$[(a_1 + a_2I)(b_1 + b_2I)][(c_1 + c_2I)(d_1 + d_2I)] = [(d_1 + d_2I)(b_1 + b_2I)][(c_1 + c_2I)(a_1 + a_2I)]$,
 $[(a_1 + a_2I)(b_1 + b_2I)][(c_1 + c_2I)(d_1 + d_2I)] = [(d_1 + d_2I)(c_1 + c_2I)][(b_1 + b_2I)(a_1 + a_2I)]$, and

$(a_1 + a_2I)[(b_1 + b_2I)(c_1 + c_2I)] = (b_1 + b_2I)[(a_1 + a_2I)(c_1 + c_2I)]$.

(3) is called neutrosophic paramedial law and a neutrosophic LA semigroup satisfies (5) is called

neutrosophic AG -groupoid.

Now, $(a + bI)^2 = a + bI$ implies $a + bI$ is idempotent and if holds for all $a + bI \in N(S)$ then $N(S)$ is called idempotent neutrosophic LA-semigroup.

2 Neutrosophic LA-semigroups

Example 2.1 Let $S = \{1, 2, 3\}$ with binary operation " \cdot " is an LA-semigroup with left identity 3 and has the following Calley's table:

\cdot	1	2	3
1	3	1	2
2	2	3	1
3	1	2	3

then

$N(S) = \{1+1I, 1+2I, 1+3I, 2+1I, 2+2I, 2+3I, 3+1I, 3-2I, 3-3I\}$

is an example of neutrosophic LA-semigroup under the operation $*$ and has the following Callay's table:

$*$	1+1I	1+2I	1+3I	2+1I	2+2I	2+3I	3+1I	3+2I	3+3I
1+1I	3+3I	3+1I	3+2I	1+3I	1+1I	1+2I	2+3I	2+1I	2+2I
1+2I	3+2I	3+3I	3+1I	1+2I	1+3I	1+1I	2+2I	2+3I	2+1I
1+3I	3+1I	3+2I	3+3I	1+1I	1+2I	1+3I	2+1I	2+2I	2+3I
2+1I	2+3I	2+1I	2+2I	3+3I	3+1I	3+2I	1+3I	1+1I	1+2I
2+2I	2+2I	2+3I	2+1I	3+2I	3+3I	3+1I	1+2I	1+3I	1+1I
2+3I	2+1I	2+2I	2+3I	3+1I	3+2I	3+3I	1+1I	1+2I	1+3I
3+1I	1+3I	1+1I	1+2I	2+3I	2+1I	2+2I	3+3I	3+1I	3+2I
3+2I	1+2I	1+3I	1+1I	2+2I	2+3I	2+1I	3+2I	3+3I	3+1I
3+3I	1+1I	1+2I	1+3I	2+1I	2+2I	2+3I	3+1I	3+2I	3+3I

It is important to note that if $N(S)$ contains left identity $3+3I$ then $(N(S))^2 = N(S)$.

Lemma 2.1: If a neutrosophic LA-semigroup $N(S)$ contains left identity $e + Ie$ then the following conditions hold.

- (i) $N(S)N(L) = N(L)$ for every neutrosophic left ideal $N(L)$ of $N(S)$.
- (ii) $N(R)N(S) = N(R)$ for every neutrosophic right ideal $N(R)$ of $N(S)$.

Proof (i) Let $N(L)$ be the neutrosophic left ideal of $N(S)$ implies that $N(S)N(L) \subseteq N(L)$. Let $a + bI \in N(L)$ and since $a + bI = (e + eI)(a + bI) \in N(S)N(L)$ which implies that $N(L) \subseteq N(S)N(L)$. Thus $N(L) = N(S)N(L)$.

(ii) Let $N(R)$ be the neutrosophic right ideal of $N(S)$.

Then $N(R)N(S) \subseteq N(R)$. Now, let $a + bI \in N(R)$. Then

$$\begin{aligned} a + bI &= (e + eI)(a + bI) \\ &= [(e + eI)(e + eI)](a + bI) \\ &= [(a + bI)(e + eI)](e + eI) \\ &\in (N(R)N(S))N(S) \\ &\subseteq N(R)N(S). \end{aligned}$$

Thus $N(R) \subseteq N(R)N(S)$. Hence $N(R)N(S) = N(R)$.

A subset $N(Q)$ of an neutrosophic LA-semigroup is called neutrosophic quasi-ideal if $N(Q)N(S) \cap N(S)N(Q) \subseteq N(Q)$. A subset $N(I)$ of an LA-semigroup $N(S)$ is called idempotent if $(N(I))^2 = N(I)$.

Lemma 2.2: The intersection of a neutrosophic left ideal $N(L)$ and a neutrosophic right ideal $N(R)$ of a neutrosophic LA-semigroup $N(S)$ is a neutrosophic quasi-ideal of $N(S)$.

Proof Let $N(L)$ and $N(R)$ be the neutrosophic left and right ideals of neutrosophic LA-semigroup $N(S)$ resp.

Since $N(L) \cap N(R) \subseteq N(R)$ and $N(L) \cap N(R) \subseteq N(L)$ and $N(S)N(L) \subseteq N(L)$ and $N(R)N(S) \subseteq N(R)$. Thus

$$\begin{aligned} &(N(L) \cap N(R))N(S) \cap N(S)(N(L) \cap N(R)) \\ &\subseteq N(R)N(S) \cap N(S)N(L) \\ &\subseteq N(R) \cap N(L) \\ &= N(L) \cap N(R). \end{aligned}$$

Hence, $N(L) \cap N(R)$ is a neutrosophic quasi-ideal of $N(S)$.

A subset (neutrosophic LA-subsemigroup) $N(B)$ of a neutrosophic LA-semigroup $N(S)$ is called neutrosophic generalized bi-ideal (neutrosophic bi-ideal) of $N(S)$ if $(N(B)N(S))N(B) \subseteq N(B)$.

Lemma 2.3: If $N(B)$ is a neutrosophic bi-ideal of a neutrosophic LA-semigroup $N(S)$ with left identity $e + eI$, then $((x_1 + Iy_1)N(B))(x_2 + Iy_2)$ is also a neutrosophic bi-ideal of $N(S)$, for any $x_1 + Iy_1$ and $x_2 + Iy_2$ in $N(S)$.

Proof Let $N(B)$ be a neutrosophic bi-ideal of $N(S)$, $(x_2 + y_2I) \in N(M)$, we have now using (1), (2), (3) and (4), we get

$$\begin{aligned} & [\{(x_1 + y_1I)N(B)\}(x_2 + y_2I)N(S)][\{(x_1 + y_1I)N(B)\}(x_2 + y_2I)] \\ &= [\{N(S)(x_2 + y_2I)\}\{(x_1 + y_1I)N(B)\}][\{(x_1 + y_1I)N(B)\}(x_2 + y_2I)] \\ &= [\{(x_1 + y_1I)N(B)\}(x_2 + y_2I)\}\{(x_1 + y_1I)N(B)\}][N(S)(x_2 + y_2I)] \\ &= [\{(x_1 + y_1I)N(B)\}(x_1 + y_1I)\}\{(x_2 + y_2I)N(B)\}][N(S)(x_2 + y_2I)] \\ &= [\{(x_1 + y_1I)N(B)\}(x_1 + y_1I)N(S)][\{(x_2 + y_2I)N(B)\}(x_2 + y_2I)] \\ &= [\{N(S)(x_1 + y_1I)\}\{(x_1 + y_1I)N(B)\}][\{(x_2 + y_2I)N(B)\}(x_2 + y_2I)] \\ &= [\{N(B)(x_1 + y_1I)\}\{(x_1 + y_1I)N(S)\}][\{(x_2 + y_2I)N(B)\}(x_2 + y_2I)] \\ &= [\{N(B)(x_1 + y_1I)\}\{(x_2 + y_2I)N(B)\}][\{(x_1 + y_1I)N(S)\}(x_2 + y_2I)] \\ &\subseteq [\{N(B)(x_1 + y_1I)\}\{(x_2 + y_2I)N(B)\}]N(S) \\ &= [\{N(B)(x_1 + y_1I)\}\{(x_2 + y_2I)N(B)\}][e + eI]N(S) \\ &= [\{N(B)(x_1 + y_1I)\}(e + eI)][\{(x_2 + y_2I)N(B)\}N(S)] \\ &= [\{(e + eI)(x_1 + y_1I)N(B)\}][\{N(S)N(B)\}(x_2 + y_2I)] \\ &= [(x_2 + y_2I)\{N(S)N(B)\}][N(B)(x_1 + y_1I)] \\ &= [\{(e + eI)(x_2 + y_2I)\}(N(S)N(B))][N(B)(x_1 + y_1I)] \\ &= [\{N(B)N(S)\}\{(x_2 + y_2I)(e + eI)\}][N(B)(x_1 + y_1I)] \\ &= [(N(B)N(S))N(B)][\{(x_2 + y_2I)(e + eI)\}(x_1 + y_1I)] \\ &\subseteq N(B)[\{(x_2 + y_2I)(e + eI)\}(x_1 + y_1I)] \\ &= [(x_2 + y_2I)(e + eI)][N(B)(x_1 + y_1I)] \\ &= [(x_1 + y_1I)N(B)][(e + eI)(x_2 + y_2I)] \\ &= [(x_1 + y_1I)N(B)](x_2 + y_2I). \end{aligned}$$

A subset $N(I)$ of a neutrosophic LA-semigroup $N(S)$ is called a neutrosophic interior ideal if $(N(S)N(I))N(S) \subseteq N(I)$.

A subset $N(M)$ of a neutrosophic LA-semigroup $N(S)$ is called a neutrosophic minimal left (right, two sided, interior, quasi- or bi-) ideal if it does not contains any other neutrosophic left (right, two sided, interior, quasi- or bi-) ideal of $N(S)$ other than itself.

Lemma 2.4: If $N(M)$ is a minimal bi-ideal of $N(S)$ with left identity and $N(B)$ is any arbitrary neutrosophic bi-ideal of $N(S)$, then $N(M) = ((x_1 + Iy_1)N(B))(x_2 + Iy_2)$, for every $(x_1 + y_1I), (x_2 + y_2I) \in N(M)$.

Proof Let $N(M)$ be a neutrosophic minimal bi-ideal and $N(B)$ be any neutrosophic bi-ideal of $N(S)$, then by Lemma 2.3, $[(x_1 + y_1I)N(B)](x_2 + y_2I)$ is a neutrosophic bi-ideal of $N(S)$ for every $(x_1 + y_1I), (x_2 + y_2I) \in N(S)$. Let $(x_1 + y_1I)$,

$$\begin{aligned} [(x_1 + y_1I)N(B)](x_2 + y_2I) &\subseteq [N(M)N(B)]N(M) \\ &\subseteq [N(M)N(S)]N(M) \\ &\subseteq N(M). \end{aligned}$$

But $N(M)$ is a neutrosophic minimal bi-ideal, so $[(x_1 + y_1I)N(B)](x_2 + y_2I) = N(M)$.

Lemma 2.5: In a neutrosophic LA-semigroup $N(S)$ with left identity, every idempotent neutrosophic quasi-ideal is a neutrosophic bi-ideal of $N(S)$.

Proof Let $N(Q)$ be an idempotent neutrosophic quasi-ideal of $N(S)$, then clearly $N(Q)$ is a neutrosophic LA-subsemigroup too.

$$\begin{aligned} (N(Q)N(S))N(Q) &\subseteq (N(Q)N(S))N(S) \\ &= (N(S)N(S))N(Q) \\ &= N(S)N(Q), \text{ and} \\ (N(Q)N(S))N(Q) &\subseteq (N(S)N(S))N(Q) \\ &= (N(S)N(S))(N(Q)N(Q)) \\ &= (N(Q)N(Q))(N(S)N(S)) \\ &= N(Q)N(S). \end{aligned}$$

Thus

$$(N(Q)N(S))N(Q) \subseteq (N(Q)N(S)) \cap (N(S)N(Q)) \subseteq N(Q).$$

Hence, $N(Q)$ is a neutrosophic bi-ideal of $N(S)$.

Lemma 2.6: If $N(A)$ is an idempotent neutrosophic quasi-ideal of a neutrosophic LA-semigroup $N(S)$ with left identity $e + eI$, then $N(A)N(B)$ is a neutrosophic bi-ideal of $N(S)$, where $N(B)$ is any neutrosophic subset of $N(S)$.

Proof Let $N(A)$ be the neutrosophic quasi-ideal of $N(S)$ and $N(B)$ be any subset of $N(S)$.

$$\begin{aligned} & ((N(A)N(B))N(S))(N(A)N(B)) \\ &= ((N(S)N(B))N(A))(N(A)N(B)) \\ &\subseteq ((N(S)N(S))N(A))(N(A)N(B)) \\ &= (N(S)N(A))(N(A)N(B)) \\ &= (N(B)N(A))(N(A)N(S)) \\ &= ((N(A)N(S))N(A))N(B) \\ &\subseteq N(A)N(B) \end{aligned}$$

Hence $N(A)N(B)$ is neutrosophic bi-ideal of $N(S)$.

Lemma 2.7: If $N(L)$ is a neutrosophic left ideal and $N(R)$ is a neutrosophic right ideal of a neutrosophic LA-semigroup $N(S)$ with left identity $e + eI$ then $N(L) \cup N(L)N(S)$ and $N(R) \cup N(S)N(R)$ are neutrosophic two sided ideals of $N(S)$.

Proof Let $N(R)$ be a neutrosophic right ideal of $N(S)$ then by using (3) and (4), we have

$$\begin{aligned} & [N(R) \cup N(S)N(R)]N(S) \\ &= N(R)N(S) \cup [N(S)N(R)]N(S) \\ &\subseteq N(R) \cup [N(S)N(R)][N(S)N(S)] \\ &= N(R) \cup [N(S)N(S)][N(R)N(S)] \\ &= N(R) \cup N(S)[N(R)N(S)] \\ &= N(R) \cup N(R)[N(S)N(S)] \\ &= N(R) \cup N(R)N(S) \\ &= N(R) \subseteq N(R) \cup N(S)N(R). \end{aligned}$$

and

$$\begin{aligned} & N(S)[N(R) \cup N(S)N(R)] \\ &= N(S)N(R) \cup N(S)[N(S)N(R)] \\ &= N(S)N(R) \cup [N(S)N(S)][N(S)N(R)] \\ &= N(S)N(R) \cup [N(R)N(S)][N(S)N(S)] \\ &\subseteq N(S)N(R) \cup N(R)[N(S)N(S)] \\ &= N(S)N(R) \cup N(R)N(S) \\ &\subseteq N(S)N(R) \cup N(R) \\ &= N(R) \cup N(S)N(R). \end{aligned}$$

Hence $[N(R) \cup N(S)N(R)]$ is a neutrosophic two sided ideal of $N(S)$. Similarly we can show that $[N(L) \cup N(S)N(L)]$ is a neutrosophic two-sided ideal of $N(S)$.

Lemma 2.8: A subset $N(I)$ of a neutrosophic LA-semigroup $N(S)$ with left identity $e + eI$ is a neutrosophic right ideal of $N(S)$ if and only if it is a neutrosophic interior ideal of $N(S)$.

Proof Let $N(I)$ be a neutrosophic right ideal of $N(S)$

$$\begin{aligned} N(S)N(I) &= [N(S)N(S)]N(I) \\ &= [N(I)N(S)]N(S) \\ &\subseteq N(I)N(S) \\ &\subseteq N(I). \end{aligned}$$

So $N(I)$ is a neutrosophic two-sided ideal of $N(S)$, so

is a neutrosophic interior ideal of $N(S)$.

Conversely, assume that $N(I)$ is a neutrosophic interior ideal of $N(S)$, then by using (4) and (3), we have

$$\begin{aligned} N(I)N(S) &= N(I)[N(S)N(S)] \\ &= N(S)[N(I)N(S)] \\ &= [N(S)N(S)][N(I)N(S)] \\ &= [N(S)N(I)][N(S)N(S)] \\ &= [N(S)N(I)]N(S) \\ &\subseteq N(I). \end{aligned}$$

If $N(A)$ and $N(M)$ are neutrosophic two-sided ideals of a neutrosophic LA-semigroup $N(S)$, such that $(N(A))^2 \subseteq N(M)$ implies $N(A) \subseteq N(M)$, then $N(M)$ is called neutrosophic semiprime.

Theorem 2.1: In a neutrosophic LA-semigroup $N(S)$ with left identity $e + eI$, the following conditions are equivalent.

(i) If $N(A)$ and $N(M)$ are neutrosophic two-sided ideals of $N(S)$, then $(N(A))^2 \subseteq N(M)$ implies $N(A) \subseteq N(M)$.

(ii) If $N(R)$ is a neutrosophic right ideal of $N(S)$ and $N(M)$ is a neutrosophic two-sided ideal of $N(S)$ then $(N(R))^2 \subseteq N(M)$ implies $N(R) \subseteq N(M)$.

(iii) If $N(L)$ is a neutrosophic left ideal of $N(S)$ and $N(M)$ is a neutrosophic two-sided ideal of $N(S)$ then $(N(L))^2 \subseteq N(M)$ implies $N(L) \subseteq N(M)$.

Proof (i) \Rightarrow (iii)

Let $N(L)$ be a left ideal of $N(S)$ and $[N(L)]^2 \subseteq N(M)$, then by Lemma ref: slrs, $N(L) \cup N(L)N(S)$ is a neutrosophic two sided ideal of $N(S)$, therefore by assumption (i), we have $[N(L) \cup N(L)N(S)]^2 \subseteq N(M)$ which implies $[N(L) \cup N(L)N(S)] \subseteq N(M)$ which further implies that $N(L) \subseteq N(M)$.

(iii) \Rightarrow (ii) and (ii) \Rightarrow (i) are obvious.

Theorem 2.2: A neutrosophic left ideal $N(M)$ of a neutrosophic LA-semigroup $N(S)$ with left identity $e + eI$ is neutrosophic quasi semiprime if and only if $(a_1 + b_1I)^2 \in N(M)$ implies $a_1 + b_1I \in N(M)$.

Proof Let $N(M)$ be a neutrosophic semiprime left ideal of $N(S)$ and $(a_1 + b_1I)^2 \in N(M)$. Since $N(S)(a_1 + b_1I)^2$ is a neutrosophic left ideal of $N(S)$ containing $(a_1 + b_1I)^2$, also $(a_1 + b_1I)^2 \in N(M)$, therefore we have $(a_1 + b_1I)^2 \in N(S)(a_1 + b_1I)^2 \subseteq N(M)$. But by using (2), we have

$$\begin{aligned} N(S)[a_1 + b_1I]^2 &= N(S)[(a_1 + b_1I)(a_1 + b_1I)] \\ &= [N(S)N(S)][(a_1 + b_1I)(a_1 + b_1I)] \\ &= [N(S)(a_1 + b_1I)][N(S)(a_1 + b_1I)] \\ &= [N(S)(a_1 + b_1I)]^2. \end{aligned}$$

Therefore, $[N(S)(a_1 + b_1I)]^2 \subseteq N(M)$, but $N(M)$ is neutrosophic semiprime ideal so $N(S)(a_1 + b_1I) \subseteq N(M)$. Since $(a_1 + b_1I) \in N(S)(a_1 + b_1I)$, therefore $(a_1 + b_1I) \in N(M)$.

Conversely, assume that $N(I)$ is an ideal of $N(S)$ and let $(N(I))^2 \subseteq N(M)$ and $(a_1 + b_1I) \in N(I)$ implies that $(a_1 + b_1I)^2 \in (N(I))^2$, which implies that $(a_1 + b_1I)^2 \in N(M)$ which further implies that $(a_1 + b_1I) \in N(M)$. Therefore, $(N(I))^2 \subseteq N(M)$ implies $N(I) \subseteq N(M)$. Hence $N(M)$ is a neutrosophic semiprime ideal.

A neutrosophic LA-semigroup $N(S)$ is called neutrosophic left (right) quasi-regular if every neutrosophic left (right) ideal of $N(S)$ is idempotent.

Theorem 2.3: A neutrosophic LA-semigroup $N(S)$ with left identity is neutrosophic left quasi-regular if and only if $a + bI \in [N(S)(a + bI)][N(S)(a + bI)]$.

Proof Let $N(L)$ be any left ideal of $N(S)$ and $a + bI \in [N(S)(a + bI)][N(S)(a + bI)]$. Now for each $l_1 + l_2I \in N(L)$, we have

$$\begin{aligned} l_1 + l_2I &\in [N(S)(l_1 + l_2I)][N(S)(l_1 + l_2I)] \\ &\subseteq [N(S)N(L)][N(S)N(L)] \\ &\subseteq N(L)N(L) = (N(L))^2. \end{aligned}$$

Therefore, $N(L) = (N(L))^2$.

Conversely, assume that $N(A) = (N(A))^2$ for every neutrosophic left ideal $N(A)$ of $N(S)$. Since $N(S)(a + bI)$ is a neutrosophic left ideal of $N(S)$. So, $a + bI \in N(S)(a + bI) = [N(S)(a + bI)][N(S)(a + bI)]$.

Theorem 2.4: The subset $N(I)$ of a neutrosophic left quasi-regular LA-semigroup $N(S)$ is a neutrosophic left ideal of $N(S)$ if and only if it is a neutrosophic right ideal of $N(S)$.

Proof Let $N(L)$ be a neutrosophic left ideal of $N(S)$ and $s_1 + s_2I \in N(S)$ therefore, by Theorem 2.3 and (1), we have

$$\begin{aligned} &(l_1 + l_2I)(s_1 + s_2I) \\ &= [\{(x_1 + x_2I)(l_1 + l_2I)\} \{(y_1 + y_2I)(l_1 + l_2I)\}](s_1 + s_2I) \\ &= [\{(s_1 + s_2I)\{(y_1 + y_2I)(l_1 + l_2I)\}\}][\{(x_1 + x_2I)(l_1 + l_2I)\}] \\ &\in [\{N(S)\{N(S)N(L)\}\}][N(S)N(L)] \\ &= [N(S)N(L)][N(S)N(L)] \\ &\subseteq N(L)N(L) = N(L). \end{aligned}$$

Conversely, assume that $N(I)$ is a neutrosophic right ideal of $N(S)$, as $N(S)$ is itself a neutrosophic left ideal and by assumption $N(S)$ is idempotent, therefore by using (2), we have

$$\begin{aligned} N(S)N(I) &= [N(S)N(S)]N(I) \\ &= [N(I)N(S)]N(S) \\ &\subseteq N(I)N(S) \subseteq N(I). \end{aligned}$$

This implies $N(I)$ is neutrosophic left bideal too.

Lemma 2.9: The intersection of any number of neutrosophic quasi-ideals of $N(S)$ is either empty or quasi-ideal of $N(S)$.

Proof Let $N(Q_1)$ and $N(Q_2)$ be two neutrosophic quasi-ideals of neutrosophic LA-semigroup $N(S)$. If $N(Q_1)$ and $N(Q_2)$ are distinct then their intersection must be empty but if not then

$$\begin{aligned} &N(S)[N(Q_1) \cap N(Q_2)] \cap [N(Q_1) \cap N(Q_2)]N(S) \\ &= [N(S)N(Q_1) \cap N(S)N(Q_2)] \cap [N(Q_1)N(S) \cap N(Q_2)N(S)] \\ &= [N(S)N(Q_1) \cap N(Q_1)N(S)] \cap [N(S)N(Q_2) \cap N(Q_2)N(S)] \\ &\subseteq N(Q_1) \cap N(Q_2). \end{aligned}$$

Therefore, $N(Q_1) \cap N(Q_2)$ is a neutrosophic quasi-ideal.

Now, generalizing the result and let

$N(Q_1), N(Q_2), \dots, N(Q_n)$ be the n-number of neutrosophic quasi ideals of neutrosophic quasi-ideals of $N(S)$ and assume that their intersection is not empty then

$$\begin{aligned} & N(S)[N(Q_1) \cap N(Q_2) \cap \dots \cap N(Q_n)] \cap [N(Q_1) \cap N(Q_2) \cap \dots \cap N(Q_n)]N(S) \\ &= [N(S)N(Q_1) \cap N(S)N(Q_2) \cap \dots \cap N(S)N(Q_n)] \cap \\ & \quad [N(Q_1)N(S) \cap N(Q_2)N(S) \cap \dots \cap N(Q_n)N(S)] \\ &= [N(S)N(Q_1) \cap N(Q_1)N(S)] \cap [N(S)N(Q_2) \cap \\ & \quad N(Q_2)N(S)] \dots [N(S)N(Q_n) \cap N(Q_n)N(S)] \\ &\subseteq N(Q_1) \cap N(Q_2) \cap \dots \cap N(Q_n). \end{aligned}$$

Hence $N(Q_1) \cap N(Q_2) \cap \dots \cap N(Q_n)$ is a neutrosophic quasi-ideal.

Therefore, the intersection of any number of neutrosophic quasi-ideals of $N(S)$ is either empty or quasi-ideal of $N(S)$.

3 Neutrosophic Regular LA-semigroups

An element $a + bI$ of a neutrosophic LA-semigroup $N(S)$ is called regular if there exists $x + yI \in N(S)$ such that $a + bI = [(a + bI)(x + yI)](a + bI)$, and $N(S)$ is called neutrosophic regular LA-semigroup if every element of $N(S)$ is regular.

Example Let $S = \{1, 2, 3\}$ with binary operation " \cdot " given in the following Callay's table, is a regular LA-semigroup with left identity 4

\cdot	1	2	3	4
1	3	4	1	2
2	2	1	4	3
3	4	3	2	1
4	1	2	3	4

then

$$N(S) = \{1 + 1I, 1 + 2I, 1 + 3I, 2 + 1I, 2 + 2I, 2 + 3I, 3 + 1I, 3 + 2I, 3 + 3I, 4 + 1I, 4 + 2I, 4 + 3I, 4 + 4I\}$$

is an example of neutrosophic regular LA-semigroup under the operation $*$ and has the following Callay's table:

$*$	1+1I	1+2I	1+3I	2+1I	2+2I	2+3I	3+1I	3+2I	3+3I	4+1I	4+2I	4+3I	4+4I
1+1I	3+3I	3+4I	3+1I	3+2I	4+3I	4+4I	4+1I	4+2I	1+3I	1+4I	1+1I	1+2I	2+3I
1+2I	3+2I	3+1I	3+4I	3+3I	4+2I	4+1I	4+4I	4+3I	1+2I	1+1I	1+4I	1+3I	2+2I
1+3I	3+4I	3+3I	3+2I	3+1I	4+4I	4+3I	4+2I	4+1I	1+4I	1+3I	1+2I	1+1I	2+4I
2+1I	3+1I	3+2I	3+3I	3+4I	4+1I	4+2I	4+3I	4+4I	1+1I	1+2I	1+3I	1+4I	2+2I
2+2I	3+2I	3+1I	3+3I	3+4I	4+2I	4+1I	4+4I	4+3I	1+2I	1+1I	1+4I	1+3I	2+3I
2+3I	3+3I	3+4I	3+1I	3+2I	4+3I	4+4I	4+1I	4+2I	1+3I	1+4I	1+1I	1+2I	2+3I
2+4I	3+4I	3+3I	3+2I	3+1I	4+4I	4+3I	4+2I	4+1I	1+4I	1+3I	1+2I	1+1I	2+4I
3+1I	3+4I	3+3I	3+2I	3+1I	4+4I	4+3I	4+2I	4+1I	1+4I	1+3I	1+2I	1+1I	2+4I
3+2I	3+2I	3+1I	3+3I	3+4I	4+2I	4+1I	4+4I	4+3I	1+2I	1+1I	1+4I	1+3I	2+2I
3+3I	3+3I	3+4I	3+1I	3+2I	4+3I	4+4I	4+1I	4+2I	1+3I	1+4I	1+1I	1+2I	2+3I
3+4I	3+4I	3+3I	3+2I	3+1I	4+4I	4+3I	4+2I	4+1I	1+4I	1+3I	1+2I	1+1I	2+4I
4+1I	4+1I	4+2I	4+3I	4+4I	4+1I	4+2I	4+3I	4+4I	1+1I	1+2I	1+3I	1+4I	2+1I
4+2I	4+2I	4+1I	4+3I	4+4I	4+2I	4+1I	4+4I	4+3I	1+2I	1+1I	1+4I	1+3I	2+2I
4+3I	4+3I	4+4I	4+1I	4+2I	4+3I	4+4I	4+1I	4+2I	1+3I	1+4I	1+1I	1+2I	2+3I
4+4I	4+4I	4+3I	4+2I	4+1I	4+4I	4+3I	4+2I	4+1I	1+4I	1+3I	1+2I	1+1I	2+4I

Clearly $N(S)$ is a neutrosophic LA-semigroup also $[(1 + 1I)(4 + 4I)](2 + 3I) \neq (1 + 1I)[(4 + 4I)(2 + 3I)]$

, so $N(S)$ is non-associative and is regular because $(1 + 1I) = [(1 + 1I)(2 + 2I)](1 + 1I)$, $(2 + 2I) = [(2 + 2I)(3 + 3I)](2 + 2I)$, $(3 + 2I) = [(3 + 2I)(1 + 3I)](3 + 2I)$, $(4 + 1I) = [(4 + 1I)(4 + 2I)](4 + 1I)$, $(4 + 4I) = [(4 + 4I)(4 + 4I)](4 + 4I)$ etc.

Note that in a neutrosophic regular LA-semigroup, $[N(S)]^2 = N(S)$.

Lemma 3.1: If $N(A)$ is a neutrosophic bi-ideal (generalized bi-ideal) of a regular neutrosophic LA-semigroup $N(S)$ then $[N(A)N(S)]N(A) = N(A)$.

Proof Let $N(A)$ be a bi-ideal (generalized bi-ideal) of $N(S)$, then $[N(A)N(S)]N(A) \subseteq N(A)$.

Let $a + bI \in N(A)$, since $N(S)$ is neutrosophic regular LA-semigroup so there exists an element $x + yI \in N(S)$ such that

$$a + bI = [(a + bI)(x + yI)](a + bI), \text{ therefore, } a + bI = [(a + bI)(x + yI)](a + bI) \in [N(A)N(S)]N(A).$$

This implies that $N(A) \subseteq [N(A)N(S)]N(A)$. Hence

$$[N(A)N(S)]N(A) = N(A)$$

Lemma 3.2: If $N(A)$ and $N(B)$ are any neutrosophic ideals of a neutrosophic regular LA-semigroup $N(S)$, then $N(A) \cap N(B) = N(A)N(B)$.

Proof Assume that $N(A)$ and $N(B)$ are any neutrosophic ideals of $N(S)$ so $N(A)N(B) \subseteq N(A)N(S) \subseteq N(A)$ and $N(A)N(B) \subseteq N(S)N(B) \subseteq N(B)$. This implies that $N(A)N(B) \subseteq N(A) \cap N(B)$. Let $a + bI \in N(A) \cap N(B)$, then $a + bI \in N(A)$ and

$a + bI \in N(B)$. Since $N(S)$ is a neutrosophic regular AG-groupoid, so there exist $x + yI$ such that $a + bI = [(a + bI)(x + yI)](a + bI) \in [N(A)N(S)N(B) \subseteq N(A)N(B)$, which implies that $N(A) \cap N(B) \subseteq N(A)N(B)$. Hence $N(A)N(B) = N(A) \cap N(B)$.

Lemma 3.3: *If $N(A)$ and $N(B)$ are any neutrosophic ideals of a neutrosophic regular LA-semigroup $N(S)$, then $N(A)N(B) = N(B)N(A)$.*

Proof Let $N(A)$ and $N(B)$ be any neutrosophic ideals of a neutrosophic regular LA-semigroup $N(S)$. Now, let $a_1 + a_2I \in N(A)$ and $b_1 + b_2I \in N(B)$. Since, $N(A) \subseteq N(S)$ and $N(B) \subseteq N(S)$ and $N(S)$ is a neutrosophic regular LA-semigroup so there exist $x_1 + x_2I, y_1 + y_2I \in N(S)$ such that $a_1 + a_2I = [(a_1 + a_2I)(x_1 + x_2I)](a_1 + a_2I)$ and $b_1 + b_2I = [(b_1 + b_2I)(y_1 + y_2I)](b_1 + b_2I)$.

Now, let $(a_1 + a_2I)(b_1 + b_2I) \in N(A)N(B)$ but

$$\begin{aligned} & (a_1 + a_2I)(b_1 + b_2I) \\ &= [\{(a_1 + a_2I)(x_1 + x_2I)\}(a_1 + a_2I)] \\ & \quad [\{(b_1 + b_2I)(y_1 + y_2I)\}(b_1 + b_2I)] \\ & \in [\{N(A)N(S)\}N(A)][\{N(B)N(S)\}N(B)] \\ & \subseteq [N(A)N(A)][N(B)N(B)] \\ &= [N(B)N(B)][N(A)N(A)] \\ & \subseteq N(B)N(A) \end{aligned}$$

$$N(A)N(B) \subseteq N(B)N(A).$$

Now, let $(b_1 + b_2I)(a_1 + a_2I) \in N(B)N(A)$ but

$$\begin{aligned} (b_1 + b_2I)(a_1 + a_2I) &= [\{(b_1 + b_2I)(y_1 + y_2I)\}(b_1 + b_2I)] \\ & \quad [\{(a_1 + a_2I)(x_1 + x_2I)\}(a_1 + a_2I)] \\ & \in [\{N(B)N(S)\}N(B)][\{N(A)N(S)\}N(A)] \\ & \subseteq [N(B)N(B)][N(A)N(A)] \\ &= [N(A)N(A)][N(B)N(B)] \\ & \subseteq N(A)N(B). \end{aligned}$$

Since $N(B)N(A) \subseteq N(A)N(B)$. Hence $N(A)N(B) = N(B)N(A)$.

Lemma 3.4; *Every neutrosophic bi-ideal of a regular neutrosophic LA-semigroup $N(S)$ with left identity*

$e + eI$ is a neutrosophic quasi-ideal of $N(S)$.

Proof Let $N(B)$ be a bi-ideal of $N(S)$ and $(s_1 + s_2I)(b_1 + b_2I) \in N(S)N(B)$, for $s_1 + s_2I \in N(S)$ and $b_1 + b_2I \in N(B)$. Since $N(S)$ is a neutrosophic regular LA-semigroup, so there exists $x_1 + x_2I$

in $N(S)$ such that $b_1 + b_2I = [(b_1 + b_2I)(x_1 + x_2I)](b_1 + b_2I)$, then by using (4) and (1), we have

$$\begin{aligned} & (s_1 + s_2I)(b_1 + b_2I) \\ &= (s_1 + s_2I)[\{(b_1 + b_2I)(x_1 + x_2I)\}(b_1 + b_2I)] \\ &= [(b_1 + b_2I)(x_1 + x_2I)][(s_1 + s_2I)(b_1 + b_2I)] \\ &= [\{(s_1 + s_2I)(b_1 + b_2I)\}(x_1 + x_2I)](b_1 + b_2I) \\ &= [(s_1 + s_2I)\{\{(b_1 + b_2I)(x_1 + x_2I)\}(b_1 + b_2I)\}(x_1 + x_2I)](b_1 + b_2I) \\ &= [[\{(b_1 + b_2I)(x_1 + x_2I)\}\{(s_1 + s_2I)(b_1 + b_2I)\}(x_1 + x_2I)](b_1 + b_2I)] \\ &= [\{(x_1 + x_2I)\{(s_1 + s_2I)(b_1 + b_2I)\}\}\{(b_1 + b_2I)(x_1 + x_2I)\}(b_1 + b_2I)] \\ &= [(b_1 + b_2I)[\{(x_1 + x_2I)\{(s_1 + s_2I)(b_1 + b_2I)\}\}(x_1 + x_2I)](b_1 + b_2I) \\ & \in [N(B)N(S)]N(B) \\ & \subseteq N(B). \end{aligned}$$

Therefore,

$$N(B)N(S) \cap N(S)N(B) \subseteq N(S)N(B) \subseteq N(B).$$

Lemma 3.5. *In a neutrosophic regular LA-semigroup $N(S)$, every neutrosophic ideal is idempotent.*

Proof. Let $N(I)$ be any neutrosophic ideal of neutrosophic regular LA-semigroup $N(S)$. As we know, $(N(I))^2 \subseteq N(I)$ and let $a + bI \in N(I)$, since $N(S)$ is regular so there exists an element $x + yI \in N(S)$ such that

$$\begin{aligned} a + bI &= [(a + bI)(x + yI)](a + bI) \\ & \in [N(I)N(S)]N(I) \\ & \subseteq N(I)N(I) = (N(I))^2. \end{aligned}$$

This implies $N(I) \subseteq (N(I))^2$. Hence, $(N(I))^2 = N(I)$.

As $N(I)$ is the arbitrary neutrosophic ideal of $N(S)$. So every ideal of neutrosophic regular AG-groupoid is idempotent.

Corollary 3.1. *In a neutrosophic regular LA-semigroup $N(S)$, every neutrosophic right ideal is idempotent.*

Proof. Let $N(R)$ be any neutrosophic right ideal of neutrosophic regular LA-semigroup $N(S)$ then $N(R)N(S) \subseteq N(R)$ and $(N(R))^2 \subseteq N(R)$. Now, let

$$a + bI \in N(R),$$

as $N(S)$ is regular implies for $a + bI \in N(R)$, there exists $x + yI \in N(S)$ such that

$$\begin{aligned} a + bI &= [(a + bI)(x + yI)](a + bI) \\ &\in [N(R)N(S)]N(I) \\ &\subseteq N(R)N(R) \\ &= (N(R))^2. \end{aligned}$$

Thus $(N(R))^2 = N(R)$. Hence, $(N(R))^2 = N(R)$. So every neutrosophic right ideal of neutrosophic regular LA-semigroup $N(S)$ is idempotent.

Corollary 3.2: *In a neutrosophic regular LA-semigroup $N(S)$, every neutrosophic ideal is semiprime.*

Proof: Let $N(P)$ be any neutrosophic ideal of neutrosophic regular LA-semigroup $N(S)$ and let $N(I)$ be any other neutrosophic ideal such that $[N(I)]^2 \subseteq N(P)$.

Now as every ideal of $N(S)$ is idempotent by lemma 3.5. So, $[N(I)]^2 = N(I)$ implies $N(I) \subseteq N(P)$. Hence, every neutrosophic ideal of $N(S)$ is semiprime.

4 Neutrosophic Intra-regular LA-semigroups

An LA-semigroup $N(S)$ is called neutrosophic intra-regular if for each element $a_1 + a_2I \in N(S)$ there exist elements $(x_1 + x_2I), (y_1 + y_2I) \in N(S)$ such that $a_1 + a_2I = [(x_1 + x_2I)(a_1 + a_2I)^2](y_1 + y_2I)$.

Example Let $S = \{1, 2, 3\}$ with binary operation " \cdot " given in the following Callay's table, is an intra-regular LA-semigroup with left identity 2.

\cdot	1	2	3
1	2	3	1
2	1	2	3
3	3	1	2

then

$$N(S) = \{1+1I, 1+2I, 1+3I, 2+1I, 2+2I, 2+3I, 3+1I, 3+2I, 3+3I\} [N(I)]^2.$$

is an example of neutrosophic intraregular LA-semigroup under the operation $*$ and has the following Callay's table:

$*$	1+1I	1+2I	1+3I	2+1I
-----	------	------	------	------

$*$	1+1I	1+2I	1+3I	2+1I	2+2I	2+3I	3+1I	3+2I	3+3I
1+1I	2+2I	2+3I	2+1I	3+2I	3+3I	3+1I	1+2I	1+3I	1+1I
1+2I	2+1I	2+2I	2+3I	3+1I	3+2I	3+3I	1+1I	1+2I	1+3I
1+3I	2+3I	2+1I	2+2I	3+3I	3+1I	3+2I	1+3I	1+1I	1+2I
2+1I	1+2I	1+3I	1+1I	2+2I	2+3I	2+1I	3+2I	3+3I	3+1I
2+2I	1+1I	1+2I	1+3I	2+1I	2+2I	2+3I	3+1I	3+2I	3+3I
2+3I	1+3I	1+1I	1+2I	2+3I	2+1I	2+2I	3+3I	3+1I	3+2I
3+1I	3+2I	3+3I	3+1I	1+2I	1+3I	1+1I	2+2I	2+3I	2+1I
3+2I	3+1I	3+2I	3+3I	1+1I	1+2I	1+3I	2+1I	2+2I	2+3I
3+3I	3+3I	3+1I	3+2I	1+3I	1+1I	1+2I	2+3I	2+1I	2+2I

Clearly $N(S)$ is a neutrosophic LA-semigroup and is non-associative because

$$[(1+1I) * (2+2I)] * (2+3I) \neq (1+1I) * [(2+2I) * (2+3I)]$$

and $N(S)$ is intra-regular as

$$\begin{aligned} (1+1I) &= [(1+3I)(1+1I)^2](2+3I) \\ (2+3I) &= [(1+1I)(2+3I)^2](3+1I) \\ (3+1I) &= [(2+3I)(3+1I)^2](3+3I) \text{ etc.} \end{aligned}$$

Note that if $N(S)$ is a neutrosophic intra-regular LA-semigroup then $[N(S)]^2 = N(S)$.

Lemma 4.1: *In a neutrosophic intra-regular LA-semigroup $N(S)$ with left identity $e + eI$, every neutrosophic ideal is idempotent.*

Proof Let $N(I)$ be any neutrosophic ideal of a neutrosophic intraregular LA-semigroup $N(S)$ implies $[N(I)]^2 \subseteq N(I)$. Now, let $a_1 + a_2I \in N(I)$ and since $N(I) \subseteq N(S)$ implies $a_1 + a_2I \in N(S)$. Since $N(S)$ is a neutrosophic intra-regular LA-semigroup, so there exist $(x_1 + x_2I), (y_1 + y_2I) \in N(S)$ such that

$$\begin{aligned} (a_1 + a_2I) &= [(x_1 + x_2I)(a_1 + a_2I)^2](y_1 + y_2I) \\ &\in [N(S)(N(I))^2]N(S) \\ &= [N(S)(N(I)N(I))]N(S) \\ &= (N(I)(N(S)N(I)))N(S) \\ &\subseteq (N(I)N(I))N(S) \\ &= (N(S)N(I))N(I) \\ &\subseteq N(I)N(I) \end{aligned}$$

Hence $[N(I)]^2 = N(I)$. As, $N(I)$ is arbitrary so every neutrosophic ideal of is idempotent in a neutrosophic intra-regular LA-semigroup $N(S)$ with left identity.

Lemma 4.2: *In a neutrosophic intra-regular LA-semigroup $N(S)$ with left identity $e + eI$,*

$N(I)N(J) = N(I) \cap N(J)$, for every neutrosophic ideals $N(I)$ and $N(J)$ in $N(S)$.

Proof: Let $N(I)$ and $N(J)$ be any neutrosophic ideals of $N(S)$, then obviously $N(I)N(J) \subseteq N(I)N(S)$ and $N(I)N(J) \subseteq N(S)N(J)$ implies $N(I)N(J) \subseteq N(I) \cap N(J)$. Since $N(I) \cap N(J) \subseteq N(I)$ and $N(I) \cap N(J) \subseteq N(J)$, then $[N(I) \cap N(J)]^2 \subseteq N(I)N(J)$. Also $N(I) \cap N(J)$ is a neutrosophic ideal of $N(S)$, so using Lemma 4.1, we have $N(I) \cap N(J) = [N(I) \cap N(J)]^2 \subseteq N(I)N(J)$. Hence $N(I)N(J) = N(I) \cap N(J)$.

Theorem 4.1. For neutrosophic intra-regular AG-groupoid with left identity $e + eI$, the following statements are equivalent.

- (i) $N(A)$ is a neutrosophic left ideal of $N(S)$.
- (ii) $N(A)$ is a neutrosophic right ideal of $N(S)$.
- (iii) $N(A)$ is a neutrosophic ideal of $N(S)$.
- (iv) $N(A)$ is a neutrosophic bi-ideal of $N(S)$.
- (v) $N(A)$ is a neutrosophic generalized bi-ideal of $N(S)$.
- (vi) $N(A)$ is a neutrosophic interior ideal of $N(S)$.
- (vii) $N(A)$ is a neutrosophic quasi-ideal of $N(S)$.
- (viii) $N(A)N(S) = N(A)$ and $N(S)N(A) = N(A)$.

Proof: (i) \Rightarrow (viii)

Let $N(A)$ be a neutrosophic left ideal of $N(S)$. By Lemma first, $N(S)N(A) = N(A)$. Now let $(a_1 + a_2I) \in N(A)$ and $(s_1 + s_2I) \in N(S)$, since $N(S)$ is a neutrosophic intra-regular LA-semigroup, so there exist $(x_1 + x_2I), (y_1 + y_2I) \in N(S)$ such that $(a_1 + a_2I) = [(x_1 + x_2I)(a_1 + a_2I)^2](y_1 + y_2I)$, therefore by (1), we have

$$\begin{aligned} (a_1 + a_2I)(s_1 + s_2I) &= [(x_1 + x_2I)(a_1 + a_2I)^2](y_1 + y_2I)(s_1 + s_2I) \\ &= [\{ (x_1 + x_2I) \{ (a_1 + a_2I)(a_1 + a_2I) \} \} (y_1 + y_2I)] (s_1 + s_2I) \\ &\in [\{ N(S) \{ N(A)N(A) \} \} N(S)] N(S) \\ &\subseteq [\{ N(S) \{ N(S)N(A) \} \} N(S)] N(S) \\ &\subseteq [\{ N(S)N(A) \} N(S)] N(S) \\ &= [N(S)N(S)] [N(S)N(A)] \\ &= N(S)[N(S)N(A)] \subseteq N(S)N(A) = N(A). \end{aligned}$$

which implies that $N(A)$ is a neutrosophic right ideal of

$N(S)$, again by Lemma first, $N(A)N(S) = N(S)$.

(viii) \Rightarrow (vii)

Let $N(A)N(S) = N(A)$ and $N(S)N(A) = N(A)$ then $N(A)N(S) \cap N(S)N(A) = N(A)$, which clearly implies that $N(A)$ is a neutrosophic quasi-ideal of $N(S)$.

(vii) \Rightarrow (vi)

Let $N(A)$ be a quasi-ideal of $N(S)$. Now let $[(s_1 + s_2I)(a_1 + a_2I)](s_1 + s_2I) \in [N(S)N(A)]N(S)$, since $N(S)$ is neutrosophic intra-regular LA-semigroup so there exist $(x_1 + x_2I), (y_1 + y_2I), (p_1 + p_2I), (q_1 + q_2I) \in N(S)$ such that $(s_1 + s_2I) = [(x_1 + x_2I)(s_1 + s_2I)^2](y_1 + y_2I)$ and $(a_1 + a_2I) = [(p_1 + p_2I)(a_1 + a_2I)^2](q_1 + q_2I)$. Therefore using (2), (4), (3) and (1), we have

$$\begin{aligned} &[(s_1 + s_2I)(a_1 + a_2I)](s_1 + s_2I) \\ &= [(s_1 + s_2I)(a_1 + a_2I)] [\{ (x_1 + x_2I)(s_1 + s_2I) \} (y_1 + y_2I)] \\ &= [\{ (s_1 + s_2I) \{ (x_1 + x_2I)(s_1 + s_2I)^2 \} \}] [(a_1 + a_2I)(y_1 + y_2I)] \\ &= (a_1 + a_2I) [\{ (s_1 + s_2I) \{ (x_1 + x_2I)(s_1 + s_2I)^2 \} \} (y_1 + y_2I)] \\ &\in N(A)N(S). \end{aligned}$$

and

$$\begin{aligned} &[(s_1 + s_2I)(a_1 + a_2I)](s_1 + s_2I) \\ &= [(s_1 + s_2I) \{ (p_1 + p_2I)(a_1 + a_2I)^2 \} (q_1 + q_2I)](s_1 + s_2I) \\ &= [\{ (p_1 + p_2I)(a_1 + a_2I)^2 \} \{ (s_1 + s_2I)(q_1 + q_2I) \}] (s_1 + s_2I) \\ &= [\{ (p_1 + p_2I) \{ (a_1 + a_2I)(a_1 + a_2I) \} \} \{ (s_1 + s_2I)(q_1 + q_2I) \}] (s_1 + s_2I) \\ &= [\{ (a_1 + a_2I) \{ (p_1 + p_2I)(a_1 + a_2I) \} \} \{ (s_1 + s_2I)(q_1 + q_2I) \}] (s_1 + s_2I) \\ &= [\{ (q_1 + q_2I)(s_1 + s_2I) \} \{ (p_1 + p_2I)(a_1 + a_2I) \} (a_1 + a_2I)] (s_1 + s_2I) \\ &= [\{ (p_1 + p_2I)(a_1 + a_2I) \} \{ (q_1 + q_2I)(s_1 + s_2I) \} (a_1 + a_2I)] (s_1 + s_2I) \\ &= [\{ (a_1 + a_2I) \{ (q_1 + q_2I)(s_1 + s_2I) \} \} \{ (a_1 + a_2I)(p_1 + p_2I) \}] (s_1 + s_2I) \\ &= [(a_1 + a_2I) \{ (a_1 + a_2I) \{ (q_1 + q_2I)(s_1 + s_2I) \} \} (p_1 + p_2I)] (s_1 + s_2I) \\ &= [(s_1 + s_2I) \{ (a_1 + a_2I) \{ (q_1 + q_2I)(s_1 + s_2I) \} \} (p_1 + p_2I)] (a_1 + a_2I) \\ &\in N(S)N(A) \subseteq N(A). \end{aligned}$$

which shows that $N(A)$ is a neutrosophic interior ideal of $N(S)$.

(vi) \Rightarrow (v)

Let $N(A)$ be a neutrosophic interior ideal of a neutrosophic intraregular LA-semigroup $N(S)$

and

$$[(a_1 + a_2I)(s_1 + s_2I)](a_1 + a_2I) \in [N(A)N(S)]N(A)$$

. Now using (4) and (1), we get

$$\begin{aligned} & [(a_1 + a_2I)(s_1 + s_2I)](a_1 + a_2I) \\ &= [(a_1 + a_2I)(s_1 + s_2I)]\{(x_1 + x_2I)(a_1 + a_2I)^2\}(y_1 + y_2I) \\ &= [(x_1 + x_2I)(a_1 + a_2I)^2]\{(a_1 + a_2I)(s_1 + s_2I)\}(y_1 + y_2I) \\ &= [(x_1 + x_2I)\{(a_1 + a_2I)(a_1 + a_2I)\}]\{(a_1 + a_2I)(s_1 + s_2I)\}(y_1 + y_2I) \\ &= [\{(a_1 + a_2I)(s_1 + s_2I)\}(y_1 + y_2I)\}\{(a_1 + a_2I)(a_1 + a_2I)\}(x_1 + x_2I) \\ &= [(a_1 + a_2I)\{\{(a_1 + a_2I)(s_1 + s_2I)\}(y_1 + y_2I)\}\}(a_1 + a_2I)](x_1 + x_2I) \\ &= [(a_1 + a_2I)\{\{(a_1 + a_2I)(y_1 + y_2I)\}\{(a_1 + a_2I)(s_1 + s_2I)\}\}(x_1 + x_2I) \\ &= [\{(a_1 + a_2I)(y_1 + y_2I)\}\{(a_1 + a_2I)\{(a_1 + a_2I)(s_1 + s_2I)\}\}\}(x_1 + x_2I) \\ &= [\{(a_1 + a_2I)\{(a_1 + a_2I)(s_1 + s_2I)\}\}(y_1 + y_2I)\}(a_1 + a_2I)](x_1 + x_2I) \\ &\in [N(S)N(A)]N(S) \subseteq N(A). \end{aligned}$$

(v) \Rightarrow (iv)

Let $N(A)$ be a neutrosophic generalized bi-ideal of $N(S)$. Let $a_1 + a_2I \in N(A)$, and since $N(S)$ is neutrosophic intra-regular LA-semigroup so there exist $(x_1 + x_2I)$, $(y_1 + y_2I)$ in $N(S)$ such that $a_1 + a_2I = [(x_1 + x_2I)(a_1 + a_2I)^2](y_1 + y_2I)$, then using (3) and (4), we have

$$\begin{aligned} & (a_1 + a_2I)(a_1 + a_2I) \\ &= [\{(x_1 + x_2I)(a_1 + a_2I)^2\}(y_1 + y_2I)](a_1 + a_2I) \\ &= [\{(x_1 + x_2I)(a_1 + a_2I)^2\}\{(e_1 + e_2I)(y_1 + y_2I)\}](a_1 + a_2I) \\ &= [\{(y_1 + y_2I)(e_1 + e_2I)\}\{(a_1 + a_2I)^2(x_1 + x_2I)\}](a_1 + a_2I) \\ &= [(a_1 + a_2I)^2\{\{(y_1 + y_2I)(e_1 + e_2I)\}(x_1 + x_2I)\}](a_1 + a_2I) \\ &= [\{(a_1 + a_2I)(a_1 + a_2I)\}\{\{(y_1 + y_2I)(e_1 + e_2I)\}(x_1 + x_2I)\}](a_1 + a_2I) \\ &= [\{(x_1 + x_2I)\{(y_1 + y_2I)(e_1 + e_2I)\}\}\{(a_1 + a_2I)(a_1 + a_2I)\}](a_1 + a_2I) \\ &= [(a_1 + a_2I)\{\{(x_1 + x_2I)\{(y_1 + y_2I)(e_1 + e_2I)\}\}\}(a_1 + a_2I)](a_1 + a_2I) \\ &\in [N(A)N(S)]N(A) \subseteq N(A). \end{aligned}$$

Hence $N(A)$ is a neutrosophic bi-ideal of $N(S)$.

(iv) \Rightarrow (iii)

Let $N(A)$ be any neutrosophic bi-ideal of $N(S)$ and let $(a_1 + a_2I)(s_1 + s_2I) \in N(A)N(S)$. Since $N(S)$ is neutrosophic intra-regular LA-semigroup, so there exist $(x_1 + x_2I)$, $(y_1 + y_2I) \in N(S)$ such that $(a_1 + a_2I) = [(x_1 + x_2I)(a_1 + a_2I)^2](y_1 + y_2I)$. Therefore, using (1), (3), (4) and (2), we have

$$\begin{aligned} & (a_1 + a_2I)(s_1 + s_2I) \\ &= [\{(x_1 + x_2I)(a_1 + a_2I)^2\}(y_1 + y_2I)](s_1 + s_2I) \\ &= [(s_1 + s_2I)(y_1 + y_2I)]\{(x_1 + x_2I)(a_1 + a_2I)^2\} \\ &= [(a_1 + a_2I)^2(x_1 + x_2I)]\{(y_1 + y_2I)(s_1 + s_2I)\} \\ &= [\{\{(y_1 + y_2I)(s_1 + s_2I)\}(x_1 + x_2I)\}(a_1 + a_2I)^2] \\ &= [\{(y_1 + y_2I)(s_1 + s_2I)\}(x_1 + x_2I)]\{(a_1 + a_2I)(a_1 + a_2I)\} \\ &= [(a_1 + a_2I)(a_1 + a_2I)]\{(x_1 + x_2I)\{(y_1 + y_2I)(s_1 + s_2I)\}\} \\ &= [\{(x_1 + x_2I)\{(y_1 + y_2I)(s_1 + s_2I)\}\}(a_1 + a_2I)](a_1 + a_2I) \\ &= \{(x_1 + x_2I)\{(y_1 + y_2I)(s_1 + s_2I)\}\} \\ &\quad \{\{(x_1 + x_2I)(a_1 + a_2I)^2\}(y_1 + y_2I)\}(a_1 + a_2I) \\ &= [\{(x_1 + x_2I)(a_1 + a_2I)^2\}\{\{(x_1 + x_2I)\{(y_1 + y_2I)(s_1 + s_2I)\}\}\} \\ &\quad (y_1 + y_2I)\}(a_1 + a_2I) \\ &= [\{(y_1 + y_2I)\{(x_1 + x_2I)\{(y_1 + y_2I)(s_1 + s_2I)\}\}\} \\ &\quad \{(a_1 + a_2I)^2(x_1 + x_2I)\}](a_1 + a_2I) \\ &= [(a_1 + a_2I)^2\{\{(y_1 + y_2I)\{(x_1 + x_2I)\{(y_1 + y_2I)(s_1 + s_2I)\}\}\} \\ &\quad (x_1 + x_2I)\}\}(a_1 + a_2I) \\ &= [\{(a_1 + a_2I)(a_1 + a_2I)\}\{\{(y_1 + y_2I)\{(x_1 + x_2I) \\ &\quad \{(y_1 + y_2I)(s_1 + s_2I)\}\}\}\}(x_1 + x_2I)](a_1 + a_2I) \\ &= [\{(x_1 + x_2I)\{(y_1 + y_2I)\{(x_1 + x_2I)\{(y_1 + y_2I)(s_1 + s_2I)\}\}\}\} \\ &\quad \{(a_1 + a_2I)(a_1 + a_2I)\}](a_1 + a_2I) \\ &\in [N(A)N(S)]N(A) \subseteq N(A). \end{aligned}$$

$$\begin{aligned} & (s_1 + s_2I)(a_1 + a_2I) \\ &= (s_1 + s_2I)[\{(x_1 + x_2I)(a_1 + a_2I)^2\}(y_1 + y_2I)] \\ &= [(x_1 + x_2I)(a_1 + a_2I)^2]\{(s_1 + s_2I)(y_1 + y_2I)\} \\ &= [(x_1 + x_2I)\{(a_1 + a_2I)(a_1 + a_2I)\}]\{(s_1 + s_2I)(y_1 + y_2I)\} \\ &= [(a_1 + a_2I)\{(x_1 + x_2I)(a_1 + a_2I)\}]\{(s_1 + s_2I)(y_1 + y_2I)\} \\ &= [\{(s_1 + s_2I)(y_1 + y_2I)\}\{(x_1 + x_2I)(a_1 + a_2I)\}](a_1 + a_2I) \\ &= [\{(a_1 + a_2I)(x_1 + x_2I)\}\{(y_1 + y_2I)(s_1 + s_2I)\}](a_1 + a_2I) \\ &= [\{\{(y_1 + y_2I)(s_1 + s_2I)\}(x_1 + x_2I)\}(a_1 + a_2I)](a_1 + a_2I) \\ &= [\{\{(y_1 + y_2I)(s_1 + s_2I)\}(x_1 + x_2I)\} \\ &\quad \{\{(x_1 + x_2I)(a_1 + a_2I)^2\}(y_1 + y_2I)\}](a_1 + a_2I) \\ &= [\{\{(y_1 + y_2I)(s_1 + s_2I)\}\{(x_1 + x_2I)(a_1 + a_2I)^2\}\} \\ &\quad \{(x_1 + x_2I)(y_1 + y_2I)\}](a_1 + a_2I) \\ &= [\{\{(a_1 + a_2I)^2(x_1 + x_2I)\}\{(s_1 + s_2I)(y_1 + y_2I)\}\} \\ &\quad \{(x_1 + x_2I)(y_1 + y_2I)\}](a_1 + a_2I) \\ &= [\{\{\{(a_1 + a_2I)(a_1 + a_2I)\}(x_1 + x_2I)\}\{(s_1 + s_2I)(y_1 + y_2I)\}\} \\ &\quad \{(x_1 + x_2I)(y_1 + y_2I)\}](a_1 + a_2I) \end{aligned}$$

$$\begin{aligned}
 &= [\{ \{ (x_1 + x_2I)(y_1 + y_2I) \} \{ (s_1 + s_2I)(y_1 + y_2I) \} \} \\
 &\quad \{ \{ (a_1 + a_2I)(a_1 + a_2I) \} (x_1 + x_2I) \}] (a_1 + a_2I) \\
 &= [(a_1 + a_2I) \{ \{ \{ (s_1 + s_2I)(y_1 + y_2I) \} (x_1 + x_2I) \} \} \\
 &\quad \{ (y_1 + y_2I)(x_1 + x_2I) \} \} (a_1 + a_2I)] (a_1 + a_2I) \\
 &\in [N(A)N(S)]N(A) \\
 &\subseteq N(A).
 \end{aligned}$$

Therefore, $N(A)$ is a neutrosophic ideal of $N(S)$.

(iii) \Rightarrow (ii) and (ii) \Rightarrow (i) are obvious.

Lemma 4.4. A neutrosophic LA-semigroup $N(S)$ with left identity $(e + eI)$ is intra-regular if and only if every neutrosophic bi-ideal of $N(S)$ is idempotent.

Proof. Assume that $N(S)$ is a neutrosophic intra-regular LA-semigroup with left identity $(e + eI)$ and $N(B)$ is a neutrosophic bi-ideal of $N(S)$. Let $(b + bI) \in N(B)$, and since $N(S)$ is intra-regular so there exist $(c_1 + c_2I)$, $(d_1 + d_2I)$ in $N(S)$ such that $(b_1 + b_2I) = [(c_1 + c_2I)(b_1 + b_2I)^2](d_1 + d_2I)$, then by using (3), (4) and (1), we have

$$\begin{aligned}
 &(b_1 + b_2I) \\
 &= [(c_1 + c_2I)(b_1 + b_2I)^2](d_1 + d_2I) \\
 &= [\{ (c_1 + c_2I)(b_1 + b_2I)^2 \} \{ (e + eI)(d_1 + d_2I) \}] \\
 &= [\{ (d_1 + d_2I)(e + eI) \} \{ (b_1 + b_2I)^2(c_1 + c_2I) \}] \\
 &= [(b_1 + b_2I)^2 \{ \{ (d_1 + d_2I)(e + eI) \} (c_1 + c_2I) \}] \\
 &= [\{ (b_1 + b_2I)(b_1 + b_2I) \} \{ \{ (d_1 + d_2I)(e + eI) \} (c_1 + c_2I) \}] \\
 &= [\{ \{ (d_1 + d_2I)(e + eI) \} (c_1 + c_2I) \} (b_1 + b_2I)] (b_1 + b_2I) \\
 &= [\{ \{ (d_1 + d_2I)(e + eI) \} (c_1 + c_2I) \} \\
 &\quad \{ \{ (c_1 + c_2I)(b_1 + b_2I)^2 \} (d_1 + d_2I) \}] (b_1 + b_2I) \\
 &= [\{ (c_1 + c_2I) \{ (b_1 + b_2I)(b_1 + b_2I) \} \} \{ \{ (d_1 + d_2I)(e + eI) \} \\
 &\quad (c_1 + c_2I) \} (d_1 + d_2I) \}] (b_1 + b_2I) \\
 &= [\{ (b_1 + b_2I) \{ (c_1 + c_2I)(b_1 + b_2I) \} \} \{ \{ (d_1 + d_2I)(e + eI) \} \\
 &\quad (c_1 + c_2I) \} (d_1 + d_2I) \}] (b_1 + b_2I) \\
 &= [\{ \{ \{ (d_1 + d_2I)(e + eI) \} (c_1 + c_2I) \} (d_1 + d_2I) \} \} \\
 &\quad \{ (c_1 + c_2I)(b_1 + b_2I) \} (b_1 + b_2I)] (b_1 + b_2I)
 \end{aligned}$$

$$\begin{aligned}
 &= [\{ \{ \{ (d_1 + d_2I)(e + eI) \} (c_1 + c_2I) \} (d_1 + d_2I) \} \} \\
 &\quad \{ \{ (c_1 + c_2I) \{ (c_1 + c_2I)(b_1 + b_2I)^2 \} \\
 &\quad (d_1 + d_2I) \} \} (b_1 + b_2I) \}] (b_1 + b_2I) \\
 &= [\{ \{ \{ (d_1 + d_2I)(e + eI) \} (c_1 + c_2I) \} (d_1 + d_2I) \} \} \{ (c_1 + c_2I) \\
 &\quad \{ (c_1 + c_2I) \{ (b_1 + b_2I)(b_1 + b_2I) \} \} (d_1 + d_2I) \} \} \} \\
 &\quad (b_1 + b_2I) \}] (b_1 + b_2I) \\
 &= [\{ \{ \{ (d_1 + d_2I)(e + eI) \} (c_1 + c_2I) \} (d_1 + d_2I) \} \} \{ (c_1 + c_2I) \{ \{ (b_1 + b_2I) \\
 &\quad \{ (c_1 + c_2I)(b_1 + b_2I) \} \} (d_1 + d_2I) \} \} \} (b_1 + b_2I) \}] (b_1 + b_2I) \\
 &= [\{ \{ \{ (d_1 + d_2I)(e + eI) \} (c_1 + c_2I) \} (d_1 + d_2I) \} \} \{ (b_1 + b_2I) \\
 &\quad \{ (c_1 + c_2I) \{ (c_1 + c_2I)(b_1 + b_2I) \} \} (d_1 + d_2I) \} \} \} (b_1 + b_2I) \}] (b_1 + b_2I) \\
 &= [(b_1 + b_2I) \{ \{ \{ (d_1 + d_2I)(e + eI) \} (c_1 + c_2I) \} (d_1 + d_2I) \} \} \\
 &\quad \{ \{ (c_1 + c_2I) \{ (c_1 + c_2I)(b_1 + b_2I) \} \} (d_1 + d_2I) \} \} \} (b_1 + b_2I) \}] (b_1 + b_2I) \\
 &\in [N(B)N(S)]N(B) \subseteq N(B)N(B).
 \end{aligned}$$

Hence $[N(B)]^2 = N(B)$.

Conversely, since $N(S)(a + bI)$ is a neutrosophic bi-ideal of $N(S)$, and by assumption $N(S)(a + bI)$ is idempotent, so by using (2), we have

Hence $N(S)$ is neutrosophic intra-regular LA-semigroup. Theorem 4.2. In a neutrosophic LA-semigroup $N(S)$ with left identity $e + eI$, the following statements are equivalent.

- (i) $N(S)$ is intra-regular.
- (ii) Every neutrosophic two sided ideal of $N(S)$ is semiprime.
- (iii) Every neutrosophic right ideal of $N(S)$ is semiprime.
- (iv) Every neutrosophic left ideal of $N(S)$ is semiprime.

Proof: (i) \Rightarrow (iv)

Let $N(S)$ is intra-regular, then by Theorem equalient and Lemma 4.1, every neutrosophic left ideal of $N(S)$ is semiprime.

(iv) \Rightarrow (iii)

Let $N(R)$ be a neutrosophic right ideal and $N(I)$ be any neutrosophic ideal of $N(S)$ such that $[N(I)]^2 \subseteq N(R)$. Then clearly $[N(I)]^2 \subseteq N(R) \cup N(S)N(R)$. Now by Lemma 2.7, $N(R) \cup N(S)N(R)$ is a neutrosophic two-sided ideal of $N(S)$, so is neutrosophic left. Then by (iv) we have $N(I) \subseteq N(R) \cup N(S)N(R)$. Now using (1) we have

$$\begin{aligned} N(S)N(R) &= [N(S)N(S)]N(R) \\ &= [N(R)N(S)]N(S) \\ &\subseteq N(R)N(S) \subseteq N(R). \end{aligned}$$

This implies that $N(I) \subseteq N(R) \cup N(S)N(R) \subseteq N(R)$. Hence $N(R)$ is semiprime.

It is clear that (iii) \Rightarrow (ii).

Now (ii) \Rightarrow (i)

Since $(a + bI)^2 N(S)$ is a neutrosophic right ideal of $N(S)$ containing $(a + bI)^2$ and clearly it is a neutrosophic two sided ideal so by assumption (ii), it is semiprime, therefore by Theorem 2.2, $(a + bI) \in (a + bI)^2 N(S)$. Thus using (4) and (3), we have

$$\begin{aligned} a + bI &\in (a + bI)^2 N(S) \\ &= (a + bI)^2 [N(S)N(S)] \\ &= N(S)[(a + bI)^2 N(S)] \\ &= [N(S)N(S)][(a + bI)^2 N(S)] \\ &= [N(S)(a + bI)^2][N(S)N(S)] \\ &= [N(S)(a + bI)^2]N(S). \end{aligned}$$

Hence $N(S)$ is intra-regular.

Theorem 4.3. *An LA-semigroup $N(S)$ with left identity $e + eI$ is intra-regular if and only if every neutrosophic left ideal of $N(S)$ is idempotent.*

Proof. Let $N(S)$ be a neutrosophic intra-regular LA-semigroup then by Theorem equalient and Lemma 4.1, every neutrosophic ideal of $N(S)$ is idempotent.

Conversely, assume that every neutrosophic left ideal of $N(S)$ is idempotent. Since $N(S)(a + bI)$ is a neutrosophic left ideal of $N(S)$, so by using (2), we have

$$\begin{aligned} a + bI &\in N(S)(a + bI) \\ &= [N(S)(a + bI)][N(S)(a + bI)] \\ &= [\{N(S)(a + bI)\}\{N(S)(a + bI)\}]\{N(S)(a + bI)\} \\ &= [\{N(S)N(S)\}\{(a + bI)(a + bI)\}]\{N(S)(a + bI)\} \\ &\subseteq [N(S)(a + bI)^2][N(S)N(S)] \\ &= [N(S)(a + bI)^2]N(S). \end{aligned}$$

Theorem 4.4. *A neutrosophic LA-semigroup $N(S)$ with left identity $e + eI$ is intra-regular if and only if*

$N(R) \cap N(L) \subseteq N(R)N(L)$, for every neutrosophic semiprime right ideal $N(R)$ and every neutrosophic left ideal $N(L)$ of $N(S)$.

Proof. Let $N(S)$ be an intra-regular LA-semigroup, so by Theorem equalient $N(R)$ and $N(L)$ become neutrosophic ideals of $N(S)$, therefore by Lemma 4.2, $N(R) \cap N(L) \subseteq N(L)N(R)$, for every neutrosophic ideal $N(R)$ and $N(L)$ and by Theorem every ideal semiprime, $N(R)$ is semiprime.

Conversely, assume that $N(R) \cap N(L) \subseteq N(R)N(L)$ for every neutrosophic right ideal $N(R)$, which is semiprime and every neutrosophic left ideal $N(L)$ of $N(S)$. Since $(a + bI)^2 \in (a + bI)^2 N(S)$, which is a neutrosophic right ideal of $N(S)$ so is semiprime which implies that $(a + bI) \in (a + bI)^2 N(S)$. Now clearly $N(S)(a + bI)$ is a neutrosophic left ideal of $N(S)$ and $(a + bI) \in N(S)(a + bI)$. Therefore, using (3), we have

$$\begin{aligned} a + bI &\in [(a + bI)^2 N(S)] \cap [N(S)(a + bI)] \\ &\subseteq [(a + bI)^2 N(S)][N(S)(a + bI)] \\ &\subseteq [(a + bI)^2 N(S)][N(S)N(S)] \\ &= [(a + bI)^2 N(S)]N(S) \\ &= [\{(a + bI)(a + bI)\}N(S)]N(S) \\ &= [\{(a + bI)(a + bI)\}\{N(S)N(S)\}]N(S) \\ &= [\{N(S)N(S)\}\{(a + bI)(a + bI)\}]N(S) \\ &= [N(S)\{(a + bI)(a + bI)\}]N(S) \\ &= [N(S)(a + bI)^2]N(S). \end{aligned}$$

Therefore, $N(S)$ is a neutrosophic intra-regular LA-semigroup.

Theorem 4.5. *For a neutrosophic LA-semigroup $N(S)$ with left identity $e + eI$, the following statements are equivalent.*

- (i) $N(S)$ is intra-regular.
- (ii) $N(L) \cap N(R) \subseteq N(L)N(R)$, for every right ideal $N(R)$, which is neutrosophic semiprime and every neutrosophic left ideal $N(L)$ of $N(S)$.
- (iii) $N(L) \cap N(R) \subseteq [N(L)N(R)]N(L)$, for every neutrosophic semiprime right ideal $N(R)$ and every neutrosophic left ideal $N(L)$.

Proof (i) \Rightarrow (iii)

Let $N(S)$ be intra-regular and $N(L), N(R)$ be any neutrosophic left and right ideals of $N(S)$ and let $a_1 + a_2I \in N(L) \cap N(R)$, which implies that $a_1 + a_2I \in N(L)$ and $a_1 + a_2I \in N(R)$. Since $N(S)$ is intra-regular so there exist $(x_1 + x_2I), (y_1 + y_2I)$ in $N(S)$ such that

$$\begin{aligned}
 a_1 + a_2I &= [(x_1 + x_2I)(a_1 + a_2I)^2](y_1 + y_2I), \text{ then by} \\
 &\text{using (4), (1) and (3), we have} \\
 a_1 + a_2I &= [(x_1 + x_2I)(a_1 + a_2I)^2](y_1 + y_2I) \\
 &= [(x_1 + x_2I)\{(a_1 + a_2I)(a_1 + a_2I)\}](y_1 + y_2I) \\
 &= [(a_1 + a_2I)\{(x_1 + x_2I)(a_1 + a_2I)\}](y_1 + y_2I) \\
 &= [(y_1 + y_2I)\{(x_1 + x_2I)(a_1 + a_2I)\}](a_1 + a_2I) \\
 &= [(y_1 + y_2I)\{(x_1 + x_2I)\{(x_1 + x_2I)(a_1 + a_2I)^2\} \\
 &\quad (y_1 + y_2I)\}\}](a_1 + a_2I) \\
 &= [(y_1 + y_2I)\{(x_1 + x_2I)(a_1 + a_2I)^2\}\{(x_1 + x_2I)(y)\}](a_1 + a_2I) \\
 &= [\{(x_1 + x_2I)(a_1 + a_2I)^2\}\{(y_1 + y_2I) \\
 &\quad \{(x_1 + x_2I)(y_1 + y_2I)\}\}](a_1 + a_2I) \\
 &= [\{(x_1 + x_2I)\{(a_1 + a_2I)(a_1 + a_2I)\}\}\{(y_1 + y_2I) \\
 &\quad \{(x_1 + x_2I)(y_1 + y_2I)\}\}](a_1 + a_2I) \\
 &= [\{(a_1 + a_2I)\{(x_1 + x_2I)(a_1 + a_2I)\}\}\{(y_1 + y_2I) \\
 &\quad \{(x_1 + x_2I)(y_1 + y_2I)\}\}](a_1 + a_2I) \\
 &\in [\{N(R)\{N(S)N(L)\}\}N(S)]N(L) \\
 &\subseteq [\{N(R)N(L)\}N(S)]N(L) \\
 &= [N(L)N(S)][N(R)N(L)] \\
 &= [N(L)N(R)][N(S)N(L)] \\
 &\subseteq [N(L)N(R)]N(L),
 \end{aligned}$$

which implies that $N(L) \cap N(R) \subseteq [N(L)N(R)]N(L)$. Also by Theorem every ideal semiprime, $N(L)$ is semiprime.

$$(iii) \Rightarrow (ii)$$

Let $N(R)$ and $N(L)$ be neutrosophic left and right ideals of $N(S)$ and $N(R)$ is semiprime, then by assumption (iii) and by (3), (4) and (1), we have

$$\begin{aligned}
 N(R) \cap N(L) &\subseteq [N(R)N(L)]N(R) \\
 &\subseteq [N(R)N(L)]N(S) \\
 &= [N(R)N(L)][N(S)N(S)] \\
 &= [N(S)N(S)][N(L)N(R)] \\
 &= N(L)[\{N(S)N(S)\}N(R)] \\
 &= N(L)[\{N(R)N(S)\}N(S)] \\
 &\subseteq N(L)[N(R)N(S)] \\
 &\subseteq N(L)N(R).
 \end{aligned}$$

$$(ii) \Rightarrow (i)$$

Since $e + eI \in N(S)$ implies $a + bI \in N(S)(a + bI)$, which is a neutrosophic left ideal of $N(S)$, and $(a + bI)^2 \in (a + bI)^2 N(S)$, which is a semiprime neutrosophic right ideal of $N(S)$, therefore by Theorem 2.2 $a + bI \in (a + bI)^2 N(S)$. Now using (3) we have

$$\begin{aligned}
 a + bI &\in [N(S)(a + bI)] \cap [(a + bI)^2 N(S)] \\
 &\subseteq [N(S)(a + bI)][(a + bI)^2 N(S)] \\
 &\subseteq [N(S)N(S)][(a + bI)^2 N(S)] \\
 &= [N(S)(a + bI)^2][N(S)N(S)] \\
 &= [N(S)(a + bI)^2]N(S).
 \end{aligned}$$

Hence $N(S)$ is intra-regular

A neutrosophic LA-semigroup $N(S)$ is called totally ordered under inclusion if $N(P)$ and $N(Q)$ are any neutrosophic ideals of $N(S)$ such that either $N(P) \subseteq N(Q)$ or $N(Q) \subseteq N(P)$.

A neutrosophic ideal $N(P)$ of a neutrosophic LA-semigroup $N(S)$ is called strongly irreducible if $N(A) \cap N(B) \subseteq N(P)$ implies either $N(A) \subseteq N(P)$ or $N(B) \subseteq N(P)$, for all neutrosophic ideals $N(A), N(B)$ and $N(P)$ of $N(S)$.

Lemma 4.4. Every neutrosophic ideal of a neutrosophic intra-regular LA-semigroup $N(S)$ is prime if and only if it is strongly irreducible.

Proof. Assume that every ideal of $N(S)$ is neutrosophic prime. Let $N(A)$ and $N(B)$ be any neutrosophic ideals of $N(S)$ so by Lemma 4.2, $N(A)N(B) = N(A) \cap N(B)$, where $N(A) \cap N(B)$ is neutrosophic ideal of $N(S)$. Now, let $N(A) \cap N(B) \subseteq N(P)$ where $N(P)$ is a neutrosophic ideal of $N(S)$ too. But by assumption every neutrosophic ideal of a neutrosophic intra-regular LA-semigroup $N(S)$ is prime so is neutrosophic prime, therefore, $N(A)N(B) = N(A) \cap N(B) \subseteq N(P)$ implies $N(A) \subseteq N(P)$ or $N(B) \subseteq N(P)$. Hence $N(S)$ is strongly irreducible.

Conversely, assume that $N(S)$ is strongly irreducible. Let

$N(A)$, $N(B)$ and $N(P)$ be any neutrosophic ideals of $N(S)$ such that $N(A) \cap N(B) \subseteq N(P)$ implies $N(A) \subseteq N(P)$ or $N(B) \subseteq N(P)$. Now, let $N(A) \cap N(B) \subseteq N(P)$ but $N(A)N(B) = N(A) \cap N(B)$ by lemma ij, $N(A)N(B) \subseteq N(P)$ implies $N(A) \subseteq N(P)$ or $N(B) \subseteq N(P)$. Since $N(P)$ is arbitrary neutrosophic ideal of $N(S)$ so very neutrosophic ideal of a neutrosophic intra-regular LA-semigroup $N(S)$ is prime. Theorem 4.6. Every neutrosophic ideal of a neutrosophic intra-regular LA-semigroup $N(S)$ is neutrosophic prime if and only if $N(S)$ is totally ordered under inclusion.

Proof. Assume that every ideal of $N(S)$ is neutrosophic prime. Let $N(P)$ and $N(Q)$ be any neutrosophic ideals of $N(S)$, so by Lemma 4.2, $N(P)N(Q) = N(P) \cap N(Q)$, where $N(P) \cap N(Q)$ is neutrosophic ideal of $N(S)$, so is neutrosophic prime, therefore, $N(P)N(Q) \subseteq N(P) \cap N(Q)$, which implies that $N(P) \subseteq N(P) \cap N(Q)$ or $N(Q) \subseteq N(P) \cap N(Q)$, which implies that $N(P) \subseteq N(Q)$ or $N(Q) \subseteq N(P)$. Hence $N(S)$ is totally ordered under inclusion.

Conversely, assume that $N(S)$ is totally ordered under inclusion. Let $N(I)$, $N(J)$ and $N(P)$ be any neutrosophic ideals of $N(S)$ such that $N(I)N(J) \subseteq N(P)$. Now without loss of generality assume that $N(I) \subseteq N(J)$ then

$$N(I) = [N(I)]^2 = N(I)N(I) \subseteq N(I)N(J) \subseteq N(P).$$

Therefore, either $N(I) \subseteq N(P)$ or $N(J) \subseteq N(P)$, which implies that $N(P)$ is neutrosophic prime.

Theorem 4.7. The set of all neutrosophic ideals $N(I)_s$ of a neutrosophic intra-regular $N(S)$ with left identity $e + eI$ forms a semilattice structure.

Proof. Let $N(A)$, $N(B) \in N(I)_s$, since $N(A)$ and $N(B)$ are neutrosophic ideals of $N(S)$ so we have

$$[N(A)N(B)]N(S) = [N(A)N(B)][N(S)N(S)] = [N(A)N(S)][N(B)N(S)] \subseteq N(A)N(B).$$

$$\text{Also } N(S)[N(A)N(B)] = [N(S)N(S)][N(A)N(B)] = [N(S)N(A)][N(S)N(B)] \subseteq N(A)N(B).$$

Thus $N(A)N(B)$ is a neutrosophic ideal of $N(S)$. Hence $N(I)_s$ is closed. Also using Lemma ij, we have, $N(A)N(B) = N(A) \cap N(B) = N(B) \cap N(A) = N(B)N(A)$ which implies that $N(I)_s$ is commutative, so is associative. Now by using Lemma ii, $[N(A)]^2 = N(A)$, for all $N(A) \in N(I)_s$. Hence $N(I)_s$ is semilattice.

References

- [1] M. Ali, and F. Smarandache, A New Type of Group Action through the Applications of Fuzzy Sets and Neutrosophic Sets, International Journal of Mathematical Combinatorics, Vol. 04, no. 04, (2015), 33-40.
- [2] M. Ali, F. Smarandache, M. Naz, and M. Shabir, Neutrosophic Code, Critical Review, A Publication of Society for Mathematics of Uncertainty, Vol. IX, (2015), 44-54.
- [3] M. Ali, M. Shabir, M. Naz, and F. Smarandache, Neutrosophic Left Almost Semigroup, Neutrosophic Sets and Systems, Vol. 03, (2014), 18-28.
- [4] M. Ali, F. Smarandache, M. Naz, and M. Shabir, G-Neutrosophic Space, Critical Review, A Publication of Society for Mathematics of Uncertainty, Vol. VIII, (2014), 37-49.
- [5] M. Ali, F. Smarandache, M. Shabir and M. Naz, Neutrosophic Bi-LA-Semigroup and Neutrosophic N-LA-Semigroup, Neutrosophic Sets and Systems, Vol. 04, (2014), 19-24.
- [6] M. Ali, F. Smarandache, and M. Shabir, New Research on Neutrosophic Algebraic Structures, EuropaNova ASBL. 3E clos du Pannasse, Brussels 1000, Belgium.
- [7] A. H. Clifford and G. B. Preston, The algebraic theory of semigroups, John Wiley & Sons, (vol. 1)1961.
- [8] P. Holgate, Groupoids satisfying a simple invertive law, The Math. Stud., 1 – 4, 61(1992), 101 – 106.
- [9] J. Je ek and T. Kepka, A note on medial division groupoids, Proc. Amer. Math. Soc., 2, 119(1993), 423 – 426.
- [10] M. A. Kazim and M. Naseeruddin, On almost semigroups, The Alig. Bull. Math., 2(1972), 1 – 7.

- [11] S. Milić, V. Pavlović, Semigroups in which some ideal is completely simple semigroup, *Publ. Inst. Math.*, **30**, 44(1981), 123 – 130 .
- [12] Madad Khan, Some studies in AG^* -groupoids, Ph. D., thesis, Quaid-i-Azam University, Islamabad, Paksitan, 2008.
- [13] Madad Khan, F. Smarandache and Saima Anis, Theory of Abel Grassmann's groupoids, The Educationa Publiusher, Inc., Ohio, USA, 2015.
- [14] Q. Mushtaq and S. M. Yousuf, On LA-semigroups, *The Alig. Bull. Math.*, **8**(1978), 65 – 70.
- [15] Q. Mushtaq and S. M. Yousuf, On LA-semigroup defined by a commutative inverse semigroup, *Math. Bech.*, **40**(1988) , 59 – 62 .
- [16] Q. Mushtaq and M. Khan, Ideals in left almost semigroups, *Proceedings of 4th International Pure Mathematics Conference 2003*, 65 – 77.
- [17] Q. Mushtaq and M. Khan, Semilattice decomposition of locally associative AG^{**} -groupoids, *Algeb. Colloq.*, **16**, 1(2009), 17 – 22 .
- [18] N. Naseeruddin, Some studies in almost semigroups and flocks, Ph.D., thesis, Aligarh Muslim University, Aligarh, India, 1970 .
- [19] P. V. Protić and N. Stevanović, AG-test and some general properties of Abel-Grassmann's groupoids, *PU. M. A.*, **4** , 6 (1995) , 371 – 383 .
- [20] P. V. Protić and M. Bo inovic, Some congruences on an AG^{**} -groupoid, *Algebra Logic and Discrete Mathematics*, Ni, **3**, 9(1995), 879 – 886 .
- [21] Florentin Smarandache, *Neutrosophy. Neutrosophic Probability, Set, and Logic*, Amer. Res. Press, Rehoboth, USA, 105 p., 1998 (4th edition)
- [22] O. Steinfeld, *Quasi-ideals in ring and semigroups*, Akademiaikiado, Budapest, 1978 .
- [23] N. Stevanović and P. V. Protić, Composition of Abel-Grassmann's 3-bands, Novi Sad, *J. Math.*, **2** , 34(2004)

Neutrosophic N-structures and their applications in semigroups

Madad Khan, Saima Anis, Florentin Smarandache, Young Bae Jun

Madad Khan, Saima Anis, Florentin Smarandache, Young Bae Jun (2017). Neutrosophic N-structures and their applications in semigroups. *Annals of Fuzzy Mathematics and Informatics* 14(6), 583-598

ABSTRACT. The notion of neutrosophic \mathcal{N} -structure is introduced, and applied it to semigroup. The notions of neutrosophic \mathcal{N} -subsemigroup, neutrosophic \mathcal{N} -product and ε -neutrosophic \mathcal{N} -subsemigroup are introduced, and several properties are investigated. Conditions for neutrosophic \mathcal{N} -structure to be neutrosophic \mathcal{N} -subsemigroup are provided. Using neutrosophic \mathcal{N} -product, characterization of neutrosophic \mathcal{N} -subsemigroup is discussed. Relations between neutrosophic \mathcal{N} -subsemigroup and ε -neutrosophic \mathcal{N} -subsemigroup are discussed. We show that the homomorphic preimage of neutrosophic \mathcal{N} -subsemigroup is a neutrosophic \mathcal{N} -subsemigroup, and the onto homomorphic image of neutrosophic \mathcal{N} -subsemigroup is a neutrosophic \mathcal{N} -subsemigroup.

Keywords: Neutrosophic \mathcal{N} -structure, neutrosophic \mathcal{N} -subsemigroup, ε -neutrosophic \mathcal{N} -subsemigroup, neutrosophic \mathcal{N} -product.

1. INTRODUCTION

Zadeh introduced the degree of membership/truth (t) in 1965 and defined the fuzzy set. As a generalization of fuzzy sets, Atanassov introduced the degree of nonmembership/falsehood (f) in 1986 and defined the intuitionistic fuzzy set. Smarandache proposed the term “neutrosophic” because “neutrosophic” etymologically comes from “neutrosophy” [French *neutre*, Latin *neuter*, neutral, and Greek *sophia*, skill/wisdom] which means knowledge of neutral thought, and this third/neutral represents the main distinction between “fuzzy” / “intuitionistic fuzzy” logic/set and “neutrosophic” logic/set, i.e. the *included middle* component (Lupasco-Nicolescu’s logic in philosophy), i.e. the neutral/indeterminate/unknown part (besides the “truth” / “membership” and “falsehood” / “non-membership” components

that both appear in fuzzy logic/set). Smarandache introduced the degree of indeterminacy/neutrality (i) as independent component in 1995 (published in 1998) and defined the neutrosophic set on three components

$$(t, i, f) = (\text{truth, indeterminacy, falsehood}).$$

For more detail, refer to the site

<http://fs.gallup.unm.edu/FlorentinSmarandache.htm>.

The concept of neutrosophic set (NS) developed by Smarandache [?] and Smarandache [?] is a more general platform which extends the concepts of the classic set and fuzzy set, intuitionistic fuzzy set and interval valued intuitionistic fuzzy set. Neutrosophic set theory is applied to various part (refer to the site

<http://fs.gallup.unm.edu/neutrosophy.htm>).

A (crisp) set A in a universe X can be defined in the form of its characteristic function $\mu_A : X \rightarrow \{0, 1\}$ yielding the value 1 for elements belonging to the set A and the value 0 for elements excluded from the set A . So far most of the generalization of the crisp set have been conducted on the unit interval $[0, 1]$ and they are consistent with the asymmetry observation. In other words, the generalization of the crisp set to fuzzy sets relied on spreading positive information that fit the crisp point $\{1\}$ into the interval $[0, 1]$. Because no negative meaning of information is suggested, we now feel a need to deal with negative information. To do so, we also feel a need to supply mathematical tool. To attain such object, Jun et al. [?] introduced a new function which is called negative-valued function, and constructed \mathcal{N} -structures. This structure is applied to BE -algebra, BCK/BCI -algebra and BCH -algebra etc. (see [?], [?], [?], [?]).

In this paper, we introduce the notion of neutrosophic \mathcal{N} -structure and applied it to semigroup. We introduce the notion of neutrosophic \mathcal{N} -subsemi-group and investigate several properties. We provide conditions for neutrosophic \mathcal{N} -structure to be neutrosophic \mathcal{N} -subsemigroup. We define neutrosophic \mathcal{N} -product, and give characterization of neutrosophic \mathcal{N} -subsemigroup by using neutrosophic \mathcal{N} -product. We also introduce ε -neutrosophic subsemigroup, and investigate relations between neutrosophic subsemigroup and ε -neutrosophic subsemigroup. We show that the homomorphic preimage of neutrosophic \mathcal{N} -subsemigroup is a neutrosophic \mathcal{N} -subsemi-group, and the onto homomorphic image of neutrosophic \mathcal{N} -subsemigroup is a neutrosophic \mathcal{N} -subsemigroup.

2. PRELIMINARIES

Let X be a semigroup. Let A and B be subsets of X . Then the multiplication of A and B is defined as follows:

$$AB = \{ab \in X \mid a \in A, b \in B\}.$$

By a subsemigroup of X , we mean a nonempty subset A of X such that $A^2 \subseteq A$. We consider the empty set \emptyset is always a subsemigroup of X .

We refer the reader to the book [?] for further information regarding fuzzy semi-groups.

For any family $\{a_i \mid i \in \Lambda\}$ of real numbers, we define:

$$\bigvee\{a_i \mid i \in \Lambda\} := \begin{cases} \max\{a_i \mid i \in \Lambda\} & \text{if } \Lambda \text{ is finite,} \\ \sup\{a_i \mid i \in \Lambda\} & \text{otherwise} \end{cases}$$

and

$$\bigwedge\{a_i \mid i \in \Lambda\} := \begin{cases} \min\{a_i \mid i \in \Lambda\} & \text{if } \Lambda \text{ is finite,} \\ \inf\{a_i \mid i \in \Lambda\} & \text{otherwise.} \end{cases}$$

For any real numbers a and b , we also use $a \vee b$ and $a \wedge b$ instead of $\bigvee\{a, b\}$ and $\bigwedge\{a, b\}$, respectively.

3. NEUTROSOPHIC \mathcal{N} -STRUCTURES

Denote by $\mathcal{F}(X, [-1, 0])$ the collection of functions from a set X to $[-1, 0]$. We say that an element of $\mathcal{F}(X, [-1, 0])$ is a negative-valued function from X to $[-1, 0]$ (briefly, \mathcal{N} -function on X). By an \mathcal{N} -structure, we mean an ordered pair (X, f) of X and an \mathcal{N} -function f on X . In what follows, let X denote the nonempty universe of discourse unless otherwise specified.

Definition 3.1. A neutrosophic \mathcal{N} -structure over X is defined to be the structure:

$$(3.1) \quad X_{\mathbf{N}} := \frac{X}{(T_N, I_N, F_N)} = \left\{ \frac{x}{(T_N(x), I_N(x), F_N(x))} \mid x \in X \right\}$$

where T_N , I_N and F_N are \mathcal{N} -functions on X which are called the negative truth membership function, the negative indeterminacy membership function and the negative falsity membership function, respectively, on X .

Note that every neutrosophic \mathcal{N} -structure $X_{\mathbf{N}}$ over X satisfies the condition:

$$(\forall x \in X) (-3 \leq T_N(x) + I_N(x) + F_N(x) \leq 0).$$

Example 3.2. Consider a universe of discourse $X = \{x, y, z\}$. We know that

$$X_{\mathbf{N}} = \left\{ \frac{x}{(-0.7, -0.5, -0.1)}, \frac{y}{(-0.2, -0.3, -0.4)}, \frac{z}{(-0.3, -0.6, -0.1)} \right\}$$

is a neutrosophic \mathcal{N} -structure over X .

Definition 3.3. Let $X_{\mathbf{N}} := \frac{X}{(T_N, I_N, F_N)}$ and $X_{\mathbf{M}} := \frac{X}{(T_M, I_M, F_M)}$ be neutrosophic \mathcal{N} -structures over X . We say that $X_{\mathbf{M}}$ is a neutrosophic \mathcal{N} -substructure over X , denoted by $X_{\mathbf{N}} \subseteq X_{\mathbf{M}}$, if it satisfies:

$$(\forall x \in X) (T_N(x) \geq T_M(x), I_N(x) \leq I_M(x), F_N(x) \geq F_M(x)).$$

If $X_{\mathbf{N}} \subseteq X_{\mathbf{M}}$ and $X_{\mathbf{M}} \subseteq X_{\mathbf{N}}$, we say that $X_{\mathbf{N}} = X_{\mathbf{M}}$.

Definition 3.4. Let $X_{\mathbf{N}} := \frac{X}{(T_N, I_N, F_N)}$ and $X_{\mathbf{M}} := \frac{X}{(T_M, I_M, F_M)}$ be neutrosophic \mathcal{N} -structures over X .

(1) The union of $X_{\mathbf{N}}$ and $X_{\mathbf{M}}$ is defined to be a neutrosophic \mathcal{N} -structure

$$X_{\mathbf{N} \cup \mathbf{M}} = (X; T_{\mathbf{N} \cup \mathbf{M}}, I_{\mathbf{N} \cup \mathbf{M}}, F_{\mathbf{N} \cup \mathbf{M}}),$$

where

$$\begin{aligned} T_{N \cup M}(x) &= \bigwedge \{T_N(x), T_M(x)\}, \\ I_{N \cup M}(x) &= \bigvee \{I_N(x), I_M(x)\}, \\ F_{N \cup M}(x) &= \bigwedge \{F_N(x), F_M(x)\}, \end{aligned}$$

for all $x \in X$.

(2) The intersection of X_N and X_M is defined to be a neutrosophic \mathcal{N} -structure

$$X_{N \cap M} = (X; T_{N \cap M}, I_{N \cap M}, F_{N \cap M}),$$

where

$$\begin{aligned} T_{N \cap M}(x) &= \bigvee \{T_N(x), T_M(x)\}, \\ I_{N \cap M}(x) &= \bigwedge \{I_N(x), I_M(x)\}, \\ F_{N \cap M}(x) &= \bigvee \{F_N(x), F_M(x)\}, \end{aligned}$$

for all $x \in X$.

Definition 3.5. Given a neutrosophic \mathcal{N} -structure $X_N := \frac{X}{(T_N, I_N, F_N)}$ over X , the complement of X_N is defined to be a neutrosophic \mathcal{N} -structure

$$X_{N^c} := \frac{X}{(T_{N^c}, I_{N^c}, F_{N^c})}$$

over X , where

$$T_{N^c}(x) = -1 - T_N(x), I_{N^c}(x) = -1 - I_N(x) \text{ and } F_{N^c}(x) = -1 - F_N(x),$$

for all $x \in X$.

Example 3.6. Let $X = \{a, b, c\}$ be a universe of discourse and let X_N be the neutrosophic \mathcal{N} -structure over X in Example ???. Let X_M be a neutrosophic \mathcal{N} -structure over X which is given by

$$X_M = \left\{ \frac{x}{(-0.3, -0.5, -0.2)}, \frac{y}{(-0.4, -0.2, -0.2)}, \frac{z}{(-0.5, -0.7, -0.8)} \right\}.$$

The union and intersection of X_N and X_M are given as follows respectively:

$$X_{N \cup M} = \left\{ \frac{x}{(-0.7, -0.5, -0.2)}, \frac{y}{(-0.4, -0.3, -0.4)}, \frac{z}{(-0.5, -0.7), -0.8)} \right\}$$

and

$$X_{N \cap M} = \left\{ \frac{x}{(-0.3, -0.5, -0.1)}, \frac{y}{(-0.2, -0.2, -0.2)}, \frac{z}{(-0.3, -0.6, -0.1)} \right\}.$$

The complement of X_N is given by

$$X_{M^c} = \left\{ \frac{x}{(-0.7, -0.5, -0.8)}, \frac{y}{(-0.6, -0.8, -0.8)}, \frac{z}{(-0.5, -0.3, -0.2)} \right\}.$$

4. APPLICATIONS IN SEMIGROUPS

In this section, we take a semigroup X as the universe of discourse unless otherwise specified.

Definition 4.1. A neutrosophic \mathcal{N} -structure $X_{\mathbf{N}}$ over X is called a neutrosophic \mathcal{N} -subsemigroup of X if the following condition is valid:

$$(4.1) \quad (\forall x, y \in X) \left(\begin{array}{l} T_N(xy) \leq \bigvee \{T_N(x), T_N(y)\} \\ I_N(xy) \geq \bigwedge \{I_N(x), I_N(y)\} \\ F_N(xy) \leq \bigvee \{F_N(x), F_N(y)\} \end{array} \right).$$

Let $X_{\mathbf{N}}$ be a neutrosophic \mathcal{N} -structure over X and let $\alpha, \beta, \gamma \in [-1, 0]$ be such that $-3 \leq \alpha + \beta + \gamma \leq 0$. Consider the following sets:

$$(4.2) \quad \begin{aligned} T_N^\alpha &:= \{x \in X \mid T_N(x) \leq \alpha\}, \\ I_N^\beta &:= \{x \in X \mid I_N(x) \geq \beta\}, \\ F_N^\gamma &:= \{x \in X \mid F_N(x) \leq \gamma\}. \end{aligned}$$

The set

$$X_{\mathbf{N}}(\alpha, \beta, \gamma) := \{x \in X \mid T_N(x) \leq \alpha, I_N(x) \geq \beta, F_N(x) \leq \gamma\}$$

is called a (α, β, γ) -level set of $X_{\mathbf{N}}$. Note that

$$X_{\mathbf{N}}(\alpha, \beta, \gamma) = T_N^\alpha \cap I_N^\beta \cap F_N^\gamma.$$

Theorem 4.2. Let $X_{\mathbf{N}}$ be a neutrosophic \mathcal{N} -structure over X and let $\alpha, \beta, \gamma \in [-1, 0]$ be such that $-3 \leq \alpha + \beta + \gamma \leq 0$. If $X_{\mathbf{N}}$ is a neutrosophic \mathcal{N} -subsemigroup of X , then the (α, β, γ) -level set of $X_{\mathbf{N}}$ is a subsemigroup of X whenever it is nonempty.

Proof. Assume that $X_{\mathbf{N}}(\alpha, \beta, \gamma) \neq \emptyset$ for $\alpha, \beta, \gamma \in [-1, 0]$ with $-3 \leq \alpha + \beta + \gamma \leq 0$. Let $x, y \in X_{\mathbf{N}}(\alpha, \beta, \gamma)$. Then $T_N(x) \leq \alpha, I_N(x) \geq \beta, F_N(x) \leq \gamma, T_N(y) \leq \alpha, I_N(y) \geq \beta$ and $F_N(y) \leq \gamma$. Thus it follows from (??) that

$$\begin{aligned} T_N(xy) &\leq \bigvee \{T_N(x), T_N(y)\} \leq \alpha, \\ I_N(xy) &\geq \bigwedge \{I_N(x), I_N(y)\} \geq \beta, \\ F_N(xy) &\leq \bigvee \{F_N(x), F_N(y)\} \leq \gamma. \end{aligned}$$

So $xy \in X_{\mathbf{N}}(\alpha, \beta, \gamma)$. Hence $X_{\mathbf{N}}(\alpha, \beta, \gamma)$ is a subsemigroup of X . □

Theorem 4.3. Let $X_{\mathbf{N}}$ be a neutrosophic \mathcal{N} -structure over X and let $\alpha, \beta, \gamma \in [-1, 0]$ be such that $-3 \leq \alpha + \beta + \gamma \leq 0$. If T_N^α, I_N^β and F_N^γ are subsemigroups of X , then $X_{\mathbf{N}}$ is a neutrosophic \mathcal{N} -subsemigroup of X .

Proof. Assume that there are $a, b \in X$ such that $T_N(ab) > \bigvee \{T_N(a), T_N(b)\}$. Then $T_N(ab) > t_\alpha \geq \bigvee \{T_N(a), T_N(b)\}$ for some $t_\alpha \in [-1, 0)$. Thus $a, b \in T_N^{t_\alpha}$ but $ab \notin T_N^{t_\alpha}$, which is a contradiction. So

$$T_N(xy) \leq \bigvee \{T_N(x), T_N(y)\},$$

for all $x, y \in X$.

Assume that $I_N(ab) < \bigwedge \{I_N(a), I_N(b)\}$, for some $a, b \in X$. Then $a, b \in I_N^{t_\beta}$ and $ab \notin I_N^{t_\beta}$, for $t_\beta := \bigwedge \{I_N(a), I_N(b)\}$. This is a contradiction. Thus

$$I_N(xy) \geq \bigwedge \{I_N(x), I_N(y)\},$$

for all $x, y \in X$.

Now, suppose that there exist $a, b \in X$ and $t_\gamma \in [-1, 0)$ such that

$$F_N(ab) > t_\gamma \geq \bigvee \{F_N(a), F_N(b)\}.$$

Then $a, b \in F_N^{t_\gamma}$ and $ab \notin F_N^{t_\gamma}$, which is a contradiction. Thus

$$F_N(xy) \leq \bigvee \{F_N(x), F_N(y)\},$$

for all $x, y \in X$. Hence X_N is a neutrosophic \mathcal{N} -subsemigroup of X . □

Theorem 4.4. *The intersection of two neutrosophic \mathcal{N} -subsemigroups is also a neutrosophic \mathcal{N} -subsemigroup.*

Proof. Let $X_N := \frac{X}{(T_N, I_N, F_N)}$ and $X_M := \frac{X}{(T_M, I_M, F_M)}$ be neutrosophic \mathcal{N} -subsemigroups of X . For any $x, y \in X$, we have

$$\begin{aligned} T_{N \cap M}(xy) &= \bigvee \{T_N(xy), T_M(xy)\} \\ &\leq \bigvee \left\{ \bigvee \{T_N(x), T_N(y)\}, \bigvee \{T_M(x), T_M(y)\} \right\} \\ &= \bigvee \left\{ \bigvee \{T_N(x), T_M(x)\}, \bigvee \{T_N(y), T_M(y)\} \right\} \\ &= \bigvee \{T_{N \cap M}(x), T_{N \cap M}(y)\}, \end{aligned}$$

$$\begin{aligned} I_{N \cap M}(xy) &= \bigwedge \{I_N(xy), I_M(xy)\} \\ &\geq \bigwedge \left\{ \bigwedge \{I_N(x), I_N(y)\}, \bigwedge \{I_M(x), I_M(y)\} \right\} \\ &= \bigwedge \left\{ \bigwedge \{I_N(x), I_M(x)\}, \bigwedge \{I_N(y), I_M(y)\} \right\} \\ &= \bigwedge \{I_{N \cap M}(x), I_{N \cap M}(y)\} \end{aligned}$$

and

$$\begin{aligned} F_{N \cap M}(xy) &= \bigvee \{F_N(xy), F_M(xy)\} \\ &\leq \bigvee \left\{ \bigvee \{F_N(x), F_N(y)\}, \bigvee \{F_M(x), F_M(y)\} \right\} \\ &= \bigvee \left\{ \bigvee \{F_N(x), F_M(x)\}, \bigvee \{F_N(y), F_M(y)\} \right\} \\ &= \bigvee \{F_{N \cap M}(x), F_{N \cap M}(y)\}, \end{aligned}$$

for all $x, y \in X$. Then $X_{N \cap M}$ is a neutrosophic \mathcal{N} -subsemigroup of X . □

Corollary 4.5. *If $\{X_{N_i} \mid i \in \mathbb{N}\}$ is a family of neutrosophic \mathcal{N} -subsemigroups of X , then so is $X_{\cap N_i}$.*

Let $X_{\mathbf{N}} := \frac{X}{(T_N, I_N, F_N)}$ and $X_{\mathbf{M}} := \frac{X}{(T_M, I_M, F_M)}$ be neutrosophic \mathcal{N} -structures over X . The neutrosophic \mathcal{N} -product of $X_{\mathbf{N}}$ and $X_{\mathbf{M}}$ is defined to be a neutrosophic \mathcal{N} -structure over X

$$X_{\mathbf{N}} \odot X_{\mathbf{M}} = \frac{X}{T_{N \circ M}, I_{N \circ M}, F_{N \circ M}} = \left\{ \frac{x}{T_{N \circ M}(x), I_{N \circ M}(x), F_{N \circ M}(x)} \mid x \in X \right\},$$

where

$$T_{N \circ M}(x) = \begin{cases} \bigwedge_{x=yz} \{T_N(y) \vee T_M(z)\} & \text{if } \exists y, z \in X \text{ such that } x = yz \\ 0 & \text{otherwise,} \end{cases}$$

$$I_{N \circ M}(x) = \begin{cases} \bigvee_{x=yz} \{I_N(y) \wedge I_M(z)\} & \text{if } \exists y, z \in X \text{ such that } x = yz \\ -1 & \text{otherwise} \end{cases}$$

and

$$F_{N \circ M}(x) = \begin{cases} \bigwedge_{x=yz} \{F_N(y) \vee F_M(z)\} & \text{if } \exists y, z \in X \text{ such that } x = yz \\ 0 & \text{otherwise.} \end{cases}$$

For any $x \in X$, the element $\frac{x}{T_{N \circ M}(x), I_{N \circ M}(x), F_{N \circ M}(x)}$ is simply denoted by

$$(X_{\mathbf{N}} \odot X_{\mathbf{M}})(x) := (T_{N \circ M}(x), I_{N \circ M}(x), F_{N \circ M}(x))$$

for the sake of convenience.

Theorem 4.6. *A neutrosophic \mathcal{N} -structure $X_{\mathbf{N}}$ over X is a neutrosophic \mathcal{N} -subsemigroup of X if and only if $X_{\mathbf{N}} \odot X_{\mathbf{N}} \subseteq X_{\mathbf{N}}$.*

Proof. Assume that $X_{\mathbf{N}}$ is a neutrosophic \mathcal{N} -subsemigroup of X and let $x \in X$. If $x \neq yz$ for all $x, y \in X$, then clearly $X_{\mathbf{N}} \odot X_{\mathbf{N}} \subseteq X_{\mathbf{N}}$. Assume that there exist $a, b \in X$ such that $x = ab$. Then

$$T_{N \circ N}(x) = \bigwedge_{x=ab} \{T_N(a) \vee T_N(b)\} \geq \bigwedge_{x=ab} T_N(ab) = T_N(x),$$

$$I_{N \circ N}(x) = \bigvee_{x=ab} \{I_N(a) \wedge I_N(b)\} \leq \bigvee_{x=ab} I_N(ab) = I_N(x),$$

and

$$F_{N \circ N}(x) = \bigwedge_{x=ab} \{F_N(a) \vee F_N(b)\} \geq \bigwedge_{x=ab} F_N(ab) = F_N(x).$$

Thus $X_{\mathbf{N}} \odot X_{\mathbf{N}} \subseteq X_{\mathbf{N}}$.

Conversely, let $X_{\mathbf{N}}$ be any neutrosophic \mathcal{N} -structure over X such that $X_{\mathbf{N}} \odot X_{\mathbf{N}} \subseteq X_{\mathbf{N}}$. Let x and y be any elements of X and let $a = xy$. Then

$$T_N(xy) = T_N(a) \leq T_{N \circ N}(a) = \bigwedge_{a=bc} \{T_N(b) \vee T_N(c)\} \leq T_N(x) \vee T_N(y),$$

$$I_N(xy) = I_N(a) \geq I_{N \circ N}(a) = \bigvee_{a=bc} \{I_N(b) \wedge I_N(c)\} \geq I_N(x) \wedge I_N(y),$$

and

$$F_N(xy) = F_N(a) \leq F_{N \circ N}(a) = \bigwedge_{a=bc} \{F_N(b) \vee F_N(c)\} \leq F_N(x) \vee F_N(y).$$

Thus X_N is a neutrosophic \mathcal{N} -subsemigroup of X . □

Since $[-1, 0]$ is a completely distributive lattice with respect to the usual ordering, we have the following theorem.

Theorem 4.7. *If $\{X_{N_i} \mid i \in \mathbb{N}\}$ is a family of neutrosophic \mathcal{N} -subsemigroups of X , then $(\{X_{N_i} \mid i \in \mathbb{N}\}, \subseteq)$ forms a complete distributive lattice.*

Theorem 4.8. *Let X be a semigroup with identity e and let $X_N := \frac{X}{(T_N, I_N, F_N)}$ be a neutrosophic \mathcal{N} -structure over X such that*

$$(\forall x \in X) (X_N(e) \geq X_N(x)),$$

that is, $T_N(e) \leq T_N(x)$, $I_N(e) \geq I_N(x)$ and $F_N(e) \leq F_N(x)$ for all $x \in X$. If X_N is a neutrosophic \mathcal{N} -subsemigroup of X , then X_N is neutrosophic idempotent, that is, $X_N \odot X_N = X_N$.

Proof. For any $x \in X$, we have

$$T_{N \circ N}(x) = \bigwedge_{x=yz} \{T_N(y) \vee T_N(z)\} \leq T_N(x) \vee T_N(e) = T_N(x),$$

$$I_{N \circ N}(x) = \bigvee_{x=yz} \{I_N(y) \wedge I_N(z)\} \geq I_N(x) \wedge I_N(e) = I_N(x)$$

and

$$F_{N \circ N}(x) = \bigwedge_{x=yz} \{F_N(y) \vee F_N(z)\} \leq F_N(x) \vee F_N(e) = F_N(x).$$

This shows that $X_N \subseteq X_N \odot X_N$. Since $X_N \supseteq X_N \odot X_N$, by Theorem ??, we know that X_N is neutrosophic idempotent. □

Definition 4.9. A neutrosophic \mathcal{N} -structure X_N over X is called an ε -neutrosophic \mathcal{N} -subsemigroup of X , if the following condition is valid:

$$(4.3) \quad (\forall x, y \in X) \left(\begin{array}{l} T_N(xy) \leq \vee\{T_N(x), T_N(y), \varepsilon_T\} \\ I_N(xy) \geq \wedge\{I_N(x), I_N(y), \varepsilon_I\} \\ F_N(xy) \leq \vee\{F_N(x), F_N(y), \varepsilon_F\} \end{array} \right),$$

where $\varepsilon_T, \varepsilon_I, \varepsilon_F \in [-1, 0]$ such that $-3 \leq \varepsilon_T + \varepsilon_I + \varepsilon_F \leq 0$.

Example 4.10. Let $X = \{e, a, b, c\}$ be a semigroup with the Cayley table which is given in Table ??.

Let X_N be a neutrosophic \mathcal{N} -structure over X which is given as follows:

$$X_N = \left\{ \frac{e}{(-0.4, -0.3, -0.25)}, \frac{a}{(-0.3, -0.5, -0.25)}, \frac{b}{(-0.2, -0.3, -0.2)}, \frac{c}{(-0.1, -0.7, -0.1)} \right\}.$$

Then X_N is an ε -neutrosophic \mathcal{N} -subsemigroup of X with $\varepsilon = (-0.4 -0.2, -0.3)$.

TABLE 1. Cayley table for the binary operation “.”

·	e	a	b	c
e	e	e	e	e
a	e	a	e	a
b	e	e	b	b
c	e	a	b	c

Proposition 4.11. *Let $X_{\mathbf{N}}$ be an ε -neutrosophic \mathcal{N} -subsemigroup of X . If $X_{\mathbf{N}}(x) \leq (\varepsilon_T, \varepsilon_I, \varepsilon_F)$, that is, $T_{\mathbf{N}}(x) \geq \varepsilon_T$, $I_{\mathbf{N}}(x) \leq \varepsilon_I$ and $F_{\mathbf{N}}(x) \geq \varepsilon_F$, for all $x \in X$, then $X_{\mathbf{N}}$ is a neutrosophic \mathcal{N} -subsemigroup of X .*

Proof. Straightforward. □

Theorem 4.12. *Let $X_{\mathbf{N}}$ be a neutrosophic \mathcal{N} -structure over X and let $\alpha, \beta, \gamma \in [-1, 0]$ be such that $-3 \leq \alpha + \beta + \gamma \leq 0$. If $X_{\mathbf{N}}$ is an ε -neutrosophic \mathcal{N} -subsemigroup of X , then the (α, β, γ) -level set of $X_{\mathbf{N}}$ is a subsemigroup of X whenever $(\alpha, \beta, \gamma) \leq (\varepsilon_T, \varepsilon_I, \varepsilon_F)$, that is, $\alpha \geq \varepsilon_T$, $\beta \leq \varepsilon_I$ and $\gamma \geq \varepsilon_F$.*

Proof. Assume that $X_{\mathbf{N}}(\alpha, \beta, \gamma) \neq \emptyset$ for $\alpha, \beta, \gamma \in [-1, 0]$ with $-3 \leq \alpha + \beta + \gamma \leq 0$. Let $x, y \in X_{\mathbf{N}}(\alpha, \beta, \gamma)$. Then $T_{\mathbf{N}}(x) \leq \alpha$, $I_{\mathbf{N}}(x) \geq \beta$, $F_{\mathbf{N}}(x) \leq \gamma$, $T_{\mathbf{N}}(y) \leq \alpha$, $I_{\mathbf{N}}(y) \geq \beta$ and $F_{\mathbf{N}}(y) \leq \gamma$. Thus it follows from (??) that

$$T_{\mathbf{N}}(xy) \leq \bigvee \{T_{\mathbf{N}}(x), T_{\mathbf{N}}(y), \varepsilon_T\} \leq \bigvee \{\alpha, \varepsilon_T\} = \alpha,$$

$$I_{\mathbf{N}}(xy) \geq \bigwedge \{I_{\mathbf{N}}(x), I_{\mathbf{N}}(y), \varepsilon_I\} \geq \bigwedge \{\beta, \varepsilon_I\} = \beta,$$

$$F_{\mathbf{N}}(xy) \leq \bigvee \{F_{\mathbf{N}}(x), F_{\mathbf{N}}(y), \varepsilon_F\} \leq \bigvee \{\gamma, \varepsilon_F\} = \gamma.$$

So $xy \in X_{\mathbf{N}}(\alpha, \beta, \gamma)$. Hence $X_{\mathbf{N}}(\alpha, \beta, \gamma)$ is a subsemigroup of X . □

Theorem 4.13. *Let $X_{\mathbf{N}}$ be a neutrosophic \mathcal{N} -structure over X and let $\alpha, \beta, \gamma \in [-1, 0]$ be such that $-3 \leq \alpha + \beta + \gamma \leq 0$. If $T_{\mathbf{N}}^{\alpha}$, $I_{\mathbf{N}}^{\beta}$ and $F_{\mathbf{N}}^{\gamma}$ are subsemigroups of X for all $\varepsilon_T, \varepsilon_I, \varepsilon_F \in [-1, 0]$ with $-3 \leq \varepsilon_T + \varepsilon_I + \varepsilon_F \leq 0$ and $(\alpha, \beta, \gamma) \leq (\varepsilon_T, \varepsilon_I, \varepsilon_F)$, then $X_{\mathbf{N}}$ is an ε -neutrosophic \mathcal{N} -subsemigroup of X .*

Proof. Assume that there are $a, b \in X$ such that

$$T_{\mathbf{N}}(ab) > \bigvee \{T_{\mathbf{N}}(a), T_{\mathbf{N}}(b), \varepsilon_T\}.$$

Then $T_{\mathbf{N}}(ab) > t_{\alpha} \geq \bigvee \{T_{\mathbf{N}}(a), T_{\mathbf{N}}(b), \varepsilon_T\}$, for some $t_{\alpha} \in [-1, 0)$. It follows that $a, b \in T_{\mathbf{N}}^{t_{\alpha}}$, $ab \notin T_{\mathbf{N}}^{t_{\alpha}}$ and $t_{\alpha} \geq \varepsilon_T$. This is a contradiction, since $T_{\mathbf{N}}^{t_{\alpha}}$ is a subsemigroup of X by hypothesis. Thus

$$T_{\mathbf{N}}(xy) \leq \bigvee \{T_{\mathbf{N}}(x), T_{\mathbf{N}}(y), \varepsilon_T\},$$

for all $x, y \in X$. Suppose that $I_{\mathbf{N}}(ab) < \bigwedge \{I_{\mathbf{N}}(a), I_{\mathbf{N}}(b), \varepsilon_I\}$, for some $a, b \in X$. If we take $t_{\beta} := \bigwedge \{I_{\mathbf{N}}(a), I_{\mathbf{N}}(b), \varepsilon_I\}$, then $a, b \in I_{\mathbf{N}}^{t_{\beta}}$, $ab \notin I_{\mathbf{N}}^{t_{\beta}}$ and $t_{\beta} \leq \varepsilon_I$. This is a contradiction. So

$$I_{\mathbf{N}}(xy) \geq \bigwedge \{I_{\mathbf{N}}(x), I_{\mathbf{N}}(y), \varepsilon_I\},$$

for all $x, y \in X$. Now, suppose that there exist $a, b \in X$ and $t_\gamma \in [-1, 0)$ such that

$$F_N(ab) > t_\gamma \geq \bigvee \{F_N(a), F_N(b), \varepsilon_F\}.$$

Then $a, b \in F_N^{t_\gamma}$, $ab \notin F_N^{t_\gamma}$ and $t_\gamma \geq \varepsilon_F$, which is a contradiction. Thus

$$F_N(xy) \leq \bigvee \{F_N(x), F_N(y), \varepsilon_F\},$$

for all $x, y \in X$. Hence X_N is an ε -neutrosophic \mathcal{N} -subsemigroup of X . □

Theorem 4.14. *For any $\varepsilon_T, \varepsilon_I, \varepsilon_F, \delta_T, \delta_I, \delta_F \in [-1, 0]$ with $-3 \leq \varepsilon_T + \varepsilon_I + \varepsilon_F \leq 0$ and $-3 \leq \delta_T + \delta_I + \delta_F \leq 0$, if X_N and X_M are an ε -neutrosophic \mathcal{N} -subsemigroup and a δ -neutrosophic \mathcal{N} -subsemigroup, respectively, of X , then their intersection is a ξ -neutrosophic \mathcal{N} -subsemigroup of X for $\xi := \varepsilon \wedge \delta$, that is, $(\xi_T, \xi_I, \xi_F) = (\varepsilon_T \vee \delta_T, \varepsilon_I \wedge \delta_I, \varepsilon_F \vee \delta_F)$.*

Proof. For any $x, y \in X$, we have

$$\begin{aligned} T_{N \cap M}(xy) &= \bigvee \{T_N(xy), T_M(xy)\} \\ &\leq \bigvee \left\{ \bigvee \{T_N(x), T_N(y), \varepsilon_T\}, \bigvee \{T_M(x), T_M(y), \delta_T\} \right\} \\ &\leq \bigvee \left\{ \bigvee \{T_N(x), T_N(y), \xi_T\}, \bigvee \{T_M(x), T_M(y), \xi_T\} \right\} \\ &= \bigvee \left\{ \bigvee \{T_N(x), T_M(x), \xi_T\}, \bigvee \{T_N(y), T_M(y), \xi_T\} \right\} \\ &= \bigvee \left\{ \bigvee \{T_N(x), T_M(x)\}, \bigvee \{T_N(y), T_M(y)\}, \xi_T \right\} \\ &= \bigvee \{T_{N \cap M}(x), T_{N \cap M}(y), \xi_T\}, \end{aligned}$$

$$\begin{aligned} I_{N \cap M}(xy) &= \bigwedge \{I_N(xy), I_M(xy)\} \\ &\geq \bigwedge \left\{ \bigwedge \{I_N(x), I_N(y), \varepsilon_I\}, \bigwedge \{I_M(x), I_M(y), \delta_I\} \right\} \\ &\geq \bigwedge \left\{ \bigwedge \{I_N(x), I_N(y), \xi_I\}, \bigwedge \{I_M(x), I_M(y), \xi_I\} \right\} \\ &= \bigwedge \left\{ \bigwedge \{I_N(x), I_M(x), \xi_I\}, \bigwedge \{I_N(y), I_M(y), \xi_I\} \right\} \\ &= \bigwedge \left\{ \bigwedge \{I_N(x), I_M(x)\}, \bigwedge \{I_N(y), I_M(y)\}, \xi_I \right\} \\ &= \bigwedge \{I_{N \cap M}(x), I_{N \cap M}(y), \xi_I\}, \end{aligned}$$

and

$$\begin{aligned}
 F_{N \cap M}(xy) &= \bigvee \{F_N(xy), F_M(xy)\} \\
 &\leq \bigvee \left\{ \bigvee \{F_N(x), F_N(y), \varepsilon_F\}, \bigvee \{F_M(x), F_M(y), \delta_F\} \right\} \\
 &\leq \bigvee \left\{ \bigvee \{F_N(x), F_N(y), \xi_F\}, \bigvee \{F_M(x), F_M(y), \xi_F\} \right\} \\
 &= \bigvee \left\{ \bigvee \{F_N(x), F_M(x), \xi_F\}, \bigvee \{F_N(y), F_M(y), \xi_F\} \right\} \\
 &= \bigvee \left\{ \bigvee \{F_N(x), F_M(x)\}, \bigvee \{F_N(y), F_M(y)\}, \xi_F \right\} \\
 &= \bigvee \{F_{N \cap M}(x), F_{N \cap M}(y), \xi_F\}.
 \end{aligned}$$

Then $X_{N \cap M}$ is a ξ -neutrosophic \mathcal{N} -subsemigroup of X . □

Theorem 4.15. *Let $X_{\mathcal{N}}$ be an ε -neutrosophic \mathcal{N} -subsemigroup of X . If*

$$\kappa := (\kappa_T, \kappa_I, \kappa_F) = \left(\bigvee_{x \in X} \{T_N(x)\}, \bigwedge_{x \in X} \{I_N(x)\}, \bigvee_{x \in X} \{F_N(x)\} \right),$$

then the set

$$\Omega := \{x \in X \mid T_N(x) \leq \kappa_T \vee \varepsilon_T, I_N(x) \geq \kappa_I \wedge \varepsilon_I, F_N(x) \leq \kappa_F \vee \varepsilon_F\}$$

is a subsemigroup of X .

Proof. Let $x, y \in \Omega$ for any $x, y \in X$. Then

$$\begin{aligned}
 T_N(x) &\leq \kappa_T \vee \varepsilon_T = \bigvee_{x \in X} \{T_N(x)\} \vee \varepsilon_T, \\
 I_N(x) &\geq \kappa_I \wedge \varepsilon_I = \bigwedge_{x \in X} \{I_N(x)\} \wedge \varepsilon_I, \\
 F_N(x) &\leq \kappa_F \vee \varepsilon_F = \bigvee_{x \in X} \{F_N(x)\} \vee \varepsilon_F, \\
 T_N(y) &\leq \kappa_T \vee \varepsilon_T = \bigvee_{y \in X} \{T_N(y)\} \vee \varepsilon_T, \\
 I_N(y) &\geq \kappa_I \wedge \varepsilon_I = \bigwedge_{y \in X} \{I_N(y)\} \wedge \varepsilon_I, \\
 F_N(y) &\leq \kappa_F \vee \varepsilon_F = \bigvee_{y \in X} \{F_N(y)\} \vee \varepsilon_F.
 \end{aligned}$$

Thus it follows from (??) that

$$\begin{aligned}
 T_N(xy) &\leq \bigvee \{T_N(x), T_N(y), \varepsilon_T\} \\
 &\leq \bigvee \{\kappa_T \vee \varepsilon_T, \kappa_T \vee \varepsilon_T, \varepsilon_T\} \\
 &= \kappa_T \vee \varepsilon_T,
 \end{aligned}$$

$$\begin{aligned} I_N(xy) &\geq \bigwedge \{I_N(x), I_N(y), \varepsilon_I\} \\ &\geq \bigwedge \{\kappa_I \wedge \varepsilon_I, \kappa_I \wedge \varepsilon_I, \varepsilon_I\} \\ &= \kappa_I \wedge \varepsilon_I \end{aligned}$$

and

$$\begin{aligned} F_N(xy) &\leq \bigvee \{F_N(x), F_N(y), \varepsilon_F\} \\ &\leq \bigvee \{\kappa_F \vee \varepsilon_F, \kappa_F \vee \varepsilon_F, \varepsilon_F\} \\ &= \kappa_F \vee \varepsilon_F. \end{aligned}$$

So $xy \in \Omega$. Hence Ω is a subsemigroup of X . □

For a map $f : X \rightarrow Y$ of semigroups and a neutrosophic \mathcal{N} -structure $X_{\mathbf{N}} := \frac{Y}{(T_N, I_N, F_N)}$ over Y and $\varepsilon = (\varepsilon_T, \varepsilon_I, \varepsilon_F)$ with $-3 \leq \varepsilon_T + \varepsilon_I + \varepsilon_F \leq 0$, define a neutrosophic \mathcal{N} -structure $X_{\mathbf{N}}^\varepsilon := \frac{X}{(T_N^\varepsilon, I_N^\varepsilon, F_N^\varepsilon)}$ over X by:

$$\begin{aligned} T_N^\varepsilon : X &\rightarrow [-1, 0], \quad x \mapsto \bigvee \{T_N(f(x)), \varepsilon_T\}, \\ F_N^\varepsilon : X &\rightarrow [-1, 0], \quad x \mapsto \bigwedge \{I_N(f(x)), \varepsilon_I\}, \\ I_N^\varepsilon : X &\rightarrow [-1, 0], \quad x \mapsto \bigvee \{F_N(f(x)), \varepsilon_F\}. \end{aligned}$$

Theorem 4.16. *Let $f : X \rightarrow Y$ be a homomorphism of semigroups. If a neutrosophic \mathcal{N} -structure $X_{\mathbf{N}} := \frac{Y}{(T_N, I_N, F_N)}$ over Y is an ε -neutrosophic \mathcal{N} -subsemigroup of Y , then $X_{\mathbf{N}}^\varepsilon := \frac{X}{(T_N^\varepsilon, I_N^\varepsilon, F_N^\varepsilon)}$ is an ε -neutrosophic \mathcal{N} -subsemigroup of X .*

Proof. For any $x, y \in X$, we have

$$\begin{aligned} T_N^\varepsilon(xy) &= \bigvee \{T_N(f(xy)), \varepsilon_T\} \\ &= \bigvee \{T_N(f(x)f(y)), \varepsilon_T\} \\ &\leq \bigvee \left\{ \bigvee \{T_N(f(x)), T_N(f(y)), \varepsilon_T\}, \varepsilon_T \right\} \\ &= \bigvee \left\{ \bigvee \{T_N(f(x)), \varepsilon_T\}, \bigvee \{T_N(f(y)), \varepsilon_T\}, \varepsilon_T \right\} \\ &= \bigvee \{T_N^\varepsilon(x), T_N^\varepsilon(y), \varepsilon_T\}, \\ I_N^\varepsilon(xy) &= \bigwedge \{I_N(f(xy)), \varepsilon_I\} \\ &= \bigwedge \{I_N(f(x)f(y)), \varepsilon_I\} \\ &\geq \bigwedge \left\{ \bigwedge \{I_N(f(x)), I_N(f(y)), \varepsilon_I\}, \varepsilon_I \right\} \\ &= \bigwedge \left\{ \bigwedge \{I_N(f(x)), \varepsilon_I\}, \bigwedge \{I_N(f(y)), \varepsilon_I\}, \varepsilon_I \right\} \\ &= \bigwedge \{I_N^\varepsilon(x), I_N^\varepsilon(y), \varepsilon_I\}, \end{aligned}$$

and

$$\begin{aligned}
 F_N^\varepsilon(xy) &= \bigvee \{F_N(f(xy)), \varepsilon_F\} \\
 &= \bigvee \{F_N(f(x)f(y)), \varepsilon_F\} \\
 &\leq \bigvee \left\{ \bigvee \{F_N(f(x)), F_N(f(y)), \varepsilon_F\}, \varepsilon_F \right\} \\
 &= \bigvee \left\{ \bigvee \{F_N(f(x)), \varepsilon_F\}, \bigvee \{F_N(f(y)), \varepsilon_F\}, \varepsilon_F \right\} \\
 &= \bigvee \{F_N^\varepsilon(x), F_N^\varepsilon(y), \varepsilon_F\}.
 \end{aligned}$$

Then $X_N^\varepsilon := \frac{X}{(T_N^\varepsilon, I_N^\varepsilon, F_N^\varepsilon)}$ is an ε -neutrosophic \mathcal{N} -subsemigroup of X . □

Let $f : X \rightarrow Y$ be a function of sets. If $Y_M := \frac{Y}{(T_M, I_M, F_M)}$ is a neutrosophic \mathcal{N} -structures over Y , then the preimage of Y_M under f is defined to be a neutrosophic \mathcal{N} -structures

$$f^{-1}(Y_M) = \frac{X}{(f^{-1}(T_M), f^{-1}(I_M), f^{-1}(F_M))}$$

over X , where $f^{-1}(T_M)(x) = T_M(f(x))$, $f^{-1}(I_M)(x) = I_M(f(x))$ and $f^{-1}(F_M)(x) = F_M(f(x))$ for all $x \in X$.

Theorem 4.17. *Let $f : X \rightarrow Y$ be a homomorphism of semigroups. If $Y_M := \frac{Y}{(T_M, I_M, F_M)}$ is a neutrosophic \mathcal{N} -subsemigroup of Y , then the preimage of Y_M under f is a neutrosophic \mathcal{N} -subsemigroup of X .*

Proof. Let

$$f^{-1}(Y_M) = \frac{X}{(f^{-1}(T_M), f^{-1}(I_M), f^{-1}(F_M))}$$

be the preimage of Y_M under f . For any $x, y \in X$, we have

$$\begin{aligned}
 f^{-1}(T_M)(xy) &= T_M(f(xy)) = T_M(f(x)f(y)) \\
 &\leq \bigvee \{T_M(f(x)), T_M(f(y))\} \\
 &= \bigvee \{f^{-1}(T_M)(x), f^{-1}(T_M)(y)\},
 \end{aligned}$$

$$\begin{aligned}
 f^{-1}(I_M)(xy) &= I_M(f(xy)) = I_M(f(x)f(y)) \\
 &\geq \bigwedge \{I_M(f(x)), I_M(f(y))\} \\
 &= \bigwedge \{f^{-1}(I_M)(x), f^{-1}(I_M)(y)\}
 \end{aligned}$$

and

$$\begin{aligned}
 f^{-1}(F_M)(xy) &= F_M(f(xy)) = F_M(f(x)f(y)) \\
 &\leq \bigvee \{F_M(f(x)), F_M(f(y))\} \\
 &= \bigvee \{f^{-1}(F_M)(x), f^{-1}(F_M)(y)\}.
 \end{aligned}$$

Then $f^{-1}(Y_M)$ is a neutrosophic \mathcal{N} -subsemigroup of X . □

Let $f : X \rightarrow Y$ be an onto function of sets. If $X_{\mathbf{N}} := \frac{X}{(T_N, I_N, F_N)}$ is a neutrosophic \mathcal{N} -structures over X , then the image of $X_{\mathbf{N}}$ under f is defined to be a neutrosophic \mathcal{N} -structures

$$f(X_{\mathbf{N}}) = \frac{Y}{(f(T_N), f(I_N), f(F_N))}$$

over Y , where

$$f(T_N)(y) = \bigwedge_{x \in f^{-1}(y)} T_N(x),$$

$$f(I_N)(y) = \bigvee_{x \in f^{-1}(y)} I_N(x),$$

$$f(F_N)(y) = \bigwedge_{x \in f^{-1}(y)} F_N(x).$$

Theorem 4.18. For an onto homomorphism $f : X \rightarrow Y$ of semigroups, let $X_{\mathbf{N}} := \frac{X}{(T_N, I_N, F_N)}$ be a neutrosophic \mathcal{N} -structure over X such that

$$(4.4) \quad (\forall T \subseteq X) (\exists x_0 \in T) \left(\begin{array}{l} T_N(x_0) = \bigwedge_{z \in T} T_N(z) \\ I_N(x_0) = \bigvee_{z \in T} I_N(z) \\ F_N(x_0) = \bigwedge_{z \in T} F_N(z) \end{array} \right).$$

If $X_{\mathbf{N}}$ is a neutrosophic \mathcal{N} -subsemigroup of X , then the image of $X_{\mathbf{N}}$ under f is a neutrosophic \mathcal{N} -subsemigroup of Y .

Proof. Let

$$f(X_{\mathbf{N}}) = \frac{Y}{(f(T_N), f(I_N), f(F_N))}$$

be the image of $X_{\mathbf{N}}$ under f . Let $a, b \in Y$. Then $f^{-1}(a) \neq \emptyset$ and $f^{-1}(b) \neq \emptyset$ in X , which imply from (??) that there are $x_a \in f^{-1}(a)$ and $x_b \in f^{-1}(b)$ such that

$$T_N(x_a) = \bigwedge_{z \in f^{-1}(a)} T_N(z), \quad I_N(x_a) = \bigvee_{z \in f^{-1}(a)} I_N(z), \quad F_N(x_a) = \bigwedge_{z \in f^{-1}(a)} F_N(z),$$

$$T_N(x_b) = \bigwedge_{w \in f^{-1}(b)} T_N(w), \quad I_N(x_b) = \bigvee_{w \in f^{-1}(b)} I_N(w), \quad F_N(x_b) = \bigwedge_{w \in f^{-1}(b)} F_N(w).$$

Thus

$$\begin{aligned} f(T_N)(ab) &= \bigwedge_{x \in f^{-1}(ab)} T_N(x) \leq T_N(x_a x_b) \\ &\leq \bigvee \{T_N(x_a), T_N(x_b)\} \\ &= \bigvee \left\{ \bigwedge_{z \in f^{-1}(a)} T_N(z), \bigwedge_{w \in f^{-1}(b)} T_N(w) \right\} \\ &= \bigvee \{f(T_N)(a), f(T_N)(b)\}, \end{aligned}$$

$$\begin{aligned}
 f(I_N)(ab) &= \bigvee_{x \in f^{-1}(ab)} I_N(x) \geq I_N(x_a x_b) \\
 &\geq \bigwedge \{I_N(x_a), I_N(x_b)\} \\
 &= \bigwedge \left\{ \bigvee_{z \in f^{-1}(a)} I_N(z), \bigvee_{w \in f^{-1}(b)} I_N(w) \right\} \\
 &= \bigwedge \{f(I_N)(a), f(I_N)(b)\},
 \end{aligned}$$

and

$$\begin{aligned}
 f(F_N)(ab) &= \bigwedge_{x \in f^{-1}(ab)} F_N(x) \leq F_N(x_a x_b) \\
 &\leq \bigvee \{F_N(x_a), F_N(x_b)\} \\
 &= \bigvee \left\{ \bigwedge_{z \in f^{-1}(a)} F_N(z), \bigwedge_{w \in f^{-1}(b)} F_N(w) \right\} \\
 &= \bigvee \{f(F_N)(a), f(F_N)(b)\}.
 \end{aligned}$$

So $f(X_N)$ is a neutrosophic \mathcal{N} -subsemigroup of Y . □

CONCLUSIONS

In order to deal with the negative meaning of information, Jun et al. [?] have introduced a new function which is called negative-valued function, and constructed \mathcal{N} -structures. The concept of neutrosophic set (NS) has been developed by Smarandache in [?] and [?] as a more general platform which extends the concepts of the classic set and fuzzy set, intuitionistic fuzzy set and interval valued intuitionistic fuzzy set. In this article, we have introduced the notion of neutrosophic \mathcal{N} -structure and applied it to semigroup. We have introduced the notion of neutrosophic \mathcal{N} -subsemigroup and investigated several properties. We have provided conditions for neutrosophic \mathcal{N} -structure to be neutrosophic \mathcal{N} -subsemigroup. We have defined neutrosophic \mathcal{N} -product, and gave characterization of neutrosophic \mathcal{N} -subsemigroup by using neutrosophic \mathcal{N} -product. We also have introduced ε -neutrosophic subsemigroup, and investigated relations between neutrosophic subsemigroup and ε -neutrosophic subsemigroup. We have shown that the homomorphic preimage of neutrosophic \mathcal{N} -subsemigroup is a neutrosophic \mathcal{N} -subsemigroup, and the onto homomorphic image of neutrosophic \mathcal{N} -subsemigroup is a neutrosophic \mathcal{N} -subsemigroup.

REFERENCES

- [1] S. Abdullah and A. F. Ali, Applications of N-structures in implicative filters of BE-algebras, *J. Intell. Fuzzy Systems* 29 (2) (2015) 517–524.
- [2] K. Atanassov, Intuitionistic fuzzy sets, *Fuzzy Sets and Systems* 20 (1986) 87–96.
- [3] Y. B. Jun, K. J. Lee and S. Z. Song, \mathcal{N} -ideals of BCK/BCI-algebras, *J. Chungcheong Math. Soc.* 22 (2009) 417–437.
- [4] Y. B. Jun, M. A. Öztürk and E. H. Roh, \mathcal{N} -structures applied to closed ideals in BCH-algebras, *Int. J. Math. Math. Sci.* Volume 2010, Article ID 943565, 9 pages.
- [5] K. J. Lee and Y. B. Jun, The essence of subtraction algebras based on \mathcal{N} -structures, *Commun. Korean Math. Soc.* 27 (1) (2012) 15–22.
- [6] J. N. Mordeson, D. S. Malik and N. Kuroki, *Fuzzy semigroups*, Springer-Verlag Berlin Heidelberg, New York 2003.
- [7] F. Smarandache, *A Unifying Field in Logics: Neutrosophic Logic. Neutrosophy, Neutrosophic Set, Neutrosophic Probability*, (American Reserch Press, Rehoboth, NM, 1999).
- [8] F. Smarandache, Neutrosophic set-a generalization of the intuitionistic fuzzy set, *Int. J. Pure Appl. Math.* 24 (3) (2005) 287–297.
- [9] L. A. Zadeh, Fuzzy sets, *Information and Control* 8 (1965) 338–353.

On Neutrosophic Extended Triplet LA-hypergroups and Strong Pure LA-semihypergroups

Minghao Hu, Florentin Smarandache, Xiaohong Zhang

Minghao Hu, Florentin Smarandache, Xiaohong Zhang (2020). On Neutrosophic Extended Triplet LA-hypergroups and Strong Pure LA-semihypergroups. *Symmetry* 12, 163; DOI: 10.3390/sym12010163

Abstract: We introduce the notions of neutrosophic extended triplet LA-semihypergroup, neutrosophic extended triplet LA-hypergroup, which can reflect some symmetry of hyperoperation and discuss the relationships among them and regular LA-semihypergroups, LA-hypergroups, regular LA-hypergroups. In particular, we introduce the notion of strong pure neutrosophic extended triplet LA-semihypergroup, get some special properties of it and prove the construction theorem about it under the condition of asymmetry. The examples in this paper are all from Python programs.

Keywords: LA-semihypergroup; LA-hypergroup; neutrosophic extended triplet LA-semihypergroup; neutrosophic extended triplet LA-hypergroup

1. Introduction and Preliminaries

Left almost semigroup (abbreviated as LA-semigroup, some researchers also call it Abel Grassmann's groupoid), a non-associative and noncommutative algebraic structure, was first proposed by Kazim and Naseeruddin in Reference [1]. Hyperstructure theory was first introduced by Marty in Reference [2]. In the following decades and nowadays, various hyperstructures are widely studied and applied [3–6]. In Reference [7], Hila and Dine extended the concept of LA-semigroup to LA-semihypergroup and investigated several properties of LA-semihypergroups. Since then, many researchers have been done a lot of studies in this field [8–13].

In recent years, as an application of idea of neutrosophic set, the new notion of neutrosophic triplet group (NTG) was firstly introduced by F. Smarandache and M. Ali in Reference [14]. Soon after, M. Gulistan, S. Nawaz and N. Hassan applied the idea of NTG to LA-semihypergroup, proposed the concept of NTG-LA-semihypergroup and got some interesting results in Reference [15]. Meanwhile, F. Smarandache extended the concept of NTG to neutrosophic triplet extended group (NETG) in Reference [16]. Later, some research articles in this field are published. F. Smarandache, X.H. Zhang, X.G. An and M.M. Hu investigated properties and structures of NETG in Reference [17]; T.G. Jaíyóolá and F. Smarandache obtained some conclusions on neutrosophic triplet groups and discussed their applications in Reference [18]; The new concept of NET-Abel-Gassmann's Groupoid was introduced and the relationships of NETGs and regular semigroups were studied in Reference [19]; X.H. Zhang and X.Y. Wu prove that the construction theorem of NETG in Reference [20]; The concept of generalized neutrosophic extended group were proposed by Y.C. Ma and the relationships of NETGs and generalized groups were studied in References [21,22]. In particular, the notions of NET-semihypergroup and NET-hypergroup were introduced by X.H. Zhang, F. Smarandache and Y.C. Ma and the decomposition theorem of PWC-NET-semihypergroup was proved in Reference [23]. For the study of some related algebraic systems, please refer to Reference [24–26].

In this study, we apply the concept of NETG to LA-semihypergroup and introduce the new notions of NET-LA-semihypergroup, NET-LA-hypergroup, SPNET-LA-semihypergroup; Further, we discuss their properties, relations and so forth.

First of all, recall some conclusions and definitions on LA-semihypergroups.

Definition 1. [7] We say that a mapping

$$\circ : H \times H \rightarrow P^*(H)$$

is a binary hyperoperation, if H is a nonempty set, $P(H)$ is power set of H and $P^*(H) = P(H)/\phi$.

Definition 2. [7] (H, \circ) is a binary hypergroupoid, if H is a nonempty set and \circ is a binary hyperoperation. In addition, we write

$$X \circ Y = \bigcup_{a \in X, b \in Y} (a \circ b), X \circ a = X \circ \{a\}, a \circ Y = \{a\} \circ Y,$$

where $a \in H, X \subseteq H, Y \subseteq H$ and $X \neq \phi, Y \neq \phi$.

Definition 3. [7] A binary hypergroupoid (H, \circ) is an LA-semihypergroup, if

$$(a \circ b) \circ c = (c \circ b) \circ a \tag{1}$$

for all $a, b, c \in H$, that is

$$\bigcup_{s \in (a \circ b)} (s \circ c) = \bigcup_{t \in (c \circ b)} (t \circ a). \tag{2}$$

By Equation (1), we know that every LA-semihypergroup (H, \circ) satisfies

$$(a \circ b) \circ (c \circ d) = (a \circ c) \circ (b \circ d) \tag{3}$$

for all $a, b, c, d \in H$.

Note that, the Equations (1) and (3) are all set equations. If we replace all the elements in the equations (1) and (3) with nonempty subsets of H , these equations still hold.

Definition 4. [7] (T, \circ) is a sub LA-semihypergroup of (H, \circ) , if the following conditions hold:

- (a) $T \subseteq H, T \neq \phi$;
- (b) $m \circ n \subseteq T$ for all $m, n \in T$;
- (c) (H, \circ) is an LA-semihypergroup.

Definition 5. [8] Suppose (H, \circ) is an LA-semihypergroup. An element $a \in H$ is regular if there is an element $t \in H$ such that

$$a \in a \circ t \circ a.$$

Furthermore, (H, \circ) is a regular LA-semihypergroup if each element of H is regular.

Definition 6. [7] Suppose (H, \circ) is an LA-semihypergroup. (H, \circ) is an LA-hypergroup if it satisfies

$$t \circ H = H \circ t = H$$

for all $t \in H$.

Definition 7. [8] Suppose (H, \circ) is an LA-semihypergroup. An element $e \in H$ is

- (a) a left identity, if $a \in e \circ a$ for each $a \in H$;
- (b) a right identity, if $a \in a \circ e$ for each $a \in H$;

- (c) an identity, if $a \in (e \circ a) \cap (a \circ e)$ for each $a \in H$;
- (d) a pure left identity, if $a = e \circ a$ for each $a \in H$;
- (e) a pure right identity, if $a = a \circ e$ for each $a \in H$;
- (f) a pure identity, if $a = (e \circ a) \cap (a \circ e)$ for each $a \in H$;
- (g) a scalar identity, if $a = e \circ a = a \circ e$ for each $a \in H$.

In addition, we say that $x \in H$ is an inverse of $a \in H$ if x satisfies

$$e \in (a \circ x) \cap (x \circ a),$$

where e is an identity of (H, \circ) .

Definition 8. (H, \circ) is a regular LA-hypergroup, if it satisfies the following conditions:

- (a) (H, \circ) is an LA-hypergroup;
- (b) There exists $e \in H$ such that e is identity of (H, \circ) ;
- (c) Every element $a \in H$ has at least one inverse.

Definition 9. [16] A nonempty set M is said to be a neutrosophic extended triplet set if to any given $a \in M$, there are $s \in M$ and $t \in M$, in such a way that

$$a \circ s = s \circ a = a \tag{4}$$

$$a \circ t = t \circ a = s, \tag{5}$$

where \circ is a binary operation on M , s is an extend neutral of 'a', t is an opposite of 'a' about s , (a, s, t) is a neutrosophic extend triplet.

Definition 10. [14,16] A semihypergroup (H, \circ) is said to be an NET-semihypergroup if to any given $a \in H$, there are $s \in H$ and $t \in H$, in such a way that

$$a \in (s \circ a) \cap (a \circ s), \tag{6}$$

$$s \in (t \circ a) \cap (a \circ t). \tag{7}$$

In addition, for a certain $a \in H$, we say that (a, s, t) is a hyper-neutrosophic-triplet and use $\{ \}_{neut(a)}$ for the set of all s that satisfy Formula (6) and (7). For a certain $s \in \{ \}_{neut(a)}$, we use $\{ \}_{anti(a)_s}$ for the set of all t that satisfy Formula (7).

2. Neutrosophic Extended Triplet LA-Semihypergroups and Neutrosophic Extended Triplet LA-Hypergroups

Definition 11. An LA-semihypergroup $(L, *)$ is said to be

- (a) a left neutrosophic extended triplet LA-semihypergroup (LNET-LA-semihypergroup) if to any given $a \in L$, there are $p \in L$ and $q \in L$, in such a way that

$$a \in p * a \tag{8}$$

$$p \in q * a. \tag{9}$$

Furthermore, for a certain $a \in L$, p, q and (a, p, q) are called left neutral of a , left opposite of a and left hyper-neutrosophic-triplet respectively. $\{ \}_{lneut(a)}$ is used to represent the set of all p that satisfy Formula (8), (9) and for a certain $p \in \{ \}_{lneut(a)}$, $\{ \}_{lantia_p}$ is used to represent the set of all q that satisfy Formula (9).

- (b) a right neutrosophic extended triplet LA-semihypergroup (RNET-LA-semihypergroup), if to any given $a \in L$, there are $s \in L$ and $t \in L$, in such a way that

$$a \in a * s \tag{10}$$

$$s \in a * t. \tag{11}$$

Furthermore, for a certain $a \in H$, (a, s, t) is called *right-hyper-neutrosophic-triplet*. $\{\}_{neut(a)}$ is used to represent the set of all s that satisfy Formula (10), (11) and for a certain $s \in \{\}_{neut(a)}$, $\{\}_{anti(a)_s}$ is used to represent the set of all t that satisfy Formula (11).

(c) a *neutrosophic extended triplet LA-semihypergroup (NET-LA-semihypergroup)*, if to any given $a \in L$, there are $m \in L$ and $n \in L$, in such a way that

$$a \in (m * a) \cap (a * m) \tag{12}$$

$$m \in (n * a) \cap (a * n). \tag{13}$$

Furthermore, for a certain $a \in L$, (a, m, n) is called a *hyper-neutrosophic-triplet*, $\{\}_{neut(a)}$ is used to represent the set of all m that satisfy Formula (12), (13) and for a certain $m \in \{\}_{neut(a)}$, $\{\}_{anti(a)_m}$ is used to represent the set of all n that satisfy Formula (13).

Example 1. Put $L = \{0, 1, 2\}$, the binary hypergroupoid $(L, *)$ is as follows (see Table 1).

Table 1. The binary hypergroupoid $(L, *)$.

*	0	1	2
0	0	0	0
1	0	1	0
2	0	0	{0, 2}

By Python program 1, $(L, *)$ is an LA-semihypergroup (please see Figure 1).

Python program 1 Verification of LA-semihypergroup 1

```

1: T = [ [[0],[0],[0]], [[0], [1], [0]], [[0], [0], [0,2]] ]
2: count = 0
3: for x in range(3):
4: for y in range(3):
5: for z in range(3):
6: T1 = T[x][y]
7: T2 = set()
8: k1 = len(T1)S3 = set(T[neut_t][t])
9: for m in range(k1)
10: T2 = set((T[T1[m]][z]).union(T2)
11: T3 = T[z][y]
12: T4 = set()
13: k2 = len(T3)
14: for n in range(k2):
15: T4 = set((T[T3[n]][x]).union(T4)
16: if T2 == T4:Ifif
17: count += 1
18: while count == 3**3:
19: print('{} is an LA-semihypergroup'.format(T))
20: break

```

Run: program 1

C:\Users\Think\Anaconda3\python.exe C:/Users/Think/PycharmProjects/1/program1.py
 [[[0],[0],[0]], [[0], [1], [0]], [[0], [0], [0,2]]] is an LA-semihypergroup.
 Process finished with exit code 0

Figure 1. The result of Python program 1.

Furthermore, we get

$$0 \in (0 * 0) \cap (0 * 0), 0 \in (0 * 0) \cap (0 * 0)$$

$$0 \in (0 * 0) \cap (0 * 0), 0 \in (1 * 0) \cap (0 * 1)$$

$$0 \in (0 * 0) \cap (0 * 0), 0 \in (2 * 0) \cap (0 * 2)$$

$$1 \in (1 * 1) \cap (1 * 1), 1 \in (1 * 1) \cap (1 * 1)$$

$$2 \in (2 * 2) \cap (2 * 2), 2 \in (2 * 2) \cap (2 * 2).$$

*By Definition 11, $(0, 0, 0), (0, 0, 1), (0, 0, 2), (1, 1, 1), (2, 2, 2)$ are all hyper neutrosophic-triplets and $(L, *)$ is an NET-LA-semihypergroup. These results can also be verified by Python program 2 (please see Figure 2).*

Python program 2 Verification of NET-LA-semihypergroup 1

```

1: T = [ [[0],[0],[0]], [[0], [1], [0]], [[0], [0], [0,2]] ]
2: test = []
3: for t in range(3):
4: for neut_t in range(3):
5: for anti_t in range(3):
6: S1 = set(T[t][neut_t])
7: S2 = set(T[t][anti_t])
8: S3 = set(T[neut_t][t])
9: S4 = set(T[anti_t][t])
10: S5 = set(list([t]))
11: S6 = set(list([neut_t]))
12: if S5.issubset(S1 & S3) and S6.issubset(S2 & S4):
13: test.append([t, neut_t, anti_t])
14: test2 = test
15: test1 = set([test2[i][0] for i in range(len(test2))])
16: if test1 == set([x for x in range(3)]):
17: print('{0} is an Net-LA-semihypergroup and hyper neutrosophic-triplet are {1}'.format(T, test2))
    
```

Run: programm 2

C:\Users\Think\Anaconda3\python.exe C:/Users/Think/PycharmProjects/1/program2.py
 [[[0],[0],[0]], [[0], [1], [0]], [[0], [0], [0,2]]] is an Net-LA-semihypergroup and hyper neutrosophic-triplet are [[0,0,0], [0,0,1], [0,0,2], [1,1,1], [2,2,2]]
 Process finished with exit code 0

Figure 2. The result of Python program 2.

Example 2. Suppose R is the set of real numbers, the binary hypergroupoid $(R, *)$ is as follows.

$$x * y = \begin{cases} (x, y) & x < y, \\ (y, x) & y < x, \\ x & x = y. \end{cases}$$

for all $x, y \in R$, where (x, y) is the open interval.

When $z < x < y$,

$$(x * y) * z = \bigcup_{s \in (x*y)} (s * z) \cup \bigcup_{s \in (x,y)} (z, s) = (z, y)$$

$$\begin{aligned} (z * y) * x &= \bigcup_{t \in (z*y)} (t * x) = \bigcup_{t \in (z,y)} (t * x) = [\bigcup_{t \in (z,x)} (t * x)] \cup [\bigcup_{t=x} (t * x)] \cup [\bigcup_{t \in (x,y)} (t * x)] \\ &= [\bigcup_{t \in (z,x)} (t, x)] \cup (\{x\}) \cup [\bigcup_{t \in (x,y)} (x, t)] = (z, x) \cup (\{x\}) \cup (x, y) = (z, y) = (x * y) * z. \end{aligned}$$

In the same way, we have

$$(x * y) * z = (z * y) * x,$$

for all $x, y, z \in R$. Hence $(R, *)$ is an LA-semihypergroup. On the other hand, Since

$$x \in (x * x) \cap (x * x), x \in (x * x) \cap (x * x),$$

for any given $x \in R, x \in \{\}_{neut(x)}, x \in \{\}_{anti(x)}$. By Definition 11, $(R, *)$ is an NET-LA-semihypergroup.

Example 3. Put $L = \{0, 1, 2\}$, the binary hypergroupoid $(L, *)$ is as follows (see Table 2).

Table 2. The binary hypergroupoid $(L, *)$.

*	0	1	2
0	0	0	0
1	0	0	0
2	0	0	{0, 1}

By Python program, $(L, *)$ is an LA-semihypergroup. In addition, we get

$$1 \notin (0 * 1) \cap (1 * 0), 1 \notin (1 * 1) \cap (1 * 1), 1 \notin (2 * 1) \cap (1 * 2).$$

This shows that $\{\}_{neut(1)} = \phi$. By Definition 11, $(L, *)$ is not an NET-LA-semihypergroup.

Remark 1. Every NET-LA-semihypergroup is an LA-semihypergroup but not vice versa.

Example 4. Put $L = \{0, 1, 2, 3\}$, the binary hypergroupoid $(L, *)$ is as follows (see Table 3).

Table 3. The binary hypergroupoid $(L, *)$.

*	0	1	2	3
0	0	0	0	{0,1,2,3}
1	0	0	0	{0,1,2,3}
2	0	0	{0,1}	{2,3}
3	{1,2,3}	{0,1,2,3}	{2,3}	{0,3}

By Python program 3 and Python program 4, $(L, *)$ is both an LA-semihypergroup (please see Figure 3) and an NET-LA-semihypergroup (please see Figure 4). In addition,

$$(0, 0, 0), (0, 0, 1), (0, 0, 2), (0, 1, 3), (0, 2, 3), (1, 3, 3), (2, 3, 3)$$

$(3, 0, 1), (3, 0, 3), (3, 1, 0), (3, 1, 1), (3, 2, 0), (3, 2, 1), (3, 2, 2), (3, 3, 0), (3, 3, 1), (3, 3, 2), (3, 3, 3)$ are all hyper neutrosophic-triplets (please see Figure 4). Let $M = \{0, 1, 2\} \subseteq L$, then $(M, *)$ is a sub LA-semihypergroup of $(L, *)$. From Example 3, $(M, *)$ is not an NET-LA-semihypergroup.

Python program 3 Verification of LA-semihypergroup 2

```

1: T = [ [[0],[0],[0],[0,1,2,3]], [[0], [0], [0],[0,1,2,3]], [[0], [0], [0,1],[2,3]], [[1,2,3],[0,1,2,3],[2,3],[0,3]] ]
2: count = 0
3: for x in range(4):
4: for y in range(4):
5: for z in range(4):
6: T1 = T[x][y]
7: T2 = set()
8: k1 = len(T1)S3 = set(T[neut_t][t])
9: for m in range(k1)
10: T2 = set(T[T1[m]][z]).union(T2)
11: T3 = T[z][y]
12: T4 = set()
13: k2 = len(T3)
14: for n in range(k2):
15: T4 = set(T[T3[n]][x]).union(T4)
16: if T2 == T4:ifif
17: count += 1
18: while count == 4**3:
19: print('( T,* ) is an LA-semihypergroup.´)
20: break

```

Run: program 3

```

C:\Users\Think\Anaconda3\python.exe C:/Users/Think/PycharmProjects/1/program3.py
(T, *) is an LA-semihypergroup.
Process finished with exit code 0

```

Figure 3. The result of Python program 3.

Python program 4 Verification of NET-LA-semihypergroup 2

```

1: T = [ [[0],[0],[0],[0,1,2,3]], [[0], [0], [0],[0,1,2,3]], [[0], [0], [0,1],[2,3]], [[1,2,3],[0,1,2,3],[2,3],[0,3]] ]
2: test = [[]]
3: for t in range(4):
4: for neut_t in range(4):
5: for anti_t in range(4):
6: S1 = set(T[t][neut_t])
7: S2 = set(T[t][anti_t])
8: S3 = set(T[neut_t][t])
9: S4 = set(T[anti_t][t])
10: S5 = set(list([t]))
11: S6 = set(list([neut_t]))
12: if S5.issubset(S1 & S3) and S6.issubset(S2 & S4):
13: test.append([t, neut_t, anti_t])
14: test2 = test
15: test1 = set([test2[i][0] for i in range(len(test2))])
16: if test1 == set([x for x in range(3)]):
17: print('(T,*) is an NET-LA-semihypergroup and hyper neutrosophic-triplet are {}'.format(test2).

```

```

Run: program 4
C:\Users\Think\Anaconda 3\python.exe C:/Users/Think/PycharmProjects/1/proram4.py
(T,*) is an NET-LA-semihypergroup and hyper neutrosopic-triplet are [[0,0,0], [0,0,1], [0,0,2],
[0,2,3], [1,3,3], [2,3,3], [3,0,1], [3,0,3], [3,1,0], [3,1,1], [3,2,0], [3,2,1], [3,2,2], [3,3,0], [3,3,1],
[3,3,2], [3,3,3]]
Process finished with exit code 0
    
```

Figure 4. The result of Python program 4.

Remark 2. From Example 4, we know that for a certain t in an NET-LA-semihypergroup, $|\{\}_{neut(x)}|$ may be greater than or equal to one and for a certain $p \in \{\}_{neut(x)}$, $|\{\}_{anti(x)_p}|$ may be greater than or equal to one. According to the results of Example 4, we have

$$\begin{aligned}
\{\}_{neut(0)} &= \{0, 1, 2\}, \{\}_{anti(0)_0} = \{0, 1, 2\}, \{\}_{anti(0)_1} = \{3\}, \{\}_{anti(0)_2} = \{3\} \\
\{\}_{neut(1)} &= \{3\}, \{\}_{anti(1)_3} = \{3\}; \{\}_{neut(2)} = \{3\}, \{\}_{anti(2)_3} = \{3\} \\
\{\}_{neut(3)} &= \{0, 1, 2, 3\}, \{\}_{anti(3)_0} = \{3\}, \{\}_{anti(3)_1} = \{0, 1\}, \{\}_{anti(3)_2} = \{0, 1, 2\}; \{\}_{anti(3)_3} = \{0, 1, 2, 3\}
\end{aligned}$$

Definition 12. $(L, *)$ is said to be an NET-LA-hypergroup if it is both an LA-hypergroup (see Definition 6) and an NET-LA-semihypergroup.

Proposition 1. Every LA-hypergroup is a regular LA-semihypergroup.

Proof. Since $(L, *)$ is an LA-hypergroup, to every $t \in L$, $t * L = L * t = L$. Thus

$$t \in L = L * t = t * L * t$$

By Definition 5, $(L, *)$ is a regular LA-semihypergroup. \square

Example 5. Put $L = \{0, 1, 2\}$, the binary hypergroupoid $(L, *)$ is as follows (see Table 4).

Table 4. The binary hypergroupoid $(L, *)$.

*	0	1	2
0	0	0	0
1	0	1	{0, 1}
2	0	{0, 1}	{2}

By Python program, $(L, *)$ is an LA-semihypergroup. Furthermore, we have

$$0 \in 0 * 0 * 0, 1 \in 1 * 2 * 1, 2 \in 2 * 2 * 2$$

By Definition 5, $(L, *)$ is a regular LA-semihypergroup. But

$$0 * L = 0 \neq L$$

By Definition 6, $(L, *)$ is not an LA-hypergroup.

Remark 3. From Example 5, a regular LA-semihypergroup is not necessarily an LA-hypergroup.

Proposition 2. Every NET-LA-semihypergroup is a regular LA-semihypergroup.

Proof. Suppose $(L, *)$ is an NET-LA-semihypergroup, then to any given $a \in L$, there are $p \in \{ \}_{neut(a)} \subseteq L$ and $q \in \{ \}_{anti(a)_p} \subseteq L$ such that

$$a \in (p * a) \cap (a * p)$$

$$p \in (q * a) \cap (a * q)$$

Hence

$$a \in (p * a) \text{ and } p \in (a * q)$$

that is

$$a \in p * a \in (a * q) * a$$

By Definition 5, $(L, *)$ is a regular LA-semihypergroup. \square

Example 6. Put $L = \{0, 1, 2\}$, the binary hypergroupoid $(L, *)$ is as follows (see Table 5).

Table 5. The binary hypergroupoid $(L, *)$.

$*$	0	1	2
0	0	0	0
1	0	2	2
2	0	{0,1,2}	{0,1,2}

By Python program, $(L, *)$ is an LA-semihypergroup. Furthermore, we have

$$0 \in 0 * 0 * 0, 1 \in 1 * 2 * 1, 2 \in 2 * 1 * 2$$

By Definition 5, $(L, *)$ is a regular LA-semihypergroup. But

$$1 \notin (0 * 1) \cap (1 * 0), 1 \notin (1 * 1) \cap (1 * 1), 1 \notin (2 * 1) \cap (1 * 2)$$

This shows that $\{ \}_{neut(1)} = \phi$. By Definition 11, $(L, *)$ is not an NET-LA-semihypergroup.

Remark 4. From Example 6, a regular LA-semihypergroup is not necessarily an NET-LA-semihypergroup.

Example 7. Put $L = \{0, 1, 2\}$, the binary hypergroupoid $(L, *)$ is as follows (see Table 6).

Table 6. The binary hypergroupoid $(L, *)$.

$*$	0	1	2
0	0	0	0
1	0	1	0
2	0	0	{0, 2}

By Python program, $(L, *)$ is an LA-semihypergroup. Furthermore, we get

$$(0, 0, 0), (0, 0, 1), (0, 0, 2), (1, 1, 1), (2, 2, 2)$$

are all hyper neuromorphic-triplets. By Definition 11, $(L, *)$ is an NET-LA-semihypergroup. But

$$0 * L = 0 \neq L$$

By Definition 6, $(L, *)$ is not an LA-hypergroup.

Example 8. Put $L = \{0, 1, 2\}$, the binary hypergroupoid $(L, *)$ is as follows (see Table 7).

Table 7. The binary hypergroupoid $(L, *)$.

*	0	1	2
0	0	{0,1,2}	{0,1,2}
1	0	{0,2}	{1,2}
2	{0,1,2}	{0,2}	{0,1,2}

By Python program, $(L, *)$ is an LA-semi hypergroup. Furthermore, we get

$$0 * L = L * 0 = L, 1 * L = L * 1 = L, 2 * L = L * 2 = L$$

By Definition 6, $(L, *)$ is an LA-hypergroup. But

$$1 \notin (0 * 1) \cap (1 * 0), 1 \notin (1 * 1) \cap (1 * 1), 1 \notin (2 * 1) \cap (1 * 2)$$

This shows that $\{ \}_{neut(1)} = \phi$. By Definition 11, $(L, *)$ is not an NET-LA-semihypergroup.

Proposition 3. Every regular LA-hypergroup is an NET-LA-hypergroup.

Example 9. Put $L = \{0, 1, 2\}$, the binary hypergroupoid $(L, *)$ is as follows (see Table 8).

Table 8. The binary hypergroupoid $(L, *)$.

*	0	1	2
0	{1,2}	{0,1,2}	{0,1,2}
1	{0,1,2}	{0,2}	{0,2}
2	{0,1}	{1,2}	{0,1}

By Python program, $(L, *)$ is an LA-semihypergroup. Furthermore, we get

$$(0, 1, 0), (0, 1, 1), (0, 1, 2), (0, 2, 0), (0, 2, 1), (1, 0, 0), (1, 0, 1), (2,1,0), (2, 1, 2)$$

are all hyper neutrosophic-triplets, and

$$0 * L = L * 0 = L, 1 * L = L * 1 = L, 2 * L = L * 2 = L$$

by Definition 12, $(L, *)$ is an NET-LA-hypergroup. But

$$0 \notin (0 * 0) \cap (0 * 0), 1 \notin (1 * 1) \cap (1 * 1), 2 \notin (2 * 2) \cap (2 * 2)$$

This shows that the identity of $(L, *)$ does not exist. By Definition 8, $(L, *)$ is not a regular LA-hypergroup.

Based on the above, the relationships of LA-semihypergroup, regular LA-semihypergroup, LA-hypergroup, NET-LA-semihypergroup, NET-LA-hypergroup and regular LA-hypergroup, can be represented by the flowing Figure 5.

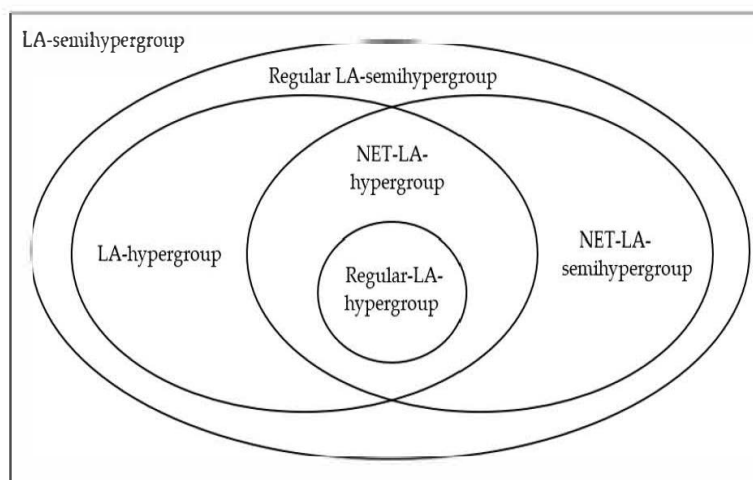

Figure 5. The relationships of various LA-semihypergroups.

Proposition 4. An NET-LA-semihypergroup $(L, *)$ is both an LNET-LA-semihypergroup and a RNET-LA-semihypergroup.

Proof. Since $(L, *)$ is an NET-LA-semihypergroup, to any given $a \in L$, there are $s \in \{neut(a)\}$ and $t \in \{anti(a)_s\}$ such that

$$a \in (s * a) \cap (a * s) \text{ and } s \in (t * a) \cap (a * t).$$

Hence $a \in (s * a)$ and $s \in (t * a)$, This shows

$$s \in \{neut(a)\} \in \{anti(a)_s\}.$$

Thus $(L, *)$ is an LNET-LA-semihypergroup. In the same way, we can prove that $(L, *)$ is also a RNET-LA-semihypergroup. \square

Example 10. Put $L = \{0, 1, 2\}$, the binary hypergroupoid $(L, *)$ is as follows (see Table 9).

Table 9. The binary hypergroupoid $(L, *)$.

*	0	1	2
0	0	0	0
1	0	2	2
2	0	{1,2}	{1,2}

By Python program, $(L, *)$ is an LA-semihypergroup and

$$(0, 0, 0), (0, 0, 1), (0, 0, 2), (1, 2, 1), (1, 2, 2), (2, 1, 2), (2, 2, 1), (2, 2, 2)$$

are all left-hyper neutrosophic-triplets;

$$(0, 0, 0), (0, 0, 1), (0, 0, 2), (2, 1, 1), (2, 1, 2), (2, 2, 1), (2, 2, 2)$$

are all right-hyper neutrosophic-triplets;

$$(0, 0, 0), (0, 0, 1), (0, 0, 2), (2, 1, 2), (2, 2, 1), (2, 2, 2)$$

are all hyper neutrosophic-triplets. By Definition 11, $(L, *)$ is an LNET-LA-semihypergroup but it is neither a RNET-LA-semihypergroup nor an NET-LA-semihypergroup.

Example 11. Put $L = \{0, 1, 2\}$, the binary hypergroupoid $(L, *)$ is as follows (see Table 10).

Table 10. The binary hypergroupoid $(L, *)$.

*	0	1	2
0	0	{0, 1, 2}	{0, 1, 2}
1	2	2	{1, 2}
2	{0, 1, 2}	{0, 2}	{0, 1, 2}

By Python program, $(L, *)$ is an LA-semihypergroup and

$$(0, 0, 0), (0, 0, 2), (0, 2, 1), (0, 2, 2), (1, 0, 0), (1, 0, 2), (2, 0, 0)$$

$$(2, 0, 2), (2, 1, 0), (2, 1, 1), (2, 1, 2), (2, 2, 0), (2, 2, 1), (2, 2, 2)$$

are all left-hyper neutrosophic-triplets;

$$(0, 0, 0), (0, 0, 1), (0, 0, 2), (0, 1, 1), (0, 1, 2), (0, 2, 1), (0, 2, 2), (1, 2, 0), (1, 2, 1)$$

$$(1, 2, 2), (2, 0, 0), (2, 0, 1), (2, 0, 2), (2, 1, 0), (2, 1, 2), (2, 2, 0), (2, 2, 1), (2, 2, 2)$$

are all right-hyper neutrosophic-triplets; But

$$1 \notin (0 * 1) \cap (1 * 0), 1 \notin (1 * 1) \cap (1 * 1), 1 \notin (2 * 1) \cap (1 * 2)$$

This shows that $\{l_{neut}(1)\} = \phi$. By Definition 11, $(L, *)$ is both an LNET-LA-semihypergroup and a RNET-LA-semihypergroup but not an NET-LA-semihypergroup. Moreover, from Example 11, we know that

$$\{l_{neut}(0)\} = \{0, 2\}, \{l_{anti}(0)_0\} = \{0, 2\}, \{l_{anti}(0)_2\} = \{1, 2\}$$

$$\{l_{neut}(1)\} = \{0\}, \{l_{anti}(1)_0\} = \{0, 2\}$$

$$\{l_{neut}(2)\} = \{0, 1, 2\}, \{l_{anti}(2)_0\} = \{0, 2\}, \{l_{anti}(2)_1\} = \{0, 1, 2\}, \{l_{anti}(2)_2\} = \{0, 1, 2\}$$

These means that for a certain x in an LNET-LA-semihypergroup, $|\{l_{neut}(x)\}|$ may be greater than or equal to one and for a certain $p \in \{l_{neut}(x)\}$, $|\{l_{anti}(x)_p\}|$ may be greater than or equal to one. There are similar conclusions in RNET-LA-semihypergroup. In addition, for a certain x in an LA-semihypergroup, if $s \in \{l_{neut}(x)\}$ (or $s \in \{r_{neut}(x)\}$), then s may be not in $\{r_{neut}(x)\}$ (or $\{l_{neut}(x)\}$). By Example 11, we have $1 \in \{r_{neut}(0)\}$ but $1 \notin \{l_{neut}(0)\}$.

Remark 5. Non-LNET-LA-semihypergroup (or Non-RNET-LA-semihypergroup) is not an NET-LA-semihypergroup. $(L, *)$ is both an LNET-LA-semihypergroup and a RNET-LA-semihypergroup but it is not necessarily an NET-LA-semihypergroup.

Based on the above, the relationships of NET-LA-semihypergroup, RNET-LA-semihypergroup and LNET-LA-hypergroup, can be represented by Figure 6.

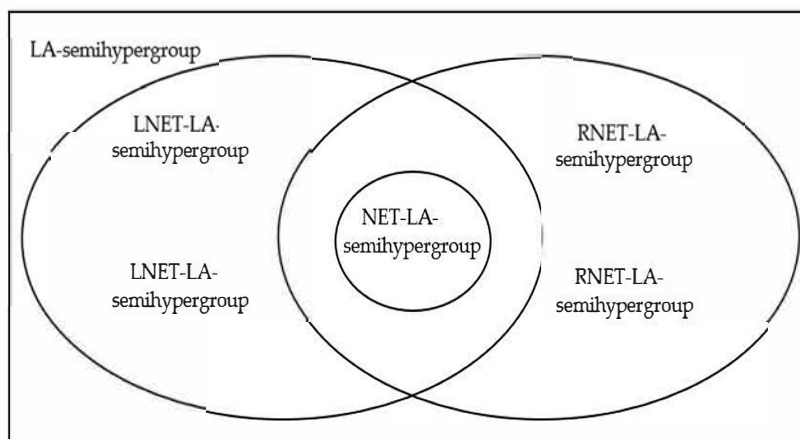

Figure 6. The relationships of various LA-semihypergroups.

3. Strong Pure Neutrosophic Extended Triplet LA-Semihypergroups (SPNET-LA-Semihypergroups)

Definition 13. An LA-semihypergroup $(L, *)$ is said to be

- (a) a pure left neutrosophic extended triplet LA-semihypergroup (PLNET-LA-semihypergroup), if to any given $a \in L$, there are $p \in L$ and $q \in L$, in such a way that

$$a = p * a \text{ and } p = q * a$$

- (b) a pure right neutrosophic extended triplet LA-semihypergroup (PRNET-LA-semihypergroup), if to any given $a \in L$, there are $s \in L$ and $t \in L$, in such a way that

$$a = a * s \text{ and } s = a * t$$

- (c) a pure neutrosophic extended triplet LA-semihypergroup (PNET-LA-semihypergroup), if to any given $a \in L$, there are $m \in L$ and $n \in L$, in such a way that

$$a = (m * a) \cap (a * m) \text{ and } m = (n * a) \cap (a * n)$$

- (d) a strong pure neutrosophic extended triplet LA-semihypergroup (SPNET-LA-semihypergroup), if to any given $a \in L$, there are $m \in L$ and $n \in L$, in such a way that

$$a = m * a = a * m \text{ and } m = n * a = a * n$$

Proposition 5. Every SPNET-LA-semihypergroup is a PNET-LA-semihypergroup; Every PNET-LA-semihypergroup is an NET-LA-semihypergroup. Every PLNET-LA-semihypergroup is an LNET-LA-semihypergroup; Every PRNET-LA-semihypergroup is a RNET-LA-semihypergroup.

Remark 6. From Proposition 5, we know that the signs in the Definition 11 can still be used, such as $\{ \}_{neut(a)}$, $\{ \}_{rneut(a)}$, $\{ \}_{neut(a)}$, $\{ \}_{lanti(a)_p}$, $\{ \}_{ranti(a)_p}$, etc.

Proposition 6. Every commutative PNET-LA-semihypergroup is an SPNET-LA-semihypergroup; Every commutative PLNET-LA-semihypergroup(or PRNET-LA-semihypergroup) is an SPNET-LA-semihypergroup.

Proposition 7. Suppose $(L, *)$ is an SPNET-LA-semihypergroup, for any $a, b, c \in L$,

- (1) if $s \in \{ \}_{neut(a)}$, then s is unique and $s * s = s$;
- (2) if $s = neut(a)$, then $neut(s) = s$ and $s \in \{ \}_{anti(s)_s}$;

- (3) if $s = neut(a)$, $t \in \{\}_{anti(a)_s}$, $r \in \{\}_{anti(s)_s}$, then $r * t \subseteq \{\}_{lanti(a)_s}$;
- (4) if $s = neut(a)$, $t \in \{\}_{anti(a)_s}$, then $s * t \subseteq \{\}_{lanti(a)_s}$;
- (5) if $p = neut(a)$, $s = neut(b)$, $q \in \{\}_{anti(a)_p}$, $t \in \{\}_{anti(b)_s}$ and $|a * b| = |p * s| = 1$, then

$$neut(a * b) = p * sandq * t \subseteq \{\}_{anti(a*b)_{p*s}}$$

- (6) if $s = neut(a) = neut(b)$, $q \in \{\}_{anti(a)_s}$, $t \in \{\}_{anti(b)_s}$ and $|a * b| = 1$, then

$$neut(a * b) = sandq * t \subseteq \{\}_{anti(a*b)_s}$$

- (7) if $neut(a) = neut(b)$, then $a * b = b * a$;
- (8) then $s * b = s * c$ if $b * a = c * a$, where $s = neut(a)$;
- (9) if $s = neut(a)$, $q, t \in \{\}_{anti(a)_s}$, then $s * q = s * t$.

Proof. (1) Suppose there are $s, p \in \{\}_{neut(a)}$, $t \in \{\}_{anti(a)_s}$, $q \in \{\}_{anti(a)_p}$. $(L, *)$ is an SPNET-LA-semihypergroup, hence

$$a = s * a = a * s, s = t * a = a * t$$

$$a = a * p = p * a, p = a * q = q * a$$

we get

$$s * p = (t * a) * p = (p * a) * t = a * t = s$$

$$p * s = (q * a) * s = (s * a) * q = a * q = p$$

$$s * p = (a * t) * (q * a) = (a * q) * (t * a) = p * s$$

Thus $p = s$, it implies s is unique and $s * s = s$.

(2) From (1), if $s = neut(a) \in L$, then $s * s = s * s = s$, This implies $neut(s) = s$ and $s \in \{\}_{anti(s)_s}$.

(3) For any given $a \in L$, if $s = neut(a)$, $t \in \{\}_{anti(a)_s}$, then

$$a = a * s = s * a, s = a * t = t * a$$

On the other hand, from $neut(s) = s$ and $r \in \{\}_{anti(s)_s}$, we get

$$s = s * s = s * s, s = r * s = s * r$$

Thus

$$\bigcup_{m \in r * t} (m * a) = (r * t) * a = (a * t) * r = s * r = s$$

where $m * a$ is a nonempty set, hence for any $m \in r * t$, $m * a = s$. This implies $m \in \{\}_{lanti(a)_s}$. In other words, $r * t \subseteq \{\}_{lanti(a)_s}$.

(4) By (2), (3), we can get (4).

(5) if $p = neut(a)$, $s = neut(b)$, $q \in \{\}_{anti(a)_p}$, $t \in \{\}_{anti(b)_s}$, then

$$(p * s) * (a * b) = (p * a) * (s * b) = a * b$$

$$(a * b) * (p * s) = (a * p) * (b * s) = a * b.$$

That is,

$$(p * s) * (a * b) = (a * b) * (p * s) = a * b. \tag{14}$$

On the other hand,

$$\bigcup_{l \in q * t} [(a * b) * l] = (a * b) * (q * t) = (a * q) * (b * t) = p * s,$$

where $(a * b) * l$ is a nonempty set, $|a * b| = 1$ and $|p * s| = 1$. Hence for any $l \in q * t$, $(a * b) * l = p * s$. In the same way, we can prove that for any $l \in q * t$, $l * (a * b) = p * s$. Thus for any $l \in q * t$,

$$l * (a * b) = (a * b) * l = p * s. \tag{15}$$

From (14), (15) and $|a * b| = |p * s| = 1$, we get $neut(a * b) = p * s$ and $q * t \subseteq \{\}_{anti(a*b)}_{p*s}$.

(6) Let $p = s$ in Proposition 7 (5), we can get the conclusion.

(7) $(L, *)$ is an SPNET-LA-semihypergroup, hence for any given $a, b \in L$, there are $neut(a) = s$, $neut(b) = p$, $t \in \{\}_{anti(a)}_s$, $q \in \{\}_{anti(b)}_p$ such that

$$\begin{aligned} a &= a * s = s * a, s = a * t = t * a \\ b &= b * p = p * b, p = b * q = q * b. \end{aligned}$$

If $s = p$, then we have

$$a * b = (a * s) * (b * p) = (a * b) * (s * p) = (a * b) * (s * s) = (a * b) * s = (s * b) * a = (p * b) * a = b * a.$$

(8) Suppose that $b * a = c * a$ for $a, b, c \in L$. There are $s = neut(a) \in L$ and $t \in \{\}_{anti(a)}_s$. Multiply $b * a = c * a$ by t , we have

$$\begin{aligned} (b * a) * t &= (c * a) * t \\ (t * a) * b &= (t * a) * c \\ s * b &= s * c \end{aligned}$$

(9) For any given $a \in L$, there is $s = neut(a) \in L$, if $q, t \in \{\}_{anti(a)}_s$, then

$$s * q = (t * a) * q = (q * a) * t = s * t.$$

□

Theorem 1. Suppose $(L, *)$ is a PRNET-LA-semihypergroup, for any $x \in L$,

(a) if $p \in \{\}_{rneut(x)}$, $q \in \{\}_{ranti(x)}_p$ and $|p * p| = 1$, then

$$p * \subseteq \{\}_{lneut(x)} * \subseteq \{\}_{lanti(x)}_{p,p}$$

and $(L, *)$ is an PLNET-LA-semihypergroup.

(b) if $p \in \{\}_{rneut(x)}$, $q \in \{\}_{ranti(x)}_p$, $p * p = p$ and $q \in p * q$, then

$$p = neutx \in \{\}_{anti(x)}_p$$

and $(L, *)$ is an SPNET-LA-semihypergroup.

Proof. (1) Since $(L, *)$ is a PRNET-LA-semihypergroup, for any given $x \in L$, there are $p \in \{\}_{rneut(x)}$ and $q \in \{\}_{ranti(x)}_p$ such that

$$x = x * p, p = x * q$$

multiply $x = x * p$ by p , we have

$$x = x * p = (x * p) * p = (p * p) * x$$

In addition,

$$\bigcup_{s \in p * q} (s * x) = (p * q) * x = (x * q) * p = p * p$$

where $s * x$ is a nonempty set and $|p * p| = 1$. Thus for any $s \in p * q$, $s * x = p * p$. It means that for any $x \in L$, there are $p * p, s \in p * q$ such that

$$(p * p) * x = x, s * x = p * p$$

It shows that

$$p * p \subseteq \{ \}_{neut(x)}, s \in p * q \subseteq \{ \}_{lanti(x)_{p * p}}$$

By Definition 11, $(L, *)$ is an LNET-LA-semihypergroup.

(2) By Theorem 1 (a),

$$p = p * p \in \{ \}_{neut(x)}$$

$$q \in p * q \subseteq \{ \}_{lanti(x)_{p * p}} = \{ \}_{lanti(x)_p}$$

It shows that for any given $x \in L$, there is $p \in L$ such that

$$p * x = x \text{ and } q * x = p$$

● On the other hand, $p \in \{ \}_{rneut(x)}, q \in \{ \}_{ranti(x)_p}$, we get

$$x = x * p \text{ and } x * q = p$$

Based on the above, for any given $x \in L$, there are p and q such that

$$x = x * p = p * x$$

$$p = x * q = q * x$$

That is,

$$p \in \{ \}_{neut(x)} \text{ and } q \in \{ \}_{anti(x)_p}$$

By Definition 11, $(L, *)$ is an SPNET-LA-semihypergroup. Applying Proposition 7 (1), we get $p = neut(x)$. □

Example 12. Put $L = \{0, 1, 2\}$, the binary hypergroupoid $(L, *)$ is as follows (see Table 11).

Table 11. The binary hypergroupoid $(L, *)$.

*	0	1	2
0	0	1	{0,1,2}
1	1	0	{0,1,2}
2	{0,1,2}	{0,1,2}	2

By Python program, $(L, *)$ is an LA-semihypergroup. Furthermore, we have

$$rneut(0) = 0, rneut(1) = 0, rneut(2) = 2$$

$$ranti(0)_{rneut(0)=0}, ranti(1)_{rneut(1)=0}, ranti(2)_{rneut(2)=2} = 2$$

$$0 * 0 = 0, 0 * 0 = 0, 2 * 2 = 2$$

$$0 \in 0 * 0, 1 \in 0 * 1, 2 \in 2 * 2$$

By Theorem 1 (b), we know that $(L, *)$ is an SPNET-LA-semihypergroup.

Corollary 1. A PRNET-LA-semihypergroup $(L, *)$, which satisfies conditions of Theorem 1 (b), then $neut(p * s) = neut(p) * neut(s)$ if $|p * s| = |neut(p) * neut(s)| = 1$, where $p, s \in L$.

Proof. It follows from Theorem 1 (b) and Proposition 7 (5). \square

Corollary 2. *An idempotent PRNET-LA-semihypergroup is a PLNET-LA-semihypergroup.*

Proof. It follows from Theorem 1 (a). \square

Proposition 8. *An idempotent PRNET-LA-semihypergroup with pure left identity is a commutative SPNET-LA-semihypergroup and its pure left identity is pure right identity.*

Proof. Put e is a pure left identity of $(L, *)$. Then for any $t \in L$,

$$e * t = t,$$

by idempotent law, we get

$$t * e = (t * t) * e = (e * t) * t = t * t = t.$$

It shows that e is pure right identity of $(L, *)$. Furthermore, for any $m, n \in L$,

$$m * n = (m * e) * n = (n * e) * m = n * m.$$

It follows that $(L, *)$ satisfies commutative law.

On the other hand, $(L, *)$ is a PRNET-LA-semihypergroup. Hence for any given $a \in L$, there are $s \in \{\}_{rneut(a)}$ and $t \in \{\}_{ranti(a)_s}$ such that

$$a = a * s, s = a * t.$$

Applying commutative law, we get

$$a = a * s = s * a, s = a * t = t * a.$$

Thus $(L, *)$ a commutative SPNET-LA-semihypergroup. \square

Proposition 9. *Suppose $(L, *)$ is a PRNET-LA-semihypergroup (or a PLNET-LA-semihypergroup) with pure right identity, then pure right identity is pure left identity and $(L, *)$ is a commutative Net-semihypergroup.*

Proof. Put e is a pure right identity of $(L, *)$, Then for any given $t \in L$,

$$t * e = t,$$

we have

$$t = t * e = (t * e) * e = (e * e) * t = e * t.$$

This shows that e is pure left identity of $(L, *)$. Furthermore, for any $l, m, n \in L$,

$$m * n = (m * e) * n = (n * e) * m = n * m$$

$$(l * m) * n = (l * m) * (e * n) = (l * e) * (m * n) = l * (m * n).$$

It follows that $(L, *)$ satisfies commutative law and associative law. In addition, $(L, *)$ is a PRNET-LA-semihypergroup. Hence for any given $s \in L$, there are $p \in \{\}_{rneut(s)}$ and $q \in \{\}_{ranti(s)_p}$ such that

$$s = s * p, p = s * q.$$

Applying commutative law, we get

$$s = s * p = p * s, p = s * q = q * s.$$

By Definition 10, $(L, *)$ is a commutative NET-semihypergroup. \square

Theorem 2. Let $(L, *)$ be a PRNET-LA-semihypergroup, which satisfies the following conditions:

(1) for any $t \in L$, there are $p \in \{\}_{r\text{neut}(t)}$, $q \in \{\}_{r\text{anti}(t)}$, such that

$$p * p = p, q = p * q; \tag{16}$$

By condition (1), for a certain q in (1), there are $r \in \{\}_{r\text{neut}(q)}$, $l \in \{\}_{r\text{anti}(q)}$, such that

$$r * r = r, l = r * l \tag{17}$$

(2) $|p * r| = 1$, where p in (16) and r in (17);

(3) for any $m, n \in L$, if $\text{neut}(m) = \text{neut}(n)$, then $|m * n| = 1$.

Define an equivalent relation φ on L ,

$$m \varphi n \text{ if and only if } \text{neut}(m) = \text{neut}(n)$$

Then

(a) (To every $t \in L$, $([t], *)$ is a sub NET-LA-semihypergroup of $(L, *)$, in which $[t]$ is the equivalent class of t based on equivalent relation φ ;

(b) To every $t \in L$, $([t], *)$ is a regular LA-hypergroup.

Proof. (a) Firstly, by Theorem 1 (b) and Theorem 2's condition (1), we know that $(L, *)$ is an SPNET-LA-semihypergroup. Suppose $m, n \in [t]$, by Theorem 2's condition (3), we have

$$\text{neut}(m) = \text{neut}(n) = \text{neut}(t) \text{ and } |m * n| = 1$$

Applying Proposition 7 (6), we get $\text{neut}(m * n) = \text{neut}(t)$. It shows that $m * n \in [t]$.

Secondly, applying Proposition 7 (2), we have

$$\text{neut}(\text{neut}(m)) = \text{neut}(\text{neut}(t)) = \text{neut}(t)$$

It means that for any $m \in [t]$, $\text{neut}(m) \in [t]$.

Lastly, by Theorem 2's condition (1) and Theorem 1 (b), for any $m \in [t] \subseteq L$, there is $q \in L$ such that

$$q = \text{neut}(m) * q \in \{\}_{\text{anti}(m)_{\text{neut}(m)}} \tag{18}$$

and for the q in (18), there are $r \in \{\}_{r\text{neut}(q)}$, $l \in \{\}_{r\text{anti}(q)}$, such that

$$\begin{aligned} r * r = r, l = r * l \\ \text{and } r = \text{neut}(q). \end{aligned} \tag{19}$$

By Theorem 2's condition (2) and (19), we get

$$|\text{neut}(m) * r| = |\text{neut}(m) * \text{neut}(q)| = |\text{neut}(\text{neut}(m)) * \text{neut}(q)| = 1.$$

Applying Proposition 7 (5), we get

$$\begin{aligned} \text{neut}(\text{neut}(m) * q) &= \text{neut}(\text{neut}(m)) * \text{neut}(q) = \text{neut}(m) * \text{neut}(q) \\ &= \text{neut}(m * q) = \text{neut}(\text{neut}(m)) = \text{neut}(m) = \text{neut}(t). \end{aligned}$$

This implies $q = \text{neut}(m) * q \in \{\}_{\text{anti}(m)_{\text{neut}(m)}} \in [t]$. Thus $([t], *)$ is a sub SPNET-LA-semihypergroup.

(b) Firstly, from (a), for any given $t \in L$, $([t], *)$ is a sub-SPNET-LA-semihypergroup of $(L, *)$. By the definition of ϕ , if $m \in [t]$, then for any $n \in [t]$, $neut(m) = neut(n) = neut(t)$. Applying Proposition 7 (7), we get

$$m * n = n * m.$$

That is $m * [t] = [t] * m$.

Secondly, for any $s \in [t]$, $s * m \in [t]$, hence $[t] * m \subseteq [t]$; On the other hand, by proof of (a), we know that for any $m \in [t]$, there is $q \in [t]$ such that

$$q = neut(m) * q \{ \}_{anti(m)_{neut(m)}}$$

hence for any $s \in [t]$, $s * q \in [t]$. Thus

$$s = neut(s) * s = neut(m) * s = (m * q) * s = (s * q) * m \subseteq [t] * m.$$

That is, $[t] \subseteq [t] * m$. Thus $[t] = [t] * m = m * [t]$. It implies that $([t], *)$ is a LA-hypergroup.

Lastly, it can be easily proved that $neut(t)$ is a scalar identity of $([t], *)$ and for every $l \in [t]$ has at least one inverse. By Definition 8, $([t], *)$ is a regular LA-hypergroup. \square

Corollary 3. *If a PRNET-LA-semihypergroup $(L, *)$ which satisfies conditions of Theorem 2 and ϕ is the equivalence relation on L defined in Theorem 2, then L / ϕ is the partition of set L .*

Example 13. *Put $L = \{0, 1, 2, 3, 4\}$, the binary hypergroupoid $(L, *)$ is as follows (see Table 12).*

Table 12. The binary hypergroupoid $(L, *)$.

*	0	1	2	3	4
0	0	1	{0, 1, 2}	0	4
1	1	0	{0, 1, 2}	1	4
2	{0, 1, 2}	{0, 1, 2}	2	{0, 1, 2}	4
3	0	1	{0, 1, 2}	3	4
4	4	4	4	4	4

By Python program, $(L, *)$ is LA-semihypergroup. Firstly, we have

$$rneut(\bullet) = 0, rneut(1) = 0, rneut(2) = 2, rneut(3) = 3, rneut(4) = 4$$

$$ranti(0)_{rneut(0)=0} = 0, ranti(1)_{rneut(1)=0} = 1, ranti(2)_{rneut(2)=2} = 2, ranti(3)_{rneut(3)=3}, ranti(4)_{rneut(4)=4} = 4$$

$$0 * 0 = 0, 0 * 1 = 0, 1 * 1 = 0, 2 * 2 = 2, 3 * 3 = 3, 4 * 4 = 4$$

$$0 = 0 * 0, 1 = 0 * 1, 2 = 2 * 2, 3 = 3 * 3, 4 = 4 * 4.$$

These means that Theorem 2's condition 1) hold; Secondly, we get

$$\left| rneut0 * rneut(ranti(0)_{rneut(0)=0}) \right| = \left| rneut(0) * rneut(0) \right| = |0| = 1$$

$$\left| () * rneut(ranti(1)_{rneut(1)=0}) \right| = \left| rneut(1) * rneut(1) \right| = |0| = 1$$

$$\left| () * rneut(ranti(2)_{rneut(2)=2}) \right| = \left| rneut(2) * rneut(2) \right| = |2| = 1$$

$$\left| () * rneut(ranti(3)_{rneut(3)=3}) \right| = \left| rneut(3) * rneut(3) \right| = |3| = 1$$

$$\left| () * rneut(ranti(4)_{rneut(4)=4}) \right| = \left| rneut(4) * rneut(4) \right| = |4| = 1$$

These means that Theorem 2's condition (2) hold. Lastly,

$$rneut(0) = rneut(1) = 0, |0 * 1| = 1$$

These means that Theorem 2's condition (3) hold. By Theorem 1 and Theorem 2, we know that $(L, *)$ is an SPNET-LA-semihypergroup and

$$L_1 = \{0, 1\} = [0] = [1], L_2 = \{2\} = [2], L_3 = \{3\} = [3], L_4 = \{4\} = [4]$$

$$L = L_1 \cup L_2 \cup L_3 \cup L_4$$

where $(L_1, *), (L_2, *), (L_3, *), (L_4, *)$ are all regular LA-hypergroups.

Definition 14. An NET-LA-semihypergroup $(L, *)$ satisfies weak commutative law, if for any $y \in L$,

$$p * y = y * p, q * x = x * q$$

where x is any element of set $L, p \in \{ \}_{rneut(x)}, q \in \{ \}_{anti(x)_p}$.

Proposition 10. An SPNET-LA-semihypergroup $(L, *)$ satisfies weak commutative law if and only if it is a commutative.

Proof. If $(L, *)$ is a weak commutative, then for any $x, y \in L, l \in \{ \}_{rneut(x)}, m \in \{ \}_{rneut(y)}$, we have

$$x * y = (x * l) * (y * m) = (l * x) * (y * m) = (l * y) * (x * m) = (y * l) * (m * x) = (y * m) * (l * x) = y * x$$

That is, $(L, *)$ is commutative. \square

4. Conclusions

In this study, we give the new notions of NET-LA-semihypergroup, NET-LA-hypergroup, LNET-LA-semihypergroup, RNET-LA-semihypergroup, PLNET-LA-semihypergroup, PRNET-LA-semihypergroup, PNET-LA-semihypergroup, SPNET-LA-semihypergroup, discuss the relationships of them (see Figures 5 and 6), get some special properties of SPNET-LA-semihypergroup (see Proposition 7). In particular, we prove that a RNET-LA-semihypergroup which satisfies certain conditions (the condition of asymmetry) be an SPNET-LA-semihypergroup and this SPNET-LA-semihypergroup is the union of some disjoint regular hypergroups, where every regular hypergroup is its subhypergroup (see Theorem 2). At last, we discuss the relationships of various NET-LA-semihypergroups (see Figure 7).

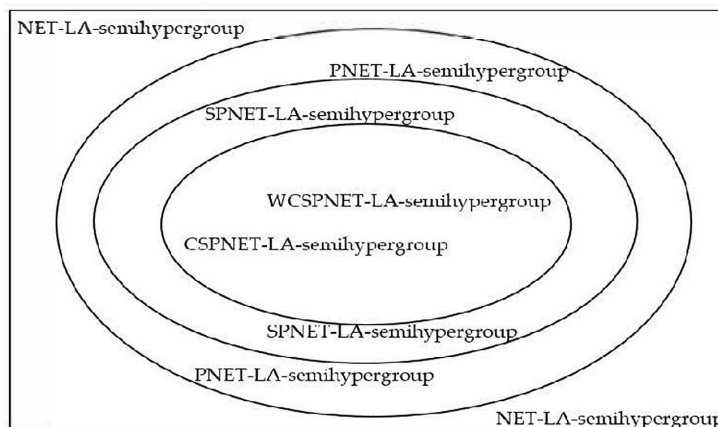

Figure 7. The relationships of various NET-LA-semihypergroups.

These studies help us to enhance the understanding of this hyperalgebraic structure about NET and tell us this hyper algebraic structure is a complex and unique structure. There is still a lot of unknown knowledge in this field to explore. In the future, we will discuss properties of NET-CA-semihypergroup.

Funding: This research was funded by National Natural Science Foundation of China (Grant No. 61976130).

References

1. Kazim, M.A.; Naseeruddin, N. On almost semigroups. *Aligarh Bull. Math.* **1972**, *2*, 1–7.
2. Marty, F. Sur Une Generalization de la Notion de Groupe. In Proceedings of the 8th Congres des Mathematicians Scandinaves, Stockholm, Sweden, 14–18 August 1934; pp. 45–49.
3. Vougiouklis, T. *Hyperstructures and Their Representations*; Hadronic Press: Palm Harbor, FL, USA, 1994.
4. Howie, J.M. *Fundamentals of Semigroup Theory*; Oxford University Press: Oxford, UK, 1995.
5. Corsini, P.; Leoreanu, V. *Applications of Hyperstructure Theory*; Springer: Berlin/Heidelberg, Germany, 2003.
6. Davvaz, B. *Semihypergroup Theory*; Elsevier: Amsterdam, The Netherlands, 2016.
7. Hila, K.; Dine, J. On hyperideals in left almost semihypergroups. *ISRN Algebra* **2011**, *2011*, 953124. [[CrossRef](#)]
8. Yaqoob, N.; Corsini, P.; Yousafzai, F. On intra-regular left almost semihypergroups with pure left identity. *J. Math.* **2013**, *2013*, 510790. [[CrossRef](#)]
9. Amjad, V.; Hila, K.; Yousafzai, F. Generalized hyperideals in locally associative left almost semihypergroups. *N. Y. J. Math.* **2014**, *20*, 1063–1076.
10. Yaqoob, N.; Gulistan, M. Partially ordered left almost semihypergroups. *J. Egypt. Math. Soc.* **2015**, *23*, 231–235. [[CrossRef](#)]
11. Yousafzai, F.; Hila, K.; Corsini, P.; Zeb, A. Existence of non-associative algebraic hyperstructures and related problems. *Afr. Mat.* **2015**, *26*, 981–995. [[CrossRef](#)]
12. Rehman, I.; Yaqoob, N.; Nawaz, S. Hyperideals and hypersystems in LA-hyperring. *Songklanakarin J. Sci. Technol.* **2017**, *39*, 651–657.
13. Nawaz, S.; Rehman, I.; Gulistan, M. On left almost semihyperring. *Int. J. Anal. Appl.* **2018**, *16*, 528–541.
14. Smarandache, F.; Ali, M. Neutrosophic triplet group. *Neural Comput. Appl.* **2018**, *29*, 595–601. [[CrossRef](#)]
15. Gulistan, M.; Nawaz, S.; Hassan, N. Neutrosophic Triplet Non-Associative Semihypergroups with Application. *Symmetry* **2018**, *10*, 613. [[CrossRef](#)]
16. Smarandache, F. *Neutrosophic Perspectives: Triplets, Duplets, Multisets, Hybrid Operators, Modal Logic, Hedge Algebras. And Applications*; Pons Publishing House: Brussels, Belgium, 2017.
17. Zhang, X.H.; Hu, Q.Q.; Smarandache, F.; An, X.G. On neutrosophic triplet groups: Basic properties, NT-subgroups, and some notes. *Symmetry* **2018**, *10*, 289. [[CrossRef](#)]
18. Jaíyéolá, T.G.; Smarandache, F. Some results on neutrosophic triplet group and their applications. *Symmetry* **2018**, *10*, 202. [[CrossRef](#)]
19. Zhang, X.H.; Wu, X.Y.; Mao, X.Y.; Smarandache, F.; Park, C. On neutrosophic extended triplet groups (Loops) and Abel-Grassmann's Groupoids (AG-Groupoids). *J. Intell. Fuzzy Syst.* **2019**, *37*, 5743–5753. [[CrossRef](#)]
20. Wu, X.Y.; Zhang, X.H. The decomposition theorems of AG-neutrosophic extended triplet loops and strong AG-(l, l)-loops. *Mathematics* **2019**, *7*, 268. [[CrossRef](#)]
21. Ma, Y.C.; Zhang, X.H.; Yang, X.F.; Zhou, X. Generalized neutrosophic extended triplet group. *Symmetry* **2019**, *11*, 327. [[CrossRef](#)]
22. Zhang, X.H.; Wang, X.J.; Smarandache, F.; Jaíyéolá, T.G.; Lian, T.Y. Singular neutrosophic extended triplet groups and generalized groups. *Cogn. Syst. Res.* **2019**, *57*, 32–40. [[CrossRef](#)]
23. Zhang, X.H.; Smarandache, F.; Ma, Y.C. Neutrosophic Extended Triplet Semihypergroups and Regular Hypergroups. *Symmetry* **2019**, *11*, 1217. [[CrossRef](#)]
24. Zhang, X.H.; Mao, X.Y.; Wu, Y.T.; Zhai, X.H. Neutrosophic filters in pseudo-BCI algebras. *Int. J. Uncertain. Quan.* **2018**, *8*, 511–526. [[CrossRef](#)]

25. Zhang, X.H.; Borzooei, R.A.; Jun, Y.B. Q-filters of quantum B-algebras and basic implication algebras. *Symmetry* **2018**, *10*, 573. [[CrossRef](#)]
26. An, X.G.; Zhang, X.H.; Ma, Y.C. Generalized Abel-Grassmann's Neutrosophic Extended Triplet Loop. *Mathematics* **2019**, *7*, 1206. [[CrossRef](#)]

Neutrosophic \aleph –interior ideals in semigroups

K. Porselvi, B. Elavarasan, F. Smarandache

K. Porselvi, Balasubramanian Elavarasan, F. Smarandache (2020). Neutrosophic \aleph -interior ideals in semigroups. *Neutrosophic Sets and Systems* 36, 70-80

Abstract: We define the concepts of neutrosophic \aleph -interior ideal and neutrosophic \aleph –characteristic interior ideal structures of a semigroup. We infer different types of semigroups using neutrosophic \aleph -interior ideal structures. We also show that the intersection of neutrosophic \aleph -interior ideals and the union of neutrosophic \aleph -interior ideals is also a neutrosophic \aleph -interior ideal.

Keywords: Semi group, neutrosophic \aleph –ideals, neutrosophic \aleph -interior ideals, neutrosophic \aleph –product.

1. Introduction

Nowadays, the theory of uncertainty plays a vital role to manage different issues relating to modelling engineering problems, networking, real-life problem relating to decision making and so on. In 1965, Zadeh[24] introduced the idea of fuzzy sets for modelling vague concepts in the globe. In 1986, Atanassov [1] generalized fuzzy set and named as Intuitionistic fuzzy set. Also, from his viewpoint, there are two degrees of freedom in the real world, one a degree of membership to a vague subset and the other is a degree of non-membership to that given subset.

Smarandache generalized fuzzy set and intuitionistic fuzzy set, and named as neutrosophic set (see [4, 7, 8, 14, 19, 22-23]). These sets are characterized by a truth membership function, an indeterminacy membership function and a falsity membership function. These sets are applied to many branches of mathematics to overcome the complexities arising from uncertain data. A Neutrosophic set can distinguish between absolute membership and relative membership. Smarandache used this in non-standard analysis such as the result of sports games (winning/defeating/tie), decision making and control theory, etc. This area has been studied by several authors (see [3, 11, 12, 16-18]).

For more details on neutrosophic set theory, the readers visit the website <http://fs.gallup.unm.edu/FlorentinSmarandache.htm>

In [2], Abdel Basset et al. designed a framework to manage scheduling problems using neutrosophic theory. As the concept of time-cost tradeoffs and deterministic project scheduling disagree with the real situation, some data were changed during the implementation process. Here fuzzy scheduling and time-cost tradeoffs models assumed only truth-membership functions dealing

with uncertainties of the project and their activities duration which were unable to treat indeterminacy and inconsistency.

In [6], Abdel Basset et al. evaluated the performance of smart disaster response systems under uncertainty. In [5], Abdel Basset et al. introduced different hybrid neutrosophic multi-criteria decision-making framework for professional selection that employed a collection of neutrosophic analytical network process and order preference by similarity to the ideal solution under bipolar neutrosophic numbers.

In [21], Prakasam Muralikrishna1 et al. presented the characterization of MBJ – Neutrosophic β – Ideal of β – algebra. They analyzed homomorphic image, pre-image, cartesian product and related results, and these concepts were explored to other substructures of a β – algebra. In [9], Chalapathi et al. constructed certain Neutrosophic Boolean rings, introduced Neutrosophic complement elements and mainly obtained some properties satisfied by the Neutrosophic complement elements of Neutrosophic Boolean rings.

In [14], M. Khan et al. presented the notion of neutrosophic \aleph -subsemigroup in semigroup and explored several properties. In [11], Gulistan et al. have studied the idea of complex neutrosophic subsemigroups and introduced the concept of the characteristic function of complex neutrosophic sets, direct product of complex neutrosophic sets.

In [10], B. Elavarasan et al. introduced the notion of neutrosophic \aleph -ideal in semigroup and explored its properties. Also, the conditions for neutrosophic \aleph -structure to be neutrosophic \aleph -ideal are given, and discussed the idea of characteristic neutrosophic \aleph -structure in semigroups and obtained several properties. In [20], we have introduced and discussed several properties of neutrosophic \aleph -bi-ideal in the semigroup. We have proved that neutrosophic \aleph -product and the intersection of neutrosophic \aleph -ideals were identical for regular semigroups. In this paper, we define and discuss the concepts of neutrosophic \aleph -interior ideal and neutrosophic \aleph -characteristic interior ideal structures of a semigroup.

Throughout this paper, X denotes a semigroup. Now, we present the important definitions of semigroup that we need in sequel.

Recall that for any $X_1, X_2 \subseteq X$, $X_1X_2 = \{ab|a \in X_1 \text{ and } b \in X_2\}$, multiplication of X_1 and X_2 .

Let X be a semigroup and $\emptyset \neq X_1 \subseteq X$. Then

- (i) X_1 is known as subsemigroup if $X_1^2 \subseteq X_1$.
- (ii) A subsemigroup X_1 is known as left (resp., right) ideal if $X_1X \subseteq X_1$ (resp., $XX_1 \subseteq X_1$).
- (iii) X_1 is known as ideal if X_1 is both a left and a right ideal.
- (iv) X is known as left (resp., right) regular if for each $r \in X$, there exists $i \in X$ such that $r = ir^2$ (resp., $r = r^2i$) [13].
- (v) X is known as regular if for each $b_1 \in X$, there exists $i \in X$ such that $b_1 = b_1ib_1$
- (vi) X is known as intra-regular if for each $x_1 \in X$, there exist $i, j \in X$ such that $x_1 = ix_1^2j$ [15].

2. Definitions of neutrosophic \aleph - structures

We present definitions of neutrosophic \aleph –structures namely neutrosophic \aleph –subsemigroup, neutrosophic \aleph –ideal, neutrosophic \aleph –interior ideal of a semigroup X

The set of all the functions from X to $[-1, 0]$ is denoted by $\mathfrak{S}(X, [-1, 0])$. We call that an element of $\mathfrak{S}(X, [-1, 0])$ is \aleph -function on X . A \aleph -structure means an ordered pair (X, g) of X and an \aleph -function g on X .

Definition 2.1.[14] A neutrosophic \aleph -structure of X is defined to be the structure:

$$X_M := \frac{X}{(T_M, I_M, F_M)} = \left\{ \frac{r}{(T_M(r), I_M(r), F_M(r))} \mid r \in X \right\},$$

where T_M, I_M and F_M are the negative truth, negative indeterminacy and negative falsity membership function on X (\aleph -functions).

It is evident that $-3 \leq T_M(r) + I_M(r) + F_M(r) \leq 0$ for all $r \in X$.

Definition 2.2.[14] A neutrosophic \aleph -structure X_M of X is called a neutrosophic \aleph -subsemigroup of X if the following assertion is valid:

$$(\forall g_i, h_j \in X) \begin{pmatrix} T_M(g_i h_j) \leq T_M(g_i) \vee T_M(h_j) \\ I_M(g_i h_j) \geq I_M(g_i) \wedge I_M(h_j) \\ F_M(g_i h_j) \leq F_M(g_i) \vee F_M(h_j) \end{pmatrix}.$$

.Let X_M be a neutrosophic \aleph -structure and $\gamma, \delta, \varepsilon \in [-1, 0]$ with $-3 \leq \gamma + \delta + \varepsilon \leq 0$. Consider the sets:

$$\begin{aligned} T_M^\gamma &= \{r_i \in X \mid T_M(r_i) \leq \gamma\} \\ I_M^\delta &= \{r_i \in X \mid I_M(r_i) \geq \delta\} \\ F_M^\varepsilon &= \{r_i \in X \mid F_M(r_i) \leq \varepsilon\}. \end{aligned}$$

The set $X_M(\gamma, \delta, \varepsilon) := \{r_i \in X \mid T_M(r_i) \leq \gamma, I_M(r_i) \geq \delta, F_M(r_i) \leq \varepsilon\}$ is known as $(\gamma, \delta, \varepsilon)$ -level set of X_M . It is easy to observe that $X_M(\gamma, \delta, \varepsilon) = T_M^\gamma \cap I_M^\delta \cap F_M^\varepsilon$.

Definition 2.3.[10] A neutrosophic \aleph -structure X_M of X is called a neutrosophic \aleph -left (resp., right) ideal of X if

$$(\forall g_i, h_j \in X) \begin{pmatrix} T_M(g_i h_j) \leq T_M(h_j) \text{ (resp., } T_M(g_i h_j) \leq T_M(g_i)) \\ I_M(g_i h_j) \geq I_M(h_j) \text{ (resp., } I_M(g_i h_j) \geq I_M(g_i)) \\ F_M(g_i h_j) \leq F_M(h_j) \text{ (resp., } F_M(g_i h_j) \leq F_M(g_i)) \end{pmatrix}.$$

X_M is neutrosophic \aleph -ideal of X if X_M is neutrosophic \aleph -left and \aleph -right ideal of X .

Definition 2.4. A neutrosophic \aleph -subsemigroup X_M of X is known as neutrosophic \aleph -interior ideal if

$$(\forall x, a, y \in X) \begin{pmatrix} T_M(xay) \leq T_M(a) \\ I_M(xay) \geq I_M(a) \\ F_M(xay) \leq F_M(a) \end{pmatrix}.$$

It is easy to observe that every neutrosophic \aleph -ideal is neutrosophic \aleph -interior ideal, but neutrosophic \aleph -interior ideal need not be a neutrosophic \aleph -ideal, as shown by an example.

Example 2.5. Let X be the set of all non-negative integers except 1. Then X is a semigroup with usual multiplication.

Let $X_M = \left\{ \frac{0}{(-0.9, -0.1, -0.7)}, \frac{2}{(-0.4, -0.6, -0.5)}, \frac{5}{(-0.3, -0.8, -0.3)}, \frac{10}{(-0.3, -0.8, -0.1)}, \frac{\text{otherwise}}{(-0.7, -0.4, -0.6)} \right\}$. Then X_M is neutrosophic \aleph -interior ideal, but not neutrosophic \aleph -ideal with $T_N(2.5) = -0.3 \not\leq T_N(2)$.

Definition 2.6.[14] For any $E \subseteq X$, the characteristic neutrosophic \aleph -structure is defined as

$$\chi_E(X_M) = \frac{X}{(\chi_E(T)_M, \chi_E(I)_M, \chi_E(F)_M)}$$

where

$$\chi_E(T)_M: X \rightarrow [-1, 0], r \rightarrow \begin{cases} -1 & \text{if } r \in E \\ 0 & \text{otherwise,} \end{cases}$$

$$\chi_E(I)_M: X \rightarrow [-1, 0], r \rightarrow \begin{cases} 0 & \text{if } r \in E \\ -1 & \text{otherwise,} \end{cases}$$

$$\chi_E(F)_M: X \rightarrow [-1, 0], r \rightarrow \begin{cases} -1 & \text{if } r \in E \\ 0 & \text{otherwise.} \end{cases}$$

Definition 2.7.[14] Let $X_N := \frac{X}{(T_N, I_N, F_N)}$ and $X_M := \frac{X}{(T_M, I_M, F_M)}$ be neutrosophic \aleph -structures of X . Then

- (i) X_N is called a neutrosophic \aleph -substructure of X_M , denote by $X_M \subseteq X_N$, if $T_M(r) \geq T_N(r)$, $I_M(r) \leq I_N(r)$, $F_M(r) \geq F_N(r)$ for all $r \in X$.
- (ii) If $X_N \subseteq X_M$ and $X_M \subseteq X_N$, then we say that $X_N = X_M$.
- (iii) The neutrosophic \aleph -product of X_N and X_M is defined to be a neutrosophic \aleph -structure of X ,

$$X_N \odot X_M := \frac{X}{(T_{N \circ M}, I_{N \circ M}, F_{N \circ M})} = \left\{ \frac{h}{(T_{N \circ M}(h), I_{N \circ M}(h), F_{N \circ M}(h))} \mid h \in X \right\},$$

where

$$(T_N \circ T_M)(h) = T_{N \circ M}(h) = \begin{cases} \bigwedge_{h=rs} \{T_N(r) \vee T_M(s)\} & \text{if } \exists r, s \in X \text{ such that } h = rs \\ 0 & \text{otherwise,} \end{cases}$$

$$(I_N \circ I_M)(h) = I_{N \circ M}(h) = \begin{cases} \bigvee_{h=rs} \{I_N(r) \wedge I_M(s)\} & \text{if } \exists u, v \in X \text{ such that } h = rs \\ -1 & \text{otherwise,} \end{cases}$$

$$(F_N \circ F_M)(h) = F_{N \circ M}(h) = \begin{cases} \bigwedge_{h=rs} \{F_N(r) \vee F_M(s)\} & \text{if } \exists u, v \in X \text{ such that } h = rs \\ 0 & \text{otherwise.} \end{cases}$$

For $i \in X$, the element $\frac{i}{(T_{N \circ M}(i), I_{N \circ M}(i), F_{N \circ M}(i))}$ is simply denoted by $(X_N \odot X_M)(i) = (T_{N \circ M}(i), I_{N \circ M}(i), F_{N \circ M}(i))$.

- (iii) The union of X_N and X_M , a neutrosophic \aleph -structure over X is defined as

$$X_N \cup X_M = X_{N \cup M} = (X; T_{N \cup M}, I_{N \cup M}, F_{N \cup M}),$$

where

$$(T_N \cup T_M)(h_i) = T_{N \cup M}(h_i) = T_N(h_i) \wedge T_M(h_i),$$

$$(I_N \cup I_M)(h_i) = I_{N \cup M}(h_i) = I_N(h_i) \vee I_M(h_i),$$

$$(F_N \cup F_M)(h_i) = F_{N \cup M}(h_i) = F_N(h_i) \wedge F_M(h_i) \quad \forall h_i \in X.$$

- (iv) The intersection of X_N and X_M , a neutrosophic \aleph -structure over X is defined as

$$X_N \cap X_M = X_{N \cap M} = (X; T_{N \cap M}, I_{N \cap M}, F_{N \cap M}),$$

where

$$(T_N \cap T_M)(h_i) = T_{N \cap M}(h_i) = T_N(h_i) \vee T_M(h_i),$$

$$(I_N \cap I_M)(h_i) = I_{N \cap M}(h_i) = I_N(h_i) \wedge I_M(h_i),$$

$$(F_N \cap F_M)(h_i) = F_{N \cap M}(h_i) = F_N(h_i) \vee F_M(h_i) \quad \forall h_i \in X.$$

3. Neutrosophic \aleph -interior ideals

We study different properties of neutrosophic \aleph -interior ideals of X . It is evident that neutrosophic \aleph -ideal is a neutrosophic \aleph -interior ideal of X , but not the converse. Further, for a regular and for an intra-regular semigroup, every neutrosophic \aleph -interior ideal is neutrosophic \aleph -ideal.

All throughout this part, we consider X_M and X_N are neutrosophic \aleph – structures of X .

Theorem 3.1. For any $L \subseteq X$, the equivalent assertions are:

- (i) L is an interior ideal,
- (ii) The characteristic neutrosophic \aleph – structure $\chi_L(X_N)$ is a neutrosophic \aleph – interior ideal.

Proof: Suppose L is an interior ideal and let $x, a, y \in X$.

If $a \in L$, then $xay \in L$, so $\chi_L(T)_N(xay) = -1 = \chi_L(T)_N(a)$, $\chi_L(I)_N(xay) = 0 = \chi_L(I)_N(a)$ and $\chi_L(F)_N(xay) = -1 = \chi_L(F)_N(a)$.

If $a \notin L$, then $\chi_L(T)_N(xay) \leq 0 = \chi_L(T)_N(a)$, $\chi_L(I)_N(xay) \geq -1 = \chi_L(I)_N(a)$ and $\chi_L(F)_N(xay) \leq 0 = \chi_L(F)_N(a)$.

Therefore $\chi_L(X_N)$ is a neutrosophic \aleph – interior ideal.

Conversely, assume that $\chi_L(X_N)$ is a neutrosophic \aleph – interior ideal. Let $u \in L$ and $x, y \in X$. Then

$$\begin{aligned} \chi_L(T)_N(xuy) &\leq \chi_L(T)_N(u) = -1, \\ \chi_L(I)_N(xuy) &\geq \chi_L(I)_N(u) = 0, \\ \chi_L(F)_N(xuy) &\leq \chi_L(F)_N(u) = -1. \end{aligned}$$

So $xuy \in L$. □

Theorem 3.2. If X_M and X_N are neutrosophic \aleph – interior ideals, then $X_{M \cap N}$ is neutrosophic \aleph – interior ideal.

Proof: Let X_M and X_N be neutrosophic \aleph – interior ideals. For any $r, s, t \in X$, we have

$$\begin{aligned} T_{M \cap N}(rst) &= T_M(rst) \vee T_N(rst) \leq T_M(s) \vee T_N(s) = T_{M \cap N}(s), \\ I_{M \cap N}(rst) &= I_M(rst) \wedge I_N(rst) \geq I_M(s) \wedge I_N(s) = I_{M \cap N}(s), \\ F_{M \cap N}(rst) &= F_M(rst) \vee F_N(rst) \leq F_M(s) \vee F_N(s) = F_{M \cap N}(s). \end{aligned}$$

Therefore $X_{M \cap N}$ is neutrosophic \aleph – interior ideal. □

Corollary 3.3. The arbitrary intersection of neutrosophic \aleph – interior ideals is a neutrosophic \aleph – interior ideal.

Theorem 3.4. If X_M and X_N are neutrosophic \aleph – interior ideals, then $X_{M \cup N}$ is neutrosophic \aleph – interior ideal.

Proof: Let X_M and X_N be neutrosophic \aleph – interior ideals. For any $r, s, t \in X$, we have

$$\begin{aligned} T_{M \cup N}(rst) &= T_M(rst) \wedge T_N(rst) \leq T_M(s) \wedge T_N(s) = T_{M \cup N}(s), \\ I_{M \cup N}(rst) &= I_M(rst) \vee I_N(rst) \geq I_M(s) \vee I_N(s) = I_{M \cup N}(s), \\ F_{M \cup N}(rst) &= F_M(rst) \wedge F_N(rst) \leq F_M(s) \wedge F_N(s) = F_{M \cup N}(s). \end{aligned}$$

Therefore $X_{M \cup N}$ is neutrosophic \aleph – interior ideal. □

Corollary 3.5. The arbitrary union of neutrosophic \aleph – interior ideals is neutrosophic \aleph – interior ideal.

Theorem 3.6. Let X be a regular semigroup. If X_M is neutrosophic \aleph – interior ideal, then X_M is neutrosophic \aleph – ideal.

Proof: Assume that X_M is an interior ideal, and let $u, v \in X$. As X is regular and $u \in X$, there exists $r \in X$ such that $u = uru$. Now, $T_M(uv) = T_M(uruv) \leq T_M(u)$, $I_M(uv) = I_M(uruv) \geq I_M(u)$ and $F_M(uv) = F_M(uruv) \leq F_M(u)$. Therefore X_M is neutrosophic \aleph – right ideal.

Similarly, we can show that X_M is neutrosophic \aleph – left ideal and hence X_M is neutrosophic \aleph – ideal. □

Theorem 3.7. Let X be an intra-regular semigroup. If X_M is neutrosophic \aleph – interior ideal, then X_M is neutrosophic \aleph – ideal.

Proof: Suppose that X_M is neutrosophic \aleph – interior ideal, and let $u, v \in X$. As X is intra regular and $u \in X$, there exist $s, t \in S$ such that $u = su^2t$. Now,

$$\begin{aligned} T_M(uv) &= T_M(su^2tv) \leq T_M(u), \\ I_M(uv) &= I_M(su^2tv) \geq I_M(u) \\ F_M(uv) &= F_M(su^2tv) \leq F_M(u). \end{aligned}$$

Therefore X_M is neutrosophic \aleph – right ideal. similarly, we can show that X_M is neutrosophic \aleph – left ideal and hence X_M is neutrosophic \aleph – ideal. □

Definition 3.8. A semigroup X is left simple (resp., right simple) if it does not contain any proper left ideal (resp., right ideal) of X . A semigroup X is simple if it does not contain any proper ideal of X .

Definition 3.9. A semigroup X is said to be neutrosophic \aleph –simple if every neutrosophic \aleph – ideal is a constant function

i.e., for every neutrosophic \aleph –ideal X_M of X , we have $T_M(i) = T_M(j)$, $I_M(i) = I_M(j)$ and $F_M(i) = F_M(j)$ for all $i, j \in X$.

Notation 3.10. If X is a semigroup and $s \in X$, we define a subset, denoted by I_s as follows:

$$I_s := \{i \in X \mid T_N(i) \leq T_N(s), I_N(i) \geq I_N(s) \text{ and } F_N(i) \leq F_N(s)\}.$$

Proposition 3.11. If X_N is neutrosophic \aleph – right (resp., \aleph – left, \aleph – ideal) ideal, then I_s is right (resp., left, ideal) ideal for every $s \in X$.

Proof: Let $s \in X$. Then it is clear that $\varphi \neq I_s \subseteq X$. Let $u \in I_s$ and $x \in X$. Then $ux \in I_s$. Indeed; Since X_N is neutrosophic \aleph – right ideal and $u, x \in X$, we get $T_N(ux) \leq T_N(u)$, $I_N(ux) \geq I_N(u)$ and $F_N(ux) \leq F_N(t)$. Since $u \in I_s$, we get $T_N(u) \leq T_N(s)$, $I_N(u) \geq I_N(s)$ and $F_N(u) \leq F_N(s)$ which imply $ux \in I_s$. Therefore I_s is a right ideal for every $s \in X$. □

Theorem 3.12.[4] For any $L \subseteq X$, the equivalent assertions are:

- (i) L is left (resp., right) ideal,
- (ii) Characteristic neutrosophic \aleph –structure $\chi_L(X_N)$ is neutrosophic \aleph –left (resp., right) ideal.

Theorem 3.13. Let X be a semigroup. Then X is simple if and only if X is neutrosophic \aleph –simple.

Proof: Suppose X is simple. Let X_M be a neutrosophic \aleph -ideal and $u, v \in X$. Then by Proposition 3.11, I_u is an ideal of X . As X is simple, we have $I_u = X$. Since $v \in I_u$, we have $T_M(v) \leq T_M(u)$, $I_M(v) \geq I_M(u)$ and $F_M(v) \leq F_M(u)$.

Similarly, we can prove that $T_M(u) \leq T_M(v)$, $I_M(u) \geq I_M(v)$ and $F_M(u) \leq F_M(v)$. So $T_M(u) = T_M(v)$, $I_M(u) = I_M(v)$ and $F_M(u) = F_M(v)$. Hence X is neutrosophic \aleph -simple.

Conversely, assume that X is neutrosophic \aleph -simple and I is an ideal of X . Then by Theorem 3.12, $\chi_I(X_N)$ is a neutrosophic \aleph -ideal. We now claim that $X = I$. Let $w \in X$. Since X is neutrosophic \aleph -simple, we have $\chi_I(X_N)$ is a constant function and $\chi_I(X_N)(w) = \chi_I(X_N)(y)$ for every $y \in X$. In particular, we have $\chi_I(T_N)(w) = \chi_I(T_N)(d) = -1$, $\chi_I(I_N)(w) = \chi_I(I_N)(d) = 0$ and $\chi_I(F_N)(w) = \chi_I(F_N)(d) = -1$ for any $d \in I$ which implies $w \in I$. Thus $X \subseteq I$ and hence $X = I$. \square

Lemma 3.14. Let X be a semigroup. Then X is simple if and only for every $t \in X$, we have $X = XtX$.

Proof: Suppose X is simple and let $t \in X$. Then $X(XtX) \subseteq XtX$ and $(XtX)X \subseteq XtX$ imply that XtX is an ideal. Since X is simple, we have $XtX = X$.

Conversely, let P be an ideal and let $a \in P$. Then $X = XaX$, $XaX \subseteq XPX \subseteq P$ which implies $P = X$. Therefore X is simple. \square

Theorem 3.15. Suppose X is a semigroup. Then X is simple if and only every neutrosophic \aleph -interior ideal of X is a constant function.

Proof: Suppose X is simple and $s, t \in X$. Let X_N be neutrosophic \aleph -interior ideal. Then by Lemma 3.14, we get $X = XsX = XtX$. As $s \in XsX$, we have $s = atb$ for $a, b \in X$. Since X_N is neutrosophic \aleph -interior ideal, we have $T_N(s) = T_N(atb) \leq T_N(t)$, $I_N(s) = I_N(atb) \geq I_N(t)$ and $F_N(s) = F_N(atb) \leq F_N(t)$. Similarly, we can prove that $T_N(t) \leq T_N(s)$, $I_N(t) \geq I_N(s)$ and $F_N(t) \leq F_N(s)$. So X_N is a constant function.

Conversely, suppose X_N is neutrosophic \aleph -ideal. Then X_N is neutrosophic \aleph -interior ideal. By hypothesis, X_N is a constant function and so X_N is neutrosophic \aleph -simple. By Theorem 3.13, X is simple. \square

Theorem 3.16. Let X_M be neutrosophic \aleph -structure and let $\gamma, \delta, \epsilon \in [-1, 0]$ with $-3 \leq \gamma + \delta + \epsilon \leq 0$. If X_M is neutrosophic \aleph -interior ideal, then $(\gamma, \delta, \epsilon)$ -level set of X_M is neutrosophic \aleph -interior ideal whenever $X_M(\gamma, \delta, \epsilon) \neq \emptyset$.

Proof: Suppose $X_M(\gamma, \delta, \epsilon) \neq \emptyset$ for $\gamma, \delta, \epsilon \in [-1, 0]$ with $-3 \leq \gamma + \delta + \epsilon \leq 0$.

Let X_M be a neutrosophic \aleph -interior ideal and let $u, v, w \in X_M(\gamma, \delta, \epsilon)$. Then $T_M(uvw) \leq T_M(v) \leq \alpha$; $I_M(uvw) \geq I_M(v) \geq \beta$ and $F_M(uvw) \leq F_M(v) \leq \gamma$ which imply $uvw \in X_M(\alpha, \beta, \gamma)$. Therefore $X_M(\gamma, \delta, \epsilon)$ is a neutrosophic \aleph -interior ideal of X . \square

Theorem 3.17. Let X_N be neutrosophic \aleph -structure with $\alpha, \beta, \gamma \in [-1, 0]$ such that $-3 \leq \alpha + \beta + \gamma \leq 0$. If T_N^α , I_N^β and F_N^γ are interior ideals, then X_N is neutrosophic \aleph -interior ideal of X whenever it is non-empty.

Proof: Suppose that for $a, b, c \in X$ with $T_N(abc) > T_N(b)$. Then $T_N(abc) > t_\alpha \geq T_N(b)$ for some $t_\alpha \in [-1, 0)$. So $b \in T_N^{t_\alpha}(b)$ but $abc \notin T_N^{t_\alpha}(b)$, a contradiction. Thus $T_N(abc) \leq T_N(b)$.

Suppose that for $a, b, c \in X$ with $I_N(abc) < I_N(b)$. Then $I_N(abc) < t_\alpha \leq I_N(b)$ for some $t_\alpha \in [-1, 0)$. So $b \in I_N^{t_\alpha}(b)$ but $abc \notin I_N^{t_\alpha}(b)$, a contradiction. Thus $I_N(abc) \geq I_N(b)$.

Suppose that for $a, b, c \in X$ with $F_N(abc) > F_N(b)$. Then $F_N(abc) > t_\alpha \geq F_N(b)$ for some $t_\alpha \in [-1, 0)$. So $b \in F_N^{t_\alpha}(b)$ but $abc \notin F_N^{t_\alpha}(b)$, a contradiction. Thus $F_N(abc) \leq F_N(b)$.

Thus X_N is neutrosophic \aleph – interior ideal. □

Theorem 3.18. Let X_M be neutrosophic \aleph – structure over X . Then the equivalent assertions are:

- (i) X_M is neutrosophic \aleph –interior ideal,
- (ii) $X_N \odot X_M \odot X_N \subseteq X_M$ for any neutrosophic \aleph – structure X_N .

Proof: Suppose X_M is neutrosophic \aleph – interior ideal. Let $x \in X$. For any $u, v, w \in X$ such that $x = uvw$. Then $T_M(x) = T_M(uvw) \leq T_M(v) \leq T_N(u) \vee T_M(v) \vee T_N(w)$ which implies $T_M(x) \leq T_{N \circ M \circ N}(x)$. Otherwise $x \neq uvw$. Then $T_M(x) \leq 0 = T_{N \circ M \circ N}(x)$. Similarly, we can prove that $I_M(x) \geq I_{N \circ M \circ N}(x)$ and $F_M(x) \leq F_{N \circ M \circ N}(x)$. Thus $X_N \odot X_M \odot X_N \subseteq X_M$.

Conversely, assume that $X_N \odot X_M \odot X_N \subseteq X_M$ for any neutrosophic \aleph –structure X_N .

Let $u, v, w \in X$. If $x = uvw$, then

$$\begin{aligned} T_M(uvw) = T_M(x) &\leq (\chi_X(T)_N \circ T_M \circ \chi_X(T)_N)(x) = \bigwedge_{x=rw} \{ \chi_X(T)_N \circ T_M(r) \vee \chi_X(T)_N(w) \} \\ &= \bigwedge_{x=rc} \{ \bigwedge_{r=uv} \{ \chi_X(T)_N(u) \vee (T)_M(v) \} \vee \chi_X(T)_N(w) \} \\ &\leq \chi_X(T)_N(u) \vee (T)_M(v) \vee \chi_X(T)_N(w) = T_M(v), \end{aligned}$$

$$\begin{aligned} I_M(uvw) = I_M(x) &\leq (\chi_X(I)_N \circ I_M \circ \chi_X(I)_N)(x) = \bigvee_{x=rw} \{ \chi_X(I)_N \circ I_M(r) \wedge \chi_X(I)_N(w) \} \\ &= \bigvee_{x=rc} \{ \bigvee_{r=uv} \{ \chi_X(I)_N(u) \wedge (I)_M(v) \} \wedge \chi_X(I)_N(w) \} \\ &\geq \chi_X(I)_N(u) \wedge (I)_M(v) \wedge \chi_X(I)_N(w) = (I)_M(v), \end{aligned}$$

and

$$\begin{aligned} F_M(uvw) = F_M(x) &\leq (\chi_X(F)_N \circ F_M \circ \chi_X(F)_N)(x) = \bigwedge_{x=rw} \{ \chi_X(F)_N \circ F_M(r) \vee \chi_X(F)_N(w) \} \\ &= \bigwedge_{x=rc} \{ \bigwedge_{r=uv} \{ \chi_X(F)_N(u) \vee (F)_M(v) \} \vee \chi_X(F)_N(w) \} \\ &\leq \chi_X(F)_N(u) \vee (F)_M(v) \vee \chi_X(F)_N(w) = F_M(v). \end{aligned}$$

Therefore X_M is neutrosophic \aleph –interior ideal. □

Notation 3.19. Let X and Z be semigroups. A mapping $g: X \rightarrow Z$ is said to be a homomorphism if $g(uv) = g(u)g(v)$ for all $u, v \in X$. Throughout this remaining section, we denote $Aut(X)$, the set of all automorphisms of X .

Definition 3.20. An interior ideal J of a semigroup X is called a characteristic interior ideal if $h(J) = J$ for all $h \in Aut(X)$.

Definition 3.21. Let X be a semigroup. A neutrosophic \aleph -interior ideal X_N is called neutrosophic \aleph -characteristic interior ideal if $T_N(h(u)) = T_N(u)$, $I_N(h(u)) = I_N(u)$ and $F_N(h(u)) = F_N(u)$ for all $u \in X$ and all $h \in \text{Aut}(X)$.

Theorem 3.22. For any $L \subseteq X$, the equivalent assertions are:

- (i) L is characteristic interior ideal,
- (ii) The characteristic neutrosophic \aleph -structure $\chi_L(X_M)$ is neutrosophic \aleph -characteristic interior ideal.

Proof: Suppose L is characteristic interior ideal and let $x \in X$. Then by Theorem 3.1, $\chi_L(X_M)$ is neutrosophic \aleph -interior ideal. If $x \in L$, then $\chi_L(T)_M(x) = -1$, $\chi_L(I)_M(x) = 0$, and $\chi_L(F)_M(x) = -1$. Now, for any $h \in \text{Aut}(X)$, $h(x) \in h(L) = L$ which implies $\chi_L(T)_M(h(x)) = -1$, $\chi_L(I)_M(h(x)) = 0$, and $\chi_L(F)_M(h(x)) = -1$. If $x \notin L$, then $\chi_L(T)_M(x) = 0$, $\chi_L(I)_M(x) = -1$, and $\chi_L(F)_M(x) = 0$. Now, for any $h \in \text{Aut}(X)$, $h(x) \notin h(L)$ which implies $\chi_L(T)_M(h(x)) = 0$, $\chi_L(I)_M(h(x)) = -1$, and $\chi_L(F)_M(h(x)) = 0$. Thus $\chi_L(T)_M(h(x)) = \chi_L(T)_M(x)$, $\chi_L(I)_M(h(x)) = \chi_L(I)_M(x)$, and $\chi_L(F)_M(h(x)) = \chi_L(F)_M(x)$ for all $x \in X$ and hence $\chi_L(X_M)$ is neutrosophic \aleph -characteristic interior ideal.

Conversely, assume that $\chi_L(X_M)$ is neutrosophic \aleph -characteristic interior ideal. Then by Theorem 3.1, L is an interior ideal. Now, let $h \in \text{Aut}(X)$ and $x \in L$. Then $\chi_L(T)_M(x) = -1$, $\chi_L(I)_M(x) = 0$ and $\chi_L(F)_M(x) = -1$. Since $\chi_L(X_M)$ is neutrosophic \aleph -characteristic interior ideal, we have $\chi_L(T)_M(h(x)) = \chi_L(T)_M(x)$, $\chi_L(I)_M(h(x)) = \chi_L(I)_M(x)$ and $\chi_L(F)_M(h(x)) = \chi_L(F)_M(x)$ which imply $h(x) \in L$. So $h(L) \subseteq L$ for all $h \in \text{Aut}(X)$. Again, since $h \in \text{Aut}(X)$ and $x \in L$, there exists $y \in L$ such that $h(y) = x$.

Suppose that $y \notin L$. Then $\chi_L(T)_M(y) = 0$, $\chi_L(I)_M(y) = -1$ and $\chi_L(F)_M(y) = 0$. Since $\chi_L(T)_M(h(y)) = \chi_L(T)_M(y)$, $\chi_L(I)_M(h(y)) = \chi_L(I)_M(y)$ and $\chi_L(F)_M(h(y)) = \chi_L(F)_M(y)$, we get $\chi_L(T)_M(h(y)) = 0$, $\chi_L(I)_M(h(y)) = -1$ and $\chi_L(F)_M(h(y)) = 0$ which imply $h(y) \notin L$, a contradiction. So $y \in L$ i.e., $h(y) \in L$. Thus $L \subseteq h(L)$ for all $h \in \text{Aut}(X)$ and hence L is characteristic interior ideal. □

Theorem 3.23. For a semigroup X , the equivalent statements are:

- (i) X is intra-regular,
- (ii) For any neutrosophic \aleph -interior ideal X_M , we have $X_M(w) = X_M(w^2)$ for all $w \in X$.

Proof: (i) \Rightarrow (ii) Suppose X is intra-regular, and X_M is neutrosophic \aleph -interior ideal and $w \in X$. Then there exist $r, s \in X$ such that $w = rw^2s$. Now $T_M(w) = T_M(rw^2s) \leq T_M(w^2) \leq T_M(w)$ and so $T_M(w) = T_M(w^2)$, $I_M(w) = I_M(rw^2s) \geq I_M(w^2) \geq I_M(w)$ and so $I_M(w) = I_M(w^2)$, and $F_M(w) = F_M(rw^2s) \leq F_M(w^2) \leq F_M(w)$ and so $F_M(w) = F_M(w^2)$. Therefore $X_M(w) = X_M(w^2)$ for all $w \in X$.

(ii) \Rightarrow (i) Let (ii) holds and $s \in X$. Then $I(s^2)$ is an ideal of X . By Theorem 3.5 of [4], $\chi_{I(s^2)}(X_M)$ is neutrosophic \aleph -ideal. By assumption, $\chi_{I(s^2)}(X_M)(s) = \chi_{I(s^2)}(X_M)(s^2)$. Since $\chi_{I(s^2)}(T)_M(s^2) = -1 = \chi_{I(s^2)}(F)_M(s^2)$ and $\chi_{I(s^2)}(I)_M(s^2) = 0$, we get $\chi_{I(s^2)}(T)_M(s) = -1 = \chi_{I(s^2)}(F)_M(s)$ and $\chi_{I(s^2)}(I)_M(s) = 0$ which imply $s \in I(s^2)$. Hence X is intra-regular. □

Theorem 3.24. For a semigroup X , the equivalent statements are:

- (i) X is left (resp., right) regular,

(ii) For any neutrosophic \mathfrak{N} -interior ideal X_M , we have $X_M(w) = X_M(w^2)$ for all $w \in X$.

Proof: (i) \Rightarrow (ii) Let X be left regular. Then there exists $y \in X$ such that $w = yw^2$. Let X_M be a neutrosophic \mathfrak{N} -interior ideal. Then $T_M(w) = T_M(yw^2) \leq T_M(w)$ and so $T_M(w) = T_M(w^2)$, $I_M(w) = I_M(yw^2) \geq I_M(w)$ and so $I_M(w) = I_M(w^2)$, and $F_M(w) = F_M(yw^2) \leq F_M(w)$ and so $F_M(w) = F_M(w^2)$. Therefore $X_M(w) = X_M(w^2)$ for all $w \in X$.

(ii) \Rightarrow (i) Suppose (ii) holds and let X_M be neutrosophic \mathfrak{N} -interior ideal. Then for any $w \in X$, $\chi_{L(w^2)}(T)_M(w) = \chi_{L(w^2)}(T)_M(w^2) = -1$, $\chi_{L(w^2)}(I)_M(w) = \chi_{L(w^2)}(I)_M(w^2) = 0$ and $\chi_{L(w^2)}(F)_M(w) = \chi_{L(w^2)}(F)_M(w^2) = -1$ which imply $w \in L(w^2)$. Thus X is left regular. \square

Conclusions

In this paper, we have introduced the concepts of neutrosophic \mathfrak{N} -interior ideals and neutrosophic \mathfrak{N} -characteristic interior ideals in semigroups and studied their properties, and characterized regular and intra-regular semigroups using neutrosophic \mathfrak{N} -interior ideal structures. We have also shown that R is a characteristic interior ideal if and only if the characteristic neutrosophic \mathfrak{N} -structure $\chi_R(X_N)$ is neutrosophic \mathfrak{N} -characteristic interior ideal. In future, we will define neutrosophic \mathfrak{N} -prime ideals in semigroups and study their properties.

Reference

1. Atanassov, K. T. Intuitionistic fuzzy sets. *Fuzzy Sets and Systems* **1986**, 20, 87-96.
2. Abdel-Basset, M., Ali, M., & Atef, A. Uncertainty assessments of linear time-cost tradeoffs using neutrosophic set. *Computers & Industrial Engineering* **2020**, 141, 106286.
3. Abdel-Basset, M., Ali, M., & Atef, A. Resource levelling problem in construction projects under neutrosophic environment. *The Journal of Supercomputing* **2020**, 76(2), 964-988.
4. Abdel-Baset, M.; Chang, V.; Gamal, A.; Smarandache, F. An integrated neutrosophic ANP and VIKOR method for achieving sustainable supplier selection: A case study in importing field. *Computers in Industry* **2019**, 106, 94-110.
5. Abdel-Basset, M., Gamal, A., Son, L. H., & Smarandache, F. A Bipolar Neutrosophic Multi Criteria Decision Making Framework for Professional Selection. *Applied Sciences* **2020**, 10(4), 1202.
6. Abdel-Basset, M., Mohamed, R., Elhoseny, M., & Chang, V. Evaluation framework for smart disaster response systems in uncertainty environment. *Mechanical Systems and Signal Processing* **2020**, 145, 106941.
7. Abdel-Basset, M., Mohamed, R., Zaied, A. E. N. H., Gamal, A., & Smarandache, F. Solving the supply chain problem using the best-worst method based on a novel Plithogenic model. In *Optimization Theory Based on Neutrosophic and Plithogenic Sets*, Academic Press **2020**, 1-19.
8. Abdel-Basset, M.; Saleh, M.; Gamal, A.; Smarandache, F. An approach of TOPSIS technique for developing supplier selection with group decision making under type-2 neutrosophic number. *Applied Soft Computing* **2019**, 77, 438-452.
9. Chalapathi, T; Madhavi, L. Neutrosophic Boolean rings. *Neutrosophic Sets and Systems* **2020**, 33, 59-66.
10. Elavarasan, B.; Smarandache, F.; Jun, Y. B. Neutrosophic \mathfrak{N} -ideals in semigroups. *Neutrosophic Sets and Systems* **2019**, 28, 273-280.
11. Gulistan, M.; Khan, A.; Abdullah, A.; Yaqoob, N. Complex Neutrosophic subsemigroups and ideals. *International J. Analysis and Applications* **2018**, 16, 97-116.

12. Jun, Y. B.; Smarandache, F.; Ozturk, M. A. Commutative falling neutrosophic ideals in BCK-algebras. *Neutrosophic Sets and Systems* **2018**, 20, 44-53.
13. Kehayopulu, N. A note on strongly regular ordered semigroups. *Sci. Math.* **1998**, 1, 33-36.
14. Khan, M. S.; Anis; Smarandache, F.; Jun, Y. B. Neutrosophic \aleph –structures and their applications in semigroups. *Annals of Fuzzy Mathematics and Informatics* **2017**, 14(6), 583–598.
15. Mordeson, J.N.; Malik, D. S.; Kuroki, N. Regular semigroups. *Fuzzy Smigroups* **2003**, 59-100.
16. Muhiuddin, G.; Ahmad, N.; Al-Kenani; Roh, E. H.; Jun, Y. B. Implicative neutrosophic quadruple BCK-algebras and ideals. *Symmetry* **2019**, 11, 277.
17. Muhiuddin, G.; Bordbar, H.; Smarandache, F.; Jun, Y. B. Further results on (2;2)-neutrosophic subalgebras and ideals in BCK/BCI- algebras. *Neutrosophic Sets and Systems* **2018**, Vol. 20, 36-43.
18. Muhiuddin, G.; Kim, S. J.; Jun, Y. B. Implicative N-ideals of BCK-algebras based on neutrosophic N-structures. *Discrete Mathematics, Algorithms and Applications* **2019**, Vol. 11, No. 01, 1950011.
19. Muhiuddin, G.; Smarandache, F.; Jun, Y. B. Neutrosophic quadruple ideals in neutrosophic quadruple BCI-algebras. *Neutrosophic Sets and Systems* **2019**, 25, 161-173.
20. Porselvi, K., Elavarasan, B.; Smarandache, F.; Jun, Y. B. Neutrosophic \aleph – bi –ideals in semigroups. *Neutrosophic Sets and Systems* **2020**, 35, 422-434.
21. Prakasam Muralikrishna.; Surya Manokaran. MBJ – Neutrosophic β – Ideal of β – Algebra. *Neutrosophic Sets and Systems* **2020**, 35, 99-118.
22. Smarandache, F. A. Unifying Field in Logics: Neutrosophic Logic. Neutrosophy, Neutrosophic Set, Neutrosophic Probability. *American Research Press* **1999**, Rehoboth, NM.
23. Smarandache, F. Neutrosophic set-a generalization of the intuitionistic fuzzy set. *Int. J. Pure Appl. Math.* **2005**, 24(3), 287-297.
24. Zadeh, L. A. Fuzzy sets. *Information and Control* **1965**, 8, 338 - 353.

NeuroOrderedAlgebra: Applications to Semigroups

Madeleine Al-Tahan, F. Smarandache, Bijan Davvaz

Madeleine Al-Tahan, F. Smarandache, Bijan Davvaz (2020). NeuroOrderedAlgebra: Applications to Semigroups. *Neutrosophic Sets and Systems* 39, 133-147

Abstract. Starting with a partial order on a NeuroAlgebra, we get a NeuroStructure. The latter if it satisfies the conditions of NeuroOrder, it becomes a NeuroOrderedAlgebra. In this paper, we apply our new defined notion to semigroups by studying NeuroOrderedSemigroups. More precisely, we define some related terms like NeutrosOrderedSemigroup, NeuroOrderedIdeal, NeuroOrderedFilter, NeuroOrderedHomomorphism, etc., illustrate them via some examples, and study some of their properties.

Keywords: NeuroAlgebra, NeuroSemigroup, NeuroOrderedAlgebra, NeutrosOrderedSemigroup, NeuroOrderedIdeal, NeuroOrderedFilter, NeuroOrderedHomomorphism, NeuroOrderedStrongHomomorphism.

1. Introduction

Neutrosophy, the study of neutralities, is a new branch of Philosophy initiated by Smarandache in 1995. It has many applications in almost every field. Many algebraists worked on the connection between neutrosophy and algebraic structures. For more details, we refer to [1–3]. Unlike the idealistic or abstract algebraic structures, from pure mathematics, constructed on a given perfect space (set), where the axioms (laws, rules, theorems, results etc.) are totally (100%) true for all spaces elements, our world and reality consist of approximations, imperfections, vagueness, and partialities. Starting from the latter idea, Smarandache introduced NeuroAlgebra. In 2019 and 2020, he [11–13] generalized the classical Algebraic Structures to NeuroAlgebraic Structures (or NeuroAlgebras) whose operations and axioms are partially true, partially indeterminate, and partially false as extensions of Partial Algebra, and to AntiAlgebraic Structures (or AntiAlgebras) whose operations and axioms are totally false. And in general, he extended any classical Structure, in no matter what field of knowledge, to a

NeutroStructure and an AntiStructure. A Partial Algebra is an algebra that has at least one Partial Operation, and all its Axioms are classical. Through a theorem, Smarandache [11] proved that a NeutroAlgebra is a generalization of Partial Algebra and gave some examples of NeutroAlgebras that are not Partial Algebras. Many researchers worked on special types of NeutroAlgebras and AntiAlgebras by applying them to different types of algebraic structures such as groups, rings, *BE*-Algebras, *BCK*-Algebras, etc. For more details, we refer to [4–6, 9, 10, 14, 15].

Inspired by NeutroAlgebra and ordered Algebra, our paper introduces and studies NeutroOrderedAlgebra. And it is constructed as follows: After an Introduction, in Section 2, we introduce NeutroOrderedAlgebra and some related terms such as NeutroOrderedSubAlgebra and NeutroOrderedHomomorphism. And in Section 3, we apply the concept of NeutroOrderedAlgebra to semigroups and study NeutroOrderedSemigroups by presenting several examples and studying some of their interesting properties.

2. NeutroOrderedAlgebra

In this section, we combine the notions of ordered algebraic structures and NeutroAlgebra to introduce *NeutroOrderedAlgebra*. Some new definitions related to the new concept are presented. For details about ordered algebraic structures, we refer to [7, 8].

Definition 2.1. [11] A non-empty set A endowed with n operations “ \star_i ” for $i = 1, \dots, n$, is called *NeutroAlgebra* if it has at least one NeutroOperation or at least one NeutroAxiom with no AntiOperations nor AntiAxioms.

Definition 2.2. [8] Let A be an Algebra with n operations “ \star_i ” and “ \leq ” be a partial order (reflexive, anti-symmetric, and transitive) on A . Then $(A, \star_1, \dots, \star_n, \leq)$ is an Ordered Algebra if the following conditions hold.

If $x \leq y \in A$ then $z \star_i x \leq z \star_i y$ and $x \star_i z \leq y \star_i z$ for all $i = 1, \dots, n$ and $z \in A$.

Definition 2.3. Let A be a NeutroAlgebra with n (Neutro) operations “ \star_i ” and “ \leq ” be a partial order (reflexive, anti-symmetric, and transitive) on A . Then $(A, \star_1, \dots, \star_n, \leq)$ is a *NeutroOrderedAlgebra* if the following conditions hold.

- (1) There exist $x \leq y \in A$ with $x \neq y$ such that $z \star_i x \leq z \star_i y$ and $x \star_i z \leq y \star_i z$ for all $z \in A$ and $i = 1, \dots, n$. (This condition is called degree of truth, “ T ”.)
- (2) There exist $x \leq y \in A$ and $z \in A$ such that $z \star_i x \not\leq z \star_i y$ or $x \star_i z \not\leq y \star_i z$ for some $i = 1, \dots, n$. (This condition is called degree of falsity, “ F ”.)
- (3) There exist $x \leq y \in A$ and $z \in A$ such that $z \star_i x$ or $z \star_i y$ or $x \star_i z$ or $y \star_i z$ are indeterminate, or the relation between $z \star_i x$ and $z \star_i y$, or the relation between $x \star_i z$

and $y \star_i z$ are indeterminate for some $i = 1, \dots, n$. (This condition is called degree of indeterminacy, “ I ”.)

Where (T, I, F) is different from $(1, 0, 0)$ that represents the classical Ordered Algebra as well from $(0, 0, 1)$ that represents the AntiOrderedAlgebra.

Definition 2.4. Let $(A, \star_1, \dots, \star_n, \leq)$ be a NeutroOrderedAlgebra. If “ \leq ” is a total order on A then A is called *NeutroTotalOrderedAlgebra*.

Definition 2.5. Let $(A, \star_1, \dots, \star_n, \leq_A)$ be a NeutroOrderedAlgebra and $\emptyset \neq S \subseteq A$. Then S is a *NeutroOrderedSubAlgebra* of A if $(S, \star_1, \dots, \star_n, \leq_A)$ is a NeutroOrderedAlgebra and there exists $x \in S$ with $[x] = \{y \in A : y \leq_A x\} \subseteq S$.

Remark 2.6. A NeutroOrderedAlgebra has at least one NeutroOrderedSubAlgebra which is itself.

Definition 2.7. Let $(A, \star_1, \dots, \star_n, \leq_A)$ and $(B, \otimes_1, \dots, \otimes_n, \leq_B)$ be NeutroOrderedAlgebras and $\phi : A \rightarrow B$ be a function. Then

- (1) ϕ is called *NeutroOrderedHomomorphism* if there exist $x, y \in A$ such that for all $i = 1, \dots, n$, $\phi(x \star_i y) = \phi(x) \otimes_i \phi(y)$, and there exist $a \leq_A b \in A$ with $a \neq b$ such that $\phi(a) \leq_B \phi(b)$.
- (2) ϕ is called *NeutroOrderedIsomomorphism* if ϕ is a bijective NeutroOrderedHomomorphism. In this case, we write $A \cong_I B$.
- (3) ϕ is called *NeutroOrderedStrongHomomorphism* if for all $x, y \in A$ and for all $i = 1, \dots, n$, we have $\phi(x \star_i y) = \phi(x) \otimes_i \phi(y)$ and $a \leq_A b \in A$ is equivalent to $\phi(a) \leq_B \phi(b)$ for all $a, b \in A$.
- (4) ϕ is called *NeutroOrderedStrongIsomomorphism* if ϕ is a bijective NeutroOrderedStrongHomomorphism. In this case, we write $A \cong_{SI} B$.

Example 2.8. Let $(A, \star_1, \dots, \star_n, \leq_A)$ be a NeutroOrderedAlgebra, B a NeutroOrderedSubAlgebra of A , and $\phi : B \rightarrow A$ be the inclusion map ($\phi(x) = x$ for all $x \in B$). Then ϕ is a NeutroOrderedStrongHomomorphism.

Example 2.9. Let $(A, \star_1, \dots, \star_n, \leq_A)$ be a NeutroOrderedAlgebra and $\phi : A \rightarrow A$ be the identity map ($\phi(x) = x$ for all $x \in A$). Then ϕ is a NeutroOrderedStrongIsomomorphism.

Remark 2.10. Every NeutroOrderedStrongHomomorphism (NeutroOrderedStrongIsomorphism) is a NeutroOrderedHomomorphism (NeutroOrderedIsomorphism).

Theorem 2.11. *The relation “ \cong_{SI} ” is an equivalence relation on the set of NeutroOrderedAlgebras.*

Proof. By taking the identity map and using Example 2.9, we can easily prove that “ \cong_{SI} ” is a reflexive relation. Let $A \cong_{SI} B$. Then there exist a NeutroOrderedStrongIsomorphism $\phi : (A, \star_1, \dots, \star_n, \leq_A) \rightarrow (B, \otimes_1, \dots, \otimes_n, \leq_B)$. We prove that $\phi^{-1} : B \rightarrow A$ is a Neutro-OrderedStrongIsomorphism. For all $b_1, b_2 \in B$, there exist $a_1, a_2 \in A$ with $\phi(a_1) = b_1$ and $\phi(a_2) = b_2$. For all $i = 1, \dots, n$, we have:

$$\phi^{-1}(b_1 \otimes_i b_2) = \phi^{-1}(\phi(a_1) \otimes_i \phi(a_2)) = \phi^{-1}(\phi(a_1 \star_i a_2)) = a_1 \star_i a_2 = \phi^{-1}(b_1) \star_i \phi^{-1}(b_2).$$

Moreover, having $a_1 \leq_A a_2 \in A$ equivalent to $\phi(a_1) \leq_B \phi(a_2) \in B$ and ϕ an onto function implies that $b_1 = \phi(a_1) \leq_B \phi(a_2) = b_2 \in B$ is equivalent to $a_1 = \phi^{-1}(b_1) \leq_A a_2 = \phi^{-1}(b_2) \in A$. Thus, $B \cong_{SI} A$ and hence, “ \cong_{SI} ” is a symmetric relation. Let $A \cong_{SI} B$ and $B \cong_{SI} C$. Then there exist NeutroOrderedStrongIsomorphisms $\phi : A \rightarrow B$ and $\psi : B \rightarrow C$. One can easily see that $\psi \circ \phi : A \rightarrow C$ is a NeutroOrderedStrongIsomorphism. Thus, $A \cong_{SI} C$ and hence, “ \cong_{SI} ” is a transitive relation. \square

Remark 2.12. The relation “ \cong_I ” is a reflexive and symmetric relation on the set of Neutro-OrderedAlgebras. But it may fail to be a transitive relation.

3. NeutroOrderedSemigroup

In this section, we use the defined notion of NeutroOrderedAlgebra in Section 2 and apply it to semigroups. As a result, we define NeutroOrderedSemigroup and other related concepts. Moreover, we present some examples of finite as well as infinite NeutroOrderedSemigroups. Finally, we study some properties of NeutroOrderedSubSemigroups, NeutroOrderedIdeals, and NeutroOrderedFilters.

Definition 3.1. [8] Let (S, \cdot) be a semigroup (“ \cdot ” is an associative and a binary closed operation) and “ \leq ” a partial order on S . Then (S, \cdot, \leq) is an *ordered semigroup* if for every $x \leq y \in S$, $z \cdot x \leq z \cdot y$ and $x \cdot z \leq y \cdot z$ for all $z \in S$.

Definition 3.2. [8] Let (S, \cdot, \leq) be an ordered semigroup and $\emptyset \neq M \subseteq S$. Then

- (1) M is an *ordered subsemigroup* of S if (M, \cdot, \leq) is an ordered semigroup and $[x] \subseteq M$ for all $x \in M$. i.e., if $y \leq x$ then $y \in M$.
- (2) M is an *ordered left ideal* of S if M is an ordered subsemigroup of S and for all $x \in M$, $r \in S$, we have $rx \in M$.
- (3) M is an *ordered right ideal* of S if M is an ordered subsemigroup of S and for all $x \in M$, $r \in S$, we have $xr \in M$.
- (4) M is an *ordered ideal* of S if M is both: an ordered left ideal of S and an ordered right ideal of S .

- (5) M is an *ordered filter* of S if (M, \cdot) is a semigroup and for all $x, y \in S$ with $x \cdot y \in M$, we have $x, y \in M$ and $[y] \subseteq M$ for all $y \in M$. i.e., if $y \in M$ with $y \leq x$ then $x \in M$.

Definition 3.3. Let (S, \cdot) be a NeutroSemigroup and “ \leq ” be a partial order (reflexive, anti-symmetric, and transitive) on S . Then (S, \cdot, \leq) is a *NeutroOrderedSemigroup* if the following conditions hold.

- (1) There exist $x \leq y \in S$ with $x \neq y$ such that $z \cdot x \leq z \cdot y$ and $x \cdot z \leq y \cdot z$ for all $z \in S$. (This condition is called degree of truth, “ T ”.)
- (2) There exist $x \leq y \in S$ and $z \in S$ such that $z \cdot x \not\leq z \cdot y$ or $x \cdot z \not\leq y \cdot z$. (This condition is called degree of falsity, “ F ”.)
- (3) There exist $x \leq y \in S$ and $z \in S$ such that $z \cdot x$ or $z \cdot y$ or $x \cdot z$ or $y \cdot z$ are indeterminate, or the relation between $z \cdot x$ and $z \cdot y$, or the relation between $x \cdot z$ and $y \cdot z$ are indeterminate. (This condition is called degree of indeterminacy, “ I ”.)

Where (T, I, F) is different from $(1, 0, 0)$ that represents the classical Ordered Semigroup, and from $(0, 0, 1)$ that represents the AntiOrderedSemigroup.

Definition 3.4. Let (S, \cdot, \leq) be a NeutroOrderedSemigroup . If “ \leq ” is a total order on A then A is called *NeutroTotalOrderedSemigroup*.

Definition 3.5. Let (S, \cdot, \leq) be a NeutroOrderedSemigroup and $\emptyset \neq M \subseteq S$. Then

- (1) M is a *NeutroOrderedSubSemigroup* of S if (M, \cdot, \leq) is a NeutroOrderedSemigroup and there exist $x \in M$ with $[x] = \{y \in S : y \leq x\} \subseteq M$.
- (2) M is a *NeutroOrderedLeftIdeal* of S if M is a NeutroOrderedSubSemigroup of S and there exists $x \in M$ such that $r \cdot x \in M$ for all $r \in S$.
- (3) M is a *NeutroOrderedRightIdeal* of S if M is a NeutroOrderedSubSemigroup of S and there exists $x \in M$ such that $x \cdot r \in M$ for all $r \in S$.
- (4) M is a *NeutroOrderedIdeal* of S if M is a NeutroOrderedSubSemigroup of S and there exists $x \in M$ such that $r \cdot x \in M$ and $x \cdot r \in M$ for all $r \in S$.
- (5) M is a *NeutroOrderedFilter* of S if (M, \cdot, \leq) is a NeutroOrderedSemigroup and there exists $x \in S$ such that for all $y, z \in S$ with $x \cdot y \in M$ and $z \cdot x \in M$, we have $y, z \in M$ and there exists $y \in M$ $[y] = \{x \in S : y \leq x\} \subseteq M$.

Proposition 3.6. Let (S, \cdot, \leq) be a NeutroOrderedSemigroup and $\emptyset \neq M \subseteq S$. Then the following statements are true.

- (1) If S contains a minimum element (i.e. there exists $m \in S$ such that $m \leq x$ for all $x \in S$.) and M is a NeutroOrderedSubSemigroup (or NeutroOrderedRightIdeal or NeutroOrderedLeftIdeal or NeutroOrderedIdeal) of S then the minimum element is in M .

- (2) If S contains a maximum element (i.e. there exists $n \in S$ such that $x \leq n$ for all $x \in S$.) and M is a *NeutroOrderedFilter* of S then M contains the maximum element of S .

Proof. The proof is straightforward. \square

Remark 3.7. Let (S, \cdot, \leq) be a *NeutroOrderedSemigroup*. Then every *NeutroOrderedIdeal* of S is *NeutroOrderedLeftIdeal* of S and a *NeutroOrderedRightIdeal* of S . But the converse may not hold. (See Example 3.16.)

Definition 3.8. Let (A, \star, \leq_A) and (B, \otimes, \leq_B) be *NeutroOrderedSemigroups* and $\phi : A \rightarrow B$ be a function. Then

- (1) ϕ is called *NeutroOrderedHomomorphism* if $\phi(x \star y) = \phi(x) \otimes \phi(y)$ for some $x, y \in A$ and there exist $a \leq_A b \in A$ with $a \neq b$ such that $\phi(a) \leq_B \phi(b)$.
- (2) ϕ is called *NeutroOrderedIsomomorphism* if ϕ is a bijective *NeutroOrderedHomomorphism*.
- (3) ϕ is called *NeutroOrderedStrongHomomorphism* if $\phi(x \star y) = \phi(x) \otimes \phi(y)$ for all $x, y \in A$ and $a \leq_A b \in A$ is equivalent to $\phi(a) \leq_B \phi(b) \in B$.
- (4) ϕ is called *NeutroOrderedStrongIsomomorphism* if ϕ is a bijective *NeutroOrdered-StrongHomomorphism*.

Example 3.9. Let $S_1 = \{s, a, m\}$ and (S_1, \cdot_1) be defined by the following table.

\cdot_1	s	a	m
s	s	m	s
a	m	a	m
m	m	m	m

Since $s \cdot_1 (s \cdot_1 s) = s = (s \cdot_1 s) \cdot_1 s$ and $s \cdot_1 (a \cdot_1 m) = s \neq m = (s \cdot_1 a) \cdot_1 m$, it follows that (S_1, \cdot_1) is a *NeutroSemigroup*.

By defining the total order

$$\leq_1 = \{(m, m), (m, s), (m, a), (s, s), (s, a), (a, a)\}$$

on S_1 , we get that (S_1, \cdot_1, \leq_1) is a *NeutroTotalOrderedSemigroup*. This is easily seen as: $m \leq_1 s$ implies that $m \cdot_1 x \leq_1 s \cdot_1 x$ and $x \cdot_1 m \leq_1 x \cdot_1 s$ for all $x \in S_1$. And having $s \leq_1 a$ but $s \cdot_1 s = s \not\leq_1 m = a \cdot_1 s$.

Example 3.10. Let $S_2 = \{0, 1, 2, 3\}$ and (S_2, \cdot_2) be defined by the following table.

\cdot_2	0	1	2	3
0	0	0	0	3
1	0	1	1	3
2	0	3	2	2
3	3	3	3	3

Since $0 \cdot_2 (0 \cdot_2 0) = 0 = (0 \cdot_2 0) \cdot_2 0$ and $1 \cdot_2 (2 \cdot_2 3) = 1 \neq 3 = (1 \cdot_2 2) \cdot_2 3$, it follows that (S_2, \cdot_2) is a NeutroSemigroup.

By defining the total order

$$\leq_2 = \{(0, 0), (0, 1), (0, 2), (0, 3), (1, 1), (1, 2), (1, 3), (2, 2), (2, 3), (3, 3)\}$$

on S_2 , we get that (S_2, \cdot_2, \leq_2) is a NeutroTotalOrderedSemigroup. This is easily seen as: $0 \leq_2 3$ implies that $0 \cdot_2 x \leq_2 3 \cdot_2 x$ and $x \cdot_2 0 \leq_2 x \cdot_2 3$ for all $x \in S_2$. And having $1 \leq_2 2$ but $2 \cdot_2 1 = 3 \not\leq_2 2 = 2 \cdot_2 2$.

We present examples on NeutroOrderedSemigroups that are not NeutroTotalOrderedSemigroups.

Example 3.11. Let $S_2 = \{0, 1, 2, 3\}$ and (S_2, \cdot'_2) be defined by the following table.

\cdot'_2	0	1	2	3
0	0	0	0	0
1	0	1	1	1
2	0	1	3	2
3	0	1	3	2

Since $0 \cdot'_2 (0 \cdot'_2 0) = 0 = (0 \cdot'_2 0) \cdot'_2 0$ and $2 \cdot'_2 (2 \cdot'_2 3) = 3 \neq 2 = (2 \cdot'_2 2) \cdot'_2 3$, it follows that (S_2, \cdot'_2) is a NeutroSemigroup.

By defining the partial order (which is not a total order)

$$\leq'_2 = \{(0, 0), (0, 1), (0, 2), (1, 1), (2, 2), (3, 3)\}$$

on S_2 , we get that (S_2, \cdot'_2, \leq'_2) is a NeutroOrderedSemigroup (that is not a NeutroTotalOrderedSemigroup). This is easily seen as:

$0 \leq'_2 1$ implies that $0 \cdot'_2 x = x \cdot'_2 0 = 0 \leq'_2 1 = 1 \cdot'_2 x = x \cdot'_2 1$. And having $0 \leq'_2 2$ but $2 \cdot'_2 0 = 0 \not\leq'_2 3 = 2 \cdot'_2 2$.

Example 3.12. Let $S_3 = \{0, 1, 2, 3, 4\}$ and (S_3, \cdot_3) be defined by the following table.

\cdot_3	0	1	2	3	4
0	0	0	0	3	0
1	0	1	2	1	1
2	0	4	2	3	3
3	0	4	2	3	3
4	0	0	0	4	0

Since $0 \cdot_3 (0 \cdot_3 0) = 0 = (0 \cdot_3 0) \cdot_3 0$ and $1 \cdot_3 (2 \cdot_3 1) = 1 \neq 4 = (1 \cdot_3 2) \cdot_3 1$, it follows that (S_3, \cdot_3) is a NeutroSemigroup.

By defining the partial order

$$\leq_3 = \{(0, 0), (0, 1), (0, 3), (0, 4), (1, 1), (1, 3), (1, 4), (2, 2), (3, 3), (3, 4), (4, 4)\}$$

on S_3 , we get that (S_3, \cdot_3, \leq_3) is a NeutroOrderedSemigroup that is not NeutroTotalOrderedSemigroup as “ \leq_3 ” is not a total order on S_3 . This is easily seen as:

$0 \leq_3 4$ implies that $0 \cdot_3 x \leq_3 4 \cdot_3 x$ and $x \cdot_3 0 \leq_3 x \cdot_3 4$ for all $x \in S_3$. And having $0 \leq_3 1$ but $0 \cdot_3 2 = 0 \not\leq_3 2 = 1 \cdot_3 2$.

Example 3.13. Let \mathbb{Z} be the set of integers and define “ \odot ” on \mathbb{Z} as follows: $x \odot y = xy - 1$ for all $x, y \in \mathbb{Z}$. Since $0 \odot (1 \odot 0) = -1 = (0 \odot 1) \odot 0$ and $0 \odot (1 \odot 2) = -1 \neq -3 = (0 \odot 1) \odot 2$, it follows that (\mathbb{Z}, \odot) is a NeutroSemigroup. We define the partial order “ $\leq_{\mathbb{Z}}$ ” on \mathbb{Z} as $-1 \leq_{\mathbb{Z}} x$ for all $x \in \mathbb{Z}$ and for $a, b \geq 0$, $a \leq_{\mathbb{Z}} b$ is equivalent to $a \leq b$ and for $a, b < 0$, $a \leq_{\mathbb{Z}} b$ is equivalent to $a \geq b$. In this way, we get $-1 \leq_{\mathbb{Z}} 0 \leq_{\mathbb{Z}} 1 \leq_{\mathbb{Z}} 2 \leq_{\mathbb{Z}} \dots$ and $-1 \leq_{\mathbb{Z}} -2 \leq_{\mathbb{Z}} -3 \leq_{\mathbb{Z}} \dots$. Having $0 \leq_{\mathbb{Z}} 1$ and $x \odot 0 = 0 \odot x = -1 \leq_{\mathbb{Z}} x - 1 = 1 \odot x = x \odot 1$ for all $x \in \mathbb{Z}$ and $-1 \leq_{\mathbb{Z}} 0$ but $(-1) \odot (-1) = 0 \not\leq_{\mathbb{Z}} -1 = 0 \odot (-1)$ implies that $(\mathbb{Z}, \odot, \leq_{\mathbb{Z}})$ is a NeutroOrderedSemigroup with -1 as minimum element.

Example 3.14. Let “ \leq ” be the usual order on \mathbb{Z} and “ \odot ” be the operation define on \mathbb{Z} in Example 3.13. One can easily see that $(\mathbb{Z}, \odot, \leq)$ is not a NeutroTotalOrderedSemigroup as there exist no $x \leq y \in \mathbb{Z}$ (with $x \neq y$) such that $z \odot x \leq z \odot y$ for all $z \in \mathbb{Z}$. In this case and according to Definition 3.3, $(T, I, F) = (0, 0, 1)$.

Example 3.15. Let \mathbb{Z} be the set of integers and define “ \otimes ” on \mathbb{Z} as follows: $x \otimes y = xy + 1$ for all $x, y \in \mathbb{Z}$. Since $0 \otimes (1 \otimes 0) = 1 = (0 \otimes 1) \otimes 0$ and $0 \otimes (1 \otimes 2) = 1 \neq 3 = (0 \otimes 1) \otimes 2$, it follows that (\mathbb{Z}, \otimes) is a NeutroSemigroup. We define the partial order “ \leq_{\otimes} ” on \mathbb{Z} as $1 \leq_{\otimes} x$ for all $x \in \mathbb{Z}$ and for $a, b \geq 1$, $a \leq_{\otimes} b$ is equivalent to $a \leq b$ and for $a, b \leq 0$, $a \leq_{\otimes} b$ is equivalent to $a \geq b$. In this way, we get $1 \leq_{\otimes} 2 \leq_{\otimes} 3 \leq_{\otimes} 4 \leq_{\otimes} \dots$ and $1 \leq_{\otimes} 0 \leq_{\otimes} -1 \leq_{\otimes} -2 \leq_{\otimes} \dots$. Having $0 \leq_{\otimes} -1$ and $x \otimes 0 = 0 \otimes x = 1 \leq_{\otimes} -x + 1 = -1 \otimes x = x \otimes (-1)$ for all $x \in \mathbb{Z}$ and

$1 \leq_{\otimes} 0$ but $1 \otimes 1 = 2 \not\leq_{\otimes} 1 = 0 \odot 1$ implies that $(\mathbb{Z}, \otimes, \leq_{\otimes})$ is a NeutroOrderedSemigroup with 1 as minimum element.

We present some examples on NeutroOrderedSubSemigroups, NeutroOrderedRightIdeals, NeutroOrderedLeftIdeals, NeutroOrderedIdeals, and NeutroOrderedFilters.

Example 3.16. Let (S_3, \cdot_3, \leq_3) be the NeutroOrderedSemigroup presented in Example 3.12. Then $I = \{0, 1, 2\}$ is a NeutroSubSemigroup of S_3 as (I, \cdot_3) is NeutroOperation (with no AntiAxiom as $0 \cdot_3 (0 \cdot_3 0) = (0 \cdot_3 0) \cdot_3 0$) and $0 \leq_3 1 \in I$ but $2 \cdot_3 0 = 0 \leq_3 4 = 2 \cdot_3 1$ is indeterminate over I as $4 \notin I$. Moreover, $(0] = \{0\} \subseteq I$. Since $g \cdot_3 0 = 0 \in I$ for all $g \in S_3$, it follows that I is a NeutroOrderedLeftIdeal of S_3 . Moreover, having $1 \cdot_3 g \in \{0, 1, 2\} \subseteq I$ implies that I is a NeutroOrderedRightIdeal of S_3 . Since there is no $g \in S$ satisfying $g \cdot_3 i \in I$ and $i \cdot_3 g \in I$ for a particular $i \in I$, it follows that I is not a NeutroOrderedIdeal of S_3 .

Remark 3.17. Unlike the case in Ordered Semigroups, the intersection of NeutroOrderedSubsemigroups may not be a NeutroOrderedSubsemigroup. (See Example 3.18.)

Example 3.18. Let (S_3, \cdot_3, \leq_3) be the NeutroOrderedSemigroup presented in Example 3.12. One can easily see that $J = \{0, 1, 3\}$ is a NeutroOrderedSubsemigroup of S_3 . From Example 3.16, we know that $I = \{0, 1, 2\}$ is a NeutroOrderedSubsemigroup of S_3 . Since $(\{0, 1\}, \cdot_3)$ is a semigroup and not a NeutroSemigroup, it follows that $(I \cap J, \cdot_3, \leq_3)$ is not a NeutroOrderedSubSemigroup of S_3 . Here, $I \cap J = \{0, 1\}$.

Example 3.19. Let $(\mathbb{Z}, \odot, \leq_{\mathbb{Z}})$ be the NeutroOrderedSemigroup presented in Example 3.13. Then $I = \{-1, 0, 1, -2, -3, -4, \dots\}$ is a NeutroOrderedIdeal of \mathbb{Z} . This is clear as:

- (1) $0 \odot (1 \odot 0) = -1 = (0 \odot 1) \odot 0$ and $0 \odot (-1 \odot -2) = -1 \neq 1 = (0 \odot -1) \odot -2$;
- (2) $g \odot 0 = 0 \odot g = -1 \in I$ for all $g \in \mathbb{Z}$;
- (3) $-1 \in I$ and $(-1] = \{-1\} \subseteq I$;
- (4) $0 \leq_{\mathbb{Z}} 1 \in I$ implies that $0 \odot x = x \odot 0 = -1 \leq_{\mathbb{Z}} x - 1 = x \odot 1 = 1 \odot x$ for all $x \in I$ and $-1 \leq_{\mathbb{Z}} 0 \in I$ but $-1 \odot -1 = 0 \not\leq_{\mathbb{Z}} -1 = 0 \odot -1$.

Example 3.20. Let $(\mathbb{Z}, \odot, \leq_{\mathbb{Z}})$ be the NeutroOrderedSemigroup presented in Example 3.13. Then $F = \{-1, 0, 1, 2, 3, 4, \dots\}$ is a NeutroOrderedFilter of \mathbb{Z} . This is clear as:

- (1) $0 \odot (1 \odot 0) = -1 = (0 \odot 1) \odot 0$ and $1 \odot (2 \odot 3) = 4 \neq 2 = (1 \odot 2) \odot 3$;
- (2) $1 \in F$ and for all $x \in \mathbb{Z}$ such that $x - 1 = 1 \odot x = x \odot 1 \in F$, we have $x \in F$;
- (3) $0 \in F$ and $[0) = \{0, 1, 2, 3, 4, \dots\} \subseteq F$;
- (4) $0 \leq_{\mathbb{Z}} 1 \in F$ and $0 \otimes (-1) = -1 \leq -2 = 1 \otimes (-1)$ is indeterminate in F .

Here, F is not a NeutroOrderedSubSemigroup of \mathbb{Z} as there exist no $x \in F$ with $(x] \subseteq F$.

Example 3.21. Let (S_2, \cdot_2, \leq_2) be the NeutroTotalOrderedSemigroup presented in Example 3.10. Then $F = \{1, 2, 3\}$ is a NeutroOrderedFilter of S_2 . This is clear as:

- (1) $2 \cdot_2 (2 \cdot_2 2) = (2 \cdot_2 2) \cdot_2 2$ and $1 \cdot_2 (2 \cdot_2 1) = 3 \neq 1 = (1 \cdot_2 2) \cdot_2 1$;
- (2) $1 \cdot_2 x \in F$ and $z \cdot_2 1 \in F$ implies that $x, z \in F$;
- (3) $3 \in F$ and $[3] = \{3\} \subseteq F$;
- (4) $2 \leq_2 3 \in F$ implies that $2 \cdot_2 x \leq_2 3 \cdot_2 x$ and $x \cdot_2 2 \leq_2 x \cdot_2 3$ for all $x \in F$ and $1 \leq_2 2$ but $2 \cdot_2 1 = 3 \not\leq_2 2 = 2 \cdot_2 2$.

Lemma 3.22. *Let (S, \cdot, \leq_S) and $(S', \star, \leq_{S'})$ be NeutroOrderedSemigroups and $\phi : S \rightarrow S'$ be a NeutroOrderedStrongIsomorphism. Then S is a NeutroTotalOrderedSemigroup if and only if S' is a NeutroTotalOrderedSemigroup.*

Proof. The proof is straightforward. \square

Remark 3.23. Let (S, \cdot, \leq_S) and $(S', \star, \leq_{S'})$ be NeutroOrderedSemigroups and $\phi : S \rightarrow S'$ be a NeutroOrderedIsomorphism. Then Lemma 3.22 may not hold. (See Example 3.24.)

Example 3.24. Let (S_2, \cdot_2, \leq_2) be the NeutroTotalOrderedSemigroup presented in Example 3.10, (S_2, \cdot'_2, \leq'_2) be the NeutroOrderedSemigroup presented in Example 3.11, and $\phi : (S_2, \cdot_2, \leq_2) \rightarrow (S_2, \cdot'_2, \leq'_2)$ be defined as $\phi(x) = x$ for all $x \in S_2$. One can easily see that ϕ is a NeutroOrderedIsomorphism that is not NeutroOrderedStrongIsomorphism as: $\phi(0 \cdot_2 0) = \phi(0) = 0 = \phi(0) \cdot'_2 \phi(0)$, $0 \leq_2 1$ and $\phi(0) = 0 \leq'_2 1 = \phi(1)$, $1 \leq_2 3$ but $\phi(1) = 1 \not\leq'_2 3 = \phi(3)$. Having (S_2, \cdot_2, \leq_2) a NeutroOrderedSemigroup that is not NeutroTotalOrderedSemigroup and (S_2, \cdot'_2, \leq'_2) a NeutroTotalOrderedSemigroup illustrates our idea.

Lemma 3.25. *Let (S, \cdot, \leq_S) and $(S', \star, \leq_{S'})$ be NeutroOrderedSemigroups and $\phi : S \rightarrow S'$ be a NeutroOrderedStrongIsomorphism. Then S contains a minimum (maximum) element if and only if S' contains a minimum (maximum) element.*

Proof. The proof is straightforward. \square

Remark 3.26. In Lemma 3.25, if $\phi : S \rightarrow S'$ is a NeutroOrderedIsomorphism that is not a NeutroOrderedStrongIsomorphism then S' may contain a minimum (maximum) element and S does not contain. (See Example 3.27.)

Example 3.27. With reference to Example 3.24, (S_2, \cdot_2, \leq_2) has 0 as its minimum element whereas (S_2, \cdot'_2, \leq'_2) has no minimum element.

Lemma 3.28. *Let (S, \cdot, \leq_S) and $(S', \star, \leq_{S'})$ be NeutroOrderedSemigroups and $\phi : S \rightarrow S'$ be a NeutroOrderedStrongIsomorphism. If $M \subseteq S$ is a NeutroOrderedSubsemigroup of S then $\phi(M)$ is a NeutroOrderedSubsemigroup of S' .*

Proof. First, we prove that $(\phi(M), \star)$ is a NeutroSemigroup. Since (M, \cdot) is a NeutroSemigroup, it follows that (M, \cdot) is either NeutroOperation or NeutroAssociative.

- Case (M, \cdot) is NeutroOperation. There exist $x, y, a, b \in M$ such that $x \cdot y \in M$ and $a \cdot b \notin M$ or $x \cdot y$ is indeterminate. The latter implies that there exist $\phi(x), \phi(y), \phi(a), \phi(b) \in \phi(M)$ such that $\phi(x) \star \phi(y) = \phi(x \cdot y) \in \phi(M)$ and $\phi(a) \star \phi(b) = \phi(a \cdot b) \notin \phi(M)$ or $\phi(x) \star \phi(y) = \phi(x \cdot y)$ is indeterminate.
- Case (M, \cdot) is NeutroAssociative. There exist $x, y, z, a, b, c \in M$ such that $(x \cdot y) \cdot z = x \cdot (y \cdot z)$ and $(a \cdot b) \cdot c \neq a \cdot (b \cdot c)$. The latter implies that there exist $\phi(x), \phi(y), \phi(z), \phi(a), \phi(b), \phi(c) \in \phi(M)$ such that $(\phi(x) \star \phi(y)) \star \phi(z) = \phi(x) \star (\phi(y) \star \phi(z))$ and $(\phi(a) \star \phi(b)) \star \phi(c) \neq \phi(a) \star (\phi(b) \star \phi(c))$ (as ϕ is one-to-one.).

Since M is a NeutroOrderedSubsemigroup of S , it follows that there exist $x \in M$ such that $[x] \subseteq M$. It is easy to see that $(\phi(x)] \subseteq \phi(M)$ as for all $t \in S'$, there exist $y \in S$ such that $t = \phi(y)$. For $\phi(y) \leq_{S'} \phi(x)$, we have $y \leq_S x$. The latter implies that $y \in M$ and hence, $t \in \phi(M)$.

Since M is a NeutroOrderedSubsemigroup of S , it follows that:

- (T) There exist $x \leq_S y \in M$ (with $x \neq y$) such that $z \cdot x \leq_S z \cdot y$ and $x \cdot z \leq_S y \cdot z$ for all $z \in M$;
- (F) There exist $a \leq_S b \in M$ and $c \in M$ with $a \cdot c \not\leq_S b \cdot c$ (or $c \cdot a \not\leq_S c \cdot b$);
- (I) There exist $x \leq_S y \in M$ and $z \in M$ with: $z \cdot x$ (or $x \cdot z$ or $y \cdot z$ or $z \cdot y$) indeterminate or $z \cdot x \leq_S z \cdot y$ (or $x \cdot z \leq_S y \cdot z$) indeterminate in M .

Where $(T, I, F) \neq (1, 0, 0)$ and $(T, I, F) \neq (0, 0, 1)$. This implies that

- (T) There exist $\phi(x) \leq_{S'} \phi(y) \in \phi(M)$ (with $\phi(x) \neq \phi(y)$ as $x \neq y$) such that $\phi(z) \star \phi(x) \leq_{S'} \phi(z) \star \phi(y)$ and $\phi(x) \star \phi(z) \leq_{S'} \phi(y) \star \phi(z)$ for all $\phi(z) \in \phi(M)$;
- (F) There exist $\phi(a) \leq_{S'} \phi(b) \in \phi(M)$ and $\phi(c) \in \phi(M)$ with $\phi(a) \star \phi(c) \not\leq_{S'} \phi(b) \star \phi(c)$ (or $\phi(c) \star \phi(a) \not\leq_{S'} \phi(c) \star \phi(b)$);
- (I) There exist $\phi(x) \leq_{S'} \phi(y) \in \phi(M)$ and $\phi(z) \in \phi(M)$ with: $\phi(z) \star \phi(x)$ (or $\phi(x) \star \phi(z)$ or $\phi(y) \star \phi(z)$ or $\phi(z) \star \phi(y)$) indeterminate or $\phi(z) \star \phi(x) \leq_{S'} \phi(z) \star \phi(y)$ (or $\phi(x) \star \phi(z) \leq_{S'} \phi(y) \star \phi(z)$) indeterminate in $\phi(M)$.

Where $(T, I, F) \neq (1, 0, 0)$ and $(T, I, F) \neq (0, 0, 1)$. Therefore, $\phi(M)$ is a NeutroOrderedSubsemigroup of S' . \square

Lemma 3.29. *Let (S, \cdot, \leq_S) and $(S', \star, \leq_{S'})$ be NeutroOrderedSemigroups and $\phi : S \rightarrow S'$ be a NeutroOrderedStrongIsomorphism. If $M \subseteq S$ is a NeutroOrderedLeftIdeal (NeutroOrderedRightIdeal) of S then $\phi(M)$ is a NeutroOrderedLeftIdeal (NeutroOrderedRightIdeal) of S' .*

Proof. We prove that if $M \subseteq S$ is a NeutroOrderedLeftIdeal of S then $\phi(M)$ is a NeutroOrderedLeftIdeal of T . For NeutroOrderedRightIdeal, it is done similarly. Using Lemma 3.28, it suffices to show that there exist $z \in \phi(M)$ such that for all $t \in S'$ $t \star z \in \phi(M)$. Since M is a NeutroOrderedLeftIdeal of S , it follows that there exist $m \in M$ such that $s \cdot m \in m$ for all $s \in S$. Having ϕ an onto function implies that for all $t \in S'$, there exist $s \in S$ with $t = \phi(s)$. By setting $z = \phi(m)$, we get that $t \star z = \phi(s) \star \phi(m) = \phi(s \cdot m) \in \phi(M)$. \square

Lemma 3.30. *Let (S, \cdot, \leq_S) and $(S', \star, \leq_{S'})$ be NeutroOrderedSemigroups and $\phi : S \rightarrow S'$ be a NeutroOrderedStrongIsomorphism. If $M \subseteq S$ is a NeutroOrderedIdeal of S then $\phi(M)$ is a NeutroOrderedIdeal of S' .*

Proof. The proof is similar to that of Lemma 3.29. \square

Example 3.31. Let $(\mathbb{Z}, \odot, \leq_{\mathbb{Z}})$ and $(\mathbb{Z}, \otimes, \leq_{\otimes})$ be the NeutroOrderedSemigroups presented in Example 3.13 and Example 3.15 respectively, and $\phi : (\mathbb{Z}, \odot, \leq_{\mathbb{Z}}) \rightarrow (\mathbb{Z}, \otimes, \leq_{\otimes})$ be defined as $\phi(x) = x+2$ for all $x \in \mathbb{Z}$. One can easily see that ϕ is a NeutroOrderedStrongIsomorphism. By Example 3.19, we have $I = \{-1, 0, 1, -2, -3, -4, \dots\}$ is a NeutroOrderedIdeal of $(\mathbb{Z}, \odot, \leq_{\mathbb{Z}})$. Applying Lemma 3.30, we get that $\phi(I) = \{1, 2, 3, 0, -1, -2, \dots\}$ is a NeutroOrderedIdeal of $(\mathbb{Z}, \otimes, \leq_{\otimes})$.

Lemma 3.32. *Let (S, \cdot, \leq_S) and $(S', \star, \leq_{S'})$ be NeutroOrderedSemigroups and $\phi : S \rightarrow S'$ be a NeutroOrderedStrongIsomorphism. If $M \subseteq S$ is a NeutroOrderedFilter of S then $\phi(M)$ is a NeutroOrderedFilter of S' .*

Proof. Using Lemma 3.28, we get that $(\phi(M), \star)$ is a NeutroSemigroup and that $\leq_{S'}$ is NeutroOrder on $\phi(M)$. i.e., Conditions (1), (2), and (3) of Definition 3.3 are satisfied.

Since M is a NeutroOrderedFilter of S , it follows that there exist $x \in M$ such that $[x] \subseteq M$. It is easy to see that $[\phi(x)] \subseteq \phi(M)$ as for all $t \in S'$, there exist $y \in S$ such that $t = \phi(y)$. For $\phi(x) \leq_{S'} \phi(y)$, we have $x \leq_S y$. The latter implies that $y \in M$ and hence, $t \in \phi(M)$.

Since M is a NeutroOrderedFilter of S , it follows that there exist $x \in M$ such that for all $y, z \in S$ with $x \cdot y \in M$ and $z \cdot x \in M$ we have $y, z \in M$. The latter and having ϕ onto implies that there exist $t = \phi(x) \in \phi(M)$ such that for all $\phi(y), \phi(z) \in S'$ with $\phi(x) \star \phi(y) \in \phi(M)$ and $\phi(z) \star \phi(x) \in \phi(M)$ we have $\phi(y), \phi(z) \in \phi(M)$. \square

Example 3.33. Let $(\mathbb{Z}, \odot, \leq_{\mathbb{Z}})$ and $(\mathbb{Z}, \otimes, \leq_{\otimes})$ be the NeutroOrderedSemigroups presented in Example 3.13 and Example 3.15 respectively, and $\phi : (\mathbb{Z}, \odot, \leq_{\mathbb{Z}}) \rightarrow (\mathbb{Z}, \otimes, \leq_{\otimes})$ be the NeutroOrderedStrongIsomorphism defined as $\phi(x) = x+2$ for all $x \in \mathbb{Z}$. By Example 3.20, we

have $F = \{-1, 0, 1, 2, 3, 4, \dots\}$ is a NeutroOrderedFilter of $(\mathbb{Z}, \odot, \leq_{\mathbb{Z}})$. Applying Lemma 3.32, we get that $\phi(F) = \{1, 2, 3, 4, 5, 6, \dots\}$ is a NeutroOrderedFilter of $(\mathbb{Z}, \otimes, \leq_{\otimes})$.

Lemma 3.34. *Let (S, \cdot, \leq_S) and $(S', \star, \leq_{S'})$ be NeutroOrderedSemigroups and $\phi : S \rightarrow S'$ be a NeutroOrderedStrongIsomorphism. If $N \subseteq S'$ is a NeutroOrderedSubsemigroup of S' then $\phi^{-1}(N)$ is a NeutroOrderedSubsemigroup of S .*

Proof. Theorem 2.11 asserts that $\phi^{-1} : S' \rightarrow S$ is a NeutroOrderedStrongIsomorphism. Having $N \subseteq S'$ a NeutroOrderedSubsemigroup of S' and by using Lemma 3.28, we get that $\phi^{-1}(N)$ is a NeutroOrderedSubsemigroup of S . \square

Lemma 3.35. *Let (S, \cdot, \leq_S) and $(S', \star, \leq_{S'})$ be NeutroOrderedSemigroups and $\phi : S \rightarrow S'$ be a NeutroOrderedStrongIsomorphism. If $N \subseteq S'$ is a NeutroOrderedSubsemigroup of S' then $\phi^{-1}(N)$ is a NeutroOrderedLeftIdeal (NeutroOrderedRightIdeal) of S .*

Proof. Theorem 2.11 asserts that $\phi^{-1} : S' \rightarrow S$ is a NeutroOrderedStrongIsomorphism. Having $N \subseteq S'$ a NeutroOrderedLeftIdeal (NeutroOrderedRightIdeal) of S' and by using Lemma 3.29, we get that $\phi^{-1}(N)$ is a NeutroOrderedLeftIdeal (NeutroOrderedRightIdeal) of S . \square

Lemma 3.36. *Let (S, \cdot, \leq_S) and $(S', \star, \leq_{S'})$ be NeutroOrderedSemigroups and $\phi : S \rightarrow S'$ be a NeutroOrderedStrongIsomorphism. If $N \subseteq S'$ is a NeutroOrderedSubsemigroup of S' then $\phi^{-1}(N)$ is a NeutroOrderedIdeal of S .*

Proof. Theorem 2.11 asserts that $\phi^{-1} : S' \rightarrow S$ is a NeutroOrderedStrongIsomorphism. Having $N \subseteq S'$ a NeutroOrderedIdeal of S' and by using Lemma 3.35, we get that $\phi^{-1}(N)$ is a NeutroOrderedIdeal of S . \square

Lemma 3.37. *Let (S, \cdot, \leq_S) and $(S', \star, \leq_{S'})$ be NeutroOrderedSemigroups and $\phi : S \rightarrow S'$ be a NeutroOrderedStrongIsomorphism. If $N \subseteq S'$ is a NeutroOrderedFilter of S' then $\phi^{-1}(N)$ is a NeutroOrderedFilter of S .*

Proof. Theorem 2.11 asserts that $\phi^{-1} : S' \rightarrow S$ is a NeutroOrderedStrongIsomorphism. Having $N \subseteq S'$ a NeutroOrderedFilter of S' and by using Lemma 3.32, we get that $\phi^{-1}(N)$ is a NeutroOrderedFilter of S . \square

We present our main theorems.

Theorem 3.38. *Let (S, \cdot, \leq_S) and $(S', \star, \leq_{S'})$ be NeutroOrderedSemigroups and $\phi : S \rightarrow S'$ be a NeutroOrderedStrongIsomorphism. Then $M \subseteq S$ is a NeutroOrderedSubsemigroup of S if and only if $\phi(M)$ is a NeutroOrderedSubsemigroup of S' .*

Proof. The proof follows from Lemmas 3.28 and 3.34. \square

Theorem 3.39. *Let (S, \cdot, \leq_S) and $(S', \star, \leq_{S'})$ be NeutroOrderedSemigroups and $\phi : S \rightarrow S'$ be a NeutroOrderedStrongIsomorphism. Then $M \subseteq S$ is a NeutroOrderedLeftIdeal (NeutroOrderedRightIdeal) of S if and only if $\phi(M)$ is a NeutroOrderedLeftIdeal (NeutroOrderedRightIdeal) of S' .*

Proof. The proof follows from Lemmas 3.29 and 3.35. \square

Theorem 3.40. *Let (S, \cdot, \leq_S) and $(S', \star, \leq_{S'})$ be NeutroOrderedSemigroups and $\phi : S \rightarrow S'$ be a NeutroOrderedStrongIsomorphism. Then $M \subseteq S$ is a NeutroOrderedIdeal of S if and only if $\phi(M)$ is a NeutroOrderedIdeal of S' .*

Proof. The proof follows from Lemmas 3.30 and 3.36. \square

Theorem 3.41. *Let (S, \cdot, \leq_S) and $(S', \star, \leq_{S'})$ be NeutroOrderedSemigroups and $\phi : S \rightarrow S'$ be a NeutroOrderedStrongIsomorphism. Then $M \subseteq S$ is a NeutroOrderedFilter of S if and only if $\phi(M)$ is a NeutroOrderedFilter of S' .*

Proof. The proof follows from Lemmas 3.32 and 3.37. \square

4. Conclusion

This paper contributed to the study of NeutroAlgebra by introducing, for the first time, NeutroOrderedAlgebra. The new defined notion was applied to semigroups and many interesting properties were proved as well illustrative examples were given on NeutroOrderedSemigroups.

For future research, it will be interesting to apply the concept of NeutroOrderedAlgebra to different algebraic structures such as groups, rings, modules, etc. and to study AntiOrderedAlgebra.

References

- [1] M. Al-Tahan and B. Davvaz, Refined neutrosophic quadruple (po-)hypergroups and their fundamental group, Neutrosophic Sets and Systems, Vol. 27, 2019, pp. 138-153.
- [2] M. Al-Tahan, B. Davvaz, and M. Parimala, A Note on Single Valued Neutrosophic Sets in Ordered Groupoids, International Journal of Neutrosophic Science (IJNS), Vol. 10, No. 2, 2020, pp. 73-83.
- [3] M. Al-Tahan and B. Davvaz, On Some Properties of Neutrosophic Quadruple Hv-rings, Neutrosophic Sets and Systems, Vol. 36, 2020, pp. 256-270.

- [4] A.A.A. Agboola, M.A. Ibrahim, E.O. Adeleke, Elementary Examination of NeutroAlgebras and AntiAlgebras viz-a-viz the Classical Number Systems, International Journal of Neutrosophic Science(IJNS), Vol. 4, 2020, pp. 16-19. DOI: <http://doi.org/10.5281/zenodo.3989530>
- [5] A.A.A. Agboola, Introduction to NeutroRings, International Journal of Neutrosophic Science (IJNS), Vol. 7, 2020, pp. 62-73.
- [6] A.A.A. Agboola, Introduction to NeutroGroups, International Journal of Neutrosophic Science(IJNS), Vol. 6, 2020, pp. 41-47.
- [7] A.H. Clifford, G.B. Preston, The Algebraic Theory of Semigroups, Vol 1, Amer. Math. Soc., Math. Surveys 7, Providence, Rhode Island, 1977.
- [8] L. Fuchs, Partially Ordered Algebraic Systems, Int. Ser. of Monographs on Pure and Appl. Math. 28, Pergamon Press, Oxford, 1963.
- [9] M. Hamidi, F. Smarandache, Neutro-BCK-Algebra, International Journal of Neutrosophic Science (IJNS), Vol. 8, 2020, pp. 110-117.
- [10] A. Rezaei, F. Smarandache, On Neutro-BE-algebras and Anti-BE-algebras, International Journal of Neutrosophic Science(IJNS), Vol. 4, 2020, pp. 8-15.
- [11] F. Smarandache, NeutroAlgebra is a Generalization of Partial Algebra, International Journal of Neutrosophic Science (IJNS), Vol. 2, No. 1, pp. 08-17, 2020, <http://fs.unm.edu/NeutroAlgebra.pdf>.
- [12] F. Smarandache, Introduction to NeutroAlgebraic Structures and AntiAlgebraic Structures, in Advances of Standard and Nonstandard Neutrosophic Theories, Pons Publishing House Brussels, Belgium, Ch. 6, pp. 240-265, 2019; <http://fs.unm.edu/AdvancesOfStandardAndNonstandard.pdf>
- [13] F. Smarandache, Introduction to NeutroAlgebraic Structures and AntiAlgebraic Structures (revisited), Neutrosophic Sets and Systems, Vol. 31, pp. 1-16, 2020. DOI: 10.5281/zenodo.3638232, <http://fs.unm.edu/NSS/NeutroAlgebraic-AntiAlgebraic-Structures.pdf>
- [14] F. Smarandache, Extension of HyperGraph to n-SuperHyperGraph and to Plithogenic n-SuperHyperGraph, and Extension of HyperAlgebra to n-ary (Classical-/Neutro-/Anti-)HyperAlgebra. Neutrosophic Sets and Systems, Vol. 33, 2020, 7 p.
- [15] F. Smarandache, A. Rezaei, H.S. Kim, A New Trend to Extensions of CI- algebras. International Journal of Neutrosophic Science(IJNS) Vol. 5, No. 1 , pp. 8-15, 2020; DOI: 10.5281/zenodo.3788124

A Kind of Variation Symmetry: Tarski Associative Groupoids (TA-Groupoids) and Tarski Associative Neutrosophic Extended Triplet Groupoids (TA-NET-Groupoids)

Xiaohong Zhang, Wangtao Yuan, Mingming Chen, Florentin Smarandache

Xiaohong Zhang, Wangtao Yuan, Mingming Chen, Florentin Smarandache (2020). A Kind of Variation Symmetry: Tarski Associative Groupoids (TA-Groupoids) and Tarski Associative Neutrosophic Extended Triplet Groupoids (TA-NET-Groupoids). *Symmetry* 12, 714; DOI: 10.3390/sym12050714

Abstract: The associative law reflects symmetry of operation, and other various variation associative laws reflect some generalized symmetries. In this paper, based on numerous literature and related topics such as function equation, non-associative groupoid and non-associative ring, we have introduced a new concept of Tarski associative groupoid (or transposition associative groupoid (TA-groupoid)), presented extensive examples, obtained basic properties and structural characteristics, and discussed the relationships among few non-associative groupoids. Moreover, we proposed a new concept of Tarski associative neutrosophic extended triplet groupoid (TA-NET-groupoid) and analyzed related properties. Finally, the following important result is proved: every TA-NET-groupoid is a disjoint union of some groups which are its subgroups.

Keywords: Tarski associative groupoid (TA-groupoid); TA-NET-groupoid; semigroup; subgroup

1. Introduction

Generally, group and semigroup [1–5] are two basic mathematical concepts which describe symmetry. As far as we know the term semigroup was firstly introduced in 1904 in a French book (see book review [1]). A semigroup is called right commutative if it satisfies the identity $a*(x*y) = a*(y*x)$ [4]. When we combine right commutative with associative law, we can get the identity:

$$(x * y) * z = x * (z * y) \text{ (Tarski associative law).}$$

In this study we focused on the non-associative groupoid satisfying Tarski associative law (it is also called transposition associative law), and this kind of groupoid is called Tarski associative groupoid (TA-groupoid). From a purely algebraic point of view, these structures are interesting. They produce innovative ideas and methods that help solve some old algebraic problems.

In order to express the general symmetry and algebraic operation laws which are similar with the associative law, scholars have studied various generalized associative laws. As early as in 1924, Suschkewitsch [6] studied the following generalized associative law (originally called “Postulate A”):

$$(x * a) * b = x * c,$$

where the element c depended upon the element a and b only, and not upon x . Apparently, the associative law is a special case of this Postulate A when $c = a * b$, and Tarski associative law explained

above is also a special case of this Postulate A when $c = b * a$. This fact shows that Tarski associative groupoid (TA-groupoid) studied in our research is a natural generalization of the semigroup. At the same time, Hosszu studied the function equations satisfying Tarski associative law in 1954 (see [7–9]); Theby [10] studied rings satisfying $x(yz) = (yx)z$, and it is symmetric to Tarski associative groupoid, since defining $x*y = yx$, $x(yz) = (yx)z$ is changed to $(z*y)*x = z*(x*y)$; Phillips (see the Table 12 in [11]) and Pushkashu [12] also referred to Tarski associative law. These facts show that the systematic study of Tarski associative groupoid (TA-groupoid) is helpful to promote the study of non-associative rings and other non-associative algebraic systems.

In recent years, a variety of non-associative groupoids have been studied in depth (it should be noted that the term “groupoid” has many different meanings, such as the concept in category theory and algebraic topology, see [13]). An algebraic structure midway between a groupoid and a commutative semigroup appeared in 1972, Kazim and Naseeruddin [14] introduced the concept of left almost semigroup (LA-semigroup) as a generalization of commutative semigroup and it is also called Abel-Grassmann’s groupoid (or simply AG-groupoid). Many different aspects of AG-groupoids have been studied in [15–22]. Moreover, Mushtaq and Kamran [19] in 1989 introduced the notion of AG*-groupoids: one AG-groupoid $(S, *)$ is called AG*-groupoid if it satisfies

$$(x * y) * z = y * (x * z), \text{ for any } x, y, z \in S.$$

Obviously, when we reverse the above equation, we can get $(z*x)*y = z*(y*x)$, which is the Tarski associative law (transposition associative law). In [23], a new kind of non-associative groupoid (cyclic associative groupoid, shortly, CA-groupoid) is proposed, and some interesting results are presented.

Moreover, this paper also involves with the algebraic system “neutrosophic extended triplet group”, which has been widely studied in recent years. The concept of neutrosophic extended triplet group (NETG) is presented in [24], and the close relationship between NETGs and regular semigroups has been established [25]. Many other significant results on NETGs and related algebraic systems can be found, see [25,26]. In this study, combining neutrosophic extended triplet groups (NETGs) and Tarski associative groupoids (TA-groupoids), we proposed the concept of Tarski associative neutrosophic extended triplet groupoid (TA-NET-groupoid).

This paper has been arranged as follows. In Section 2, we give some definitions and properties on groupoid, CA-groupoid, AG-groupoid and NETG. In Section 3, we propose the notion of Tarski associative groupoid (TA-groupoid), and show some examples. In Section 4, we study its basic properties, and, moreover, analyze the relationships among some related algebraic systems. In Section 5, we introduce the new concept of Tarski associative NET-groupoid (TA-NET-groupoid) and weak commutative TA-NET-groupoid (WC-TA-NET-Groupoid), investigate basic properties of TA-NET-groupoids and weak commutative TA-NET-groupoids (WC-TA-NET-Groupoids). In Section 6, we prove a decomposition theorem of TA-NET-groupoid. Finally, Section 7 presents the summary and plans for future work.

2. Preliminaries

In this section, some notions and results about groupoids, AG-groupoids, CA-groupoids and neutrosophic triplet groups are given. A groupoid is a pair $(S, *)$ where S is a non-empty set with a binary operation $*$. Traditionally, when the $*$ operator is omitted, it will not be confused. Suppose $(S, *)$ is a groupoid, we define some concepts as follows:

- (1) $\forall a, b, c \in S, a*(b*c) = a*(c*b)$, S is called right commutative; if $(a*b)*c = (b*a)*c$, S is called left commutative. When S is right and left commutative, then it is called bi-commutative groupoid.
- (2) If $a^2 = a$ ($a \in S$), the element a is called idempotent.
- (3) If for all $x, y \in S, a*x = a*y \Rightarrow x = y$ ($x*a = y*a \Rightarrow x = y$), the element $a \in S$ is left cancellative (respectively right cancellative). If an element is a left and right cancellative, the element is

cancellative. If $(\forall a \in S)$ a is left (right) cancellative or cancellative, then S is left (right) cancellative or cancellative.

- (4) If $\forall a, b, c \in S, a*(b*c) = (a*b)*c$, S is called semigroup. If $\forall a, b \in S, a*b = b*a$, then a semigroup $(S, *)$ is commutative.
- (5) If $\forall a \in S, a^2 = a$, a semigroup $(S, *)$ is called a band.

Definition 1. ([14,15]) Assume that $(S, *)$ is a groupoid. If S satisfying the left invertive law: $\forall a, b, c \in S, (a*b)*c = (c*b)*a$. S is called an Abel-Grassmann's groupoid (or simply AG-groupoid).

Definition 2. ([21,22]) Let $(S, *)$ be an AG-groupoid, for all $a, b, c \in S$.

- (1) If $(a*b)*c = b*(a*c)$, then S is called an AG*-groupoid.
- (2) If $a*(b*c) = b*(a*c)$, then S is called an AG**-groupoid.
- (3) If $a*(b*c) = c*(a*b)$, then S is called a cyclic associative AG-groupoid (or CA-AG-groupoid).

Definition 3. [23] Let $(S, *)$ be a groupoid. S is called a cyclic associative groupoid (shortly, CA-groupoid), if S satisfying the cyclic associative law: $\forall a, b, c \in S, a*(b*c) = c*(a*b)$.

Proposition 1. [23] Let $(S, *)$ be a CA-groupoid, then:

- (1) For any $a, b, c, d, x, y \in S, (a*b)*(c*d) = (d*a)*(c*b)$;
- (2) For any $a, b, c, d, x, y \in S, (a*b)*((c*d)*(x*y)) = (d*a)*((c*b)*(x*y))$.

Definition 4. ([24,26]) Suppose S be a non-empty set with the binary operation $*$. If for any $a \in S$, there is a neutral " a " (denote by $neut(a)$), and the opposite of " a " (denote by $anti(a)$), such that $neut(a) \in S, anti(a) \in S$, and: $a*neut(a) = neut(a)*a = a; a*anti(a) = anti(a)*a = neut(a)$. Then, S is called a neutrosophic extended triplet set.

Note: For any $a \in S, neut(a)$ and $anti(a)$ may not be unique for the neutrosophic extended triplet set $(S, *)$. To avoid ambiguity, we use the symbols $\{neut(a)\}$ and $\{anti(a)\}$ to represent the sets of $neut(a)$ and $anti(a)$, respectively.

Definition 5. ([24,26]) Let $(S, *)$ be a neutrosophic extended triplet set. Then, S is called a neutrosophic extended triplet group (NETG), if the following conditions are satisfied:

- (1) $(S, *)$ is well-defined, that is, for any $a, b \in S, a*b \in S$.
- (2) $(S, *)$ is associative, that is, for any $a, b, c \in S, (a*b)*c = a*(b*c)$.

A NETG S is called a commutative NETG if $a*b = b*a, \forall a, b \in S$.

Proposition 2. ([25]) Let $(S, *)$ be a NETG. Then $(\forall a \in S) neut(a)$ is unique.

Proposition 3. ([25]) Let $(S, *)$ be a groupoid. Then S is a NETG if and only if it is a completely regular semigroup.

3. Tarski Associative Groupoids (TA-Groupoids)

Definition 6. Let $(S, *)$ be a groupoid. S is called a Tarski associative groupoid (shortly, TA-groupoid), if S satisfying the Tarski associative law (it is also called transposition associative law): $(a*b)*c = a*(c*b), \forall a, b, c \in S$.

The following examples depict the wide existence of TA-groupoids.

Example 1. For the regular hexagon as shown in Figure 1, denote $S = \{\theta, G, G^2, G^3, G^4, G^5\}$, where G, G^2, G^3, G^4, G^5 and θ represent rotation 60, 120, 180, 240, 300 and 360 degrees clockwise around the center, respectively.

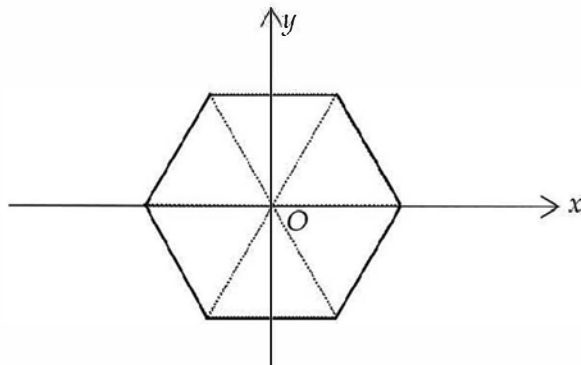

Figure 1. Regular hexagon.

Define the binary operation \circ as a composition of functions in S , that is, $\forall U, V \in S, U \circ V$ is that the first transforming V and then transforming U . Then (S, \circ) is a TA-groupoid (see Table 1).

Table 1. Cayley table on $S = \{\theta, G, G^2, G^3, G^4, G^5\}$.

\circ	θ	G	G^2	G^3	G^4	G^5
θ	θ	G	G^2	G^3	G^4	G^5
G	G	G^2	G^3	G^4	G^5	θ
G^2	G^2	G^3	G^4	G^5	θ	G
G^3	G^3	G^4	G^5	θ	G	G^2
G^4	G^4	G^5	θ	G	G^2	G^3
G^5	G^5	θ	G	G^2	G^3	G^4

Example 2. Let $S = [n, 2n]$ (real number interval, n is a natural number), $\forall x, y \in S$. Define the multiplication $*$ by

$$x * y = \begin{cases} x + y - n, & \text{if } x + y \leq 3n \\ x + y - 2n, & \text{if } x + y > 3n \end{cases}$$

Then $(S, *)$ is a TA-groupoid, since it satisfies $(x * y) * z = x * (z * y), \forall x, y, z \in S$, the proof is as follows:

Case 1: $x + y + z - n \leq 3n$. It follows that $y + z \leq x + y + z - n \leq 3n$ and $x + y \leq x + y + z - n \leq 3n$. Then $(x * y) * z = (x + y - n) * z = x + y + z - 2n = x * (z + y - n) = x * (z * y)$.

Case 2: $x + y + z - n > 3n, y + z \leq 3n$ and $x + y \leq 3n$. Then $(x * y) * z = (x + y - n) * z = x + y + z - 3n = x * (z + y - n) = x * (z * y)$.

Case 3: $x + y + z - n > 3n, y + z \leq 3n$ and $x + y > 3n$. It follows that $x + y + z - 2n \leq x + 3n - 2n = x + n \leq 3n$. Then $(x * y) * z = (x + y - 2n) * z = x + y + z - 3n = x * (z + y - n) = x * (z * y)$.

Case 4: $x + y + z - n > 3n, y + z > 3n$ and $x + y \leq 3n$. It follows that $x + y + z - 2n \leq 3n + c - 2n = z + n \leq 3n$. Then $(x * y) * z = (x + y - n) * z = x + y + z - 3n = x * (z + y - 2n) = x * (z * y)$.

Case 5: $x + y + z - n > 3n, y + z > 3n$ and $x + y > 3n$. When $x + y + c - 2n \leq 3n, (x * y) * z = (x + y - 2n) * z = x + y + z - 3n = x * (z + y - 2n) = x * (z * y)$; When $x + y + z - 2n > 3n, (x * y) * z = (x + y - 2n) * z = x + y + z - 4n = x * (z + y - 2n) = x * (z * y)$.

Example 3. Let

$$S = \left\{ \begin{pmatrix} x & 0 \\ 0 & 0 \end{pmatrix} : x \text{ is a integral number} \right\} \cup \left\{ \begin{pmatrix} 1 & 0 \\ 0 & 1 \end{pmatrix}, \begin{pmatrix} 1 & 0 \\ 0 & -1 \end{pmatrix} \right\}.$$

Denote $S_1 = \left\{ \begin{pmatrix} a & 0 \\ 0 & 0 \end{pmatrix} : a \text{ is a integral number} \right\}$, $S_2 = \left\{ \begin{pmatrix} 1 & 0 \\ 0 & 1 \end{pmatrix}, \begin{pmatrix} 1 & 0 \\ 0 & -1 \end{pmatrix} \right\}$. Define the operation $*$ on

$S: \forall x, y \in S$, (1) if $x \in S_1$ or $y \in S_1$, $x*y$ is common matrix multiplication; (2) if $x \in S_2$ and $y \in S_2$, $x*y = \begin{pmatrix} 1 & 0 \\ 0 & 1 \end{pmatrix}$.

Then $(S, *)$ is a TA-groupoid. In fact, we can verify that $(x*y)*z = x*(z*y) \forall x, y, z \in S$, since

- (i) if $x, y, z \in S_1$, by the definition of operation $*$ we can get $(x*y)*z = x*(y*z) = x*(z*y)$;
- (ii) if $x, y, z \in S_2$, then $(x*y)*z = \begin{pmatrix} 1 & 0 \\ 0 & 1 \end{pmatrix} = x*(z*y)$, by (2) in the definition of operation $*$;
- (iii) if $x \in S_2, y, z \in S_1$, then $(x*y)*z = y*z = z*y = x*(z*y)$, by (1) in the definition of operation $*$;
- (iv) if $x \in S_2, y \in S_2, z \in S_1$, then $(x*y)*z = \begin{pmatrix} 1 & 0 \\ 0 & 1 \end{pmatrix} * z = z = z*y = x*(z*y)$, by the definition of operation $*$;
- (v) if $x \in S_2, y \in S_1, z \in S_2$, then $(x*y)*z = y*z = y = z*y = x*(z*y)$, by the definition of operation $*$;
- (vi) if $x \in S_1, y \in S_2, z \in S_1$, then $(x*y)*z = x*z = x*(z*y)$, by (1) in the definition of operation $*$;
- (vii) if $x \in S_1, y \in S_1, z \in S_2$, then $(x*y)*z = x*y = x*(z*y)$, by (1) in the definition of operation $*$;
- (viii) if $x \in S_1, y \in S_2, z \in S_2$, then $(x*y)*z = x*z = x = x*\begin{pmatrix} 1 & 0 \\ 0 & 1 \end{pmatrix} = x*(z*y)$, by (1) and (2) in the definition of operation $*$.

Example 4. Table 2 shows the non-commutative TA-groupoid of order 5. Since $(b * a) * b \neq b * (a * b)$, $(a * b) * b \neq (b * b) * a$, so $(S, *)$ is not a semigroup, and it is not an AG-groupoid.

Table 2. Cayley table on $S = \{a, b, c, d, e\}$.

*	a	b	c	d	e
a	a	a	a	a	a
b	d	d	c	c	b
c	d	c	c	c	c
d	d	d	c	c	c
e	d	c	c	c	e

From the following example, we know that there exists TA-groupoid which is a non- commutative semigroup, moreover, we can generate some semirings from a TA-groupoid.

Example 5. As shown in Table 3, put $S = \{s, t, u, v, w\}$, and define the operations $*$ on S . Then we can verify through MATLAB that $(S, *)$ is a TA-groupoid, and $(S, *)$ is a semigroup.

Table 3. Cayley table on $S = \{s, t, u, v, w\}$.

*	s	t	u	v	w
s	s	s	s	s	s
t	t	t	t	t	t
u	s	s	u	u	s
v	s	s	u	v	s
w	t	t	w	w	t

Now, define the operation $+$ on S as Table 4 (or Table 5), then $(\forall m, n, p \in S) (m + n) * p = m * p + n * p$ and $(S; +, *)$ is a semiring (see [27]).

Table 4. A Commutative semigroup $(S, +)$.

$+$	s	t	u	v	w
s	s	t	u	u	w
t	t	s	w	w	u
u	u	w	u	u	w
v	u	w	u	u	w
w	w	u	w	w	u

Table 5. Another commutative semigroup $(S, +)$ with unit s .

$+$	s	t	u	v	w
s	s	t	u	v	w
t	t	t	w	w	w
u	u	w	u	u	w
v	v	w	u	u	w
w	w	w	w	w	w

Proposition 4. (1) If $(S, *)$ is a commutative semigroup, then $(S, *)$ is a TA-groupoid. (2) Let $(S, *)$ be a commutative TA-groupoid. Then $(S, *)$ is a commutative semigroup.

Proof. It is easy to verify from the definitions. \square

4. Various Properties of Tarski Associative Groupoids (TA-Groupoids)

In this section, we discussed the basic properties of TA-groupoids, gave some typical examples, and established its relationships with CA-AG-groupoids and semigroups (see Figure 2). Furthermore, we discussed the cancellative and direct product properties that are important for exploring the structure of TA-groupoids.

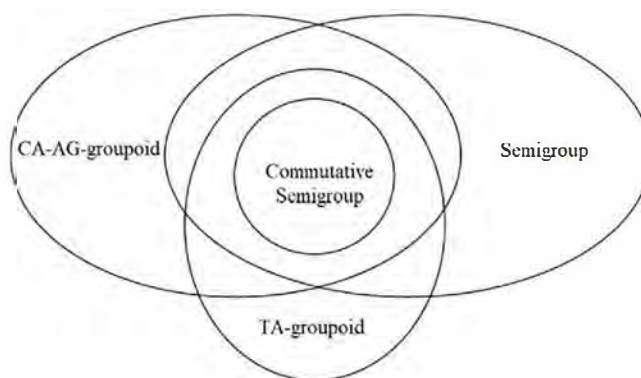

Figure 2. The relationships among some algebraic systems.

Proposition 5. Let $(S, *)$ be a TA-groupoid. Then $\forall m, n, p, r, s, t \in S$:

- (1) $(m * n) * (p * r) = (m * r) * (p * n)$;
- (2) $((m * n) * (p * r)) * (s * t) = (m * r) * ((s * t) * (p * n))$.

Proof. (1) Assume that $(S, *)$ is a TA-groupoid, then for any $m, n, p, r \in S$, by Definition 6, we have

$$(m * n) * (p * r) = m * ((p * r) * n) = m * (p * (n * r)) = (m * (n * r)) * p = ((m * r) * n) * p = (m * r) * (p * n).$$

(2) For any $m, n, p, r, s, t \in S$, by Definition 6, we have

$$\begin{aligned} ((m * n) * (p * r)) * (s * t) &= (m * n) * ((s * t) * (p * r)) = (m * n) * ((s * r) * (p * t)) = ((m * n) * (p * t)) * (s * r) \\ &= ((m * n) * r) * (s * (p * t)) = ((m * n) * r) * ((s * t) * p) = ((m * n) * p) * ((s * t) * r) \\ &= (m * (p * n)) * ((s * t) * r) = (m * r) * ((s * t) * (p * n)). \quad \square \end{aligned}$$

Theorem 1. Assume that $(S, *)$ is a TA-groupoid.

- (1) If $\exists e \in S$ such that $(\forall a \in S) e * a = a$, then $(S, *)$ is a commutative semigroup.
- (2) If $e \in S$ is a left identity element in S , then e is an identity element in S .
- (3) If S is a right commutative CA-groupoid, then S is an AG-groupoid.
- (4) If S is a right commutative CA-groupoid, then S is a left commutative CA-groupoid.
- (5) If S is a left commutative CA-groupoid, then S is a right commutative CA-groupoid.
- (6) If S is a left commutative CA-groupoid, then S is an AG-groupoid.
- (7) If S is a left commutative semigroup, then S is a CA-groupoid.

Proof. It is easy to verify from the definitions, and the proof is omitted. \square

From the following example, we know that a right identity element in S may be not an identity element in S .

Example 6. TA-groupoid of order 6 is given in Table 6, and e_6 is a right identity element in S , but e_6 is not a left identity element in S .

Table 6. Cayley table on $S = \{e_1, e_2, e_3, e_4, e_5, e_6\}$.

*	e_1	e_2	e_3	e_4	e_5	e_6
e_1	e_1	e_1	e_1	e_1	e_1	e_1
e_2	e_2	e_2	e_2	e_2	e_2	e_2
e_3	e_1	e_1	e_4	e_6	e_1	e_3
e_4	e_1	e_1	e_6	e_3	e_1	e_4
e_5	e_2	e_2	e_5	e_5	e_2	e_5
e_6	e_1	e_1	e_3	e_4	e_1	e_6

By Theorem 1 (1) and (2) we know that the left identity element in a TA-groupoid is unique. But the following example shows that the right identity element in a TA-groupoid may be not unique.

Example 7. The following non-commutative TA-groupoid of order 5 given in Table 7. Moreover, x_1 and x_2 are right identity elements in S .

Table 7. Cayley table on $S = \{x_1, x_2, x_3, x_4, x_5\}$.

*	x_1	x_2	x_3	x_4	x_5
x_1	x_1	x_1	x_3	x_3	x_5
x_2	x_2	x_2	x_4	x_4	x_5
x_3	x_3	x_3	x_1	x_1	x_5
x_4	x_4	x_4	x_2	x_2	x_5
x_5	x_5	x_5	x_5	x_5	x_5

Theorem 2. *Let $(S, *)$ be a TA-groupoid.*

- (1) *If S is a left commutative AG-groupoid, then S is a CA-groupoid.*
- (2) *If S is a left commutative AG-groupoid, then S is a right commutative TA-groupoid.*
- (3) *If S is a right commutative AG-groupoid, then S is a left commutative TA-groupoid.*
- (4) *If S is a right commutative AG-groupoid, then S is a CA-groupoid.*
- (5) *If S is a left commutative semigroup, then S is an AG-groupoid.*

Proof. It is easy to verify from the definitions, and the proof is omitted. \square

Theorem 3. *Let $(S, *)$ be a groupoid.*

- (1) *If S is a CA-AG-groupoid and a semigroup, then S is a TA-groupoid.*
- (2) *If S is a CA-AG-groupoid and a TA-groupoid, then S is a semigroup.*
- (3) *If S is a semigroup, TA-groupoid and CA-groupoid, then S is an AG-groupoid.*
- (4) *If S is a semigroup, TA-groupoid and AG-groupoid, S is a CA-groupoid.*

Proof. (1) If $(S, *)$ is a CA-AG-groupoid and a semigroup, then by Definition 2, $\forall a, b, c \in S$:

$$b * (c * a) = c * (a * b) = (c * a) * b = (b * a) * c.$$

It follows that $(S, *)$ is a TA-groupoid by Definition 6.

(2) Assume that $(S, *)$ is a CA-AG-groupoid and a TA-groupoid, by Definition 2, $\forall a, b, c \in S$:

$$a * (b * c) = c * (a * b) = (c * b) * a = (a * b) * c.$$

This means that $(S, *)$ is a semigroup.

(3) Assume that $(S, *)$ is a semigroup, TA-groupoid and CA-groupoid. Then, we have ($\forall a, b, c \in S$):

$$(a * b) * c = a * (b * c) = c * (a * b) = (c * b) * a.$$

Thus, $(S, *)$ is an AG-groupoid.

(4) Suppose that $(S, *)$ is a semigroup, TA-groupoid and AG-groupoid. $\forall a, b, c \in S$:

$$c * (b * a) = (c * b) * a = (a * b) * c = a * (c * b).$$

That is, $(S, *)$ is a CA-groupoid by Definition 3. \square

Example 8. *Put $S = \{e, f, g, h, i\}$. The operation $*$ is defined on S in Table 8. We can get that $(S, *)$ is a CA-AG-groupoid. But $(S, *)$ is not a TA-groupoid, due to the fact that $(i * h) * i \neq i * (i * h)$. Moreover, $(S, *)$ is not a semigroup, because $(i * i) * i \neq i * (i * i)$.*

Table 8. Cayley table on $S = \{e, f, g, h, i\}$.

$*$	e	f	g	h	i
e	e	e	e	e	e
f	e	e	e	e	e
g	e	e	e	e	f
h	e	e	e	e	f
i	e	e	e	g	h

From Proposition 4, Theorems 1–3, Examples 4–5 and Example 8, we get the relationships among TA-groupoids and its closely linked algebraic systems, as shown in Figure 2.

Theorem 4. *Let $(S, *)$ be a TA-groupoid.*

- (1) *Every left cancellative element in S is right cancellative element;*
- (2) *if $x, y \in S$ and they are left cancellative elements, then $x*y$ is a left cancellative element;*
- (3) *if x is left cancellative and y is right cancellative, then $x*y$ is left cancellative;*
- (4) *if $x*y$ is right cancellative, then y is right cancellative;*
- (5) *If for all $a \in S, a^2 = a$, then it is associative. That is, S is a band.*

Proof. (1) Suppose that x is a left cancellative element in S . If $(\forall p, q \in S) p*x = q*x$, then:

$$\begin{aligned} x*(x*(x*p)) &= (x*(x*p))*x = ((x*p)*x)*x = (x*p)*(x*x) \\ &= x*((x*x)*p) = x*(x*(p*x)) = x*(x*(q*x)) \\ &= x*((x*x)*q) = (x*q)*(x*x) = ((x*q)*x)*x \\ &= (x*(x*q))*x = x*(x*(x*q)). \end{aligned}$$

From this, applying left cancellability, $x*(x*p) = x*(x*q)$. From this, applying left cancellability two times, we get that $p = q$. Therefore, x is right cancellative.

(2) If x and y are left cancellative, and $(\forall p, q \in S) (x*y)*p = (x*y)*q$, there are:

$$\begin{aligned} x*(x*(y*p)) &= x*((x*p)*y) = (x*y)*(x*p) \\ &= (x*p)*(x*y) \text{ (by Proposition 5 (1))} \\ &= x((x*y)*p) = x((xy)*p) = x((xy)*q) = x((x*y)*q) \\ &= (x*q)*(x*y) = (x*y)*(x*q) = x*((x*q)*y) \\ &= x*(x*(y*q)). \end{aligned}$$

Applying the left cancellation property of x , we have $y*p = y*q$. Moreover, since y is left cancellative, we can get that $p = q$. Therefore, $x*y$ is left cancellative.

(3) Suppose that x is left cancellative and y is right cancellative. If $(\forall p, q \in S) (x*y)*p = (x*y)*q$, there are:

$$x*(p*y) = (x*y)*p = (x*y)*q = x*(q*y).$$

Applying the left cancellation property of x , we have $p*y = q*y$. Moreover, since y is right cancellative, we can get that $p = q$. Therefore, $x*y$ is left cancellative.

(4) If $x*y$ is right cancellative, and $p*y = q*y, p, q \in S$, there are:

$$p*(x*y) = (p*y)*x = (q*y)*x = q*(x*y).$$

Applying the right cancellation property of $x*y$, we have $p = q$. Hence, we get that y is right cancellative. \square

(5) Assume that for all $a \in S, a^2 = a$. Then, $\forall r, s, t \in S$,

$$\begin{aligned} r*(s*t) &= (r*(s*t))*(r*(s*t)) = r*((r*(s*t))*(s*t)) \\ &= r*(r*((s*t)*(s*t))) = r*(r*(s*t)). \end{aligned} \tag{1}$$

Similarly, according to (1) we can get $r*(t*s) = r*(r*(t*s))$. And, by Proposition 5 (1), we have

$$\begin{aligned} r*(r*(s*t)) &= r*((r*t)*s) = (r*s)*(r*t) = (r*t)*(r*s) \\ &= r*((r*s)*t) = r*(r*(t*s)). \end{aligned}$$

Combining the results above, we get that $r^*(s*t) = r^*(r^*(s*t)) = r^*(r^*(t*s)) = r^*(t*s)$. Moreover, by Definition 6, $(r*s)*t = r^*(t*s)$. Thus

$$(r*s)*t = r^*(t*s) = r^*(s*t).$$

This means that S is a semigroup, and for all $a \in S, a^2 = a$.

Therefore, we get that S is a band. \square

Example 9. TA-groupoid of order 4, given in Table 9. It is easy to verify that $(S, *)$ is a band, due to the fact that $x*x = x, y*y = y, z*z = z, u*u = u$.

Table 9. Cayley table on $S = \{x, y, z, u\}$.

*	x	y	z	u
x	x	x	x	x
y	y	y	z	y
z	u	u	z	u
u	u	u	u	u

Definition 7. Assume that $(S_1, *_1)$ and $(S_2, *_2)$ are TA-groupoids, $S_1 \times S_2 = \{(a, b) | a \in S_1, b \in S_2\}$. Define the operation $*$ on $S_1 \times S_2$ as follows:

$$(a_1, a_2) * (b_1, b_2) = (a_1 *_1 b_1, a_2 *_2 b_2), \text{ for any } (a_1, a_2), (b_1, b_2) \in S_1 \times S_2.$$

Then $(S_1 \times S_2, *)$ is called the direct product of $(S_1, *_1)$ and $(S_2, *_2)$.

Theorem 5. If $(S_1, *_1)$ and $(S_2, *_2)$ are TA-groupoids, then their direct product $(S_1 \times S_2, *)$ is a TA-groupoid.

Proof. Assume that $(a_1, a_2), (b_1, b_2), (c_1, c_2) \in S_1 \times S_2$. Since

$$\begin{aligned} ((a_1, a_2) * (b_1, b_2)) * (c_1, c_2) &= (a_1 *_1 b_1, a_2 *_2 b_2) * (c_1, c_2) \\ &= ((a_1 *_1 b_1) *_1 c_1, (a_2 *_2 b_2) *_2 c_2) = (a_1 *_1 (c_1 *_1 b_1), a_2 *_2 (c_2 *_2 b_2)) \\ &= (a_1, a_2) * (c_1 *_1 b_1, c_2 *_2 b_2) = (a_1, a_2) * ((c_1, c_2) * (b_1, b_2)). \end{aligned}$$

Hence, $(S_1 \times S_2, *)$ is a TA-groupoid. \square

Theorem 6. Let $(S_1, *_1)$ and $(S_2, *_2)$ be two TA-groupoids, if x and y are cancellative ($x \in S_1, y \in S_2$), then $(x, y) \in S_1 \times S_2$ is cancellative.

Proof. Using Theorem 5, we can get that $S_1 \times S_2$ is a TA-groupoid. Moreover, for any $(s_1, s_2), (t_1, t_2) \in S_1 \times S_2$, if $(x, y) * (s_1, s_2) = (x, y) * (t_1, t_2)$, there are:

$$\begin{aligned} (xs_1, ys_2) &= (xt_1, yt_2) \\ xs_1 = xt_1, &ys_2 = yt_2. \end{aligned}$$

Since x and y are cancellative, so $s_1 = t_1, s_2 = t_2$, and $(s_1, s_2) = (t_1, t_2)$.

Therefore, (x, y) is cancellative. \square

5. Tarski Associative Neutrosophic Extended Triplet Groupoids (TA-NET-Groupoids) and Weak Commutative TA-NET-Groupoids (WC-TA-NET-Groupoids)

In this section, we first propose a new concept of TA-NET-groupoids and discuss its basic properties. Next, this section will discuss an important kind of TA-NET-groupoids, called weak

commutative TA-NET-groupoids (WC-TA-NET-groupoids). In particular, we proved some well-known properties of WC-TA-NET-groupoids.

Definition 8. Let $(S, *)$ be a neutrosophic extended triplet set. If

- (1) $(S, *)$ is well-defined, that is, $(\forall x, y \in S) x*y \in S$;
- (2) $(S, *)$ is Tarski associative, that is, for any $x, y, z \in S (x*y)*z = x*(z*y)$.

Then $(S, *)$ is called a Tarski associative neutrosophic extended triplet groupoid (or TA-NET-groupoid). A TA-NET-groupoid $(S, *)$ is called to be commutative, if $(\forall x, y \in S) x*y = y*x$.

According to the definition of the TA-NET-groupoid, element a may have multiple neutral elements $neut(a)$. We tried using the MATLAB math tools to find an example showing that an element's neutral element is not unique. Unfortunately, we did not find this example. This leads us to consider another possibility: every element in a TA-NET-groupoid has a unique neutral element? Fortunately, we successfully proved that this conjecture is correct.

Theorem 7. Let $(S, *)$ be a TA-NET-groupoid. Then the local unit element $neut(a)$ is unique in S .

Proof. For any $a \in S$, if there exists $s, t \in \{neut(a)\}$, then $\exists m, n \in S$ there are:

$$a * s = s * a = a \text{ and } a * m = m * a = s; a * t = t * a = a \text{ and } a * n = n * a = t.$$

(1) $s = t * s$. Since

$$s = a * m = (t * a) * m = t * (m * a) = t * s.$$

(2) $t = t * s$. Since

$$t = n * a = n * (s * a) = (n * a) * s = t * s.$$

Hence $s = t$ and $neut(a)$ is unique for any $a \in S$. \square

Remark 1. For element a in TA-NET-groupoid $(S, *)$, although $neut(a)$ is unique, we know from Example 10 that $anti(a)$ may be not unique.

Example 10. TA-NET-groupoid of order 6, given in Table 10. While $neut(\Delta) = \Delta, \{anti(\Delta)\} = \{\Delta, \Gamma, I, \vartheta, K\}$.

Table 10. Cayley table on $S = \{\Delta, \Gamma, I, \vartheta, K, \Lambda\}$.

*	Δ	Γ	I	ϑ	K	Λ
Δ	Δ	Δ	Δ	Δ	Δ	Δ
Γ	Δ	Γ	I	ϑ	K	Δ
I	Δ	I	K	Γ	ϑ	Δ
ϑ	Δ	ϑ	Γ	K	I	Δ
K	Δ	K	ϑ	I	Γ	Δ
Λ	Λ	Λ	Λ	Λ	Λ	Λ

Theorem 8. Let $(S, *)$ be a TA-NET-groupoid. Then $\forall x \in S$:

- (1) $neut(x) * neut(x) = neut(x)$;
- (2) $neut(neut(x)) = neut(x)$;
- (3) $anti(neut(x)) \in \{anti(neut(x))\}, x = anti(neut(x)) * x$.

Proof. (1) For any $x \in S$, according to $x * anti(x) = anti(x) * x = neut(x)$, we have

$$neut(x) * neut(x) = neut(x) * (anti(x) * x) = (neut(x) * x) * anti(x) = x * (anti(x)) = neut(x).$$

(2) $\forall x \in S$, by the definition of $neut(neut(x))$, there are:

$$neut(neut(x)) * neut(x) = neut(x) * neut(neut(x)) = neut(x).$$

Thus,

$$\begin{aligned} neut(neut(x)) * x &= neut(neut(x)) * (x * neut(x)) = (neut(neut(x)) * neut(x)) * x = neut(x) * x = x; \\ x * neut(neut(x)) &= (x * neut(x)) * neut(neut(x)) = x * (neut(neut(x)) * neut(x)) = x * neut(x) = x. \end{aligned}$$

Moreover, we can get:

$$anti(neut(x)) * neut(x) = neut(x) * anti(neut(x)) = neut(neut(x)).$$

Then,

$$\begin{aligned} (anti(neut(x)) * anti(x)) * x &= anti(neut(x)) * (x * anti(x)) = anti(neut(x)) * neut(x) = neut(neut(x)); \\ x * (anti(neut(x)) * anti(x)) &= (x * anti(x)) * anti(neut(x)) = neut(x) * anti(neut(x)) = neut(neut(x)). \end{aligned}$$

Combining the results above, we get

$$\begin{aligned} neut(neut(x)) * x &= x * neut(neut(x)) = x; \\ (anti(neut(x)) * anti(x)) * x &= x * (anti(neut(x)) * anti(x)) = neut(neut(x)). \end{aligned}$$

This means that $neut(neut(x))$ is a neutral element of x (see Definition 4). Applying Theorem 6, we get that $neut(neut(x)) = neut(x)$.

(3) For all $x \in S$, using Definition 8 and above (2),

$$\begin{aligned} anti(neut(x)) * x &= anti(neut(x)) * (x * neut(x)) = (anti(neut(x)) * neut(x)) * x \\ &= neut(neut(x)) * x = neut(x) * x = x. \end{aligned}$$

Thus, $anti(neut(x)) * x = x$. \square

Example 11. TA-NET-groupoid of order 4, given in Table 11. And $neut(\alpha) = \alpha$, $neut(\beta) = \beta$, $neut(\delta) = \delta$, $\{anti(\alpha)\} = \{\alpha, \delta, \epsilon\}$. While $anti(\alpha) = \delta$, $neut(anti(\alpha)) = neut(\delta) = \delta \neq \alpha = neut(\alpha)$.

Table 11. Cayley table on $S = \{\alpha, \beta, \delta, \epsilon\}$.

*	α	β	δ	ϵ
α	α	α	α	α
β	β	β	β	β
δ	α	α	δ	δ
ϵ	α	α	δ	ϵ

Theorem 9. Let $(S, *)$ be a TA-NET-groupoid. Then $\forall x \in S, \forall m, n \in \{anti(a)\}, \forall anti(a) \in \{anti(a)\}$:

- (1) $m * (neut(x)) = neut(x) * n$;
- (2) $anti(neut(x)) * anti(x) \in \{anti(x)\}$;
- (3) $neut(x) * anti(n) = x * neut(n)$;
- (4) $neut(m) * neut(x) = neut(x) * neut(m) = neut(x)$;

- (5) $(n^*(neut(x))^*x = x^*(neut(x))^*n) = neut(x);$
- (6) $neut(n)^*x = x.$

Proof. (1) By the definition of neutral and opposite element (see Definition 4), applying Theorem 6, there are:

(2) By Theorem 7(2), there are:

$$\begin{aligned} m^*x &= x^*m = neut(x), n^*x = x^*n = neut(x). \\ m^*(neut(x)) &= m^*(n^*x) = (m^*x)^*n = neut(x)^*n. \\ x^*[anti(neut(x))^*anti(x)] &= [x^*(anti(x))]^*anti(neut(x)) = neut(x)^*anti(neut(x)) \\ &= neut(neut(x)) = neut(x). \\ [anti(neut(x))^*anti(x)]^*x &= anti(neut(x))^*[x^*(anti(x))] = anti(neut(x))^*neut(x) \\ &= neut(neut(x)) = neut(x). \end{aligned}$$

Thus, $anti(neut(x))^*anti(x) \in \{anti(x)\}.$

(3) For any $x \in S, n \in \{anti(a)\},$ by $x^*n = n^*x = neut(x)$ and $n^*anti(n) = anti(n)^*n = neut(n),$ we get

$$x^*neut(n) = x^*[anti(n)^*n] = (x^*n)^*anti(n) = neut(x)^*anti(n).$$

This shows that $neut(x)^*anti(n) = x^*neut(n).$

(4) For any $x \in S, m \in \{anti(x)\},$ by $x^*m = m^*x = neut(x)$ and $anti(m)^*m = m^*anti(m) = neut(m),$ there are:

$$\begin{aligned} neut(m)^*neut(x) &= neut(m)^*(x^*m) = (neut(m)^*m)^*x = m^*x = neut(x). \\ neut(x)^*neut(m) &= neut(x)^*[m^*(anti(m))] = [neut(x)^*anti(m)]^*m. \end{aligned}$$

Applying (3), there are:

$$neut(x)^*neut(m) = [neut(x)^*anti(m)]^*m = [x^*(neut(m))]^*m = x^*(m^*(neut(m))) = x^*m = neut(x).$$

That is,

$$neut(m)^*neut(x) = neut(x)^*neut(m) = neut(x).$$

(5) By $x^*n = n^*x = neut(x),$ there are:

$$\begin{aligned} [n^*(neut(x))]^*x &= n^*(x^*(neut(x))) = n^*x = neut(x). \\ x^*[neut(x)^*n] &= (x^*n)^*(neut(x)) = neut(x)^*neut(x) = neut(x). \end{aligned}$$

Thus, $[n^*(neut(x))]^*x = x^*[neut(x)^*n] = neut(x).$

(6) For any $x \in S, n \in \{anti(x)\},$ by $x^*n = n^*x = neut(x),$

$$neut(n)^*x = neut(n)^*[x^*(neut(x))] = [neut(n)^*neut(x)]^*x.$$

From this, applying (4), there are:

$$neut(n)^*x = [neut(n)^*neut(x)]^*x = neut(x)^*x = x.$$

Hence, $neut(n)^*x = x. \square$

Proposition 6. Let $(S, *)$ be a TA-NET-groupoid. Then $\forall x, y, z \in S:$

- (1) $y^*x = z^*x,$ implies $neut(x)^*y = neut(x)^*z;$
- (2) $y^*x = z^*x,$ if and only if $y^*neut(x) = z^*neut(x).$

Proof. (1) For any $x, y \in S$, if $y^*x = z^*x$, then $anti(x)^*(y^*x) = anti(x)^*(z^*x)$. By Definition 6 and Definition 8 there are:

$$anti(x)^*(y^*x) = (anti(x)^*x)^*y = neut(x)^*y;$$

$$anti(x)^*(z^*x) = (anti(x)^*x)^*z = neut(x)^*z.$$

Thus $neut(x)^*y = anti(x)^*(y^*x) = anti(x)^*(z^*x) = neut(x)^*z$.

(2) For any $x, y \in S$, if $y^*x = z^*x$, then $(y^*x)^*anti(x) = (z^*x)^*anti(x)$. Since

$$(y^*x)^*anti(x) = y^*(anti(x)^*x) = y^*neut(x); (z^*x)^*anti(x) = z^*(anti(x)^*x) = z^*neut(x).$$

It follows that $y^*neut(x) = z^*neut(x)$. This means that $y^*x = z^*x$ implies $y^*neut(x) = z^*neut(x)$. Conversely, if $y^*neut(x) = z^*neut(x)$, then $(y^*neut(x))^*x = (z^*neut(x))^*x$. Since

$$(y^*neut(x))^*x = y^*(x^*neut(x)) = y^*x; (z^*neut(x))^*x = z^*(x^*neut(x)) = z^*x.$$

Thus, $y^*x = z^*x$. Hence, $y^*neut(x) = z^*neut(x)$ implies $y^*x = z^*x$. \square

Proposition 7. Suppose that $(S, *)$ is a commutative TA-NET-groupoid. $\forall x, y \in S$:

- (1) $neut(x) * neut(y) = neut(x * y)$;
- (2) $anti(x) * anti(y) \in \{anti(x * y)\}$.

Proof. (1) For any $x, y \in S$, since S is commutative, so $x * y = y * x$. From this, by Proposition 5(1), we have

$$(x^*y)^*(neut(x)^*neut(y)) = (y^*x)^*(neut(x)^*neut(y)) = (y^*neut(y))^*(neut(x)^*x) = y^*x = x^*y;$$

$$(neut(x)^*neut(y))^*(x^*y) = (neut(x)^*neut(y))^*(y^*x) = (neut(x)^*x)^*(y^*(neut(y))) = x^*y.$$

Moreover, using Proposition 5(1),

$$(anti(x)^*anti(y))^*(x^*y) = (anti(x)^*anti(y))^*(y^*x) = (anti(x)^*x)^*(y^*anti(y)) = neut(x)^*neut(y);$$

$$(x^*y)^*(anti(x)^*anti(y)) = (x^*y)^*(anti(y)^*anti(x)) = (x^*anti(x))^*(anti(y)^*y) = neut(x)^*neut(y).$$

This means that $neut(x)^*neut(y)$ is a neutral element of x^*y (see Definition 4). Applying Theorem 6, we get that $neut(x)^*neut(y) = neut(x^*y)$.

(2) For any $anti(x) \in \{anti(x)\}$, $anti(y) \in \{anti(y)\}$, by the proof of (1) above,

$$(anti(x)^*anti(y))^*(x^*y) = (x^*y)^*(anti(x)^*anti(y)) = neut(x)^*neut(y).$$

From this and applying (1), there are:

$$(anti(x)^*anti(y))^*(x^*y) = (x^*y)^*(anti(x)^*anti(y)) = neut(x^*y).$$

Hence, $anti(x)^*anti(y) \in \{anti(x^*y)\}$. \square

Definition 9. Let $(S, *)$ be a TA-NET-groupoid. If $(\forall x, y \in S) x * neut(y) = neut(y) * x$, then we said that S is a weak commutative TA-NET-groupoid (or WC-TA-NET-groupoid).

Proposition 8. Let $(S, *)$ be a TA-NET-groupoid. Then $(S, *)$ is weak commutative $\Leftrightarrow S$ satisfies the following conditions $(\forall x, y \in S)$:

- (1) $neut(x)^*neut(y) = neut(y)^*neut(x)$.
- (2) $neut(x)^*(neut(y)^*x) = neut(x)^*(x^*neut(y))$.

Proof. Assume that $(S, *)$ is a weak commutative TA-NET-groupoid, using Definition 9, there are $(\forall x, y \in S)$:

$$\begin{aligned} neut(x)*neut(y) &= neut(y)*neut(x), \\ neut(x)*(neut(y)*x) &= neut(x)*(x*neut(y)). \end{aligned}$$

In contrast, suppose that S satisfies the above conditions (1) and (2). there are $(\forall x, y \in S)$:

$$\begin{aligned} x*neut(y) &= (neut(x)*x)*neut(y) = neut(x)*(neut(y)*x) = neut(x)*(x*neut(y)) = \\ &= (neut(x)*neut(y))*x = (neut(y)*neut(x))*x = neut(y)*(x*neut(x)) = neut(y)*x. \end{aligned}$$

From Definition 9 and this we can get that $(S, *)$ is a weak commutative TA-NET-groupoid. \square

Theorem 10. Assume that $(S, *)$ is a weak commutative TA-NET-groupoid. Then $\forall x, y \in S$:

- (1) $neut(x)*neut(y) = neut(y*x)$;
- (2) $anti(x)*anti(y) \in \{anti(y*x)\}$;
- (3) $(S \text{ is commutative}) \Leftrightarrow (S \text{ is weak commutative})$.

Proof. (1) By Proposition 5 (1)), there are:

$$\begin{aligned} [neut(x)*neut(y)]*(y*x) &= [neut(x)*x]*[y*neut(y)] = [neut(x)*x]*[neut(y)*y] = \\ &= [neut(x)*y]*[neut(y)*x] = [y*neut(x)]*[x*neut(y)] = [y*neut(y)]*[x*neut(x)] = y*x. \end{aligned}$$

And, $(y*x)*[neut(x)*neut(y)] = [y*neut(y)]*[neut(x)*x] = y*x$. That is,

$$[neut(x)*neut(y)]*(y*x) = (y*x)*[neut(x)*neut(y)] = y*x.$$

And that, there are:

$$\begin{aligned} [anti(x)*anti(y)]*(y*x) &= [anti(x)*x]*[y*anti(y)] = neut(x)*neut(y); \\ (y*x)*[anti(x)*anti(y)] &= [y*anti(y)] * [anti(x)*x] = neut(y)*neut(x) = neut(x)*neut(y). \end{aligned}$$

That is,

$$[anti(x)*anti(y)]*(y*x) = (y*x)*[anti(x)*anti(y)] = neut(x)*neut(y).$$

Thus, combining the results above, we know that $neut(x)*neut(y)$ is a neutral element of $y*x$. Applying Theorem 6, we get $neut(x)*neut(y) = neut(y*x)$.

(2) Using (1) and the following result (see the proof of (1))

$$[anti(x)*anti(y)]*(y*x) = (y*x)*[anti(x)*anti(y)] = neut(x)*neut(y)$$

we can get that $anti(x)*anti(y) \in \{anti(y*x)\}$.

(3) If S is commutative, then S is weak commutative.

●n the other hand, suppose that S is a TA-NET-groupoid and S is weak commutative. By Proposition 5 (1) and Definition 9, there are:

$$\begin{aligned} x*y &= (x*neut(x))*(y*neut(y)) = (x*neut(y))*(y*neut(x)) = (neut(y)*x)*(neut(x)*y) \\ &= (neut(y)*y)*(neut(x)*x) = y*x. \end{aligned}$$

Therefore, S is a commutative TA-NET-groupoid. \square

6. Decomposition Theorem of TA-NET-Groupoids

This section generalizes the well-known Clifford's theorem in semigroup to TA-NET-groupoid, which is very exciting.

Theorem 11. *Let $(S, *)$ be a TA-NET-groupoid. Then for any $x \in S$, and all $m \in \{anti(a)\}$:*

- (1) $neut(x)*m \in \{anti(x)\}$;
- (2) $m*neut(x) = (neut(x)*m)*neut(x)$;
- (3) $neut(x)*m = (neut(x)*m)*neut(x)$;
- (4) $m*neut(x) = neut(x)*m$;
- (5) $neut(m*(neut(x))) = neut(x)$.

Proof. (1) For any $x \in S, m \in \{anti(x)\}$, we have $m*x = x*m = neut(x)$. Then, by Definition 6, Theorem 7 (1) and Proposition 5 (1), there are:

$$x*[neut(x)*m] = (x*m)*neut(x) = neut(x)*neut(x) = neut(x);$$

$$[neut(x)*m]*x = [neut(x)*m]*[x*neut(x)] = [neut(x)*neut(x)]*(x*m) = [neut(x)*neut(x)]*neut(x) = neut(x).$$

This means that $neut(x)*m \in \{anti(x)\}$.

(2) If $x \in S, m \in \{anti(x)\}$, then $m*x = x*m = neut(x)$. Applying (1) and Theorem 8 (1),

$$m*neut(x) = neut(x)*[neut(x)*m].$$

● On the other hand, using Theorem 7 (1) and Proposition 5 (1), there are:

$$neut(x)*[neut(x)*m] = (neut(x)*neut(x))*[neut(x)*m] = [neut(x)*m]*[neut(x)*neut(x)] = [neut(x)*m]*neut(x).$$

Combining two equations above, we get $m*neut(x) = (neut(x)*m)*neut(x)$.

(3) Assume that $m \in \{anti(x)\}$, then $x*m = m*x = neut(x)$ and $m*neut(m) = neut(m)*m = m$. By Theorem 7 (1), Proposition 5 (1) and Theorem 8 (4), there are:

$$neut(x)*m = [neut(x)*neut(x)]*(neut(m)*m) = (neut(x)*m)[neut(m)*neut(x)] = (neut(x)*m)*neut(x).$$

That is, $neut(x)*m = (neut(x)*m)*neut(x)$.

(4) It follows from (2) and (3).

(5) Assume $m \in \{anti(x)\}$, then $x*m = m*x = neut(x)$. Denote $t = m*neut(x)$. We prove the following equations,

$$t*neut(x) = neut(x)*t = t; t*x = x*t = neut(x).$$

By (3) and (4), there are:

$$t*neut(x) = (m*neut(x))*neut(x) = (neut(x)*m)*neut(x) = neut(x)*m = m*neut(x) = t.$$

Using Definition 6, Theorem 7 (1) and Theorem 8 (1), there are:

$$neut(x)*t = neut(x)*[m*(neut(x))] = (neut(x)*neut(x))*m = neut(x)*m = m*neut(x) = t.$$

Moreover, applying Proposition 5 (1), Theorem 7 (1) and Definition 6, there are:

$$\begin{aligned}
 t*x &= [m*(neut(x))] * x = [m*neut(x)] * (neut(x)*x) = (m*x)*[neut(x)*neut(x)] \\
 &= neut(x)*[neut(x)*neut(x)] = neut(x). \\
 x*t &= x*[m*(neut(x))] = [x*neut(x)] * m = x*m = neut(x).
 \end{aligned}$$

Thus,

$$t*neut(x) = neut(x)*t = t; t*x = x*t = neut(x).$$

By the definition of neutral element and Theorem 6, we get that $neut(x)$ is the neutral element of $t = m*neut(x)$. This means that $neut(m*(neut(x))) = neut(x)$. \square

Theorem 12. *Let $(S, *)$ be a TA-NET-groupoid. Then the product of idempotents is still idempotent. That is for any $y_1, y_2 \in S, (y_1 * y_2) * (y_1 * y_2) = y_1 * y_2$.*

Proof. Assume that $y_1, y_2 \in S$ and $(y_1*y_1 = y_1, y_2*y_2 = y_2)$, then:

$$(y_1*y_2)*(y_1*y_2) = y_1*[(y_1*y_2)*y_2] = y_1*[y_1*(y_2*y_2)] = y_1*(y_1*y_2).$$

From this, applying Definition 4 and Definition 6,

$$\begin{aligned}
 y_1*y_2 &= [neut(y_1*y_2)]*(y_1*y_2) = [anti(y_1*y_2)*(y_1*y_2)]*(y_1*y_2) = anti(y_1*y_2)*[(y_1*y_2)*(y_1*y_2)] \\
 &= anti(y_1*y_2)*[y_1*(y_1*y_2)] \text{ (By } (y_1*y_2)*(y_1*y_2) = y_1*(y_1*y_2)\text{)} \\
 &= [anti(y_1*y_2)*(y_1*y_2)]*y_1 = neut(y_1*y_2)*y_1.
 \end{aligned}$$

Thus,

$$\begin{aligned}
 (y_1*y_2)*(y_1*y_2) &= y_1*(y_1*y_2) = (y_1*y_2)*y_1 \\
 &= [neut(y_1*y_2)*y_1]*y_1 \text{ (By } y_1*y_2 = [neut(y_1*y_2)]*y_1\text{)} \\
 &= neut(y_1*y_2)*(y_1*y_1) = neut(y_1*y_2)*y_1 = y_1*y_2.
 \end{aligned}$$

This means that the product of idempotents is still idempotent. \square

Example 12. TA-NET-groupoid of order 4, given in Table 12, and the product of any two idempotent elements is still idempotent, due to the fact that,

$$\begin{aligned}
 (z_1 * z_2) * (z_1 * z_2) &= z_1 * z_2, (z_1 * z_3) * (z_1 * z_3) = z_1 * z_3, (z_1 * z_4) * (z_1 * z_4) = z_1 * z_4, \\
 (z_2 * z_3) * (z_2 * z_3) &= z_2 * z_3, (z_2 * z_4) * (z_2 * z_4) = z_2 * z_4, (z_3 * z_4) * (z_3 * z_4) = z_3 * z_4.
 \end{aligned}$$

Table 12. Cayley table on $S = \{z_1, z_2, z_3, z_4\}$.

*	z_1	z_2	z_3	z_4
z_1	z_1	z_1	z_1	z_4
z_2	z_2	z_2	z_2	z_4
z_3	z_1	z_1	z_3	z_4
z_4	z_4	z_4	z_4	z_4

Theorem 13. *Let $(S, *)$ be a TA-NET-groupoid. Denote $E(S)$ be the set of all different neutral element in $S, S(e) = \{a \in S \mid neut(a) = e\} (\forall e \in E(S))$. Then:*

- (1) $S(e)$ is a subgroup of S .
- (2) for any $e_1, e_2 \in E(S), e_1 \neq e_2 \Rightarrow S(e_1) \cap S(e_2) = \emptyset$.
- (3) $S = \cup_{e \in E(S)} S(e)$.

Proof. (1) For any $m \in S(e)$, $neut(m) = e$. That is, e is an identity element in $S(e)$. And, using Theorem 7 (1), we get $e * e = e$.

Assume that $m, n \in S(e)$, then $neut(m) = neut(n) = e$. We're going to prove that $neut(m*n) = e$.

Applying Definition 6, Proposition 5 (1),

$$\begin{aligned} (m*n)*e &= m*(e*n) = m*n; \\ e*(m*n) &= (e*e)*(m*n) = (e*n)*(m*e) = (e*n)*m \\ &= (e*n)*(e*m) = (e*m)*(e*n) = m*n. \end{aligned}$$

On the other hand, for any $anti(m) \in \{anti(m)\}$, $anti(n) \in \{anti(n)\}$, by Proposition 5 (1), we have

$$\begin{aligned} (m*n)*[anti(m)*anti(n)] &= (m*anti(n))*(anti(m)*n) = [(m*anti(n))*n]*anti(m) \\ &= [m*(n*anti(n))]*anti(m) = (m*neut(n))*anti(m) = (m*e)*anti(m) \\ &= m*anti(m) = neut(m) = e. \\ [anti(m)*anti(n)]*(m*n) &= [anti(m)*n]*[m*anti(n)] = anti(m)*[(m*anti(n))*n] \\ &= anti(m)*[m*(n*anti(n))] = anti(m)*(m*neut(n)) = anti(m)*(m*e) \\ &= anti(m)*m = neut(m) = e. \end{aligned}$$

From this, using Theorem 6 and Definition 4, we know that $neut(m*n) = e$. Therefore, $m*n \in S(e)$, i.e., $(S(e), *)$ is a sub groupoid.

Moreover, $\forall m \in S(e)$, $\exists q \in S$ such that $q \in \{anti(m)\}$. Applying Theorem 10 (1)(2)(3), $q*neut(m) \in \{anti(m)\}$; and applying Theorem 10 (5), $neut(q*neut(m)) = neut(m)$.

Put $t = q*neut(m)$, we get

$$\begin{aligned} t &= q*neut(m) \in \{anti(m)\}, \\ neut(t) &= neut(q*neut(m)) = neut(m) = e. \end{aligned}$$

Thus $t \in \{anti(m)\}$, $neut(t) = e$, i.e., $t \in S(e)$ and t is the inverse element of m in $S(e)$.

Hence, $(S(e), *)$ is a subgroup of S .

(2) Let $x \in S(e_1) \cap S(e_2)$ and $e_1, e_2 \in E(S)$. We have $neut(x) = e_1, neut(x) = e_2$. Using Theorem 6, $e_1 = e_2$. Therefore, $e_1 \neq e_2 \Rightarrow S(e_1) \cap S(e_2) = \emptyset$.

(3) For any $x \in S$, there exists $neut(x) \in S$. Denote $e = neut(x)$, then $e \in E(S)$ and $x \in S(e)$.

This means that $S = \cup_{e \in E(S)} S(e)$. \square

Example 13. Table 13 represents a TA-NET-groupoid of order 5. And,

$$\begin{aligned} neut(m_1) &= m_4, anti(m_1) = m_1; neut(m_2) = m_3, anti(m_2) = m_2; \\ neut(m_3) &= m_3, anti(m_3) = \{m_3, m_5\}; neut(m_4) = m_4, anti(m_4) = m_4; neut(m_5) = m_5, anti(m_5) = m_5. \end{aligned}$$

Table 13. Cayley table on $S = \{m_1, m_2, m_3, m_4, m_5\}$.

*	m_1	m_2	m_3	m_4	m_5
m_1	m_4	m_4	m_1	m_1	m_1
m_2	m_3	m_3	m_2	m_2	m_2
m_3	m_2	m_2	m_3	m_3	m_3
m_4	m_1	m_1	m_4	m_4	m_4
m_5	m_2	m_2	m_3	m_3	m_5

Denote $S_1 = \{m_1, m_4\}$, $S_2 = \{m_2, m_3\}$, $S_3 = \{m_5\}$, then S_1, S_2 and S_3 are subgroup of S , and $S = S_1 \cup S_2 \cup S_3, S_1 \cap S_2 = \emptyset, S_1 \cap S_3 = \emptyset, S_2 \cap S_3 = \emptyset$.

Example 14. Table 14 represents a TA-NET-groupoid of order 5. And,

$$\begin{aligned} &neut(x) = x, anti(x) = x; neut(y) = y, \{anti(y)\} = \{y, v\}; \\ &neut(z) = y, \{anti(z)\} = \{z, v\}; neut(u) = u, \{anti(u)\} = \{y, z, u, v\}; neut(v) = v, anti(v) = v. \end{aligned}$$

Denote $S_1 = \{x\}$, $S_2 = \{y, z\}$, $S_3 = \{u\}$, $S_4 = \{v\}$, then S_1, S_2, S_3 and S_4 are subgroup of S , and $S = S_1 \cup S_2 \cup S_3 \cup S_4, S_1 \cap S_2 = \emptyset, S_1 \cap S_3 = \emptyset, S_1 \cap S_4 = \emptyset, S_2 \cap S_3 = \emptyset, S_2 \cap S_4 = \emptyset, S_3 \cap S_4 = \emptyset$.

Table 14. Cayley table on $S = \{x, y, z, u, v\}$.

*	<i>x</i>	<i>y</i>	<i>z</i>	<i>u</i>	<i>v</i>
<i>x</i>	<i>x</i>	<i>x</i>	<i>x</i>	<i>x</i>	<i>x</i>
<i>y</i>	<i>u</i>	<i>y</i>	<i>z</i>	<i>u</i>	<i>y</i>
<i>z</i>	<i>u</i>	<i>z</i>	<i>y</i>	<i>u</i>	<i>z</i>
<i>u</i>	<i>u</i>	<i>u</i>	<i>u</i>	<i>u</i>	<i>u</i>
<i>v</i>	<i>u</i>	<i>y</i>	<i>z</i>	<i>u</i>	<i>v</i>

Open Problem. Are there some TA-NET-groupoids which are not semigroups?

7. Conclusions

In this study, we introduce the new notions of TA-groupoid, TA-NET-groupoid, discuss some fundamental characteristics of TA-groupoids and established their relations with some related algebraic systems (see Figure 2), and prove a decomposition theorem of TA-NET-groupoid (see Theorem 13). Studies have shown that TA-groupoids have important research value, provide methods for studying other non-associated algebraic structures, and provide new ideas for solving algebraic problems. This study obtains some important results:

- (1) The concepts of commutative semigroup and commutative TA-groupoid are equivalent.
- (2) Every TA-groupoid with left identity element is a monoid.
- (3) A TA-groupoid is a band if each element is idempotent (see Theorem 4 and Example 9).
- (4) In a Tarski associative neutrosophic extended triplet groupoid (TA-NET-groupoid), the local unit element $neut(a)$ is unique (see Theorem 7).
- (5) The concepts of commutative TA-groupoid and WC-TA-groupoid are equivalent.
- (6) In a TA-NET-groupoid, the product of two idempotent elements is still idempotent (see Theorem 12 and Example 12).
- (7) Every TA-NET-groupoid is factorable (see Theorem 13 and Example 13–14).

Those results are of great significance to study the structural characteristics of TA-groupoids and TA-NET-groupoids. As the next research topic, we will study the Green relations on TA-groupoids and some relationships among related algebraic systems (see [23,25,28]).

Funding: This research was funded by National Natural Science Foundation of China grant number 61976130.

References

1. Dickson, L.E. Book Review: *Éléments de la Théorie des Groupes Abstraits*. *Bull. Amer. Math. Soc.* **1904**, *11*, 159–162. [[CrossRef](#)]
2. Clifford, A.H.; Preston, G.B. *The Algebraic Theory of Semigroups*; American Mathematical Society: Providence, RI, USA, 1961.
3. Holgate, P. Groupoids satisfying a simple invertive law. *Math. Stud.* **1992**, *61*, 101–106.
4. Howie, J.M. *Fundamentals of Semigroup Theory*; Oxford University Press: Oxford, UK, 1995.
5. Akinmoyewa, J.T. A study of some properties of generalized groups. *Octagon* **2009**, *17*, 599–626.
6. Suschkewitsch, A. On a generalization of the associative law. *Transactions of the American Mathematical Society.* **1929**, *31*, 204–214. [[CrossRef](#)]
7. Hosszu, M. Some functional equations related with the associative law. *Publ. Math. Debrecen* **1954**, *3*, 205–214.
8. Maksa, G. CM solutions of some functional equations of associative type. *Ann. Univ. Sci. Budapest. Sect. Comput.* **2004**, *24*, 125–132.
9. Schölzel, K.; Tomaschek, J. Power series solutions of Tarski's associativity law and of the cyclic associativity law. *Aequat. Math.* **2016**, *90*, 411–425. [[CrossRef](#)]
10. Thedy, A. Ringe mit $x(yz) = (yx)z$. *Mathematische Zeitschriften.* **1967**, *99*, 400–404. [[CrossRef](#)]
11. Phillips, J.D.; Vojtechovský, P. Linear groupoids and the associated wreath products. *J. Symb. Comput.* **2005**, *40*, 1106–1125. [[CrossRef](#)]
12. Pushkashu, D.I. Para-associative groupoids. *Quasigroups Relat. Syst.* **2010**, *18*, 187–194.
13. Weinstein, A. Groupoids: Unifying internal and external symmetry. A tour through some examples. *Not. AMS* **1996**, *43*, 744–752.
14. Kazim, M.A.; Naseeruddin, M. On almost semigroups. *Alig. Bull. Math.* **1972**, *2*, 1–7.
15. Shah, M.; Shah, T.; Ali, A. On the cancellativity of AG-groupoids. *Int. Math. Forum* **2011**, *6*, 2187–2194.
16. Stevanovic, N.; Protic, P.V. Some decomposition on Abel-Grassmann's groupoids. *PU. M. A.* **1997**, *8*, 355–366.
17. Shah, M.; Ali, A.; Ahmad, I. On introduction of new classes of AG-groupoids. *Res. J. Recent Sci.* **2013**, *2*, 67–70.
18. Mushtaq, Q.; Khan, M. Direct product of Abel-Grassmann's groupoids. *J. Interdiscip. Math.* **2008**, *11*, 461–467. [[CrossRef](#)]
19. Mushtaq, Q.; Kamran, M.S. On LA-semigroups with weak associative law. *Sci. Khyber.* **1989**, *1*, 69–71.
20. Ahmad, I.; Rashad, M.; Shah, M. Some properties of AG*-groupoid. *Res. J. Recent Sci.* **2013**, *2*, 91–93.
21. Iqbal, M.; Ahmad, I.; Shah, M.; Ali, M.I. On cyclic associative Abel-Grassman groupoids. *Br. J. Math. Comput. Sci.* **2016**, *12*, 1–16. [[CrossRef](#)]
22. Iqbal, M.; Ahmad, I. On further study of CA-AG-groupoids. *Proc. Pakistan Acad. Sci. A. Phys. Comput. Sci.* **2016**, *53*, 325–337.
23. Zhang, X.H.; Ma, Z.R.; Yuan, W.T. Cyclic associative groupoids (CA-groupoids) and cyclic associative neutrosophic extended triplet groupoids (CA-NET-groupoids). *Neutrosophic Sets Syst.* **2019**, *29*, 19–29.
24. Smarandache, F. *Neutrosophic Perspectives: Triplets, Duplets, Multisets, Hybrid Operators, Modal Logic, Hedge Algebras and Applications*; Pons Publishing House: Brussels, Belgium, 2017.
25. Zhang, X.H.; Wu, X.Y.; Mao, X.Y.; Smarandache, F.; Park, C. On neutrosophic extended triplet groups (loops) and Abel-Grassmann's groupoids (AG-groupoids). *J. Intell. Fuzzy Syst.* **2019**, *37*, 5743–5753. [[CrossRef](#)]
26. Smarandache, F.; Ali, M. Neutrosophic triplet group. *Neural Comput. Appl.* **2018**, *29*, 595–601.
27. Golan, J.S. *Semirings and Their Applications*; Springer: Dordrecht, The Netherlands, 1999.
28. Zhang, X.H.; Borzooei, R.A.; Jun, Y.B. Q-filters of quantum B-algebras and basic implication algebras. *Symmetry* **2018**, *10*, 573. [[CrossRef](#)]

Properties of Productional NeutroOrderedSemigroups

Madeleine Al-Tahan, Bijan Davvaz, Florentin Smarandache, Osman Anis

Madeleine Al-Tahan, Bijan Davvaz, Florentin Smarandache, Osman Anis (2021). Properties of Productional NeutroOrderedSemigroups. *Neutrosophic Sets and Systems* 42, 178-190

Abstract. The introducing of NeutroAlgebra by Smarandache opened the door for researchers to define many related new concepts. NeutroOrderedAlgebra was one of these new related definitions. The aim of this paper is to study productional NeutroOrderedSemigroup. In this regard, we firstly present many examples and study subsets of productional NeutroOrderedSemigroups. Then, we find sufficient conditions for the productional NeutroSemigroup to be a NeutroOrderedSemigroup. Finally, we find sufficient conditions for subsets of the productional NeutroOrderedSemigroup to be NeutroOrderedSubSemigroups, NeutroOrderedIdeals, and NeutroOrderedFilters.

Keywords: NeutroSemigroup, NeutrosOrderedSemigroup, NeutroOrderedIdeal, NeutroOrderedFilter, Productional NeutroOrderedSemigroup.

1. Introduction

Smarandache [1–3] introduced NeutroAlgebra as a generalization of the known Algebra. It is known that in an Algebra, operations are well defined and axioms are always true whereas for NeutroAlgebra, operations and axioms are partially true, partially indeterminate, and partially false. The latter is considered as an extension of Partial Algebra where operations and axioms are partially true and partially false. Many researchers worked on special types of NeutroAlgebras by applying them to different types of algebraic structures such as semigroups, groups, rings, *BE*-Algebras, *CI*-Algebras, *BCK*-Algebras, etc. For more details about NeutroStructures, the reader may see [4–8]. In order on it that satisfies the monotone property, we get an Ordered Algebra (as illustrated in Figure 1). And starting with a partial order on a

FIGURE 1. Ordered Algebra

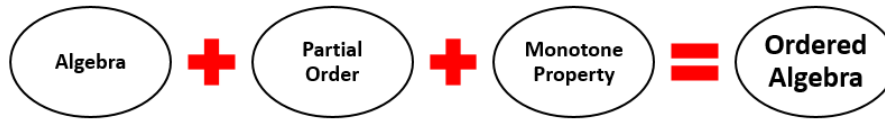

NeutroAlgebra, we get a NeutroStructure. The latter if it satisfies the conditions of **Neutro-Order**, it becomes a NeutroOrderedAlgebra (as illustrated in Figure 2). In [9], the authors

FIGURE 2. NeutroOrderedAlgebra

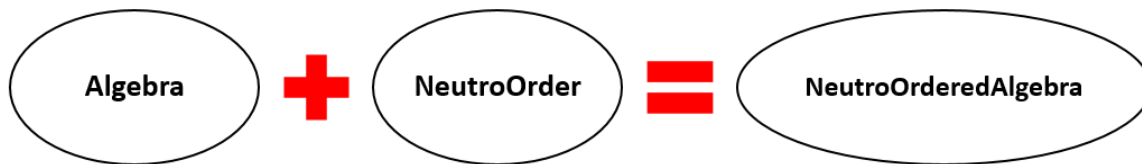

defined NeutroOrderedAlgebra and applied it to semigroups by studying NeutroOrderedSemigroups and their subsets such as NeutrosOrderedSubSemigroups, NeutroOrderedIdeals, and NeutroOrderedFilters.

Our paper is concerned about Cartesian product of NeutroOrderedSemigroups and the remainder part of it is as follows: In Section 2, we present some definitions and examples related to NeutroOrderedSemigroups. In Section 3, we define productional NeutroOrderedSemigroup and find sufficient conditions for the Cartesian product of NeutroSemigroups and semigroups to be NeutroOrderedSemigroups. Finally in Section 4, we find sufficient conditions for subsets of the productional NeutroOrderedSemigroup to be NeutroOrderedSubSemigroups, NeutroOrderedIdeals, and NeutroOrderedFilters.

2. NeutroOrderedSemigroups

In this section, we present some definitions and examples about NeutroOrderedSemigroups, introduced and studied by the authors in [9], that are used throughout the paper.

Definition 2.1. [10] Let (S, \cdot) be a semigroup (“ \cdot ” is an associative and a binary closed operation) and “ \leq ” a partial order on S . Then (S, \cdot, \leq) is an *ordered semigroup* if for every $x \leq y \in S$, $z \cdot x \leq z \cdot y$ and $x \cdot z \leq y \cdot z$ for all $z \in S$.

Definition 2.2. [10] Let (S, \cdot, \leq) be an ordered semigroup and $\emptyset \neq M \subseteq S$. Then

- (1) M is an *ordered subsemigroup* of S if (M, \cdot, \leq) is an ordered semigroup and $(x] \subseteq M$ for all $x \in M$. i.e., if $y \leq x$ then $y \in M$.
- (2) M is an *ordered left ideal* of S if M is an ordered subsemigroup of S and for all $x \in M$, $r \in S$, we have $rx \in M$.
- (3) M is an *ordered right ideal* of S if M is an ordered subsemigroup of S and for all $x \in M$, $r \in S$, we have $xr \in M$.
- (4) M is an *ordered ideal* of S if M is both: an ordered left ideal of S and an ordered right ideal of S .
- (5) M is an *ordered filter* of S if (M, \cdot) is a semigroup and for all $x, y \in S$ with $x \cdot y \in M$, we have $x, y \in M$ and $(y] \subseteq M$ for all $y \in M$. i.e., if $y \in M$ with $y \leq x$ then $x \in M$.

For more details about semigroup theory and ordered algebraic structures, we refer to [10, 11].

Definition 2.3. [2] Let A be any non-empty set and “ \cdot ” be an operation on A . Then “ \cdot ” is called a *NeutroOperation* on A if the following conditions hold.

- (1) There exist $x, y \in A$ with $x \cdot y \in A$. (This condition is called degree of truth, “ T ”.)
- (2) There exist $x, y \in A$ with $x \cdot y \notin A$. (This condition is called degree of falsity, “ F ”.)
- (3) There exist $x, y \in A$ with $x \cdot y$ is indeterminate in A . (This condition is called degree of indeterminacy, “ I ”.)

Where (T, I, F) is different from $(1, 0, 0)$ that represents the classical binary closed operation, and from $(0, 0, 1)$ that represents the AntiOperation.

Definition 2.4. [2] Let A be any non-empty set and “ \cdot ” be an operation on A . Then “ \cdot ” is called a *NeutroAssociative* on A if there exist $x, y, z, a, b, c, e, f, g \in A$ satisfying the following conditions.

- (1) $x \cdot (y \cdot z) = (x \cdot y) \cdot z$; (This condition is called degree of truth, “ T ”.)
- (2) $a \cdot (b \cdot c) \neq (a \cdot b) \cdot c$; (This condition is called degree of falsity, “ F ”.)
- (3) $e \cdot (f \cdot g)$ is indeterminate or $(e \cdot f) \cdot g$ is indeterminate or we can not find if $e \cdot (f \cdot g)$ and $(e \cdot f) \cdot g$ are equal. (This condition is called degree of indeterminacy, “ I ”.)

Where (T, I, F) is different from $(1, 0, 0)$ that represents the classical associative axiom, and from $(0, 0, 1)$ that represents the AntiAssociativeAxiom.

Definition 2.5. [2] Let A be any non-empty set and “ \cdot ” be an operation on A . Then (A, \cdot) is called a *NeutroSemigroup* if “ \cdot ” is either a NeutroOperation or NeutroAssociative.

Definition 2.6. [9] Let (S, \cdot) be a NeutroSemigroup and “ \leq ” be a partial order (reflexive, anti-symmetric, and transitive) on S . Then (S, \cdot, \leq) is a *NeutroOrderedSemigroup* if the following conditions hold.

- (1) There exist $x \leq y \in S$ with $x \neq y$ such that $z \cdot x \leq z \cdot y$ and $x \cdot z \leq y \cdot z$ for all $z \in S$. (This condition is called degree of truth, “ T ”.)
- (2) There exist $x \leq y \in S$ and $z \in S$ such that $z \cdot x \not\leq z \cdot y$ or $x \cdot z \not\leq y \cdot z$. (This condition is called degree of falsity, “ F ”.)
- (3) There exist $x \leq y \in S$ and $z \in S$ such that $z \cdot x$ or $z \cdot y$ or $x \cdot z$ or $y \cdot z$ are indeterminate, or the relation between $z \cdot x$ and $z \cdot y$, or the relation between $x \cdot z$ and $y \cdot z$ are indeterminate. (This condition is called degree of indeterminacy, “ I ”.)

Where (T, I, F) is different from $(1, 0, 0)$ that represents the classical Ordered Semigroup, and from $(0, 0, 1)$ that represents the AntiOrderedSemigroup.

Definition 2.7. [9] Let (S, \cdot, \leq) be a NeutroOrderedSemigroup . If “ \leq ” is a total order on A then A is called *NeutroTotalOrderedSemigroup*.

Example 2.8. [9] Let $S_1 = \{s, a, m\}$ and (S_1, \cdot_1) be defined by the following table.

\cdot_1	s	a	m
s	s	m	s
a	m	a	m
m	m	m	m

By defining the total order

$$\leq_1 = \{(m, m), (m, s), (m, a), (s, s), (s, a), (a, a)\}$$

on S_1 , we get that (S_1, \cdot_1, \leq_1) is a NeutroTotalOrderedSemigroup.

Example 2.9. Let $S_2 = \{0, 1, 2, 3\}$ and (S_2, \cdot'_2) be defined by the following table.

\cdot'_2	0	1	2	3
0	0	0	0	0
1	0	1	1	1
2	0	1	3	2
3	0	1	3	2

By defining the partial order

$$\leq'_2 = \{(0, 0), (0, 1), (0, 2), (1, 1), (2, 2), (3, 3)\}$$

on S_2 , we get that (S_2, \cdot'_2, \leq'_2) is a NeutroOrderedSemigroup.

Example 2.10. [9] Let $S_3 = \{0, 1, 2, 3, 4\}$ and (S_3, \cdot_3) be defined by the following table.

\cdot_3	0	1	2	3	4
0	0	0	0	3	0
1	0	1	2	1	1
2	0	4	2	3	3
3	0	4	2	3	3
4	0	0	0	4	0

By defining the partial order

$$\leq_3 = \{(0, 0), (0, 1), (0, 3), (0, 4), (1, 1), (1, 3), (1, 4), (2, 2), (3, 3), (3, 4), (4, 4)\}$$

on S_3 , we get that (S_3, \cdot_3, \leq_3) is a NeutroOrderedSemigroup.

Example 2.11. Let \mathbb{Z} be the set of integers and define “ \star ” on \mathbb{Z} as follows: $x \star y = xy - 2$ for all $x, y \in \mathbb{Z}$. We define the partial order “ \leq_\star ” on \mathbb{Z} as $-2 \leq_\star x$ for all $x \in \mathbb{Z}$ and for $a, b \geq -2$, $a \leq_\star b$ is equivalent to $a \leq b$ and for $a, b < -2$, $a \leq_\star b$ is equivalent to $a \geq b$. In this way, we get $-2 \leq_\star -1 \leq_\star 0 \leq_\star 1 \leq_\star \dots$ and $-2 \leq_\star -3 \leq_\star -4 \leq_\star \dots$. Then $(\mathbb{Z}, \star, \leq_\star)$ is a NeutroOrderedSemigroup.

Definition 2.12. [9] Let (S, \cdot, \leq) be a NeutroOrderedSemigroup and $\emptyset \neq M \subseteq S$. Then

- (1) M is a *NeutroOrderedSubSemigroup* of S if (M, \cdot, \leq) is a NeutroOrderedSemigroup and there exist $x \in M$ with $[x] = \{y \in S : y \leq x\} \subseteq M$.
- (2) M is a *NeutroOrderedLeftIdeal* of S if M is a NeutroOrderedSubSemigroup of S and there exists $x \in M$ such that $r \cdot x \in M$ for all $r \in S$.
- (3) M is a *NeutroOrderedRightIdeal* of S if M is a NeutroOrderedSubSemigroup of S and there exists $x \in M$ such that $x \cdot r \in M$ for all $r \in S$.
- (4) M is a *NeutroOrderedIdeal* of S if M is a NeutroOrderedSubSemigroup of S and there exists $x \in M$ such that $r \cdot x \in M$ and $x \cdot r \in M$ for all $r \in S$.
- (5) M is a *NeutroOrderedFilter* of S if (M, \cdot, \leq) is a NeutroOrderedSemigroup and there exists $x \in S$ such that for all $y, z \in S$ with $x \cdot y \in M$ and $z \cdot x \in M$, we have $y, z \in M$ and there exists $y \in M$ $[y] = \{x \in S : y \leq x\} \subseteq M$.

Definition 2.13. [9] Let (A, \star, \leq_A) and (B, \otimes, \leq_B) be NeutroOrderedSemigroups and $\phi : A \rightarrow B$ be a function. Then

- (1) ϕ is called *NeutroOrderedHomomorphism* if $\phi(x \star y) = \phi(x) \otimes \phi(y)$ for some $x, y \in A$ and there exist $a \leq_A b \in A$ with $a \neq b$ such that $\phi(a) \leq_B \phi(b)$.
- (2) ϕ is called *NeutroOrderedIsomorphism* if ϕ is a bijective NeutroOrderedHomomorphism.

- (3) ϕ is called *NeutroOrderedStrongHomomorphism* if $\phi(x \star y) = \phi(x) \otimes \phi(y)$ for all $x, y \in A$ and $a \leq_A b \in A$ is equivalent to $\phi(a) \leq_B \phi(b) \in B$.
- (4) ϕ is called *NeutroOrderedStrongIsomomorphism* if ϕ is a bijective NeutroOrderedStrongHomomorphism.

Example 2.14. Let (S_3, \cdot_3, \leq_3) be the NeutroOrderedSemigroup presented in Example 2.10. Then $I = \{0, 1, 2\}$ is both: a NeutroOrderedLeftIdeal and a NeutroOrderedRightIdeal of S_3 .

Example 2.15. Let $(\mathbb{Z}, \star, \leq_\star)$ be the NeutroOrderedSemigroup presented in Example 2.11. Then $I = \{-2, -1, 0, 1, -2, -3, -4, \dots\}$ is a NeutroOrderedIdeal of \mathbb{Z} .

Example 2.16. Let $(\mathbb{Z}, \star, \leq_\star)$ be the NeutroOrderedSemigroup presented in Example 2.11. Then $F = \{-2, -1, 0, 1, 2, 3, 4, \dots\}$ is a NeutroOrderedFilter of \mathbb{Z} .

3. Productional NeutroOrderedSemigroups

Let (A_α, \leq_α) be a partial ordered set for all $\alpha \in \Gamma$. We define “ \leq ” on $\prod_{\alpha \in \Gamma} A_\alpha$ as follows: For all $(x_\alpha), (y_\alpha) \in \prod_{\alpha \in \Gamma} A_\alpha$,

$$(x_\alpha) \leq (y_\alpha) \iff x_\alpha \leq_\alpha y_\alpha \text{ for all } \alpha \in \Gamma.$$

One can easily see that $(\prod_{\alpha \in \Gamma} A_\alpha, \leq)$ is a partial ordered set.

Let A_α be any non-empty set for all $\alpha \in \Gamma$ and “ \cdot_α ” be an operation on A_α . We define “ \cdot ” on $\prod_{\alpha \in \Gamma} A_\alpha$ as follows: For all $(x_\alpha), (y_\alpha) \in \prod_{\alpha \in \Gamma} A_\alpha$, $(x_\alpha) \cdot (y_\alpha) = (x_\alpha \cdot_\alpha y_\alpha)$.

Throughout the paper, we write NOS instead of NeutroOrderedSemigroup.

Theorem 3.1. *Let $(G_1, \leq_1), (G_2, \leq_2)$ be partially ordered sets with operations \cdot_1, \cdot_2 respectively. Then $(G_1 \times G_2, \cdot, \leq)$ is an NOS if one of the following statements is true.*

- (1) G_1 and G_2 are NeutroSemigroups with at least one of them is an NOS.
- (2) One of G_1, G_2 is an NOS and the other is a semigroup.

Proof. Without loss of generality, let G_1 be an NOS. We prove 1. and 2. is done similarly. We have three cases for “ \cdot_1 ” and “ \cdot_2 ”: Case “ \cdot_1 ” is a NeutroOperation, Case “ \cdot_2 ” is a NeutroOperation, and Case “ \cdot_1 ” and “ \cdot_2 ” are NeutroAssociative.

Case “ \cdot_1 ” is a NeutroOperation. There exist $x_1, y_1, a_1, b_1 \in G_1$ such that $x_1 \cdot_1 y_1 \in G_1$ and $a_1 \cdot_1 b_1 \notin G_1$ or $x_1 \cdot_1 y_1$ is indeterminate in G_1 . Since G_2 is a NeutroSemigroup, it follows that there exist $x_2, y_2 \in G_2 \neq \emptyset$ such that $x_2 \cdot_2 y_2 \in G_2$ or $x_2 \cdot_2 y_2$ is indeterminate in G_2 (If no such elements exist then G_2 will be an AntiSemigroup.). Then $(x_1, x_2) \cdot (y_1, y_2) \in G_1 \times G_2$ and $(a_1, x_2) \cdot (b_1, y_2) \notin G_1 \times G_2$ or $(x_1, x_2) \cdot (y_1, y_2)$ is indeterminate in $G_1 \times G_2$. Thus “ \cdot ” is a NeutroOperation.

Case “ \cdot_2 ” is a NeutroOperation. This case can be done in a similar way to Case “ \cdot_1 ” is a

NeutroOperation.

Case “ \cdot_1 ” and “ \cdot_2 ” are NeutroAssociative. There exist $x_1, y_1, z_1, a_1, b_1, c_1 \in G_1$ and $x_2, y_2, z_2, a_2, b_2, c_2 \in G_2$ such that

$$x_1 \cdot_1 (y_1 \cdot_1 z_1) = (x_1 \cdot_1 y_1) \cdot_1 z_1, a_1 \cdot_1 (b_1 \cdot_1 c_1) \neq (a_1 \cdot_1 b_1) \cdot_1 c_1,$$

$$x_2 \cdot_2 (y_2 \cdot_2 z_2) = (x_2 \cdot_2 y_2) \cdot_2 z_2, \text{ and } a_2 \cdot_2 (b_2 \cdot_2 c_2) \neq (a_2 \cdot_2 b_2) \cdot_2 c_2.$$

The latter implies that

$$(x_1, x_2) \cdot ((y_1, y_2) \cdot (z_1, z_2)) = ((x_1, x_2) \cdot (y_1, y_2)) \cdot (z_1, z_2)$$

and

$$(a_1, a_2) \cdot ((b_1, b_2) \cdot (c_1, c_2)) = ((a_1, a_2) \cdot (b_1, b_2)) \cdot (c_1, c_2).$$

Thus, “ \cdot ” is NeutroAssociative.

Having “ \leq_1 ” a NeutroOrder on G_1 implies that:

- (1) There exist $x \leq_1 y \in G_1$ with $x \neq y$ such that $z \cdot_1 x \leq_1 z \cdot_1 y$ and $x \cdot_1 z \leq_1 y \cdot_1 z$ for all $z \in G_1$.
- (2) There exist $x \leq_1 y \in G_1$ and $z \in G_1$ such that $z \cdot_1 x \not\leq_1 z \cdot_1 y$ or $x \cdot_1 z \not\leq_1 y \cdot_1 z$.
- (3) There exist $x \leq_1 y \in G_1$ and $z \in G_1$ such that $z \cdot_1 x$ or $z \cdot_1 y$ or $x \cdot_1 z$ or $y \cdot_1 z$ are indeterminate, or the relation between $z \cdot_1 x$ and $z \cdot_1 y$, or the relation between $x \cdot_1 z$ and $y \cdot_1 z$ are indeterminate.

Where (T, I, F) is different from $(1, 0, 0)$ and from $(0, 0, 1)$.

Having $b \leq_2 b$ for all $b \in G_2$ implies that:

By (1), we get that there exist $(x, b) \leq (y, b) \in G_1 \times G_2$ with $(x, b) \neq (y, b)$. For all $(z, a) \in G_1 \times G_2$, we have either $a \cdot_2 b \in G_2$ or $a \cdot_2 b \notin G_2$ or $a \cdot_2 b$ is indeterminate in G_2 . Similarly for $b \cdot_2 a$. The latter implies that $(z, a) \cdot (x, b) \leq (z, a) \cdot (y, b)$ and $(x, b) \cdot (z, a) \leq (y, b) \cdot (z, a)$ or $(z, a) \cdot (x, b) \leq (z, a) \cdot (y, b)$ is indeterminate in $G_1 \times G_2$ or $(x, b) \cdot (z, a) \leq (y, b) \cdot (z, a)$ is indeterminate in $G_1 \times G_2$.

By (2), we get that there exist $(x, b) \leq (y, b) \in G_1 \times G_2$ and $(z, a) \in G_1 \times G_2$ such that $(z, a) \cdot (x, b) \not\leq (z, a) \cdot (y, b)$ or $(x, b) \cdot (z, a) \not\leq (y, b) \cdot (z, a)$ or $(z, a) \cdot (x, b) \leq (z, a) \cdot (y, b)$ is indeterminate in $G_1 \times G_2$ or $(x, b) \cdot (z, a) \leq (y, b) \cdot (z, a)$ is indeterminate in $G_1 \times G_2$.

By (3), we get that there exist $(x, b) \leq (y, b) \in G_1 \times G_2$ and $(z, a) \in G_1 \times G_2$ such that $(z, a) \cdot (x, b) \leq (z, a) \cdot (y, b)$ is indeterminate in $G_1 \times G_2$ or $(x, b) \cdot (z, a) \leq (y, b) \cdot (z, a)$ is indeterminate in $G_1 \times G_2$ or $(z, a) \cdot (x, b)$ is indeterminate in $G_1 \times G_2$ or $(x, b) \cdot (z, a)$ is indeterminate in $G_1 \times G_2$. Therefore, $(G_1 \times G_2, \cdot, \leq)$ is an NOS. \square

Theorem 3.1 implies that $G_1 \times G_2$ is an NOS if either G_1, G_2 are both NOS, G_1 is an NOS and G_2 is a NeutroSemigroup, G_1 is an NOS and G_2 is a semigroup (or odered semigroup),

G_1 is a NeutroSemigroup and G_2 is an NOS, or G_1 is a semigroup (or ordered semigroup) and G_2 is an NOS.

We present a generalization of Theorem 3.1.

Theorem 3.2. *Let (G_α, \leq_α) be a partially ordered set with operation “ \cdot_α ” for all $\alpha \in \Gamma$. Then $(\prod_{\alpha \in \Gamma} G_\alpha, \cdot, \leq)$ is an NOS if there exist $\alpha_0 \in \Gamma$ such that $(G_{\alpha_0}, \cdot_{\alpha_0}, \leq_{\alpha_0})$ is an NOS and (G_α, \cdot_α) is a semigroup or NeutroSemigroup for all $\alpha \in \Gamma - \{\alpha_0\}$.*

Notation 1. *Let (G_α, \leq_α) be a partially ordered set with operation “ \cdot_α ” for all $\alpha \in \Gamma$. If $(\prod_{\alpha \in \Gamma} G_\alpha, \cdot, \leq)$ is an NOS then we call it the **productional NOS**.*

Proposition 3.3. *Let (G_1, \cdot_1, \leq_1) and (G_2, \cdot_2, \leq_2) be NeutroTotalOrderedSemigroups with $|G_1|, |G_2| \geq 2$. Then $(G_1 \times G_2, \cdot, \leq)$ is not a NeutroTotalOrderedSemigroup.*

Proof. Since (G_1, \cdot_1, \leq_1) and (G_2, \cdot_2, \leq_2) are NeutroTotalOrderedSemigroups with $|G_1| \geq 2$ and $|G_2| \geq 2$, it follows that there exist $a \leq_1 b \in G_1, c \leq_2 d \in G_2$ with $a \neq b$ and $c \neq d$. One can easily see that $(a, d) \not\leq (b, c) \in G_1 \times G_2$ and $(b, c) \not\leq (a, d) \in G_1 \times G_2$. Therefore, $(G_1 \times G_2, \cdot, \leq)$ is not a NeutroTotalOrderedSemigroup. \square

Corollary 3.4. *Let $(G_\alpha, \cdot_\alpha, \leq_\alpha)$ be NeutroTotalOrderedSemigroups for all $\alpha \in \Gamma$ with $|G_{\alpha_0}|, |G_{\alpha_1}| \geq 2$ for $\alpha_0 \neq \alpha_1 \in \Gamma$. Then $(\prod_{\alpha \in \Gamma} G_\alpha, \cdot, \leq)$ is not a NeutroTotalOrderedSemigroup.*

Proof. The proof follows from Proposition 3.3. \square

Example 3.5. Let $S_1 = \{s, a, m\}$, (S_1, \cdot_1, \leq_1) be the NOS presented in Example 2.8, and “ \leq'_1 ” be the trivial order on S_1 . Theorem 3.1 asserts that Cartesian product $(S_1 \times S_1, \cdot, \leq)$ resulting from (S_1, \cdot_1, \leq_1) and (S_1, \cdot_1, \leq'_1) is an NOS of order 9.

Example 3.6. Let $S_1 = \{s, a, m\}$, (S_1, \cdot_1, \leq_1) be the NOS presented in Example 2.8, and $(\mathbb{R}, \cdot_s, \leq_u)$ be the semigroup of real numbers under standard multiplication and usual order. Theorem 3.1 asserts that Cartesian product $(\mathbb{R} \times S_1, \cdot, \leq)$ is an NOS of infinite order.

Example 3.7. Let $S_1 = \{s, a, m\}$ and (S_1, \cdot_1, \leq_1) be the NOS presented in Example 2.8. Theorem 3.2 asserts that $(S_1 \times S_1 \times S_1, \cdot, \leq)$ is an NOS of order 27. Moreover, by means of Proposition 3.3, $(S_1 \times S_1 \times S_1, \cdot, \leq)$ is not a NeutroTotalOrderedSemigroup.

Example 3.8. Let $(\mathbb{Z}, \star, \leq_\star)$ be the NOS presented in Example 2.11 and $(\mathbb{Z}_n, \odot, \leq_t)$ be the semigroup under standard multiplication of integers modulo n and “ \leq_t ” is defined as follows. For all $\bar{x}, \bar{y} \in \mathbb{Z}_n$ with $0 \leq x, y \leq n - 1$,

$$\bar{x} \leq_t \bar{y} \iff x \leq y \in \mathbb{Z}.$$

Then $(\mathbb{Z}_n \times \mathbb{Z}, \cdot, \leq)$ is an NOS.

Proposition 3.9. *Let (G_α, \leq_α) be a partially ordered set with operation “ \cdot_α ” for all $\alpha \in \Gamma$ and $(G_{\alpha_0}, \cdot_{\alpha_0}, \leq_{\alpha_0})$ be an NOS for some $\alpha_0 \in \Gamma$. Then $\phi : (\prod_{\alpha \in \Gamma} G_\alpha, \cdot, \leq) \rightarrow G_{\alpha_0}$ with $\phi((x_\alpha)) = x_{\alpha_0}$ is a NeutroOrderedHomomorphism.*

Proof. The proof is straightforward. \square

Remark 3.10. If $|\Gamma| \geq 2$ and there exist $\alpha \neq \alpha_0 \in \Gamma$ with $|G_\alpha| \geq 2$ then the NeutroOrderedHomomorphism ϕ in Proposition 3.9 is not a NeutroOrderedIsomorphism.

Remark 3.11. If $|\Gamma| \geq 2$ and there exist $\alpha \neq \alpha_0 \in \Gamma$ with $|G_\alpha| \geq 2$ then $G_{\alpha_0} \not\cong_s \prod_{\alpha \in \Gamma} G_\alpha$. This is clear as there exist no bijective function from G_{α_0} to $\prod_{\alpha \in \Gamma} G_\alpha$.

Proposition 3.12. *There are infinite non-isomorphic NOS.*

Proof. Let (G, \cdot_G, \leq_G) be an NOS with $|G| \geq 2$, $\Gamma \subseteq \mathbb{R}$, and $|\Gamma| \geq 2$. Theorem 3.2 asserts that $(\prod_{\alpha \in \Gamma} G, \cdot, \leq)$ is an NOS for every $\Gamma \subseteq \mathbb{R}$. For all $\Gamma_1, \Gamma_2 \subseteq \mathbb{R}$ with $|\Gamma_1| \neq |\Gamma_2|$, Remark 3.11 asserts that $\prod_{\alpha \in \Gamma_1} G \not\cong_s \prod_{\alpha \in \Gamma_2} G$. Therefore, there are infinite non-isomorphic NOS. \square

Example 3.13. Let $(\mathbb{Z}, \star, \leq_\star)$ be the NOS presented in Example 2.11. Then for every $n \in \mathbb{N}$, we have $(\prod_{i=1}^n \mathbb{Z}, \cdot, \leq)$ is an NOS. Moreover, we have infinite such non-isomorphic NOS.

Theorem 3.14. *Let $(G_\alpha, \cdot_\alpha, \leq_\alpha)$ and $(G'_\alpha, \cdot'_\alpha, \leq'_\alpha)$ be NOS for all $\alpha \in \Gamma$. Then the following statements hold.*

- (1) *If there is a NeutroOrderedHomomorphism from G_α to G'_α for all $\alpha \in \Gamma$ then there is a NeutroOrderedHomomorphism from $(\prod_{\alpha \in \Gamma} G_\alpha, \cdot, \leq)$ to $(\prod_{\alpha \in \Gamma} G'_\alpha, \cdot', \leq')$.*
- (2) *If there is a NeutroOrderedStrongHomomorphism from G_α to G'_α for all $\alpha \in \Gamma$ then there is a NeutroOrderedStrongHomomorphism from $(\prod_{\alpha \in \Gamma} G_\alpha, \cdot, \leq)$ to $(\prod_{\alpha \in \Gamma} G'_\alpha, \cdot', \leq')$.*
- (3) *If $G_\alpha \cong G'_\alpha$ for all $\alpha \in \Gamma$ then $(\prod_{\alpha \in \Gamma} G_\alpha, \cdot, \leq) \cong (\prod_{\alpha \in \Gamma} G'_\alpha, \cdot', \leq')$.*
- (4) *If $G_\alpha \cong_s G'_\alpha$ for all $\alpha \in \Gamma$ then $(\prod_{\alpha \in \Gamma} G_\alpha, \cdot, \leq) \cong_s (\prod_{\alpha \in \Gamma} G'_\alpha, \cdot', \leq')$.*

Proof. We prove 1. and the proof of 2., 3., and 4. are done similarly. Let $\phi_\alpha : G_\alpha \rightarrow G'_\alpha$ be a NeutroOrderedHomomorphism and define $\phi : \prod_{\alpha \in \Gamma} G_\alpha \rightarrow \prod_{\alpha \in \Gamma} G'_\alpha$ as follows: For all $(x_\alpha) \in \prod_{\alpha \in \Gamma} G_\alpha$,

$$\phi((x_\alpha)) = (\phi_\alpha(x_\alpha)).$$

one can easily see that ϕ is a NeutroOrderedHomomorphism. \square

4. Subsets of productional NeutroOrderedSemigroups

In this section, we find some sufficient conditions for subsets of the productional NOS to be NeutroOrderedSubSemigroups, NeutroOrderedIdeals, and NeutroOrderedFilters. Moreover, we present some related examples.

Proposition 4.1. *Let (A_α, \leq_α) be a partial ordered set for all $\alpha \in \Gamma$ and $(x_\alpha) \in \prod_{\alpha \in \Gamma} A_\alpha$. Then $((x_\alpha)) = \prod_{\alpha \in \Gamma} (x_\alpha]$.*

Proof. Let $(y_\alpha) \in ((x_\alpha))$. Then $(y_\alpha) \leq (x_\alpha)$. The latter implies that $y_\alpha \leq_\alpha x_\alpha$ for all $\alpha \in \Gamma$ and hence, $y_\alpha \in (x_\alpha]$ for all $\alpha \in \Gamma$. We get now that $(y_\alpha) \in \prod_{\alpha \in \Gamma} (x_\alpha]$. Thus, $((x_\alpha)) \subseteq \prod_{\alpha \in \Gamma} (x_\alpha]$. Similarly, we can prove that $\prod_{\alpha \in \Gamma} (x_\alpha] \subseteq ((x_\alpha))$. \square

Proposition 4.2. *Let (A_α, \leq_α) be a partial ordered set for all $\alpha \in \Gamma$ and $(x_\alpha) \in \prod_{\alpha \in \Gamma} A_\alpha$. Then $[(x_\alpha)) = \prod_{\alpha \in \Gamma} [x_\alpha)$.*

Proof. The proof is similar to that of Proposition 4.1. \square

Theorem 4.3. *Let $(G_\alpha, \cdot_\alpha, \leq_\alpha)$ be an NOS for all $\alpha \in \Gamma$. If S_α is a NeutroOrderedSubSemigroup of G_α for all $\alpha \in \Gamma$ then $\prod_{\alpha \in \Gamma} S_\alpha$ is a NeutroOrderedSubSemigroup of $\prod_{\alpha \in \Gamma} G_\alpha$.*

Proof. For all $\alpha \in \Gamma$, we have S_α an NOS (as it is NeutroOrderedSubSemigroup of G_α). Theorem 3.2 asserts that $\prod_{\alpha \in \Gamma} S_\alpha$ is an NOS. Since S_α is a NeutroOrderedSubSemigroup of G_α for every $\alpha \in \Gamma$, it follows that for every $\alpha \in \Gamma$ there exist $x_\alpha \in S_\alpha$ with $(x_\alpha] \subseteq S_\alpha$. Using Proposition 4.1, we get that there exist $(x_\alpha) \in \prod_{\alpha \in \Gamma} S_\alpha$ such that $((x_\alpha)) = \prod_{\alpha \in \Gamma} (x_\alpha] \subseteq \prod_{\alpha \in \Gamma} S_\alpha$. Therefore, $\prod_{\alpha \in \Gamma} S_\alpha$ is a NeutroOrderedSubSemigroup of $\prod_{\alpha \in \Gamma} G_\alpha$. \square

Corollary 4.4. *Let $(G_\alpha, \cdot_\alpha, \leq_\alpha)$ be an NOS for all $\alpha \in \Gamma$. If there exists $\alpha_0 \in \Gamma$ such that S_{α_0} is a NeutroOrderedSubSemigroup of G_{α_0} then $\prod_{\alpha \in \Gamma, \alpha < \alpha_0} G_\alpha \times S_{\alpha_0} \times \prod_{\alpha \in \Gamma, \alpha > \alpha_0} G_\alpha$ is a NeutroOrderedSubSemigroup of $\prod_{\alpha \in \Gamma} G_\alpha$.*

Proof. The proof follows from Theorem 4.3 and having G_α a NeutroOrderedSubSemigroup of itself. \square

Theorem 4.5. *Let $(G_\alpha, \cdot_\alpha, \leq_\alpha)$ be an NOS for all $\alpha \in \Gamma$. If I_α is a NeutroOrderedLeftIdeal of G_α for all $\alpha \in \Gamma$ then $\prod_{\alpha \in \Gamma} I_\alpha$ is a NeutroOrderedLeftIdeal of $\prod_{\alpha \in \Gamma} G_\alpha$.*

Proof. Having every NeutroOrderedLeftIdeal a NeutroOrderedSubSemigroup and that I_α is a NeutroOrderedLeftIdeal of G_α for all $\alpha \in \Gamma$ implies, by means of Theorem 4.3, that $\prod_{\alpha \in \Gamma} I_\alpha$ is a NeutroOrderedSubSemigroup of $\prod_{\alpha \in \Gamma} G_\alpha$. Since I_α is a NeutroOrderedLeftIdeal of G_α for all $\alpha \in \Gamma$, it follows that for every $\alpha \in \Gamma$ there exist $x_\alpha \in I_\alpha$ such that $r_\alpha \cdot_\alpha x_\alpha \in I_\alpha$ for all $r_\alpha \in G_\alpha$. The latter implies that there exist $(x_\alpha) \in \prod_{\alpha \in \Gamma} I_\alpha$ such that $(r_\alpha) \cdot (x_\alpha) = (r_\alpha \cdot_\alpha x_\alpha) \in \prod_{\alpha \in \Gamma} I_\alpha$ for all $(r_\alpha) \in \prod_{\alpha \in \Gamma} G_\alpha$. Therefore, $\prod_{\alpha \in \Gamma} I_\alpha$ is a NeutroOrderedLeftIdeal of $\prod_{\alpha \in \Gamma} G_\alpha$. \square

Corollary 4.6. *Let $(G_\alpha, \cdot_\alpha, \leq_\alpha)$ be an NOS for all $\alpha \in \Gamma$. If there exists $\alpha_0 \in \Gamma$ such that I_{α_0} is a NeutroOrderedLeftIdeal of G_{α_0} and for $\alpha \neq \alpha_0$ there exist $x_\alpha \in G_\alpha$ such that $r_\alpha \cdot_\alpha x_\alpha \in G_\alpha$ for all $r_\alpha \in G_\alpha$ then $\prod_{\alpha \in \Gamma, \alpha < \alpha_0} G_\alpha \times I_{\alpha_0} \times \prod_{\alpha \in \Gamma, \alpha > \alpha_0} G_\alpha$ is a NeutroOrderedLeftIdeal of $\prod_{\alpha \in \Gamma} G_\alpha$.*

Proof. The proof follows from Theorem 4.5 and having G_α a NeutroOrderedLeftIdeal of itself. \square

Theorem 4.7. *Let $(G_\alpha, \cdot_\alpha, \leq_\alpha)$ be an NOS for all $\alpha \in \Gamma$. If I_α is a NeutroOrderedRightIdeal of G_α for all $\alpha \in \Gamma$ then $\prod_{\alpha \in \Gamma} I_\alpha$ is a NeutroOrderedRightIdeal of $\prod_{\alpha \in \Gamma} G_\alpha$.*

Proof. The proof is similar to that of Theorem 4.5. \square

Corollary 4.8. *Let $(G_\alpha, \cdot_\alpha, \leq_\alpha)$ be an NOS for all $\alpha \in \Gamma$. If there exists $\alpha_0 \in \Gamma$ such that I_{α_0} is a NeutroOrderedRightIdeal of G_{α_0} and for $\alpha \neq \alpha_0$ there exist $x_\alpha \in G_\alpha$ such that $x_\alpha \cdot_\alpha r_\alpha \in G_\alpha$ for all $r_\alpha \in G_\alpha$ then $\prod_{\alpha \in \Gamma, \alpha < \alpha_0} G_\alpha \times I_{\alpha_0} \times \prod_{\alpha \in \Gamma, \alpha > \alpha_0} G_\alpha$ is a NeutroOrderedRightIdeal of $\prod_{\alpha \in \Gamma} G_\alpha$.*

Proof. The proof follows from Theorem 4.7 and having G_α a NeutroOrderedRightIdeal of itself. \square

Theorem 4.9. *Let $(G_\alpha, \cdot_\alpha, \leq_\alpha)$ be an NOS for all $\alpha \in \Gamma$. If I_α is a NeutroOrderedIdeal of G_α for all $\alpha \in \Gamma$ then $\prod_{\alpha \in \Gamma} I_\alpha$ is a NeutroOrderedIdeal of $\prod_{\alpha \in \Gamma} G_\alpha$.*

Proof. The proof is similar to that of Theorem 4.5. \square

Corollary 4.10. *Let $(G_\alpha, \cdot_\alpha, \leq_\alpha)$ be an NOS for all $\alpha \in \Gamma$. If there exists $\alpha_0 \in \Gamma$ such that I_{α_0} is a NeutroOrderedIdeal of G_{α_0} and for $\alpha \neq \alpha_0$ there exist $x_\alpha \in G_\alpha$ such that $r_\alpha \cdot_\alpha x_\alpha, x_\alpha \cdot_\alpha r_\alpha \in G_\alpha$ for all $r_\alpha \in G_\alpha$ then $\prod_{\alpha \in \Gamma, \alpha < \alpha_0} G_\alpha \times I_{\alpha_0} \times \prod_{\alpha \in \Gamma, \alpha > \alpha_0} G_\alpha$ is a NeutroOrderedIdeal of $\prod_{\alpha \in \Gamma} G_\alpha$.*

Proof. The proof follows from Theorem 4.9 and having G_α a NeutroOrderedIdeal of itself. \square

Example 4.11. Let (S_3, \cdot, \leq_3) be the NeutroOrderedSemigroup presented in Example 2.10. Example 2.14 asserts that $I = \{0, 1, 2\}$ is both: a NeutroOrderedLeftIdeal and a NeutroOrderedRightIdeal of S_3 . Theorem 4.5 and Theorem 4.7 imply that $I \times I = \{(0, 0), (0, 1), (0, 2), (1, 0), (1, 1), (1, 2), (2, 0), (2, 1), (2, 2)\}$ is both: a NeutroOrderedLeftIdeal and a NeutroOrderedRightIdeal of $S_3 \times S_3$. Moreover, $I \times S_3$ and $S_3 \times I$ are both: NeutroOrderedLeftIdeals and NeutroOrderedRightIdeals of $S_3 \times S_3$.

Example 4.12. Let $(\mathbb{Z}, \star, \leq_\star)$ be the NeutroOrderedSemigroup presented in Example 2.11. Example 2.15 asserts that $I = \{-2, -1, 0, 1, -2, -3, -4, \dots\}$ is a NeutroOrderedIdeal of \mathbb{Z} . Theorem 4.9 asserts that $I \times I \times I$ is NeutroOrderedIdeal of $\mathbb{Z} \times \mathbb{Z} \times \mathbb{Z}$.

Theorem 4.13. *Let $(G_\alpha, \cdot_\alpha, \leq_\alpha)$ be an NOS for all $\alpha \in \Gamma$. If F_α is a NeutroOrderedFilter of G_α for all $\alpha \in \Gamma$ then $\prod_{\alpha \in \Gamma} F_\alpha$ is a NeutroOrderedFilter of $\prod_{\alpha \in \Gamma} G_\alpha$.*

Proof. For all $\alpha \in \Gamma$, we have F_α an NOS (as it is NeutroOrderedFilter of G_α). Theorem 3.2 asserts that $\prod_{\alpha \in \Gamma} S_\alpha$ is an NOS. Having F_α is a NeutroOrderedFilter of G_α for all $\alpha \in \Gamma$ implies that for every $\alpha \in \Gamma$ there exist $x_\alpha \in F_\alpha$ such that for all $y_\alpha, z_\alpha \in F_\alpha$, $x_\alpha \cdot_\alpha y_\alpha \in F_\alpha$ and $z_\alpha \cdot_\alpha x_\alpha \in F_\alpha$ imply that $y_\alpha, z_\alpha \in F_\alpha$. We get now that there exist $(x_\alpha) \in \prod_{\alpha \in \Gamma} F_\alpha$ such that for all $(y_\alpha), (z_\alpha) \in \prod_{\alpha \in \Gamma} F_\alpha$, $(x_\alpha) \cdot (y_\alpha) = (x_\alpha \cdot_\alpha y_\alpha) \in \prod_{\alpha \in \Gamma} F_\alpha$ and $(z_\alpha) \cdot (x_\alpha) = (z_\alpha \cdot_\alpha x_\alpha) \in \prod_{\alpha \in \Gamma} F_\alpha$ imply that $(y_\alpha), (z_\alpha) \in \prod_{\alpha \in \Gamma} F_\alpha$. Since F_α is a NeutroOrderedFilter of G_α for every $\alpha \in \Gamma$, it follows that for every $\alpha \in \Gamma$ there exist $x_\alpha \in F_\alpha$ with $[x_\alpha] \subseteq F_\alpha$. Using Proposition 4.2, we get that there exist $(x_\alpha) \in \prod_{\alpha \in \Gamma} F_\alpha$ such that $[(x_\alpha)] = \prod_{\alpha \in \Gamma} [x_\alpha] \subseteq \prod_{\alpha \in \Gamma} F_\alpha$. Therefore, $\prod_{\alpha \in \Gamma} F_\alpha$ is a NeutroOrderedFilter of $\prod_{\alpha \in \Gamma} G_\alpha$. \square

Corollary 4.14. *Let $(G_\alpha, \cdot_\alpha, \leq_\alpha)$ be an NOS for all $\alpha \in \Gamma$. If there exists $\alpha_0 \in \Gamma$ such that F_{α_0} is a NeutroOrderedFilter of G_{α_0} then $\prod_{\alpha \in \Gamma, \alpha < \alpha_0} G_\alpha \times F_{\alpha_0} \times \prod_{\alpha \in \Gamma, \alpha > \alpha_0} G_\alpha$ is a NeutroOrderedFilter of $\prod_{\alpha \in \Gamma} G_\alpha$.*

Proof. The proof follows from Theorem 4.13 and having G_α a NeutroOrderedFilter of itself. \square

Example 4.15. Let $(\mathbb{Z}, \star, \leq_\star)$ be the NeutroOrderedSemigroup presented in Example 2.11. Example 2.16 asserts that $F = \{-2, -1, 0, 1, 2, 3, 4, \dots\}$ is a NeutroOrderedFilter of \mathbb{Z} . Theorem 4.13 implies that $F \times F \times F \times F$ is a NeutroOrderedFilter of $\mathbb{Z} \times \mathbb{Z} \times \mathbb{Z} \times \mathbb{Z}$. Moreover, $\mathbb{Z} \times \mathbb{Z} \times F \times \mathbb{Z}$ is a NeutroOrderedFilter of $\mathbb{Z} \times \mathbb{Z} \times \mathbb{Z} \times \mathbb{Z}$.

5. Conclusion

The class of NeutroAlgebras is very large. This paper considered NeutroOrderedSemigroups (introduced by the authors in [9]) as a subclass of NeutroAlgebras. Results related to productional NOS and its subsets were investigated and some examples were elaborated.

For future work, it will be interesting to investigate the following.

- (1) Find necessary conditions for the productional NeutroSemigroup to be NeutroOrderedSemigroup.
- (2) Check the possibility of introducing the quotient NeutroOrderedSemigroup and investigate its properties.
- (3) Study other types of productional NeutroOrderedStructures.

References

- [1] F. Smarandache, Introduction to NeutroAlgebraic Structures and AntiAlgebraic Structures, in Advances of Standard and Nonstandard Neutrosophic Theories, Pons Publishing House Brussels, Belgium, Ch. 6, pp. 240-265, 2019; <http://fs.unm.edu/AdvancesOfStandardAndNonstandard.pdf>
- [2] F. Smarandache, Introduction to NeutroAlgebraic Structures and AntiAlgebraic Structures (revisited), Neutrosophic Sets and Systems, Vol. 31, pp. 1-16, 2020. DOI: 10.5281/zenodo.3638232, <http://fs.unm.edu/NSS/NeutroAlgebraic-AntiAlgebraic-Structures.pdf>
- [3] F. Smarandache, NeutroAlgebra is a Generalization of Partial Algebra, International Journal of Neutrosophic Science (IJNS), Vol. 2, No. 1, pp. 08-17, 2020, <http://fs.unm.edu/NeutroAlgebra.pdf>.
- [4] A.A.A. Agboola, Introduction to NeutroGroups, International Journal of Neutrosophic Science(IJNS), Vol. 6, 2020, pp. 41-47.
- [5] A.A.A. Agboola, Introduction to NeutroRings, International Journal of Neutrosophic Science (IJNS), Vol. 7, 2020, pp. 62-73.
- [6] M. Hamidi, F. Smarandache, Neutro-BCK-Algebra, International Journal of Neutrosophic Science (IJNS), Vol. 8, 2020, pp. 110-117.
- [7] F. Smarandache, A. Rezaei, H.S. Kim, A New Trend to Extensions of CI- algebras, International Journal of Neutrosophic Science(IJNS) Vol. 5, No. 1 , pp. 8-15, 2020; DOI: 10.5281/zenodo.3788124
- [8] A. Rezaei, F. Smarandache, On Neutro-BE-algebras and Anti-BE-algebras, International Journal of Neutrosophic Science(IJNS), Vol. 4, 2020, pp. 8-15.
- [9] M. Al-Tahan, F. Smarandache, B. Davvaz, NeutroOrderedAlgebra: Applications to Semigroups, Neutrosophic Sets and Systems, Vol. 39, pp. 133-147, 2021.
- [10] L. Fuchs, Partially Ordered Algebraic Systems, Int. Ser. of Monographs on Pure and Appl. Math. 28, Pergamon Press, Oxford, 1963.
- [11] A.H. Clifford, G.B. Preston, The Algebraic Theory of Semigroups, Vol 1, Amer. Math. Soc., Math. Surveys 7, Providence, Rhode Island, 1977.

NEUTROSOPHIC GRAPHS

Graph Structures in Bipolar Neutrosophic Environment

Muhammad Akram, Muzzamal Sitara Florentin Smarandache

Muhammad Akram, Muzzamal Sitara, Florentin Smarandache (2017). Graph Structures in Bipolar Neutrosophic Environment. *Mathematics*, 5(4), 60; DOI: 10.3390/math5040060

Abstract: A bipolar single-valued neutrosophic (BSVN) graph structure is a generalization of a bipolar fuzzy graph. In this research paper, we present certain concepts of BSVN graph structures. We describe some operations on BSVN graph structures and elaborate on these with examples. Moreover, we investigate some related properties of these operations.

Keywords: graph structure; bipolar single-valued neutrosophic (BSVN) graph structure

1. Introduction

Fuzzy graphs are mathematical models for dealing with combinatorial problems in different domains, including operations research, optimization, computer science and engineering. In 1965, Zadeh [1] proposed fuzzy set theory to deal with uncertainty in abundant meticulous real-life phenomena. Fuzzy set theory is affluently applicable in real-time systems consisting of information with different levels of precision. Subsequently, Atanassov [2] introduced the idea of intuitionistic fuzzy sets in 1986. However, for many real-life phenomena, it is necessary to deal with the implicit counter property of a particular event. Zhang [3] initiated the concept of bipolar fuzzy sets in 1994. Evidently bipolar fuzzy sets and intuitionistic fuzzy sets seem to be similar, but they are completely different sets. Bipolar fuzzy sets have large number of applications in image processing and spatial reasoning. Bipolar fuzzy sets are more practical, advantageous and applicable in real-life phenomena. However, both bipolar fuzzy sets and intuitionistic fuzzy sets cope with incomplete information, because they do not consider indeterminate or inconsistent information that clearly appears in many systems of different fields, including belief systems and decision-support systems. Smarandache [4] introduced neutrosophic sets as a generalization of fuzzy sets and intuitionistic fuzzy sets. A neutrosophic set has three constituents: truth membership, indeterminacy membership and falsity membership, for which each membership value is a real standard or non-standard subset of the unit interval $[0^-, 1^+]$. In real-life problems, neutrosophic sets can be applied more appropriately by using the single-valued neutrosophic sets defined by Smarandache [4] and Wang et al. [5]. Deli et al. [6] considered bipolar neutrosophic sets as a generalization of bipolar fuzzy sets. They also studied some operations and applications in decision-making problems.

On the basis of Zadeh's fuzzy relations [7], Kauffman defined fuzzy graphs [8]. In 1975, Rosenfeld [9] discussed a fuzzy analogue of different graph-theoretic ideas. Later on, Bhattacharya [10] gave some remarks on fuzzy graphs in 1987. Akram [11] first introduced the notion of bipolar fuzzy graphs. In 2011, Dinesh and Ramakrishnan [12] studied fuzzy graph structures and discussed their properties. In 2016, Akram and Akmal [13] proposed the concept of bipolar fuzzy graph structures. Certain concepts on graphs have been discussed in [14–19]. Ye [20–22] considered several applications

of single-valued neutrosophic sets. In this research paper, we present certain concepts of bipolar single-valued neutrosophic graph structures (BSVNGSs). We introduce some operations on BSVNGSs and elaborate on these with examples. Moreover, we investigate some relevant and remarkable properties of these operators.

We have used standard definitions and terminologies in this paper. For other notations, terminologies and applications not mentioned in the paper, the readers are referred to [23–29].

2. Bipolar Single-Valued Neutrosophic Graph Structures

Definition 1. [4] A neutrosophic set N on a non-empty set V is an object of the form

$$N = \{(v, T_N(v), I_N(v), F_N(v)) : v \in V\}$$

where $T_N, I_N, F_N : V \rightarrow [0^-, 1^+]$ and there is no restriction on the sum of $T_N(v)$, $I_N(v)$ and $F_N(v)$ for all $v \in V$.

Definition 2. [5] A single-valued neutrosophic set N on a non-empty set V is an object of the form

$$N = \{(v, T_N(v), I_N(v), F_N(v)) : v \in V\}$$

where $T_N, I_N, F_N : V \rightarrow [0, 1]$ and the sum of $T_N(v)$, $I_N(v)$ and $F_N(v)$ is confined between 0 and 3 for all $v \in V$.

Definition 3. [23] A BSVN set on a non-empty set V is an object of the form

$$B = \{(v, T_B^P(v), I_B^P(v), F_B^P(v), T_B^N(v), I_B^N(v), F_B^N(v)) : v \in V\}$$

where $T_B^P, I_B^P, F_B^P : V \rightarrow [0, 1]$ and $T_B^N, I_B^N, F_B^N : V \rightarrow [-1, 0]$. The positive values $T_B^P(v)$, $I_B^P(v)$ and $F_B^P(v)$ denote the truth, indeterminacy and falsity membership values of an element $v \in V$, whereas negative values $T_B^N(v)$, $I_B^N(v)$ and $F_B^N(v)$ indicate the implicit counter property of truth, indeterminacy and falsity membership values of an element $v \in V$.

Definition 4. [23] A BSVN graph on a non-empty set V is a pair $G = (B, R)$, where B is a BSVN set on V and R is a BSVN relation in V such that

$$\begin{aligned} T_R^P(b, d) &\leq T_B^P(b) \wedge T_B^P(d), & I_R^P(b, d) &\leq I_B^P(b) \wedge I_B^P(d), & F_R^P(b, d) &\leq F_B^P(b) \vee F_B^P(d), \\ T_R^N(b, d) &\geq T_B^N(b) \vee T_B^N(d), & I_R^N(b, d) &\geq I_B^N(b) \vee I_B^N(d), & F_R^N(b, d) &\geq F_B^N(b) \wedge F_B^N(d) \end{aligned}$$

for all $b, d \in V$.

We now define the BSVNGS.

Definition 5. [30] A BSVNGS of a graph structure $\check{G}_s = (V, V_1, V_2, \dots, V_m)$ is denoted by $\check{G}_{bn} = (B, B_1, B_2, \dots, B_m)$, where $B = \langle b, T^P(b), I^P(b), F^P(b), T^N(b), I^N(b), F^N(b) \rangle$ is a BSVN set on the set V and $B_k = \langle (b, d), T_k^P(b, d), I_k^P(b, d), F_k^P(b, d), T_k^N(b, d), I_k^N(b, d), F_k^N(b, d) \rangle$ are the BSVN sets on V_k such that

$$\begin{aligned} T_k^P(b, d) &\leq \min\{T^P(b), T^P(d)\}, & I_k^P(b, d) &\leq \min\{I^P(b), I^P(d)\}, & F_k^P(b, d) &\leq \max\{F^P(b), F^P(d)\}, \\ T_k^N(b, d) &\geq \max\{T^N(b), T^N(d)\}, & I_k^N(b, d) &\geq \max\{I^N(b), I^N(d)\}, & F_k^N(b, d) &\geq \min\{F^N(b), F^N(d)\} \end{aligned}$$

for all $b, d \in V$. Note that $0 \leq T_k^P(b, d) + I_k^P(b, d) + F_k^P(b, d) \leq 3$, $-3 \leq T_k^N(b, d) + I_k^N(b, d) + F_k^N(b, d) \leq 0$ for all $(b, d) \in V_k$, and (b, d) represents an edge between two vertices b and d . In this paper we use bd in place of (b, d) .

Example 1. Consider a graph structure $\check{G}_s = (V, V_1, V_2, V_3)$ such that $V = \{b_1, b_2, b_3, b_4, b_5, b_6, b_7, b_8\}$, $V_1 = \{b_1b_2, b_2b_7, b_4b_8, b_6b_8, b_5b_6, b_3b_4\}$, $V_2 = \{b_1b_5, b_5b_7, b_3b_6, b_7b_8\}$, and $V_3 = \{b_1b_3, b_2b_4\}$. Let B be a BSVN set on V given in Table 1 and B_1, B_2 and B_3 be BSVN sets on V_1, V_2 and V_3 , respectively, given in Table 2.

Table 1. Bipolar single-valued neutrosophic (BSVN) set B on vertex set V .

B	b_1	b_2	b_3	b_4	b_5	b_6	b_7	b_8
T^P	0.5	0.4	0.4	0.5	0.3	0.4	0.5	0.3
I^P	0.4	0.3	0.4	0.4	0.2	0.4	0.5	0.4
F^P	0.6	0.5	0.4	0.6	0.4	0.7	0.4	0.5
T^N	-0.5	-0.4	-0.4	-0.5	-0.3	-0.4	-0.5	-0.3
I^N	-0.4	-0.3	-0.4	-0.4	-0.2	-0.4	-0.5	-0.4
F^N	-0.6	-0.5	-0.4	-0.6	-0.4	-0.7	-0.4	-0.5

Table 2. BSVN sets B_1, B_2 and B_3 .

B₁	b_1b_2	b_2b_7	b_4b_8	b_6b_8	b_5b_6	b_3b_4	B₂	b_1b_5	b_5b_7	b_3b_6	b_7b_8	B₃	b_1b_3	b_2b_4
T^P	0.4	0.4	0.3	0.3	0.3	0.4	T^P	0.3	0.3	0.4	0.3	T^P	0.4	0.4
I^P	0.3	0.3	0.4	0.4	0.2	0.4	I^P	0.2	0.2	0.4	0.4	I^P	0.4	0.3
F^P	0.6	0.5	0.6	0.7	0.7	0.6	F^P	0.6	0.4	0.7	0.5	F^P	0.6	0.6
T^N	-0.4	-0.4	-0.3	-0.3	-0.3	-0.4	T^N	-0.3	-0.3	-0.4	-0.3	T^N	-0.4	-0.4
I^N	-0.3	-0.3	-0.4	-0.4	-0.2	-0.4	I^N	-0.2	-0.2	-0.4	-0.4	I^N	-0.4	-0.3
F^N	-0.6	-0.5	-0.6	-0.7	-0.7	-0.6	F^N	-0.6	-0.4	-0.7	-0.5	F^N	-0.6	-0.6

By direct calculations, it is easy to show that $\check{G}_{bn} = (B, B_1, B_2, B_3)$ is a BSVNGS. This BSVNGS is shown in Figure 1. Generated with L^AT_EXDraw 2.0.8 on Saturday March 11 20:30:24 PKT 2017.

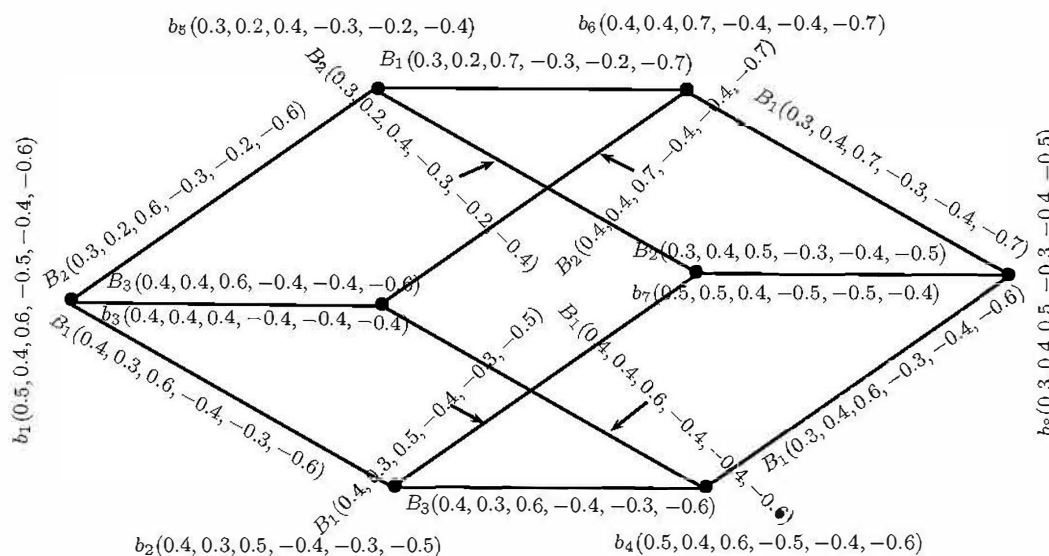

Figure 1. A BSVN graph structure.

Definition 6. A BSVNGS $\check{G}_{bn} = (B, B_1, B_2, \dots, B_m)$ is called a B_k -cycle if $(supp(B), supp(B_1), supp(B_2), \dots, supp(B_m))$ is a B_k -cycle.

Example 2. Consider a BSVNGS $\check{G}_{bn} = (B, B_1, B_2)$ as shown in Figure 2.

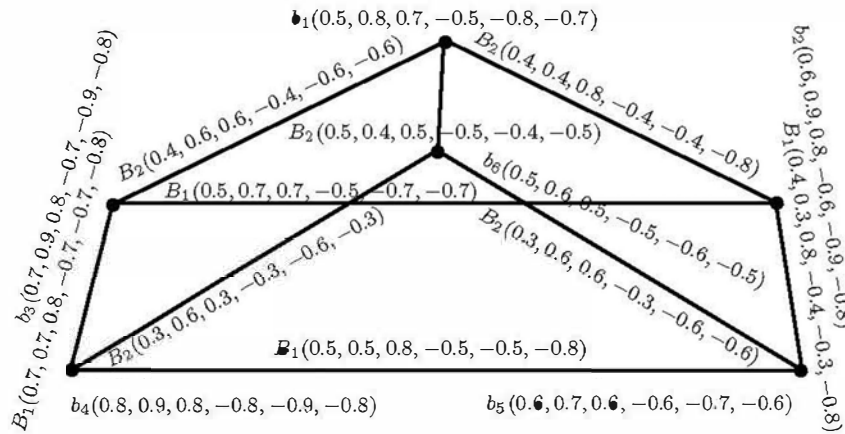

Figure 2. A BSVN B_1 -cycle.

\check{G}_{b_n} is a B_1 -cycle, as $(supp(B), supp(B_1), supp(B_2))$ is a B_1 -cycle, that is, b_2 - b_3 - b_4 - b_5 - b_2 .

Definition 7. A BSVNGS $\check{G}_{b_n} = (B, B_1, B_2, \dots, B_m)$ is a BSVN fuzzy B_k -cycle (for any k) if \check{G}_{b_n} is a B_k -cycle and no unique B_k -edge bd exists in \check{G}_{b_n} , such that $T_{B_k}^P(bd) = \min\{T_{B_k}^P(ef) : ef \in B_k = supp(B_k)\}$, $I_{B_k}^P(bd) = \min\{I_{B_k}^P(ef) : ef \in B_k = supp(B_k)\}$, $F_{B_k}^P(bd) = \max\{F_{B_k}^P(ef) : ef \in B_k = supp(B_k)\}$, $T_{B_k}^N(bd) = \max\{T_{B_k}^N(ef) : ef \in B_k = supp(B_k)\}$, $I_{B_k}^N(bd) = \max\{I_{B_k}^N(ef) : ef \in B_k = supp(B_k)\}$ or $F_{B_k}^N(bd) = \min\{F_{B_k}^N(ef) : ef \in B_k = supp(B_k)\}$.

Example 3. Consider a BSVNGS $\check{G}_{b_n} = (B, B_1, B_2)$ as depicted in Figure 3.

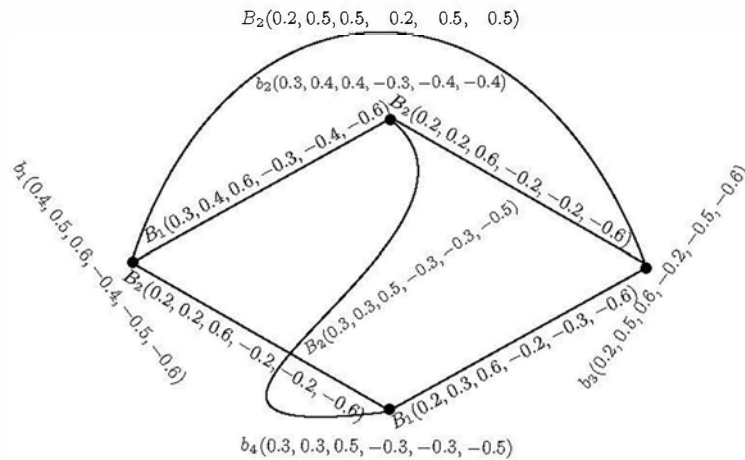

Figure 3. A BSVN fuzzy B_2 -cycle.

$T_{B_2}^P(bd) = \min\{T_{B_2}^P(ef) : ef \in B_2 = supp(B_2)\}$, $I_{B_2}^P(bd) = \min\{I_{B_2}^P(ef) : ef \in B_2 = supp(B_2)\}$, $F_{B_2}^P(bd) = \max\{F_{B_2}^P(ef) : ef \in B_2 = supp(B_2)\}$, $T_{B_2}^N(bd) = \max\{T_{B_2}^N(ef) : ef \in B_2 = supp(B_2)\}$, $I_{B_2}^N(bd) = \max\{I_{B_2}^N(ef) : ef \in B_2 = supp(B_2)\}$ or $F_{B_2}^N(bd) = \min\{F_{B_2}^N(ef) : ef \in B_2 = supp(B_2)\}$.

Definition 8. A sequence of vertices (distinct) in a BSVNGS $\check{G}_{b_n} = (B, B_1, B_2, \dots, B_m)$ is called a B_k -path, that is, b_1, b_2, \dots, b_m , such that $b_{k-1}b_k$ is a BSVN B_k -edge, for all $k = 2, \dots, m$.

Example 4. Consider a BSVNGS $\check{G}_{b_n} = (B, B_1, B_2)$ as represented in Figure 4.

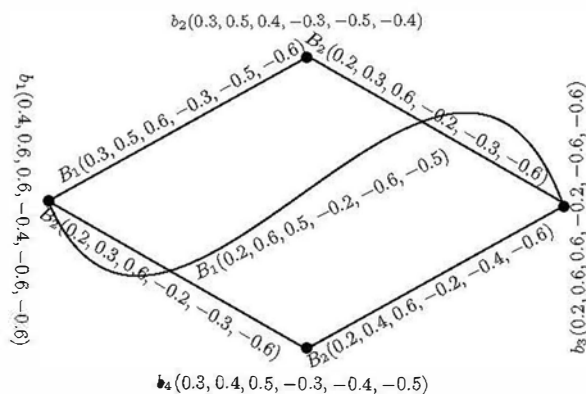

Figure 4. A BSVN B_2 -path.

In this BSVNGS, the sequence of distinct vertices b_1, b_4, b_3, b_2 is a BSVN B_2 -path.

Definition 9. Let $\check{G}_{bn} = (B, B_1, B_2, \dots, B_m)$ be a BSVNGS. The positive truth strength $T^P.P_{B_k}$, positive falsity strength $F^P.P_{B_k}$, and positive indeterminacy strength $I^P.P_{B_k}$ of a B_k -path, $P_{B_k} = b_1, b_2, \dots, b_n$, are defined as

$$T^P.P_{B_k} = \bigwedge_{h=2}^n [T_{B_k}^P(b_{h-1}b_h)], I^P.P_{B_k} = \bigwedge_{h=2}^n [I_{B_k}^P(b_{h-1}b_h)], F^P.P_{B_k} = \bigvee_{h=2}^n [F_{B_k}^P(b_{h-1}b_h)]$$

Similarly, the negative truth strength $T^N.P_{B_k}$, negative falsity strength $F^N.P_{B_k}$, and negative indeterminacy strength $I^N.P_{B_k}$ of a B_k -path are defined as

$$T^N.P_{B_k} = \bigvee_{h=2}^n [T_{B_k}^N(b_{h-1}b_h)], I^N.P_{B_k} = \bigvee_{h=2}^n [I_{B_k}^N(b_{h-1}b_h)], F^N.P_{B_k} = \bigwedge_{h=2}^n [F_{B_k}^N(b_{h-1}b_h)]$$

Example 5. Consider a BSVNGS $\check{G}_{bn} = (B, B_1, B_2, B_3)$ as shown in Figure 5.

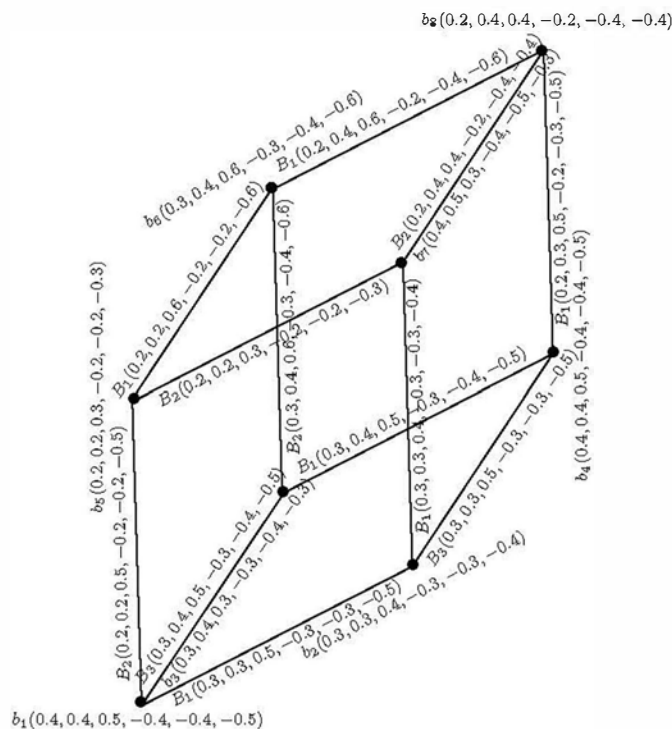

Figure 5. A bipolar single-valued neutrosophic graph structure (BSVNGS) $\check{G}_{bn} = (B, B_1, B_2, B_3)$.

In this BSVNGS, there is a B_1 -path, that is, $P_{B_1} = b_5, b_6, b_8, b_4, b_3$. Thus, $T^N.P_{B_1} = -0.2$, $I^N.P_{B_1} = -0.2$, $F^N.P_{B_2} = -0.6$, $T^P.P_{B_1} = 0.2$, $I^P.P_{B_1} = 0.2$ and $F^P.P_{B_2} = 0.6$.

Definition 10. Let $\check{G}_{b_m} = (B, B_1, B_2, \dots, B_m)$ be a BSVNGS. Then

- The B_k -positive strength of connectedness of truth between two nodes b and d is defined by $T_{B_k}^{P\infty}(bd) = \bigvee_{l \geq 1} \{T_{B_k}^{Pl}(bd)\}$, such that $T_{B_k}^{Pl}(bd) = (T_{B_k}^{Pl-1} \circ T_{B_k}^{Pl})(bd)$ for $l \geq 2$ and $T_{B_k}^{P2}(bd) = (T_{B_k}^{P1} \circ T_{B_k}^{P1})(bd) = \bigvee_y (T_{B_k}^{P1}(by) \wedge T_{B_k}^{P1}(yd))$.
- The B_k -positive strength of connectedness of indeterminacy between two nodes b and d is defined by $I_{B_k}^{P\infty}(bd) = \bigvee_{l \geq 1} \{I_{B_k}^{Pl}(bd)\}$, such that $I_{B_k}^{Pl}(bd) = (I_{B_k}^{Pl-1} \circ I_{B_k}^{Pl})(bd)$ for $l \geq 2$ and $I_{B_k}^{P2}(bd) = (I_{B_k}^{P1} \circ I_{B_k}^{P1})(bd) = \bigvee_y (I_{B_k}^{P1}(by) \wedge I_{B_k}^{P1}(yd))$.
- The B_k -positive strength of connectedness of falsity between two nodes b and d is defined by $F_{B_k}^{P\infty}(bd) = \bigwedge_{l \geq 1} \{F_{B_k}^{Pl}(bd)\}$, such that $F_{B_k}^{Pl}(bd) = (F_{B_k}^{Pl-1} \circ F_{B_k}^{Pl})(bd)$ for $l \geq 2$ and $F_{B_k}^{P2}(bd) = (F_{B_k}^{P1} \circ F_{B_k}^{P1})(bd) = \bigwedge_y (F_{B_k}^{P1}(by) \vee F_{B_k}^{P1}(yd))$.
- The B_k -negative strength of connectedness of truth between two nodes b and d is defined by $T_{B_k}^{N\infty}(bd) = \bigwedge_{l \geq 1} \{T_{B_k}^{Nl}(bd)\}$, such that $T_{B_k}^{Nl}(bd) = (T_{B_k}^{Nl-1} \circ T_{B_k}^{Nl})(bd)$ for $l \geq 2$ and $T_{B_k}^{N2}(bd) = (T_{B_k}^{N1} \circ T_{B_k}^{N1})(bd) = \bigwedge_y (T_{B_k}^{N1}(by) \vee T_{B_k}^{N1}(yd))$.
- The B_k -negative strength of connectedness of indeterminacy between two nodes b and d is defined by $I_{B_k}^{N\infty}(bd) = \bigwedge_{l \geq 1} \{I_{B_k}^{Nl}(bd)\}$, such that $I_{B_k}^{Nl}(bd) = (I_{B_k}^{Nl-1} \circ I_{B_k}^{Nl})(bd)$ for $l \geq 2$ and $I_{B_k}^{N2}(bd) = (I_{B_k}^{N1} \circ I_{B_k}^{N1})(bd) = \bigwedge_y (I_{B_k}^{N1}(by) \vee I_{B_k}^{N1}(yd))$.
- The B_k -negative strength of connectedness of falsity between two nodes b and d is defined by $F_{B_k}^{N\infty}(bd) = \bigvee_{l \geq 1} \{F_{B_k}^{Nl}(bd)\}$, such that $F_{B_k}^{Nl}(bd) = (F_{B_k}^{Nl-1} \circ F_{B_k}^{Nl})(bd)$ for $l \geq 2$ and $F_{B_k}^{N2}(bd) = (F_{B_k}^{N1} \circ F_{B_k}^{N1})(bd) = \bigvee_y (F_{B_k}^{N1}(by) \wedge F_{B_k}^{N1}(yd))$.

Definition 11. Let $\check{G}_{b_m} = (B, B_1, B_2, \dots, B_m)$ be a BSVNGS and "b" be a node in \check{G}_{b_m} . Let $(B', B'_1, B'_2, \dots, B'_m)$ be a BSVN subgraph structure of \check{G}_{b_m} induced by $B \setminus \{b\}$ such that $\forall e \neq b, f \neq b$

$$\begin{aligned}
 T_{B'_i}^P(b) &= I_{B'_i}^P(b) = F_{B'_i}^P(b) = T_{B'_i}^P(be) = I_{B'_i}^P(be) = F_{B'_i}^P(be) = 0 \\
 T_{B'_i}^N(b) &= I_{B'_i}^N(b) = F_{B'_i}^N(b) = T_{B'_i}^N(be) = I_{B'_i}^N(be) = F_{B'_i}^N(be) = 0 \\
 T_{B'_i}^P(e) &= T_B^P(e), I_{B'_i}^P(e) = I_B^P(e), F_{B'_i}^P(e) = F_B^P(e), T_{B'_i}^N(e) = T_B^N(e), I_{B'_i}^N(e) = I_B^N(e), F_{B'_i}^N(e) = F_B^N(e) \\
 T_{B'_i}^P(ef) &= T_{B_k}^P(ef), I_{B'_i}^P(ef) = I_{B_k}^P(ef), F_{B'_i}^P(ef) = F_{B_k}^P(ef), T_{B'_i}^N(ef) = T_{B_k}^N(ef), I_{B'_i}^N(ef) = I_{B_k}^N(ef) \\
 F_{B'_i}^N(ef) &= F_{B_k}^N(ef), \forall \text{ edges } be, ef \in \check{G}_{b_m}
 \end{aligned}$$

Then b is a BSVN fuzzy B_k cut-vertex if $T_{B_k}^{P\infty}(ef) > T_{B'_i}^{P\infty}(ef)$, $I_{B_k}^{P\infty}(ef) > I_{B'_i}^{P\infty}(ef)$, $F_{B_k}^{P\infty}(ef) > F_{B'_i}^{P\infty}(ef)$, $T_{B_k}^{N\infty}(ef) < T_{B'_i}^{N\infty}(ef)$, $I_{B_k}^{N\infty}(ef) < I_{B'_i}^{N\infty}(ef)$ and $F_{B_k}^{N\infty}(ef) < F_{B'_i}^{N\infty}(ef)$, for some $e, f \in B \setminus \{b\}$. Note that vertex b is a BSVN fuzzy $B_k - T^P$ cut-vertex if $T_{B_k}^{P\infty}(ef) > T_{B'_i}^{P\infty}(ef)$, it is a BSVN fuzzy $B_k - I^P$ cut-vertex if $I_{B_k}^{P\infty}(ef) > I_{B'_i}^{P\infty}(ef)$, and it is a BSVN fuzzy $B_k - F^P$ cut-vertex if $F_{B_k}^{P\infty}(ef) > F_{B'_i}^{P\infty}(ef)$. Moreover, vertex b is a BSVN fuzzy $B_k - T^N$ cut-vertex if $T_{B_k}^{N\infty}(ef) < T_{B'_i}^{N\infty}(ef)$, it is a BSVN fuzzy $B_k - I^N$ cut-vertex if $I_{B_k}^{N\infty}(ef) < I_{B'_i}^{N\infty}(ef)$ and it is a BSVN fuzzy $B_k - F^N$ cut-vertex if $F_{B_k}^{N\infty}(ef) < F_{B'_i}^{N\infty}(ef)$.

Example 6. Consider a BSVNGS $\check{G}_{b_m} = (B, B_1, B_2)$ as depicted in Figure 6, and let $\check{G}'_{b_h} = (B', B'_1, B'_2)$ be a BSVN subgraph structure of the BSVNGS \check{G}_{b_m} , which is obtained through deletion of vertex b_2 .

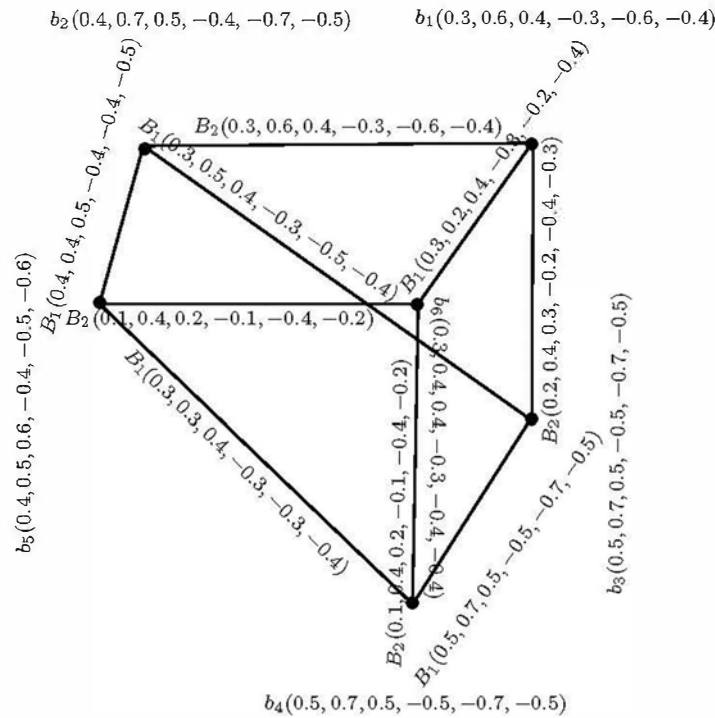

Figure 6. A BSVNGS $\check{G}_{bn}^x = (B, B_1, B_2)$.

The vertex b_2 is a BSVN fuzzy $B_1 - I^P$ cut-vertex and a BSVN fuzzy $B_1 - I^N$ cut-vertex, because $I_{B_1}^{P\infty}(b_2b_5) = 0$, $I_{B_1}^{P\infty}(b_2b_5) = 0.5$, $I_{B_1}^{P\infty}(b_4b_3) = 0.7$, $I_{B_1}^{P\infty}(b_4b_3) = 0.7$, $I_{B_1}^{P\infty}(b_3b_5) = 0.3$, $I_{B_1}^{P\infty}(b_3b_5) = 0.4$. $I_{B_1}^{N\infty}(b_2b_5) = 0 > -0.5 = I_{B_1}^{N\infty}(b_2b_5)$, $I_{B_1}^{N\infty}(b_4b_3) = 0.7 = I_{B_1}^{N\infty}(b_4b_3)$ and $I_{B_1}^{N\infty}(b_3b_5) = -0.3 > -0.4 = I_{B_1}^{N\infty}(b_3b_5)$.

Definition 12. Suppose $\check{G}_{bn} = (B, B_1, B_2, \dots, B_m)$ is a BSVNGS and bd is a B_k -edge. Let $(B', B'_1, B'_2, \dots, B'_m)$ be a BSVN fuzzy spanning subgraph structure of \check{G}_{bn} , such that

$$T_{B'_k}^P(bd) = 0 = I_{B'_k}^P(bd) = F_{B'_k}^P(bd), T_{B'_k}^N(bd) = 0 = I_{B'_k}^N(bd) = F_{B'_k}^N(bd)$$

$$T_{B'_k}^P(gh) = T_{B'_k}^P(gh), I_{B'_k}^P(gh) = I_{B'_k}^P(gh)$$

$$F_{B'_k}^P(bd) = F_{B'_k}^P(bd), T_{B'_k}^N(gh) = T_{B'_k}^N(gh), I_{B'_k}^N(gh) = I_{B'_k}^N(gh), F_{B'_k}^N(bd) = F_{B'_k}^N(bd), \forall \text{ edges } gh \neq bd$$

Then bd is a BSVN fuzzy B_k -bridge if $T_{B'_k}^{P\infty}(ef) > T_{B'_k}^{P\infty}(ef)$, $I_{B'_k}^{P\infty}(ef) > I_{B'_k}^{P\infty}(ef)$, $F_{B'_k}^{P\infty}(ef) > F_{B'_k}^{P\infty}(ef)$, $T_{B'_k}^{N\infty}(ef) < T_{B'_k}^{N\infty}(ef)$, $I_{B'_k}^{N\infty}(ef) < I_{B'_k}^{N\infty}(ef)$ and $F_{B'_k}^{N\infty}(ef) < F_{B'_k}^{N\infty}(ef)$, for some $e, f \in V$. Note that bd is a BSVN fuzzy $B_k - T^P$ bridge if $T_{B'_k}^{P\infty}(ef) > T_{B'_k}^{P\infty}(ef)$, it is a BSVN fuzzy $B_k - I^P$ bridge if $I_{B'_k}^{P\infty}(ef) > I_{B'_k}^{P\infty}(ef)$ and it is a BSVN fuzzy $B_k - F^P$ bridge if $F_{B'_k}^{P\infty}(ef) > F_{B'_k}^{P\infty}(ef)$. Moreover, bd is a BSVN fuzzy $B_k - T^N$ bridge if $T_{B'_k}^{N\infty}(ef) < T_{B'_k}^{N\infty}(ef)$, it is a BSVN fuzzy $B_k - I^N$ bridge if $I_{B'_k}^{N\infty}(ef) < I_{B'_k}^{N\infty}(ef)$ and it is a BSVN fuzzy $B_k - F^N$ bridge if $F_{B'_k}^{N\infty}(ef) < F_{B'_k}^{N\infty}(ef)$.

Example 7. Consider a BSVNGS $\check{G}_{bn} = (B, B_1, B_2)$ as depicted in Figure 6 and $\check{G}_{bs}' = (B', B'_1, B'_2)$, a BSVN spanning subgraph structure of the BSVNGS \check{G}_{bn} obtained by deleting B_1 -edge (b_2b_5) and that is shown in Figure 7.

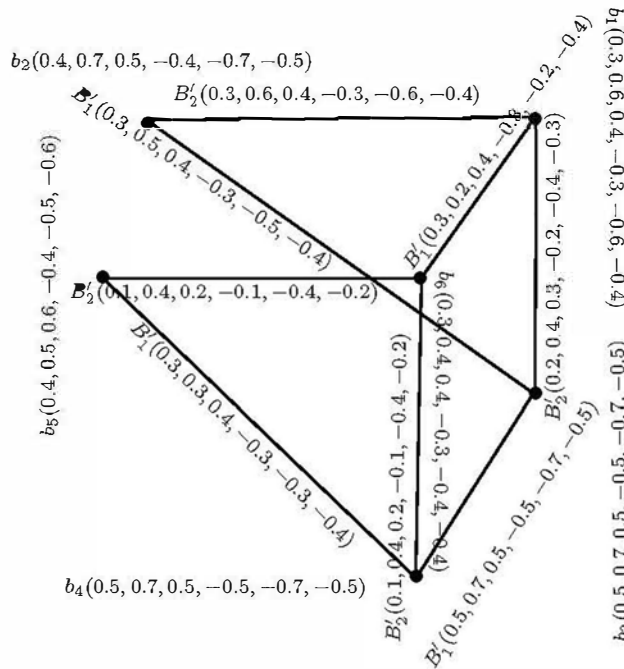

Figure 7. A BSVNGS $\check{G}'_{bs} = (B', B'_1, B'_2)$.

This edge (b_2b_5) is a BSVN fuzzy B_1 -bridge, as $T_{B'_1}^{P\infty}(b_2b_5) = 0.3$, $T_{B_1}^{P\infty}(b_2b_5) = 0.4$, $I_{B'_1}^{P\infty}(b_2b_5) = 0.3$, $I_{B_1}^{P\infty}(b_2b_5) = 0.4$, $F_{B'_1}^{P\infty}(b_2b_5) = 0.4$, $F_{B_1}^{P\infty}(b_2b_5) = 0.5$, $T_{B'_1}^{N\infty}(b_2b_5) = -0.3 > -0.4 = T_{B_1}^{N\infty}(b_2b_5)$, $I_{B'_1}^{N\infty}(b_2b_5) = -0.3 > -0.4 = I_{B_1}^{N\infty}(b_2b_5)$, and $F_{B'_1}^{N\infty}(b_2b_5) = -0.4 > -0.5 = F_{B_1}^{N\infty}(b_2b_5)$.

Definition 13. A BSVNGS $\check{G}_{bn} = (B, B_1, B_2, \dots, B_m)$ is a B_k -tree if $(supp(B), supp(B_1), supp(B_2), \dots, supp(B_m))$ is a B_k -tree. Alternatively, \check{G}_{bn} is a B_k -tree if \check{G}_{bn} has a subgraph induced by $supp(B_k)$ that forms a tree.

Example 8. Consider the BSVNGS $\check{G}_{bn} = (B, B_1, B_2)$ as depicted in Figure 8.

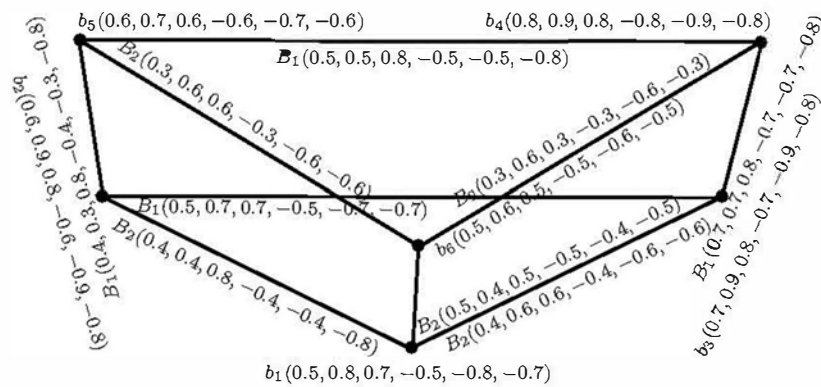

Figure 8. A BSVN B_2 -tree.

This BSVNGS $\check{G}_{bn} = (B, B_1, B_2)$ is a B_2 -tree, as $(supp(B), supp(B_1), supp(B_2))$ is a B_2 -tree.

Definition 14. A BSVNGS $\check{G}_{bn} = (B, B_1, B_2, \dots, B_m)$ is a BSVN fuzzy B_k -tree if \check{G}_{bn} has a BSVN fuzzy spanning subgraph structure $\check{H}_{bn} = (B', B'_1, B'_2, \dots, B'_m)$ such that for all B_k -edges, bd not in \check{H}_{bn} :

1. \check{H}_{bn} is a B'_k -tree.

2. $T_{B_k}^P(bd) < T_{B_k'}^{P\infty}(bd)$, $I_{B_k}^P(bd) < I_{B_k'}^{P\infty}(bd)$, $F_{B_k}^P(bd) < F_{B_k'}^{P\infty}(bd)$, $T_{B_k}^N(bd) > T_{B_k'}^{N\infty}(bd)$, $I_{B_k}^N(bd) > I_{B_k'}^{N\infty}(bd)$, and $F_{B_k}^N(bd) > F_{B_k'}^{N\infty}(bd)$.

In particular, \check{G}_{bn} is a BSVN fuzzy $B_k - T^P$ tree if $T_{B_k}^P(bd) < T_{B_k'}^{P\infty}(bd)$, it is a BSVN fuzzy $B_k - I^P$ tree if $I_{B_k}^P(bd) < I_{B_k'}^{P\infty}(bd)$, and it is a BSVN fuzzy $B_k - F^P$ tree if $F_{B_k}^P(bd) > F_{B_k'}^{P\infty}(bd)$. Moreover, \check{G}_{bn} is a BSVN fuzzy $B_k - T^N$ tree if $T_{B_k}^N(bd) > T_{B_k'}^{N\infty}(bd)$, it is a BSVN fuzzy $B_k - I^N$ tree if $I_{B_k}^N(bd) > I_{B_k'}^{N\infty}(bd)$, and it is a BSVN fuzzy $B_k - F^N$ tree if $F_{B_k}^N(bd) < F_{B_k'}^{N\infty}(bd)$.

Example 9. Consider the BSVNGS $\check{G}_{bn} = (B, B_1, B_2)$ as depicted in Figure 9.

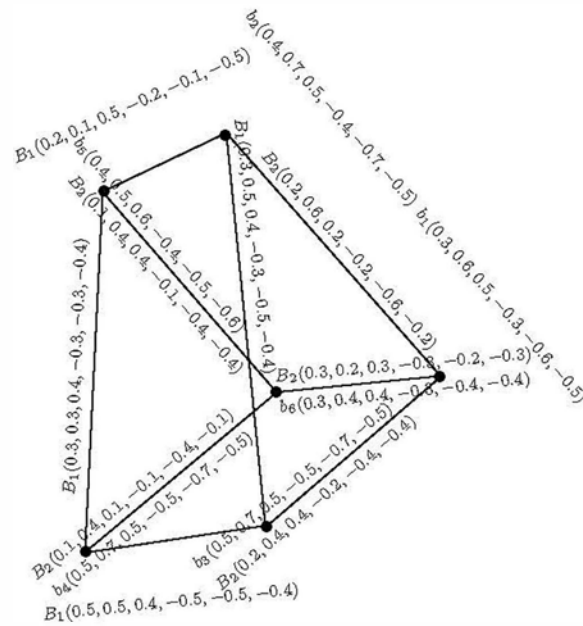

Figure 9. A BSVN fuzzy B_1 -tree.

It is B_2 -tree, rather than a B_1 -tree. However, it is a BSVN fuzzy B_1 -tree, because it has a BSVN fuzzy spanning subgraph (B', B_1', B_2') as a B_1' -tree, which is obtained through the deletion of the B_1 -edge b_2b_5 from \check{G}_{bn} . Moreover, $T_{B_1'}^{P\infty}(b_2b_5) = 0.3$, $T_{B_1'}^P(b_2b_5) = 0.2$, $I_{B_1'}^{P\infty}(b_2b_5) = 0.3$, $I_{B_1'}^P(b_2b_5) = 0.1$, $F_{B_1'}^{P\infty}(b_2b_5) = 0.4$, $F_{B_1'}(b_2b_5) = 0.5$, $T_{B_1'}^{N\infty}(b_2b_5) = -0.3 < -0.2 = T_{B_1'}^N(b_2b_5)$, $I_{B_1'}^{N\infty}(b_2b_5) = -0.3 < -0.1 = I_{B_1'}^N(b_2b_5)$ and $F_{B_1'}^{N\infty}(b_2b_5) = -0.4 > -0.5 = F_{B_1'}(b_2b_5)$.

Now we define the operations on BSVNGSs.

Definition 15. Let $\check{G}_{b1} = (B_1, B_{11}, B_{12}, \dots, B_{1m})$ and $\check{G}_{b2} = (B_2, B_{21}, B_{22}, \dots, B_{2m})$ be two BSVNGSs. The Cartesian product of \check{G}_{b1} and \check{G}_{b2} , denoted by

$$\check{G}_{b1} \times \check{G}_{b2} = (B_1 \times B_2, B_{11} \times B_{21}, B_{12} \times B_{22}, \dots, B_{1m} \times B_{2m})$$

is defined as

$$(i) \quad \begin{cases} T_{(B_1 \times B_2)}^P(bd) = (T_{B_1}^P \times T_{B_2}^P)(bd) = T_{B_1}^P(b) \wedge T_{B_2}^P(d) \\ I_{(B_1 \times B_2)}^P(bd) = (I_{B_1}^P \times I_{B_2}^P)(bd) = I_{B_1}^P(b) \wedge I_{B_2}^P(d) \\ F_{(B_1 \times B_2)}^P(bd) = (F_{B_1}^P \times F_{B_2}^P)(bd) = F_{B_1}^P(b) \vee F_{B_2}^P(d) \end{cases}$$

$$\begin{aligned}
 \text{(ii)} \quad & \begin{cases} T_{(B_1 \times B_2)}^N(bd) = (T_{B_1}^N \times T_{B_2}^N)(bd) = T_{B_1}^N(b) \vee T_{B_2}^N(d) \\ I_{(B_1 \times B_2)}^N(bd) = (I_{B_1}^N \times I_{B_2}^N)(bd) = I_{B_1}^N(b) \vee I_{B_2}^N(d) \\ F_{(B_1 \times B_2)}^N(bd) = (F_{B_1}^N \times F_{B_2}^N)(bd) = F_{B_1}^N(b) \wedge F_{B_2}^N(d) \end{cases} \\
 & \text{for all } (bd) \in V_1 \times V_2, \\
 \text{(iii)} \quad & \begin{cases} T_{(B_{1k} \times B_{2k})}^P(bd_1)(bd_2) = (T_{B_{1k}}^P \times T_{B_{2k}}^P)(bd_1)(bd_2) = T_{B_{1k}}^P(b) \wedge T_{B_{2k}}^P(d_1d_2) \\ I_{(B_{1k} \times B_{2k})}^P(bd_1)(bd_2) = (I_{B_{1k}}^P \times I_{B_{2k}}^P)(bd_1)(bd_2) = I_{B_{1k}}^P(b) \wedge I_{B_{2k}}^P(d_1d_2) \\ F_{(B_{1k} \times B_{2k})}^P(bd_1)(bd_2) = (F_{B_{1k}}^P \times F_{B_{2k}}^P)(bd_1)(bd_2) = F_{B_{1k}}^P(b) \vee F_{B_{2k}}^P(d_1d_2) \end{cases} \\
 \text{(iv)} \quad & \begin{cases} T_{(B_{1k} \times B_{2k})}^N(bd_1)(bd_2) = (T_{B_{1k}}^N \times T_{B_{2k}}^N)(bd_1)(bd_2) = T_{B_{1k}}^N(b) \vee T_{B_{2k}}^N(d_1d_2) \\ I_{(B_{1k} \times B_{2k})}^N(bd_1)(bd_2) = (I_{B_{1k}}^N \times I_{B_{2k}}^N)(bd_1)(bd_2) = I_{B_{1k}}^N(b) \vee I_{B_{2k}}^N(d_1d_2) \\ F_{(B_{1k} \times B_{2k})}^N(bd_1)(bd_2) = (F_{B_{1k}}^N \times F_{B_{2k}}^N)(bd_1)(bd_2) = F_{B_{1k}}^N(b) \wedge F_{B_{2k}}^N(d_1d_2) \end{cases} \\
 & \text{for all } b \in V_1, (d_1d_2) \in V_{2k}, \text{ and} \\
 \text{(v)} \quad & \begin{cases} T_{(B_{1k} \times B_{2k})}^P(b_1d)(b_2d) = (T_{B_{1k}}^P \times T_{B_{2k}}^P)(b_1d)(b_2d) = T_{B_{2k}}^P(d) \wedge T_{B_{1k}}^P(b_1b_2) \\ I_{(B_{1k} \times B_{2k})}^P(b_1d)(b_2d) = (I_{B_{1k}}^P \times I_{B_{2k}}^P)(b_1d)(b_2d) = I_{B_{2k}}^P(d) \wedge I_{B_{1k}}^P(b_1b_2) \\ F_{(B_{1k} \times B_{2k})}^P(b_1d)(b_2d) = (F_{B_{1k}}^P \times F_{B_{2k}}^P)(b_1d)(b_2d) = F_{B_{2k}}^P(d) \vee F_{B_{1k}}^P(b_1b_2) \end{cases} \\
 \text{(vi)} \quad & \begin{cases} T_{(B_{1k} \times B_{2k})}^N(b_1d)(b_2d) = (T_{B_{1k}}^N \times T_{B_{2k}}^N)(b_1d)(b_2d) = T_{B_{2k}}^N(d) \vee T_{B_{1k}}^N(b_1b_2) \\ I_{(B_{1k} \times B_{2k})}^N(b_1d)(b_2d) = (I_{B_{1k}}^N \times I_{B_{2k}}^N)(b_1d)(b_2d) = I_{B_{2k}}^N(d) \vee I_{B_{1k}}^N(b_1b_2) \\ F_{(B_{1k} \times B_{2k})}^N(b_1d)(b_2d) = (F_{B_{1k}}^N \times F_{B_{2k}}^N)(b_1d)(b_2d) = F_{B_{2k}}^N(d) \wedge F_{B_{1k}}^N(b_1b_2) \end{cases} \\
 & \text{for all } d \in V_2, (b_1b_2) \in V_{1k}.
 \end{aligned}$$

Example 10. Consider $\check{G}_{b_1} = (B_1, B_{11}, B_{12})$ and $\check{G}_{b_2} = (B_2, B_{21}, B_{22})$ as BSVNGSs of GSs $\check{G}_{s_1} = (V_1, V_{11}, V_{12})$ and $\check{G}_{s_2} = (V_2, V_{21}, V_{22})$, respectively, as depicted in Figure 10, where $V_{11} = \{b_1b_2\}$, $V_{12} = \{b_3b_4\}$, $V_{21} = \{d_1d_2\}$, and $V_{22} = \{d_3d_4\}$.

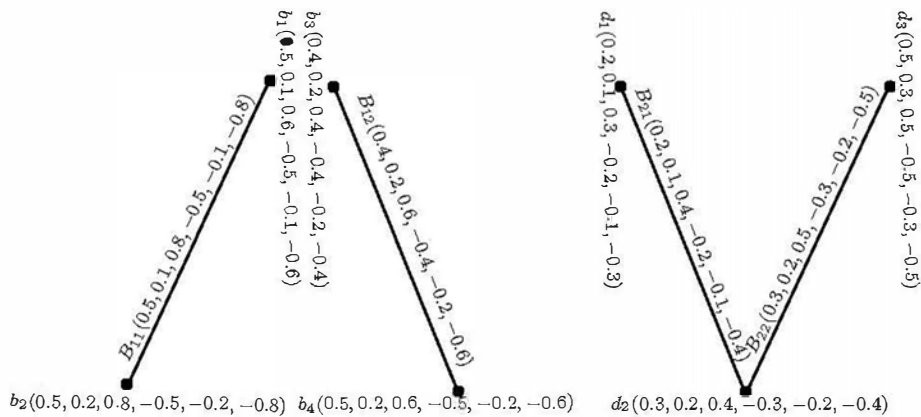

Figure 10. Two BSVNGSs \check{G}_{b_1} and \check{G}_{b_2} .

The Cartesian product of \check{G}_{b_1} and \check{G}_{b_2} , defined as $\check{G}_{b_1} \times \check{G}_{b_2} = \{B_1 \times B_2, B_{11} \times B_{21}, B_{12} \times B_{22}\}$, is depicted in Figures 11 and 12.

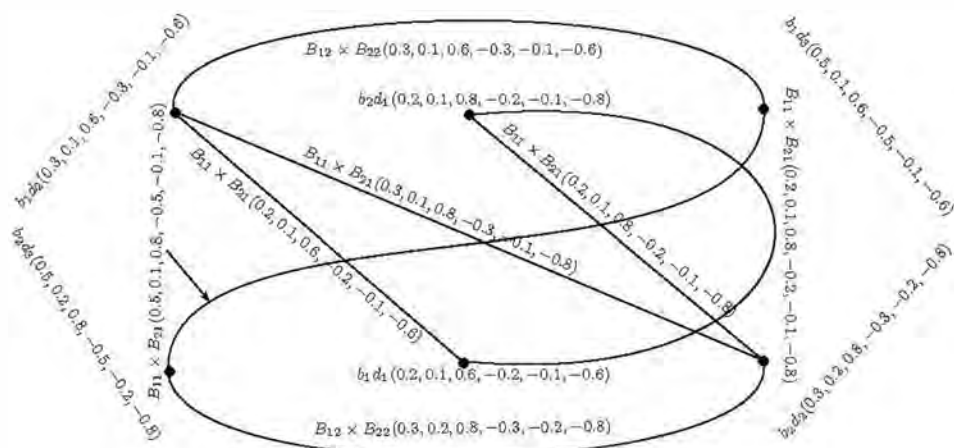

Figure 11. $\check{G}_{b1} \times \check{G}_{b2}$.

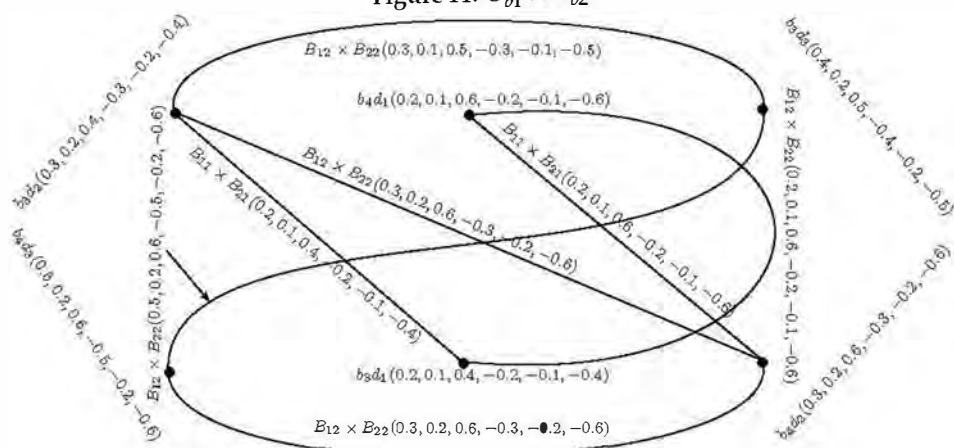

Figure 12. $\check{G}_{b1} \times \check{G}_{b2}$.

Theorem 1. The Cartesian product $\check{G}_{b1} \times \check{G}_{b2} = (B_1 \times B_2, B_{11} \times B_{21}, B_{12} \times B_{22}, \dots, B_{1m} \times B_{2m})$ of two BSVNSGSs of GSs \check{G}_{s1} and \check{G}_{s2} is a BSVNGS of $\check{G}_{s1} \times \check{G}_{s2}$.

Proof. Consider two cases:

Case 1. For $b \in V_1, d_1d_2 \in V_{2k}$,

$$\begin{aligned} T_{(B_{1k} \times B_{2k})}^P((bd_1)(bd_2)) &= T_{B_1}^P(b) \wedge T_{B_{2k}}^P(d_1d_2) \\ &\leq T_{B_1}^P(b) \wedge [T_{B_2}^P(d_1) \wedge T_{B_2}^P(d_2)] \\ &= [T_{B_1}^P(b) \wedge T_{B_2}^P(d_1)] \wedge [T_{B_1}^P(b) \wedge T_{B_2}^P(d_2)] \\ &= T_{(B_1 \times B_2)}^P(bd_1) \wedge T_{(B_1 \times B_2)}^P(bd_2) \end{aligned}$$

$$\begin{aligned} T_{(B_{1k} \times B_{2k})}^N((bd_1)(bd_2)) &= T_{B_1}^N(b) \vee T_{B_{2k}}^N(d_1d_2) \\ &\geq T_{B_1}^N(b) \vee [T_{B_2}^N(d_1) \vee T_{B_2}^N(d_2)] \\ &= [T_{B_1}^N(b) \vee T_{B_2}^N(d_1)] \vee [T_{B_1}^N(b) \vee T_{B_2}^N(d_2)] \\ &= T_{(B_1 \times B_2)}^N(bd_1) \vee T_{(B_1 \times B_2)}^N(bd_2) \end{aligned}$$

$$\begin{aligned}
 I_{(B_{1k} \times B_{2k})}^P((bd_1)(bd_2)) &= I_{B_1}^P(b) \wedge I_{B_{2k}}^P(d_1d_2) \\
 &\leq I_{B_1}^P(b) \wedge [I_{B_2}^P(d_1) \wedge I_{B_2}^P(d_2)] \\
 &= [I_{B_1}^P(b) \wedge I_{B_2}^P(d_1)] \wedge [I_{B_1}^P(b) \wedge I_{B_2}^P(d_2)] \\
 &= I_{(B_1 \times B_2)}^P(bd_1) \wedge I_{(B_1 \times B_2)}^P(bd_2)
 \end{aligned}$$

$$\begin{aligned}
 I_{(B_{1k} \times B_{2k})}^N((bd_1)(bd_2)) &= I_{B_1}^N(b) \vee I_{B_{2k}}^N(d_1d_2) \\
 &\geq I_{B_1}^N(b) \vee [I_{B_2}^N(d_1) \vee I_{B_2}^N(d_2)] \\
 &= [I_{B_1}^N(b) \vee I_{B_2}^N(d_1)] \vee [I_{B_1}^N(b) \vee I_{B_2}^N(d_2)] \\
 &= I_{(B_1 \times B_2)}^N(bd_1) \vee I_{(B_1 \times B_2)}^N(bd_2)
 \end{aligned}$$

$$\begin{aligned}
 F_{(B_{1k} \times B_{2k})}^P((bd_1)(bd_2)) &= F_{B_1}^P(b) \vee F_{B_{2k}}^P(d_1d_2) \\
 &\leq F_{B_1}^P(b) \vee [F_{B_2}^P(d_1) \vee F_{B_2}^P(d_2)] \\
 &= [F_{B_1}^P(b) \vee F_{B_2}^P(d_1)] \vee [F_{B_1}^P(b) \vee F_{B_2}^P(d_2)] \\
 &= F_{(B_1 \times B_2)}^P(bd_1) \vee F_{(B_1 \times B_2)}^P(bd_2)
 \end{aligned}$$

$$\begin{aligned}
 F_{(B_{1k} \times B_{2k})}^N((bd_1)(bd_2)) &= F_{B_1}^N(b) \wedge F_{B_{2k}}^N(d_1d_2) \\
 &\geq F_{B_1}^N(b) \wedge [F_{B_2}^N(d_1) \wedge F_{B_2}^N(d_2)] \\
 &= [F_{B_1}^N(b) \wedge F_{B_2}^N(d_1)] \wedge [F_{B_1}^N(b) \wedge F_{B_2}^N(d_2)] \\
 &= F_{(B_1 \times B_2)}^N(bd_1) \wedge F_{(B_1 \times B_2)}^N(bd_2)
 \end{aligned}$$

for $bd_1, bd_2 \in V_1 \times V_2$.

Case 2. For $b \in V_2, d_1d_2 \in V_{1k}$,

$$\begin{aligned}
 T_{(B_{1k} \times B_{2k})}^P((d_1b)(d_2b)) &= T_{B_2}^P(b) \wedge T_{B_{1k}}^P(d_1d_2) \\
 &\leq T_{B_2}^P(b) \wedge [T_{B_1}^P(d_1) \wedge T_{B_1}^P(d_2)] \\
 &= [T_{B_2}^P(b) \wedge T_{B_1}^P(d_1)] \wedge [T_{B_2}^P(b) \wedge T_{B_1}^P(d_2)] \\
 &= T_{(B_1 \times B_2)}^P(d_1b) \wedge T_{(B_1 \times B_2)}^P(d_2b)
 \end{aligned}$$

$$\begin{aligned}
 T_{(B_{1k} \times B_{2k})}^N((d_1b)(d_2b)) &= T_{B_2}^N(b) \vee T_{B_{1k}}^N(d_1d_2) \\
 &\geq T_{B_2}^N(b) \vee [T_{B_1}^N(d_1) \vee T_{B_1}^N(d_2)] \\
 &= [T_{B_2}^N(b) \vee T_{B_1}^N(d_1)] \vee [T_{B_2}^N(b) \vee T_{B_1}^N(d_2)] \\
 &= T_{(B_1 \times B_2)}^N(d_1b) \vee T_{(B_1 \times B_2)}^N(d_2b)
 \end{aligned}$$

$$\begin{aligned}
 I_{(B_{1k} \times B_{2k})}^P((d_1b)(d_2b)) &= I_{B_2}^P(b) \wedge I_{B_{1k}}^P(d_1d_2) \\
 &\leq I_{B_2}^P(b) \wedge [I_{B_1}^P(d_1) \wedge I_{B_1}^P(d_2)] \\
 &= [I_{B_2}^P(b) \wedge I_{B_1}^P(d_1)] \wedge [I_{B_2}^P(b) \wedge I_{B_1}^P(d_2)] \\
 &= I_{(B_1 \times B_2)}^P(d_1b) \wedge I_{(B_1 \times B_2)}^P(d_2b)
 \end{aligned}$$

$$\begin{aligned}
 I_{(B_{1k} \times B_{2k})}^N((d_1b)(d_2b)) &= I_{B_2}^N(b) \vee I_{B_{1k}}^N(d_1d_2) \\
 &\geq I_{B_2}^N(b) \vee [I_{B_1}^N(d_1) \vee I_{B_1}^N(d_2)] \\
 &= [I_{B_2}^N(b) \vee I_{B_1}^N(d_1)] \vee [I_{B_2}^N(b) \vee I_{B_1}^N(d_2)] \\
 &= I_{(B_1 \times B_2)}^N(d_1b) \vee I_{(B_1 \times B_2)}^N(d_2b)
 \end{aligned}$$

$$\begin{aligned}
 F_{(B_{1k} \times B_{2k})}^P((d_1b)(d_2b)) &= F_{B_2}^P(b) \vee F_{B_{1k}}^P(d_1d_2) \\
 &\leq F_{B_2}^P(b) \vee [F_{B_1}^P(d_1) \vee F_{B_1}^P(d_2)] \\
 &= [F_{B_2}^P(b) \vee F_{B_1}^P(d_1)] \vee [F_{B_2}^P(b) \vee F_{B_1}^P(d_2)] \\
 &= F_{(B_1 \times B_2)}^P(d_1b) \vee F_{(B_1 \times B_2)}^P(d_2b)
 \end{aligned}$$

$$\begin{aligned}
 F_{(B_{1k} \times B_{2k})}^N((d_1b)(d_2b)) &= F_{B_2}^N(b) \wedge F_{B_{1k}}^N(d_1d_2) \\
 &\geq F_{B_2}^N(b) \wedge [F_{B_1}^N(d_1) \wedge F_{B_1}^N(d_2)] \\
 &= [F_{B_2}^N(b) \wedge F_{B_1}^N(d_1)] \wedge [F_{B_2}^N(b) \wedge F_{B_1}^N(d_2)] \\
 &= F_{(B_1 \times B_2)}^N(d_1b) \wedge F_{(B_1 \times B_2)}^N(d_2b)
 \end{aligned}$$

for $d_1b, d_2b \in V_1 \times V_2$.

Both cases hold for all $k \in \{1, 2, \dots, m\}$. This completes the proof. \square

Definition 16. Let $\check{G}_{b_1} = (B_1, B_{11}, B_{12}, \dots, B_{1m})$ and $\check{G}_{b_2} = (B_2, B_{21}, B_{22}, \dots, B_{2m})$ be two BSVNGSs. The cross product of \check{G}_{b_1} and \check{G}_{b_2} , denoted by

$$\check{G}_{b_1} * \check{G}_{b_2} = (B_1 * B_2, B_{11} * B_{21}, B_{12} * B_{22}, \dots, B_{1m} * B_{2m})$$

is defined as

$$\begin{aligned}
 \text{(i)} \quad &\begin{cases} T_{(B_1 * B_2)}^P(bd) = (T_{B_1}^P * T_{B_2}^P)(bd) = T_{B_1}^P(b) \wedge T_{B_2}^P(d) \\ I_{(B_1 * B_2)}^P(bd) = (I_{B_1}^P * I_{B_2}^P)(bd) = I_{B_1}^P(b) \wedge I_{B_2}^P(d) \\ F_{(B_1 * B_2)}^P(bd) = (F_{B_1}^P * F_{B_2}^P)(bd) = F_{B_1}^P(b) \vee F_{B_2}^P(d) \end{cases} \\
 \text{(ii)} \quad &\begin{cases} T_{(B_1 * B_2)}^N(bd) = (T_{B_1}^N * T_{B_2}^N)(bd) = T_{B_1}^N(b) \vee T_{B_2}^N(d) \\ I_{(B_1 * B_2)}^N(bd) = (I_{B_1}^N * I_{B_2}^N)(bd) = I_{B_1}^N(b) \vee I_{B_2}^N(d) \\ F_{(B_1 * B_2)}^N(bd) = (F_{B_1}^N * F_{B_2}^N)(bd) = F_{B_1}^N(b) \wedge F_{B_2}^N(d) \end{cases} \\
 &\text{for all } (bd) \in V_1 \times V_2, \text{ and} \\
 \text{(iii)} \quad &\begin{cases} T_{(B_{1k} * B_{2k})}^P(b_1d_1)(b_2d_2) = (T_{B_{1k}}^P * T_{B_{2k}}^P)(b_1d_1)(b_2d_2) = T_{B_{1k}}^P(b_1b_2) \wedge T_{B_{2k}}^P(d_1d_2) \\ I_{(B_{1k} * B_{2k})}^P(b_1d_1)(b_2d_2) = (I_{B_{1k}}^P * I_{B_{2k}}^P)(b_1d_1)(b_2d_2) = I_{B_{1k}}^P(b_1b_2) \wedge I_{B_{2k}}^P(d_1d_2) \\ F_{(B_{1k} * B_{2k})}^P(b_1d_1)(b_2d_2) = (F_{B_{1k}}^P * F_{B_{2k}}^P)(b_1d_1)(b_2d_2) = F_{B_{1k}}^P(b_1b_2) \vee F_{B_{2k}}^P(d_1d_2) \end{cases} \\
 \text{(iv)} \quad &\begin{cases} T_{(B_{1k} * B_{2k})}^N(b_1d_1)(b_2d_2) = (T_{B_{1k}}^N * T_{B_{2k}}^N)(b_1d_1)(b_2d_2) = T_{B_{1k}}^N(b_1b_2) \vee T_{B_{2k}}^N(d_1d_2) \\ I_{(B_{1k} * B_{2k})}^N(b_1d_1)(b_2d_2) = (I_{B_{1k}}^N * I_{B_{2k}}^N)(b_1d_1)(b_2d_2) = I_{B_{1k}}^N(b_1b_2) \vee I_{B_{2k}}^N(d_1d_2) \\ F_{(B_{1k} * B_{2k})}^N(b_1d_1)(b_2d_2) = (F_{B_{1k}}^N * F_{B_{2k}}^N)(b_1d_1)(b_2d_2) = F_{B_{1k}}^N(b_1b_2) \wedge F_{B_{2k}}^N(d_1d_2) \end{cases} \\
 &\text{for all } (b_1b_2) \in V_{1k}, (d_1d_2) \in V_{2k}.
 \end{aligned}$$

Example 11. The cross product of BSVNGSs \check{G}_{b_1} and \check{G}_{b_2} shown in Figure 10 is defined as $\check{G}_{b_1} * \check{G}_{b_2} = \{B_1 * B_2, B_{11} * B_{21}, B_{12} * B_{22}\}$ and is depicted in Figure 13.

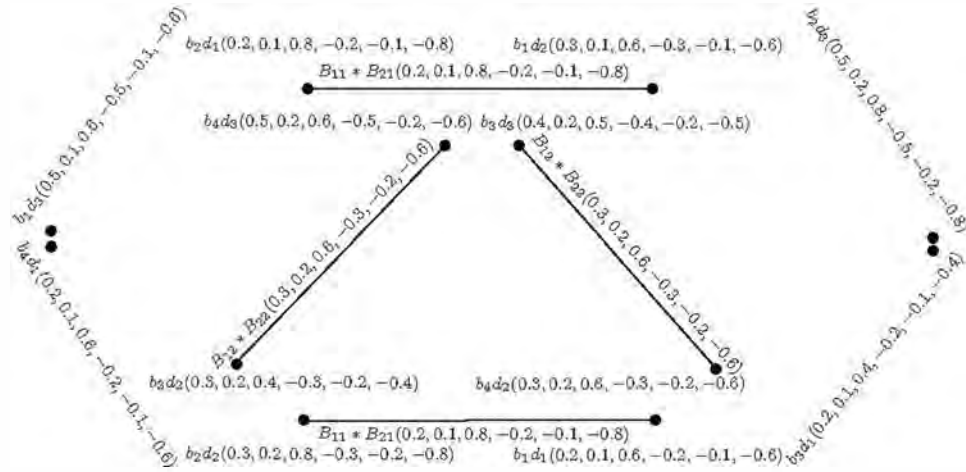

Figure 13. $\check{G}_{b1} \times \check{G}_{b2}$.

Theorem 2. The cross product $\check{G}_{b1} * \check{G}_{b2} = (B_1 * B_2, B_{11} * B_{21}, B_{12} * B_{22}, \dots, B_{1m} * B_{2m})$ of two BSVNSGSs of GSs \check{G}_{s1} and \check{G}_{s2} is a BSVNSGS of $\check{G}_{s1} * \check{G}_{s2}$.

Proof. For $b_1 b_2 \in V_{1k}, d_1 d_2 \in V_{2k}$,

$$\begin{aligned} T_{(B_{1k} * B_{2k})}^P((b_1 d_1)(b_2 d_2)) &= T_{B_{1k}}^P(b_1 b_2) \wedge T_{B_{2k}}^P(d_1 d_2) \\ &\leq [T_{B_1}^P(b_1) \wedge T_{B_1}^P(b_2)] \wedge [T_{B_2}^P(d_1) \wedge T_{B_2}^P(d_2)] \\ &= [T_{B_1}^P(b_1) \wedge T_{B_2}^P(d_1)] \wedge [T_{B_1}^P(b_2) \wedge T_{B_2}^P(d_2)] \\ &= T_{(B_1 * B_2)}^P(b_1 d_1) \wedge T_{(B_1 * B_2)}^P(b_2 d_2) \end{aligned}$$

$$\begin{aligned} T_{(B_{1k} * B_{2k})}^N((b_1 d_1)(b_2 d_2)) &= T_{B_{1k}}^N(b_1 b_2) \vee T_{B_{2k}}^N(d_1 d_2) \\ &\geq [T_{B_1}^N(b_1) \vee T_{B_1}^N(b_2)] \vee [T_{B_2}^N(d_1) \vee T_{B_2}^N(d_2)] \\ &= [T_{B_1}^N(b_1) \vee T_{B_2}^N(d_1)] \vee [T_{B_1}^N(b_2) \vee T_{B_2}^N(d_2)] \\ &= T_{(B_1 * B_2)}^N(b_1 d_1) \vee T_{(B_1 * B_2)}^N(b_2 d_2) \end{aligned}$$

$$\begin{aligned} I_{(B_{1k} * B_{2k})}^P((b_1 d_1)(b_2 d_2)) &= I_{B_{1k}}^P(b_1 b_2) \wedge I_{B_{2k}}^P(d_1 d_2) \\ &\leq [I_{B_1}^P(b_1) \wedge I_{B_1}^P(b_2)] \wedge [I_{B_2}^P(d_1) \wedge I_{B_2}^P(d_2)] \\ &= [I_{B_1}^P(b_1) \wedge I_{B_2}^P(d_1)] \wedge [I_{B_1}^P(b_2) \wedge I_{B_2}^P(d_2)] \\ &= I_{(B_1 * B_2)}^P(b_1 d_1) \wedge I_{(B_1 * B_2)}^P(b_2 d_2) \end{aligned}$$

$$\begin{aligned} I_{(B_{1k} * B_{2k})}^N((b_1 d_1)(b_2 d_2)) &= I_{B_{1k}}^N(b_1 b_2) \vee I_{B_{2k}}^N(d_1 d_2) \\ &\geq [I_{B_1}^N(b_1) \vee I_{B_1}^N(b_2)] \vee [I_{B_2}^N(d_1) \vee I_{B_2}^N(d_2)] \\ &= [I_{B_1}^N(b_1) \vee I_{B_2}^N(d_1)] \vee [I_{B_1}^N(b_2) \vee I_{B_2}^N(d_2)] \\ &= I_{(B_1 * B_2)}^N(b_1 d_1) \vee I_{(B_1 * B_2)}^N(b_2 d_2) \end{aligned}$$

$$\begin{aligned}
 F_{(B_{1k} * B_{2k})}^P((b_1 d_1)(b_2 d_2)) &= F_{B_{1k}}^P(b_1 b_2) \vee F_{B_{2k}}^P(d_1 d_2) \\
 &\leq [F_{B_1}^P(b_1) \vee F_{B_1}^P(b_2)] \vee [F_{B_2}^P(d_1) \vee F_{B_2}^P(d_2)] \\
 &= [F_{B_1}^P(b_1) \vee F_{B_2}^P(d_1)] \vee [F_{B_1}^P(b_2) \vee F_{B_2}^P(d_2)] \\
 &= F_{(B_1 * B_2)}^P(b_1 d_1) \vee F_{(B_1 * B_2)}^P(b_2 d_2)
 \end{aligned}$$

$$\begin{aligned}
 F_{(B_{1k} * B_{2k})}^N((b_1 d_1)(b_2 d_2)) &= F_{B_{1k}}^N(b_1 b_2) \wedge F_{B_{2k}}^N(d_1 d_2) \\
 &\geq [F_{B_1}^N(b_1) \wedge F_{B_1}^N(b_2)] \wedge [F_{B_2}^N(d_1) \wedge F_{B_2}^N(d_2)] \\
 &= [F_{B_1}^N(b_1) \wedge F_{B_2}^N(d_1)] \wedge [F_{B_1}^N(b_2) \wedge F_{B_2}^N(d_2)] \\
 &= F_{(B_1 * B_2)}^N(b_1 d_1) \wedge F_{(B_1 * B_2)}^N(b_2 d_2)
 \end{aligned}$$

where $b_1 d_1, b_2 d_2 \in V_1 * V_2$ and $h \in \{1, 2, \dots, m\}$. \square

Definition 17. Let $\check{G}_{b_1} = (B_1, B_{11}, B_{12}, \dots, B_{1m})$ and $\check{G}_{b_2} = (B_2, B_{21}, B_{22}, \dots, B_{2m})$ be two BSVNGSs. The composition of \check{G}_{b_1} and \check{G}_{b_2} , denoted by

$$\check{G}_{b_1} \circ \check{G}_{b_2} = (B_1 \circ B_2, B_{11} \circ B_{21}, B_{12} \circ B_{22}, \dots, B_{1m} \circ B_{2m})$$

is defined as

- (i) $\begin{cases} T_{(B_1 \circ B_2)}^P(bd) = (T_{B_1}^P \circ T_{B_2}^P)(bd) = T_{B_1}^P(b) \wedge T_{B_2}^P(d) \\ I_{(B_1 \circ B_2)}^P(bd) = (I_{B_1}^P \circ I_{B_2}^P)(bd) = I_{B_1}^P(b) \wedge I_{B_2}^P(d) \\ F_{(B_1 \circ B_2)}^P(bd) = (F_{B_1}^P \circ F_{B_2}^P)(bd) = F_{B_1}^P(b) \vee F_{B_2}^P(d) \end{cases}$
- (ii) $\begin{cases} T_{(B_1 \circ B_2)}^N(bd) = (T_{B_1}^N \circ T_{B_2}^N)(bd) = T_{B_1}^N(b) \vee T_{B_2}^N(d) \\ I_{(B_1 \circ B_2)}^N(bd) = (I_{B_1}^N \circ I_{B_2}^N)(bd) = I_{B_1}^N(b) \vee I_{B_2}^N(d) \\ F_{(B_1 \circ B_2)}^N(bd) = (F_{B_1}^N \circ F_{B_2}^N)(bd) = F_{B_1}^N(b) \wedge F_{B_2}^N(d) \end{cases}$
for all $(bd) \in V_1 \times V_2$,
- (iii) $\begin{cases} T_{(B_{1k} \circ B_{2k})}^P(bd_1)(bd_2) = (T_{B_{1k}}^P \circ T_{B_{2k}}^P)(bd_1)(bd_2) = T_{B_{1k}}^P(b) \wedge T_{B_{2k}}^P(d_1 d_2) \\ I_{(B_{1k} \circ B_{2k})}^P(bd_1)(bd_2) = (I_{B_{1k}}^P \circ I_{B_{2k}}^P)(bd_1)(bd_2) = I_{B_{1k}}^P(b) \wedge I_{B_{2k}}^P(d_1 d_2) \\ F_{(B_{1k} \circ B_{2k})}^P(bd_1)(bd_2) = (F_{B_{1k}}^P \circ F_{B_{2k}}^P)(bd_1)(bd_2) = F_{B_{1k}}^P(b) \vee F_{B_{2k}}^P(d_1 d_2) \end{cases}$
- (iv) $\begin{cases} T_{(B_{1k} \circ B_{2k})}^N(bd_1)(bd_2) = (T_{B_{1k}}^N \circ T_{B_{2k}}^N)(bd_1)(bd_2) = T_{B_{1k}}^N(b) \vee T_{B_{2k}}^N(d_1 d_2) \\ I_{(B_{1k} \circ B_{2k})}^N(bd_1)(bd_2) = (I_{B_{1k}}^N \circ I_{B_{2k}}^N)(bd_1)(bd_2) = I_{B_{1k}}^N(b) \vee I_{B_{2k}}^N(d_1 d_2) \\ F_{(B_{1k} \circ B_{2k})}^N(bd_1)(bd_2) = (F_{B_{1k}}^N \circ F_{B_{2k}}^N)(bd_1)(bd_2) = F_{B_{1k}}^N(b) \wedge F_{B_{2k}}^N(d_1 d_2) \end{cases}$
for all $b \in V_1, (d_1 d_2) \in V_{2k}$,
- (v) $\begin{cases} T_{(B_{1k} \circ B_{2k})}^P(b_1 d)(b_2 d) = (T_{B_{1k}}^P \circ T_{B_{2k}}^P)(b_1 d)(b_2 d) = T_{B_2}^P(d) \wedge T_{B_{1k}}^P(b_1 b_2) \\ I_{(B_{1k} \circ B_{2k})}^P(b_1 d)(b_2 d) = (I_{B_{1k}}^P \circ I_{B_{2k}}^P)(b_1 d)(b_2 d) = I_{B_2}^P(d) \wedge I_{B_{1k}}^P(b_1 b_2) \\ F_{(B_{1k} \circ B_{2k})}^P(b_1 d)(b_2 d) = (F_{B_{1k}}^P \circ F_{B_{2k}}^P)(b_1 d)(b_2 d) = F_{B_2}^P(d) \vee F_{B_{1k}}^P(b_1 b_2) \end{cases}$
- (vi) $\begin{cases} T_{(B_{1k} \circ B_{2k})}^N(b_1 d)(b_2 d) = (T_{B_{1k}}^N \circ T_{B_{2k}}^N)(b_1 d)(b_2 d) = T_{B_2}^N(d) \vee T_{B_{1k}}^N(b_1 b_2) \\ I_{(B_{1k} \circ B_{2k})}^N(b_1 d)(b_2 d) = (I_{B_{1k}}^N \circ I_{B_{2k}}^N)(b_1 d)(b_2 d) = I_{B_2}^N(d) \vee I_{B_{1k}}^N(b_1 b_2) \\ F_{(B_{1k} \circ B_{2k})}^N(b_1 d)(b_2 d) = (F_{B_{1k}}^N \circ F_{B_{2k}}^N)(b_1 d)(b_2 d) = F_{B_2}^N(d) \wedge F_{B_{1k}}^N(b_1 b_2) \end{cases}$
for all $d \in V_2, (b_1 b_2) \in V_{1k}$, and
- (vii) $\begin{cases} T_{(B_{1k} \circ B_{2k})}^P(b_1 d_1)(b_2 d_2) = (T_{B_{1k}}^P \circ T_{B_{2k}}^P)(b_1 d_1)(b_2 d_2) = T_{B_{1k}}^P(b_1 b_2) \wedge T_{B_2}^P(d_1) \wedge T_{B_2}^P(d_2) \\ I_{(B_{1k} \circ B_{2k})}^P(b_1 d_1)(b_2 d_2) = (I_{B_{1k}}^P \circ I_{B_{2k}}^P)(b_1 d_1)(b_2 d_2) = I_{B_{1k}}^P(b_1 b_2) \wedge I_{B_2}^P(d_1) \wedge I_{B_2}^P(d_2) \\ F_{(B_{1k} \circ B_{2k})}^P(b_1 d_1)(b_2 d_2) = (F_{B_{1k}}^P \circ F_{B_{2k}}^P)(b_1 d_1)(b_2 d_2) = F_{B_{1k}}^P(b_1 b_2) \vee F_{B_2}^P(d_1) \vee F_{B_2}^P(d_2) \end{cases}$

$$(viii) \begin{cases} T_{(B_{1k} \circ B_{2k})}^N(b_1 d_1)(b_2 d_2) = (T_{B_{1k}}^N \circ T_{B_{2k}}^N)(b_1 d_1)(b_2 d_2) = T_{B_{1k}}^N(b_1 b_2) \vee T_{B_2}^N(d_1) \vee T_{B_2}^N(d_2) \\ I_{(B_{1k} \circ B_{2k})}^N(b_1 d_1)(b_2 d_2) = (I_{B_{1k}}^N \circ I_{B_{2k}}^N)(b_1 d_1)(b_2 d_2) = I_{B_{1k}}^N(b_1 b_2) \vee I_{B_2}^N(d_1) \vee I_{B_2}^N(d_2) \\ F_{(B_{1k} \circ B_{2k})}^N(b_1 d_1)(b_2 d_2) = (F_{B_{1k}}^N \circ F_{B_{2k}}^N)(b_1 d_1)(b_2 d_2) = F_{B_{1k}}^N(b_1 b_2) \wedge F_{B_2}^N(d_1) \wedge F_{B_2}^N(d_2) \end{cases}$$

for all $(b_1 b_2) \in V_{1k}, (d_1 d_2) \in V_{2k}$ such that $d_1 \neq d_2$.

Example 12. The composition of BSVNGSs \check{G}_{b1} and \check{G}_{b2} shown in Figure 10 is defined as $\check{G}_{b1} \circ \check{G}_{b2} = \{B_1 \circ B_2, B_{11} \circ B_{21}, B_{12} \circ B_{22}\}$ and is depicted in Figures 14 and 15.

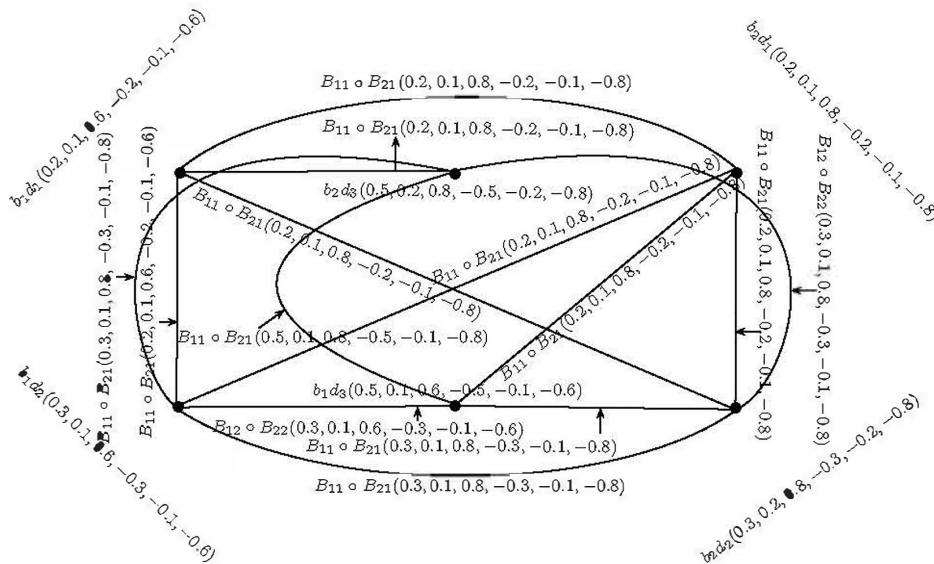

Figure 14. $\check{G}_{b1} \circ \check{G}_{b2}$.

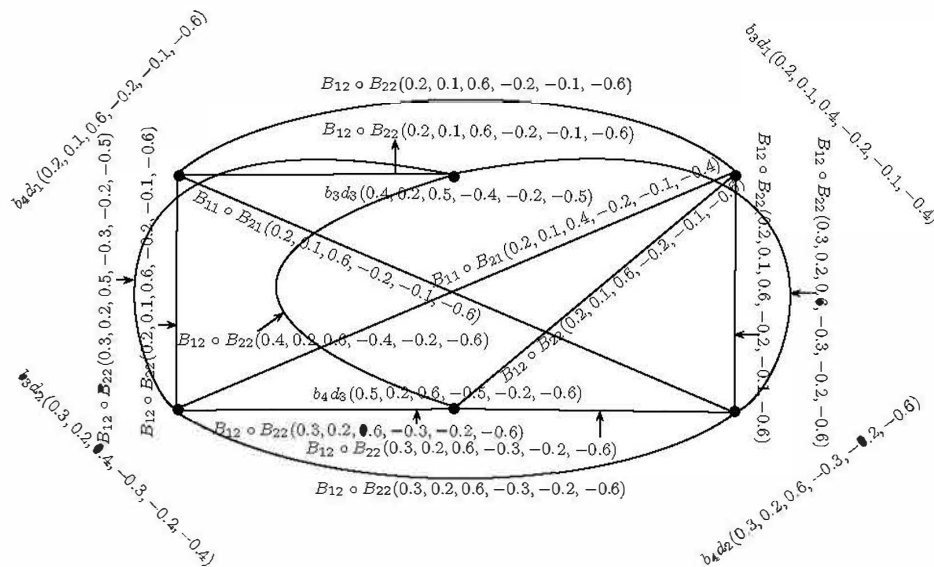

Figure 15. $\check{G}_{b1} \circ \check{G}_{b2}$.

Theorem 3. The composition $\check{G}_{b1} \circ \check{G}_{b2} = (B_1 \circ B_2, B_{11} \circ B_{21}, B_{12} \circ B_{22}, \dots, B_{1m} \circ B_{2m})$ of two BSVNGSs of GSs \check{G}_{s1} and \check{G}_{s2} is a BSVNGS of $\check{G}_{s1} \circ \check{G}_{s2}$.

Proof. Consider three cases:

Case 1. For $b \in V_1, d_1d_2 \in V_{2k}$,

$$\begin{aligned} T_{(B_{1k} \circ B_{2k})}^P((bd_1)(bd_2)) &= T_{B_1}^P(b) \wedge T_{B_{2k}}^P(d_1d_2) \\ &\leq T_{B_1}^P(b) \wedge [T_{B_2}^P(d_1) \wedge T_{B_2}^P(d_2)] \\ &= [T_{B_1}^P(b) \wedge T_{B_2}^P(d_1)] \wedge [T_{B_1}^P(b) \wedge T_{B_2}^P(d_2)] \\ &= T_{(B_1 \circ B_2)}^P(bd_1) \wedge T_{(B_1 \circ B_2)}^P(bd_2) \end{aligned}$$

$$\begin{aligned} T_{(B_{1k} \circ B_{2k})}^N((bd_1)(bd_2)) &= T_{B_1}^N(b) \vee T_{B_{2k}}^N(d_1d_2) \\ &\geq T_{B_1}^N(b) \vee [T_{B_2}^N(d_1) \vee T_{B_2}^N(d_2)] \\ &= [T_{B_1}^N(b) \vee T_{B_2}^N(d_1)] \vee [T_{B_1}^N(b) \vee T_{B_2}^N(d_2)] \\ &= T_{(B_1 \circ B_2)}^N(bd_1) \vee T_{(B_1 \circ B_2)}^N(bd_2) \end{aligned}$$

$$\begin{aligned} I_{(B_{1k} \circ B_{2k})}^P((bd_1)(bd_2)) &= I_{B_1}^P(b) \wedge I_{B_{2k}}^P(d_1d_2) \\ &\leq I_{B_1}^P(b) \wedge [I_{B_2}^P(d_1) \wedge I_{B_2}^P(d_2)] \\ &= [I_{B_1}^P(b) \wedge I_{B_2}^P(d_1)] \wedge [I_{B_1}^P(b) \wedge I_{B_2}^P(d_2)] \\ &= I_{(B_1 \circ B_2)}^P(bd_1) \wedge I_{(B_1 \circ B_2)}^P(bd_2) \end{aligned}$$

$$\begin{aligned} I_{(B_{1k} \circ B_{2k})}^N((bd_1)(bd_2)) &= I_{B_1}^N(b) \vee I_{B_{2k}}^N(d_1d_2) \\ &\geq I_{B_1}^N(b) \vee [I_{B_2}^N(d_1) \vee I_{B_2}^N(d_2)] \\ &= [I_{B_1}^N(b) \vee I_{B_2}^N(d_1)] \vee [I_{B_1}^N(b) \vee I_{B_2}^N(d_2)] \\ &= I_{(B_1 \circ B_2)}^N(bd_1) \vee I_{(B_1 \circ B_2)}^N(bd_2) \end{aligned}$$

$$\begin{aligned} F_{(B_{1k} \circ B_{2k})}^P((bd_1)(bd_2)) &= F_{B_1}^P(b) \vee F_{B_{2k}}^P(d_1d_2) \\ &\leq F_{B_1}^P(b) \vee [F_{B_2}^P(d_1) \vee F_{B_2}^P(d_2)] \\ &= [F_{B_1}^P(b) \vee F_{B_2}^P(d_1)] \vee [F_{B_1}^P(b) \vee F_{B_2}^P(d_2)] \\ &= F_{(B_1 \circ B_2)}^P(bd_1) \vee F_{(B_1 \circ B_2)}^P(bd_2) \end{aligned}$$

$$\begin{aligned} F_{(B_{1k} \circ B_{2k})}^N((bd_1)(bd_2)) &= F_{B_1}^N(b) \wedge F_{B_{2k}}^N(d_1d_2) \\ &\geq F_{B_1}^N(b) \wedge [F_{B_2}^N(d_1) \wedge F_{B_2}^N(d_2)] \\ &= [F_{B_1}^N(b) \wedge F_{B_2}^N(d_1)] \wedge [F_{B_1}^N(b) \wedge F_{B_2}^N(d_2)] \\ &= F_{(B_1 \circ B_2)}^N(bd_1) \wedge F_{(B_1 \circ B_2)}^N(bd_2) \end{aligned}$$

for $bd_1, bd_2 \in V_1 \circ V_2$.

Case 2. For $b \in V_2, d_1d_2 \in V_{1k}$,

$$\begin{aligned} T_{(B_{1k} \circ B_{2k})}^P((d_1b)(d_2b)) &= T_{B_2}^P(b) \wedge T_{B_{1k}}^P(d_1d_2) \\ &\leq T_{B_2}^P(b) \wedge [T_{B_1}^P(d_1) \wedge T_{B_1}^P(d_2)] \\ &= [T_{B_2}^P(b) \wedge T_{B_1}^P(d_1)] \wedge [T_{B_2}^P(b) \wedge T_{B_1}^P(d_2)] \\ &= T_{(B_1 \circ B_2)}^P(d_1b) \wedge T_{(B_1 \circ B_2)}^P(d_2b) \end{aligned}$$

$$\begin{aligned}
 T_{(B_{1k} \circ B_{2k})}^N((d_1b)(d_2b)) &= T_{B_2}^N(b) \vee T_{B_{1k}}^N(d_1d_2) \\
 &\geq T_{B_2}^N(b) \vee [T_{B_1}^N(d_1) \vee T_{B_1}^N(d_2)] \\
 &= [T_{B_2}^N(b) \vee T_{B_1}^N(d_1)] \vee [T_{B_2}^N(b) \vee T_{B_1}^N(d_2)] \\
 &= T_{(B_1 \circ B_2)}^N(d_1b) \vee T_{(B_1 \circ B_2)}^N(d_2b)
 \end{aligned}$$

$$\begin{aligned}
 I_{(B_{1k} \circ B_{2k})}^P((d_1b)(d_2b)) &= I_{B_2}^P(b) \wedge I_{B_{1k}}^P(d_1d_2) \\
 &\leq I_{B_2}^P(b) \wedge [I_{B_1}^P(d_1) \wedge I_{B_1}^P(d_2)] \\
 &= [I_{B_2}^P(b) \wedge I_{B_1}^P(d_1)] \wedge [I_{B_2}^P(b) \wedge I_{B_1}^P(d_2)] \\
 &= I_{(B_1 \circ B_2)}^P(d_1b) \wedge I_{(B_1 \circ B_2)}^P(d_2b)
 \end{aligned}$$

$$\begin{aligned}
 I_{(B_{1k} \circ B_{2k})}^N((d_1b)(d_2b)) &= I_{B_2}^N(b) \vee I_{B_{1k}}^N(d_1d_2) \\
 &\geq I_{B_2}^N(b) \vee [I_{B_1}^N(d_1) \vee I_{B_1}^N(d_2)] \\
 &= [I_{B_2}^N(b) \vee I_{B_1}^N(d_1)] \vee [I_{B_2}^N(b) \vee I_{B_1}^N(d_2)] \\
 &= I_{(B_1 \circ B_2)}^N(d_1b) \vee I_{(B_1 \circ B_2)}^N(d_2b)
 \end{aligned}$$

$$\begin{aligned}
 F_{(B_{1k} \circ B_{2k})}^P((d_1b)(d_2b)) &= F_{B_2}^P(b) \vee F_{B_{1k}}^P(d_1d_2) \\
 &\leq F_{B_2}^P(b) \vee [F_{B_1}^P(d_1) \vee F_{B_1}^P(d_2)] \\
 &= [F_{B_2}^P(b) \vee F_{B_1}^P(d_1)] \vee [F_{B_2}^P(b) \vee F_{B_1}^P(d_2)] \\
 &= F_{(B_1 \circ B_2)}^P(d_1b) \vee F_{(B_1 \circ B_2)}^P(d_2b)
 \end{aligned}$$

$$\begin{aligned}
 F_{(B_{1k} \circ B_{2k})}^N((d_1b)(d_2b)) &= F_{B_2}^N(b) \wedge F_{B_{1k}}^N(d_1d_2) \\
 &\geq F_{B_2}^N(b) \wedge [F_{B_1}^N(d_1) \wedge F_{B_1}^N(d_2)] \\
 &= [F_{B_2}^N(b) \wedge F_{B_1}^N(d_1)] \wedge [F_{B_2}^N(b) \wedge F_{B_1}^N(d_2)] \\
 &= F_{(B_1 \circ B_2)}^N(d_1b) \wedge F_{(B_1 \circ B_2)}^N(d_2b)
 \end{aligned}$$

for $d_1b, d_2b \in V_1 \circ V_2$.

Case 3. For $(b_1b_2) \in V_{1k}, (d_1d_2) \in V_{2k}$ such that $d_1 \neq d_2$,

$$\begin{aligned}
 T_{(B_{1k} \circ B_{2k})}^P((b_1d_1)(b_2d_2)) &= T_{B_{1k}}^P(b_1b_2) \wedge T_{B_2}^P(d_1) \wedge T_{B_2}^P(d_2) \\
 &\leq [T_{B_1}^P(b_1) \wedge T_{B_1}^P(b_2)] \wedge [T_{B_2}^P(d_1) \wedge T_{B_2}^P(d_2)] \\
 &= [T_{B_1}^P(b_1) \wedge T_{B_2}^P(d_1)] \wedge [T_{B_1}^P(b_2) \wedge T_{B_2}^P(d_2)] \\
 &= T_{(B_1 \circ B_2)}^P(b_1d_1) \wedge T_{(B_1 \circ B_2)}^P(b_2d_2)
 \end{aligned}$$

$$\begin{aligned}
 T_{(B_{1k} \circ B_{2k})}^N((b_1d_1)(b_2d_2)) &= T_{B_{1k}}^N(b_1b_2) \vee T_{B_2}^N(d_1) \vee T_{B_2}^N(d_2) \\
 &\geq [T_{B_1}^N(b_1) \vee T_{B_1}^N(b_2)] \vee [T_{B_2}^N(d_1) \vee T_{B_2}^N(d_2)] \\
 &= [T_{B_1}^N(b_1) \vee T_{B_2}^N(d_1)] \vee [T_{B_1}^N(b_2) \vee T_{B_2}^N(d_2)] \\
 &= T_{(B_1 \circ B_2)}^N(b_1d_1) \vee T_{(B_1 \circ B_2)}^N(b_2d_2)
 \end{aligned}$$

$$\begin{aligned}
 I_{(B_{1k} \circ B_{2k})}^P((b_1 d_1)(b_2 d_2)) &= I_{B_{1k}}^P(b_1 b_2) \wedge I_{B_2}^P(d_1) \wedge I_{B_2}^P(d_2) \\
 &\leq [I_{B_1}^P(b_1) \wedge I_{B_1}^P(b_2)] \wedge [I_{B_2}^P(d_1) \wedge I_{B_2}^P(d_2)] \\
 &= [I_{B_1}^P(b_1) \wedge I_{B_2}^P(d_1)] \wedge [I_{B_1}^P(b_2) \wedge I_{B_2}^P(d_2)] \\
 &= I_{(B_1 \circ B_2)}^P(b_1 d_1) \wedge I_{(B_1 \circ B_2)}^P(b_2 d_2)
 \end{aligned}$$

$$\begin{aligned}
 I_{(B_{1k} \circ B_{2k})}^N((b_1 d_1)(b_2 d_2)) &= I_{B_{1k}}^N(b_1 b_2) \vee I_{B_2}^N(d_1) \vee I_{B_2}^N(d_2) \\
 &\geq [I_{B_1}^N(b_1) \vee I_{B_1}^N(b_2)] \vee [I_{B_2}^N(d_1) \vee I_{B_2}^N(d_2)] \\
 &= [I_{B_1}^N(b_1) \vee I_{B_2}^N(d_1)] \vee [I_{B_1}^N(b_2) \vee I_{B_2}^N(d_2)] \\
 &= I_{(B_1 \circ B_2)}^N(b_1 d_1) \vee I_{(B_1 \circ B_2)}^N(b_2 d_2)
 \end{aligned}$$

$$\begin{aligned}
 F_{(B_{1k} \circ B_{2k})}^P((b_1 d_1)(b_2 d_2)) &= F_{B_{1k}}^P(b_1 b_2) \vee F_{B_2}^P(d_1) \vee F_{B_2}^P(d_2) \\
 &\leq [F_{B_1}^P(b_1) \vee F_{B_1}^P(b_2)] \vee [F_{B_2}^P(d_1) \vee F_{B_2}^P(d_2)] \\
 &= [F_{B_1}^P(b_1) \vee F_{B_2}^P(d_1)] \vee [F_{B_1}^P(b_2) \vee F_{B_2}^P(d_2)] \\
 &= F_{(B_1 \circ B_2)}^P(b_1 d_1) \vee F_{(B_1 \circ B_2)}^P(b_2 d_2)
 \end{aligned}$$

$$\begin{aligned}
 F_{(B_{1k} \circ B_{2k})}^N((b_1 d_1)(b_2 d_2)) &= F_{B_{1k}}^N(b_1 b_2) \wedge F_{B_2}^N(d_1) \wedge F_{B_2}^N(d_2) \\
 &\geq [F_{B_1}^N(b_1) \wedge F_{B_1}^N(b_2)] \wedge [F_{B_2}^N(d_1) \wedge F_{B_2}^N(d_2)] \\
 &= [F_{B_1}^N(b_1) \wedge F_{B_2}^N(d_1)] \wedge [F_{B_1}^N(b_2) \wedge F_{B_2}^N(d_2)] \\
 &= F_{(B_1 \circ B_2)}^N(b_1 d_1) \wedge F_{(B_1 \circ B_2)}^N(b_2 d_2)
 \end{aligned}$$

where $b_1 d_1, b_2 d_2 \in V_1 \circ V_2$.

All cases are satisfied for all $k \in \{1, 2, \dots, m\}$. \square

3. Conclusions

The notion of bipolar fuzzy graphs is applicable in several domains of engineering, expert systems, pattern recognition, signal processing, neural networks, medical diagnosis and decision-making. BSVNGSs show more flexibility, compatibility and precision for a system than single-valued neutrosophic graph structures. In this research paper, we introduced certain concepts of BSVNGSs and elaborated on them with suitable examples. Further, we defined some operations on BSVNGSs and investigated some relevant properties of these operations. We intend to generalize our research of fuzzification to (1) concepts of BSVN soft graph structures, (2) concepts of BSVN rough fuzzy graph structures, (3) concepts of BSVN fuzzy soft graph structures, and (4) concepts of BSVN rough fuzzy soft graph structures.

References

1. Zadeh, L.A. Fuzzy sets. *Inf. Control* **1965**, *8*, 338–353.
2. Atanassov, K. Intuitionistic fuzzy sets. *Fuzzy Sets Syst.* **1986**, *20*, 87–96.

3. Zhang, W.-R. Bipolar fuzzy sets and relations: A computational framework for cognitive modeling and multiagent decision analysis. In Proceedings of the Industrial Fuzzy Control and Intelligent Systems Conference, and the NASA Joint Technology Workshop on Neural Networks and Fuzzy Logic Fuzzy Information Processing Society Biannual Conference, San Antonio, TX, USA, 18–21 December 1994; pp. 305–309.
4. Smarandache, F. *Neutrosophy Neutrosophic Probability, Set, and Logic*; Amer Res Press: Rehoboth, MA, USA, 1998.
5. Wang, H.; Smarandache, F.; Zhang, Y.Q.; Sunderraman, R. Single valued neutrosophic sets. *Multispace Multistruct.* **2010**, *4*, 410–413.
6. Deli, I.; Ali, M.; Smarandache, F. Bipolar neutrosophic sets and their application based on multi-criteria decision making problems. In Proceedings of the International Conference IEEE Advanced Mechatronic Systems (ICAMechS), Beijing, China, 22–24 August 2015; pp. 249–254.
7. Zadeh, L.A. Similarity relations and fuzzy orderings. *Inf. Sci.* **1971**, *3*, 177–200.
8. Kauffman, A. *Introduction to the Theory of Fuzzy Subsets*; Academic Press: Cambridge, MA, USA, 1973; Volume 1.
9. Rosenfeld, A. Fuzzy graphs. In *Fuzzy Sets and Their Applications*; Zadeh, L.A., Fu, K.S., Eds.; Academic Press: New York, NY, USA, 1975; pp. 77–95.
10. Bhattacharya, P. Some remarks on fuzzy graphs. *Pattern Recognit. Lett.* **1987**, *6*, 297–302.
11. Akram, M. Bipolar fuzzy graphs. *Inf. Sci.* **2011**, *181*, 5548–5564.
12. Dinesh, T.; Ramakrishnan, T.V. On generalised fuzzy graph structures. *Appl. Math. Sci.* **2011**, *5*, 173–180.
13. Akram, M.; Akmal, R. Application of bipolar fuzzy sets in graph structures. *Appl. Comput. Intell. Soft Comput.* **2016**, *2016*, doi:10.1155/2016/5859080.
14. Akram, M.; Akmal, R. Certain operations on bipolar fuzzy graph structures. *Appl. Appl. Math.* **2016**, *11*, 463–488.
15. Akram, M.; Shahzadi, S. Representation of graphs using intuitionistic neutrosophic soft sets. *J. Math. Anal.* **2016**, *7*, 31–53.
16. Akram, M.; Shahzadi, G. Operations on single-valued neutrosophic graphs. *J. Uncertain Syst.* **2017**, *11*, 176–196.
17. Broumi, S.; Smarandache, F.; Talea, M.; Bakali, A. An introduction to bipolar single valued neutrosophic graph theory. *Appl. Mech. Mater.* **2016**, *841*, 184–191.
18. Dhavaseelan, R.; Vikramaprasad, R.; Krishnaraj, V. Certain types of neutrosophic graphs. *Int. J. Math. Sci. Appl.* **2015**, *5*, 333–339.
19. Dinesh, T. A study on graph structures Incidence Algebras and Their Fuzzy Analogues. Ph.D. Thesis, Kannur University, Kannur, India, 2011.
20. Ye, J. Single-valued neutrosophic minimum spanning tree and its clustering method. *J. Intell. Syst.* **2014**, *23*, 311–324.
21. Ye, J. Improved correlation coefficients of single-valued neutrosophic sets and interval neutrosophic sets for multiple attribute decision making. *J. Intell. Fuzzy Syst.* **2014**, *27*, 2453–2462.
22. Ye, J. A multicriteria decision-making method using aggregation operators for simplified neutrosophic sets. *J. Intell. Fuzzy Syst.* **2014**, *26*, 2459–2466.
23. Akram, M.; Sarwar, M. Novel multiple criteria decision making methods based on bipolar neutrosophic sets and bipolar neutrosophic graphs. *Ital. J. Pure Appl. Math.* **2017**, *38*, 368–389.
24. Majumdar, P.; Samanta, S.K. On similarity and entropy of neutrosophic sets. *J. Intell. Fuzzy Syst.* **2014**, *26*, 1245–1252.
25. Mordeson, J.N.; Chang-Shyh, P. Operations on fuzzy graphs. *Inf. Sci.* **1994**, *79*, 159–170.
26. Mordeson, J.N.; Nair, P.S. *Fuzzy Graphs and Fuzzy Hypergraphs*; Physica Verlag: Heidelberg, Germany, 1998; Second Edition 2001.
27. Parvathi, R.; Karunambigai, M.G.; Atanassov, K.T. Operations on intuitionistic fuzzy graphs. In Proceedings of the IEEE International Conference on Fuzzy Systems, Jeju Island, Korea, 20–24 August 2009; pp. 1396–1401.
28. Peng, J.J.; Wang, J.Q.; Zhang, H.Y.; Chen, X.H. An outranking approach for multi-criteria decision-making problems with simplified neutrosophic sets. *Appl. Soft Comput.* **2014**, *25*, 336–346.
29. Sampathkumar, E. Generalized graph structures. *Bull. Kerala Math. Assoc.* **2006**, *3*, 65–123.
30. Akram, M.; Sitara, M. Bipolar neutrosophic graph structures. *J. Indones. Math. Soc.* **2017**, *23*, 55–76.

An Efficient Image Segmentation Algorithm Using Neutrosophic Graph Cut

Yanhui Guo, Yaman Akbulut, Abdulkadir Şengür, Rong Xia Florentin Smarandache

Yanhui Guo, Yaman Akbulut, Abdulkadir Şengür, Rong Xia, Florentin Smarandache (2017). An Efficient Image Segmentation Algorithm Using Neutrosophic Graph Cut. *Symmetry* 9, 185; DOI: 10.3390/sym9090185

Abstract: Segmentation is considered as an important step in image processing and computer vision applications, which divides an input image into various non-overlapping homogenous regions and helps to interpret the image more conveniently. This paper presents an efficient image segmentation algorithm using neutrosophic graph cut (NGC). An image is presented in neutrosophic set, and an indeterminacy filter is constructed using the indeterminacy value of the input image, which is defined by combining the spatial information and intensity information. The indeterminacy filter reduces the indeterminacy of the spatial and intensity information. A graph is defined on the image and the weight for each pixel is represented using the value after indeterminacy filtering. The segmentation results are obtained using a maximum-flow algorithm on the graph. Numerous experiments have been taken to test its performance, and it is compared with a neutrosophic similarity clustering (NSC) segmentation algorithm and a graph-cut-based algorithm. The results indicate that the proposed NGC approach obtains better performances, both quantitatively and qualitatively.

Keywords: image segmentation; neutrosophic set; graph cut; indeterminate filtering

1. Introduction

With a classical definition, image segmentation refers to dividing an input image into several sub-images according to a pre-defined criterion where the sub-images are disjointed, homogenous and meaningful. Image segmentation is also known as an important and crucial step in many computer vision and pattern-recognition applications. Many researchers have been working on image segmentation, and works have been done [1].

Among the published works, graph-based segmentation algorithms constitute an important image segmentation category [2]. A graph G can be denoted as $G = (V, E)$ where V and E are a set of vertices and edges. On an image, vertices can be either pixels or regions, and edges connect the neighboring vertices [3]. A weight is a non-negative measure of dissimilarity which is associated with each edge using some property of the pixels.

In this paper, using the advantages of neutrosophic to interpret the indeterminacy on the image, we combine neutrosophic set into the graph cut for image segmentation. Neutrosophic set (NS) was an extension of the fuzzy set [4]. In NS theory, a member of a set has degrees to the truth, falsity, and indeterminacy, respectively [5]. Therefore, it has an ability to deal with the indeterminacy information and has attracted much attention in almost all engineering communities and subsequently a great number of works have been studied, such as NS-based color and texture segmentation [6–14], NS-based

clustering [15–17], NS-based similarity for image thresholding [18], NS-based edge detection [19] and NS-based level set [20].

Firstly, the image is interpreted using neutrosophic set and indeterminacy degree is calculated accordingly. Then an indeterminacy filter is constructed using the indeterminacy value on the image which is defined by combining the spatial and intensity information. The indeterminacy filter reduces the indeterminacy in the intensity and spatial information respectively. A graph is defined on the image and the weight for each pixel is represented using the value after indeterminacy filtering, and the energy function is also redefined using the neutrosophic value. A maximum-flow algorithm on the graph is employed to obtain the final segmentation results.

The proposed method has the following new contributions: (1) an indeterminate filter is proposed to reduce the uncertain information in the image; and (2) a new energy function in graph model is defined in neutrosophic domain and used to segment the image with better performance.

The rest of the paper is structured: Section 2 briefly reviews the previous works. Section 3 describes the proposed method based on neutrosophic graph cut. Section 4 provides the experimental results. Conclusions are drawn in Section 5.

2. Previous Works

As mentioned in the Introduction Section, graph based image segmentation has gained much attention from the domain researchers with many published papers. A systematic survey work on graph-based image segmentation was conducted by Peng et al. [21]. In this survey, authors categorized the graph-based image segmentation methods into five groups. The first category is minimal spanning tree (MST)-based method. The MST is a popular concept in graph theory with numerous works. In [22], a hierarchical image segmentation method was proposed based on MST [22]. This method segmented the input image iteratively. At each iteration, one sub-graph was produced and, in the final segmentation, there were a given number of sub-graphs. In [23], a region merging procedure was adopted to produce a MST-based image segmentation algorithm using the differences between two sub graphs and inside graphs.

Cost-function-based graph cut methods constitute the second category. The most popular graph-based segmentation methods are in this category. Wu et al. [3] applied the graph theory to image segmentation and proposed the popular minimal cut method to minimize a cost function. A graph-based image segmentation approach namely normalized cut (Ncut) was presented [24]. It alleviates shortcomings of the minimal cut method by introducing an eigen system. Wang et al. [25] presented a graph-based method and a cost function and defined it as the ratio of the sum of different weights of edges along the cut boundary. Ding et al. [26] presented a cost function to alleviate the weakness of the minimal cut method, in which the similarity between two subgraphs was minimized, and the similarity within each subgraph was maximized. Another efficient graph-based image segmentation method was proposed in [27], and considered both the interior and boundary information. It minimized the ratio between the exterior boundary and interior region. The Mean-Cut incorporates the edge weight function [25] to minimize the mean edge weight on the cut boundary.

Methods based on Markov random fields (MRF) are in the third class, and the shortest-path-based methods are classified in the fourth class. Generally, MRF-based graph cut methods form a graph structure with a cost function and try to minimize that cost function to solve the segmentation problem. The shortest path based methods searched the shortest path between two vertices [21], and the boundaries of segments were achieved by employing the shortest path. The shortest-path-based segmentation methods need interaction from users.

The other graph-based methods are categorized into the fifth class. The random walker (RW) method by Grady [28] used a weighted graph to obtain labels of pixels and then these weights were considered as the likelihood that RW went across the edge. Finally, a pixel label was assigned by the seed point where the RW reached first.

3. Proposed Method

3.1. Neutrosophic Image

An element in NS is defined as: let $A = \{A_1, A_2, \dots, A_m\}$ as a set of alternatives in neutrosophic set. The alternative A_i is $\{T(A_i), I(A_i), F(A_i)\} / A_i$, where $T(A_i)$, $I(A_i)$ and $F(A_i)$ are the membership values to the true, indeterminate and false set.

An image I_m in NS is called neutrosophic image, denoted as I_{NS} which is interpreted using Ts , Is and Fs . Given a pixel $P(x,y)$ in I_{NS} , it is interpreted as $P_{NS}(x,y) = \{Ts(x,y), Is(x,y), Fs(x,y)\}$. $Ts(x,y)$, $Is(x,y)$ and $Fs(x,y)$ represent the memberships belonging to foreground, indeterminate set and background, respectively.

Based on the intensity value and local spatial information, the true and indeterminacy memberships are used to describe the indeterminacy among local neighborhood as:

$$Ts(x,y) = \frac{g(x,y) - g_{\min}}{g_{\max} - g_{\min}} \tag{1}$$

$$Is(x,y) = \frac{Gd(x,y) - Gd_{\min}}{Gd_{\max} - Gd_{\min}} \tag{2}$$

where $g(x,y)$ and $Gd(x,y)$ are the intensity and gradient magnitude at the pixel of (x,y) on the image.

We also compute the neutrosophic membership values based on the global intensity distribution which considers the indeterminacy on intensity between different groups. The neutrosophic c-means clustering (NCM) overcomes the disadvantages on handling indeterminate points in other algorithms [16]. Here, we use NCM to obtain the indeterminacy values between different groups on intensity to be segmented.

Using NCM, the truth and indeterminacy memberships are defined as:

$$K = \left[\frac{1}{\omega_1} \sum_{j=1}^C (x_i - c_j)^{-\frac{2}{m-1}} + \frac{1}{\omega_2} (x_i - \bar{c}_{\max})^{-\frac{2}{m-1}} + \frac{1}{\omega_3} \delta^{-\frac{2}{m-1}} \right]^{-1} \tag{3}$$

$$Tn_{ij} = \frac{K}{\omega_1} (x_i - c_j)^{-\frac{2}{m-1}} \tag{4}$$

$$In_i = \frac{K}{\omega_2} (x_i - \bar{c}_{\max})^{-\frac{2}{m-1}} \tag{5}$$

where Tn_{ij} and In_i are the true and indeterminacy membership value of point i , and the cluster centers is c_j . \bar{c}_{\max} is obtained using to indexes of the largest and second largest value of T_{ij} . They are updated at each iteration until $|T_{n_{ij}}^{(k+1)} - T_{n_{ij}}^{(k)}| < \epsilon$, where ϵ is a termination criterion.

3.2. Indeterminacy Filtering

A filter is newly defined based on the indeterminacy and used to remove the effect of indeterminacy information for segmentation, in which the kernel function is defined using a Gaussian function as follows:

$$G_I(u,v) = \frac{1}{2\pi\sigma_I^2} \exp\left(-\frac{u^2 + v^2}{2\sigma_I^2}\right) \tag{6}$$

$$\sigma_I(x,y) = f(I(x,y)) = aI(x,y) + b \tag{7}$$

where σ_I is the standard deviation value where is defined as a function $f(\cdot)$ associated to the indeterminacy degree. When the indeterminacy level is high, σ_I is large and the filtering can make the current local neighborhood more smooth. When the indeterminacy level is low, σ_I is

small and the filtering takes a less smooth operation on the local neighborhood. The reason to use Gaussian function is that it can map the indeterminate degree to a filter weight more smooth.

An indeterminate filtering is taken on $T_s(x, y)$, and it becomes more homogeneous.

$$T'_s(x, y) = T_s(x, y) \oplus G_{I_s}(u, v) = \sum_{v=y-m/2}^{y+m/2} \sum_{u=x-m/2}^{x+m/2} T_s(x-u, y-v) G_{I_s}(u, v) \tag{8}$$

$$G_{I_s}(u, v) = \frac{1}{2\pi\sigma_{I_s}^2} \exp\left(-\frac{u^2 + v^2}{2\sigma_{I_s}^2}\right) \tag{9}$$

$$\sigma_{I_s}(x, y) = f(I_s(x, y)) = aI_s(x, y) + b \tag{10}$$

where T'_s is the indeterminate filtering result. a and b are the parameters in the linear function to transform the indeterminacy level to parameter value.

The filtering is also used on $T_{n_{ij}}(x, y)$ after NCM. The input of NCM is the local spatial neutrosophic value after indeterminacy filtering.

$$Tn'_{ij}(x, y) = Tn_{ij}(x, y) \oplus G_{I_n}(u, v) = \sum_{v=y-m/2}^{y+m/2} \sum_{u=x-m/2}^{x+m/2} Tn_{ij}(x-u, y-v) G_{I_n}(u, v) \tag{11}$$

$$G_{I_n}(u, v) = \frac{1}{2\pi\sigma_{I_n}^2} \exp\left(-\frac{u^2 + v^2}{2\sigma_{I_n}^2}\right) \tag{12}$$

$$\sigma_{I_n}(x, y) = f(I_n(x, y)) = cI_n(x, y) + d \tag{13}$$

where Tn'_{ij} is the indeterminate filtering result on T_s and m is the size of the filter kernel. Tn'_{ij} is employed to construct a graph, and a maximum-flow algorithm is used to segment the image.

3.3. Neutrosophic Graph Cut

A cut $C = (S, T)$ partitions a graph $G = (V, E)$ into two subsets: S and T . The cut set of a cut $C = (S, T)$ is the set $\{(u, v) \in E | u \in S, v \in T\}$ of edges that have one endpoint in S and the other endpoint in T . Graph cuts can efficiently solve image segmentation problems by formulating in terms of energy minimization, which is transformed into the maximum flow problem in a graph or a minimal cut of the graph.

The energy function often includes two components: data constrict E_{data} and smooth constrict E_{smooth} as:

$$E(f) = E_{data}(f) + E_{smooth}(f) \tag{14}$$

where f is a map which assigns pixels to different groups. E_{data} measures the disagreement between f and the assigned region, which can be represented as a t-link, while E_{smooth} evaluates the extent of how f is piecewise smooth and can be represented as an n-link in a graph.

Different models have different forms in the implementation of the energy function. The function based on Potts model is defined as:

$$E(f) = \sum_{p \in P} D_p(f_p) + \sum_{\{p, q\} \in N} V_{\{p, q\}}(f_p, f_q) \tag{15}$$

where p and q are pixels, and N is the neighborhood of p . D_p evaluates how appropriate a segmentation is for the pixel p .

In the proposed neutrosophic graph cut (NGC) algorithm, the data function D_p and smooth function $V_{\{p, q\}}$ are defined as:

$$D_{ij}(p) = |Tn'_{ij}(p) - C_j| \tag{16}$$

$$V_{\{p,q\}}(f_p, f_q) = u\delta(f_p \neq f_q) \tag{17}$$

$$\delta(f_p \neq f_q) = \begin{cases} 1 & \text{if } f_p \neq f_q \\ 0 & \text{otherwise} \end{cases} \tag{18}$$

where u is a constant number in $[0, 1]$ and used for a penalty of the disagree of labeling of pixel p and q .

After the energy function is redefined in the neutrosophic set domain, a maximum flow algorithm in graph cut theory is used to segment the objects from the background.

All steps can be summarized as:

- Step 1: Compute the local neutrosophic value T_s and I_s .
- Step 2: Take indeterminate filtering on T_s using I_s .
- Step 3: Use NCM algorithm on the filtered T_s subset to obtain T_n and I_n .
- Step 4: Filter T_n using indeterminate filter based on I_n .
- Step 5: Define the energy function based on the T_n' value.
- Step 6: Partition the image using the maximum flow algorithm.

The flowchart of the proposed approach is shown in Figure 1 as:

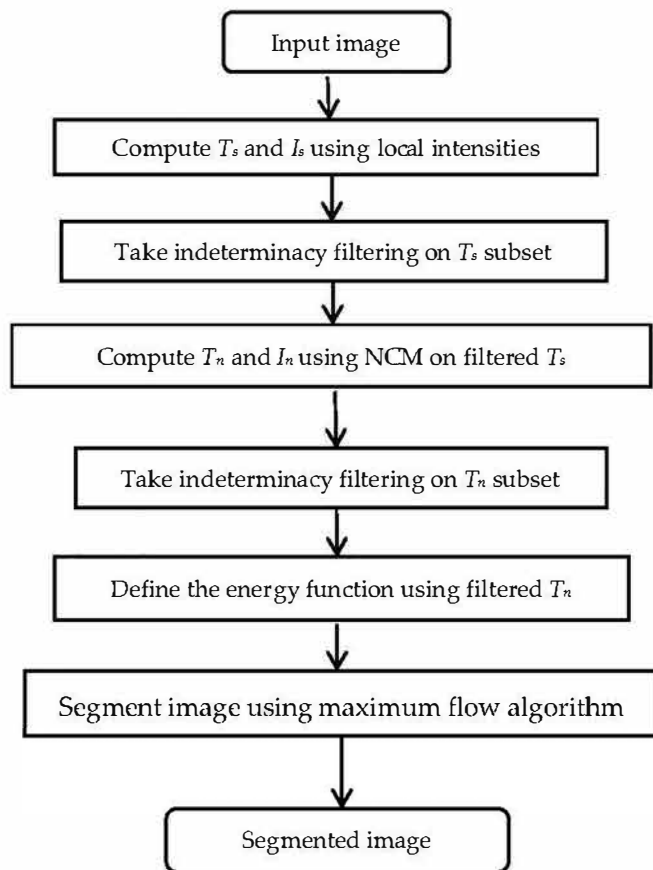

Figure 1. The flowchart of the proposed method.

To show the steps of the whole algorithm, some intermediate results are demonstrated using an example image in Figure 2.

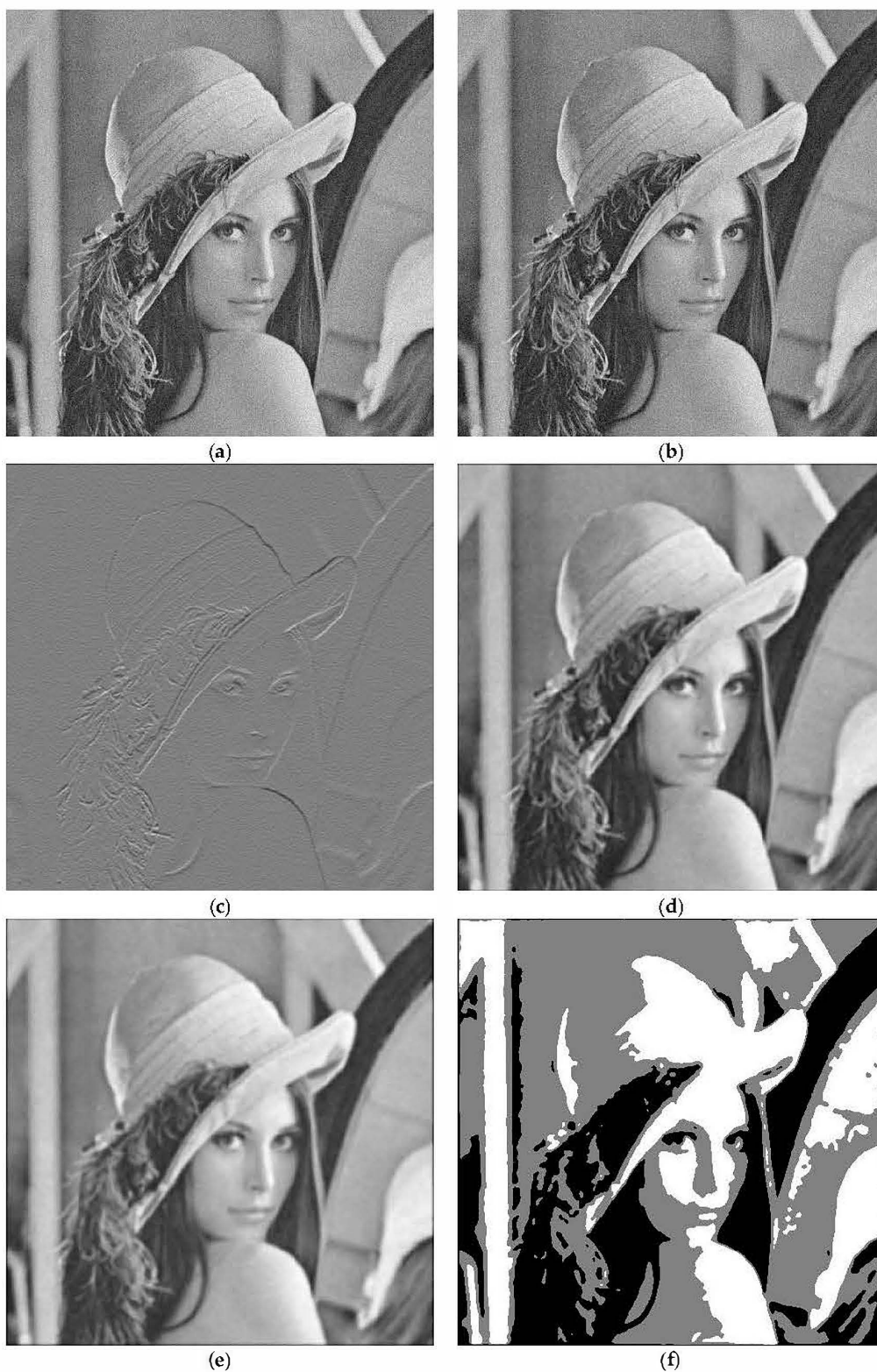

Figure 2. Intermediate results for "Lena" image: (a) Original image; (b) Result of Ts; (c) Result of Is; (d) Filtered result of Ts; (e) Filter result of Tn; (f) Final result.

4. Experimental Results

It is challenging to segment images having uncertain information such as noise. Different algorithms have been developed to solve this problem. To validate the performance of the NGC

approach on image segmentation, we test it on many images and compare its performance with a newly published neutrosophic similarity clustering (NSC) method [12] which performed better than previous methods [6], and a newly developed graph cut (GC) method [29].

All experiments are taken using the same parameters: $a = 10$; $b = 0.25$; $c = 10$; $d = 0.25$; and $u = 0.5$.

4.1. Quantitatively Evaluation

Simulated noisy images are employed to compare the NGC with NSC and GC methods visually, and then their performances are tested quantitatively by using two metrics. In the NSC method [12], simulated noisy images were employed to evaluate its performance. To make the comparison fair and consistent, we use the same images and noise and test three algorithms on them.

A simulated image having intensities of 64, 128, and 192 is added with Gaussian noises and used to evaluate the performance of NGC, NSC, and GC algorithms. Figure 3a shows the original noisy images with noise mean values are 0 and variance values: 80, 100, and 120, respectively. Figure 3b–d lists results by the NSC, GC, and NGC methods, respectively. The results in Figure 3 also show the NGC performs visually better than NSC and GC methods on the simulated images with low contrast and noises. Pixels in Figure 3b,c that are segmented into wrong groups are assigned into the right groups by NGC method in Figure 3d. Boundary pixels, which are challenging to label, are also segmented into right categories by NGC.

Misclassification error (ME) is used to evaluate the segmentation performances [30–32]. The ME measures the percentage of background wrongly categorized into foreground, and vice versa.

$$ME = 1 - \frac{|B_o \cap B_T| + |F_o \cap F_T|}{|B_o| + |F_o|} \tag{19}$$

where F_o , B_o , F_T , and B_T are the object and background pixels on the ground truth image and the resulting image, respectively.

In addition, FOM [31] is used to evaluate the difference between the segmented results with the ground truth:

$$FOM = \frac{1}{\max(N_I, N_A)} \sum_{k=1}^{N_A} \frac{1}{1 + \beta d^2(k)} \tag{20}$$

where N_I and N_A are the numbers of the segment object and the true object pixels. $d(k)$ is the distance from the k_{th} actual pixel to the nearest segmented result pixel. β is a constant and set as $1/9$ in [31].

The quality of the noisy image is measured via a signal to noise ratio (SNR):

$$SNR = 10 \log \left[\frac{\sum_{r=1}^{H-1} \sum_{c=1}^{W-1} I^2(r, c)}{\sum_{r=1}^{H-1} \sum_{c=1}^{W-1} (I(r, c) - I_n(r, c))^2} \right] \tag{21}$$

where $I_n(r,c)$ and $I(r,c)$ are the intensities of point (r,c) in the noisy and original images, respectively.

The results of ME and FOM are drawn in Figures 4 and 5, where * denotes NSC method, o denotes GC method, and + is NGC method. NGC method has the lowest ME values. All ME by NGC are smaller than 0.043, and all values from NSC and GC methods are larger than those from NGC method. The NGC obtains the best performance with $ME = 0.0068$ when SNR is 5.89 dB, while NSC has the lowest value $ME = 0.1614$ and GC $ME = 0.0327$. NGC also has bigger FOM than NSC and GC, especially at the low SNR. The comparison results are listed in Table 1. The mean and standard deviation of the ME and FOM are 0.247 ± 0.058 and 0.771 ± 0.025 using NSC method, 0.062 ± 0.025 and 0.897 ± 0.027 using GC method, 0.015 ± 0.011 and 0.987 ± 0.012 using NGC method, respectively. The NGC method achieves better performance with lesser values of ME and FOM than the NSC and GC methods.

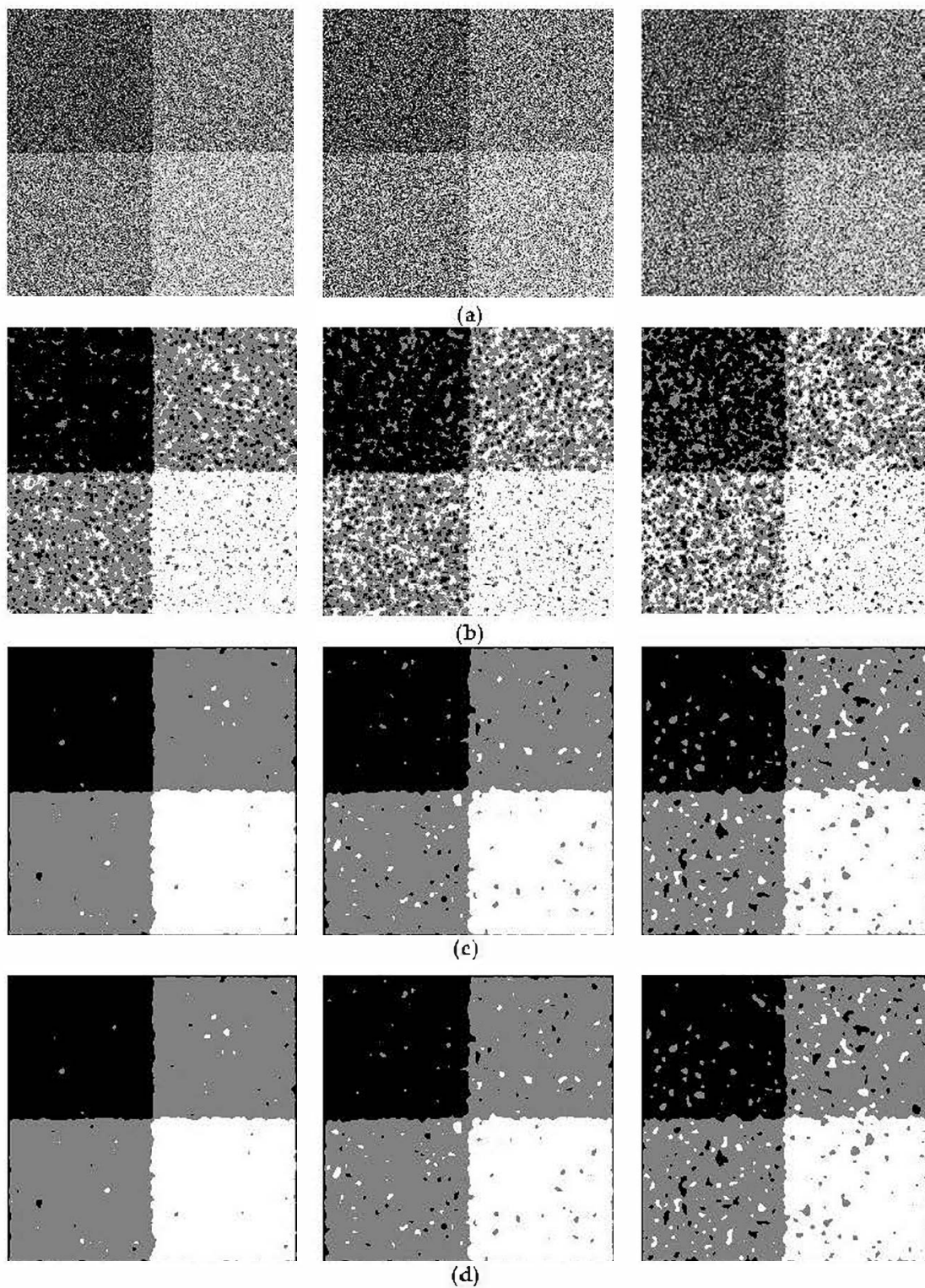

Figure 3. Segmentation comparison on a low contrast synthetic noisy image: (a) Artificial image with different levels of Gaussian noises; (b) Results of the NSC; (c) Results of the GC; (d) Results of the NGC.

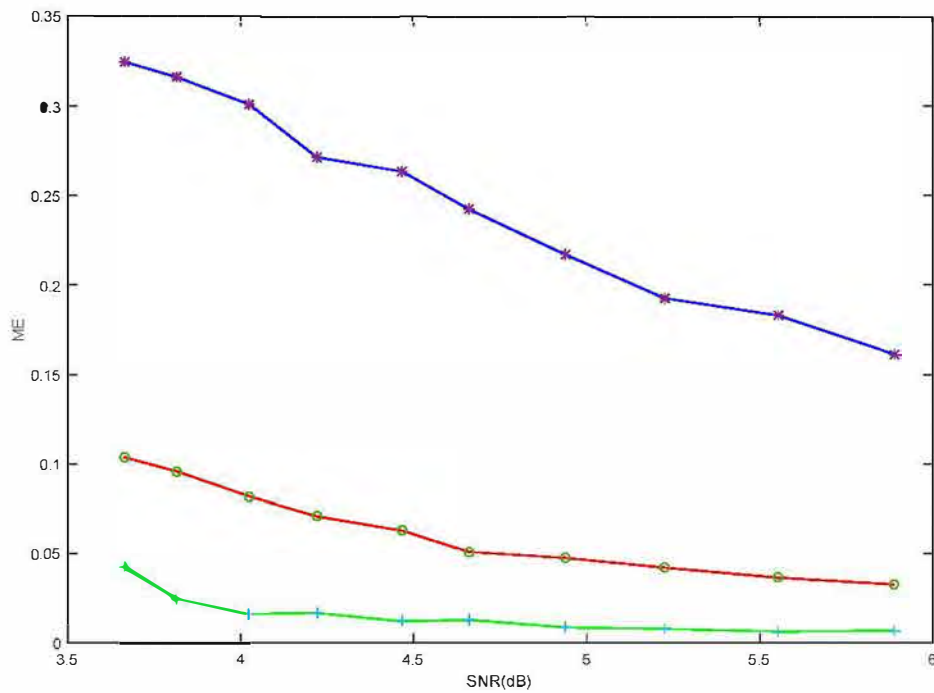

Figure 4. Plot of ME: *, NSC method; o, GC method; +, NGC method.

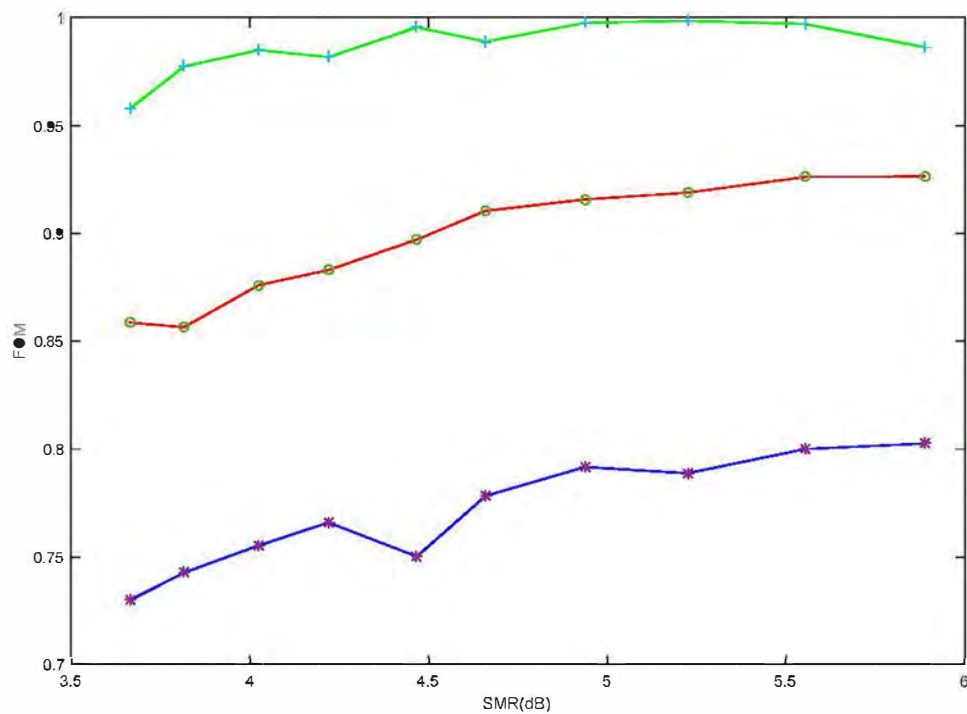

Figure 5. Plot of FOM: *, NSC method; o, GC method; +, NGC method.

Table 1. Performance comparisons on evaluation metrics.

Metrics	NSC	GC	NGC
ME	0.247 ± 0.058	0.062 ± 0.025	0.015 ± 0.011
FOM	0.771 ± 0.025	0.897 ± 0.027	0.987 ± 0.012

4.2. Performance on Natural Images

Many images are employed to validate the NGC’s performance. We also compare the results with a newly developed image segmentation algorithm based on an improved kernel graph cut (KGC) algorithm [33]. Here, five images are randomly selected to show the NGC method’s segmentation performance. The first row in Figures 6–10 shows the original images and segmentation results of NSC, GC, KGC, and NGC, respectively. The other rows demonstrate the results on the noisy images. The results by NGC have better quality than those of NSC, GC, and KGC visually. On the original images, the NGC and GC obtain similarly accurate results, while the KGC obtains under-segmented results. When the noise is increased, the NSC and GC are deeply affected and have a lot of over-segmentation, and the KGC results are under-segmentation and lose some details. However, NGC is not affected by noise and most pixels are categorized into the right groups, and the details on the boundary are well segmented.

Figure 6 shows the segmentation results on the “Lena” image. The results in the fourth columns are better than in the second and third columns. Regions of face, nose, mouth, and eyes are segmented correctly by NGC. The noisy regions as hair region and the area above the hat are also segmented correctly. However, the NSC and GC methods obtain wrong segmentations, especially in the region above the hat. The KGC results lose some detail information on face and eyes. In the observation, the NGC algorithm is better than NSC.



(a)

Figure 6. Cont.



(b)



(c)

Figure 6. *Cont.*



Figure 6. Comparison results on “Lena” image: (a) “Lena” image with different Gaussian noise level: variance: 0, 10, 20, 30; (b) Segmentation results of NSC; (c) Segmentation results of GC; (d) Segmentation results of KGC; (e) Segmentation results of NGC.

We also compared the performances of all methods on the “Peppers” image, as shown in Figure 7. As mentioned earlier for other comparisons, for zero noise level, GC, NGC, and KGC produced similar segmentations. GC, KGC and NGC methods produced better segmentation results than NSC in all noise levels. When the noise level increased, the efficiency of the proposed NGC method became more obvious. There were some wrong segmentation regions (black regions in gray pepper regions) in the GC results. Some of the background regions were also wrongly segmented by the GC method. More proper segmentations were obtained with the proposed NGC method. Especially, for noise levels 20 and 30, the NGC method’s segmentation achievement was visually better than the others, with less wrongly segmented regions produced. On this image, the KGC achieves similar performance as NGC on the segmentation results.

The comparison results on the “Woman” image are given in Figure 8. It is obvious that the NSC method produced worse segmentations when the noise level increased. The GC and KGC methods produced better results when compared to the NSC method, with more homogeneous regions produced. It is also worth mentioning that the GC, KGC and NGC methods produced the same segmentation results for the noiseless case. However, when the noise level increased, the face of the woman became more complicated. On the other hand, the proposed NGC method produced more distinctive regions when compared to other methods. On the results of KGC, the boundary of eyes and nose cannot be recognized. In addition, the edges of the produced regions by NGC were smoother than for the others.



(a)

Figure 7. Cont.

Apuzoșu

1157

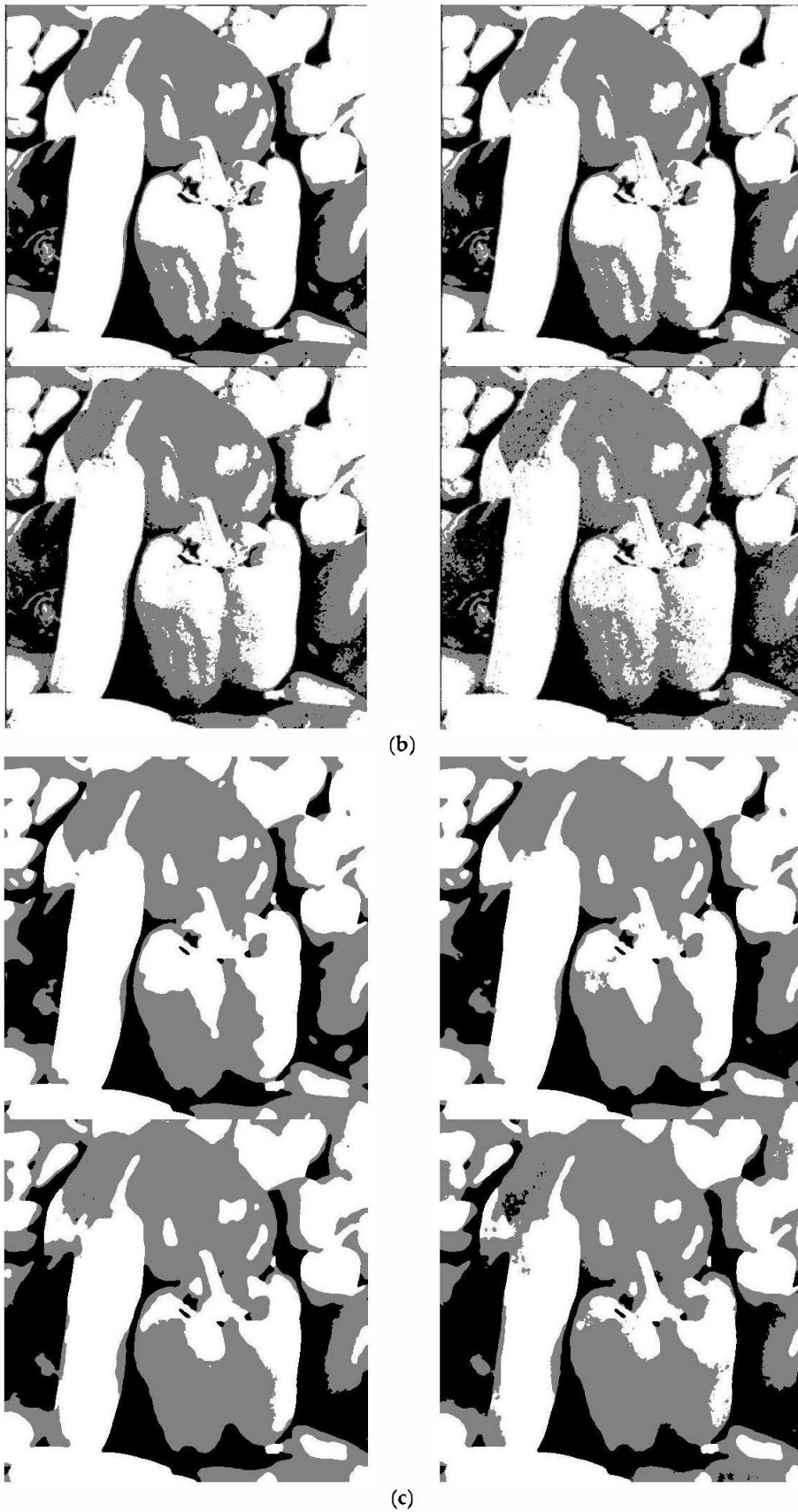

Figure 7. Cont.

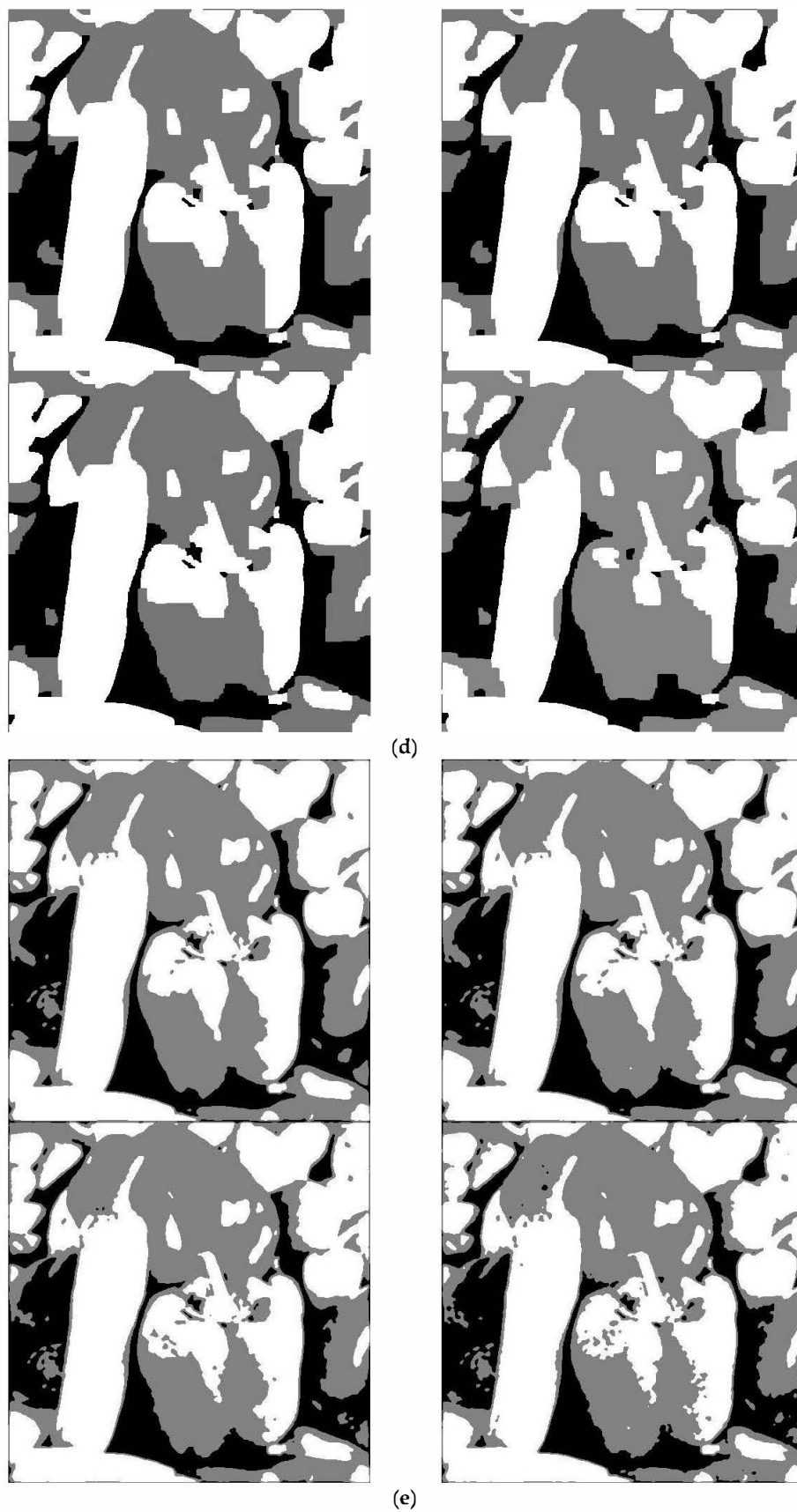

Figure 7. Comparison results on "Peppers" image: (a) "Peppers" image with different Gaussian noise level: variance: 0, 10, 20, 30; (b) Segmentation results of NSC; (c) Segmentation results of GC; (d) Segmentation results of KGC; (e) Segmentation results of NGC.



(a)



(b)

Figure 8. *Cont.*

RECONSTRUCTION

OF THE



(c)



(d)

Figure 8. Cont.



Figure 8. Comparison results on “Woman” image: (a) “Woman” image with different Gaussian noise level: variance: 0, 10, 20, 30; (b) Segmentation results of NSC; (c) Segmentation results of GC; (d) Segmentation results of KGC; (e) Segmentation results of NGC.

We also compared these methods on the “Lake” image, as shown in Figure 9. In the comparisons, it is seen that GC, KGC and NGC methods produced better results than for the NSC method. The results are especially better at high noise levels. It should be specified that GC and KGC methods produced more homogeneous regions, but, in that case, the boundary information was lost. This is an important disadvantage of the GC method. On the other hand, the proposed NGC method also produced comparable homogeneous regions, while preserving the edge information. The proposed method especially yielded better results at high noise levels.

In Figure 10, a more convenient image was used for comparison purposes. While the blood cells can be considered as objects, the rest of the image can be considered as background. In the “Blood” image, the NSC and NGC methods produced similar segmentation results. The KGC has some wrong segmentation on the background region. The NGC has better results on the noisy blood images where the blood cells are extracted accurately and completely. The superiority of the NGC algorithm can also be observed in this image.



(a)

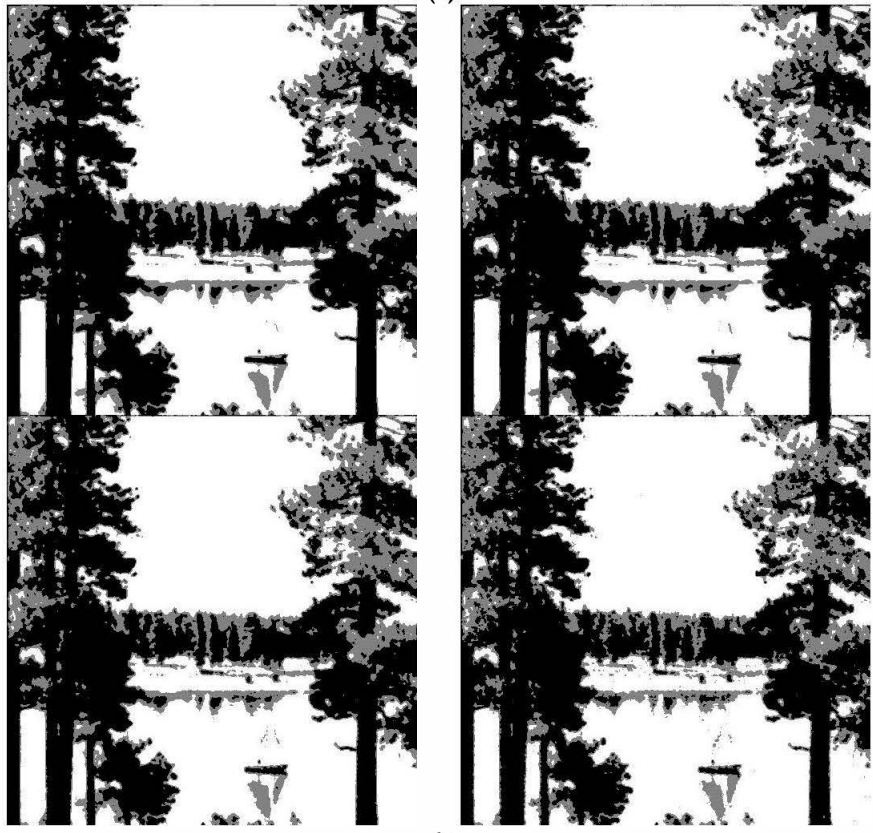

(b)

Figure 9. Cont.

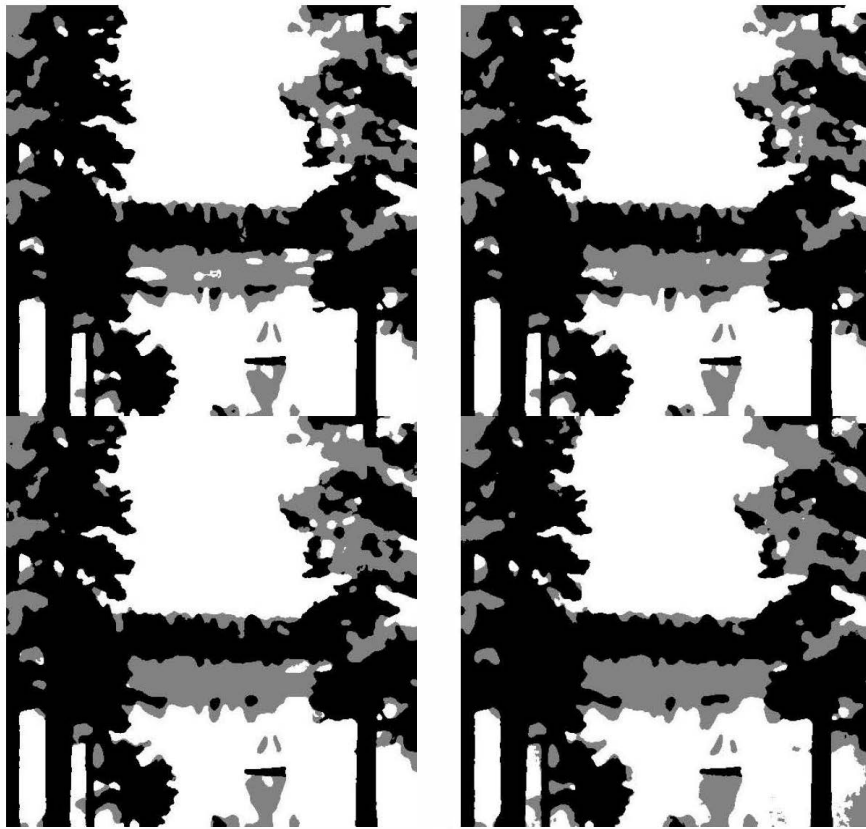

(c)

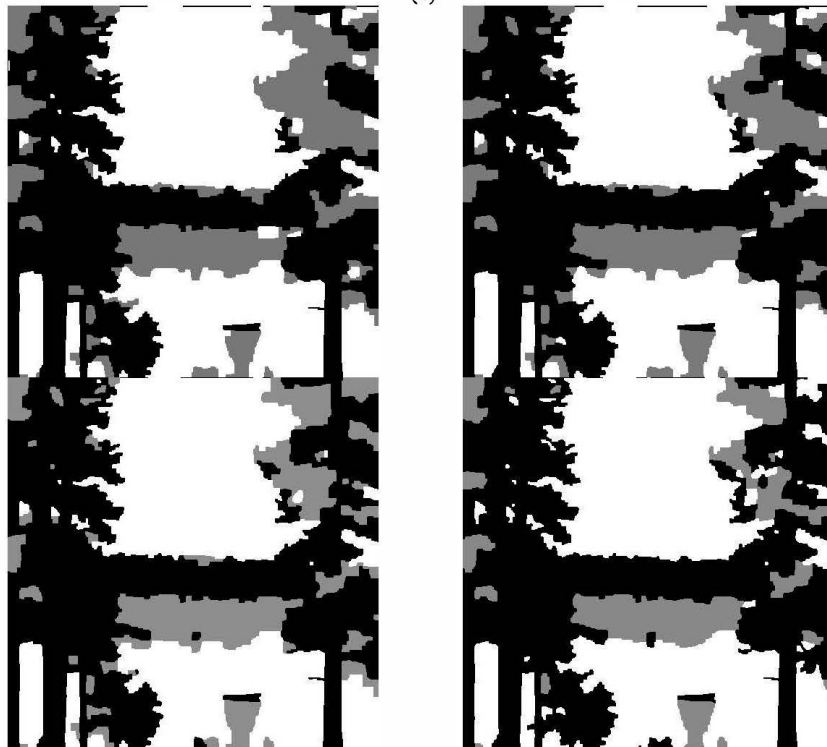

(d)

Figure 9. *Cont.*

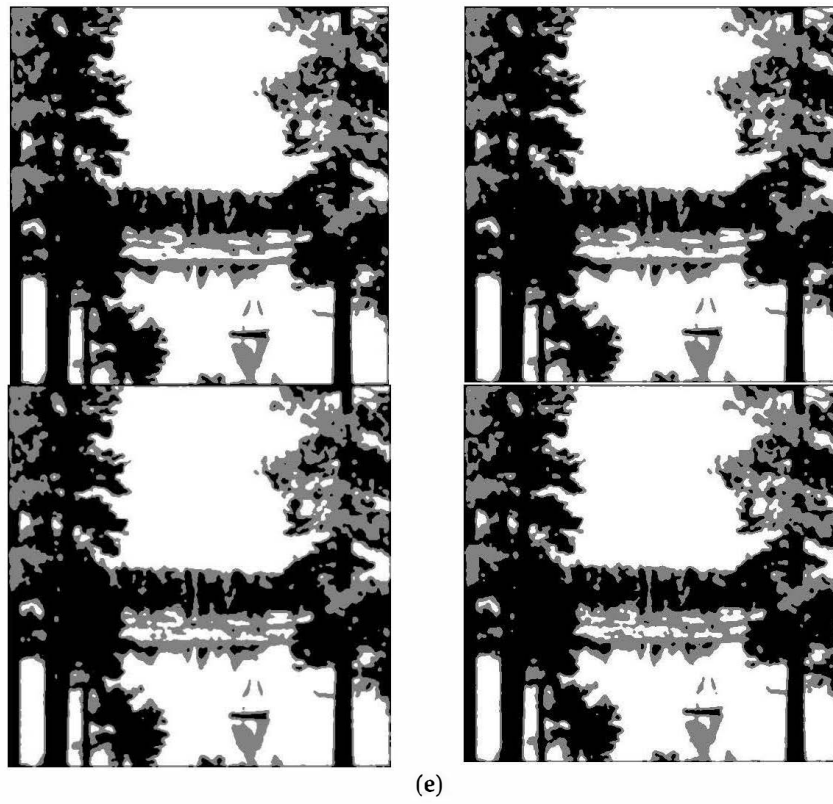

Figure 9. Comparison results on “Lake” image: (a) “Lake” image with different Gaussian noise level: variance: 0, 10, 20, 30; (b) Segmentation results of NSC; (c) Segmentation results of GC; (d) Segmentation results of KGC; (e) Segmentation results of NGC.

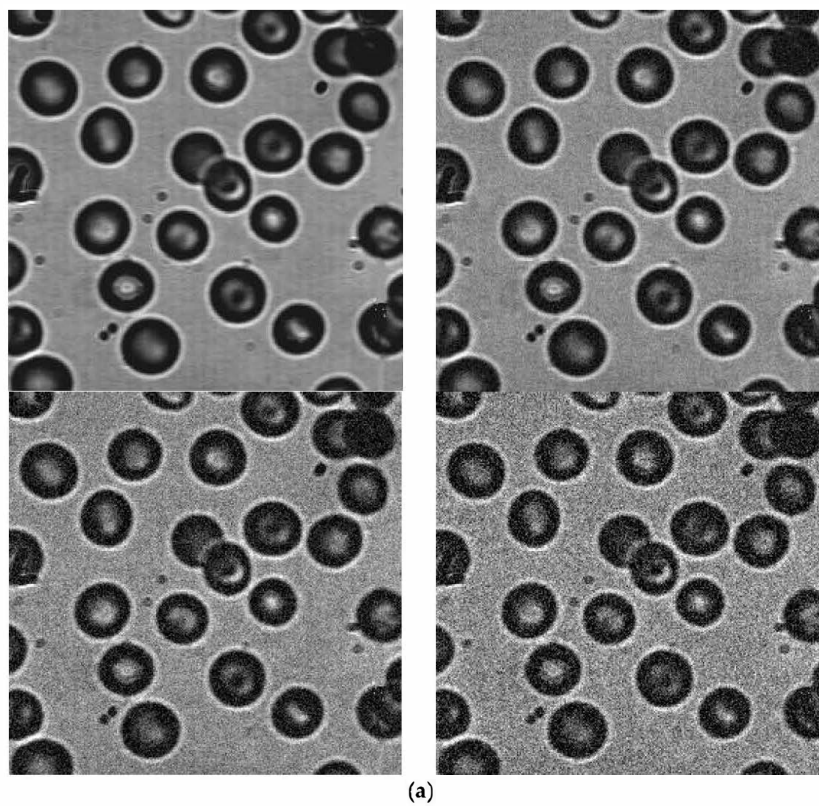
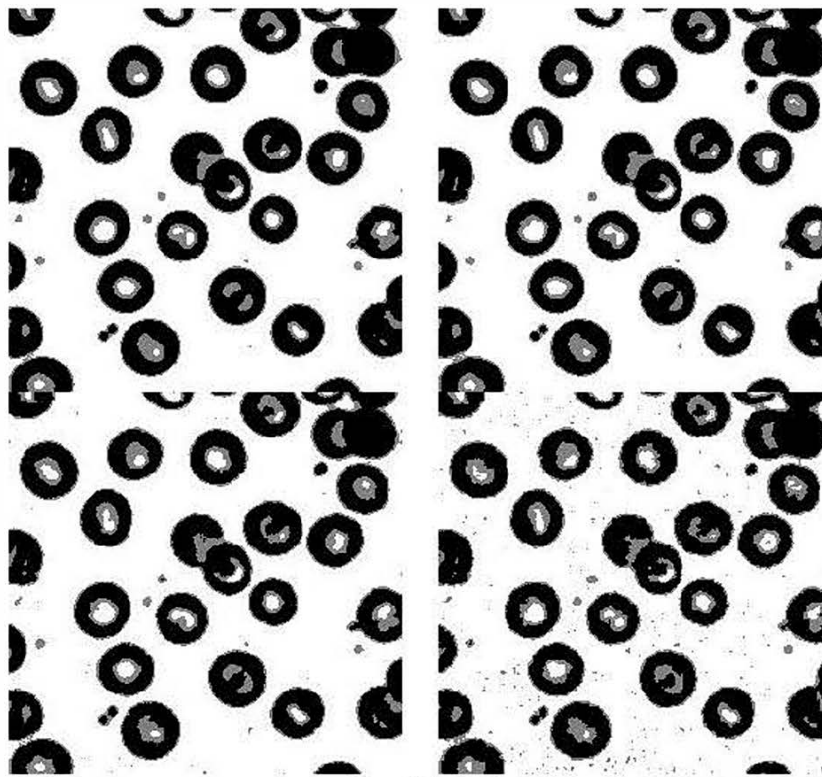
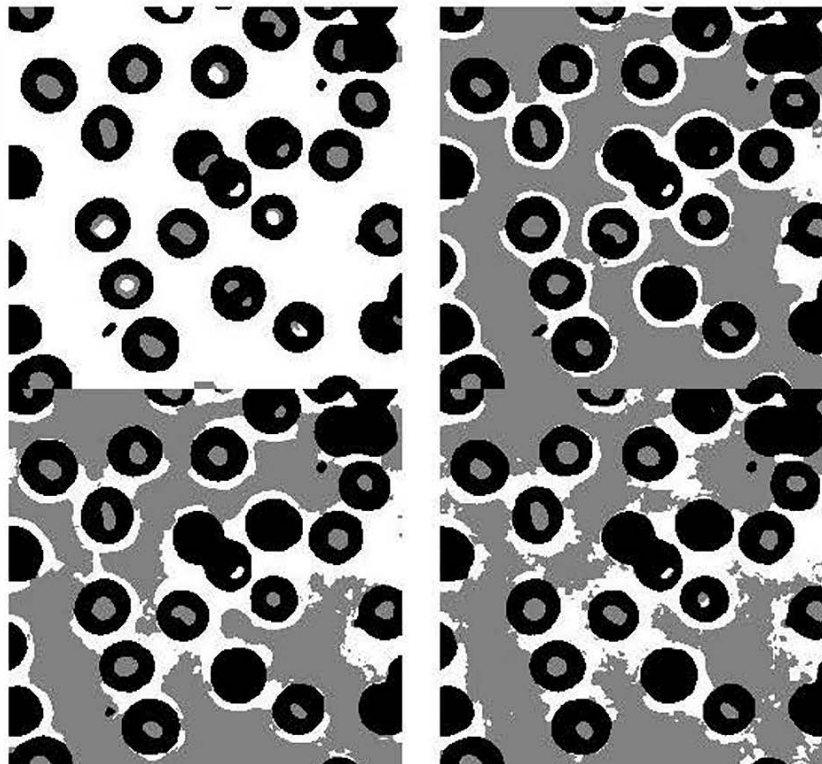

Figure 10. *Cont.*



(b)



(c)

Figure 10. *Cont.*

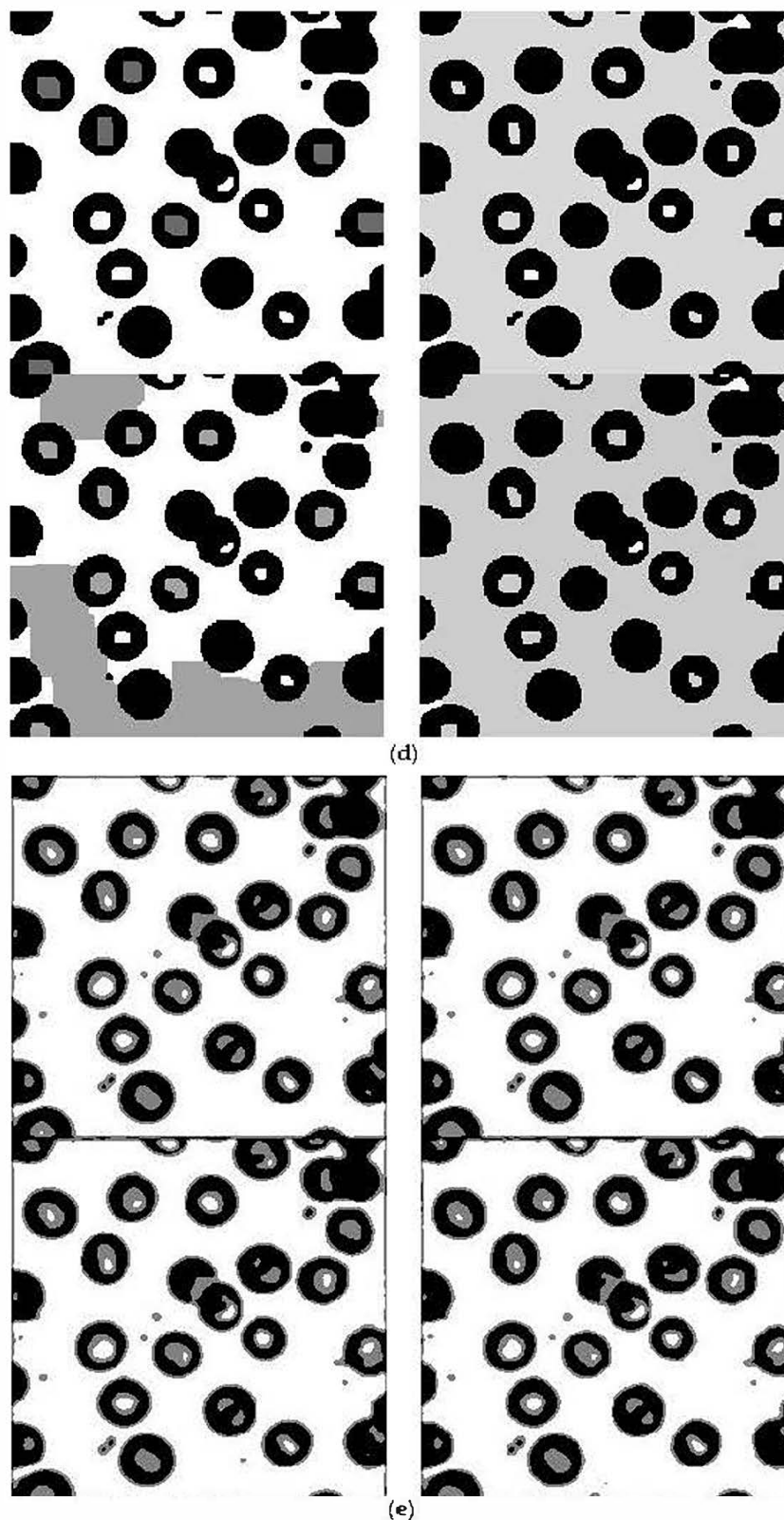

Figure 10. Comparison results on "Blood" image: (a) "Blood" image with different Gaussian noise level: variance: 0, 10, 20, 30, 40; (b) Segmentation results of NSC; (c) Segmentation results of GC; (d) Segmentation results of KGC; (e) Segmentation results of NGC.

5. Conclusions

This study aims to develop an efficient method to segment images having uncertain information such as noise. To overcome this challenge, a novel image segmentation method is proposed based on neutrosophic graph cut in this paper. An image is mapped into the neutrosophic set domain and filtered using a newly defined indeterminacy filter. Then, a new energy function is designed according to the neutrosophic values after indeterminacy filtering. The indeterminacy filtering operation removes the indeterminacy in the global intensity and local spatial information. The segmentation results are obtained by maximum flow algorithm. Comparison results demonstrate the better performance of the proposed method than existing methods, in both quantitative and qualitative terms. It also shows that the presented method can segment the images properly and effectively, on both clean images and noisy images, because the indeterminacy information in the image has been handled well in the proposed approach.

References

1. Pal, N.R.; Pal, S.K. A review on image segmentation techniques. *Pattern Recognit.* **1993**, *26*, 1277–1294. [CrossRef]
2. Gonzalez, R.C. *Digital Image Processing*, 2nd ed.; Prentice Hall: Upper Saddle River, NJ, USA, 2002.
3. Wu, Z.; Leahy, R. An optimal graph theoretic approach to data clustering: Theory and its application to image segmentation. *IEEE. Trans. Pattern Anal. Mach. Intell.* **1993**, *15*, 1101–1113. [CrossRef]
4. Smarandache, F. *Neutrosophy. Neutrosophic Probability, Set, and Logic*, ProQuest Information & Learning; Infolearnquest: Ann Arbor, MI, USA, 1998; p. 105. Available online: <http://fs.gallup.unm.edu/eBook-neutrosophics6.pdf> (accessed on 28 June 2017).
5. Smarandache, F. A Unifying Field in Logics Neutrosophic Logic. In *Neutrosophy, Neutrosophic Set, Neutrosophic Probability*; American Research Press: Rehoboth, DE, USA, 2005.
6. Guo, Y.; Cheng, H.-D. New neutrosophic approach to image segmentation. *Pattern Recognit.* **2009**, *42*, 587–595. [CrossRef]
7. Akhtar, N.; Agarwal, N.; Burjwal, A. K-mean algorithm for Image Segmentation using Neutrosophy. In Proceedings of the ICACCI International Conference on Advances in Computing, Communications and Informatics, New Delhi, India, 24–27 September 2014; pp. 2417–2421.
8. Cheng, H.; Guo, Y.; Zhang, Y. A novel image segmentation approach based on neutrosophic set and improved fuzzy c-means algorithm. *New Math. Nat. Comput.* **2011**, *7*, 155–171. [CrossRef]
9. Zhang, M.; Zhang, L.; Cheng, H. A neutrosophic approach to image segmentation based on watershed method. *Signal Process.* **2010**, *90*, 1510–1517. [CrossRef]
10. Hanbay, K.; Talu, M.F. Segmentation of SAR images using improved artificial bee colony algorithm and neutrosophic set. *Appl. Soft Comput.* **2014**, *21*, 433–443. [CrossRef]
11. Karabatak, E.; Guo, Y.; Sengur, A. Modified neutrosophic approach to color image segmentation. *J. Electron. Imaging* **2013**, *22*, 013005. [CrossRef]
12. Guo, Y.; Sengur, A. A novel color image segmentation approach based on neutrosophic set and modified fuzzy c-means. *Circuits Syst. Signal Process.* **2013**, *32*, 1699–1723. [CrossRef]
13. Sengur, A.; Guo, Y. Color texture image segmentation based on neutrosophic set and wavelet transformation. *Comput. Vis. Image Underst.* **2011**, *115*, 1134–1144. [CrossRef]
14. Mathew, J.M.; Simon, P. Color Texture Image Segmentation Based on Neutrosophic Set and Nonsampled Contourlet Transformation. In Proceedings of the ICAA 2014 First International Conference on Applied Algorithms, Kolkata, India, 13–15 January 2014; Springer: Berlin/Heidelberg, Germany, 2014; pp. 164–173.

15. Yu, B.; Niu, Z.; Wang, L. Mean shift based clustering of neutrosophic domain for unsupervised constructions detection. *Optik-Int. J. Light Electron Opt.* **2013**, *124*, 4697–4706. [[CrossRef](#)]
16. Guo, Y.; Sengur, A. NCM: Neutrosophic c-means clustering algorithm. *Pattern Recognit.* **2015**, *48*, 2710–2724. [[CrossRef](#)]
17. Guo, Y.; Şengür, A. A novel image segmentation algorithm based on neutrosophic similarity clustering. *Appl. Soft Comput.* **2014**, *25*, 391–398. [[CrossRef](#)]
18. Guo, Y.; Şengür, A.; Ye, J. A novel image thresholding algorithm based on neutrosophic similarity score. *Measurement* **2014**, *58*, 175–186. [[CrossRef](#)]
19. Guo, Y.; Şengür, A. A novel image edge detection algorithm based on neutrosophic set. *Comput. Electr. Eng.* **2014**, *40*, 3–25. [[CrossRef](#)]
20. Guo, Y.; Şengür, A. A novel image segmentation algorithm based on neutrosophic filtering and level set. *Neutrosophic Sets Syst.* **2013**, *1*, 46–49.
21. Bo, P.; Zhang, L.; Zhang, D. A survey of graph theoretical approaches to image segmentation. *Pattern Recognit.* **2013**, *46*, 1020–1038.
22. Morris, O.J.; Lee, M.D.; Constantinides, A.G. Graph theory for image analysis: An approach based on the shortest spanning tree. *IEE Proc. F Commun. Radar Signal Proc.* **1986**, *133*, 146–152. [[CrossRef](#)]
23. Felzenszwalb, P.F.; Huttenlocher, D.P. Efficient graph based image segmentation. *Int. J. Comput. Vis.* **2004**, *59*, 167–181. [[CrossRef](#)]
24. Shi, J.; Malik, J. Normalized cuts and image segmentation. *IEEE Trans. Pattern Anal. Mach. Intell.* **2000**, *22*, 888–905.
25. Wang, S.; Siskind, J.M. Image segmentation with ratio cut. *IEEE Trans. Pattern Anal. Mach. Intell.* **2003**, *25*, 675–690. [[CrossRef](#)]
26. Ding, C.; He, X.; Zha, H.; Gu, M.; Simon, H. A min-max cut algorithm for graph partitioning and data clustering. In Proceedings of the First IEEE International Conference on Data Mining (ICDM), San Jose, CA, USA, 29 November–2 December 2001; pp. 107–114.
27. Cox, I.J.; Rao, S.B.; Zhong, Y. Ratio regions: A technique for image segmentation. In Proceedings of the International Conference on Pattern Recognition, Vienna, Austria, 25–29 August 1996; pp. 557–564.
28. Grady, L. Multilabel random walker segmentation using prior models. In Proceedings of the IEEE Conference of Computer Vision and Pattern Recognition, San Diego, CA, USA, 20–25 June 2005; Volume 1, pp. 763–770.
29. Yuan, J.; Bae, E.; Tai, X.; Boykov, Y. A continuous max-flow approach to potts model. *Comput. Vis. ECCV* **2010**, *6316*, 379–392.
30. Yasnoff, W.A.; Mui, J.K.; Bacus, J.W. Error measures for scene segmentation. *Pattern Recognit.* **1977**, *9*, 217–231. [[CrossRef](#)]
31. Pratt, W.K. *Digital Image Processing*; John Wiley & Sons: Hoboken, NJ, USA, 1978; pp. 429–432.
32. Wang, S.; Chung, F.-L.; Xiong, F. A novel image thresholding method based on Parzen window estimate. *Pattern Recognit.* **2008**, *41*, 117–129. [[CrossRef](#)]
33. Salah, M.B.; Mitiche, A.; Ayed, I.B. Multiregion Image Segmentation by Parametric Kernel Graph Cuts. *IEEE Trans. Image Process.* **2011**, *20*, 545–557. [[CrossRef](#)] [[PubMed](#)]

Interval-Valued Fermatean Neutrosophic Graphs

Said Broumi, Raman Sundareswaran, Marayanagaraj Shanmugapriya,
Giorgio Nordo, Mohamed Talea, Assia Bakali, Florentin Smarandache

Said Broumi, Raman Sundareswaran, Marayanagaraj Shanmugapriya, Giorgio Nordo, Mohamed Talea, Assia Bakali, Florentin Smarandache (2022). Interval-Valued Fermatean Neutrosophic Graphs. *Decision Making: Applications in Management and Engineering*, 25; DOI: 10.31181/dmame0311072022b

Abstract: *In this work, we define Interval-valued Fermatean neutrosophic graphs (IVFNS) and present some operations on Interval-valued Fermatean neutrosophic graphs. Further, we introduce the concepts of Regular interval-valued Fermatean neutrosophic graphs, Strong interval-valued Fermatean neutrosophic graphs, Cartesian, Composition, Lexicographic product of interval-valued Fermatean neutrosophic graphs. Finally, we give the applications of Interval-valued Fermatean neutrosophic graphs.*

Key words: *Interval-valued Fermatean Fuzzy sets, Interval-valued Fermatean Neutrosophic sets, Interval-valued Fermatean Neutrosophic graphs*

1. Introduction

The concept of neutrosophic set theory was proposed by Jun (2017). The idea of neutrosophic set which is a generalization of the fuzzy set (Zadeh, 1965), intuitionistic

fuzzy set (Atanassov, 1986). The neutrosophic sets are characterized by a truth function (T), an indeterminate function (I) and a false function (F) independently. Smarandache (2019) introduced the concept of spherical neutrosophic oversets as generalization of spherical fuzzy sets. By bending the concept of single valued neutrosophic set and graph theory, different classes of neutrosophic graphs is discussed by Broumi (2016) and many works available in the literature (Broumi et al., 2016a, 2016b, 2016c, 2016d, 2022). Nagarajan et al. (2019) investigated the interval-valued neutrosophic graphs and its applications. Recently, Ajay et al. (2020, 2021) extended the concept of Pythagorean neutrosophic sets to graphs and called it Pythagorean neutrosophic graph (PNG) and investigated some of their properties. The same authors presented the idea of labelling of Pythagorean neutrosophic fuzzy graphs and investigate their properties. Ajay et al. (2022) studied the concept of regularity in PNG and introduced the ideas of regular, full edge regular, edge regular, and partially edge regular Pythagorean Neutrosophic graphs. In addition, a new MCDM method has been introduced using the Pythagorean neutrosophic graphs with an illustrative example. By integrating the concepts pythagorean neutrosophic fuzzy graph and Dombi operator. Furthermore, Ajay et al. (2021) proposed a new extension of neutrosophic graph called Pythagorean Neutrosophic Dombi fuzzy graphs (PNDFG) and suggested some basic operations of PNDFG and computed the degree and total degree of a vertex of PNDFG. Akalyadevi et al. (2022) introduced the concept of spherical neutrosophic graph coloring and discussed some of their important properties also they suggested the chromatic number of spherical neutrosophic graph as a crisp number. Duleba et al. (2021) applied the concept of Interval-valued spherical fuzzy AHP method to public transportation problem. Aydın et al. (2021) proposed a novel fuzzy MULTIMOORA method based on interval-valued spherical fuzzy sets to evaluate companies that are using Industry 4.0 technologies. Lathamaheswari et al. (2021) proposed the concept of Interval Valued Spherical Fuzzy Aggregation Operators and applied it for solving a Decision-Making Problem. Kutlu Gündoğdu et al. (2021) extended spherical fuzzy analytic hierarchy process to interval-valued spherical fuzzy AHP (IVSF-AHP) method and applied it to compare the service performances of several hospitals. Kutlu Gündoğdu et al. (2019) presented the idea of Spherical fuzzy sets (SFS) as an integration of Pythagorean fuzzy sets and neutrosophic sets. Smarandache (2017) proposed the concept of Spherical Neutrosophic Numbers. Senapati et al. (2019) defined basic operators over the FFSs. On the other hand, division, and subtraction operations on FFSs were proposed. Donghai Liu et al. (2019) focused on a distance measure for Fermatean fuzzy linguistic term sets. Ganie et al. (2022) proposed some novel distance measures for Fermatean fuzzy sets using t-conorms. On the other hand, Jeevaraj et al. (2021) proposed the concept of interval-valued Fermatean fuzzy sets (IVFFSs) and establishes some Mathematical operations on the class of IVFFSs. A new total ordering principle on the class of IVFFNs is introduced. They implemented the interval-valued Fermatean fuzzy TOPSIS (IVFFTOPSIS) method for solving multi-criteria decision-making problems. Based on neutrosophic Pythagorean sets, Stephen et al. (2021) introduced the concept of interval-valued neutrosophic Pythagorean sets with dependent interval valued Pythagorean components and discussed some of its properties. Recently, Lakhwani et al. (2022) introduced a novel concept of Dombi neutrosophic graph and presented some kinds of Dombi neutrosophic graph such as a regular Dombi neutrosophic graph, strong Dombi neutrosophic graph, complete Dombi neutrosophic graph, and complement Dombi neutrosophic graph and described some of their properties, also, and discussed some operations on Dombi neutrosophic graphs are defined.

In this paper, we present the concept of Interval-valued Fermatean neutrosophic graphs (IVFNG) and the concepts of Regular interval-valued Fermatean neutrosophic graphs, Strong interval-valued Fermatean neutrosophic graphs, Cartesian, Composition, Lexicographic product of interval-valued Fermatean neutrosophic graphs. We also introduce some theorems and examples on IVFNG's. Finally, we give the applications of Interval-valued Fermatean neutrosophic graphs.

2. Preliminaries

The extension of crisp set theory with membership degree is known as Fuzzy set theory in which each element of the set gets a real number between 0 and 1. But in many real time situations, it is not always possible to give an exact degree of membership because of lack of knowledge, vague information, and so forth. To overcome this problem, we can use interval-valued fuzzy sets, which assign to each element a closed interval which approximates the “real,” but unknown, membership degree. The length of this interval is a measure for the uncertainty about the membership degree. An interval number I is an interval $[c^-, c^+]$ with $0 \leq c^- \leq c^+ \leq 1$. The interval $[c, c]$ is identified with the number $c \in [0, 1]$. Let $I[0, 1]$ be the set of all closed subintervals of $[0, 1]$. An extension of fuzzy sets by Zadeh (1965), Interval-valued fuzzy sets which stated that the values of the membership degrees are intervals of numbers instead of the numbers. It provides a more sufficient information about uncertainty than traditional fuzzy sets. In this section, we provide all the basic definitions of interval valued sets and its corresponding graphs. Table 1 depicts the types of sets and graphs for interval-valued fuzzy and neutrosophic environments.

Table 1. Different types of Interval-valued sets and its graphs

Type of Sets	Definition	Type of Graphs	Definition
Interval-valued Fuzzy set (IVFS) - Zadeh, 1975	$A = \{(x, [\mu_A^-(x), \mu_A^+(x)]): x \in V\}$	Interval-valued Fuzzy graph (IVFG) - Muhammad Akram, Wieslaw A. Dudek, 2011.	$G = (A, B)$, where $A = [\mu_A^-(x), \mu_A^+(x)]$ is an interval-valued fuzzy set on V and $B = [\mu_B^-(x), \mu_B^+(x)]$ is an interval-valued fuzzy relation on E . <ul style="list-style-type: none"> $\mu_A: V \rightarrow D[0,1]; \eta_A: V \rightarrow D[0,1]$ such that $0 \leq \mu_A(x) + \eta_A(x) \leq 1, \forall x \in V$ $\mu_B: E \subseteq V \times V \rightarrow D[0,1]; \eta_B: E \subseteq V \times V \rightarrow D[0,1]$ $\mu_B^-(x, y) \leq \min(\mu_A^-(x), \mu_A^-(y));$ $\eta_B^-(x, y) \geq \min(\eta_A^-(x), \eta_A^-(y))$ $\mu_B^+(x, y) \leq \min(\mu_A^+(x), \mu_A^+(y));$ $\eta_B^+(x, y) \geq \min(\eta_A^+(x), \eta_A^+(y))$ such that $0 \leq \mu_B^+(x, y) + \eta_B^+(x, y) \leq 1, \forall (x, y) \in E$
Interval-valued Intuitionistic Fuzzy set (IVIFS) - Atanassov, K., Gargov, G., 1989	$A = \{(x, [T_A^-(x), T_A^+(x)]): x \in V\};$ $B = \{(x, [F_A^-(x), F_A^+(x)]): x \in V\}$ such that $0 \leq T_A^+(x) + F_A^+(x) \leq 1$ for all $x \in X$	Interval-valued Intuitionistic Fuzzy graph (IVIFG) - S. N. Mishra and A. Pal, 2013	$G = (A, B)$, where $A = < [T_A^-, T_A^+], [I_A^-, I_A^+], [F_A^-, F_A^+] >$ is an interval-valued neutrosophic set on X ; and $B = < [T_B^-, T_B^+], [I_B^-, I_B^+], [F_B^-, F_B^+] >$ $T_B^-: V \times V \rightarrow [0, 1], T_B^+: V \times V \rightarrow [0, 1], I_B^-: V \times V \rightarrow [0, 1], I_B^+: V \times V \rightarrow [0, 1]$ and $F_B^-: V \times V \rightarrow [0, 1], F_B^+: V \times V \rightarrow [0, 1]$ are such that $T_B^-(\{v_i, v_j\}) \leq \min[T_A^-(v_i), T_A^-(v_j)],$ $T_B^+(\{v_i, v_j\}) \leq \min[T_A^+(v_i), T_A^+(v_j)],$ $I_B^-(\{v_i, v_j\}) \geq \max[I_A^-(v_i), I_A^-(v_j)],$ $I_B^+(\{v_i, v_j\}) \geq \max[I_A^+(v_i), I_A^+(v_j)],$ $F_B^-(\{v_i, v_j\}) \geq \max[F_A^-(v_i), F_A^-(v_j)],$ $F_B^+(\{v_i, v_j\}) \geq \max[F_A^+(v_i), F_A^+(v_j)],$
Interval-valued Neutrosophic set (IVNS) - Said Broumi, Mohamed Talea, Assia Bakali, Florentin Smarandache, (2016)	For each point $x \in X$, we have that $T_A(x) = [T_A^-(x), T_A^+(x)], I_A(x) = [I_A^-(x), I_A^+(x)], F_A(x) = [F_A^-(x), F_A^+(x)] \subseteq [0, 1]$ and $0 \leq T_A(x) + I_A(x) + F_A(x) \leq 3$.	Interval-valued Neutrosophic graph (IVNG) - Said Broumi, Mohamed Talea, Assia Bakali, Florentin Smarandache, 2016	

Interval-valued
Pythagorean
Fuzzy set
(IVPFS) - F.
Teng, Z. Liu, and
P. Liu, (2018).

For each point $x \in X$, we have that
 $T_A(x) = [T_A^-(x), T_A^+(x)]$, $F_A(x) = [F_A^-(x), F_A^+(x)] \subseteq [0, 1]$ and $0 \leq T_A^+(x)^2 + F_A^+(x)^2 \leq 1$.

Interval-valued
Pythagorean
Fuzzy graph
(IVPFG) -
Mohamed S.Y.,
Ali A.M.,2018

$F_B^+ (\{v_i, v_j\}) \geq \max[F_B^+(v_i), F_B^+(v_j)]$
 $G = (A, B)$, where $A = \langle [T_A^-, T_A^+], [F_A^-, F_A^+] \rangle$ is an interval-valued neutrosophic set on V ; and $B = \langle [T_B^-, T_B^+], [F_B^-, F_B^+] \rangle > T_B^-: V \times V \rightarrow [0, 1], T_B^+: V \times V \rightarrow [0, 1]$, and $F_B^-: V \times V \rightarrow [0, 1], F_B^+: V \times V \rightarrow [0, 1]$ are such that
 $T_B^+ (\{v_i, v_j\}) \leq \min[T_A^+(v_i), T_A^+(v_j)]$,
 $T_B^- (\{v_i, v_j\}) \leq \min[T_A^-(v_i), T_A^-(v_j)]$,
 $F_B^- (\{v_i, v_j\}) \geq \max[F_B^-(v_i), F_B^-(v_j)]$,
 $F_B^+ (\{v_i, v_j\}) \geq \max[F_B^+(v_i), F_B^+(v_j)]$
such that $0 \leq T_A^+(x)^2 + F_A^+(x)^2 \leq 1$.

Interval-valued
Fermatean
Fuzzy set
(IVFFS) -
Jeevaraj S,
(2021)

For each point $x \in X$, we have that
 $T_A(x) = [T_A^-(x), T_A^+(x)]$, $F_A(x) = [F_A^-(x), F_A^+(x)] \subseteq [0, 1]$ and $0 \leq T_A^+(x)^3 + F_A^+(x)^3 \leq 1$.

Interval-valued
Fermatean
Fuzzy graph
(IVFFG)

$G = (A, B)$, where $A = \langle [T_A^-, T_A^+], [F_A^-, F_A^+] \rangle$ is an interval-valued neutrosophic set on V ; and $B = \langle [T_B^-, T_B^+], [F_B^-, F_B^+] \rangle > T_B^-: V \times V \rightarrow [0, 1], T_B^+: V \times V \rightarrow [0, 1]$, and $F_B^-: V \times V \rightarrow [0, 1], F_B^+: V \times V \rightarrow [0, 1]$ are such that
 $T_B^+ (\{v_i, v_j\}) \leq \min[T_A^+(v_i), T_A^+(v_j)]$,
 $T_B^- (\{v_i, v_j\}) \leq \min[T_A^-(v_i), T_A^-(v_j)]$,
 $F_B^- (\{v_i, v_j\}) \geq \max[F_B^-(v_i), F_B^-(v_j)]$,
 $F_B^+ (\{v_i, v_j\}) \geq \max[F_B^+(v_i), F_B^+(v_j)]$
such that $0 \leq T_A^+(x)^3 + F_A^+(x)^3 \leq 1$.

Interval-valued
Fermatean
Neutrosophic
set (IVFNS) -
Said Broumi,
Raman
Sundareswaran,
Marayanagaraj
Shanmugapriya,
Giorgio Nordo
Mohamed
Talea, Assia
Bakali, and
Florentin
Smarandache,
(2022)

$A = \{(x, T_A(x), I_A(x), F_A(x)) \mid x \in X\}$
where $T_A(x) = [T_A^-(x), T_A^+(x)]$, $I_A(x) = [I_A^-(x), I_A^+(x)]$
and $F_A(x) = [F_A^-(x), F_A^+(x)]$,
 $T_A(x): X \rightarrow D[0, 1]$
 $I_A(x): X \rightarrow D[0, 1]$, $F_A(x): X \rightarrow D[0, 1]$
 $0 \leq (T_A(x))^3 + (F_A(x))^3 \leq 1$ and $0 \leq (I_A(x))^3 \leq 1$
 $0 \leq (T_A(x))^3 + (F_A(x))^3 + (I_A(x))^3 \leq 2$ means
 $0 \leq (T_A^+(x))^3 + (I_A^+(x))^3 + (F_A^+(x))^3 \leq 2$
 $\forall x \in X$

Interval-valued
Fermatean
Neutrosophic
graph (IVFNG)
- Said Broumi,
et al., 2022

$G = (A, B)$, where $A = \langle [T_A^-, T_A^+], [I_A^-, I_A^+], [F_A^-, F_A^+] \rangle$ is an interval-valued Fermatean neutrosophic set on V ; and $B = \langle [T_B^-, T_B^+], [I_B^-, I_B^+], [F_B^-, F_B^+] \rangle > E$ satisfying the following condition:
 $T_A^-: V \rightarrow [0, 1], T_A^+: V \rightarrow [0, 1], I_A^-: V \rightarrow [0, 1], I_A^+: V \rightarrow [0, 1]$ and $F_A^-: V \rightarrow [0, 1], F_A^+: V \rightarrow [0, 1]$,
and $0 \leq T_A(v_i) + I_A(v_i) + F_A(v_i) \leq 3$, for all $v_i \in V$ ($i = 1, 2, \dots, n$)
The functions $T_B^-: V \times V \rightarrow [0, 1], T_B^+: V \times V \rightarrow [0, 1], I_B^-: V \times V \rightarrow [0, 1], I_B^+: V \times V \rightarrow [0, 1]$ and $F_B^-: V \times V \rightarrow [0, 1], F_B^+: V \times V \rightarrow [0, 1]$ are such that
 $T_B^+ (\{v_i, v_j\}) \leq \min[T_A^+(v_i), T_A^+(v_j)]$,
 $T_B^- (\{v_i, v_j\}) \leq \min[T_A^-(v_i), T_A^-(v_j)]$,
 $I_B^- (\{v_i, v_j\}) \geq \max[I_B^-(v_i), I_B^-(v_j)]$,
 $I_B^+ (\{v_i, v_j\}) \geq \max[I_B^+(v_i), I_B^+(v_j)]$,
 $F_B^- (\{v_i, v_j\}) \geq \max[F_B^-(v_i), F_B^-(v_j)]$,
 $F_B^+ (\{v_i, v_j\}) \geq \max[F_B^+(v_i), F_B^+(v_j)]$,

denoting the degree of truth-membership, indeterminacy-membership and falsity-membership of the edge $(v_i, v_j) \in E$ respectively, where $0 \leq T_B(\{v_i, v_j\})^3 + I_B(\{v_i, v_j\})^3 + F_B(\{v_i, v_j\})^3 \leq 2$ for all $\{v_i, v_j\} \in E$ ($i, j = 1, 2, \dots, n$) means $0 \leq (T_B^+(v_i, v_j))^3 + (I_B^+(v_i, v_j))^3 + (F_B^+(v_i, v_j))^3 \leq 2 \forall x \in X$.

Definition 2.1 (Akram et al., 2013)

The Interval-valued Fuzzy Set (IVFS) A in V is defined by $A = \{(x, \{\mu_A^-(x), \mu_A^+(x)\}) : x \in V\}$, where $\mu_A^-(x)$ and $\mu_A^+(x)$ are fuzzy subsets of V such that $\mu_A^-(x) \leq \mu_A^+(x)$ for all $x \in V$. For any two interval-valued sets $A = [\mu_A^-(x), \mu_A^+(x)]$ and $B = [\mu_B^-(x), \mu_B^+(x)]$ in V .

- Define: • $A \cup B = \{(x, \max(\mu_A^-(x), \mu_B^-(x)), \max(\mu_A^+(x), \mu_B^+(x))) : x \in V\}$,
• $A \cap B = \{(x, \min(\mu_A^-(x), \mu_B^-(x)), \min(\mu_A^+(x), \mu_B^+(x))) : x \in V\}$.

Definition 2.2 (Akram et al., 2013)

If $G^* = (V, E)$ is a graph, then by an **Interval-valued Fuzzy Relation (IVFR)** B on a set E we mean an interval-valued fuzzy set such that $\mu_B^-(xy) \leq \min(\mu_A^-(x), \mu_A^-(y)), \mu_B^+(xy) \leq \min(\mu_A^+(x), \mu_A^+(y))$ for all $xy \in E$.

Definition 2.3 (Akram et al., 2013)

By an Interval-valued Fuzzy Graph (IVFG) of a graph $G^* = (V, E)$ we mean a pair $G = (A, B)$, where $A = [\mu_A^-, \mu_A^+]$ is an interval-valued fuzzy set on V and $B = [\mu_B^-, \mu_B^+]$ is an interval-valued fuzzy relation on E .

Example 2.4 (Akram et al., 2013)

Consider a graph $G^* = (V, E)$ such that $V = \{x, y, z\}, E = \{xy, yz, zx\}$. Let A be an interval-valued fuzzy set of V and B be an interval-valued fuzzy set of $E \subseteq V \times V$ defined by

$$A = \left\langle \left(\frac{x}{0.2}, \frac{y}{0.3}, \frac{z}{0.4} \right), \left(\frac{x}{0.4}, \frac{y}{0.5}, \frac{z}{0.5} \right) \right\rangle, B = \left\langle \left(\frac{xy}{0.2}, \frac{yz}{0.3}, \frac{zx}{0.4} \right), \left(\frac{xy}{0.3}, \frac{yz}{0.4}, \frac{zx}{0.4} \right) \right\rangle$$

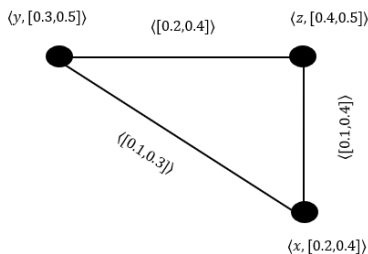

Figure 1. Interval-Valued Fuzzy Graph G

Akram et al. (2013) introduced certain types of interval-valued fuzzy graphs including balanced interval-valued fuzzy graphs, neighbourly irregular interval-valued fuzzy graphs, neighbourly total irregular interval-valued fuzzy graphs, highly irregular interval-valued fuzzy graphs, and highly total irregular interval-valued fuzzy graph. Hossein et al. (2013) define three new operations on interval-valued fuzzy graphs; namely direct product, semi strong product and strong product.

Definition 2.5 (Mishra et al., 2013; Ismayil et al., 2014)

An Interval-valued Intuitionistic Fuzzy Set (IVIFS) A in X , is given by $A = \{ (x, \mu_A(x), \eta_A(x)) / x \in X \}$ where $\mu_A: X \rightarrow [0, 1], \eta_A: X \rightarrow D[0, 1]$. The intervals $\mu_A(x)$ and $\eta_A(x)$ denote the degree of membership and the degree of non-membership of the element x to the set, where $\mu_A(x) = [\mu_A^-(x), \mu_A^+(x)]$ and $\eta_A(x) = [\eta_A^-(x), \eta_A^+(x)]$ with the condition $0 \leq \mu_A^+(x) + \eta_A^+(x) \leq 1$ for all $x \in X$.

Definition 2.6 (Mishra et al., 2013; Ismayil et al., 2014)

An Interval-valued Intuitionistic Fuzzy Graph (IVIFG) with underlying set V is defined to be a pair $G = (A, B)$ where

- the functions $\mu_A: V \rightarrow D[0,1]; \eta_A: V \rightarrow D[0,1]$ denote the degree of membership and non-membership of the element $x \in V$ respectively, such that $0 \leq \mu_A(x) + \eta_A(x) \leq 1, \forall x \in V$
- the functions $\mu_B: E \subseteq V \times V \rightarrow D[0,1]; \eta_B: E \subseteq V \times V \rightarrow D[0,1]$ are defined by

$$\begin{aligned} \mu_B^-(x, y) &\leq \min(\mu_A^-(x), \mu_A^-(y)) ; \eta_B^-(x, y) \geq \min(\eta_A^-(x), \eta_A^-(y)) \\ \mu_B^+(x, y) &\leq \min(\mu_A^+(x), \mu_A^+(y)) ; \eta_B^+(x, y) \geq \min(\eta_A^+(x), \eta_A^+(y)) \\ \text{such that } 0 &\leq \mu_B^+(x, y) + \eta_B^+(x, y) \leq 1, \forall (x, y) \in E \end{aligned}$$

Example 2.7

$G = (A, B)$ defined on a graph $G^* = (V, E)$ such that $V = \{x, y, z\}, E = \{xy, yz, zx\}$, A is an interval valued intuitionistic fuzzy set of V and let B is an interval-valued intuitionistic fuzzy set of $E \subseteq V \times V$.

here $A = \{ \langle x, [0.5, 0.7], [0.1, 0.3] \rangle, \langle y, [0.6, 0.7], [0.1, 0.3] \rangle, \langle z, [0.4, 0.6], [0.2, 0.4] \rangle \}$
 $B = \{ \langle xy, [0.3, 0.6], [0.2, 0.4] \rangle, \langle yz, [0.3, 0.5], [0.3, 0.4] \rangle, \langle xz, [0.3, 0.5], [0.2, 0.4] \rangle \}$

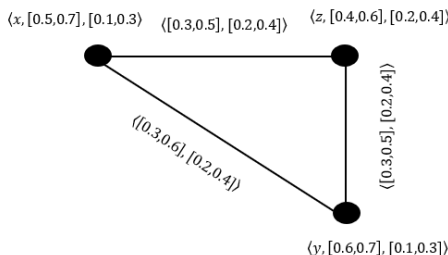

Figure 2. Interval-Valued Intuitionistic Fuzzy Graph G

Mishra et al. (2013) introduced product of IVIFG and Ismayil et al. (2014) defined On Strong Interval-Valued Intuitionistic Fuzzy Graph. Akram et al. (2013) studied the certain types of interval-valued fuzzy graphs. Peng Xu et al. (2022) studied the concept of certain interval-valued intuitionistic fuzzy graphs and its applications. Xindong et al. (2016) introduced the concept of interval-valued Pythagorean fuzzy set. Mohamed et al. (2018) introduced and studied interval-valued Pythagorean fuzzy graphs.

Definition 2.8 (Mohamed et. al., 2018)

An Interval- valued Pythagorean Fuzzy set (IVPFS) A defined in a finite universe of discourse X is given by $A = \{ \langle x, \mu_A(x) = [\mu_A^-(x), \mu_A^+(x)], \eta_A(x) = [\eta_A^-(x), \eta_A^+(x)] \rangle / x \in X \}$ where $\mu_A^-(x), \mu_A^+(x) : X \rightarrow [0, 1]$ and $\eta_A^-(x), \eta_A^+(x) : X \rightarrow [0, 1]$ and $0 \leq (\mu_A^+(x))^2 + (\eta_A^+(x))^2 \leq 1$. Here $\mu_A(x)$ and $\eta_A(x)$ denote the degree of membership and degree of non-membership of $x \in X$ in A .

Definition 2.9 (Mohamed et. al., 2018)

An Pythagorean Fuzzy Graph (PFG) with underlying set V defined to be a pair $G = (A, B)$ where

- the functions $\mu_A : V \rightarrow D[0, 1]; \eta_A : V \rightarrow D[0, 1]$ denote the degree of membership and non-membership of the element $x \in V$ respectively, such that $0 \leq \mu_A(x) + \eta_A(x) \leq 1, \forall x \in V$
- the functions $\mu_B : E \subseteq V \times V \rightarrow D[0, 1]; \eta_B : E \subseteq V \times V \rightarrow D[0, 1]$ are defined by

$$\begin{aligned} \mu_B^-(x, y) &\leq \min(\mu_A^-(x), \mu_A^-(y)) ; \eta_B^-(x, y) \geq \min(\eta_A^-(x), \eta_A^-(y)) \\ \mu_B^+(x, y) &\leq \min(\mu_A^+(x), \mu_A^+(y)) ; \eta_B^+(x, y) \geq \min(\eta_A^+(x), \eta_A^+(y)) \\ \text{such that } 0 &\leq \mu_B^+(x, y)^2 + \eta_B^+(x, y)^2 \leq 1, \forall (x, y) \in E \end{aligned}$$

Yahya et al. (2018) defined the strong interval-valued Pythagorean fuzzy graph and Cartesian product, composition and join of two strong interval-valued Pythagorean fuzzy graph are studied.

Definition 2.10 (Broumi et al., 2016d)

An Interval-valued Neutrosophic Set (IVNS) A in X is characterized by truth-membership function $T_A(x)$, indeterminacy-membership function $I_A(x)$ and falsity-membership function $F_A(x)$. For each point $x \in X$, we have that $T_A(x) = [T_A^-(x), T_A^+(x)]$, $I_A(x) = [I_A^-(x), I_A^+(x)]$, $F_A(x) = [F_A^-(x), F_A^+(x)] \subseteq [0, 1]$ and $0 \leq T_A(x) + I_A(x) + F_A(x) \leq 3$.

Definition 2.11 (Broumi et al., 2016d)

An **Interval-valued Neutrosophic Graph (IVNG)** of a graph $G^* = (V, E)$ we mean a pair $G = (A, B)$, where $A = \langle [T_A^-, T_A^+], [I_A^-, I_A^+], [F_A^-, F_A^+] \rangle$ is an interval-valued neutrosophic set on V ; and $B = \langle [T_B^-, T_B^+], [I_B^-, I_B^+], [F_B^-, F_B^+] \rangle$ is an interval valued neutrosophic relation on E satisfying the following condition:

- i. $V = \{v_1, v_2, \dots, v_n\}$, such that $T_A^- : V \rightarrow [0, 1]$, $T_A^+ : V \rightarrow [0, 1]$, $I_A^- : V \rightarrow [0, 1]$, $I_A^+ : V \rightarrow [0, 1]$ and $F_A^- : V \rightarrow [0, 1]$, $F_A^+ : V \rightarrow [0, 1]$ denote the degree of truth-membership, the degree of indeterminacy-membership and falsity-membership of the element $y \in V$, respectively, and $0 \leq T_A(v_i) + I_A(v_i) + F_A(v_i) \leq 3$, for all $v_i \in V$ ($i = 1, 2, \dots, n$)
- ii. The functions $T_B^- : V \times V \rightarrow [0, 1]$, $T_B^+ : V \times V \rightarrow [0, 1]$, $I_B^- : V \times V \rightarrow [0, 1]$, $I_B^+ : V \times V \rightarrow [0, 1]$ and $F_B^- : V \times V \rightarrow [0, 1]$, $F_B^+ : V \times V \rightarrow [0, 1]$ are such that

$$\begin{aligned} T_B^-(\{v_i, v_j\}) &\leq \min[T_A^-(v_i), T_A^-(v_j)], \\ T_B^+(\{v_i, v_j\}) &\leq \min[T_A^+(v_i), T_A^+(v_j)], \\ I_B^-(\{v_i, v_j\}) &\geq \max[I_A^-(v_i), I_A^-(v_j)], \\ I_B^+(\{v_i, v_j\}) &\geq \max[I_A^+(v_i), I_A^+(v_j)], \\ F_B^-(\{v_i, v_j\}) &\geq \max[F_A^-(v_i), F_A^-(v_j)], \\ F_B^+(\{v_i, v_j\}) &\geq \max[F_A^+(v_i), F_A^+(v_j)], \end{aligned}$$

denoting the degree of truth-membership, indeterminacy-membership and falsity-membership of the edge $(v_i, v_j) \in E$ respectively, where $0 \leq T_B(\{v_i, v_j\}) + I_B(\{v_i, v_j\}) + F_B(\{v_i, v_j\}) \leq 3$ for all $\{v_i, v_j\} \in E$ ($i, j = 1, 2, \dots, n$).

3. Interval-valued Fermatean neutrosophic graphs

Fuzzy sets, Intuitionistic fuzzy sets, Neutrosophic sets are the generalization of the classical set and which are also the most popular mathematical tools in the study uncertainty. Later, researchers combined these sets with graph structures and studied its properties in literature. These combinations, Fuzzy graphs, Intuitionistic fuzzy graphs and Neutrosophic graphs are useful in decision making problems. In an administrative setup, electing a leader among a group of people through the voting process, a judgement may give based on a candidate satisfies his expectations with a possibility of 0.80 and this candidate dissatisfies the expectations with a possibility of 0.95 and neutrally give 0.85. But their sum is 2.80 (>2) and their square sum is 2.265 (>2) and the sum of the cubes is equal to 1.9835 (<2). It is impossible to give an exact degree of membership in every instant, because the lack of knowledge, vague

information, and so forth may produce higher values to the membership values. To overcome this problem, we can use interval-valued fuzzy sets, which assign to each element a closed interval which approximates the “real,” but unknown, membership degree. In this series, we are adding one more class of graphs namely, interval-valued Fermatean neutrosophic graphs and certain types of interval-valued Fermatean neutrosophic graphs are introduced and discussed in this section.

Definition 3.1

An interval-valued Fermatean neutrosophic set (IVFNS) A on the universe of discourse X is of the structure:

$$A = \{ \langle x, T_A(x), I_A(x), F_A(x) \rangle \mid x \in X \}, \text{ where } T_A(x) = [T_A^-(x), T_A^+(x)], I_A(x) = [I_A^-(x), I_A^+(x)] \text{ and } F_A(x) = [F_A^-(x), F_A^+(x)]$$

represents the truth-membership degree, indeterminacy-membership degree and falsity-membership degree, respectively. Consider the mapping $T_A(x): X \rightarrow D[0,1], I_A(x): X \rightarrow D[0,1], F_A(x): X \rightarrow D[0,1]$ and

$$0 \leq (T_A(x))^3 + (F_A(x))^3 \leq 1 \text{ and } 0 \leq (I_A(x))^3 \leq 1$$

$$0 \leq (T_A(x))^3 + (F_A(x))^3 + (I_A(x))^3 \leq 2 \text{ means}$$

$$0 \leq (T_A^+(x))^3 + (I_A^+(x))^3 + (F_A^+(x))^3 \leq 2 \quad \forall x \in X$$

Definition 3.2

An Interval-Valued Fermatean Neutrosophic Graph (IVFNG) of a graph $G^* = (V, E)$ we mean a pair $G = (A, B)$, where $A = \langle [T_A^-, T_A^+], [I_A^-, I_A^+], [F_A^-, F_A^+] \rangle$ is an interval-valued Fermatean neutrosophic set on V ; and $B = \langle [T_B^-, T_B^+], [I_B^-, I_B^+], [F_B^-, F_B^+] \rangle$ is an interval valued Fermatean neutrosophic relation on E satisfying the following condition:

- i. $V = \{ v_1, v_2, \dots, v_n \}$, such that $T_A^- : V \rightarrow [0, 1], T_A^+ : V \rightarrow [0, 1], I_A^- : V \rightarrow [0, 1], I_A^+ : V \rightarrow [0, 1]$ and $F_A^- : V \rightarrow [0, 1], F_A^+ : V \rightarrow [0, 1]$ denote the degree of truth -membership, the degree of indeterminacy-membership and falsity-membership of the element $y \in V$, respectively, and $0 \leq T_A(v_i) + I_A(v_i) + F_A(v_i) \leq 3$, for all $v_i \in V (i = 1, 2, \dots, n)$.
- ii. The functions $T_B^- : V \times V \rightarrow [0, 1], T_B^+ : V \times V \rightarrow [0, 1], I_B^- : V \times V \rightarrow [0, 1], I_B^+ : V \times V \rightarrow [0, 1]$ and $F_B^- : V \times V \rightarrow [0, 1], F_B^+ : V \times V \rightarrow [0, 1]$ are such that

$$T_B^-(\{v_i, v_j\}) \leq \min[T_A^-(v_i), T_A^-(v_j)], \quad T_B^+(\{v_i, v_j\}) \leq \min[T_A^+(v_i), T_A^+(v_j)],$$

$$I_B^-(\{v_i, v_j\}) \geq \max[I_A^-(v_i), I_A^-(v_j)], \quad I_B^+(\{v_i, v_j\}) \geq \max[I_A^+(v_i), I_A^+(v_j)],$$

$$F_B^-(\{v_i, v_j\}) \geq \max[F_A^-(v_i), F_A^-(v_j)], \quad F_B^+(\{v_i, v_j\}) \geq \max[F_A^+(v_i), F_A^+(v_j)]$$

denoting the degree of truth-membership, indeterminacy-membership and falsity-membership of the edge $(v_i, v_j) \in E$ respectively, where $0 \leq T_B(\{v_i, v_j\})^3 + I_B(\{v_i, v_j\})^3 + F_B(\{v_i, v_j\})^3 \leq 2$ for all $\{v_i, v_j\} \in E (i, j = 1, 2, \dots, n)$ means $0 \leq (T_B^+(v_i, v_j))^3 + (I_B^+(v_i, v_j))^3 + (F_B^+(v_i, v_j))^3 \leq 2 \quad \forall x \in X$.

Example 3.3

Consider a graph G^* , such that $V = \{x_1, x_2, x_3\}, E = \{x_1x_2, x_2x_3, x_3x_4, x_4x_1\}$. Let A be an interval valued Fermatean neutrosophic subset of V and B be an interval valued Fermatean neutrosophic subset of E , denoted by

$$A = \left\{ \begin{aligned} &\langle x_1, [0.85, 0.95], [0.90, 0.95], [0.85, 0.85] \rangle, \langle x_2, [0.85, 0.90], [0.90, 0.95], [0.85, 0.90] \rangle, \\ &\langle x_3, [0.85, 0.95], [0.95, 0.95], [0.85, 0.95] \rangle \end{aligned} \right\}$$

$$B = \left\{ \begin{aligned} &\langle x_1x_2, [0.80, 0.90], [0.90, 0.95], [0.80, 0.85] \rangle, \langle x_2x_3, [0.85, 0.90], [0.90, 0.95], [0.85, 0.85] \rangle, \\ &\langle x_3x_1, [0.85, 0.95], [0.90, 0.95], [0.85, 0.85] \rangle \end{aligned} \right\}$$

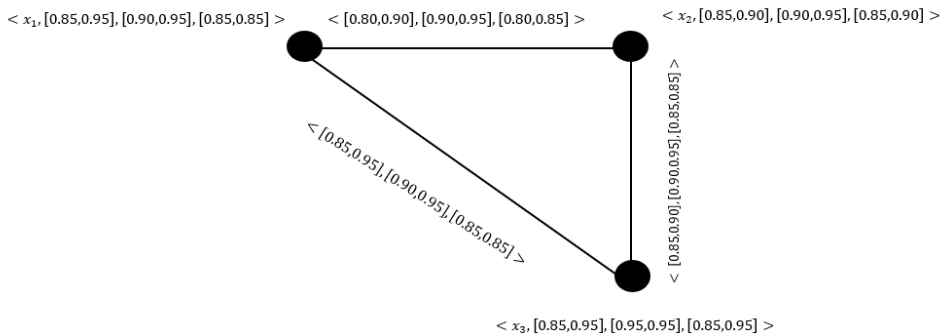

Figure 3. Interval-valued Fermatean Neutrosophic Graph G

Definition 3.4.

Let $G = (A, B)$ be an IVFNG. G is an interval valued regular Fermatean neutrosophic graph if it satisfies the following conditions:

$$\begin{aligned} \sum_{v_1 \neq v_2} T_B^-(v_1, v_2) &= \text{constant} & ; & \sum_{v_1 \neq v_2} T_B^+(v_1, v_2) = \text{constant} \\ \sum_{v_1 \neq v_2} I_B^-(v_1, v_2) &= \text{constant} & ; & \sum_{v_1 \neq v_2} I_B^+(v_1, v_2) = \text{constant} \\ \sum_{v_1 \neq v_2} F_B^-(v_1, v_2) &= \text{constant} & ; & \sum_{v_1 \neq v_2} F_B^+(v_1, v_2) = \text{constant} \end{aligned}$$

Definition 3.5.

Let $G = (A, B)$ be an IVFNG. G is an interval valued regular strong neutrosophic graph if it satisfies the following conditions

$$\begin{aligned} T_B^-(v_1, v_2) &= \min(T_A^-(v_1), T_A^-(v_2)); & \sum_{v_1 \neq v_2} T_B^-(v_1, v_2) &= \text{constant} \\ T_B^+(v_1, v_2) &= \min(T_A^+(v_1), T_A^+(v_2)); & \sum_{v_1 \neq v_2} T_B^+(v_1, v_2) &= \text{constant} \\ I_B^-(v_1, v_2) &= \max(I_A^-(v_1), I_A^-(v_2)); & \sum_{v_1 \neq v_2} I_B^-(v_1, v_2) &= \text{constant} \\ I_B^+(v_1, v_2) &= \max(I_A^+(v_1), I_A^+(v_2)); & \sum_{v_1 \neq v_2} I_B^+(v_1, v_2) &= \text{constant} \\ F_B^-(v_1, v_2) &= \max(F_A^-(v_1), F_A^-(v_2)); & \sum_{v_1 \neq v_2} F_B^-(v_1, v_2) &= \text{constant} \\ F_B^+(v_1, v_2) &= \max(F_A^+(v_1), F_A^+(v_2)); & \sum_{v_1 \neq v_2} F_B^+(v_1, v_2) &= \text{constant} \end{aligned}$$

Definition 3.6.

Let $G = (A, B)$ be an IVFNG. G is a strong interval valued regular strong neutrosophic graph if it satisfies the following conditions:

$$\begin{aligned} T_B^-(v_1, v_2) &= \min(T_A^-(v_1), T_A^-(v_2)); \\ I_B^-(v_1, v_2) &= \max(I_A^-(v_1), I_A^-(v_2)); \\ F_B^-(v_1, v_2) &= \max(F_A^-(v_1), F_A^-(v_2)); \\ T_B^+(v_1, v_2) &= \min(T_A^+(v_1), T_A^+(v_2)); \\ I_B^+(v_1, v_2) &= \max(I_A^+(v_1), I_A^+(v_2)); \\ F_B^+(v_1, v_2) &= \max(F_A^+(v_1), F_A^+(v_2)); \end{aligned}$$

such that $0 \leq T_B^+(v_1, v_2) + I_B^+(v_1, v_2) + F_B^+(v_1, v_2) \leq 3$, for all $v_1, v_2 \in E$ and $0 \leq (T_B^+(v_i, v_j))^3 + (I_B^+(v_i, v_j))^3 + (F_B^+(v_i, v_j))^3 \leq 2 \quad \forall x \in X$

Example 3.7.

Let $G = (A, B)$ be an Interval-valued Fermatean Neutrosophic graph with $V = \{x_1, x_2, x_3\}$.

$$A = \left\{ \langle x_1, [0.85, 0.95], [0.90, 0.95], [0.85, 0.85] \rangle, \langle x_2, [0.85, 0.90], [0.90, 0.95], [0.85, 0.90] \rangle, \langle x_3, [0.85, 0.95], [0.95, 0.95], [0.85, 0.95] \rangle \right\}$$

$$B = \left\{ \langle x_1 x_2, [0.85, 0.90], [0.90, 0.95], [0.80, 0.90] \rangle, \langle x_2 x_3, [0.85, 0.90], [0.95, 0.95], [0.85, 0.95] \rangle, \langle x_1 x_3, [0.85, 0.95], [0.95, 0.95], [0.85, 0.95] \rangle \right\}$$

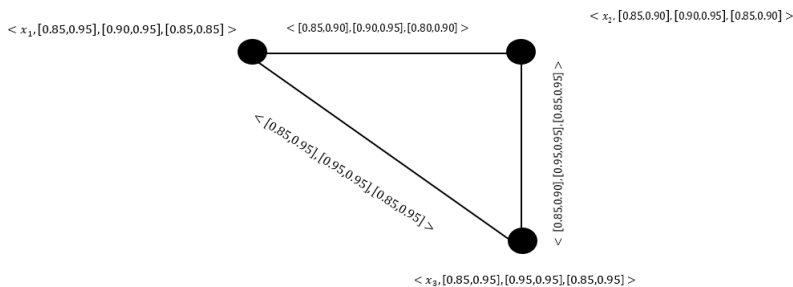

Figure 4. Strong Interval-valued Fermatean Neutrosophic Graph G

Definition 3.8.

Let A_1 and A_2 be interval-valued neutrosophic subsets of V_1 and V_2 respectively. Let B_1 and B_2 interval-valued neutrosophic subsets of E_1 and E_2 respectively. The Cartesian product of two IVFNGs G_1 and G_2 is denoted by $G_1 \times G_2 = (A_1 \times A_2, B_1 \times B_2)$ and is defined as follows:

- i. $(T_{A_1}^- \times T_{A_2}^-)(x_1, x_2) = \min(T_{A_1}^-(x_1), T_{A_2}^-(x_2))$
 $(T_{A_1}^+ \times T_{A_2}^+)(x_1, x_2) = \min(T_{A_1}^+(x_1), T_{A_2}^+(x_2))$
 $(I_{A_1}^- \times I_{A_2}^-)(x_1, x_2) = \max(I_{A_1}^-(x_1), I_{A_2}^-(x_2))$
 $(I_{A_1}^+ \times I_{A_2}^+)(x_1, x_2) = \max(I_{A_1}^+(x_1), I_{A_2}^+(x_2))$
 $(F_{A_1}^- \times F_{A_2}^-)(x_1, x_2) = \max(F_{A_1}^-(x_1), F_{A_2}^-(x_2))$
 $(F_{A_1}^+ \times F_{A_2}^+)(x_1, x_2) = \max(F_{A_1}^+(x_1), F_{A_2}^+(x_2))$ for all $(x_1, x_2) \in V$
- ii. $(T_{B_1}^- \times T_{B_2}^-)((x, x_2)(x, y_2)) = \min(T_{A_1}^-(x), T_{B_1}^-(x_2 y_2))$
 $(T_{B_1}^+ \times T_{B_2}^+)((x, x_2)(x, y_2)) = \min(T_{A_1}^+(x), T_{B_1}^+(x_2 y_2))$
 $(I_{B_1}^- \times I_{B_2}^-)((x, x_2)(x, y_2)) = \max(I_{A_1}^-(x), I_{B_2}^-(x_2 y_2))$
 $(I_{B_1}^+ \times I_{B_2}^+)((x, x_2)(x, y_2)) = \max(I_{A_1}^+(x), I_{B_2}^+(x_2 y_2))$
 $(F_{B_1}^- \times F_{B_2}^-)((x, x_2)(x, y_2)) = \max(F_{A_1}^-(x), F_{B_2}^-(x_2 y_2))$
 $(F_{B_1}^+ \times F_{B_2}^+)((x, x_2)(x, y_2)) = \max(F_{A_1}^+(x), F_{B_2}^+(x_2 y_2))$
 $\forall x \in V_1$ and $\forall x_2 y_2 \in E_2$
- iii. $(T_{B_1}^- \times T_{B_2}^-)((x_1, z)(y_1, z)) = \min(T_{B_1}^-(x_1 y_1), T_{A_2}^-(z))$

$$\begin{aligned}
 (T_{B_1}^+ \times T_{B_2}^+) ((x_1, z) (y_1, z)) &= \min (T_{B_1}^+(x_1 y_1), T_{A_2}^+(z)) \\
 (I_{B_1}^- \times I_{B_2}^-) ((x_1, z) (y_1, z)) &= \max (I_{B_1}^-(x_1 y_1), I_{A_2}^-(z)) \\
 (I_{B_1}^+ \times I_{B_2}^+) ((x_1, z) (y_1, z)) &= \max (I_{B_1}^+(x_1 y_1), I_{A_2}^+(z)) \\
 (F_{B_1}^- \times F_{B_2}^-) ((x_1, z) (y_1, z)) &= \max (F_{B_1}^-(x_1 y_1), F_{A_2}^-(z)) \\
 (F_{B_1}^+ \times F_{B_2}^+) ((x_1, z) (y_1, z)) &= \max (F_{B_1}^+(x_1 y_1), F_{A_2}^+(z)) \\
 &\forall z \in V_2 \text{ and } \forall x_1 y_1 \in E_1
 \end{aligned}$$

Example 3.9.

Let $G_1^* = (A_1, B_1)$ and $G_2^* = (A_2, B_2)$ be two graphs where $V_1 = \{u_1, u_2\}, V_2 = \{v_1, v_2\}$. Consider two interval valued Fermatean neutrosophic graphs:
 $A_1 = \{\langle u_1, [0.85, 0.95], [0.95, 0.95], [0.95, 0.95] \rangle, \langle u_2, [0.90, 0.90], [0.95, 0.95], [0.85, 0.85] \rangle\}$,
 $B_1 = \{\langle u_1 u_2, [0.85, 0.90], [0.95, 0.95], [0.95, 0.95] \rangle\}$;
 $A_2 = \{\langle v_1, [0.80, 0.90], [0.85, 0.95], [0.95, 0.85] \rangle, \langle v_2, [0.95, 0.90], [0.95, 0.95], [0.80, 0.85] \rangle\}$,
 $B_2 = \{\langle v_1 v_2, [0.80, 0.90], [0.95, 0.95], [0.95, 0.85] \rangle\}$.

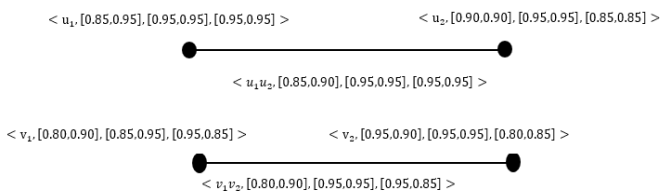

Figure 5. Interval – valued Fermatean Neutrosophic Graphs G_1, G_2

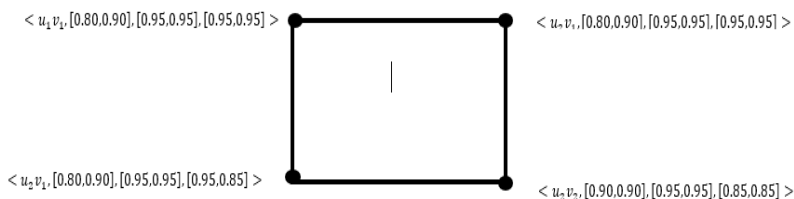

Figure 6. Cartesian product of two IVFNGs $G_1 \times G_2$

Definition 3.10.

Let $G^{\$} = G_1^{\$} \times G_2^{\$} = (V_1 \times V_2, E)$ be the composition of two graphs where $E = \{(x, x_2) (x, y_2) / x \in V_1, x_2 y_2 \in E_2\} \cup \{(x_1, z) (y_1, z) / z \in V_2, x_1 y_1 \in E_1\} \cup \{(x_1, x_2) (y_1, y_2) | x_1 y_1 \in E_1, x_2 \neq y_2\}$, then the composition of interval valued Fermatean neutrosophic graphs $G_1[G_2] = (A_1 \circ A_2, B_1 \circ B_2)$ is an interval valued Fermatean neutrosophic graphs defined by:

- i. $(T_{A_1}^- \circ T_{A_2}^-) (x_1, x_2) = \min (T_{A_1}^-(x_1), T_{A_2}^-(x_2))$
 $(T_{A_1}^+ \circ T_{A_2}^+) (x_1, x_2) = \min (T_{A_1}^+(x_1), T_{A_2}^+(x_2))$
 $(I_{A_1}^- \circ I_{A_2}^-) (x_1, x_2) = \max (I_{A_1}^-(x_1), I_{A_2}^-(x_2))$
 $(I_{A_1}^+ \circ I_{A_2}^+) (x_1, x_2) = \max (I_{A_1}^+(x_1), I_{A_2}^+(x_2))$
 $(F_{A_1}^- \circ F_{A_2}^-) (x_1, x_2) = \max (F_{A_1}^-(x_1), F_{A_2}^-(x_2))$
 $(F_{A_1}^+ \circ F_{A_2}^+) (x_1, x_2) = \max (F_{A_1}^+(x_1), F_{A_2}^+(x_2)) \forall x_1 \in V_1, x_2 \in V_2$
- ii. $(T_{A_1}^- \circ T_{A_2}^-) ((x, x_2) (x, y_2)) = \min (T_{A_1}^-(x), T_{B_2}^-(x_2 y_2))$

$$\begin{aligned}
 &(T_{A_1}^+ \circ T_{A_1}^+)((x, x_2)(x, y_2)) = \min(T_{A_1}^+(x), T_{B_2}^+(x_2y_2)) \\
 &(I_{A_1}^- \circ I_{A_2}^-)((x, x_2)(x, y_2)) = \max(I_{A_1}^-(x), I_{B_2}^-(x_2y_2)) \\
 &(I_{A_1}^+ \circ I_{A_2}^+)((x, x_2)(x, y_2)) = \max(I_{A_1}^+(x), I_{B_2}^+(x_2y_2)) \\
 &(F_{A_1}^- \circ F_{A_2}^-)((x, x_2)(x, y_2)) = \max(F_{A_1}^-(x), F_{B_2}^-(x_2y_2)) \\
 &(F_{A_1}^+ \circ F_{A_2}^+)((x, x_2)(x, y_2)) = \max(F_{A_1}^+(x), F_{B_2}^+(x_2y_2)) \forall x \in V_1, \forall x_2y_2 \in E_2 \\
 \text{iii. } &(T_{B_1}^- \circ T_{B_2}^-)((x_1, z)(y_1, z)) = \min(T_{B_1}^-(x_1y_1), T_{A_2}^-(z)) \\
 &(T_{B_1}^+ \circ T_{B_2}^+)((x_1, z)(y_1, z)) = \min(T_{B_1}^+(x_1y_1), T_{A_2}^+(z)) \\
 &(I_{B_1}^- \circ I_{B_2}^-)((x_1, z)(y_1, z)) = \max(I_{B_1}^-(x_1y_1), I_{A_2}^-(z)) \\
 &(I_{B_1}^+ \circ I_{B_2}^+)((x_1, z)(y_1, z)) = \max(I_{B_1}^+(x_1y_1), I_{A_2}^+(z)) \\
 &(F_{B_1}^- \circ F_{B_2}^-)((x_1, z)(y_1, z)) = \max(F_{B_1}^-(x_1y_1), F_{A_2}^-(z)) \\
 &(F_{B_1}^+ \circ F_{B_2}^+)((x_1, z)(y_1, z)) = \max(F_{B_1}^+(x_1y_1), F_{A_2}^+(z)) \forall z \in V_2, \forall x_1y_1 \in E_1 ; \\
 \text{iv. } &(T_{B_1}^- \circ T_{B_2}^-)((x_1, x_2)(y_1, y_2)) = \min(T_{A_2}^-(x_2), T_{A_2}^-(y_2), T_{B_1}^-(x_1y_1)) \\
 &(T_{B_1}^+ \circ T_{B_2}^+)((x_1, x_2)(y_1, y_2)) = \min(T_{A_2}^+(x_2), T_{A_2}^+(y_2), T_{B_1}^+(x_1y_1)) \\
 &(I_{B_1}^- \circ I_{B_2}^-)((x_1, x_2)(y_1, y_2)) = \max(I_{A_2}^-(x_2), I_{A_2}^-(y_2), I_{B_1}^-(x_1y_1)) \\
 &(I_{B_1}^+ \circ I_{B_2}^+)((x_1, x_2)(y_1, y_2)) = \max(I_{A_2}^+(x_2), I_{A_2}^+(y_2), I_{B_1}^+(x_1y_1)) \\
 &(F_{B_1}^- \circ F_{B_2}^-)((x_1, x_2)(y_1, y_2)) = \max(F_{A_2}^-(x_2), F_{A_2}^-(y_2), F_{B_1}^-(x_1y_1)) \\
 &(F_{B_1}^+ \circ F_{B_2}^+)((x_1, x_2)(y_1, y_2)) = \max(F_{A_2}^+(x_2), F_{A_2}^+(y_2), F_{B_1}^+(x_1y_1)) \\
 &\forall (x_1, x_2)(y_1, y_2) \in E^0 - E, \text{ where } E^0 = E \cup \{(x_1, x_2)(y_1, y_2) | x_1y_1 \in E_1, x_2 \neq y_2\}.
 \end{aligned}$$

Example 3.11.

Let $G_1^* = (A_1, B_1)$ and $G_2^* = (A_2, B_2)$ be two graphs where $V_1 = \{u_1, u_2\}, V_2 = \{v_1, v_2\}$. Consider two interval valued Fermatean neutrosophic graphs:

$$\begin{aligned}
 A_1 &= \{\langle u_1, [0.85, 0.95], [0.95, 0.95], [0.95, 0.95] \rangle, \langle u_2, [0.90, 0.90], [0.95, 0.95], [0.85, 0.85] \rangle\}, \\
 B_1 &= \{\langle u_1u_2, [0.85, 0.90], [0.95, 0.95], [0.95, 0.95] \rangle\}; \\
 A_2 &= \{\langle v_1, [0.80, 0.90], [0.85, 0.95], [0.95, 0.85] \rangle, \langle v_2, [0.95, 0.90], [0.95, 0.95], [0.80, 0.85] \rangle\}, \\
 B_2 &= \{\langle v_1v_2, [0.80, 0.90], [0.95, 0.95], [0.95, 0.85] \rangle\}.
 \end{aligned}$$

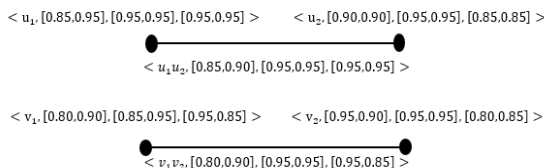

Figure 7. Interval – valued Fermatean Neutrosophic Graphs G_1, G_2

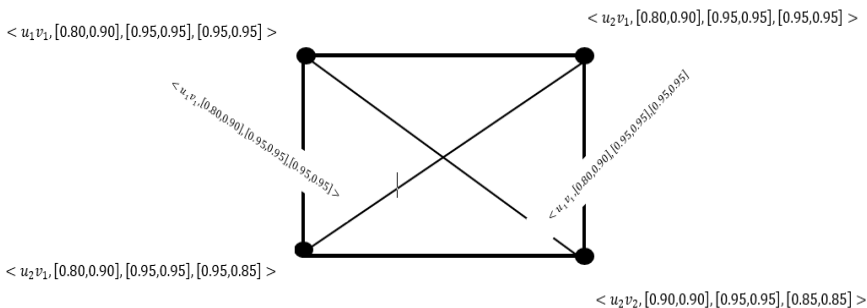

Figure 8. Composition of interval valued Fermatean neutrosophic graphs $G_1 [G_2]$

Definition 3.12.

The union $G_1 \cup G_2 = (A_1 \cup A_2, B_1 \cup B_2)$ of two interval valued Fermatean neutrosophic graphs of the graphs G_1^* and G_2^* is an interval-valued Fermatean neutrosophic graph of $G_1^* \cup G_2^*$.

- $(T_{A_1}^- \cup T_{A_2}^-)(x) = \begin{cases} T_{A_1}^-(x), & \text{if } x \in V_1 \text{ and } x \notin V_2 \\ T_{A_2}^-(x) & \text{if } x \notin V_1 \text{ and } x \in V_2 \\ \min(T_{A_1}^-(x), T_{A_2}^-(x)) & \text{if } x \in V_1 \cap V_2, \end{cases}$
- $(T_{A_1}^+ \cup T_{A_2}^+)(x) = \begin{cases} T_{A_1}^+(x), & \text{if } x \in V_1 \text{ and } x \notin V_2 \\ T_{A_2}^+(x) & \text{if } x \notin V_1 \text{ and } x \in V_2 \\ \min(T_{A_1}^+(x), T_{A_2}^+(x)) & \text{if } x \in V_1 \cap V_2, \end{cases}$
- $(I_{A_1}^- \cup I_{A_2}^-)(x) = \begin{cases} I_{A_1}^-(x), & \text{if } x \in V_1 \text{ and } x \notin V_2 \\ I_{A_2}^-(x) & \text{if } x \notin V_1 \text{ and } x \in V_2 \\ \max(I_{A_1}^-(x), I_{A_2}^-(x)) & \text{if } x \in V_1 \cap V_2, \end{cases}$
- $(I_{A_1}^+ \cup I_{A_2}^+)(x) = \begin{cases} I_{A_1}^+(x), & \text{if } x \in V_1 \text{ and } x \notin V_2 \\ I_{A_2}^+(x) & \text{if } x \notin V_1 \text{ and } x \in V_2 \\ \max(I_{A_1}^+(x), I_{A_2}^+(x)) & \text{if } x \in V_1 \cap V_2, \end{cases}$
- $(F_{A_1}^- \cup F_{A_2}^-)(x) = \begin{cases} F_{A_1}^-(x), & \text{if } x \in V_1 \text{ and } x \notin V_2 \\ F_{A_2}^-(x) & \text{if } x \notin V_1 \text{ and } x \in V_2 \\ \max(F_{A_1}^-(x), F_{A_2}^-(x)) & \text{if } x \in V_1 \cap V_2, \end{cases}$
- $(F_{A_1}^+ \cup F_{A_2}^+)(x) = \begin{cases} F_{A_1}^+(x), & \text{if } x \in V_1 \text{ and } x \notin V_2 \\ F_{A_2}^+(x) & \text{if } x \notin V_1 \text{ and } x \in V_2 \\ \max(F_{A_1}^+(x), F_{A_2}^+(x)) & \text{if } x \in V_1 \cap V_2, \end{cases}$
- $(T_{B_1}^- \cup T_{B_2}^-)(xy) = \begin{cases} T_{B_1}^-(xy), & \text{if } xy \in E_1 \text{ and } xy \notin E_2 \\ T_{B_2}^-(xy) & \text{if } xy \notin E_1 \text{ and } xy \in E_2 \\ \min(T_{B_1}^-(xy), T_{B_2}^-(xy)) & \text{if } xy \in E_1 \cap E_2, \end{cases}$
- $(T_{B_1}^+ \cup T_{B_2}^+)(xy) = \begin{cases} T_{B_1}^+(xy), & \text{if } xy \in E_1 \text{ and } xy \notin E_2 \\ T_{B_2}^+(xy) & \text{if } xy \notin E_1 \text{ and } xy \in E_2 \\ \min(T_{B_1}^+(xy), T_{B_2}^+(xy)) & \text{if } xy \in E_1 \cap E_2, \end{cases}$

- $(I_{B_1}^- \cup I_{B_2}^-)(xy) = \begin{cases} I_{B_1}^-(xy), \text{ if } xy \in E_1 \text{ and } xy \notin E_2 \\ I_{B_2}^-(xy) \text{ if } xy \notin E_1 \text{ and } xy \in E_2 \\ \min(I_{B_1}^-(xy), I_{B_2}^-(xy)) \text{ if } xy \in E_1 \cap E_2, \end{cases}$
- $(I_{B_1}^+ \cup I_{B_2}^+)(xy) = \begin{cases} I_{B_1}^+(xy), \text{ if } xy \in E_1 \text{ and } xy \notin E_2 \\ I_{B_2}^+(xy) \text{ if } xy \notin E_1 \text{ and } xy \in E_2 \\ \max(I_{B_1}^+(xy), I_{B_2}^+(xy)) \text{ if } xy \in E_1 \cap E_2, \end{cases}$
- $(F_{B_1}^- \cup F_{B_2}^-)(xy) = \begin{cases} F_{B_1}^-(xy), \text{ if } xy \in E_1 \text{ and } xy \notin E_2 \\ F_{B_2}^-(xy) \text{ if } xy \notin E_1 \text{ and } xy \in E_2 \\ \max(F_{B_1}^-(xy), F_{B_2}^-(xy)) \text{ if } xy \in E_1 \cap E_2, \end{cases}$
- $(F_{B_1}^+ \cup F_{B_2}^+)(xy) = \begin{cases} F_{B_1}^+(xy), \text{ if } xy \in E_1 \text{ and } xy \notin E_2 \\ F_{B_2}^+(xy) \text{ if } xy \notin E_1 \text{ and } xy \in E_2 \\ \max(F_{B_1}^+(xy), F_{B_2}^+(xy)) \text{ if } xy \in E_1 \cap E_2, \end{cases}$

Definition 3.13.

The join of $G_1 + G_2 = (A_1 + A_2, B_1 + B_2)$ interval valued neutrosophic graphs G_1 and G_2 of the graphs G_1^* and G_2^* is defined as follows:

- $(T_{A_1}^- + T_{A_2}^-)(x) = \begin{cases} T_{A_1}^-(x) \text{ if } x \in V_1 \\ T_{A_2}^-(x) \text{ if } x \in V_2 \\ \min(T_{A_1}^-, T_{A_2}^-)(x) \text{ if } x \in V_1 \cup V_2, \end{cases}$
- $(T_{A_1}^+ + T_{A_2}^+)(x) = \begin{cases} T_{A_1}^+(x) \text{ if } x \in V_1 \\ T_{A_2}^+(x) \text{ if } x \in V_2 \\ \min(T_{A_1}^+, T_{A_2}^+)(x) \text{ if } x \in V_1 \cup V_2, \end{cases}$
- $(I_{A_1}^- + I_{A_2}^-)(x) = \begin{cases} I_{A_1}^-(x) \text{ if } x \in V_1 \\ I_{A_2}^-(x) \text{ if } x \in V_2 \\ \max(I_{A_1}^-, I_{A_2}^-)(x) \text{ if } x \in V_1 \cup V_2, \end{cases}$
- $(I_{A_1}^+ + I_{A_2}^+)(x) = \begin{cases} I_{A_1}^+(x) \text{ if } x \in V_1 \\ I_{A_2}^+(x) \text{ if } x \in V_2 \\ \max(I_{A_1}^+, I_{A_2}^+)(x) \text{ if } x \in V_1 \cup V_2, \end{cases}$
- $(F_{A_1}^- + F_{A_2}^-)(x) = \begin{cases} F_{A_1}^-(x) \text{ if } x \in V_1 \\ F_{A_2}^-(x) \text{ if } x \in V_2 \\ \max(F_{A_1}^-, F_{A_2}^-)(x) \text{ if } x \in V_1 \cup V_2, \end{cases}$
- $(F_{A_1}^+ + F_{A_2}^+)(x) = \begin{cases} F_{A_1}^+(x) \text{ if } x \in V_1 \\ F_{A_2}^+(x) \text{ if } x \in V_2 \\ \max(F_{A_1}^+, F_{A_2}^+)(x) \text{ if } x \in V_1 \cup V_2, \end{cases}$
- $(T_{B_1}^- + T_{B_2}^-)(xy) = \begin{cases} T_{B_1}^-(xy), \text{ if } xy \in E_1 \\ T_{B_2}^-(xy) \text{ if } xy \in E_2 \\ \min(T_{B_1}^-(xy), T_{B_2}^-(xy)) \text{ if } xy \in E_1 \cup E_2, \end{cases}$

$$\begin{aligned}
 \bullet \quad (T_{B_1}^+ + T_{B_2}^+)(xy) &= \begin{cases} T_{B_1}^+(xy), \text{ if } xy \in E_1 \\ T_{B_2}^+(xy) \text{ if } xy \in E_2 \\ \min(T_{B_1}^+(xy), T_{B_2}^+(xy)) \text{ if } xy \in E_1 \cup E_2, \end{cases} \\
 \bullet \quad (I_{B_1}^- + I_{B_2}^-)(xy) &= \begin{cases} I_{B_1}^-(xy), \text{ if } xy \in E_1 \\ I_{B_2}^-(xy) \text{ if } xy \in E_2 \\ \max(I_{B_1}^-(xy), I_{B_2}^-(xy)) \text{ if } xy \in E_1 \cup E_2, \end{cases} \\
 \bullet \quad (I_{B_1}^+ + I_{B_2}^+)(xy) &= \begin{cases} I_{B_1}^+(xy), \text{ if } xy \in E_1 \\ I_{B_2}^+(xy) \text{ if } xy \in E_2 \\ \max(I_{B_1}^+(xy), I_{B_2}^+(xy)) \text{ if } xy \in E_1 \cup E_2, \end{cases} \\
 \bullet \quad (F_{B_1}^- + F_{B_2}^-)(xy) &= \begin{cases} F_{B_1}^-(xy), \text{ if } xy \in E_1 \\ F_{B_2}^-(xy) \text{ if } xy \in E_2 \\ \max(F_{B_1}^-(xy), F_{B_2}^-(xy)) \text{ if } xy \in E_1 \cup E_2, \end{cases} \\
 \bullet \quad (F_{B_1}^+ + F_{B_2}^+)(xy) &= \begin{cases} F_{B_1}^+(xy), \text{ if } xy \in E_1 \\ F_{B_2}^+(xy) \text{ if } xy \in E_2 \\ \max(F_{B_1}^+(xy), F_{B_2}^+(xy)) \text{ if } xy \in E_1 \cup E_2, \end{cases} \\
 \bullet \quad (T_{B_1}^- + T_{B_2}^-)(xy) &= \min(T_{B_1}^-(x), T_{B_2}^-(x)) \\
 \bullet \quad (T_{B_1}^+ + T_{B_2}^+)(xy) &= \min(T_{B_1}^+(x), T_{B_2}^+(x)) \\
 \bullet \quad (I_{B_1}^- + I_{B_2}^-)(xy) &= \max(I_{B_1}^-(x), I_{B_2}^-(x)) \\
 \bullet \quad (I_{B_1}^+ + I_{B_2}^+)(xy) &= \max(I_{B_1}^+(x), I_{B_2}^+(x)) \\
 \bullet \quad (F_{B_1}^- + F_{B_2}^-)(xy) &= \max(F_{B_1}^-(x), F_{B_2}^-(x)) \\
 \bullet \quad (F_{B_1}^+ + F_{B_2}^+)(xy) &= \max(F_{B_1}^+(x), F_{B_2}^+(x)) \text{ if } xy \in E',
 \end{aligned}$$

where E' is the set of all edges joining the nodes of V_1 and V_2 , assuming $V_1 \cap V_2 = \emptyset$.

Example 3.14.

Let $G_1^* = (A_1, B_1)$ and $G_2^* = (A_2, B_2)$ be two graphs where $V_1 = \{u_1, u_2, u_3, u_4\}$, $V_2 = \{v_1, v_2, v_3\}$. Consider two interval valued fermatean neutrosophic graphs:

$$\begin{aligned}
 A_1 &= \{ \langle u_1, [0.85, 0.95], [0.95, 0.95], [0.95, 0.95] \rangle, \langle u_2, [0.90, 0.90], [0.95, 0.95], [0.85, 0.85] \rangle, \\
 &\quad \langle u_3, [0.90, 0.95], [0.85, 0.95], [0.85, 0.85] \rangle, \langle u_4, [0.90, 0.95], [0.95, 0.90], [0.80, 0.85] \rangle \} \\
 B_1 &= \{ \langle u_1 u_2, [0.85, 0.90], [0.95, 0.95], [0.95, 0.95] \rangle, \langle u_2 u_3, [0.90, 0.90], [0.95, 0.95], [0.85, 0.85] \rangle, \\
 &\quad \langle u_3 u_4, [0.90, 0.95], [0.95, 0.95], [0.85, 0.85] \rangle, \langle u_1 u_4, [0.85, 0.95], [0.95, 0.95], [0.95, 0.95] \rangle, \\
 &\quad \langle u_1 u_3, [0.85, 0.95], [0.95, 0.95], [0.95, 0.95] \rangle \} ; \\
 A_2 &= \{ \langle u_1, [0.80, 0.90], [0.85, 0.95], [0.95, 0.85] \rangle, \langle u_2, [0.95, 0.90], [0.95, 0.95], [0.80, 0.85] \rangle, \\
 &\quad \langle u_3, [0.90, 0.90], [0.95, 0.95], [0.80, 0.80] \rangle \} \\
 B_2 &= \{ \langle u_1 u_2, [0.80, 0.90], [0.95, 0.95], [0.95, 0.85] \rangle, \langle u_2 u_3, [0.90, 0.90], [0.95, 0.95], [0.80, 0.85] \rangle, \\
 &\quad \langle u_1 u_3, [0.80, 0.90], [0.95, 0.95], [0.95, 0.85] \rangle \}
 \end{aligned}$$

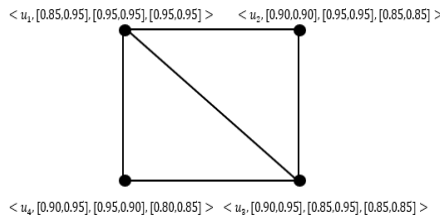

Figure 9. Interval – valued Fermatean Neutrosophic Graph G_1

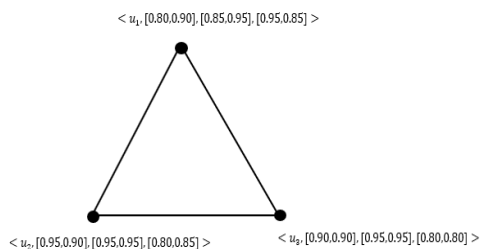

Figure 10. Interval – valued Fermatean Neutrosophic Graph G_2

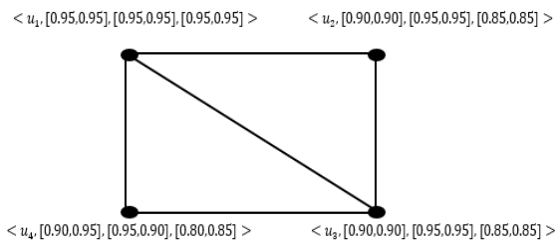

Figure 11. Union two Interval – valued Fermatean Neutrosophic Graphs $G_1 \cup G_2$

$$\left\{ \begin{aligned} &\langle u_1 u_2, [0.80, 0.90], [0.95, 0.95], [0.95, 0.95] \rangle, \langle u_2 u_3, [0.90, 0.90], [0.95, 0.95], [0.85, 0.85] \rangle, \\ &\langle u_3 u_4, [0.90, 0.95], [0.95, 0.95], [0.85, 0.85] \rangle, \langle u_1 u_4, [0.85, 0.95], [0.95, 0.95], [0.95, 0.95] \rangle, \\ &\langle u_1 u_3, [0.80, 0.90], [0.95, 0.95], [0.95, 0.95] \rangle \end{aligned} \right\}$$

Example 3.15

Let $G_1^* = (A_1, B_1)$ and $G_2^* = (A_2, B_2)$ be two graphs where $V_1 = \{x_1, x_2, x_3\}$, $V_2 = \{y_1, y_2, y_3\}$. Consider two interval valued Fermatean neutrosophic graphs :

$$\begin{aligned} A_1 &= \left\{ \langle x_1, [0.85, 0.95], [0.95, 0.95], [0.95, 0.95] \rangle, \langle x_2, [0.90, 0.90], [0.95, 0.95], [0.85, 0.85] \rangle, \right. \\ &\quad \left. \langle x_3, [0.90, 0.95], [0.85, 0.95], [0.85, 0.85] \rangle \right\} \\ B_1 &= \{ \langle x_1 x_2, [0.85, 0.90], [0.95, 0.95], [0.95, 0.95] \rangle, \langle x_2 x_3, [0.90, 0.90], [0.95, 0.95], [0.85, 0.85] \rangle \} \\ A_2 &= \left\{ \langle y_1, [0.85, 0.85], [0.95, 0.95], [0.90, 0.90] \rangle, \langle y_2, [0.95, 0.90], [0.90, 0.95], [0.80, 0.85] \rangle, \right. \\ &\quad \left. \langle y_3, [0.95, 0.95], [0.85, 0.85], [0.85, 0.85] \rangle \right\} \\ B_2 &= \{ \langle y_1 y_2, [0.85, 0.85], [0.95, 0.95], [0.90, 0.90] \rangle, \langle y_2 y_3, [0.95, 0.90], [0.90, 0.95], [0.85, 0.85] \rangle \} \end{aligned}$$

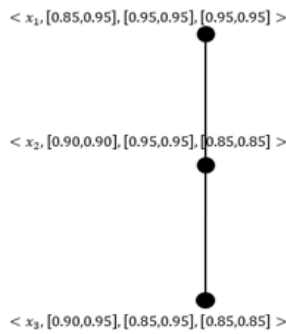

Figure 12. Interval – valued Fermatean Neutrosophic Graph G_1

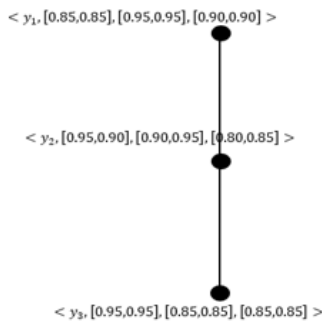

Figure 13. Interval – valued Fermatean Neutrosophic Graph G_2

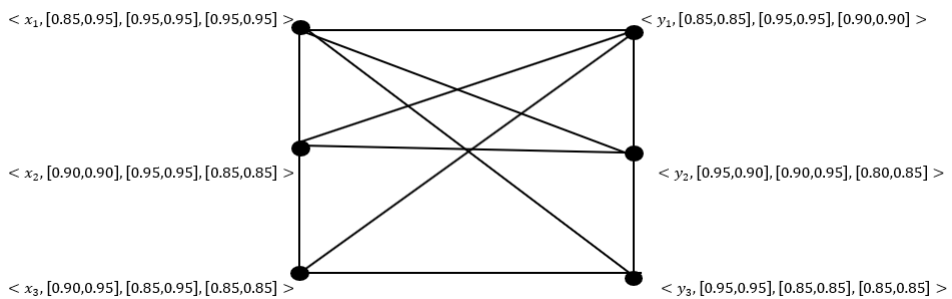

Figure 14. Join of Interval – valued Fermatean Neutrosophic Graphs $G_1 + G_2$

$E(G_1 + G_2)$:

$$\begin{aligned} &< x_1x_2, [0.85,0.90], [0.95,0.95], [0.95,0.95] >, < x_2x_3, [0.90,0.90], [0.95,0.95], [0.85,0.85] > \\ &< y_1y_2, [0.85,0.85], [0.95,0.95], [0.90,0.90] >, < y_2y_3, [0.95,0.90], [0.90,0.95], [0.85,0.85] > \\ &< x_1y_1, [0.85,0.85], [0.95,0.95], [0.95,0.95] >, < x_1y_2, [0.85,0.90], [0.95,0.95], [0.95,0.95] >, \\ &\quad < x_1y_3, [0.85,0.95], [0.95,0.95], [0.95,0.95] > \\ &< x_2y_1, [0.85,0.90], [0.95,0.95], [0.90,0.90] >, < x_2y_2, [0.90,0.90], [0.95,0.95], [0.85,0.85] >, \\ &\quad < x_2y_3, [0.90,0.90], [0.95,0.95], [0.85,0.85] > \\ &< x_3y_1, [0.85,0.85], [0.95,0.95], [0.90,0.90] >, < x_3y_2, [0.90,0.90], [0.90,0.95], [0.85,0.85] >, \\ &\quad < x_3y_3, [0.90,0.95], [0.85,0.95], [0.85,0.85] > \end{aligned}$$

Definition 3.16.

An interval valued Fermatean neutrosophic graph $G = (A, B)$ is called complete if

$$\begin{aligned}
 T_B^-(\{v_i, v_j\}) &= \min[T_A^-(v_i), T_A^-(v_j)], T_B^+(\{v_i, v_j\}) = \min[T_A^+(v_i), T_A^+(v_j)] \\
 I_B^-(\{v_i, v_j\}) &= \max[I_B^-(v_i), I_B^-(v_j)], I_B^+(\{v_i, v_j\}) = \max[I_B^+(v_i), I_B^+(v_j)] \\
 F_B^-(\{v_i, v_j\}) &= \max[F_B^-(v_i), F_B^-(v_j)], F_B^+(\{v_i, v_j\}) = \max[F_B^+(v_i), F_B^+(v_j)]
 \end{aligned}$$

Definition 3.17.

Let $G = (A, B)$ be an interval-valued Fermatean neutrosophic graph where $A = \langle [T_A^-, T_A^+], [I_A^-, I_A^+], [F_A^-, F_A^+] \rangle$ is an interval-valued Fermatean neutrosophic set on V ; and $B = \langle [T_B^-, T_B^+], [I_B^-, I_B^+], [F_B^-, F_B^+] \rangle$ is an interval valued Fermatean neutrosophic relation on E satisfying $V = \{v_1, v_2, \dots, v_n\}$, such that $T_A^- : V \rightarrow [0, 1]$, $T_A^+ : V \rightarrow [0, 1]$, $I_A^- : V \rightarrow [0, 1]$, $I_A^+ : V \rightarrow [0, 1]$ and $F_A^- : V \rightarrow [0, 1]$, $F_A^+ : V \rightarrow [0, 1]$ denote the degree of truth-membership, the degree of indeterminacy-membership and falsity-membership of the element $y \in V$, respectively. The positive degree of a vertex $u \in V(G)$ is $T^+(u) = \sum_{uv \in E(G)} [T_A^+]$; $I^+(u) = \sum_{uv \in E(G)} [I_A^+]$; $F^+(u) = \sum_{uv \in E(G)} [F_A^+]$ and $d^+(u) = (T_A^+, I_A^+, F_A^+)$. $T^-(u) = \sum_{uv \in E(G)} [T_A^-]$; $I^-(u) = \sum_{uv \in E(G)} [I_A^-]$; $F^-(u) = \sum_{uv \in E(G)} [F_A^-]$ and $d^-(u) = (T_A^-, I_A^-, F_A^-)$. The degree of a vertex u is $d(u) = [d^+(u), d^-(u)]$.

If $d^+(u) = k_1, d^-(u) = k_2$ for all $u \in V$, k_1, k_2 are two real numbers, then the graph is called $[k_1, k_2]$ -regular interval valued Fermatean neutrosophic graph.

Example 3.18.

We consider an interval-valued Fermatean neutrosophic graph.

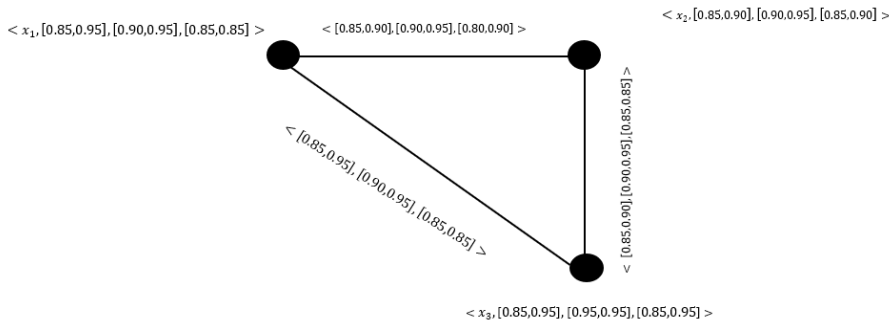

Figure 15. Interval- valued Fermatean Neutrosophic Graph G

$$\begin{aligned}
 d(x_1) &= ([1.65, 1.80, 1.65], [1.85, 1.90, 1.70]); \\
 d(x_2) &= ([1.65, 1.8, 1.65], [1.8, 1.9, 1.7]); \quad d(x_3) = ([1.7, 1.8, 1.7], [1.85, 1.9, 1.7]).
 \end{aligned}$$

4. Proposed IVFNG framework for MCDM problem

The most of real life problems deal with uncertain domain. Recently, researchers (Sriganesh et al. 2021; Sundareswaran et al. 2022) have been studied the assessment of structural cracks in buildings using single-valued neutrosophic DEMATEL model and graph theoretical approach. The new concepts of IVFNG are employed to find the best materials that are used for making dental implants in the case of smokers. There are many researchers developed and studied different types uncertainty sets and their application in Multi-Criteria Decision- Making (MCDM) (Duran et al., 2021; Ejegwa et al. 2022; Mohanta et al., 2020; Li et al., 2022; Smarandache, 2020; Smarandache, 2022; Wang et al., 2022; Zhang et al., 2022). Mahesh et al. (2022), made a comparative study

of Dental Implant Materials Using Digraph Techniques. Dental implants are the most popular option to replace missing teeth. They create direct contact with the bone which mimics the root of the tooth, upon which dental prosthesis can be fitted. These implants are designed in such a way that they can last for a long time without any failure. They get adhered to the bone without intervening in any connective tissue and this phenomenon is known as osseointegration. Titanium is considered the gold standard as it is the most commonly used dental implant material in use since the 1960s Zirconia is a non-metallic alternative to metal dental implants like *Ti alloy (Ti – 6Al – 4V)* and *Ti* alloys.

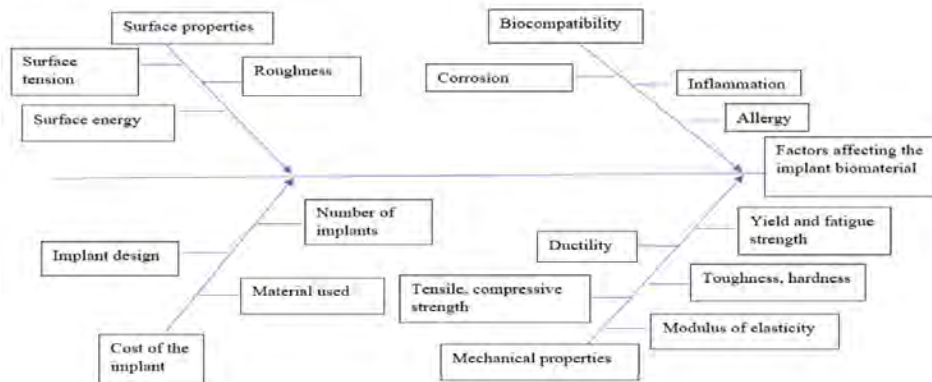

Figure 16. Fishbone diagram with the various factors and subfactors

In this section, the concept of Interval-valued Fermatean neutrosophic graph-theoretic approach has been used to selection of material. The condition of osseointegration in smokers is taken into consideration to compare the different material dental implants namely *Ti alloy (Ti – 6Al – 4V)*, *Ti* alloy, and zirconia. The material to be chosen should exhibit certain properties to satisfy the purpose. While designing a dental implant, many factors come into consideration such as materials, dimensions, shape, etc. Material selection is the most important property for a dental implant to serve the required function. The material of the implant must be affordable and available. Following are the factors that are important for the selection of the material.

Biocompatibility (B): A biocompatible material does not invoke an immune response and does not release any toxic substances. The major subfactors of biocompatibility are corrosion, inflammation, and allergy.

Surface Properties (S): Surface properties refer to macroscopic and microscopic features of the implant surface and it plays a major role in determining the level of osseointegration between the implant and the bone. The major subfactors of surface properties are Surface Tension and Surface Energy, Surface Roughness, Porosity.

Mechanical Properties(M): The implant biomaterial should possess a high degree of modulus of elasticity, to withstand the forces applied to the implant, thus preventing its deformation. It also ensures uniform stress distribution, thus reducing the implant movement concerning the bone.

Cost (C): Dental implants in India range from 30,000-50,000 rupees. The price depends on many factors like the type of tooth implant, material, and design of the implant, etc. Titanium is more expensive than stainless steel. The cost of titanium is slightly lower than zirconia.

Titanium (M_1) and Titanium Alloys (M_2): Titanium is an excellent corrosion-resistant material due to the formation of *Ti alloy* ($Ti - 6Al - 4V$) when *Ti* atoms react with water molecules and oxygen. They show excellent biocompatibility properties and support osseointegration. Titanium-based dental implants are strong and resist fracture. The cost of titanium is slightly lower than the zirconia. However, titanium implants are less aesthetically pleasing than zirconia and hence they are not preferable to use in the case of front teeth implant placement. Zirconia could be preferred in this case due to its ivory color.

Zirconia (M_3): Zirconia is a non-metallic alternative to metal dental implants like Ti. An advantage of zirconia over titanium is its ivory color. Its low modulus of elasticity and thermal conductivity, low affinity to plaque, and high biocompatibility, in addition to its white color, have made zirconia ceramics a very attractive alternative to titanium. It is highly corrosion resistant and does not involve any release of ions hence no cytotoxicity.



Figure 17. Types of Dental Implants

In the process of applying IVFNG in identifying the best material. IVFNG can be represented as a matrix whose rows and columns are the sub-factors. $V = \{M_1, M_2, M_3\}$ be the three different material under the selection on the basis of wishing parameters or attributes set $A = \{B, S\}$.

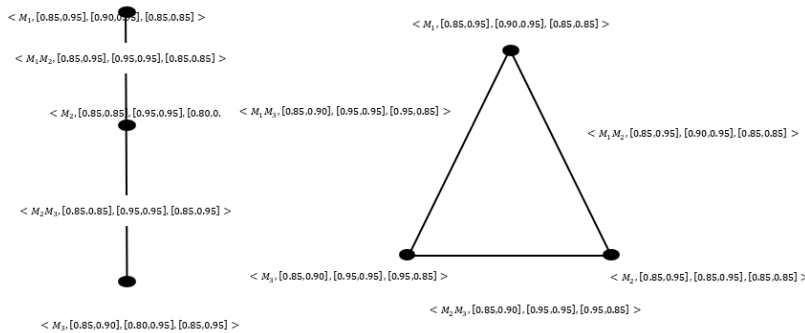

Figure 18. IVFNG based on Biocompatibility & Surface Properties

We construct the adjacency matrix for $M(B)$, $M(S)$ listed below:

$$M(B) = \begin{pmatrix} < [0, 0], [0, 0], [0, 0] > & < [0.85, 0.95], [0.95, 0.95], [0.85, 0.85] > & < [0, 0], [0, 0], [0, 0] > \\ < [0.85, 0.95], [0.95, 0.95], [0.85, 0.85] > & < [0, 0], [0, 0], [0, 0] > & < [0.85, 0.85], [0.95, 0.95], [0.85, 0.95] > \\ < [0, 0], [0, 0], [0, 0] > & < [0.85, 0.85], [0.95, 0.95], [0.85, 0.95] > & < [0, 0], [0, 0], [0, 0] > \end{pmatrix}$$

$$M(S) = \begin{pmatrix} < [0, 0], [0, 0], [0, 0] > & < [0.85, 0.95], [0.90, 0.95], [0.85, 0.85] > & < [0.85, 0.90], [0.95, 0.95], [0.95, 0.85] > \\ < [0.85, 0.95], [0.90, 0.95], [0.85, 0.85] > & < [0, 0], [0, 0], [0, 0] > & < [0.85, 0.90], [0.95, 0.95], [0.95, 0.85] > \\ < [0.85, 0.90], [0.95, 0.95], [0.95, 0.85] > & < [0.85, 0.90], [0.95, 0.95], [0.95, 0.85] > & < [0, 0], [0, 0], [0, 0] > \end{pmatrix}$$

We obtain the resultant interval valued Fermatean neutrosophic graph G by performing some operation (AND or OR). The incidence matrix of resultant interval Fermatean neutrosophic graph is

$$M(B) = \begin{pmatrix} \langle [0, 0], [0, 0], [0, 0] \rangle & \langle [0.85, 0.95], [0.95, 0.95], [0.85, 0.85] \rangle & \langle [0, 0], [0, 0], [0, 0] \rangle \\ \langle [0.85, 0.95], [0.95, 0.95], [0.85, 0.85] \rangle & \langle [0, 0], [0, 0], [0, 0] \rangle & \langle [0.85, 0.85], [0.95, 0.95], [0.95, 0.95] \rangle \\ \langle [0, 0], [0, 0], [0, 0] \rangle & \langle [0.85, 0.85], [0.95, 0.95], [0.95, 0.95] \rangle & \langle [0, 0], [0, 0], [0, 0] \rangle \end{pmatrix}$$

Sahin (2015) defined the average possible membership degree of element x to interval valued neutrosophic set

$A = \langle [T_A^-(x), T_A^+(x)], [I_A^-(x), I_A^+(x)], [F_A^-(x), F_A^+(x)] \rangle$ as follows:

$$S_k(x) = \frac{T_A^-(x) + T_A^+(x) + 4 - I_A^-(x) - I_A^+(x) - F_A^-(x) - F_A^+(x)}{6}$$

Based on $S_k(x)$, Table 2 depicted the score value of adjacency matrix of resultant interval valued Fermatean neutrosophic graph G with S_k and choice value for both materials.

Table 2. Score value of adjacency matrix

Materials	M_1	M_2	M_3	Overall
M_1	0	0.383	0	0.383
M_2	0.383	0	0.317	0.7
M_3	0	0.317	0	0.317

Further, it is noticed from Table 2, Ti alloy ($Ti - 6Al - 4V$) has higher level of osseointegration in smokers followed by Ti and zirconia. Therefore, we may claim that IVFNG is a new way to tackle the uncertainty in Fermatean Neutrosophic environment.

5. Conclusion

The concept of uncertainty plays a vital role in all science and engineering problems. Especially, Fuzzy theory, Intuitionistic fuzzy theory and then Neutrosophic theory are the most valuable tools to find the optimum solution in mutli-criteria decision making problems. In this work, we include one more concept called interval-valued Fermatean neutrosophic graphs in the list which has Pythagorean Neutrosophic, Single Valued Neutrosophic, Bipolar Neutrosophic graphs. We have discussed various types of Interval-valued Fermatean Neutrosophic graphs and the other types of these graphs in this paper. We also apply this new type of graph in a decision making problem. We are extending our research on this new concept to introduce Interval-valued Fermatean Neutrosophic number and Interval-valued Fermatean triangle and trapezoidal Neutrosophic number and its applications in our future work.

Interval-valued Fermatean Neutrosophic graph has many advantages in MCDM problems such as mobile networking, supply chain management system, bio-medical applications, e-waste management and networking, etc. In future, one may determine the optimum alternatives in MCDM problems using IVFNG based score and accuracy functions.

Acknowledgments: The authors would like to thank the management of Sri Sivasubramaniya Nadar College of Engineering for giving the needed facilities to complete this research work.

References

- Ajay, D., & Chellamani, P. (2020). Pythagorean Neutrosophic Fuzzy Graphs. *International Journal of Neutrosophic Science*, 11, 108-114.
- Ajay, D., Karthiga, S., & Chellamani, P. (2021). A study on labelling of pythagorean neutrosophic fuzzy graphs. *Journal of Computational Mathematica*, 5, 105–116.
- Ajay, D., Chellamani, P., Rajchakit, G., Boonsatit, N., & Hammachukiattikul, P. (2022). Regularity of Pythagorean neutrosophic graphs with an illustration in MCDM. *AIMS Mathematics*, 7, 9424–9442.
- Ajay, D., & Chellamani, P. (2021). Pythagorean Neutrosophic Dombi Fuzzy Graphs with an Application to MCDM. *Neutrosophic Sets and Systems*, 47, 411-431.
- Akalyadevia, K., Antony Crispin Sweetey, C., & Sudamani Ramaswamy, A. R. (2022). Spherical neutrosophic graph coloring. *AIP Conference Proceedings*, 2393, 020217.
- Atanassov, K.T. (1986). Intuitionistic fuzzy sets. *Fuzzy Sets System*, 20, 87–96.
- Aydın, S., & Kutlu Gündoğdu, F. (2021). Interval-Valued Spherical Fuzzy MULTIMOORA Method and Its Application to Industry 4.0. In: Kahraman, C., Kutlu Gündoğdu, F. (eds) *Decision Making with Spherical Fuzzy Sets. Studies in Fuzziness and Soft Computing*, 392. Springer, Cham.
- Broumi, S., Talea, M., Bakali, A., & Smarandache, F. (2016). Single valued neutrosophic graphs. *Journal of New Theory*, 10, 86-101.
- Broumi, S., Bakali, A., Talea, M., & Smarandache, F. (2016a). Isolated single valued neutrosophic graphs. *Neutrosophic Sets Systems*, 11, 74–78.
- Broumi, S., Smarandache, F., Talea, M., & Bakali, A. (2016b). An introduction to bipolar single valued neutrosophic graph theory. *Applied Mechanics and Materials*, 841, 184–191.
- Broumi, S., Talea, M., Bakali, A., & Smarandache, F. (2016c). On bipolar single valued neutrosophic graphs. *New Trends in Neutrosophic Theory and Applications*, 11, 203-221.
- Broumi, S., Mohamed Tale., Assia Bakali., & Smarandache, F. (2016d). Interval Valued Neutrosophic Graphs. *Critical Review*, Volume XII.

Broumi, S., Sundareswaran, R., Shanmugapriya, M., Bakali, A. & Talea, M. (2022). Theory and Applications of Fermatean Neutrosophic Graphs. *Neutrosophic Sets and Systems*, 50, 248-286.

Donghai Liu., Yuanyuan Liu., & Lizhen Wang. (2019). Distance measure for Fermatean fuzzy linguistic term sets based on linguistic scale function: An illustration of the TODIM and TOPSIS methods. *Journal of Intelligent Systems*, 1–28.

Duran, V., Topal, S., & Smarandache, F. (2021). An application of neutrosophic logic in the confirmatory data analysis of the satisfaction with life scale. *Journal of Fuzzy Extension and Applications*, 2(3), 262-282.

Duleba, S., Kutlu Gündoğdu, F., & Moslem, S. (2021). Interval-Valued Spherical Fuzzy Analytic Hierarchy Process Method to Evaluate Public Transportation Development. *Informatica*, 32(4), 661-686.

Ejegwa, P., & Zuakwagh, D. (2022). Fermatean fuzzy modified composite relation and its application in pattern recognition. *Journal of Fuzzy Extension and Applications*, 3(2), 140-151.

Ganie, A. H. (2022). Multicriteria decision-making based on distance measures and knowledge measures of Fermatean fuzzy sets. *Granular Computing*, 1-20.

Hossein Rashmanlou., & Young Bae Jun. (2013). Complete interval-valued fuzzy graphs. *Annals of Fuzzy Mathematics and Informatics*, 6(3), 677–687.

Jeevaraj, S. (2021). Ordering of interval-valued Fermatean fuzzy sets and its applications. *Expert Systems with Applications*, 185, 115613.

Jun, Y.B., Smarandache, F., & Kim, C.S. (2017). Neutrosophic Cubic sets. *New Mathematics and Natural Computation*, 13, 41–54.

Kartick Mohanta, Arindam Dey & Anita Pal. (2020). A Study on Picture Dombi Fuzzy Graph. *Decision Making: Applications in Management and Engineering*, 3(2), 119-130.

Kutlu Gündoğdu, F., & Kahraman, C. (2021). Hospital Performance Assessment Using Interval-Valued Spherical Fuzzy Analytic Hierarchy Process. In: Kahraman, C., Kutlu Gündoğdu, F. (eds) *Decision Making with Spherical Fuzzy Sets. Studies in Fuzziness and Soft Computing*, vol 392. Springer, Cham.

Kutlu Gündoğdu, F., & Kahraman, C. (2019). A novel fuzzy TOPSIS method using emerging interval-valued spherical fuzzy sets. *Engineering Applications of Artificial Intelligence*, 85, 307–323.

Lakhwani, T.S., Mohanta, K., & Dey, A. (2022). Some operations on Dombi neutrosophic graph. *Journal of Ambient Intelligence and Humanized Computing*, 13, 425–443.

Lathamaheswari, M., Nagarajan, D., Garg, H., & Kavikumar, J. (2021). Interval Valued Spherical Fuzzy Aggregation Operators and Their Application in Decision Making Problem. In: Kahraman, C., Kutlu Gündoğdu, F. (eds) *Decision Making with Spherical Fuzzy Sets. Studies in Fuzziness and Soft Computing*, 392. Springer, Cham.

Li, J., Alburaihan, A. & de Fátima Muniz, R. (2022), Evaluation of safety-based performance in construction projects with neutrosophic data envelopment analysis, *Management Decision*, Vol. ahead-of-print No. ahead-of-print. <https://doi.org/10.1108/MD-02-2022-0237>

Mahesh, V., Sundareswaran, R., Nikileswari, L., Varsha, S., & Harsha, B. Comparative Study of Dental Implant Materials Using Digraph Techniques. AIP Conference Proceedings, (accepted for publication).

Mishra, S. N. & Pal, A. (2013). Product of interval-valued intuitionistic fuzzy graph. *Annals of Pure and Applied Mathematics*, 5(1), 37–46.

Mohamed Ismayil, A. & Mohamed Ali, A. (2014). On Strong Interval-Valued Intuitionistic Fuzzy Graph. *International Journal of Fuzzy Mathematics and Systems*, 4(2), 161-168.

Mohamed S.Y., & Ali A.M. (2018). Interval-valued Pythagorean fuzzy graph. *Journal of Computer and Mathematical Sciences*, 9(10), 1497-1511.

Muhammad Akram., Noura Omair Alshehri., & Wieslaw A. Dudek. (2013). Certain Types of Interval-Valued Fuzzy Graphs. *Journal of Applied Mathematics*, 857070, 1-11.

Nagarajan, D., Lathamaheswari, M., Broumi, S., & Kavikumar, J. (2019). Dombi interval valued neutrosophic graph and its role in traffic control management. *Neutrosophic Sets and Systems*, 124, 114-133.

Peng Xu., Hao Guan., Talebi, A. A., Ghassemi, M., & Hossein Rashmanlou. (2022). Certain Concepts of Interval-Valued Intuitionistic Fuzzy Graphs with an Application. *Advances in Mathematical Physics*, 6350959, 1-12.

Polymenis, A. (2021). A neutrosophic Student's t -type of statistic for AR (1) random processes. *Journal of Fuzzy Extension and Applications*, 2(4), 388-393.

Sanapati, T., & Yager. R. Yager. (2019). Fermatean Fuzzy Sets. *Journal of Ambient Intelligence and Humanized Computing*, 11, 663-674.

Şahin, R. (2015). Cross-entropy measure on interval neutrosophic sets and its applications in multicriteria decision making. *Neural Computing and Applications*, 1-11.

Smarandache, F. (2019). Neutrosophic Set is a Generalization of Intuitionistic Fuzzy Set, Inconsistent Intuitionistic Fuzzy Set (Picture Fuzzy Set, Ternary Fuzzy Set), Pythagorean Fuzzy Set (Atanassov's Intuitionistic Fuzzy Set of second type), q -Rung Orthopair Fuzzy Set, Spherical Fuzzy Set, and n -Hyper Spherical Fuzzy Set, while Neutrosophication is a Generalization of Regret Theory, Grey System Theory, and Three-Ways Decision (revisited), *Journal of New Theory*. 29, 01-35.

Smarandache, F. (2017). Spherical Neutrosophic Numbers, in the book *Neutrosophic Perspectives: Triplets, Duplets, Multisets, Hybrid Operators, Modal Logic, Hedge Algebras. And Applications*, Second extended and improved edition. Pons Publishing House Brussels. Section II.2, 28-29.

Smarandache, F. (2020). Generalizations and alternatives of classical algebraic structures to neutroAlgebraic structures and antiAlgebraic structures. *Journal of Fuzzy Extension and Applications*, 1(2), 81-83.

Smarandache, F. (2022). Plithogeny, Plithogenic Set, Logic, Probability and Statistics: A Short Review.

Stephen, S., & Helen, M. (2021). Interval-valued Neutrosophic Pythagorean Sets and their Application Decision Making using IVNP-TOPSIS. *International Journal of Innovative Research in Science. Engineering and Technology*, 10 (1), 14571- 14578.

Sriganesh, R., Sundareswaran, R., Shanmugapriya, M., & Pandikumar, M. (2021). A Study of power plant selection process – A graph theoretic approach. *Journal of Physics.: Conference Series*, 1921, 012081.

Sundareswaran R., Sangeetha, P., Shanmugapriya, M., Thaga Sheriff, M., Benasir, M., Shri Thrisha, A., & Sathyaprakash, R. Assessment of structural cracks in buildings using single-valued neutrosophic DEMATEL model, <https://doi.org/10.1016/j.matpr.2022.04.156>, *Materials Today: Proceedings* (accepted for publication).

Wang, C., Hu, Z. & Bao, Z. (2022), Evaluation of the government entrepreneurship support by a new dynamic neutrosophic operator based on time degrees. *Management Decision*, 2022-0305.

Xindong P., & Yong Y. (2016). Fundamental properties of interval-valued Pythagorean fuzzy Aggregation Operators. *International Journal of Intelligent Systems*, 31, 444–487.

Yahya, S., Mohamed & Mohamed Ali, A. (2018). On Strong Interval-valued Pythagorean Fuzzy Graph. *Journal of Applied Science and Computations*, 5(10), 699- 713.

Zadeh, L. A. (1965). Fuzzy sets. *Information and control*, 8, 338 - 353.

Zhang, K., Xie, Y., Noorkhah, S.A., Imeni, M. and Das, S.K. (2022), Neutrosophic management evaluation of insurance companies by a hybrid TODIM-BSC method: a case study in private insurance companies, *Management Decision*, Vol. ahead-of-print No. ahead-of-print. <https://doi.org/10.1108/MD-01-2022-0120>

SUPERHYPERGRAPHS

Introduction to the n-SuperHyperGraph - the most general form of graph today

Florentin Smarandache

Florentin Smarandache (2022). Introduction to the n-SuperHyperGraph - the most general form of graph today. *Neutrosophic Sets and Systems* 48, 483-485

Abstract: We recall and improve our 2019 and 2020 concepts of *n-SuperHyperGraph*, *Plithogenic n-SuperHyperGraph*, *n-Power Set of a Set*, and we present some application from the real world. The n-SuperHyperGraph is the most general form of graph today and it is able to describe the complex reality we live in, by using n-SuperVertices (groups of groups of groups etc.) and n-SuperHyperEdges (edges connecting groups of groups of groups etc.).

Keywords: n-SuperHyperGraph (n-SHG), n-SHG-vertex, n-SHG-edge, Plithogenic (Crisp, Fuzzy, Intuitionistic Fuzzy, Neutrosophic, etc.) n-SuperHyperGraph, n-Power Set of a Set, MultiEdge, Loop, Indeterminate Vertex, Null Vertex, Indeterminate Edge, Null Edge, Neutrosophic Directed Graph

1. Definition of the n-SuperHyperGraph

Let $V = \{v_1, v_2, \dots, v_m\}$, for $1 \leq m \leq \infty$, be a set of vertices, that contains Single Vertices (the classical ones), Indeterminate Vertices (unclear, vague, partially known), and Null Vertices (totally unknown, empty).

Let $P(V)$ be the power of set V , that includes the empty set \emptyset too.

Then $P^n(V)$ be the n -power set of the set V , defined in a recurrent way, i.e.:

$$P(V), P^2(V) = P(P(V)), P^3(V) = P(P^2(V)) = P(P(P(V))), \dots,$$

$$P^n(V) = P(P^{n-1}(V)), \text{ for } 1 \leq n \leq \infty, \text{ where by definition } P^0(V) \stackrel{def}{=} V.$$

Then, the **n-SuperHyperGraph (n-SHG)** is an ordered pair:

$$\text{n-SHG} = (G_n, E_n),$$

where $G_n \subseteq P^n(V)$, and $E_n \subseteq P^n(V)$, for $1 \leq n \leq \infty$.

G_n is the set of vertices, and E_n is the set of edges.

The set of vertices G_n contains the following types of vertices:

- Singles Vertices (the classical ones);
- Indeterminate Vertices (unclear, vagues, partially unknown);
- Null Vertices (totally unknown, empty);

and:

- SuperVertex (or SubsetVertex), i.e. two or more (single, indeterminate, or null) vertices put together as a group (organization).
- n-SuperVertex that is a collection of many vertices such that at least one is a $(n - 1)$ -SuperVertex and all other r -SuperVertices into the collection, if any, have the order $r \leq n - 1$.
- The set of edges E_n contains the following types of edges:
- Singles Edges (the classical ones);

- Indeterminate Edges (unclear, vagues, partially unknown);
 - Null Edges (totally unknown, empty);
- and:
- HyperEdge (connecting three or more single vertices);
 - SuperEdge (connecting two vertices, at least one of them being a SuperVertex);
 - n-SuperEdge (connecting two vertices, at least one being a n-SuperVertex, and the other of order r-SuperVertex, with $r \leq n$);
 - SuperHyperEdge (connecting three or more vertices, at least one being a SuperVertex);
 - n-SuperHyperEdge (connecting three or more vertices, at least one being a n-SuperVertex, and the other r-SuperVertices with $r \leq n$);
 - MultiEdges (two or more edges connecting the same two vertices);
 - Loop (and edge that connects an element with itself).
- and:
- Directed Graph (classical one);
 - Undirected Grpah (classical one);
 - Neutrosophic Directed Graph (partially directed, partially undirected, partially indeterminate direction).

2. SuperHyperGraph

When $n = 1$ we call the 1-SuperHyperGraph simply **SuperHyperGraph**, because only the first power set of V is used, P(V).

3. Examples of 2-SuperHyperGraph, SuperVertex, IndeterminateVertex, SingleEdge, Indeterminate Edge, HyperEdge, SuperEdge, MultiEdge, 2-SuperHyperEdge [2]

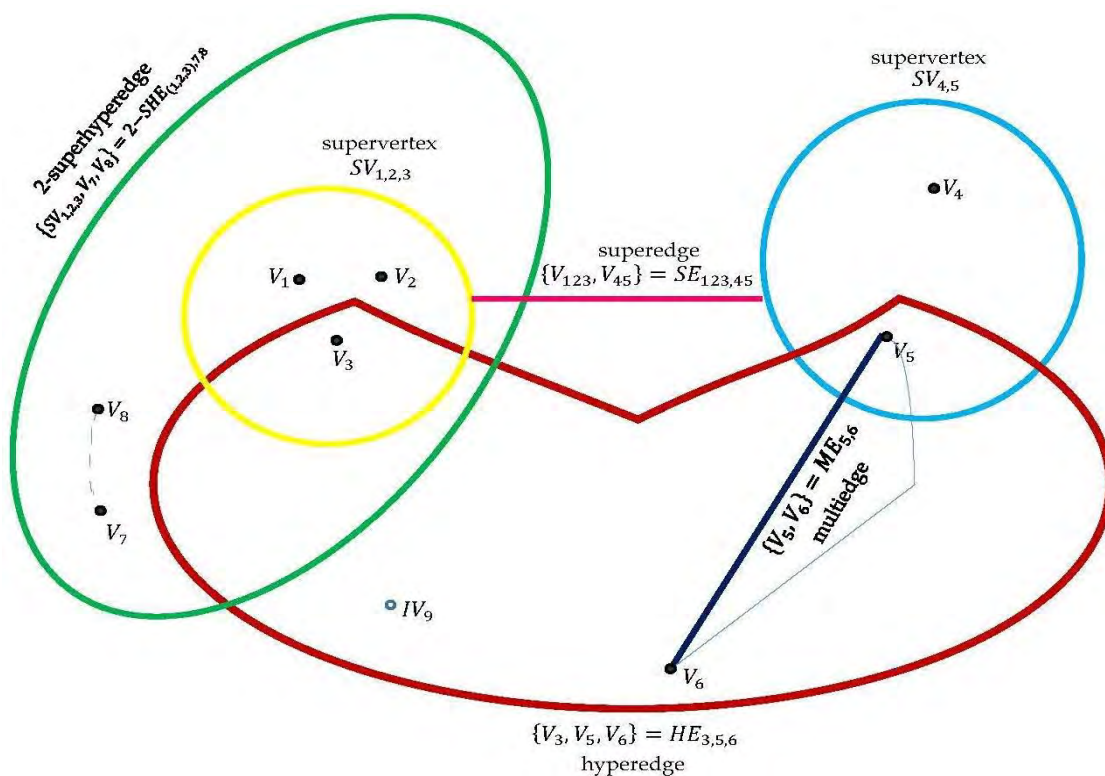

$IE_{7,8}$ is an Indeterminate Edge between single vertices V_7 and V_8 , since the connecting curve is dotted;

IV_9 is an Indeterminate Vertex (since the dot is not filled in); while $ME_{5,6}$ is a MultiEdge (double edge in this case) between single vertices V_5 and V_6 .

4. Types of n-SuperHyperGraphs

The attributes values degrees of appurtenance of a vertex or an edge to the graph may be: crisp / fuzzy / intuitionistic fuzzy / picture fuzzy / spherical fuzzy / etc. / neutrosophic / refined neutrosophic / degrees with respect to each *n-SHG-vertex* and to each *n-SHG-edge* respectively.

For example, one has:

5. Plithogenic n-SuperHyperGraph

We recall the Plithogenic n-SuperHyperGraph.

A *Plithogenic n-SuperHyperGraph (n-PSHG)* is a n-SuperHyperGraph whose each *n-SHG-vertex* and each *n-SHG-edge* are characterized by many distinct attributes values (a_1, a_2, \dots, a_p) , $p \geq 1$.

Therefore one gets n-SHG-vertex(a_1, a_2, \dots, a_p) and n-SHG-edge(a_1, a_2, \dots, a_p).

6. Plithogenic Fuzzy-n-SHG-vertex $(a_1(t_1), a_2(t_2), \dots, a_p(t_p))$

and Fuzzy-n-SHG-edge($a_1(t_1), a_2(t_2), \dots, a_p(t_p)$);

7. Plithogenic Intuitionistic Fuzzy-n-SHG-vertex $(a_1(t_1, f_1), a_2(t_2, f_2), \dots, a_p(t_p, f_p))$

and Intuitionistic Fuzzy-n-SHG-edge($a_1(t_1, f_1), a_2(t_2, f_2), \dots, a_p(t_p, f_p)$);

8. Plithogenic Neutrosophic-n-SHG-vertex $(a_1(t_1, i_1, f_1), a_2(t_2, i_2, f_2), \dots, a_p(t_p, i_p, f_p))$

and Neutrosophic-n-SHG-edge ($a_1(t_1, i_1, f_1), a_2(t_2, i_2, f_2), \dots, a_p(t_p, i_p, f_p)$);

etc.

Whence in general we get:

9. The Plithogenic (Crisp / Fuzzy / Intuitionistic Fuzzy / Picture Fuzzy / Spherical Fuzzy / etc. / Neutrosophic / Refined Neutrosophic) n-SuperHyperGraph

10. Conclusions

The n-SuperHyperGraph is the most general for of graph today, designed in order to catch our complex real world.

First, the SuperVertex was introduced in 2019, then the SuperHyperGraph constructed on the power set $P(V)$, and further on this was extended to the n-SuperHyperGraph built on the n-power set of the power set, $P^n(V)$, in order to overcome the complex groups of individuals and the sophisticated connections between them.

References

1. Florentin Smarandache, n-SuperHyperGraph and Plithogenic n-SuperHyperGraph, in *Nidus Idearum*, Vol. 7, second and third editions, Pons, Bruxelles, pp. 107-113, 2019, <http://fs.unm.edu/NidusIdearum7-ed3.pdf>.
2. Florentin Smarandache, Extension of HyperGraph to n-SuperHyperGraph and to Plithogenic n-SuperHyperGraph, and Extension of HyperAlgebra to n-ary (Classical-/Neutro-/Anti-) HyperAlgebra, *Neutrosophic Sets and Systems*, vol. 33, 2020, pp. 290-296. DOI: 10.5281/zenodo.3783103, <http://fs.unm.edu/NSS/n-SuperHyperGraph-n-HyperAlgebra.pdf> (accessed 02/13/2022).

Introduction to Neutrosophic Restricted SuperHyperGraphs and Neutrosophic Restricted SuperHyperTrees and several of their properties

Masoud Ghods, Zahra Rostami, Florentin Smarandache

Masoud Ghods, Zahra Rostami, Florentin Smarandache (2022). Introduction to Neutrosophic Restricted SuperHyperGraphs and Neutrosophic Restricted SuperHyperTrees. *Neutrosophic Sets and Systems* 50, 480-487

Abstract: In this article, we first provide a modified definition of SuperHyperGraphs (SHG) and we call it Restricted SuperHyperGraphs (R-SHG). We then generalize the R-SHG to the neutrosophic graphs and then define the corresponding trees. In the following, we examine the Helly property for subtrees of SuperHyperGraphs.

Keywords: SuperHyperGraphs; Restricted SuperHyperGraphs; Neutrosophic SuperHyperGraphs; Neutrosophic SuperHyperTrees; Helly property; chordal graph; subtree.

1. Introduction

Hypergraph theory is one of the most widely used theories in modeling large and complex problems. In recent years, many efforts have been made to find different properties of these graphs [1-5]. One of these features that is also very important is the property of Helly. To read more about this property, you can refer to [4, 5]. Here we first rewrite the definition of SuperHyperGraphs from [1], which has the advantage that we have reduced the empty set from the set of vertices because in practice the empty vertex is not much applicable, and we have also categorized the set of vertices and edges according to its type. Then the adjacency matrix. We define the incidence matrix and the Laplacian matrix.

Obviously, if a super hyper power graph contains a triangle, it will not have a highlight feature. We show here that some defined super hyper power graphs have subtrees that have Helly property. There are algorithms for detecting Helly property in subtrees that the reader can refer to [4] to view.

In graph theory, a chordal graph is a graph in which each cycle is four or more lengths and contains at least one chord. In other words, each induction cycle in these graphs has a maximum of three vertices. Chord graphs have unique features and applications. To study an example of the applications of chordal graphs, you can refer to [7].

Definition 1 [4]. Let A be a set. We say that A has Helly property if and only if, for every non-empty set S such that $S \subseteq A$ and for all sets x, y such that $x, y \in S$ holds x meets y holds $\cap S \neq \emptyset$.

Proposition 1 [4]. Let T be a tree and X be a finite set such that for every set x such that $x \in X$ there exists a subtree t of T such that x is equal the vertices of t . Then X has Helly property.

2. Neutrosophic Restricted SuperHyperGraphs

In this section, we provide a modified definition of Restricted SuperHyperGraphs (RSHG), and then generalize this definition to neutrosophic graphs.

Definition 2. SuperHyperGraph (SHG)[1]

A Super Hyper Graph (SHG) is an ordered pair $SHG = (X \subseteq P(V) \setminus \emptyset, E \subseteq P(V) \times P(V))$, where

- i. $V = \{v_1, v_2, \dots, v_n\}$ is a finite set of $n \geq 0$ vertices, or an infinite set.
- ii. $P(V)$ is the power set of V (all subset of V). therefore, an SHG-vertex may be a **single** (classical) **vertex** (V_{Si}), or a **super-vertex** (V_{Su}) (a subset of many vertices) that represents a group (organization), or even an **indeterminate-vertex** (V_i) (unclear, unknown vertex);
- iii. $E = \{e_1, e_2, \dots, e_m\}$, for $m \geq 1$, is a family of subsets of $V \times V$, and each e_i is an SHG –edge, $e_i \in P(V) \times P(V)$. An SHG –edge may be a (classical) **edge**, or a **super-edge** (edge between super vertices) that represents connections between two groups (organizations), or **hyper-super-edge** that represents connections between three or more groups (organizations), or even an **indeterminate-edge** (unclear, unknown edge); \emptyset represents the null-edge (edge that means there is no connection between the given vertices).

Definition 2-1(2-Restricted SuperHyperGraphs)

2-Restricted SuperHyperGraphs are a special case of SuperHyperGraphs, where we look at the system from the part to the whole. So, according to definition 2, we have

1. Single Edges (E_{Si}), as in classical graphs.
2. Hyper Edges (E_H), edges connecting three or more single- vertices.
3. Super Edges (E_{Su}), edges connecting only two SHG- vertices and at least one vertex is super Vertex.
4. Hyper Super Edges (E_{HS}), edges connecting three or more single- vertices (and at least one vertex is super vertex).
5. Indeterminate Edges (E_I), either we do not know their value, or we do not know what vertices they might connect.

Then, $G = (X, E)$ where $X = (V_{Si}, V_{Su}, V_i) \subseteq P(V) \setminus \emptyset$, and $E = (E_{Si}, E_H, E_{Su}, E_{HS}, E_I) \subseteq P(V) \times P(V)$.

Definition 3. (Neutrosophic Restricted SuperHyperGraphs) Let $G = (X, E)$ be a Restricted SuperHyperGraph. If all vertices and edges of G belong to the neutrosophic set, then the SHG is a Neutrosophic Restricted SuperHyperGraphs (NRSHG). If x is a neutrosophic super vertex containing vertices $\{v_1, v_2, \dots, v_k\}$, where $v_i \in V$ for $1 \leq i \leq k$, then

$$\begin{aligned} T_x(x) &= \min\{T_x(v_i), 1 \leq i \leq k\}, \\ I_x(x) &= \min\{I_x(v_i), 1 \leq i \leq k\}, \\ F_x(x) &= \max\{F_x(v_i), 1 \leq i \leq k\}. \end{aligned}$$

Definition 4. Let $G = (X, E)$ be a 2-Restricted SuperHyperGraph, with $X = (V_{Si}, V_{Su}, V_i) \subseteq P(V) \setminus \emptyset$, and $E = (E_{Si}, E_H, E_{Su}, E_{HS}, E_I) \subseteq P(V) \times P(V)$. Then, the **adjacency matrix** $A(G) = (a_{ij})$ of G is defined as a square matrix which columns and rows its, is shown by the vertices of G and for each $v_i, v_j \in X$,

$$a_{ij} = \begin{cases} 0 & \text{there should be no edge between vertices } v_i \text{ and } v_j; \\ 1 & \text{there is a single edge between vertices } v_i \text{ and } v_j; \\ S & \text{there is a super edge between vertices } v_i \text{ and } v_j; \\ H & \text{there is a hyper edge between vertices } v_i \text{ and } v_j; \\ SH & \text{there is a super hyper edge between vertices } v_i \text{ and } v_j. \end{cases}$$

Note that in the adjacency matrix A , a value of one can be placed instead of non-numeric values (S , H and SH) if necessary for calculations. So that, since A is a symmetric and values of A is positive, eigenvalues of A are real.

Definition 5. Let $G = (X, E)$ be a Restricted SuperHyperGraph, with $X = (V_{Si}, V_{Su}, V_i) \subseteq P(V) \setminus \emptyset$, and $E = (E_{Si}, E_H, E_{Su}, E_{HS}, E_I) \subseteq P(V) \times P(V)$. If $E = (e_1, e_2, \dots, e_m)$ then an **incidence matrix** $B(G) = (b_{ij})$ define as

$$b_{ij} = \begin{cases} 1 & \text{if } v_i \in e_j, \\ 0 & \text{otherwise.} \end{cases}$$

Definition 6. Let $G = (X, E)$ be a Restricted SuperHyperGraph, with $X = (V_{Si}, V_{Su}, V_I) \subseteq P(V) \setminus \emptyset$, and $E = (E_{Si}, E_H, E_{Su}, E_{HS}, E_I) \subseteq P(V) \times P(V)$. If $D = \text{diag}(D(v_1), D(v_2), \dots, D(v_n))$ where $D(v_i) = \sum_{v_j \in X} a_{v_i v_j}$, then, a **laplacian matrix** define as $L(G) = D - A(G)$.

Example 1. Consider $G = (X, E)$ as shown in figure 1 (This figure is selected from reference [1]). Where $X = \{V_1, V_2, V_3, V_4, V_5, V_6, V_7, V_8, Iv_9, Sv_{4,5}, Sv_{1,2,3}\}$ and $E = \{SiE_{5,6}, IE_{7,8}, SE_{123,45}, HE_{459,3}, HSE_{123,7,8}\}$. We now obtain the SuperHyperGraph – related matrices in figure 1 using the above definitions.

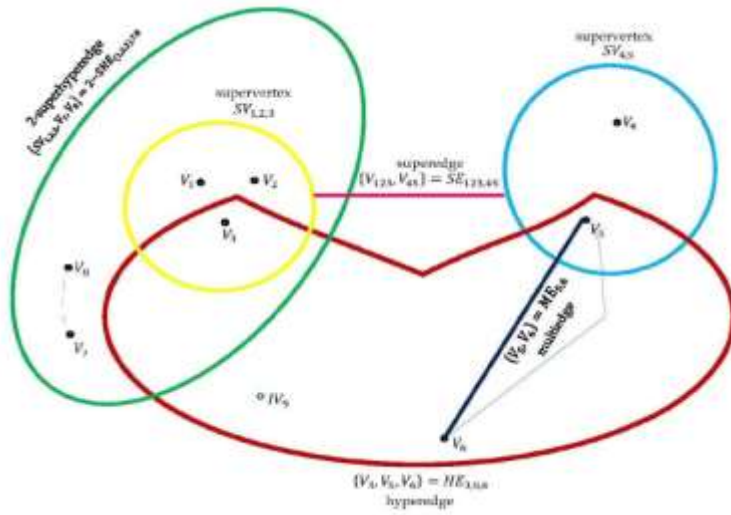

Figure 1. a Restricted SuperHyperGraph $G = (X, E)$

a. Adjacency matrix

$$A = \begin{matrix} & v_1 & v_2 & v_3 & v_4 & v_5 & v_6 & v_7 & v_8 & Iv_9 & Sv_{4,5} & Sv_{1,2,3} \\ \begin{matrix} v_1 \\ v_2 \\ v_3 \\ v_4 \\ v_5 \\ v_6 \\ v_7 \\ v_8 \\ Iv_9 \\ Sv_{4,5} \\ Sv_{1,2,3} \end{matrix} & \begin{pmatrix} 0 & 0 & 0 & 0 & 0 & 0 & 0 & 0 & 0 & 0 & 0 & 0 \\ 0 & 0 & 0 & 0 & 0 & 0 & 0 & 0 & 0 & 0 & 0 & 0 \\ 0 & 0 & 0 & 0 & H & H & 0 & 0 & H & 0 & 0 & 0 \\ 0 & 0 & 0 & 0 & 0 & 0 & 0 & 0 & 0 & 0 & 0 & 0 \\ 0 & 0 & H & 0 & 0 & 2, H & 0 & 0 & H & 0 & 0 & 0 \\ 0 & 0 & H & 0 & 2, H & 0 & 0 & 0 & H & 0 & 0 & 0 \\ 0 & 0 & 0 & 0 & 0 & 0 & 0 & 0 & I & 0 & 0 & SH \\ 0 & 0 & 0 & 0 & 0 & 0 & 0 & I & 0 & 0 & 0 & SH \\ 0 & 0 & H & 0 & H & H & 0 & 0 & 0 & 0 & 0 & 0 \\ 0 & 0 & 0 & 0 & 0 & 0 & 0 & 0 & 0 & 0 & 0 & S \\ 0 & 0 & 0 & 0 & 0 & 0 & SH & SH & 0 & 0 & S & 0 \end{pmatrix} \end{matrix}$$

b. incidence matrix

$$B = \begin{matrix} E_{5,6} \\ SE_{123,45} \\ HE_{3,5,6,9} \\ SHE_{123,7,8} \\ IE_{7,8} \end{matrix} \begin{pmatrix} v_1 & v_2 & v_3 & v_4 & v_5 & v_6 & v_7 & v_8 & Iv_9 & Sv_{4,5} & Sv_{1,2,3} \\ 0 & 0 & 0 & 0 & 2 & 2 & 0 & 0 & 0 & 0 & 0 \\ 0 & 0 & 0 & 0 & 0 & 0 & 0 & 0 & 0 & 1 & 1 \\ 0 & 0 & 1 & 0 & 1 & 1 & 0 & 0 & 1 & 0 & 0 \\ 0 & 0 & 0 & 0 & 0 & 0 & 1 & 1 & 0 & 0 & 1 \\ 0 & 0 & 0 & 0 & 0 & 0 & 1 & 1 & 0 & 0 & 0 \end{pmatrix}$$

c. Laplacian matrix

To calculate the Laplacian matrix, we first obtain the diameter matrix D , in which the vertices on the principal diameter, the degree of vertices, and the other vertices are 0. Then its Laplacian matrix is calculated as follows.

$$L = \begin{pmatrix} 0 & 0 & 0 & 0 & 0 & 0 & 0 & 0 & 0 & 0 & 0 \\ 0 & 0 & 0 & 0 & 0 & 0 & 0 & 0 & 0 & 0 & 0 \\ 0 & 0 & 3 & 0 & -1 & -1 & 0 & 0 & -1 & 0 & 0 \\ 0 & 0 & 0 & 0 & 0 & 0 & 0 & 0 & 0 & 0 & 0 \\ 0 & 0 & -1 & 0 & 5 & -3 & 0 & 0 & -1 & 0 & 0 \\ 0 & 0 & -1 & 0 & -3 & 5 & 0 & 0 & -1 & 0 & 0 \\ 0 & 0 & 0 & 0 & 0 & 0 & 2 & -1 & 0 & 0 & -1 \\ 0 & 0 & 0 & 0 & 0 & 0 & -1 & 2 & 0 & 0 & -1 \\ 0 & 0 & -1 & 0 & -1 & -1 & 0 & 0 & 3 & 0 & 0 \\ 0 & 0 & 0 & 0 & 0 & 0 & 0 & 0 & 0 & 1 & -1 \\ 0 & 0 & 0 & 0 & 0 & 0 & -1 & -1 & 0 & -1 & 3 \end{pmatrix}$$

3. Neutrosophic SuperHyperTree

In this section, we first provide a definition of Neutrosophic SuperHyperTree. We then define the subtree for Neutrosophic SuperHyperGraphs. In the following, we will examine the Helly property in this type of power graphs.

Definition 7. Let $G = (X, E)$ be a Neutrosophic SuperHyperGraph. Then G is called a Neutrosophic SuperHyperTree (NSHG) if G be a connected Neutrosophic SuperHyperGraph without a neutrosophic cycle.

Definition 8. Let $H = (A, B)$ be a Neutrosophic SuperHyperGraph. Then H is called a subtree NSHG if there exists a tree T with the same vertex set V such that each hyperedge, superedge, or hypersuperedge $e \in E$ induces a subtree in T .

Note. Here we consider the underlying graph H^* to find the subtree of NSHG.

Example 2. Consider $G = (X, E)$ a Restricted SuperHyperGraph as shown in figure 2.

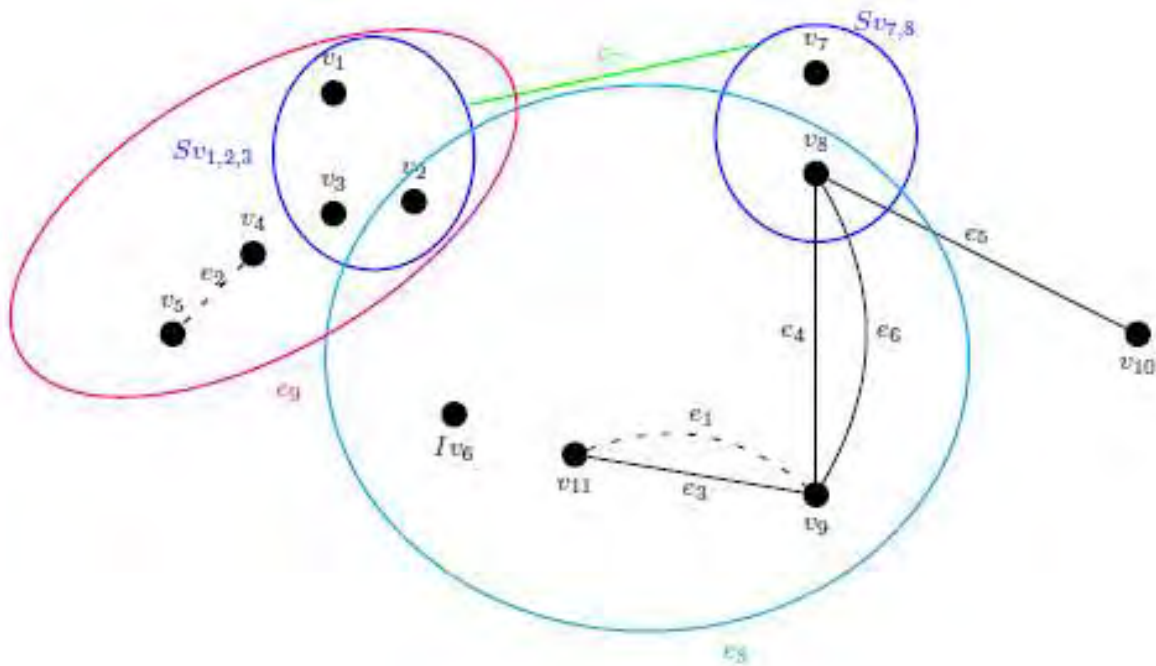

Figure 2. A Restricted SuperHyperGraph

As you can see, since G contains the cycle, so that G is not a Restricted SuperHyperTree. An RSH –subgraph induced by the subset $\{e_7, e_8, e_9, e_5\}$ of X , is a RSHT.

Example 3. Consider $G = (X, E)$ a Neutrosophic Super Hyper Power Graph as shown in figure 3. Note that in this example all vertices and edges belong to the neutrosophic sets. As you can see, G is a Restricted SuperHyperTree.

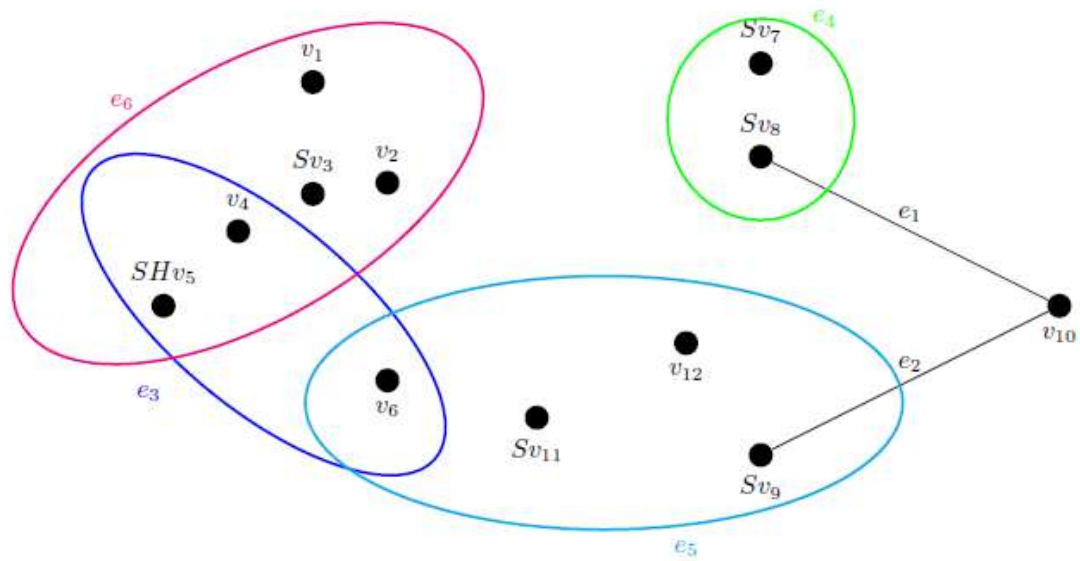

Figure 3. A Neutrosophic Restricted SuperHyperTree G

Now we find a subtree according to definition 7 for G .

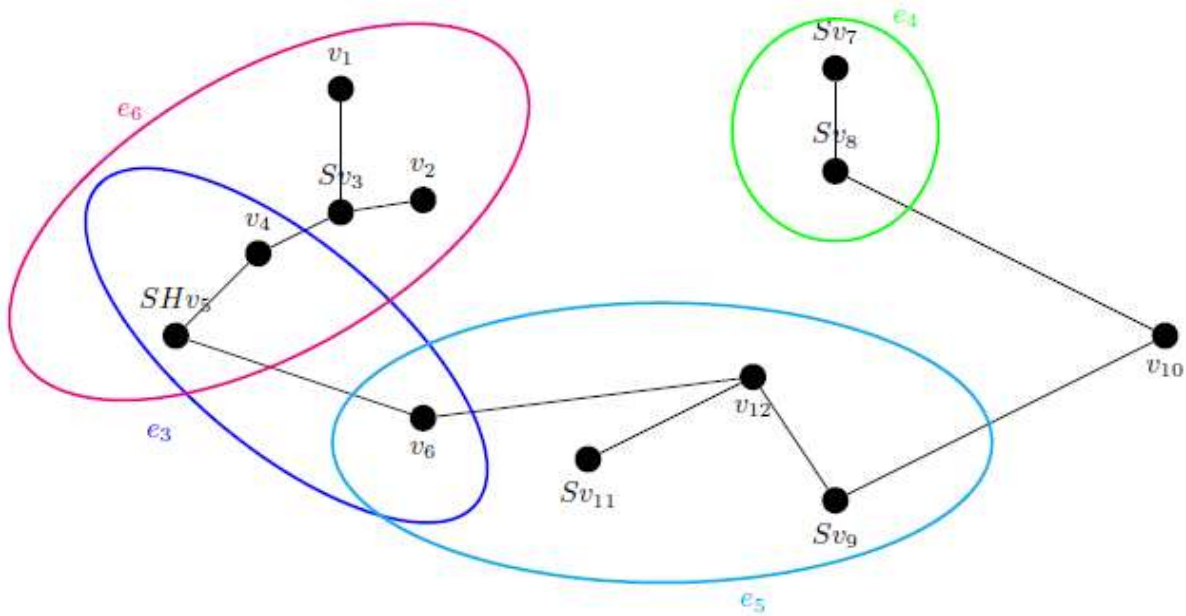

Figure 4. A subtree for NRSHG G

Now, let $T = (A, C)$ be a tree, that is, T is a connected neutrosophic graph without cycle. Then, we build a connected NRSHGraph H in the following way:

1. The set of vertices of H is the set of vertices of T ;
2. The set of edges (hyperedges, superedges or superhyperedges) are a family E of subset V such that induced subgraph T_i is a subtree of T where T_i is produced by vertices located on edge $e_i \in E$. so that subgraph T_i is a tree.

Theorem 1. Let $T = (V, E')$ be a tree. Also, H is a subtree Restricted SuperHyperGraph according to T . Then H has the Helly property.

Proof. Since for each tree there exist exactly one path between the two vertices v_i, v_j . The path between two vertices v_i, v_j denoted $P[v_i, v_j]$. suppose that, v_i, v_j and v_k are three vertices of H . The paths $P[v_i, v_j]$, $P[v_j, v_k]$ and $P[v_k, v_i]$ have one common vertex. Now, using theorem 1, for each family of edges (hyperedges, superedges and superhyperedges) where the edge contains at least two of the vertices v_i, v_j and v_k have a non-empty intersection.

□

Theorem 2. Let $T = (V, E')$ be a tree. Also, H is a subtree Restricted SuperHyperGraph according to T . Then $L(H)$ is a chordal graph.

Proof. Consider $T = (V, E')$ is a tree. Suppose H is a subtree Restricted SuperHyperGraph according to T . If $|V| = 1$, then H include exactly one vertex and one hyperdege, so that, the linegraph of H has only one vertex hence H is a clique. It turns out that H is a chordal graph. Next, assume that the assertion is true for each tree with $|V| = n - 1, n > 1$.

Now we have to show that the problem assumption is valid for n vertices as well. For that, suppose $v \in V$ is a vertex leaf on H . remember that in a tree with at least two vertices there exist at least two leaves. If $T_1 = (V - \{v\}, E'_1)$, where T_1 is the subgraph on $V - \{v\}$, and

$$H_1(V - \{v\}) = (V - \{v\}, E_1), |V| > 1.$$

The $T_1 = (V - \{v\}, E'_1)$ is a tree moreover $H_1 = (V - \{v\}, E_1)$ is an induced subtree Restricted SuperHyperGraph associated with T_1 . Hence $L(H_1)$ is chordal.

Now, if the number of edges should be the same, that is, $|E'| = |E'_1|$ then we have $L(H) \approx L(H_1)$ so that $L(H)$ is a chordal graph.

If $|E'| \neq |E'_1|$ then we have

$$\{v\} \in E' \text{ and } |E'| > |E'_1|.$$

It is easy to show that a neighborhood from $\{v\}$ in $L(H)$ is a clique. Hence any cycle passing through $\{v\}$ is chordal in $L(H)$ and so $L(H)$ is chordal.

□

Corollary 1. A Restricted SuperHyperGraph G is a subtr Restricted SuperHyperGraph if and only if G has the Helly property and its line graph is a chordal graph.

4. Conclusions

In this article, we have defined a SuperHyperTree and Neutrosophic SuperHyperTree, and examined the Helly property, which is one of the most important and practical properties in subtrees,

for the super hyper tree introduced in this article. There are also algorithms for detecting Helly property that we have omitted here.

References

1. Smarandache, F. Extension of HyperGraph to n-SuperHyperGraph and to Plithogenic n-SuperHyperGraph, and Extension of HyperAlgebra to n-ary (Classical-/Neutro-/Anti-)HyperAlgebra. 2020. *Neutrosophic Sets and Systems*, Vol. 33.
2. Smarandache, F. n-SuperHyperGraph and Plithogenic n-SuperHyperGraph. 2019. in *Nidus Idearum*, Vol. 7, second edition, Pons asbl, Bruxelles, pp. 107-113.
3. Smarandache, F. The neutrosophic triplet (n-ary HyperAlgebra, n-ary NeutroHyperAlgebra, n-ary AntiHyper Algebra). 2019. In *Nidus Idearum*, Vol. 7, second edition, Pons asbl, Bruxelles, pp. 104-106.
4. Bretton, A., Ubeda, S., Zerovnik, Y. A polynomial algorithm for the strong Helly property. 2002. *IPL. Inf. Process. Lett.* 81(1), 55-57.
5. Voloshin, V.I. *Introduction to Graph and Hypergraph Theory*. 2009. Nova Science Publishers, New York.
6. Enright, J., Rudnicki, P. Helly Property for Subtrees. 2008. *FORMALIZED MATHEMATICS*, Vol 16, pp. 91-96.
7. Agnarsson, G. On Chordal Graphs and Their Chromatic Polynomials. 2003. *Math SCAND.* 93(2), pp. 240-246. Dio:10.7146/math.scand.a-14421, MR 2009583.

Received: Feb 8, 2022. Accepted: Jun 14, 2022

Spectrum of Superhypergraphs via Flows

Mohammad Hamidi, Florentin Smarandache, Elham Davneshvar

Mohammad Hamidi, Florentin Smarandache, Elham Davneshvar (2022). Spectrum of Superhypergraphs via Flows. *Journal of Mathematics*, ID 9158912, 12; DOI: 10.1155/2022/9158912

For any $n \in \mathbb{N}$ and given nonempty subset V , the concept of n -superhypergraphs is introduced by Florentin Smarandache based on $P^n(V)$ (n -th power set of V). In this paper, we present the novel concepts *supervertices*, *superedges*, and *superhypergraph* via the concept of *flow*. This study computes the number of superedges of any given superhypergraphs, and based on the numbers of superedges and partitions of an underlying set of superhypergraph, we obtain the number of all superhypergraphs on any nonempty set. As a main result of the research, this paper is introducing the *incidence matrix* of superhypergraph and computing the *characteristic polynomial* for the incidence matrix of superhypergraph, so we obtain the *spectrum* of superhypergraphs. The flow of superedges plays the main role in computing of spectrum of superhypergraphs, so we compute the spectrum of superhypergraphs in some types such as *regular flow*, *regular reversed flow*, and *regular two-sided flow*. The new conception of *superhypergraph* and computation of the spectrum of superhypergraphs are introduced firstly in this paper.

1. Introduction and Preliminaries

The theory of graph is a main and important theory for modeling the real problem in the world, and this theory extends in past years in this regard. The disadvantage of a graph is that it cannot connect more than two elements, so this problem causes weakness in this theory. Berge generalized the theory of graphs to the mathematical concept of theory of hypergraphs with the motivation that hypergraphs solve the conflicts, defects, and shortcomings of graph theory around 1960 [1]. Hypergraphs have some applications in other sciences and the real-world, one of the applications of hypergraphs is a simulation for complex hypernetworks. Today, hypergraphs have a vital role and important performances, so are used in complex hypernetworks such as computer science, wireless sensor hypernetwork, and social hypernetworks. In this regards there has been a lot of research about using hypergraphs to problems in real-world such as hypergraph matching via game-theoretic hypergraph clustering [2], hypergraph matching via game-theoretic hypergraph clustering [3], hypergraph-based centrality metrics for maritime container service networks, a

worldwide application [4], clustering ensemble via structured hypergraph learning [5], and hypergraph neural network for skeleton-based action recognition [6]. There is some main connection between graphs and hypergraphs via the mathematical computational tools and basic theorems in which these connections facilitate the modeling of other sciences with mathematics. Further materials regarding graphs and hypergraphs are available such as extending factorizations of complete uniform hypergraphs [7], finding perfect matchings in bipartite hypergraphs [8], graphs and hypergraphs [1], resilient hypergraphs with fixed matching number [9], on the spectrum of hypergraphs [10], on the distance spectrum of minimal cages and associated distance biregular graphs [11], on the spectrum of the perfect matching derangement graph [12], and probabilistic refinement of the asymptotic spectrum of graphs [13]. Recently, Hamidi and Saeid computed eigenvalues of discrete complete hypergraphs and partitioned hypergraphs. They defined positive equivalence relation on hypergraphs that establishes a connection between hypergraphs and graphs, and it makes a connection between a spectrum of graphs and a spectrum of the quotient of any hypergraphs. They studied

the construct spectrum of path trees via the quotient of partitioned hypergraphs [14]. A hypergraph on any given set considers a relationship between elements and the set (as objects or hyper vertices) and describes this relationship if it is a weighted hypergraph. It is an ideal condition if proper weights are known, but in most situations, the weights may not be known, and the relationships are hesitant in a natural sense. With the advent of the fuzzy graph, the importance of this theory increased and fuzzy graph as a generalization of a graph provides more information in real-life problems. Based on Zadeh's fuzzy relations [15], the notion of hypergraph has been extended in the fuzzy theory and the concept of fuzzy hypergraph was provided by Kaufmann [16]. Recently, some researchers investigated the concept of fuzzy hypergraphs and applications such as fuzzy hypergraphs and related extensions [17], an algorithm to compute the strength of competing interactions in the Bering sea based on Pythagorean fuzzy hypergraphs [18] and bipolar fuzzy soft information applied to hypergraphs [19]. Recently, Smarandache introduced a new the concept as a generalization of hypergraphs to n -superhypergraph, plithogenic n -superhypergraph {with supervertices (that are groups of vertices) and hyperedges {defined on power set of power set. . .} that is the most general form of a graph as today}, which have several properties and are connected with the real-world [20]. Indeed, n -superhypergraphs are a generalization of hypergraphs, with the advantage that they can communicate between the hyperedges.

Regarding these points, we consider a nonempty set and make a partition of the given set into some subsets, and relate this subset together with some maps. Indeed, subsets will call supervertices, the mapping between them will call superedges or flows and the system with supervertices and superedges will call a quasi superhypergraph. The main motivation of this the concept is a generalization of graphs to hypernetworks such that all elements be related together. In hypergraph theory, any hypergraph can relate a set of elements, while without any details that it makes some conflicts, defects, and shortcomings in the hypergraph theory. Thus, by introducing superhypergraph, we try to eliminate defects of graph (sometimes graph structures give very limited information about complex networks) structures and hypergraph structures (although the hypergraph structures are for covering graph defects in the applications but in hypergraphs, the relation between of vertices cannot be described in full details). As a main result of the research, this paper is introducing the incidence matrix of superhypergraph and computing the characteristic polynomial for the incidence matrix of superhypergraph, so we obtain the spectrum of superhypergraphs. Indeed, we computed the number of superedges of any given superhypergraphs and based on superedges and partitions of an underlying set of superhypergraph, we obtained the number of all superhypergraphs on any nonempty set. The flow of superedges plays the main role in computing of spectrum of superhypergraphs, so we computed the spectrum of superhypergraphs in some types regular flow, regular reversed flow, and regular two-sided flow.

Definition 1. [1] Let X be a finite set. A hypergraph on X is a pair $H = (X, \{E_i\}_{i=1}^m)$ such that for all $1 \leq i \leq m, \emptyset \neq E_i \subseteq X$ and $\cup_{i=1}^m E_i = X$. The elements x_1, x_2, \dots, x_n of X are called vertices, and the sets E_1, E_2, \dots, E_m are called the hyperedges of the hypergraph H . In hypergraphs, hyperedges can contain an element (loop) two elements (edge) or more than three elements. A hypergraph $H = (X, \{E_i\}_{i=1}^m)$ is called a complete hypergraph, if for any $x, y \in X$ there is $1 \leq i \leq m$ such that $\{x, y\} \subseteq E_i$. A hypergraph $H = (X, \{E_i\}_{i=1}^m)$ is called as a joint complete hypergraph, if $|X| = n$ for all $1 \leq i \leq n, |E_i| = i$ and $E_i \subseteq E_{i+1}$ element (loop). If for all $1 \leq k \leq m, |E_k| = 2$, the hypergraph becomes an ordinary (undirected) graph and n rows representing the vertices x_1, x_2, \dots, x_n , where for all $1 \leq i \leq n$ and for all $1 \leq j \leq m$, we have $m_{ij} = 1$ if $x_i \in E_j$ and $m_{ij} = 0$ if $x_i \notin E_j$.

Definition 2. [20] Let $m \in \mathbb{N}$ and $V = \{v_1, v_2, \dots, v_m\}$ be a set of vertices, that contains single vertices (the classic alones), indeterminate vertices (unclear, vague, unknown) and null vertices (unknown, empty). Consider $P(V)$ as the power set of $V, P^2(V) = P(P(V)) \dots$, and $P^n(V) = P(P^{n-1}(V))$ be the n -power set of the set V . Then, the n -superhypergraph (n -SHG) is an ordered pair n -SHG = (G_n, E_n) , where for any $n \in \mathbb{N}, G_n \subseteq P^n(V)$ is the set of vertices and $E_n \subseteq P^n(V)$ is the set of edges. The set G_n contains some type of vertices, such as single vertices (the classical ones), indeterminate vertices (unclear, vague, partially unknown), null vertices (totally unknown, empty), and supervertices (or subset vertex), i.e., two or more (single, indeterminate, or null) vertices together as a group (organization). An n -supervertex is a collection of many vertices such that at least one is a $(n - 1)$ -supervertex and all other supervertices in to the collection if any have the order $r \leq n - 1$. The set of edges E_n contains some type of edges such as single edges (the classic alones), indeterminate (unclear, vague, partially unknown), null-edge (empty, totally unknown), hyperedge (containing three or more single vertices), superedge (containing two vertices atleast one of them being a super vertex), n -superedge (containing two vertices, atleast one being an n - super vertex and the other of order r - super vertex with $r \leq n$), superhyperedge (containing three or more vertices, at least one being a super-vertex, n -superhyperedge (containing three or more vertices, atleast one being an n - super vertex and the other r - super vertices with $r \leq n$), multiedges (two or more edges connecting the same two vertices), and loop (an edge that connects an element).

2. On (Quasi) Superhypergraph

In this section, we introduce the concepts of supervertex, superedge, superhypergraph, and investigate their properties. For any given superhypergraph, the lower and upper bound of the set of their superedges is computed and proved in a theorem. Also, we computed and proved the number of all superhypergraphs constructed on any given nonempty set. In the following, for any nonempty set X , will denote $P^*(X) = \{Y | \emptyset \neq Y \subseteq X\}$.

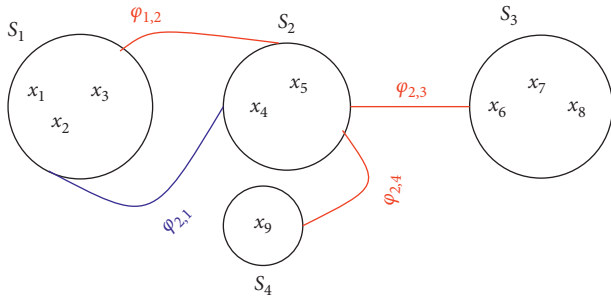

FIGURE 1: Superhypergraph $H = (X, \{S_i\}_{i=1}^4, \{\varphi_{1,2}, \varphi_{2,1}, \varphi_{2,3}, \varphi_{2,4}\})$.

In what follows, based on the concept of n -superhypergraph [20], recall, define, and investigate a special case in n -superhypergraphs as the notation of quasi superhypergraph.

Definition 3. Let X be a nonempty set. Then,

- (i) $H = (X, \{S_i\}_{i=1}^k, \{\varphi_{i,j}\}_{i,j})$ is called a quasi superhypergraph, if $\{\varphi_{i,j}\}_{i,j} \neq \emptyset$ and $X = \cup_{i=1}^n S_i$, where $k \geq 2$,
- (ii) for all $1 \leq i \leq k, S_i \in P^*(X)$, is called a supervertex and for any $i \neq j$, the map $\varphi_{i,j}: S_i \rightarrow S_j$ (say S_i links to S_j) is called a superedge,
- (iii) the quasi superhypergraph $H = (X, \{S_i\}_{i=1}^k, \{\varphi_{i,j}\}_{i,j})$ is called a superhypergraph, if for any $S_i \in P^*(X)$, there exists at least one $S_j \in P^*(X)$ such that S_i links to S_j (it is not necessary all super vertices be linked).
- (iv) The superhypergraph $H = (X, \{S_i\}_{i=1}^k, \{\varphi_{i,j}\}_{i,j})$ is called a trivial superhypergraph, if $k = 1$ (S_1 can't link to itself).

Example 1. Let $X = \{x_i\}_{i=1}^9$. Then, $H = (X, \{S_i\}_{i=1}^4, \{\varphi_{1,2}, \varphi_{2,1}, \varphi_{2,3}, \varphi_{2,4}\})$ is a quasi superhypergraph (there is no any link between of S_4 and S_3) in Figure 1, where

$$\begin{aligned} \varphi_{1,2} &= \{(x_1, x_4), (x_2, x_5), (x_3, x_4)\}, \\ \varphi_{2,1} &= \{(x_4, x_3), (x_5, x_2)\}, \\ \varphi_{2,3} &= \{(x_4, x_6), (x_5, x_7)\}, \\ \varphi_{2,4} &= \{(x_5, x_9), (x_4, x_9)\}. \end{aligned} \tag{1}$$

Let $H = (X, \{S_i\}_{i=1}^k, \{\varphi_{i,j}\}_{i,j})$ be a superhypergraph. We will denote $\Phi(H) = \{\varphi_{i,j} | i, j \geq 1\}$ by the set of all superedges of superhypergraph H . In what follows, compute and prove the lower bound and upper bound of $\Phi(H)$, as set of all superedges of superhypergraph.

Theorem 1. Let $H = (X, \{S_i\}_{i=1}^k, \{\varphi_{i,j}\}_{i,j})$ be a superhypergraph. Then,

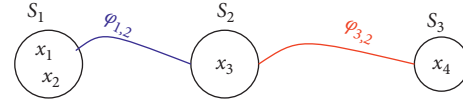

FIGURE 2: Superhypergraph $H = (X, \{S_i\}_{i=1}^3, \{\varphi_{1,2}, \varphi_{3,2}\})$ with $|\Phi(H)| = 2$.

$$(k - 1) \leq |\Phi(H)| \leq \sum_{1 \leq i \neq j \leq n} |S_i|^{|S_j|}. \tag{2}$$

Proof. Let $H = (X, \{S_i\}_{i=1}^k, \{\varphi_{i,j}\}_{i,j})$ be a superhypergraph. Since, by definition, for any $S_i \in P^*(X)$, there exists at least one $S_j \in P^*(X)$ such that S_i links to S_j , we have $(k - 1)$ superedges. In addition, let $\Phi(S_i, S_j) = \{\varphi_{i,j}: S_i \rightarrow S_j | i, j\}$. For all $1 \leq i \neq j \leq n$, in one case, if $S_i \cap S_j = \emptyset$, then, $|\Phi(S_i, S_j)| = |S_i|^{|S_j|} + |S_j|^{|S_i|}$. Hence, if $|\Phi(S_1, S_2, \dots, S_{k-1})| = \sum_{1 \leq i \neq j \leq k-1} |S_i|^{|S_j|}$, then, for all $1 \leq i \neq j \leq n, S_i \cap S_j = \emptyset$ implies that

$$\begin{aligned} |\Phi(S_1, S_2, \dots, S_{k-1}, S_k)| &= |\Phi((S_1, S_2, \dots, S_{k-1}), S_k)| \\ &= |\Phi(S_1, S_2, \dots, S_{k-1})| \\ &\quad + \sum_{1 \leq i \leq k-1} (|S_i|^{|S_k|} + |S_k|^{|S_i|}) \\ &= \sum_{1 \leq i \neq j \leq n} |S_i|^{|S_j|}. \end{aligned} \tag{3}$$

In another case, if there exists some $1 \leq i \neq j \leq n$ such that $S_i \cap S_j \neq \emptyset$, since for all $1 \leq i \neq j \leq n, S_i \cap S_j \subseteq S_i$, for all $1 \leq t \leq n$, we get that $\Phi(S_i \cap S_j, S_t) \subseteq \Phi(S_i, S_t)$ and $\Phi(S_i \cap S_j, S_t) \subseteq \Phi(S_j, S_t)$. So, in any cases, $|\Phi| \leq \sum_{1 \leq i \neq j \leq n} |S_i|^{|S_j|}$. \square

Example 2. Let $|X| = \{x_i\}_{i=1}^4$ and $H = (X, \{S_i\}_{i=1}^3, \{\varphi_{i,j}\}_{i,j})$ be a superhypergraph, where $|S_1| = 2, |S_2| = 1, |S_3| = 1$. Then, by Theorem 1, $2 \leq |\Phi(H)| \leq 8 = (2^1 + 2^1 + 1^2 + 1^1 + 1^2 + 1^1)$, where

$$\begin{aligned} \varphi_{1,2} &= \{(x_1, x_3), (x_2, x_3)\}, \\ \varphi_{1,3} &= \{(x_1, x_4), (x_2, x_4)\}, \\ \varphi_{2,1} &= \{(x_3, x_1)\}, \\ \varphi'_{2,1} &= \{(x_3, x_2)\}, \\ \varphi_{3,1} &= \{(x_4, x_1)\}, \\ \varphi'_{3,1} &= \{(x_4, x_2)\}, \\ \varphi_{2,3} &= \{(x_3, x_4)\}, \\ \varphi_{3,2} &= \{(x_4, x_3)\}. \end{aligned} \tag{4}$$

The superhypergraph $H = (X, \{S_i\}_{i=1}^3, \{\varphi_{1,2}\}_{3,2})$ with minimum superedges is shown in Figure 2.

Let X be a nonempty set, $\mathcal{SH} = \{H|H \text{ is a superhypergraph on } X\}$ and $\mathcal{SH}(n_1, n_2, \dots, n_k) = \{(X, \{S_i\}_{i=1}^k, \{\varphi_{i,j}\}_{i,j}) \in \mathcal{SH} || S_i| = n_i \text{ and for all } i \neq j, S_i \cap S_j = \emptyset\}$. In what follows, compute and prove the number of $\mathcal{SH}(n_1, n_2, \dots, n_k)$, as the set of all superhypergraphs based on any nonempty set X , where $|X| = n$.

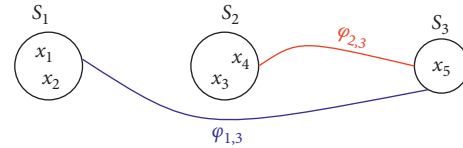

FIGURE 3: Superhypergraph $H = (X, \{S_i\}_{i=1}^3, \{\varphi_{1,3}, \varphi_{2,3}\})$.

Theorem 2. Let X be a nonempty set, $r, n \in \mathbb{N}$ and $|X| = n$.

- (i) $|\mathcal{SH}(n)| = 1$.
- (ii) If $\sum_{i=1}^r n_i = n$ and $m = |\{i|n_i = n_j\}|$, then, $|\mathcal{SH}(n_1, n_2, \dots, n_r)| = (1/m!) \prod_{i=1}^r (n - \sum_{j=1}^{i-1} n_j) (\sum_{1 \leq i \neq j \leq r} n_i^{n_j})$.

Proof

- (i) By definitions is clear.
- (ii) Let $|X| = n$. Since $\mathcal{SH}(n_1, n_2, \dots, n_k) = \{(X, \{S_i\}_{i=1}^k, \{\varphi_{i,j}\}_{i,j}) \in \mathcal{SH} || S_i| = n_i \text{ and for all } i \neq j, S_i \cap S_j = \emptyset\}$, we get that $\{S_1, S_2, \dots, S_k\} \in \mathcal{P}(X)$ is a partition of set X , where $|S_i| = n_i$. Consider S_1 , then, the numbers of selected vertices in S_1 is equal to $\binom{n}{n_1}$. Because for any $1 \leq i \leq k, S_i \cap S_j = \emptyset$, the number of selected vertices in S_2 is equal to $\binom{n-n_1}{n_2}$. It follows that the numbers of ways to chosen the selected vertices between S_1, S_2 is equal to $\binom{n}{n_1} \binom{n-n_1}{n_2}$ for the case $n_1 \neq n_2$ and is equal to $(1/2!) \binom{n}{n_1} \binom{n-n_1}{n_2}$, for the case $n_1 = n_2$. Thus, in the process of doing so and by induction, for all $1 \leq i \leq k, |\mathcal{P}(X)| = (1/m!) \prod_{i=1}^k (n - \sum_{j=1}^{i-1} n_j)$, where $m = |\{i|n_i = n_j\}|$. In addition, by Theorem 1, we have $|\Phi(H)| \leq \sum_{1 \leq i \neq j \leq n} |S_i|^{n_j}$, so $|\mathcal{SH}(n_1, n_2, \dots, n_r)| = (1/m!) \prod_{i=1}^r (n - \sum_{j=1}^{i-1} n_j) (\sum_{1 \leq i \neq j \leq r} n_i^{n_j})$. \square

Theorem 3. Let X be a nonempty set and $|X| = n$. If $\alpha = \{(n_1, n_2, \dots, n_r) | \sum_{i=1}^r n_i = n, n_i, r \in \mathbb{N}\}$ and $m = |\{i|n_i = n_j\}|$, then,

$$|\mathcal{SH}(X)| = \sum_{\alpha} \left(\frac{1}{m!} \prod_{i=1}^r n - \sum_{j=1}^{i-1} n_j \left(\sum_{1 \leq i \neq j \leq r} n_i^{n_j} \right) \right). \quad (5)$$

Proof. It is clear by Theorem 2. \square

Example 3. Let X be an arbitrary set and $|X| = 4$. Then,

$$\begin{aligned} |\mathcal{SH}(X)| &= |\mathcal{SH}(4)| + |\mathcal{SH}(3, 1)| + |\mathcal{SH}(2, 2)| \\ &\quad + |\mathcal{SH}(2, 1, 1)| + |\mathcal{SH}(1, 1, 1, 1)| \\ &= 1 + \binom{4}{3} \binom{1}{1} (3^1 + 1^3) \\ &\quad + \frac{1}{2!} \binom{4}{2} \binom{2}{2} (2^2 + 2^2) \\ &\quad + \frac{1}{2!} \binom{4}{2} \binom{2}{1} \binom{1}{1} (2^1 + 2^1 + 1^2 + 1^1 + 1^2 + 1^1) \\ &\quad + \frac{1}{4!} \binom{4}{1} \binom{3}{1} \binom{2}{1} \binom{1}{1} (1^1 + 1^1 + 1^1) 4 = 101. \end{aligned} \quad (6)$$

3. Incidence Matrix of Superhypergraphs

In this section, we introduce a square matrix as incidence matrix associate with any given superhypergraph with sign function. Indeed, in the incidence matrix associate to any given superhypergraph the domain and range of any map determine the sign function.

Let $H = (X, \{S_i\}_{i=1}^k, \{\varphi_{i,j}\}_{i,j})$ be a superhypergraph and $\Psi(H) \subseteq \Phi(H)$. Then, we have the following concepts.

Definition 4. Let $H = (X, \{S_i\}_{i=1}^k, \{\varphi_{i,j}\}_{i,j})$ be a superhypergraph and $|X| = n$. Define $A_{(|S_1|, |S_2|, \dots, |S_k|)} = (a_{ij})_{n \times (k + |\Psi(H)|)}$ as incidence matrix of H with $k + |\Psi(H)|$ columns representing the supervertices S_1, S_2, \dots, S_k , superedges $\varphi_{i,j}$ and n rows representing the vertices x_1, x_2, \dots, x_n , where $n = (k + |\Psi(H)|)$ and

$$a_{ij} = \begin{cases} 1, & \text{if } x_i \in S_i \text{ or } x_i \in \text{Domain}(\varphi_{i,j}), \\ -1, & \text{if } x_i \in \text{Range}(\varphi_{i,j}), \\ 0, & \text{otherwise.} \end{cases} \quad (7)$$

Example 4. Let $X = \{x_i\}_{i=1}^5$. Then, $H = (X, \{S_i\}_{i=1}^3, \{\varphi_{1,3}, \varphi_{2,3}\})$ is a superhypergraph in Figure 3, where $\varphi_{1,3} = \{(x_1, x_5), (x_2, x_5)\}$ and $\varphi_{2,3} = \{(x_3, x_5), (x_4, x_5)\}$. Then, $A_{(2,2,1)}$ is the incidence matrix of H .

$$A_{(2,2,1)} = \begin{matrix} & S_1 & S_2 & S_3 & \phi_{1,3} & \phi_{2,3} \\ \begin{matrix} x_1 \\ x_2 \\ x_3 \\ x_4 \\ x_5 \end{matrix} & \begin{pmatrix} 1 & 0 & 0 & 1 & 0 \\ 1 & 0 & 0 & 1 & 0 \\ 0 & 1 & 0 & 0 & 1 \\ 0 & 1 & 0 & 0 & 1 \\ 0 & 0 & 1 & -1 & -1 \end{pmatrix} \end{matrix} \quad (8)$$

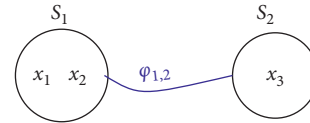

FIGURE 4: Superhypergraph $H = (X, \{S_i\}_{i=1}^2, \{\varphi_{i,j}\})$.

$$P_{k,1}^{\rightsquigarrow}(x) = \det(D_{1,k}^{\rightsquigarrow} - I_{(k+1) \times (k+1)} X) = x(-P_{1,k-1}^{\rightsquigarrow}(x) + (-x)^{k-1} + (-x)^{k-2}) = (-x)^{k-1}(x^2 + (k-3)x - (k-2)). \quad (11)$$

(ii) It is clear by item (i). □

3.1. Characteristic Polynomial for the Incidence Matrix of Superhypergraph. In this subsection, we compute the characteristic polynomial of the incidence matrix of any given superhypergraph. Let $H = (X, \{S_i\}_{i=1}^k, \{\varphi_{i,j}\}_{i,j})$ be a superhypergraph and so investigate the spectrum of the superhypergraph.

From now on, let $P_{(|S_1|, |S_2|, \dots, |S_k|)}(x)$ be the characteristic polynomial of the incidence matrix $A_{(|S_1|, |S_2|, \dots, |S_k|)}$ corresponding to superhypergraph H and $E(A_{(|S_1|, |S_2|, \dots, |S_k|)}) = \{x | x \text{ is an eigenvalue of } A_{(|S_1|, |S_2|, \dots, |S_k|)}\}$. In addition, for any S_i, S_j , if $\Phi(S_i, S_j) = \{\varphi_{i,j} | \varphi_{i,j}: S_i \rightarrow S_j, i, j \geq 1\}$, will say S_i flows to S_j and will denote by $S_i \rightsquigarrow S_j$. In this case, will denote $A_{(|S_1|, |S_2|, \dots, |S_k|)}$ by $A_{(|S_1|, |S_2|, \dots, |S_k|)}^{\rightsquigarrow}$ and $P_{(|S_1|, |S_2|, \dots, |S_k|)}(x)$ by $P_{(|S_1|, |S_2|, \dots, |S_k|)}^{\rightsquigarrow}(x)$.

Theorem 4. Let $|S_1| = 1, |S_2| = n, n \geq 2$ and $S_1 \rightsquigarrow S_2$. Then,

- (i) $P_{1,n}^{\rightsquigarrow}(x) = (-x)^{n-1}(x^2 + (n-3)x - (n-2))$.
- (ii) $\text{Spec}(A_{1,n}^{\rightsquigarrow}) = \begin{pmatrix} 0 & 1 & 2-n \\ n-1 & 1 & 1 \end{pmatrix}$.

Proof

- (i) Let $n = 2$. It is easy to see that $P_{1,2}^{\rightsquigarrow}(x) = (-x)(x^2 - x)$. Suppose that $k \geq 3$ and $P_{1,k-1}^{\rightsquigarrow}(x) = (-x)^{k-2}(x^2 + (k-4)x - (k-3))$. Then, $A_{1,k}^{\rightsquigarrow} = [c_1, c_2, \dots, c_k, c_{k+1}]$, where $c_3 = \dots = c_{k+1} = [1, \underbrace{-1, \dots, -1}_t]^t$. It follows that

$$P_{1,k}^{\rightsquigarrow}(x) = \det(\underbrace{A_{1,k}^{\rightsquigarrow}}_{k\text{-times}} - I_{(k+1) \times (k+1)} X) = \det(B_{1,k}^{\rightsquigarrow}), \quad (9)$$

such that $B_{1,k}^{\rightsquigarrow} = [b_{ij}]_{(k+1) \times (k+1)}$, where $B_{1,k}^{\rightsquigarrow} = [c'_1, c'_2, \dots, c'_k, c'_{k+1}]$ that for all $i \in \{3, \dots, k+1\}$, $c'_i = [1, \underbrace{-1, \dots, -1}_{(i-2)\text{-times}}, -1 - x, \underbrace{-1, \dots, -1}_{(k-i+1)\text{-times}}]^t$. Now,

consider $D_{1,k}^{\rightsquigarrow} = (d_{ij})_{(k+1) \times (k+1)}$, where

$$d_{ij} = \begin{cases} b_{ij}, & j \neq k+1, \\ -c'_k + c'_{k+1}, & j = k+1. \end{cases} \quad (10)$$

Thus, $D_{1,k}^{\rightsquigarrow} = [c'_1, c'_2, \dots, c'_{k-1}, c'_k, c'_{k+1}]$, where $c'_{k+1} = [\underbrace{0, \dots, 0}_{(k-1)\text{-times}}, x, -x]^t = (x)[\underbrace{0, \dots, 0}_{(k-1)\text{-times}}, 1, -1]^t$. Based on

induction assumption and computations of determinant based on column c'_{k+1} in matrix $D_{1,k}^{\rightsquigarrow}$, have

Theorem 5. Let $|S_1| = n, |S_2| = 1, n \geq 2$ and $S_1 \rightsquigarrow S_2$. Then, $P_{n,1}^{\rightsquigarrow}(x) = (-x)^{n-1}(x^2 - (n-2)x - 2)$.

Proof. Let $n = 2$. It is easy to see that $P_{2,1}^{\rightsquigarrow}(x) = (-x)(x^2 - 2)$. Suppose that $k \geq 3$ and $P_{k-1,1}^{\rightsquigarrow}(x) = (-x)^{k-2}(x^2 - (k-3)x - 2)$. Then, $A_{k,1}^{\rightsquigarrow} = [c_1, c_2, \dots, c_k, c_{k+1}]$, where $c_3 = \dots = c_{k+1} = [\underbrace{1, 1, \dots, 1}_{k\text{-times}}, -1]^t$. It follows that

$$P_{k,1}^{\rightsquigarrow}(x) = \det(A_{k,1}^{\rightsquigarrow} - I_{(k+1) \times (k+1)} X) = \det(B_{k,1}^{\rightsquigarrow}), \quad (12)$$

such that $B_{k,1}^{\rightsquigarrow} = [b_{ij}]_{(k+1) \times (k+1)}$, where $B_{k,1}^{\rightsquigarrow} = [c'_1, c'_2, \dots, c'_k, c'_{k+1}]$ that for all $i \in \{3, 4, \dots, k\}$, $c'_i = [\underbrace{1, 1, \dots, 1}_{(i-1)\text{-times}}, 1 - x, \underbrace{1, 1, \dots, 1}_{[k-i]\text{-times}}, -1]^t$ and $c'_{k+1} = [\underbrace{1, 1, \dots, 1}_{k\text{-times}}, -1 - x]^t$.

Consider $D_{k,1}^{\rightsquigarrow} = (d_{ij})_{(k+1) \times (k+1)}$, where

$$d_{ij} = \begin{cases} b_{ij}, & j \neq k, \\ c'_k - c'_{k+1}, & j = k. \end{cases} \quad (13)$$

Thus, $D_{k,1}^{\rightsquigarrow} = [c'_1, c'_2, \dots, c'_{k-1}, c'_k, c'_{k+1}]$, where $c'_k = [\underbrace{0, \dots, 0}_{[k-1]\text{-times}}, -x, x]^t = (-x)[\underbrace{0, \dots, 0}_{[k-1]\text{-times}}, 1, -1]^t$. Based on

induction assumption and computations of determinant based on column c'_k in matrix $D_{k,1}^{\rightsquigarrow}$, have

$$P_{k,1}^{\rightsquigarrow}(x) = \det(D_{k,1}^{\rightsquigarrow} - I_{(k+1) \times (k+1)} X) = -xP_{k-1,1}^{\rightsquigarrow}(x) + (-x)^k. \quad (14)$$

□

Theorem 6. Let $|S_1| = n, |S_2| = 2, n \geq 2$ and $S_1 \rightsquigarrow S_2$. Then, $P_{n,2}^{\rightsquigarrow}(x) = (-x)^n(x^2 - (n-3)x - 4)$.

Proof. Let $n = 2$. It is easy to see that $P_{2,1}^{\rightsquigarrow}(x) = x^2(x^2 + x - 4)$. Suppose that $k \geq 3$ and $P_{k-1,1}^{\rightsquigarrow}(x) = (-x)^{k-1}(x^2 - (k-4)x - 4)$. Then, $A_{k,2}^{\rightsquigarrow} = [c_1, c_2, \dots, c_k, c_{k+1}, c_{k+2}]$, where $c_3 = \dots = c_{k+2} = [\underbrace{1, 1, \dots, 1}_{k\text{-times}}, -1, -1]^t$. It follows that

$$P_{k,2}^{\rightsquigarrow}(x) = \det(A_{k,2}^{\rightsquigarrow} - I_{(k+2) \times (k+2)} X) = \det(B_{k,2}^{\rightsquigarrow}), \quad (15)$$

such that $B_{k,2}^{\rightsquigarrow} = [b_{ij}]_{(k+2) \times (k+2)}$, where $B_{k,2}^{\rightsquigarrow} = [c'_1, c'_2, \dots, c'_k, c'_{k+1}, c'_{k+2}]$ that for all $i \in \{3, 4, \dots, k\}$ $c'_i =$

$[1, 1, \dots, 1, 1 - x, 1, 1, \dots, 1, -1, -1]^t, c_{k+1}' = [1, 1, \dots, 1, -1 - x, \dots, -1]^t$ and $c_{k+2}' = [1, 1, \dots, 1, -1, -1 - x]^t$. In addition, $D_{k,2}^{\rightsquigarrow} = (d_{ij})_{(k+2) \times (k+2)}$, where

$$d_{ij} = \begin{cases} b_{ij}, & j \neq k, \\ c'_k - c'_{k+2}, & j = k. \end{cases} \quad (16)$$

Thus, $D_{k,2}^{\rightsquigarrow} = [c'_1, c'_2, \dots, c'_k, c'_{k+1}, c'_{k+2}]$, where $c''_k = [0, \dots, 0, -x, 0, x]^t = (-x)[0, \dots, 0, 1, 0, -1]^t$. Based on induction assumption and computations of determinant based on column c''_k in matrix $D_{k,2}^{\rightsquigarrow}$ show that

$$P_{k,2}^{\rightsquigarrow}(x) = \det(D_{k,2}^{\rightsquigarrow} - I_{(k+2) \times (k+2)} X) = -xP_{k-1,2}^{\rightsquigarrow}(x) + (-x)^{k+1}. \quad (17)$$

Theorem 7. Let $|S_1| = n, |S_2| = 3, n \geq 2$ and $S_1 \rightsquigarrow S_2$. Then, $P_{n,3}^{\rightsquigarrow}(x) = (-x)^{n+1}(x^2 - (n-4)x - 6)$.

Proof. It is similar to Theorem 6. □

Corollary 1. Let $|S_1| = n, |S_2| = m, n \geq 2, m \geq 1$ and $S_1 \rightsquigarrow S_2$. Then,

- (i) $P_{n,m}^{\rightsquigarrow}(x) = (-x)^{n+m-2}(x^2 - (n-m-1)x - 2m)$.
- (ii) $\text{Spec}(A_{n,m}^{\rightsquigarrow}) = (0, (\alpha + \sqrt{\alpha^2 + 8m})/2, (\alpha - \sqrt{\alpha^2 + 8m})/2, n + m - 21)$, where $\alpha = n - m - 1$.
- (iii) $\sum_{x \in E(A_{n,m}^{\rightsquigarrow})} x = 0$ if and only if $n = m + 1$.

Example 5. Let $X = \{x_1, x_2, x_3\}$. Then, $H = (X, \{S_i\}_{i=1}^2, \{\phi_{1,2}\})$ is a superhypergraph as shown in Figure 4 and incidence matrix of $A_{2,1}^{\rightsquigarrow}$ as follows.

$$M_H = \begin{matrix} & S_1 & S_2 & \phi_{1,2} \\ \begin{matrix} x_1 \\ x_2 \\ x_3 \end{matrix} & \begin{pmatrix} 1 & 0 & 1 \\ 1 & 0 & 1 \\ 0 & 1 & -1 \end{pmatrix} \end{matrix}. \quad (18)$$

Thus, by Theorem 5, we have $P_{2,1}^{\rightsquigarrow}(x) = (-x)(x^2 - 2)$ and so $\text{Spec}(A_{2,1}^{\rightsquigarrow}) = \left(0, \sqrt{2}, -\sqrt{2}\right)$.

3.2. Characteristic Polynomial for the Incidence Matrix of Superhypergraph with Reverse Flows. In this subsection, we compute the characteristic polynomial and spectrum of the superhypergraph in the reverse flows to the previous section.

For any S_i, S_j , if $\Phi(S_j, S_i) = \{\varphi_{i,j} | \varphi_{i,j}: S_j \rightarrow S_i, i, j \geq 1\}$, will say S_j flows to S_i and will denote by $S_i \leftarrow S_j$ (reverse flows to $S_i \rightsquigarrow S_j$) and so $A_{|S_1|, |S_2|, \dots, |S_k|}$ by $A_{|S_1|, |S_2|, \dots, |S_k|}^{\leftarrow}$ and $P_{|S_1|, |S_2|, \dots, |S_k|}(x)$ by $P_{|S_1|, |S_2|, \dots, |S_k|}^{\leftarrow}(x)$.

Theorem 8. Let $|S_1| = 1, |S_2| = n, n \geq 2$ and $S_1 \leftarrow S_2$. Then,

- (i) $P_{1,n}^{\leftarrow}(x) = (-x)^{n-1}(x^2 - (n+1)x + n)$.

(ii) $\text{Spec}(A_{1,n}^{\leftarrow}) = \left(0, 1, n, n-1, 1, 1\right)$.

Proof

- (i) Let $n = 2$. It is easy to see that $P_{1,2}^{\leftarrow}(x) = (-x)(x^2 - 3x + 2)$. Suppose that $k \geq 3$ and $P_{1,k-1}^{\leftarrow}(x) = (-x)^{k-2}(x^2 - kx + (k-1))$. Then, $A_{1,k}^{\leftarrow} = [c_1, c_2, \dots, c_k, c_{k+1}]$, where $c_3 = \dots = c_{k+1} = [-1, 1, \dots, 1]^t$. It follows that

$$P_{1,k}^{\leftarrow}(x) = \det(A_{1,k}^{\leftarrow} - I_{(k+1) \times (k+1)} X) = \det(B_{1,k}^{\leftarrow}), \quad (19)$$

such that $B_{1,k}^{\leftarrow} = [b_{ij}]_{(k+1) \times (k+1)}$, where $B_{1,k}^{\leftarrow} = [c'_1, c'_2, \dots, c'_k, c'_{k+1}]$ that for all $i \in \{3, 4, \dots, k+1\}, c'_i = [-1, 1, \dots, 1, \underbrace{1-x}_{i-2 \text{ times}}, \underbrace{1}_{i \text{ th}}, \underbrace{1, \dots, 1}_{(k-i+1) \text{ times}}]^t$. Now, consider

$$D_{1,k}^{\leftarrow} = (d_{ij})_{(k+1) \times (k+1)}, \text{ where } d_{ij} = \begin{cases} b_{ij}, & j \neq k+1, \\ -c'_k + c'_{k+1}, & j = k+1. \end{cases} \quad (20)$$

Thus, $D_{1,k}^{\leftarrow} = [c'_1, c'_2, \dots, c'_{k-1}, c'_k, c'_{k+1}]$, where $c''_{k+1} = [0, \dots, 0, x, -x]^t = (x)[0, \dots, 0, 1, -1]^t$. Based on induction assumption and computations of determinant based on column c''_{k+1} in matrix $D_{1,k}^{\leftarrow}$, have

$$P_{1,k}^{\leftarrow}(x) = \det(D_{1,k}^{\leftarrow} - I_{(k+1) \times (k+1)} X) = x(-P_{1,k-1}^{\leftarrow}(x) - (-x)^{k-1} - (-x)^{k-2}) = (-x)^{k-1}(x^2 - (k+1)x + k).$$

- (ii) It is clear by item (i). □

Theorem 9. Let $|S_1| = n, |S_2| = 1, n \geq 2$ and $S_1 \leftarrow S_2$. Then, $P_{n,1}^{\leftarrow}(x) = (-x)^{n-1}(x^2 + (n-4)x + 2)$.

Proof. Let $n = 2$. It easy is to see that $P_{2,1}^{\leftarrow}(x) = (-x)(x^2 - 2x + 2)$. Suppose that $k \geq 3$ and $P_{k-1,1}^{\leftarrow}(x) = (-x)^{k-2}(x^2 + (k-5)x + 2)$. Then, $A_{k,1}^{\leftarrow} = [c_1, c_2, \dots, c_k, c_{k+1}]$, where $c_3 = \dots = c_{k+1} = \underbrace{[-1, -1, \dots, -1, 1]^t}_{k \text{ times}}$. It follows that

$$P_{k,1}^{\leftarrow}(x) = \det(A_{k,1}^{\leftarrow} - I_{(k+1) \times (k+1)} X) = \det(B_{k,1}^{\leftarrow}), \quad (22)$$

such that $B_{k,1}^{\leftarrow} = [b_{ij}]_{(k+1) \times (k+1)}$, where $B_{k,1}^{\leftarrow} = [c'_1, c'_2, \dots, c'_k, c'_{k+1}]$ that for all $i \in \{3, \dots, k\}, c'_i = \underbrace{[-1, \dots, -1]}_{(i-1) \text{ times}}, \underbrace{-1-x}_{i \text{ th}}, \underbrace{-1, \dots, -1}_{(k-i) \text{ times}}, 1, -x]^t$ and $c'_{k+1} = \underbrace{[-1, -1, \dots, -1]}_{k \text{ times}}, 1, -x]^t$.

Moreover, consider $D_{k,1}^{\leftarrow} = (d_{ij})_{(k+1) \times (k+1)}$, where

$$d_{ij} = \begin{cases} b_{ij}, & j \neq k, \\ c'_k - c'_{k+1}, & j = k. \end{cases} \quad (23)$$

Thus, $D_{k,1}^- = [c'_1, c'_2, \dots, c'_{k-1}, \overset{n}{c}_k, c'_{k+1}]$, where $\overset{n}{c}_k = [0, \dots, 0, -x, x]^t = (-x)[\underbrace{0, \dots, 0}_{k-1 \text{ times}}, 1, -1]^t$. Based on induction assumption and computations of determinant based on column $\overset{n}{c}_k$ in matrix $D_{k,1}^-$, have

$$P_{k,1}^-(x) = \det(D_{k,1}^- - I_{(k+1) \times (k+1)} X) = -xP_{k-1,1}^-(x) + (-1)^{k+1} x^k. \tag{24}$$

□

Theorem 10. Let $|S_1| = n, |S_2| = 2, n \geq 2$ and $S_1 \leftarrow S_2$. Then, $P_{n,2}^-(x) = (-x)^n (x^2 + (n-5)x + 4)$.

Proof. Let $n = 2$. It is easy to see that $P_{2,1}^-(x) = x^2(x^2 - 3x + 4)$. Suppose that $k \geq 3$ and $P_{k-1,1}^-(x) = (-x)^{k-1}(x^2 + (k-6)x + 4)$. Then, $A_{k,2}^- = [c_1, c_2, \dots, c_k, c_{k+1}, c_{k+2}]$, where $c_3 = \dots = c_{k+2} = \underbrace{[-1, -1, \dots, -1, 1, 1]}_{k \text{ times}}^t$. It follows that

$$P_{k,2}^-(x) = \det(A_{k,2}^- - I_{(k+2) \times (k+2)} X) = \det(B_{k,2}^-), \tag{25}$$

such that $B_{k,2}^- = [b_{ij}]_{(k+2) \times (k+2)}$, where $B_{k,2}^- = [c'_1, c'_2, \dots, c'_k, c'_{k+1}, c'_{k+2}]$ that for all $i \in \{3, \dots, k\}, c'_i = \underbrace{[-1, \dots, -1]}_{(i-1)\text{-times}}$, $\underbrace{-1-x, -1, \dots, -1, 1, 1}_{i^{\text{th}} \text{ (k-i)-times}}^t, c'_{k+1} = \underbrace{[-1, \dots, -1, 1-x, 1]}_{k\text{-times}}^t$, and $c'_{k+2} = \underbrace{[-1, \dots, -1, 1, 1-x]}_{k\text{-times}}^t$. Consider $D_{k,2}^- = (d_{ij})_{(k+2) \times (k+2)}$ where

$$d_{ij} = \begin{cases} b_{ij}, & j \neq k, \\ c'_k - c'_{k+1}, & j = k. \end{cases} \tag{26}$$

Thus, $D_{k,2}^- = [c'_1, c'_2, \dots, \overset{n}{c}_k, c'_{k+1}, c'_{k+2}]$, where $\overset{n}{c}_k = [\underbrace{0, \dots, 0}_{(k-1)\text{-times}}, -x, x, 0]^t = (-x)[\underbrace{0, \dots, 0}_{(k-1)\text{-times}}, 1, -1, 0]^t$. Based on induction assumption and computations of determinant based on column $\overset{n}{c}_k$ in matrix $D_{k,2}^-$ show that

$$P_{k,2}^-(x) = \det(D_{k,2}^- - I_{(k+2) \times (k+2)} X) = (-x)P_{k-1,2}^-(x) + (-1)^k x^{k+1}. \tag{27}$$

□

Theorem 11. Let $|S_1| = n, |S_2| = 3, n \geq 2$ and $S_1 \leftarrow S_2$. Then, $P_{n,3}^-(x) = (-x)^{n+1} (x^2 + (n-6)x + 6)$.

Proof. It is similar to Theorem 6. □

Corollary 2. Let $|S_1| = n, |S_2| = m, n \geq 2, m \geq 1$ and $S_1 \leftarrow S_2$. Then,

- (i) $P_{n,m}^-(x) = (-x)^{n+m-2} (x^2 + (n-m-3)x + 2m)$.
- (ii) $\text{Spec}(A_{n,m}^-) = (0, (-\alpha + \sqrt{\alpha^2 - 8m})/2, (-\alpha - \sqrt{\alpha^2 - 8m})/2, n + m - 1)$, where $\alpha = n - m - 3$.

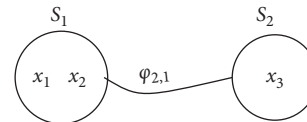

FIGURE 5: Superhypergraph $H = (X, \{S_i\}_{i=1}^2, \{\phi_{2,1}\})$.

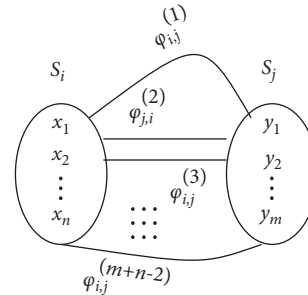

FIGURE 6: $H = (X, \{S_i, S_j\}, \{\phi_{i,j}^{(1)}, \phi_{j,i}^{(2)}, \dots, \phi_{j,i}^{(m+n-2)}\})$.

(iii) $\sum_{x \in E(A_{n,m})} x = 0$ if and only if $n = m + 3$.

Example 6. Let $X = \{x_1, x_2, x_3\}$. Then, $H = (X, \{S_i\}_{i=1}^2, \{\phi_{2,1}\})$ is a superhypergraph as shown in Figure 5 and incidence matrix of $A_{2,1}$ as follows.

$$M_H = \begin{matrix} & S_1 & S_2 & \phi_{2,1} \\ \begin{matrix} x_1 \\ x_2 \\ x_3 \end{matrix} & \begin{pmatrix} 1 & 0 & -1 \\ 1 & 0 & -1 \\ 0 & 1 & 1 \end{pmatrix} \end{matrix} \tag{28}$$

Thus, by Theorem 9, we have $P_{2,1}^-(x) = (-x)(x^2 - 2x + 2)$ and so $\text{Spec}(A_{2,1}^-) = \left(\begin{matrix} 0 & 1 & 1 & -i \\ 1 & 1 & 1 & \end{matrix} \right)$.

3.3. Characteristic Polynomial for the Incidence Matrix of Superhypergraph with Two-Sided Flows. In this subsection, we compute the characteristic polynomial and spectrum of the superhypergraph with two-sided flows.

For any S_i, S_j , if $\Phi = \{\phi_{i,j} | \phi_{i,j}: S_i \leftrightarrow S_j, i, j \geq 1\}$, will say S_i flows to S_j by two-sided and will denote by $S_i \leftrightarrow S_j$ and so $A_{|S_1|, |S_2|, \dots, |S_k|}$ by $A_{|S_1|, |S_2|, \dots, |S_k|}^{\leftrightarrow}$ and $P_{|S_1|, |S_2|, \dots, |S_k|}(x)$ by $P_{|S_1|, |S_2|, \dots, |S_k|}^{\leftrightarrow}(x)$. When we will show that $S_i \leftrightarrow S_j$ of type $[+, -, +, -, \dots]$, it means that the first map flows from S_i to S_j , the second map flows from S_j to S_i , the third map flows from S_i to S_j , etc., respectively. We will show it in Figure 6, where, n is an odd.

Theorem 12. Let $|S_1| = 1, |S_2| = n, n \geq 3$ and $S_1 \leftrightarrow S_2$ of type $[+, -, +, -, \dots]$. Then,

- (i) $P_{1,n}^{\leftrightarrow}(x) = \begin{cases} -(x^{2k})(x-1) & n = 2k \\ x^{2k}(x-1)^2 & n = 2k+1 \end{cases}$.
- (ii) if n is an even, then $\text{Spec}(A_{1,n}^{\leftrightarrow}) = \left(\begin{matrix} 0 & 1 \\ n & 1 \end{matrix} \right)$.

(iii) if n is an odd, then $\text{Spec}(A_{1,n}^{\leftrightarrow}) = \begin{pmatrix} 0 & 1 \\ n-1 & 2 \end{pmatrix}$.

Proof

(i) Let $n = 3$ and $n = 4$. It is easy to see that $P_{1,3}^{\leftrightarrow}(x) = x^2(x-1)^2$ and $P_{1,4}^{\leftrightarrow}(x) = -x^4(x-1)$. Suppose that $k \geq 3$ is an odd and $P_{1,k-1}^{\leftrightarrow}(x) = x^{2k-2}(x-1)^2$. Then, $A_{1,k}^{\leftrightarrow} = [c_1, c_2, \dots, c_k, c_{k+1}]$, where for all $i \in \{3, 5, 7, \dots, k\}$, $c_i = [1, \underbrace{-1, \dots, -1}_{k\text{-times}}]^t$ and where for all $i \in \{4, 8, \dots, k+1\}$, $c_i = [-1, \underbrace{1, \dots, 1}_{k\text{-times}}]^t$. It follows that

$$P_{1,k}^{\leftrightarrow}(x) = \det(A_{1,k}^{\leftrightarrow} - I_{(k+1) \times (k+1)} X) = \det(B_{1,k}^{\leftrightarrow}), \quad (29)$$

such that $B_{1,k}^{\leftrightarrow} = [b_{ij}]_{(k+1) \times (k+1)}$, where $B_{1,k}^{\leftrightarrow} = [c'_1, c'_2, \dots, c'_k, c'_{k+1}]$, where for all $i \in \{3, 5, 7, \dots, k\}$, $c'_i = [1, \underbrace{-1, \dots, -1}_{(i-2)\text{-times}}, \underbrace{-1-x}_{(i)^{\text{th}}}, \underbrace{-1, \dots, -1}_{(k-i+1)\text{-times}}]^t$ and for all $i \in \{4, 8, \dots, k+1\}$, $c'_i = [-1, \underbrace{1, \dots, 1}_{(i-2)\text{-times}}, \underbrace{1-x}_{(i)^{\text{th}}}, \underbrace{1, \dots, 1}_{(k-i+1)\text{-times}}]^t$. Now, consider

$D_{1,k}^{\leftrightarrow} = (d_{ij})_{(k+1) \times (k+1)}$, where

$$d_{ij} = \begin{cases} b_{ij}, & 1 \leq j \leq k-1, \\ c'_k + c'_{k-1}, & j = k, \\ c'_{k+1} - c'_{k-1}, & j = k+1. \end{cases} \quad (30)$$

Thus, $D_{1,k}^{\leftrightarrow} = [c'_1, c'_2, \dots, c'_{k-1}, c''_k, c''_{k+1}]$, where $c''_k = [0, \dots, 0, -x, -x, 0]^t = (-x)[0, \dots, 0, 1, 1, 0]^t$ and $c''_{k+1} = [0, \dots, 0, x, 0, -x]^t = (-x)[0, \dots, 0, -1, 0, 1]^t$. Based on induction assumption and computations of determinant based on column c''_{k+1} in matrix $D_{1,k}^{\leftrightarrow}$, have

$$P_{1,k}^{\leftrightarrow}(x) = \det(D_{1,k}^{\leftrightarrow} - I_{(k+1) \times (k+1)} X) = (x^2)(P_{1,k-2}^{\leftrightarrow}(x)) = x^{2k}(x-1)^2. \quad (31)$$

In a similar way, if n is an even, we get that $P_{1,n}^{\leftrightarrow}(x) = -(x^n)(x-1)$.

(ii) and (iii) They are clear by item (i) and (ii). \square

Theorem 13. Let $|S_1| = n, |S_2| = 1, n \geq 3$ and $S_1 \leftrightarrow S_2$ of type $[+, -, +, -, \dots]$. Then,

$$P_{n,1}^{\leftrightarrow}(x) = \begin{cases} (-x)^{2k-1}(x^2-2), & n = 2k, \\ (x)^{2k}(x^2-3x+2), & n = 2k+1. \end{cases} \quad (32)$$

Proof. Let $n = 3$. It is easy to see that $P_{3,1}^{\leftrightarrow}(x) = x^2(x^2-3x+2)$. Suppose that $k \geq 3$ is an odd and $P_{k-1,1}^{\leftrightarrow}(x) = x^{2k-2}(x^2-3x+2)$. Then, $A_{k,1}^{\leftrightarrow} = [c_1, c_2, \dots, c_k, c_{k+1}]$, where for all $i \in \{3, 5, \dots, k\}$, $c_i = [\underbrace{1, \dots, 1}_{k\text{-times}}, -1]^t$ and where for all $i \in \{4, 6, \dots, k+1\}$, $c_i = [\underbrace{-1, \dots, -1}_{k\text{-times}}, 1]^t$. It follows that

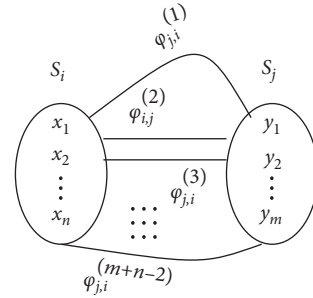

FIGURE 7: $H = (X, \{S_i, S_j\}, \{\varphi_{ij}^{(1)}, \varphi_{ji}^{(2)}, \dots, \varphi_{ji}^{(m+n-2)}\})$.

$$P_{k,1}^{\leftrightarrow}(x) = \det(A_{k,1}^{\leftrightarrow} - I_{(k+1) \times (k+1)} X) = \det(B_{k,1}^{\leftrightarrow}), \quad (33)$$

such that $B_{k,1}^{\leftrightarrow} = [b_{ij}]_{(k+1) \times (k+1)}$, where $B_{k,1}^{\leftrightarrow} = [c'_1, c'_2, \dots, c'_k, c'_{k+1}]$, where for all $i \in \{3, 5, \dots, k\}$, $c'_i = [1, \dots, 1, \underbrace{-1}_{(i-1)\text{-times}}]^t$ and for all $i \in \{4, 8, \dots, k-1\}$, $c'_i = [1, \dots, 1, \underbrace{-1-x}_{(i)^{\text{th}}}, \underbrace{-1, \dots, -1}_{(k-i)\text{-times}}]^t$ and for all $i \in \{4, 8, \dots, k-1\}$, $c'_i = [-1, \dots, -1, \underbrace{-1-x}_{(i)^{\text{th}}}, \underbrace{-1, \dots, -1}_{(k-i)\text{-times}}]^t$ and for $i = k+1$, $c'_i = [-1, \dots, -1, 1-x]^t$. Now, consider $D_{k,1}^{\leftrightarrow} = (d_{ij})_{(k+1) \times (k+1)}$, where

$$d_{ij} = \begin{cases} b_{ij}, & j = 1, \dots, k-2, k+1, \\ c'_k + c'_{k-1}, & j = k-1, \\ c'_k + c'_{k+1}, & j = k. \end{cases} \quad (34)$$

Thus, $D_{k,1}^{\leftrightarrow} = [c'_1, c'_2, \dots, c'_{k-2}, c'_{k-1}, c''_k, c'_{k+1}]$, where $c'_{k-1} = [0, \dots, 0, -x, -x, 0]^t = (-x)[0, \dots, 0, 1, 1, 0]^t$ and $c''_k = [0, \dots, 0, x, 0, -x]^t = (-x)[0, \dots, 0, -1, 0, 1]^t$. Based on induction assumption and computations of determinant based on column c''_k in matrix $D_{k,1}^{\leftrightarrow}$, we have

$$P_{k,1}^{\leftrightarrow}(x) = \det(D_{k,1}^{\leftrightarrow} - I_{(k+1) \times (k+1)} X) = (x^2)(P_{k-2,1}^{\leftrightarrow}(x)) = x^{2k}(x^2-3x+2). \quad (35)$$

In a similar way, if k is an even, we get that $P_{k,1}^{\leftrightarrow}(x) = (-x)^{2k-1}(x^2-2)$.

(ii) and (iii) They are clear by item (i) and (ii). \square

Theorem 14. Let $|S_1| = n, |S_2| = 2, n \geq 3$ and $S_1 \leftrightarrow S_2$ of type $[+, -, +, -, \dots]$. Then,

$$P_{n,2}^{\leftrightarrow}(x) = \begin{cases} x^{2k+1}(x-1), & n = 2k, \\ -x^{2k+2}(x-2), & n = 2k+1. \end{cases} \quad (36)$$

Proof. Let $n = 3$. It is easy to see that $P_{3,1}^{\leftrightarrow}(x) = (-x)^4(x-2)$. Suppose that $k \geq 3$ is an odd and $P_{k-1,2}^{\leftrightarrow}(x) = (-x)^{2k}(x-2)$. Then, $A_{k,2}^{\leftrightarrow} = [c_1, c_2, \dots, c_k + 1, c_{k+2}]$, where for all $i \in \{3, 5, \dots, k+2\}$, $c_i = [1, \dots, 1, -1, -1]^t$ and where for all $i \in \{4, 6, \dots, k+1\}$, $c_i = [-1, \dots, -1, 1, 1]^t$. It follows that

$$P_{k,2}^{\leftrightarrow}(x) = \det(A_{k,2}^{\leftrightarrow} - I_{(k+2) \times (k+2)} X) = \det(B_{k,2}^{\leftrightarrow}), \quad (37)$$

such that $B_{k,2}^{\leftrightarrow} = [b_{ij}]_{(k+2) \times (k+2)}$, where $B_{k,2}^{\leftrightarrow} = [c'_1, c'_2, \dots, c'_{k+1}, c'_{k+2}]$, where for all $i \in \{3, 5, \dots, k\}$, $c'_i = [\underbrace{1, \dots, 1}_{(i-1)\text{-times}}, \underbrace{1-x}_{(i)^{\text{th}}}, \underbrace{1, \dots, 1}_{(k-i)\text{-times}}, -1, -1]^t$ and for $i = k+2$, $c'_i = [\underbrace{1, \dots, 1}_{(k-2)\text{-times}}, -1, -1-x]^t$ and for all $i \in \{4, 8, \dots, k+1\}$, $c'_i = [\underbrace{-1, \dots, -1}_{(i-1)\text{-times}}, \underbrace{-1-x}_{(i)^{\text{th}}}, \underbrace{-1, \dots, -1}_{(k-i)\text{-times}}, 1, 1]^t$. Now, consider

$$D_{k,2}^{\leftrightarrow} = (d_{ij})_{(k+2) \times (k+2)}, \text{ where } d_{ij} = \begin{cases} b_{ij}, & j = 1, \dots, k-2, k+1, k+2, \\ c'_k + c'_{k-1}, & j = k-1, \\ c'_k + c'_{k+1}, & j = k. \end{cases} \quad (38)$$

Thus, $D_{k,2}^{\leftrightarrow} = [c'_1, c'_2, \dots, c'_{k-2}, c'_{k-1}, c''_k, c'_{k+1}, c'_{k+2}]$, where $c''_k = [\underbrace{0, \dots, 0}_{(k-2)\text{-times}}, -x, -x, 0, 0]^t = (-x)[\underbrace{0, \dots, 0}_{(k-2)\text{-times}}, 1, 1, 0, 0]^t$ and $c''_k = [\underbrace{0, \dots, 0}_{(k-1)\text{-times}}, -x, -x, 0]^t = (-x)[\underbrace{0, \dots, 0}_{(k-1)\text{-times}}, 1, 1, 0]^t$.

Based on induction assumption and computations of determinant based on column c''_k in matrix $D_{k,2}^{\leftrightarrow}$, we have

$$P_{k,2}^{\leftrightarrow}(x) = \det(D_{k,2}^{\leftrightarrow} - I_{(k+2) \times (k+2)} X) = (x^2)(P_{k-2,2}^{\leftrightarrow}(x)) = (-x)^{2k+2}(x-2). \quad (39)$$

In a similar way, if k is an even, we get that $P_{k,2}^{\leftrightarrow}(x) = x^{2k+1}(x-1)$.

(ii) and (iii) They are clear by item (i) and (ii). \square

Theorem 15. Let $|S_1| = n, |S_2| = 3, n \geq 2$ and $S_1 \leftrightarrow S_2$ of type $[+, -, +, -, \dots]$. Then,

$$P_{n,3}^{\leftrightarrow}(x) = \begin{cases} (-x)^{2k+1}(x^2-2), & n = 2k(k \geq 1), \\ (-x)^{2k+2}(x^2-3x+2), & n = 2k+1(k \geq 1). \end{cases} \quad (40)$$

Proof. It is similar to Theorem 14. \square

Corollary 3. Let $|S_1| = n, |S_2| = m, n \geq 2, m \geq 1$ and $S_1 \leftrightarrow S_2$ of type $[+, -, +, -, \dots]$. If m is an odd, then,

- (i) $P_{n,m}^{\leftrightarrow}(x) = \begin{cases} (-x)^{2k+m-2}(x^2-2) & n = 2k(k \geq 1) \\ x^{2k+m-1}(x^2-3x+2) & n = 2k+1(k \geq 1) \end{cases}$,
- (ii) If n is an odd, then, $\text{Spec}(A_{n,m}^{\leftrightarrow}) = \begin{pmatrix} 0 & 1 & 2 \\ n+m-2 & 1 & 1 \end{pmatrix}$,
- (iii) If n is an even, then $\text{Spec}(A_{n,m}^{\leftrightarrow}) = \begin{pmatrix} 0 & -\sqrt{2} & \sqrt{2} \\ n+m-2 & 1 & 1 \end{pmatrix}$,
- (iv) $\sum_{x \in E(A_{n,m})} x \neq 0$.

Corollary 4. Let $|S_1| = n, |S_2| = m, n \geq 2, m \geq 1$ and $S_1 \leftrightarrow S_2$ of type $[+, -, +, -, \dots]$. If m is an even, then,

- (i) if n is an even, then, $P_{n,m}^{\leftrightarrow}(x) = \begin{cases} (-x)^{2k+m-1}(x-1) & n = 2k(k \geq 1) \\ -(x^{2k+m})(x-2) & n = 2k+1(k \geq 1) \end{cases}$,

- (ii) If n is an odd, then, $\text{Spec}(A_{n,m}^{\leftrightarrow}) = \begin{pmatrix} 0 & 2 \\ n+m-1 & 1 \end{pmatrix}$,
- (iii) If n is an even, then, $\text{Spec}(A_{n,m}^{\leftrightarrow}) = \begin{pmatrix} 0 & 1 \\ n+m-1 & 1 \end{pmatrix}$,
- (iv) $\sum_{x \in E(A_{n,m})} x \neq 0$.

When we will show that $S_i \leftrightarrow S_j$ of type $[-, +, -, +, \dots]$, it means that the first map flows from S_j to S_i , the second map flows from S_i to S_j , the third map flows from S_j to S_i , etc., respectively. We will show it in Figure 7, where, n is an odd.

Theorem 16. Let $|S_1| = 1, |S_2| = n, n \geq 3$ and $S_1 \leftrightarrow S_2$ of type $[-, +, -, +, \dots]$. Then,

- (i) $P_{1,n}^{\leftrightarrow}(x) = \begin{cases} -(x^{2k-1})(x^2-3x+2) & n = 2k \\ x^{2k}(x-1)^2 & n = 2k+1 \end{cases}$,
- (ii) if n is an even, then, $\text{Spec}(A_{1,n}^{\leftrightarrow}) = \begin{pmatrix} 0 & 1 & 2 \\ n-1 & 1 & 1 \end{pmatrix}$,
- (iii) if n is an odd, then, $\text{Spec}(A_{1,n}^{\leftrightarrow}) = \begin{pmatrix} 0 & 1 \\ n-1 & 2 \end{pmatrix}$.

Proof

(i) Let $n = 3$ and $n = 4$. It is easy to see that $P_{1,3}^{\leftrightarrow}(x) = x^2(x-1)^2$ and $P_{1,4}^{\leftrightarrow}(x) = -x^3(x^2-3x+2)$. Suppose that $k \geq 3$ is an even and $P_{1,k-1}^{\leftrightarrow}(x) = -x^{2k-3}(x^2-3x+2)$. Then, $A_{1,k}^{\leftrightarrow} = [c_1, c_2, \dots, c_k, c_{k+1}]$, where for all $i \in \{3, 5, 7, \dots, k\}$, $c_i = [-1, \underbrace{1, \dots, 1}_{k\text{-times}}]^t$ and where for all $i \in \{4, 6, 8, \dots, k\}$, $c_i = [1, \underbrace{-1, \dots, -1}_{k\text{-times}}]^t$. It follows that

$$P_{1,k}^{\leftrightarrow}(x) = \det(A_{1,k}^{\leftrightarrow} - I_{(k+1) \times (k+1)} X) = \det(B_{1,k}^{\leftrightarrow}), \quad (41)$$

such that $B_{1,k}^{\leftrightarrow} = [b_{ij}]_{(k+1) \times (k+1)}$, where $B_{1,k}^{\leftrightarrow} = [c'_1, c'_2, \dots, c'_k, c'_{k+1}]$, where for all $i \in \{4, 6, 8, \dots, k\}$, $c'_i = [1, \underbrace{-1, \dots, -1}_{(i-2)\text{-times}}, \underbrace{-1-x}_{(i)^{\text{th}}}, \underbrace{-1, \dots, -1}_{(k+1-i)\text{-times}}]^t$ and for all $i \in \{3, 5, 7, \dots, k\}$, $c'_i = [-1, \underbrace{1, \dots, 1}_{(i-2)\text{-times}}, \underbrace{1-x}_{(i)^{\text{th}}}, \underbrace{1, \dots, 1}_{(k+1-i)\text{-times}}]^t$. Now,

consider $D_{1,k}^{\leftrightarrow} = (d_{ij})_{(k+1) \times (k+1)}$, where

$$d_{ij} = \begin{cases} b_{ij}, & 1 \leq j \leq k-1, \\ c'_k + c'_{k-1}, & j = k, \\ c'_{k+1} - c'_{k-1}, & j = k+1. \end{cases} \quad (42)$$

Thus, $D_{1,k}^{\leftrightarrow} = [c'_1, c'_2, \dots, c'_{k-1}, c''_k, c'_{k+1}]$, where $c''_k = [\underbrace{0, \dots, 0}_{(k-2)\text{-times}}, -x, -x, 0]^t = (-x)[\underbrace{0, \dots, 0}_{(k-2)\text{-times}}, 1, 1, 0]^t$ and $c''_{k+1} = [\underbrace{0, \dots, 0}_{(k-2)\text{-times}}, x, 0, -x]^t = (-x)[\underbrace{0, \dots, 0}_{(k-2)\text{-times}}, -1, 0, 1]^t$. Based on

induction assumption and computations of determinant based on column c''_{k+1} in matrix $D_{1,k}^{\leftrightarrow}$, we have

$$P_{1,k}^{\leftrightarrow}(x) = \det(D_{1,k}^{\leftrightarrow} - I_{(k+1) \times (k+1)} X) = (x^2)(P_{1,k-2}^{\leftrightarrow}(x)) = -(x^{2k-1})(x^2-3x+2). \quad (43)$$

In a similar way, if n is an odd, we get that $P_{1,n}^{\leftrightarrow}(x) = x^{n-1}(x-1)^2$.
 (ii) and (iii) They are clear by item (i). \square

Theorem 17. Let $|S_1| = n, |S_2| = 1, n \geq 3$ and $S_1 \leftrightarrow S_2$ of type $[-, +, -, +, \dots]$. Then,

$$P_{n,1}^{\leftrightarrow}(x) = \begin{cases} (-x)^{2k-1}(x^2 - 2x + 2), & n = 2k, \\ (-x)^{2k}(x^2 + x - 2), & n = 2k + 1. \end{cases} \quad (44)$$

Proof. Let $n = 3, n = 4$. It is easy to see that $P_{3,1}^{\leftrightarrow}(x) = x^2(x^2 + x - 2)$ and $P_{4,1}^{\leftrightarrow}(x) = (-x)^3(x^2 - 2x + 2)$. Suppose that $k \geq 3$ is an even and $P_{k-1,1}^{\leftrightarrow}(x) = (-x)^{2k-3}(x^2 - 2x + 2)$. Then, $A_{k,1}^{\leftrightarrow} = [c_1, c_2, \dots, c_k, c_{k+1}]$, where for all $i \in \{3, 5, \dots, k+1\}, c_i = \underbrace{[-1, \dots, -1]}_{k\text{-times}}, 1]^t$ and where for all $i \in \{4, 6, \dots, k\}, c_i = \underbrace{[1, \dots, 1]}_{k\text{-times}}, -1]^t$. It follows that

$$P_{k,1}^{\leftrightarrow}(x) = \det(A_{k,1}^{\leftrightarrow} - I_{(k+1) \times (k+1)} X) = \det(B_{k,1}^{\leftrightarrow}), \quad (45)$$

such that $B_{k,1}^{\leftrightarrow} = [b_{ij}]_{(k+1) \times (k+1)}$, where $B_{k,1}^{\leftrightarrow} = [c'_1, c'_2, \dots, c'_k, c'_{k+1}]$, where for all $i \in \{4, 6, \dots, k\}, c'_i = \underbrace{[1, \dots, 1]}_{(i-1)\text{-times}}, -1]^t$ and for all $i \in \{3, 5, \dots, k-1\}, c'_i = \underbrace{[1-x, 1, \dots, 1]}_{(i)\text{th}}, -1]^t$ and for all $i \in \{3, 5, \dots, k-1\}, c'_i = \underbrace{[-1, \dots, -1]}_{(i-1)\text{-times}}, -1-x, \underbrace{[-1, \dots, -1]}_{(k-i)\text{-times}}, 1]^t$ and for $i = k+1, c'_i = \underbrace{[-1, \dots, -1]}_{k\text{-times}}, 1-x]^t$. Now, consider $D_{k,1}^{\leftrightarrow} = (d_{ij})_{(k+1) \times (k+1)}$, where

$$d_{ij} = \begin{cases} b_{ij}, & j = 1, \dots, k-2, k+1, \\ c'_k + c'_{k-1}, & j = k-1, \\ c'_k + c'_{k+1}, & j = k. \end{cases} \quad (46)$$

Thus, $D_{k,1}^{\leftrightarrow} = [c'_1, c'_2, \dots, c'_{k-2}, c'_{k-1}, c''_k, c'_{k+1}]$, where $c'_{k-1} = \underbrace{[0, \dots, 0]}_{(k-2)\text{-times}}, -x, -x, 0]^t = (-x) \underbrace{[0, \dots, 0]}_{(k-2)\text{-times}}, 1, 1, 0]^t$ and $c''_k = \underbrace{[0, \dots, 0]}_{(k-1)\text{-times}}, -x, -x]^t = (-x) \underbrace{[0, \dots, 0]}_{(k-1)\text{-times}}, 1, 1]^t$. Based on induction assumption and computations of determinant based on column c''_k in matrix $D_{k,1}^{\leftrightarrow}$, we have

$$P_{k,1}^{\leftrightarrow}(x) = \det(D_{k,1}^{\leftrightarrow} - I_{(k+1) \times (k+1)} X) = (x^2)(P_{k-2,1}^{\leftrightarrow}(x)) = (-x)^{2k-1}(x^2 - 2x + 2). \quad (47)$$

In a similar way, if k is an odd, we get that $P_{k,1}^{\leftrightarrow}(x) = (-x)^{2k}(x^2 + x - 2)$.
 (ii) and (iii) They are clear by item (i) and (ii). \square

Theorem 18. Let $|S_1| = n, |S_2| = 2, n \geq 3$ and $S_1 \leftrightarrow S_2$ of type $[-, +, -, +, \dots]$. Then,

$$P_{n,2}^{\leftrightarrow}(x) = \begin{cases} x^{2k+1}(x-1), & n = 2k, \\ (-x)^{2k+3}, & n = 2k+1. \end{cases} \quad (48)$$

Proof. Let $n = 3$. It is easy to see that $P_{3,2}^{\leftrightarrow}(x) = (-x)^5$ and for $n = 4, P_{4,2}^{\leftrightarrow}(x) = x^5(x-1)$. Suppose that $k \geq 3$ is an odd and $P_{k-1,2}^{\leftrightarrow}(x) = (-x)^{2k+1}$. Then, $A_{k,2}^{\leftrightarrow} = [c_1, c_2, \dots, c_{k+1}, c_{k+2}]$, where for all $i \in \{3, 5, \dots, k+2\}, c_i = \underbrace{[-1, \dots, -1]}_{k\text{-times}}, 1, 1]^t$ and where for all $i \in \{4, 6, \dots, k+1\}, c_i = \underbrace{[1, \dots, 1]}_{k\text{-times}}, -1, -1]^t$. It follows that

$$P_{k,2}^{\leftrightarrow}(x) = \det(A_{k,2}^{\leftrightarrow} - I_{(k+2) \times (k+2)} X) = \det(B_{k,2}^{\leftrightarrow}), \quad (49)$$

such that $B_{k,2}^{\leftrightarrow} = [b_{ij}]_{(k+2) \times (k+2)}$, where $B_{k,2}^{\leftrightarrow} = [c'_1, c'_2, \dots, c'_{k+1}, c'_{k+2}]$, where for all $i \in \{3, 5, \dots, k\}, c'_i = \underbrace{[-1, \dots, -1]}_{(i-1)\text{-times}}, \underbrace{[-1-x]}_{(i)\text{th}}, \underbrace{[-1, \dots, -1]}_{(k-i)\text{-times}}, 1, 1]^t$ and for $i = k+2, c'_i = \underbrace{[-1, \dots, -1]}_{k\text{-times}}, 1, 1-x]^t$ and for all $i \in \{4, 8, \dots, k-1\}, c'_i = \underbrace{[1, \dots, 1]}_{(k-2)\text{-times}}, \underbrace{[1-x]}_{(i)\text{th}}, \underbrace{[1, \dots, 1]}_{(k-i)\text{-times}}, -1, -1]^t$ and for $i = k+1, c'_i = \underbrace{[1, \dots, 1]}_{k\text{-times}}, -1-x, -1]^t$. Now, consider $D_{k,2}^{\leftrightarrow} = (d_{ij})_{(k+2) \times (k+2)}$, where

$$d_{ij} = \begin{cases} b_{ij}, & j = 1, \dots, k-2, k+1, k+2, \\ c'_k + c'_{k-1}, & j = k-1, \\ c'_k + c'_{k+1}, & j = k. \end{cases} \quad (50)$$

Thus, $D_{k,2}^{\leftrightarrow} = [c'_1, c'_2, \dots, c'_{k-2}, c'_{k-1}, c''_k, c'_{k+1}, c'_{k+2}]$, where $c'_{k-1} = \underbrace{[0, \dots, 0]}_{(k-2)\text{-times}}, -x, -x, 0]^t = (-x) \underbrace{[0, \dots, 0]}_{(k-2)\text{-times}}, 1, 1, 0, 0]^t$ and $c''_k = \underbrace{[0, \dots, 0]}_{(k-1)\text{-times}}, -x, -x, 0]^t = (-x) \underbrace{[0, \dots, 0]}_{(k-1)\text{-times}}, 1, 1, 0]^t$.

Based on induction assumption and computations of determinant based on column c''_k in matrix $D_{k,2}^{\leftrightarrow}$, we have

$$P_{k,2}^{\leftrightarrow}(x) = \det(D_{k,2}^{\leftrightarrow} - I_{(k+2) \times (k+2)} X) = (x^2)(P_{k-2,2}^{\leftrightarrow}(x)) = (-x)^{2k+3}. \quad (51)$$

In a similar way, if k is an even, we get that $P_{k,2}^{\leftrightarrow}(x) = x^{2k+1}(x-1)$.
 (ii) and (iii) They are clear by item (i) and (ii). \square

Theorem 19. Let $|S_1| = n, |S_2| = 3, n \geq 2$ and $S_1 \leftrightarrow S_2$ of type $[-, +, -, +, \dots]$. Then,

$$P_{n,3}^{\leftrightarrow}(x) = \begin{cases} -x^{2k+1}(x^2 - 2x + 2), & n = 2k, \\ x^{2k+2}(x^2 + x - 2), & n = 2k + 1. \end{cases} \quad (52)$$

Proof. It is similar to Theorem 18. \square

Corollary 5. Let $|S_1| = n, |S_2| = m, n \geq 2, m \geq 1$ and $S_1 \leftrightarrow S_2$ of type $[-, +, -, +, \dots]$. If m is an odd, then,

- (i) $P_{n,m}^{\leftrightarrow}(x) = \begin{cases} -x^{2k+m-2}(x^2-2x+2) & n=2k(k \geq 1) \\ x^{2k+m-1}(x^2+x-2) & n=2k+1(k \geq 1) \end{cases}$
- (ii) If n is an odd, then, $\text{Spec}(A_{n,m}^{\leftrightarrow}) = \begin{pmatrix} 0 & -2 & 1 \\ n+m-2 & 1 & 1 \end{pmatrix}$,
- (iii) If n is an even, then, $\text{Spec}(A_{n,m}^{\leftrightarrow}) = \begin{pmatrix} 0 & 1+i & 1-i \\ n+m-2 & 1 & 1 \end{pmatrix}$,
- (iv) $\sum_{x \in E(A_{n,m})} x \neq 0$.

Corollary 6. Let $|S_1| = n, |S_2| = m, n \geq 2, m \geq 1$ and $S_1 \leftrightarrow S_2$ of type $[-, +, -, +, \dots]$. If m is an even, then,

- (i) $P_{n,m}^{\leftrightarrow}(x) = \begin{cases} x^{2k+m-1}(x-1) & n=2k(k \geq 1) \\ -(x^{2k+m+1}) & n=2k+1(k \geq 1) \end{cases}$
- (ii) If n is an odd, then, $\text{Spec}(A_{n,m}^{\leftrightarrow}) = \begin{pmatrix} 0 \\ n+m \end{pmatrix}$,
- (iii) If n is an even, then, $\text{Spec}(A_{n,m}^{\leftrightarrow}) = \begin{pmatrix} 0 & 1 \\ n+m-1 & 1 \end{pmatrix}$,
- (iv) $\sum_{x \in E(A_{n,m})} x \neq 0$.

4. Conclusions and Future Works

The current paper has introduced a novel concept of superhypergraphs as a generalization of graphs. The advantage of the notation of superhypergraphs is that it considers the relationship between a set of elements separately and as a whole, and this helps to eliminate the defects of graphs and superhypergraphs. The notation of superhypergraphs can be useful tools in modeling the real issues in engineering sciences and other sciences, especially network-related issues. For any given superhypergraph, the lower and upper bound of the number of the set of their superedges is computed and so it is computed and proved the number of all superhypergraphs constructed on any given nonempty set. Polynomial characteristics and eigenvalues of a matrix that represents a superhypergraph can provide useful information about the superhypergraph. The concept of the incidence matrix of superhypergraphs is presented and the characteristic polynomial of the incidence matrix of superhypergraphs and spectrum of superhypergraphs is analyzed and computed. It is shown that the spectrum of superhypergraphs depended on to flows of their maps between supervertices and the spectrum of superhypergraphs varies with the change of direction of flows. We presented and computed the spectrum of superhypergraphs with some types of flows such as one-sided flows, left to the right flows, right to left flows, and two-sided reverse flows. We hope that these results are helpful for further studies in the theory of graphs, hypergraphs, and superhypergraphs. In our future studies, we hope to obtain more results regarding domination sets and domination numbers of superhypergraphs, fuzzy superhypergraphs, and obtain some results in this regard and their applications in the real-world.

References

- [1] C. Berge, *Graphs and Hypergraphs*, Springer, North Holland, Netherlands, 1979.
- [2] J. Hou, M. Pelillo, and H. Yuan, "Hypergraph matching via game-theoretic hypergraph clustering," *Pattern Recognition*, vol. 125, Article ID 108526, 2022.
- [3] Y. Qian, H. Meng, W. Lu, Z. Liao, Y. Ding, and H. Wu, "Identification of DNA-binding proteins via hypergraph based laplacian support vector machine," *Current Bioinformatics*, vol. 17, no. 1, pp. 108–117, 2022.
- [4] D. Tocchi, C. Sys, A. Papola, F. Tinessa, F. Simonelli, and V. Marzano, "Hypergraph-based centrality metrics for maritime container service networks: a worldwide application," *Journal of Transport Geography*, vol. 98, Article ID 103225, 2022.
- [5] P. Zhou, X. Wang, L. Du, and X. Li, "Clustering ensemble via structured hypergraph learning," *Information Fusion*, vol. 78, pp. 171–179, 2022.
- [6] X. Hao, Ji. Li, Y. Guo, Ta. Jiang, and M. Yu, "Hypergraph neural network for skeleton-based action recognition," *IEEE Transactions on Image Processing*, vol. 30, pp. 2263–2275, 2021.
- [7] M. Amin Bahmanian and M. Newman, "Extending factorizations of complete uniform hypergraphs," *Combinatorica*, vol. 38, no. 6, pp. 1309–1335, 2018.
- [8] C. Annamalai, "Finding perfect matchings in bipartite hypergraphs," *Combinatorica*, vol. 38, no. 6, pp. 1285–1307, 2018.
- [9] P. Frankl, "Resilient hypergraphs with fixed matching number," *Combinatorica*, vol. 38, no. 5, pp. 1079–1094, 2018.
- [10] A. Banerjee, "On the spectrum of hypergraphs," *Linear Algebra and Its Applications*, vol. 614, no. 1, pp. 82–110, 2021.
- [11] A. Howlader and P. Panigrahi, "On the distance spectrum of minimal cages and associated distance biregular graphs," *Linear Algebra and Its Applications*, vol. 636, no. 1, pp. 115–133, 2022.
- [12] P. Renteln, "On the spectrum of the perfect matching derangement graph," *Journal of Algebraic Combinatorics*, 2022.
- [13] P. Vrana, "Probabilistic refinement of the asymptotic spectrum of graphs," *Combinatorica*, vol. 41, no. 6, pp. 873–904, 2021.
- [14] M. Hamidi and A. Saeid, "Accessible spectrum of graphs," *Applicable Analysis and Discrete Mathematics*, vol. 15, no. 1, pp. 001–026, 2021.
- [15] L. A. Zadeh, "Fuzzy sets," *Information and Control*, vol. 8, no. 3, pp. 338–353, 1965.
- [16] A. Kaufmann, *Introduction Ci la Thiorie des Sous-Ensemble Flous*, Masson, Paris, France, 1977.
- [17] M. Akram and A. Luqman, "Fuzzy hypergraphs and related extensions," *Studies in Fuzziness and Soft Computing*, vol. 390, 2020.
- [18] H. S. Nawaz, M. Akram, and J. C. R. Alcantud, "An algorithm to compute the strength of competing interactions in the Bering Sea based on Pythagorean fuzzy hypergraphs," *Neural Computing & Applications*, vol. 34, no. 2, pp. 1099–1121, 2022.
- [19] M. Sarwar, M. Akram, and S. Shahzadi, "Bipolar fuzzy soft information applied to hypergraphs," *Soft Computing*, vol. 25, no. 5, pp. 3417–3439, 2021.
- [20] F. Smarandache, "Extension of HyperGraph to n-Super-HyperGraph and to plithogenic n-SuperHyperGraph, and extension of HyperAlgebra to n-ary (Classical-/Neutro-/Anti-) HyperAlgebra," *Neutrosophic Sets and Systems*, vol. 33, pp. 290–296, 2020.

PLITHOGENY

Plithogenic Probability & Statistics are generalizations of MultiVariate Probability & Statistics

Florentin Smarandache

Florentin Smarandache (2021). Plithogenic Probability & Statistics are generalizations of MultiVariate Probability & Statistics. *Neutrosophic Sets and Systems* 43, 280-289

Abstract: In this paper we exemplify the types of Plithogenic Probability and respectively Plithogenic Statistics. Several applications are given.

The Plithogenic Probability of an event to occur is composed from the chances that the event occurs with respect to all random variables (parameters) that determine it. Each such a variable is described by a Probability Distribution (Density) Function, which may be a classical, (T,I,F)-neutrosophic, I-neutrosophic, (T,F)-intuitionistic fuzzy, (T,N,F)-picture fuzzy, (T,N,F)-spherical fuzzy, or (other fuzzy extension) distribution function.

The Plithogenic Probability is a generalization of the classical MultiVariate Probability.

The analysis of the events described by the plithogenic probability is the Plithogenic Statistics.

Keywords: MultiVariate Probability; MultiVariate Statistics; Plithogenic Probability; Plithogenic Refined Probability; Plithogenic Statistics; Plithogenic Refined Statistics; Neutrosophic Data; Neutrosophic Sample, Neutrosophic Population, Neutrosophic Random Variables; Plithogenic Variate Data

1. Introduction

The Plithogeny, as generalization of Dialectics and Neutrosophy, and then its applications to Plithogenic Set/Logic/Probability/Statistics (as generalization of fuzzy, intuitionistic fuzzy, neutrosophic set/logic/probability/statistics) [1, 2] were introduced by Smarandache in 2017.

Plithogeny is the genesis or origination, creation, formation, development, and evolution of new entities from dynamics and organic fusions of contradictory and/or neutrals and/or non-contradictory multiple old entities.

Plithogenic means what is pertaining to plithogeny. Etymologically, plitho-geny comes from: (Gr.) πλήθος (plithos) = crowd, many while -geny < (Gr.) -γενιά (-geniá) = generation, the production of something

2. Neutrosophic (or Indeterminate) Data

Neutrosophic (or Indeterminate) Data is a vague, unclear, incomplete, partially unknown, conflicting indeterminate data. The neutrosophic data can be metrical, or categorical, or both. Plithogenic Variate Data summarizes the associations (or inter-relationships) between Neutrosophic variables. While Neutrosophic Variable is a variable (or function, operator), that deals with neutrosophic data) either in its arguments or in its values, or in both. The problem to solve may have many dimensions, therefore multiple measurements and observations are needed since there are many sides to the problem, not only one. Neutrosophic variables may be: dependent; independent; or partially dependent, partially independent, and partially indeterminate.

(i.e. unknown if dependent or independent). The data's attributes (features, functions etc.) are investigated by survey-based techniques within the frame of Neutrosophic Conjoint Analysis (which includes the choice based conjoint and the adaptive choice-based conjoint.) Indeterminacy may occur at the level of attributes as well. We may thus deal with neutrosophic (indeterminate, unclear, partially known etc.) attributes [3-14].

3. Classical MultiVariate Analysis vs. Plithogenic Variate Analysis

The **Classical MultiVariate Analysis** (MVA) studies a system, which is characterized by many variables, or one may call it a system-of-systems. The variables, i.e. the subsystems, and the system as a whole are also classical (i.e. they do not deal with indeterminacy). Many classical measurements are needed, and the classical relations between variables to be determined. This system-of-systems is generally represented by a surrogate approximate model.

The **Plithogenic Variate Analysis** (PVA) is an extension of of the classical MultiVariate Analysis, where indeterminate data or procedures, that are called neutrosophic data and respectively neutrosophic procedures, are allowed. Therefore PVA deals with neutrosophic/indeterminate variables, neutrosophic/indeterminate subsystems, and neutrosophic/indeterminate system-of-systems as a whole.

Therefore the Plithogenic Variate Analysis studies a neutrosophic/indeterminate system as a whole, characterized by many neutrosophic/indeterminate variables (i.e. neutrosophic/indeterminate sub-systems), and many neutrosophic/indeterminate relationships. Hence many neutrosophic measurements and observations are needed.

The Plithogenic Variate Analysis requires complex computations, hence it is more complicated than the Classical MultiVariate Analysis due to the neutrosophic (indeterminate) data it deals with; nonetheless the PVA better reflects our world, giving results nearer to real-life situation. With the dramatic increase of computers power this complexity is overcome.

The Plithogenic Variate Analysis elucidates each attribute of the data, using various methods, such as: regression/factor/cluster/path/discriminant/latent (trait or profile)/multilevel analysis / structural equation/recursive partition/redundancy/ constrained correspondence/ artificial neural networks, multidimensional scaling, and so on.

The **Plithogenic UniVariate Analysis** (PUVA) comprises the procedures for analysis of neutrosophic/indeterminate data that contains only one neutrosophic/indeterminate variable.

4. Plithogenic Probability

The Plithogenic Probability of an event to occur is composed from the chances that the event occurs with respect to all random variables (parameters) that determine it.

The Plithogenic Probability, based on Plithogenic Variate Analysis, is a multi-dimensional probability ("plitho" means "many", synonym with "multi"). We may say that it is a probability of sub-probabilities, where each sub-probability describes the behavior of one variable. We assume that the event we study is produced by one or more variables.

Each variable is represented by a **Probability Distribution (Density) Function** (PDF).

5. Subclasses of Plithogenic Probability are:

- (i) If all PDFs are classical, then we have a classical **MultiVariate Probability**.
- (ii) If all PDFs are in the neutrosophic style, i.e. of the form (T, I, F) ,
 where T is the chance that the event occurs,
 I is the indeterminate-chance of the event to occur or not,
 and F is the chance that the event do not occur, with $T, I, F \in [0, 1], 0 \leq T+I+F \leq 3$,
 then we have a **Plithogenic Neutrosophic Probability**.
- (iii) If all PDFs are indeterminate functions (i.e. functions that have indeterminate data in their arguments, or in their values, or in both),

then we have a **Plithogenic Indeterminate Probability**.

- (iv) If all PDFs are Intuitionistic Fuzzy in the form of (T, F) , where T is the chance that the event occurs, and F is the chance that the event do not occur, with $T, F \in [0, 1], 0 \leq T + F \leq 1$, then we have a **Plithogenic Intuitionistic Fuzzy Probability**.
- (v) If all PDFs are in the Picture Fuzzy Set style, i.e. of the form (T, N, F) , where T is the chance that the event occurs, N is the neutral-chance of the event to occur or not, and F is the chance that the event do not occur, with $T, N, F \in [0, 1], 0 \leq T + N + F \leq 1$, then we have a **Plithogenic Picture Fuzzy Probability**.
- (vi) If all PDFs are in the Spherical Fuzzy Set style, i.e. of the form (T, H, F) , where T is the chance that the event occurs, H is the neutral-chance of the event to occur or not, and F is the chance that the event do not occur, with $T, H, F \in [0,1], 0 \leq T^2 + H^2 + F^2 \leq 1$, then we have a **Plithogenic Spherical Fuzzy Probability**.
- (vii) In general, if all PDFs are in any (fuzzy-extension set) style, then we have a **Plithogenic (fuzzy-extension) Probability**.
- (viii) If some PDFs are in one of the above styles, while others are in different styles, then we have a **Plithogenic Hybrid Probability**.

6. Plithogenic Refined Probability

The most general form of probability is **Plithogenic Refined Probability**, when the components of T (Truth = Occurrence), I (Indeterminate-Occurrence), and F (Falsehood-NonOccurrence) are refined/split into sub-components: T_1, T_2, \dots, T_p (sub-truths = sub-occurrences) and I_1, I_2, \dots, I_r (sub-indeterminate-occurrences), and F_1, F_2, \dots, F_s (sub-falsehoods = sub-nonoccurrences), where $p, r, s \geq 0$ are integers, and $p + r + s \geq 1$.

All the above sub-classes of plithogenic probability may be refined this way.

7. Convergence from MultiVariate to UniVariate Analysis

In order to be able to make a decision, we need to convert from Plithogenic (*MultiVariate*) Probability and Statistics to Plithogenic *UniVariate* Probability and Statistics. Actually we need to fusion (combine) all variables and obtain a single cumulative variable.

The **Classical Probability Space** is complete, i.e. all possible event that may occur are known.

For example, let's consider a soccer game between teams A and B. The classical probability space is $CPS = \{A \text{ wins, tie game, B wins}\}$.

The **Neutrosophic Probability Space** is in general incomplete, i.e. not all possible events are known, and there also are events that are only partially known. In our world, most real probability spaces are neutrosophic.

Example. Considering the same soccer game, the neutrosophic probability space $NPS = \{A \text{ wins, tie game, B wins, interrupted game, etc.}\}$, "interrupted" means that due to some unexpected weather conditions, or to a surprising terrorist attack on the stadium, etc. the game is interrupted and rescheduled (this has happened in our world many times).

Let's assume an event E in a given (classical or neutrosophic) probability space is determined by $n \geq 2$ variables v_1, v_2, \dots, v_n , and we denote it as $E(v_1, v_2, \dots, v_n)$. The multi-variate probability of the event E to occur, denoted by $MVP(E)$, depends on many probabilities, i.e. on the probability that the event E occurs with respect to variable v_1 , denoted by $P_1(E(v_1))$, on the probability that the event E occurs with respect to variable v_2 , denoted by $P_2(E(v_2))$, and so on.

Therefore, $MVP(E(v_1, v_2, \dots, v_n)) = (P_1(E(v_1)), P_2(E(v_2)), \dots, P_n(E(v_n)))$.

The variables v_1, v_2, \dots, v_n , and the probabilities P_1, P_2, \dots, P_n , may be classical, or having some degree of indeterminacy.

In order to convert from multi-probability to uni-probability, we apply various logical operators (conjunctions, disjunctions, negations, implications, etc. and their combinations, depending on the application to do and on the expert) on the multi-probability.

Such applications are presented towards the end of the paper.

7. Plithogenic Statistics

Plithogenic Statistics (PS) encompasses the analysis and observations of the events studied by the Plithogenic Probability.

Plithogenic Statistics is a generalization of classical MultiVariate Statistics, and it is a simultaneous analysis of many outcome neutrosophic/indeterminate variables, and it as well is a multi-indeterminate statistics.

8. Subclasses of Plithogenic Statistics are:

- MultiVariate Statistics
- Plithogenic Neutrosophic Statistics
- Plithogenic Indeterminate Statistics
- Plithogenic Intuitionistic Fuzzy Statistics
- Plithogenic Picture Fuzzy Statistics
- Plithogenic Spherical Fuzzy Statistics
- and in general: Plithogenic (*fuzzy-extension*) Statistics
- and Plithogenic Hybrid Statistics.

9. **Plithogenic Refined Statistics** are, similarly, the most general form of statistics that studies the analysis and observations of the events described by the Plithogenic Refined Probability.

10. Applications of Plithogenic Probability

We retour our 2017 example [1] and pass it through all sub-classes of Plithogenic Probability.

In the Spring 2021 semester, at The University of New Mexico, United States, in a program of Electrical Engineering, Jenifer needs to pass four courses in order to graduate at the end of the semester: two courses of Mathematics (Second Order Differential Equations, and Stochastic Analysis), and two courses of Mechanics (Fluid Mechanics and Solid Mechanics). What is the Plithogenic Probability that Jenifer will graduate?

Her chances of graduating are estimated by the university's advisors.

There are four variables (courses), v_1, v_2, v_3, v_4 respectively, that generate four probability distributions. We consider the discrete probability distribution functions.

[For the continuous ones, it will be similar.]

10.1. Classical MultiVariate Probability (CMVP)

The advisers have estimated that $CMVP(Jenifer) = (0.5, 0.6, 0.8, 0.4)$,

which means that Jenifer has 50% chance to pass the Second Order Differential Equations class, 60% chance of passing the Stochastic Analysis class (both as part of Mathematics), and 80% chance of passing the Fluid Mechanics class, and 40% chance of passing the Solid Mechanics class (both as part of Mechanics).

Since she has to pass all four classes, Jenifer's chance of graduating is $\min\{0.5, 0.6, 0.8, 0.4\} = 0.4$ or 40% chance.

10.2 Plithogenic Neutrosophic Probability

$PNP(Jenifer) = ((0.5, 0.9, 0.2), (0.6, 0.7, 0.4); (0.8, 0.2, 0.1), (0.4, 0.3, 0.5))$,

which similarly means that :

Jenifer's chance to pass the Second Order Differential Equations class is 50%, and the indeterminate chance is 90%, and the chance to fail it is 20%. Similarly for the other three classes.

In conclusion: $(\min\{0.5, 0.6, 0.8, 0.4\}, \max\{0.9, 0.7, 0.2, 0.3\}, \max\{0.2, 0.4, 0.1, 0.5\}) = (0.4, 0.9, 0.5)$.

10.3. Plithogenic Indeterminate Probability

$PIP(\text{Jenifer}) = ([0.4, 0.5], 0.2 \text{ or } 0.4, 0.1 \text{ or unknown})$
 which unclear information, i.e. chance of graduating is between [40%, 50%], 20% or 40% is indeterminate-chance of graduating, and chance of not graduating is 10% or unknown (i.e. the advisors were not able to estimate it well).

10.4. Plithogenic Intuitionistic Fuzzy Probability (PIFP) provides more information

$PIFP(\text{Jenifer}) = ((0.5, 0.2), (0.6, 0.4); (0.8, 0.1), (0.4, 0.5))$,
 which means that Jenifer has 50% chance to pass the Second Order Differential Equations class, and 20% chance to fail it. And similarly for the other three classes.
 In conclusion: $((\min\{0.5, 0.6, 0.8, 0.4\}, \max\{0.2, 0.4, 0.1, 0.5\}) = (0.4, 0.5)$.

10.5. Plithogenic Picture Fuzzy Probability (PPFP) brings even more information

$PPFP(\text{Jenifer}) = ((0.5, 0.1, 0.2), (0.6, 0.0, 0.4); (0.8, 0.1, 0.1), (0.4, 0.0, 0.5))$,
 which means that Jenifer’s chance to pass the Second Order Differential Equations class is 50%, and 10% neutral chance, and 20% chance to fail it. Similarly for the other three classes.
 In conclusion: $PSFP(\text{Jenifer}) = ((\min\{0.5, 0.6, 0.8, 0.4\}, \max\{0.1, 0.0, 0.1, 0.0\}, \max\{0.2, 0.4, 0.1, 0.5\}) = (0.4, 0.1, 0.5)$.

10.6. Plithogenic Spherical Fuzzy Probability (PSFP) enlarges the value spectrum of the previous one

$PSFP(\text{Jenifer}) = ((0.5, 0.3, 0.2), (0.6, 0.5, 0.4); (0.8, 0.3, 0.1), (0.4, 0.6, 0.5))$,
 with the same meaning as the previous one.
 In conclusion: $PSFP(\text{Jenifer}) = ((\min\{0.5, 0.6, 0.8, 0.4\}, \max\{0.3, 0.5, 0.3, 0.6\}, \max\{0.2, 0.4, 0.1, 0.5\}) = (0.4, 0.6, 0.5)$.

10.7. Plithogenic Hybrid Probability (PHP)

$PHP(\text{Jenifer}) = (0.5; (0.7, 0.1, 0.4); (0.1, 0.2); 0.4 \text{ or } 0.3)$,
 which means that Jenifer has 50% chance to pass the Second Order Differential Equations class; 70% chance of passing and 10% indeterminate-chance and 40% chance of failing the Stochastic Analysis class (both as part of Mathematics); and 10% chance of passing and 20% of failing the Fluid Mechanics class; and 40% or 30% chance of passing the Solid Mechanics class (both as part of Mechanics).

We have mixed herein: the fuzzy, neutrosophic, intuitionistic fuzzy, and indeterminate above cases.

Or $PHP(\text{Jenifer}) = ((0.5, 0.0, 0.0); (0.7, 0.1, 0.4); (0.1, 0.7, 0.2); (0.4 \text{ or } 0.3, 0.0, 0.0))$, since for the intuitionistic fuzzy the hesitancy is : $1 - 0.1 - 0.2 = 0.7$.

In conclusion: $PHP(\text{Jenifer}) = ((\min\{0.5, 0.7, 0.1, 0.4 \text{ or } 0.3\}, \max\{0.0, 0.1, 0.7, 0.0\}, \max\{0.0, 0.4, 0.2, 0.0\}) = (0.1, 0.7, 0.4)$.

10.8. Plithogenic Refined Probability (PRP)

Let’s assume that for each class, Jenifer has to pass an oral test and a written test. Therefore T,I,F are refined/split into:

T1(oral test), T2(written test);

I1(oral test), I2(written test);

F1(oral test), F2(written test).

Then, we may have, as an example:

$$\begin{aligned} \text{PRP}(\text{Jenifer}) = & (((0.5, 0.6), (0.4, 0.7), (0.1, 0.2)), \\ & ((0.6, 0.8), (0.0, 0.7), (0.3, 0.4)), \\ & ((0.8, 0.8), (0.1, 0.2), (0.1, 0.0)), \\ & ((0.3, 0.7), (0.2, 0.3), (0.5, 0.4))), \end{aligned}$$

which means :

with respect to the first class,

Jenifer's chance to pass the oral test is 50% and the written test is 60%;

indeterminate-chance to pass the oral test is 40% and the written test is 70%;

and chance not to pass the oral test is 10% and the written test 20%.

Similarly for the other classes.

11. Converging/Transforming from MultiVariate to UniVariate Analysis

11.1. From Classical MultiVariate Probability (CMVP) to UniVariate Probability

(i) Since Jenifer has to pass *all* four classes, we use the conjunction operator: $v_1 \wedge v_2 \wedge v_3 \wedge v_4$. In this case it is fuzzy conjunction (t-norm).

Therefore, Jenifer's chance of graduating is $\text{CMVP}(\text{Jenifer}) = \min\{0.5, 0.6, 0.8, 0.4\} = 0.4$, or 40% chance.

(ii) Let's change the example and assume that for Jenifer to graduate she needs to pass at least one class among the four. Now we use the disjunction operator: $v_1 \vee v_2 \vee v_3 \vee v_4$ or fuzzy disjunction (t-conorm). Therefore, Jenifer's chance of graduating is $\text{CMVP}(\text{Jenifer}) = \max\{0.5, 0.6, 0.8, 0.4\} = 0.8$, or 80% chance.

(iii) Let's change again the example and assume that for Jenifer to graduate she needs to pass at least one class of Mathematics and at least one class of Mechanics. Then, we use a mixture of conjunctions and disjunctions: $\text{CMVP}(\text{Jenifer}) = (v_1 \vee v_2) \wedge (v_3 \vee v_4) = \min\{\max\{v_1, v_2\}, \max\{v_3, v_4\}\} = \min\{\max\{0.5, 0.6\}, \max\{0.8, 0.4\}\} = \min\{0.6, 0.8\} = 0.6$, or 60% chance.

11.2 From Plithogenic Neutrosophic Probability (PNP) to UniVariate Neutrosophic Probability

In conclusion: $\text{PNP}(\text{Jenifer}) = ((\min\{0.5, 0.6, 0.8, 0.4\}, \max\{0.9, 0.7, 0.2, 0.3\}, \max\{0.2, 0.4, 0.1, 0.5\})) = (0.4, 0.9, 0.5)$.

11.3. This Plithogenic Indeterminate Probability happens to be a UniVariate Indeterminate Probability

Therefore, no converting (or transformation) needed.

$$\text{PIP}(\text{Jenifer}) = ([0.4, 0.5], 0.2 \text{ or } 0.4, 0.1 \text{ or unknown})$$

with unclear information, i.e. chance of graduating is between [40%, 50%], 20% or 40% indeterminate-chance of graduating, and chance of not graduating is (10% or unknown – i.e. the advisors were not able to estimate it well).

11.4. From Plithogenic Intuitionistic Fuzzy Probability (PIFP) to UniVariate Intuitionistic Fuzzy Probability

In conclusion: $\text{PIPF}(\text{Jenifer}) = ((\min\{0.5, 0.6, 0.8, 0.4\}, \max\{0.2, 0.4, 0.1, 0.5\})) = (0.4, 0.5)$, which means that chance of graduating is 40%, and chance of not graduating 50%.

11.5. From Plithogenic Picture Fuzzy Probability (PPFP) to UniVariate Picture Fuzzy Probability

In conclusion: $\text{PSFP}(\text{Jenifer}) = ((\min\{0.5, 0.6, 0.8, 0.4\}, \max\{0.1, 0.0, 0.1, 0.0\}, \max\{0.2, 0.4, 0.1, 0.5\})) = (0.4, 0.1, 0.5)$, or 40% chance to graduate, 10% neutral chance, and 50% chance not to graduate.

11.6. From Plithogenic Spherical Fuzzy Probability (PSFP) to UniVariate Spherical Fuzzy Probability

In conclusion: PSFP(Jenifer) = ((min{0.5, 0.6, 0.8, 0.4}, max{0.3, 0.5, 0.3, 0.6}, max{0.2, 0.4, 0.1, 0.5}) = (0.4, 0.6, 0.5), or 40% chance to graduate, 60% hesitant chance, and 50% chance not to graduate.

11.7. From Plithogenic Hybrid Probability (PHP) to UniVariate Hybrid Probability

In conclusion: PHP(Jenifer) = ((min{0.5, 0.7, 0.1, 0.4 or 0.3}, max{0.0, 0.1, 0.7, 0.0}, max{0.0, 0.4, 0.2, 0.0}) = (0.1, 0.7, 0.4).

10.8. From Plithogenic Refined Probability (PRP) to UniVariate Refined Probability ???

Taking min of T1’s, min T2’s, and max of I1’s, max of I2’s, and max of F1’s, F2’s, one gets:

$$PRP(Jenifer) = ((0.3, 0.6), (0.4, 0.7), (0.5, 0.4)).$$

Whence, Jenifer’s chance, with respect to all classes,

to pass the oral test is 30% and the written test is 60%;

indeterminate-chance to pass the oral test is 40% and the written test is 70%;

and chance not to pass the oral test is 50% and the written test 40%.

But, with respect to graduation, we use again the fuzzy conjunction:

$$PRP(Jenifer) = (min\{0.3, 0.6\}, max\{0.4, 0.7\}, max\{0.5, 0.4\}) = (0.3, 0.7, 0.5),$$

or Jenifer’s chance to graduate is 30%, indeterminate-chance of graduating 70%, and 50% chance not to graduate.

11. Corresponding Applications of Plithogenic Statistics

A prospective is made on the university student population, that was enrolled this semester, in order to determine the chance of the average students to graduate.

Let’s take a random sample of the university’s student population in order to investigate what’s the chance of graduating for an enrolled average student.

By *inference statistics*, we estimate the population’s average student to be similar to the sample’s average student.

We may have a **classical random sample**, i.e. the sample size is known and all sample individuals belong 100% of the population - i.e. the individuals are full-time students; or a **neutrosophic random sample** {i.e. the sample size may be unknown or only approximately known), and some or all individuals may only partially belonging to the population (for example part-time students), or may have taken some extra classes above the norm.

Even the university’s student population is a **neutrosophic population**, since the number of students changes almost continuously (some students drop, others enroll earlier or later), and not all students are 100% enrolled: there are full-time, part-time, and even over-time (i.e. students enrolled in more than the required full time number or credit hour classes).

In a **classical population**, the population size is known, and all population individuals belong 100% to the population.

Let T = truth, with T belongs to [0,1], be the chance to graduate, I = indeterminate, with I belongs to [0,1], be the indeterminate-chance to graduate, and F = falsehood, with F belongs to [0,1], be the chance not to graduate, where $0 \leq T + I + F \leq 3$.

Let’s assume, the classical or neutrosophic random sample has the size $n \geq 2$, and a student $S_j, 1 \leq j \leq n$, has the plithogenic neutrosophic probability of (graduating, indeterminate-graduating, not graduating), respectively (T_j, I_j, F_j) , with all T_j, I_j, F_j belong to [0, 1], $0 \leq T_j + I_j + F_j \leq 3$.

Make the average of all sample students, assuming the sample size is $n \geq 2$,

$$\frac{1}{n} \sum_{j=1}^n (T_j, I_j, F_j) = \left(\frac{1}{n} \sum_{j=1}^n T_j, \frac{1}{n} \sum_{j=1}^n I_j, \frac{1}{n} \sum_{j=1}^n F_j \right).$$

For the Plithogenic Refined Neutrosophic Probabilities, the average is a straight-forward extension. Let the student $S_j, 1 \leq j \leq n$, have the Plithogenic Refined Neutrosophic Probability:

$$\text{PRNP}(S_j) = (T_1(j), T_2(j), \dots, T_p(j); I_1(j), I_2(j), \dots, I_r(j); F_1(j), F_2(j), \dots, F_s(j))$$

where $p, r, s \geq 0$ are integers, and $p + r + s \geq 1$.

The refined neutrosophic sub-components with index 0, such as $T_0(j), I_0(j), F_0(j)$, if any, are discarded.

All refined neutrosophic sub-components

$$T_k(j), 1 \leq k \leq p, I_l(j), 1 \leq l \leq r, F_m(j), 1 \leq m \leq s, \text{ are single-valued in } [0, 1].$$

Then, the average of PRNPs of the sample students is:

$$\begin{aligned} & \frac{1}{n} \sum_{j=1}^n \text{PRNP}(S_j) = \frac{1}{n} \sum_{j=1}^n (T_1(j), T_2(j), \dots, T_p(j); I_1(j), I_2(j), \dots, I_r(j); F_1(j), F_2(j), \dots, F_s(j)) \\ = & \left(\frac{1}{n} \sum_{j=1}^n T_1(j), \frac{1}{n} \sum_{j=1}^n T_2(j), \dots, \frac{1}{n} \sum_{j=1}^n T_p(j); \frac{1}{n} \sum_{j=1}^n I_1(j), \frac{1}{n} \sum_{j=1}^n I_2(j), \dots, \frac{1}{n} \sum_{j=1}^n I_r(j); \frac{1}{n} \sum_{j=1}^n F_1(j), \frac{1}{n} \sum_{j=1}^n F_2(j), \dots, \frac{1}{n} \sum_{j=1}^n F_s(j) \right) \end{aligned}$$

And we get the sample average students' plithogenic refined probability to (graduate, indeterminate graduate, not graduate).

For the cases when one or two among T, I, F are missing, we simply discard them.

An average student is not among the best, not among the worst.

Let's consider Jenifer is an average student, whose plithogenic probabilities have been obtained after sampling and computing the average of plithogenic probabilities of all its students - since we have already her data.

Considering the inference statistics, we simply substitute Jenifer by average student.

We consider the simplest case when T,I,F are single-valued neutrosophic (SVN) components in $[0,1]$. But the cases when T,I,F are hesitant-valued (finite discrete subsets of $[0,1]$) neutrosophic HVN components, or interval-valued included in $[0,1]$ neutrosophic (IVN) component, or in general subset-valued included in $[0,1]$ neutrosophic (SVN) components.

10.1. Classical MultiVariate Statistics (CMVS)

Since the average student has to pass all four classes, his chance of graduating is $\min\{0.5, 0.6, 0.8, 0.4\} = 0.4$ or 40% chance. In conclusion: $\text{CMVS}(\text{average student}) = 0.4$.

10.2. Plithogenic Neutrosophic Statistics (PNS)

In conclusion: $\text{PNP}(\text{average student}) = ((\min\{0.5, 0.6, 0.8, 0.4\}, \max\{0.9, 0.7, 0.2, 0.3\}, \max\{0.2, 0.4, 0.1, 0.5\})) = ((0.4, 0.9, 0.5))$.

An average student has 40% chance to graduate, 90% indeterminate chance of graduating, and 50% chance not to graduate.

10.3. Plithogenic Indeterminate Statistics

An average student has (40% or 50%) chance of graduating, 90% indeterminate chance of graduating, and (50% or unknown) chance of not graduating.

10.4. Plithogenic Intuitionistic Fuzzy Statistics

An average student has 40% chance to graduate and 50% chance not to graduate.

10.5. *Plithogenic Picture Fuzzy Statistics*

An average student has 40% chance to graduate, 10% indeterminate chance to graduate, and 50% chance not to graduate.

10.6. *Plithogenic Spherical Fuzzy Statistics*

An average student has 40% chance to graduate, 60% indeterminate chance of graduating, and 50% chance not to graduate.

10.7. *Plithogenic Hybrid Statistics*

An average student has 40% chance to graduate, 60% indeterminate chance of graduating, and 50% chance not to graduate.

10.8. *Plithogenic Refined Statistics*

An average student's chance to graduate is 30%, indeterminate-chance of graduating 70%, and 50% chance not to graduate.

11. Conclusion

We have presented in this paper many types of Plithogenic Probability and corresponding Plithogenic Statistics, together with some application.

The Plithogenic Probability of an event to occur is composed from the chances that the event occurs with respect to all random variables (parameters) that determine it. Each such a variable is described by a Probability Distribution (Density) Function, which may be a classical, (T,I,F)-neutrosophic, I-neutrosophic, (T,F)-intuitionistic fuzzy, (T,N,F)-picture fuzzy, (T,N,F)-spherical fuzzy, or (other fuzzy extension) distribution function.

The Plithogenic Probability is a generalization of the classical MultiVariate Probability.

The analysis of the events described by the plithogenic probability constitutes the Plithogenic Statistics.

References

1. F. Smarandache, *Plithogeny, Plithogenic Set, Logic, Probability, and Statistics*, Pons Editions, Brussels, 141 p., 2017; <http://fs.unm.edu/Plithogeny.pdf> (all websites were accessed on April 22, 2021)
2. F. Smarandache, *Plithogenic Set, an Extension of Crisp, Fuzzy, Intuitionistic Fuzzy, and Neutrosophic Sets – Revisited*, *Neutrosophic Sets and Systems*, vol. 21, 2018, pp. 153-166. <https://doi.org/10.5281/zenodo.1408740>, <http://fs.unm.edu/NSS/PlithogenicSetAnExtensionOfCrisp.pdf>

3. Jeff Kaplan (archivist), Neutrosophic Statistics is a generalization of Classical Statistics, in Internet Archives, San Francisco, California, USA, <https://archive.org/details/neutrosophic-statistics?tab=about> and <https://archive.org/details/neutrosophic-statistics?tab=collection> (accessed on April 22nd, 2021)
4. S. Gomathy, D. Nagarajan, S. Broumi, M. Lathamaheswari, Plithogenic sets and their application in decision making, *Neutrosophic Sets and Systems*, vol. 38, 2020, pp. 453-469. DOI: 10.5281/zenodo.4300565, <http://fs.unm.edu/NSS/PlithogenicSetsAndTheirApplication30.pdf>
5. Gustavo Álvarez Gómez, Jorge Viteri Moya, Jesús Estupiñán Ricardo, Cristina Belén Viteri Sanchez, Evaluating Strategies of Continuing Education for Academics Supported in the Pedagogical Model and Based on Plithogenic Sets, *Neutrosophic Sets and Systems*, vol. 37, 2020, pp. 16-23. DOI: 10.5281/zenodo.4121980, <http://fs.unm.edu/NSS/3EvaluatingStrategiesContinuing.pdf>
6. Rously Eedyah Atencio González, Julio César de Jesús Arrias Añez, Johanna Emperatriz Coronel Piloso, Orlando Iván Ronquillo Riera, Prioritization of the Social Approach of Employment Modeled by Plithogenic Sets, *Neutrosophic Sets and Systems*, vol. 37, 2020, pp. 184-192. DOI: 10.5281/zenodo.4122116, <http://fs.unm.edu/NSS/22PrioritizationSocialApproach.pdf>
7. Nivetha Martin and Florentin Smarandache, Introduction to Combined Plithogenic Hypersoft Sets, *Neutrosophic Sets and Systems*, vol. 35, 2020, pp. 503-510. DOI: 10.5281/zenodo.3951708, <http://fs.unm.edu/NSS/IntroductionToCombined28.pdf>
8. Nivetha Martin and Florentin Smarandache, Concentric Plithogenic Hypergraph based on Plithogenic Hypersoft sets – A Novel Outlook, *Neutrosophic Sets and Systems*, vol. 33, 2020, pp. 78-91. DOI: 10.5281/zenodo.3782824, <http://fs.unm.edu/NSS/ConcentricPlithogenicHypergraph.pdf>
9. Sudipta Gayen, Florentin Smarandache, Sripati Jha, Manoranjan Kumar Singh, Said Broumi and Ranjan Kumar, Introduction to Plithogenic Hypersoft Subgroup, *Neutrosophic Sets and Systems*, vol. 33, 2020, pp. 208-233. DOI: 10.5281/zenodo.3782897 <http://fs.unm.edu/NSS/IntroductionToPlithogenic.pdf> (accessed on May 21, 2021)
10. Shawkat Alkhazaleh, Plithogenic Soft Set, *Neutrosophic Sets and Systems*, vol. 33, 2020, pp. 256-274. DOI: 10.5281/zenodo.3783023, <http://fs.unm.edu/NSS/PlithogenicSoftSet.pdf>
11. Florentin Smarandache, Extension of HyperGraph to n-SuperHyperGraph and to Plithogenic n-SuperHyperGraph, and Extension of HyperAlgebra to n-ary (Classical-/Neutro-/Anti-) HyperAlgebra, *Neutrosophic Sets and Systems*, vol. 33, 2020, pp. 290-296. DOI: 10.5281/zenodo.3783103, <http://fs.unm.edu/NSS/n-SuperHyperGraph-n-HyperAlgebra.pdf>
12. Mohamed Grida, Rehab Mohamed and Abdelnaser H. Zaid, A Novel Plithogenic MCDM Framework for Evaluating the Performance of IoT Based Supply Chain, *Neutrosophic Sets and Systems*, vol. 33, 2020, pp. 321-338. DOI: 10.5281/zenodo.3808980, <http://fs.unm.edu/NSS/NovelPlithogenicMCDM.pdf>
13. Shazia Rana, Madiha Qayyum, Muhammad Saeed, F. Smarandache, Bakhtawar Ali Khan: Plithogenic Fuzzy Whole Hypersoft Set, Construction of Operators and their Application in Frequency Matrix Multi Attribute Decision Making Technique, *Neutrosophic Sets and Systems*, vol. 28, 2019, pp. 34-50. DOI: 10.5281/zenodo.3382507, <http://fs.unm.edu/NSS/PlithogenicFuzz%20yWholeHypersoftSet.pdf>
14. F. Smarandache: Extension of Soft Set to Hypersoft Set, and then to Plithogenic Hypersoft Set, *Neutrosophic Sets and Systems*, vol. 22, 2018, pp. 168-170. DOI: 10.5281/zenodo.2159754 <http://fs.unm.edu/NSS/ExtensionOfSoftSetToHypersoftSet.pdf>

Plithogeny, Plithogenic Set, Logic, Probability, and Statistics: A Short Review

Florentin Smarandache

Florentin Smarandache (2022). Plithogeny, Plithogenic Set, Logic, Probability, and Statistics: A Short Review. *Journal of Computational and Cognitive Engineering* 1(2) 47-50; DOI: 10.47852/bonviewJCCE2202191

Abstract: In this paper, one recalls our 2017 concepts of plithogeny and its derivative applications in set theory, logic, probability, and statistics. The plithogenic set, plithogenic logic, plithogenic probability, and plithogenic statistics are presented again.

Keywords: plithogeny; plithogenic set; plithogenic logic; plithogenic probability; plithogenic statistics

1. Etymology of Plithogeny

Plithogeny etymologically comes from: (Gr.) πλήθος (plithos) = crowd, large number of, multitude, plenty of, and -geny < (Gr.) -γενιά (-geniá) = generation, the production of something, and γένεια (généia) = generations, the production of something < -γένεσι (-génesi) = genesis, origination, creation, development, according to Translate Google Dictionaries (<https://translate.google.com/>) and Webster’s New World Dictionary of American English, Third College Edition, Simon & Schuster, Inc., New York, pp. 562–563, 1988.

Therefore, plithogeny is the genesis or origination, creation, formation, development, and evolution of new entities from dynamics and organic fusions of contradictory and/or neutrals and/or non-contradictory multiple old entities. Plithogenic means what is pertaining to plithogeny.

2. Plithogenic Set

A plithogenic set P is a set whose elements are characterized by one or more attributes, and each attribute may have many values. Each attribute’s value v has a corresponding degree of appurtenance $d(x,v)$ of the element x to the set P , with respect to some given criteria.

In order to obtain a better accuracy for the plithogenic aggregation operators, a contradiction (dissimilarity) degree is defined between each attribute value and the dominant (most important) attribute value.

However, there are cases when such dominant attribute value may not be taken into consideration or may not exist (therefore it is considered zero by default), or there may be many dominant attribute values. In such cases, either the contradiction degree function is suppressed, or another relationship function between attribute values should be established.

The plithogenic aggregation operators (intersection, union, complement, inclusion, equality) are based on contradiction

degrees between attributes’ values, and the first two are linear combinations of the fuzzy operators’ t_{norm} and t_{conorm} .

Plithogenic set was introduced by Smarandache in Smarandache (2017, 2018, 2019, 2020, 2021), and Chavez et al. (2021), and it is a generalization of the crisp set, fuzzy set, intuitionistic fuzzy set, and neutrosophic set, since these types of sets are characterized by a single attribute value (appurtenance): which has one value (membership) – for the crisp set and fuzzy set, two values (membership and nonmembership) – for intuitionistic fuzzy set, or three values (membership, nonmembership, and indeterminacy) – for neutrosophic set.

2.1. Example

Let P be a plithogenic set, representing the students from a college. Let $x \in P$ be a generic student that is characterized by three attributes:

- altitude (a), whose values are {tall, short} = $\{a1, a2\}$;
- weight (w), whose values are {obese, fat, medium, thin} = $\{w1, w2, w3, w4\}$;
- and
- hair color, whose values are {blond, reddish, brown} = $\{h1, h2, h3\}$.

The multi-attribute of dimension 3 is

$$V_3 = \{(a_i, w_j, h_k) \text{ for all } 1 \leq i \leq 2, 1 \leq j \leq 4, 1 \leq k \leq 3\}.$$

Let us say $P = \{\text{John}(a1, w3, h2), \text{Richard}(a1, w3, h2)\} = \{\text{John}(\text{tall, thin, reddish}), \text{Richard}(\text{tall, thin, reddish})\}$.

From the view point of expert A, one has $PA = \{\text{John}(0.7, 0.2, 0.4), \text{Richard}(0.5, 0.8, 0.6)\}$, which means that, from the view point of expert A, John’s fuzzy degrees of tallness, thinness, and reddishness are, respectively, 0.7, 0.2, and 0.4, while Richard’s fuzzy degrees of tallness, thinness, and reddishness are, respectively, 0.5, 0.8, and 0.6.

While from the view point of expert B, one has $PB = \{\text{John}(0.8, 0.2, 0.5), \text{Richard}(0.3, 0.7, 0.4)\}$.

The uni-dimensional attribute contradiction degrees are

$$\begin{aligned} c(a_1, a_2) &= 1 \\ c(w_1, w_2) &= \frac{1}{3} \\ c(w_1, w_3) &= \frac{2}{3} \\ c(w_1, w_4) &= 1 \\ c(h_1, h_2) &= 0.5 \\ c(h_1, h_3) &= 1 \end{aligned}$$

Dominant attribute values are $a_1, w_1,$ and h_1 for each corresponding uni-dimensional attribute $a, w,$ and $h,$ respectively. Let us use the fuzzy conjunction $a \wedge_F b = ab$ {where \wedge_F means fuzzy conjunction}, and fuzzy disjunction $a \vee_F b = a + b - ab$ {where \vee_F means fuzzy disjunction}.

We use the notations: \wedge_P and \vee_P to denote the plithogenic intersection and the plithogenic union, respectively.

Then

$$\begin{aligned} (a, b, c) \wedge_P (d, e, f) &= (ad, (1/2)\{(be) + (b + e - be)\}, c + f - cf) \\ &= (ad, (b + e)/2, c + f - cf). \end{aligned}$$

2.2. A plithogenic application to images

A pixel x may be characterized by colors $c_1, c_2, \dots, c_n.$ We write $x(c_1, c_2, \dots, c_n),$ where $n \geq 1.$ We may consider the degree of each color either fuzzy, intuitionistic fuzzy, or neutrosophic.

For example.

Fuzzy degree:

$$x(0.4, 0.6, 0.1, \dots, 0.3).$$

Intuitionistic fuzzy degree:

$$x((0.1, 0.2), (0.3, 0.5), (0.0, 0.6), \dots, (0.8, 0.9)).$$

Neutrosophic degree:

$$x((0.0, 0.3, 0.6), (0.2, 0.8, 0.9), (0.7, 0.4, 0.2), \dots, (0.1, 0.1, 0.9)).$$

Then, we can use a plithogenic operator to combine them.

For example:

$$x(0.4, 0.6, 0.1, \dots, 0.3) \wedge_P x(0.1, 0.7, 0.5, \dots, 0.2) = \dots$$

We establish first the degrees of contradictions between all colors c_i and c_j in order to find the linear combinations of t-norm and t-conorm that one applies to each color (similar to the indeterminacy above).

2.3. A plithogenic application to decision-making problems

Researchers have shown great attention to the decision-making problem by utilizing the features of the plithogenic set.

For instance, Sankar et al. (2020) presented a TOPSIS approach to solve the decision-making problems by using plithogenic set. Abdel-Basset et al. (2021) presented a decision model for supplier selection problem using the plithogenic set. Rana et al. (2019) and Ahmad et al. (2020) presented the applications of the decision-making problems under the environment of plithogenic hypersoft set. Sujatha et al. (2020) and Martin and Priya (2021) utilized the plithogenic cognitive map to analyze the data related to the corona virus. Quek et al. (2020) presented an entropy measure, while Bala (2020) discussed the information fusion measures for the plithogenic set. Ahmad et al. (2021) presented an optimization model for the supply chain problems by utilizing the neutrosophic set features.

2.4. Extension of the plithogenic set

Since the appearance of the plithogenic set, many researchers have extended the concept of the plithogenic set to different environment. For instance, Smarandache (2018a,c) give the formal definition of the Plithogenic set, which is an extension of the several existing theories such as crisp, fuzzy, neutrosophic etc. Later on, Smarandache (2018b) extends the soft set to hypersoft set and plithogenic hypersoft set. Gayen et al. (2020) presented the idea of the plithogenic hypersoft subgroup. In 2020, Alkhazaleh (2020) presented the concept of the plithogenic soft set. Priyadarshini et al. (2020) presented the concept of the plithogenic cubic set. For more details about the plithogenic hypersoft set and their extensions, we refer to read the articles (Martin and Smarandache, 2020, 2020a, 2020b; Rana et al. 2020). Some other application on the extension of the plithogenic set can be read from the articles (Selcuk et al. 2020; Alwadani and Ndubisi, 2021; Martin et al., 2021).

3. Plithogenic Probability

Since in plithogenic probability each event E from a probability space U is characterized by many chances of the event to occur (not only one chance of the event E to occur: as in classical probability, imprecise probability, and neutrosophic probability), a plithogenic probability distribution function, $PP(x),$ of a random variable, $x,$ is described by many plithogenic probability distribution sub-functions, where each sub-function represents the chance (with respect to a given attribute value) that value x occurs, and these chances of occurrence can be represented by classical, imprecise, neutrosophic probabilities, and in general any fuzzy-extension type (depending on the type of degree of a chance).

3.1. Example of plithogenic probabilistic

What is the plithogenic probability that Jenifer will graduate at the end of this semester in her program of electrical engineering, given that she is enrolled in and has to pass two courses of Mathematics (Non-Linear Differential Equations and Stochastic Analysis), and two courses of Mechanics (Fluid Mechanics, and Solid Mechanics)? We have four attribute values of plithogenic probability.

According to her adviser, Jenifer's plithogenic single-valued fuzzy probability of graduating at the end of this semester is: $J(0.5, 0.6; 0.8, 0.4),$ which means 50% chance of passing the Non-Linear Differential Equations class, 60% chance of passing the Stochastic Analysis class (as part of Mathematics), and 80% chance of passing the Fluid Mechanics class and 40% chance of passing the Solid Mechanics class (as part of Physics).

Therefore, the plithogenic probability in this example is composed of four classical probabilities.

3.2. Subclasses of Plithogenic Probability (Smarandache, 2021) are

- (i) If all probability distribution functions (PDFs) are classical, then we have a classical **MultiVariate Probability**.
- (ii) If all PDFs are in the neutrosophic style, that is, of the form (T, I, F) , where T is the chance that the event occurs, I is the indeterminate chance of the event to occur or not, and F is the chance that the event does not occur, with $T, I, F \in [0,1]$, $0 \leq T + I + F \leq 3$, then we have a **Plithogenic Neutrosophic Probability**.
- (iii) If all PDFs are indeterminate functions (i.e. functions that have indeterminate data in the arguments, or in the values, or in both), then we have a **Plithogenic Indeterminate Probability**.
- (iv) If all PDFs are Intuitionistic Fuzzy in the form of (T, F) , where T is the chance that the event occurs, and F is the chance that the event does not occur, with $T, F \in [0, 1]$, $0 \leq T + F \leq 1$, then we have a **Plithogenic Intuitionistic Fuzzy Probability**.
- (v) If all PDFs are in the Picture Fuzzy Set style, that is, of the form (T, N, F) , where T is the chance that the event occurs, N is the neutral chance of the event to occur or not, and F is the chance that the event does not occur, with $T, N, F \in [0, 1]$, $0 \leq T + N + F \leq 1$, then we have a **Plithogenic Picture Fuzzy Probability**.
- (vi) If all PDFs are in the Spherical Fuzzy Set style, that is, of the form (T, H, F) , where T is the chance that the event occurs, H is the neutral chance of the event to occur or not, and F is the chance that the event does not occur, with $T, H, F \in [0, 1]$, $0 \leq T^2 + H^2 + F^2 \leq 1$, then we have a **Plithogenic Picture Fuzzy Probability**.
- (vii) In general, if all PDFs are in any (fuzzy-extension set) style, then we have a **Plithogenic (fuzzy-extension) Probability**.
- (viii) If some PDFs are in one of the above styles, while others are in different styles, then we have a **Plithogenic Hybrid Probability**.

3.3. Plithogenic refined probability

The most general form of probability is **Plithogenic Refined Probability** (Smarandache and Smarandache, 2021), when the components of T (Truth = Occurrence), I (Indeterminate-Occurrence), and F (Falsehood-NonOccurrence) are refined/split into sub-components: T_1, T_2, \dots, T_p (sub-truths = sub-occurrences) and I_1, I_2, \dots, I_r (sub-indeterminate-occurrences), and F_1, F_2, \dots, F_s (sub-falsehoods = sub-nonoccurrences), where $p, r, s \geq 0$ are integers, and at least one of p, r, s is ≥ 2 .

All the above sub-classes of plithogenic probability may be refined this way. In the direction of refined plithogenic set, Priyadarshini and Nirmala Irudayam (2021) discussed an approach related to the refined plithogenic neutrosophic set to solve the decision-making problems.

4. Plithogenic Statistics

As a generalization of classical statistics and neutrosophic statistics, the plithogenic statistics is the analysis of events described by the plithogenic probability.

In neutrosophic statistics, we have some degree of indeterminacy into the data or into the statistical inference methods. The neutrosophic probability (and similarly for classical probability and for the imprecise probability) of an event E to occur is calculated with respect to the chance of the event E to occur (i.e. it is

calculated with respect to only ONE chance of occurrence), while the plithogenic probability of an event E to occur is calculated with respect to MANY chances of the event E to occur (it is calculated with respect to each event's attribute/parameter chance of occurrence). Therefore, the plithogenic probability is a multi-probability (i.e. multi-dimensional probability) – unlike the classical, and probabilities may be of any type, such as classical, imprecise, neutrosophic, and any other fuzzy-extension type that are uni-dimensional probabilities. Recently, Singh (2020) utilized the plithogenic set to study the multi-variate data.

4.1. Example of plithogenic statistics

Let us consider the previous example of plithogenic probability that Jenifer will graduate at the end of this semester in her program of electrical engineering. Instead of defining only one probability distribution function (and drawing its curve), we do now draw four probability distribution functions (and draw four curves), when we consider the neutrosophic distribution as a uni-dimensional neutrosophic function. Therefore, plithogenic statistics is a multivariate statistics.

5. Conclusion

We have recalled the 2017 plithogenic set, logic, probability, and statistics of an event that is composed from the chances that the event occurs with respect to all random variables (parameters) that determine it. Each such a variable is described by a probability distribution (density) function, which may be a classical, (T, I, F) -neutrosophic, I -neutrosophic, (T, F) -intuitionistic fuzzy, (T, N, F) -picture fuzzy, (T, N, F) -spherical fuzzy, or (other fuzzy extension) distribution function.

Plithogenic statistics is the analysis of the events described by the plithogenic probability. Several examples were provided.

References

- Abdel-Basset, M., Mohamed, R., Smarandache, F., & Elhoseny, M. (2021). A new decision-making model based on plithogenic set for supplier selection. *Computers, Materials & Continua*, 66(3), 2752–2769. <https://doi.org/10.32604/cmc.2021.013092>
- Ahmad, F., Adhami, A. Y., & Smarandache, F. (2020). Modified neutrosophic fuzzy optimization model for optimal closed-loop supply chain management under uncertainty. *Optimization Theory Based on Neutrosophic and Plithogenic Sets*, 343–403. <https://doi.org/10.1016/B978-0-12-819670-0.00015-9>
- Ahmad, M.R., Saeed, M., Afzal, U., & Yang, M.-S. (2020). A novel MCDM method based on plithogenic hypersoft sets under fuzzy neutrosophic environment. *Symmetry*, 12(11), 1855. <https://doi.org/10.3390/sym12111855>
- Alkhalaleh, S. (2020). Plithogenic soft set. *Neutrosophic Sets and Systems*, 33, 256–274. <http://fs.unm.edu/NSS2/index.php/111/article/view/196>
- Alwadani, R., & Ndubisi, N. O. (2021). Family business goal, sustainable supply chain management, and platform economy: A theory based review & propositions for future research. *International Journal of Logistics Research and Applications*, 1–24. <https://doi.org/10.1080/13675567.2021.1944069>
- Bala, G. (2020). Information fusion using plithogenic set and logic. *Acta Scientific Computer Sciences*, 2(7), 26–27. <https://actascientific.com/ASCS/pdf/ASCS-02-0053.pdf>
- Chavez, W. O., Pozo Ortega, F., Vasquez Perez, J. K., Diaz Zuniga, E. J., & Rivera, A. R. P. (2021). *Modelo ecologico de*

- Bronferbrenner aplicado a la pedagogia, modelacion matematica para la toma de decisiones bajo incertidumbre: de la logica difusa a la logica plitogenica.* NSIA Publishing House Editions. <http://fs.unm.edu/LogicaPlitogenica.pdf>
- Gayen, S., Smarandache, F., Jha, S., Singh, M. K., Broumi, S., & Kumar, R. (2020). Introduction to plithogenic hypersoft subgroup. *Neutrosophic Sets and Systems*, 33, 208–233. <http://fs.unm.edu/NSS/IntroductionToPlithogenic.pdf>
- Martin, N., & Priya, R. (2021). New Plithogenic sub cognitive maps approach with mediating effects of factors in COVID-19 diagnostic model. *Journal of Fuzzy Extension & Applications*, 2(1), 1–15. <https://doi.org/10.22105/JFEA.2020.250164.1015>
- Martin, N., & Smarandache, F. (2020). Concentric plithogenic hypergraph based on plithogenic hypersoft sets - A novel outlook. *Neutrosophic Sets and Systems*, 33, 78–91. <http://fs.unm.edu/NSS2/index.php/111/article/view/185>
- Martin, N. & Smarandache, F. (2020). Introduction to combined plithogenic hypersoft sets. *Neutrosophic Sets and Systems*, 35, 503–510. <http://fs.unm.edu/NSS2/index.php/111/article/view/40>
- Martin, N., & Smarandache, F. (2020). Plithogenic cognitive maps in decision making. *International Journal of Neutrosophic Science*, 9(1), 9–21. <http://doi.org/10.5281/zenodo.3950063>
- Martin, N., Smarandache, F., & Priya, R. (2021). Introduction to Plithogenic Sociogram with preference representations by Plithogenic Number. *Journal of Fuzzy Extension & Applications*, 3(1), 96–108. <http://doi.org/10.22105/jfea.2021.288057.1151>
- Priyadharshini, S. P., Nirmala Irudayam, F., & Smarandache, F. (2020). Plithogenic cubic sets. *International Journal of Neutrosophic Science*, 11(1), 30–38. <https://doi.org/10.5281/zenodo.4275725>
- Priyadharshini, S.P., & Nirmala Irudayam, F. (2021). A novel approach of refined plithogenic neutrosophic sets in multi criteria decision making. *International Research Journal of Modernization in Engineering Technology and Science*, 3(4), 5. https://www.irjmets.com/uploadedfiles/paper/volume3/issue_5_may_2021/9582/1628083385.pdf
- Quek, S. G., Selvachandran, G., Smarandache, F., Vimala, J., Le, S. H., Bui, Q.-T., & Gerogiannis, V. C. (2020). Entropy measures for plithogenic sets and applications in multi-attribute decision making. *Mathematics*, 8(6), 965. <https://doi.org/10.3390/math8060965>
- Rana, S., Qayyum, M., Saeed, M., Smarandache, F., & Ali Khan, B. (2019). Plithogenic fuzzy whole hypersoft set, construction of operators and their application in frequency matrix multi attribute decision making technique. *Neutrosophic Sets and Systems*, 28, 34–50. https://digitalrepository.unm.edu/nss_journal/vol28/iss1/5
- Rana, S., Saeed, M., Qayyum, M., & Smarandache, F. (2020). Plithogenic subjective hyper-super-soft matrices with new definitions & local, global, universal subjective ranking model. *International Journal of Neutrosophic Science*, 6(2), 56–79. <https://doi.org/10.5281/zenodo.3841624>
- Sankar, C., Sujatha, R. & Nagarajan, D. (2020) TOPSIS by using plithogenic set in COVID-19 decision making. *International Journal of Neutrosophic Science*, 10(2), 116–125. <https://doi.org/10.5281/zenodo.4277255>
- Selcuk, K., Ezgi, D., Caglar, K., & Zeljko, S. (2020). Determining the dimensions of the innovation ability in logistics sector by using plithogenic-critic method: An application in Sakarya Province. *International Review*, 1–2, 119–127. <https://doi.org/10.5937/intrev2001119K>
- Singh, P. K. (2020). Plithogenic set for multi-variable data analysis. *International Journal of Neutrosophic Science*, 1(2), 81–89. <https://doi.org/10.5281/zenodo.3988028>
- Smarandache, F. (2017). *Plithogeny, Plithogenic Set, Logic, Probability, and Statistics*. Pons. <https://arxiv.org/ftp/arxiv/papers/1808/1808.03948.pdf>
- Smarandache, F. (2018). Plithogenic set, an extension of crisp, fuzzy, intuitionistic fuzzy, and neutrosophic sets - Revisited. *Neutrosophic Sets and Systems*, 21, 153–166. <https://doi.org/10.5281/zenodo.1408740>
- Smarandache, F. (2018). Extension of soft set to hypersoft set, and then to plithogenic hypersoft set. *Neutrosophic Sets and Systems*, 22, 168–170.
- Smarandache, F. (2018). Conjunto plitogenico, una extension de los conjuntos crisp, difusos, conjuntos difusos intuicionistas y neutrosoficos revisitado. *Neutrosophic Computing and Machine Learning*, 3, 1–19. <http://fs.unm.edu/NCML2/index.php/112/article/view/19>
- Smarandache, F. (2019). New types of Neutrosophic Set/Logic/Probability, Neutrosophic Over-/Under-/Off-Set, Neutrosophic Refined Set, and their Extension to Plithogenic Set/Logic/Probability, with Applications. *Symmetry*, 714. https://www.mdpi.com/journal/symmetry/special_issues/Neutrosophic_Set_Logic_Probability.
- Smarandache, F., & Abdel-Basset, M. (2020). *Optimization Theory Based on Neutrosophic and Plithogenic Sets*. ELSEVIER, 446.
- Smarandache, F., & Martin, N. (2020). Plithogenic n-Super hypergraph in novel multi-attribute decision making. *International Journal of Neutrosophic Science*, 7(1), 8–30. <https://doi.org/10.5281/zenodo.3876206>
- Smarandache, F. (2021). Plithogenic probability & statistics are generalizations of multivariate probability & statistics. *Neutrosophic Sets and Systems*, 43, 280–289. <https://doi.org/10.5281/zenodo.491489>.
- Sujatha, R., Poomagal, S., Kuppuswami, G., & Broumi, S. (2020). An analysis on novel corona virus by a plithogenic fuzzy cognitive map approach. *International Journal of Neutrosophic Science*, 11(2), 62–75. <https://doi.org/10.5281/zenodo.4275788>
- Uluta, A., Topal, A., Karabasevic, D., Stanujkic, D., Popovic, G., & Smarandache, F. (2022). Prioritization of logistics risks with plithogenic PIPRECIA method. *International Conference on Intelligent and Fuzzy Systems*, 663–670. https://doi.org/10.1007/978-3-030-85577-2_78

INFORMATION FUSION

Indeterminate masses, elements and models in information fusion

Florentin Smarandache

Florentin Smarandache (2013). Indeterminate masses, elements and models in information fusion. *Journal of Advances in Information Fusion* 5(6), 365-372

Abstract: In this paper at the beginning, we make a short history of the logics, from the classical Boolean logic to the most general logic of today neutrosophic logic. We define the general logic space and give the definition of the neutrosophic logic. Then we introduce the indeterminate models in information fusion, which are due either to the existence of some indeterminate elements in the fusion space or to some indeterminate masses. The best approach for dealing with such models is the neutrosophic logic, which is part of neutrosophy. Neutrosophic logic is connected with neutrosophic set and neutrosophic probability and statistics.

Keywords: neutrosophic logic; indeterminacy; indeterminate model; indeterminate element; indeterminate mass; indeterminate fusion rules; DSmT; DST; TBM.

1 Introduction

Let Θ be a frame of discernment, defined as:

$$\Theta = \{\phi_1, \phi_2, \dots, \phi_n\}, n \geq 2, \tag{1}$$

and its Super-Power Set (or fusion space):

$$S^\Theta(\Theta, \cup, \cap, \bar{\cdot}) \tag{2}$$

which means the set S^Θ closed under union, intersection, and respectively complement.

As an alternative to the existing logics we have proposed the neutrosophic logic (NL) to represent a mathematical model of uncertainty, vagueness, ambiguity, imprecision, undefined, unknown, incompleteness, inconsistency, redundancy, contradiction. It is a non-classical logic. NL and neutrosophic set are consequences of the neutrosophy.

Neutrosophy is a new branch of philosophy, which studies the origin, nature, and scope of neutralities, as well as their interactions with different ideational spectra.

A logic in which each proposition is estimated to have the percentage of truth in a subset T , the percentage of indeterminacy in a subset I , and the percentage of falsity in a subset F , where T, I, F are defined above, is called *NL*.

(T, I, F) truth-values, where T, I, F are standard or non-standard subsets of the non-standard interval $] -0, 1+[$, where $ninf = inf T + inf I + inf F = -0$, and $nsup = sup T + sup I + sup F = 3+$. Statically T, I, F are subsets, but dynamically T, I, F are functions/operators depending on many known or unknown parameters.

The truth, indeterminacy and falsity can be approximated: for example, a proposition is between 30 to 40 true and between 60 to 70 false, even worst:

between 30 to 40 or 45 to 50 true (according to various analysers), and 60 or between 66 to 70 false.

The subsets are not necessary intervals, but any sets (discrete, continuous, open or closed or half-open/half-closed interval, intersections or unions of the previous sets, etc.) in accordance with the given proposition.

Statically T, I, F are subsets, but dynamically they are functions/operators depending on many known or unknown parameters.

The classical logic, also called bivalent logic for taking only two values $\{0, 1\}$, or Boolean logic from British mathematician George Boole (1815–1964), was named by the philosopher Quine (1981) *sweet simplicity*.

Peirce, before 1910, developed a semantics for three-valued logic in an unpublished note, but Emil Post's dissertation (1920s) is cited for originating the three-valued logic. Here '1' is used for truth, '1/2' for indeterminacy, and '0' for falsehood. Also, Reichenbach, leader of the logical empiricism, studied it.

The three-valued logic was employed by Hallden (1949), Korner (1960), and Tye (1994) to solve Sorites Paradoxes. They used truth tables, such as Kleene's, but everything depended on the definition of validity. A three-valued paraconsistent system (LP) has the values: 'true', 'false', and 'both true and false'. The ancient Indian metaphysics considered four possible values of a statement: 'true (only)', 'false (only)', 'both true and false', and 'neither true nor false'; J.M. Dunn (1976) formalised this in a four-valued paraconsistent system as his first degree entailment semantics.

The Buddhist logic added a fifth value to the previous ones, 'none of these' (called *catushkoti*).

The $\{0, a_1, \dots, a_n, 1\}$ multi-valued, or plurivalent, logic was developed by Lukasiewicz, while Post originated the m valued calculus.

The many-valued logic was replaced by Goguen (1969) and Zadeh (1975) with an infinite-valued logic (of continuum power, as in the classical mathematical analysis and classical probability) called fuzzy logic, where the truth-value can be any number in the closed unit interval $[0, 1]$. The fuzzy set was introduced by Zadeh in 1965.

Applications of neutrosophic logic/set have been used to information fusion (Smarandache and Dezert, 2004–2009), extension logic (Smarandache, 2013; Vladareanu et al., 2013), and to robotics (Smarandache and Vladareanu, 2011; Smarandache, 2011; Okuyama et al., 2013).

With imprecise data has been worked in magnetic bearing systems (Anantachaisilp and Lin, 2013), signal processing (Golpira and Golpira, 2013), water pollution control system (Wang and Wu, 2013), neutrosophic soft set (Broumi and Smarandache, 2013), and especially to robotica and mechatronics systems (Vladareanu et al., 2012a, 2012b).

This paper is organised as follows: we present the NL, the indeterminate masses, elements and models, and give an example of indeterminate intersection.

Indeterminate mass

2.1 Neutrosophic logic

NL (Smarandache, 1998, 2002) started in 1995 as a generalisation of the fuzzy logic, especially of the intuitionistic fuzzy logic (IFL). A logical proposition P is characterised by three neutrosophic components:

$$NL(P) = (T, I, F) \tag{3}$$

where T is the degree of truth, F the degree of falsehood, and I the degree of indeterminacy (or *neutral*, where the name *neutro-sophic* comes from, i.e., neither truth nor falsehood but in between – or included-middle principle), and with:

$$T, I, F \subseteq]-0, 1+[\tag{4}$$

where $]-0, 1+[$ is a non-standard interval.

In this paper, for technical proposal, we can reduce this interval to the standard interval $[0, 1]$.

The main distinction between NL and IFL is that in NL the sum $T + I + F$ of the components, when $T, I,$ and F are crisp numbers, does not need to necessarily be 1 as in IFL, but it can also be less than 1 (for incomplete/missing information), equal to 1 (for complete information), or greater than 1 (for paraconsistent/contradictory information).

The combination of neutrosophic propositions is done using the neutrosophic operators (especially \wedge, \vee).

2.2 Neutrosophic mass

We recall that a classical mass $m(\cdot)$ is defined as:

$$m : S^\Theta \rightarrow [0, 1] \tag{5}$$

such that

$$\sum_{X \in S^\Theta} m(X) = 1 \tag{6}$$

We extend this classical basic belief assignment (mass) $m(\cdot)$ to a neutrosophic basic belief assignment (NBBA) (or neutrosophic mass) $m_n(\cdot)$ in the following way.

$$m_n : S^\Theta \rightarrow [0, 1]^3 \tag{7}$$

with

$$m_n(A) = (T(A), I(A), F(A)) \tag{8}$$

where $T(A)$ means the (local) chance that hypothesis A occurs, $F(A)$ means the (local) chance that hypothesis A does not occur (non-chance), while $I(A)$ means the (local) indeterminate chance of A (i.e., knowing neither if A occurs nor if A does not occur), such that:

$$\sum_{X \in S^\Theta} [T(X) + I(X) + F(X)] = 1. \tag{9}$$

In a more general way, the summation (9) can be less than 1 (for incomplete neutrosophic information), equal to 1 (for complete neutrosophic information), or greater than 1 (for

paraconsistent/conflicting neutrosophic information). But in this paper we only present the case when summation (9) is equal to 1.

Of course,

$$0 \leq T(A), I(A), F(A) \leq 1 \tag{10}$$

A *basic belief assignment* (or *mass*) is considered *indeterminate* if there exist at least an element $A \in S$ such that $I(A) > 0$, i.e., there exists some indeterminacy in the chance of at least an element A for occurring or for not occurring. Therefore, a neutrosophic mass which has at least one element A with $I(A) > 0$ is an indeterminate mass.

A classical mass $m(\cdot)$ as defined in equations (5) and (6) can be extended under the form of a neutrosophic mass $m_n'(\cdot)$ in the following way:

$$m_n'(\cdot) : S^{\Theta} \rightarrow [0, 1]^3 \tag{11}$$

with

$$m_n'(A) = (m(A), 0, 0) \tag{12}$$

but reciprocally it does not work since $I(A)$ has no correspondence in the definition of the classical mass.

We just have $T(A) = m(A)$ and $F(A) = m(C(A))$, where $C(A)$ is the complement of A . The non-null $I(A)$ can, for example, be roughly approximated by the total ignorance mass $m(\cdot)$, or better by the partial ignorance mass $m(\cdot)$ where \cdot is the union of all singletons that have some non-zero indeterminacy, but these mean less accuracy and less refinement in the fusion.

If $I(X) = 0$ for all $X \in S$, then the neutrosophic mass is simply reduced to a classical mass.

Indeterminate element

We have two types of elements in the fusion space S , *determinate elements* (which are well-defined), and *indeterminate elements* (which are not well-defined; for example: a geographical area whose frontiers are vague; or let us say in a murder case there are two suspects, *John* – who is known/determinate element – but he acted together with another man X (since the information source saw *John* together with an unknown/unidentified person) – therefore X is an indeterminate element).

Herein, we gave examples of singletons as indeterminate elements just in the frame of discernment, but indeterminate elements can also result from the combinations (unions, intersections, and/or complements) of determinate elements that form the super-power set S . For example, A and B can be determinate singletons (we call the elements in S as singletons), but their intersection $A \cap B$ can be an indeterminate (unknown) element, in the sense that we might not know if $A \cap B = \phi$ or $A \cap B \neq \phi$.

Or A can be a determinate element, but its complement $C(A)$ can be indeterminate element (not well-known), and similarly for determinate elements A and B , but their $A \cup B$ might be indeterminate.

Indeterminate elements in S can, of course, result from the combination of indeterminate singletons too. All depends on the problem that is studied.

A frame of discernment which has at least an indeterminate element is called *indeterminate frame of discernment*. Otherwise, it is called *determinate frame of discernment*. Similarly, we call an *indeterminate fusion space* (S) that fusion space which has at least one indeterminate element. Of course an indeterminate frame of discernment spans an indeterminate fusion space.

An *indeterminate source of information* is a source which provides an indeterminate mass or an indeterminate fusion space. Otherwise it is called a *determinate source of information*.

Indeterminate model

An *indeterminate model* is a model whose fusion space is indeterminate, or a mass that characterises it is indeterminate.

Such case has not been studied in the information fusion literature so far. In the next sections, we will present some examples of indeterminate models.

Classification of models

In the classical fusion theories, all elements are considered determinate in the closed world, except in Smets' open world where there is some room (i.e., mass assigned to the empty set) for a possible unknown missing singleton in the frame of discernment. So, the open world has a probable indeterminate element, and thus its frame of discernment is indeterminate. While the closed world frame of discernment is determinate.

In the closed world in Dezert-Smarandache theory, there are three models classified upon the types of singleton intersections: Shafer's model (where all intersections are empty), hybrid model (where some intersections are empty, while others are non-empty), and free model (where all intersections are non-empty).

We now introduce a fourth category, called *indeterminate model* (where at least one intersection is indeterminate/unknown, and in general at least one element of the fusion space is indeterminate). We do this because in practical problems we do not always know if an intersection is empty or nonempty. As we still have to solve the problem in the real time, we have to work with what we have, i.e., with indeterminate models.

The *indeterminate intersection* cannot be refined (because not knowing if $A \cap B$ is empty or nonempty, we'd get two different refinements: $\{A, B\}$ when intersection is empty, and $\{A \cap B, B \cap A, A \cup B\}$ when intersection is nonempty).

The *percentage of indeterminacy* of a model depends on the number of indeterminate elements and indeterminate masses.

By default: the sources, the masses, the elements, the frames of discernment, the fusion spaces, and the models are supposed determinate.

An example of information fusion with an indeterminate model

We present the below example.

Suppose we have two sources, $m_1(\cdot)$ and $m_2(\cdot)$, such that.

Table 1 First part of the fusion with indeterminate model

	A	B	C	$A \cup B \cup C$	$A \cap B = Ind.$	$A \cap C = \phi$	$B \cap C = Ind.$
m_1	0.4	0.2	0.3	0.1			
m_2	0.1	0.3	0.2	0.4			
m_{12}	0.21	0.17	0.20	0.04	0.14	0.11	0.13

Applying the conjunction rule to m_1 and m_2 we get $m_{12}(\cdot)$ as shown in Table 1.

The frame of discernment is $\{A, B, C\}$. We know that $A \cap C$ is empty, but we do not know the other two intersections: we note them as $A \cap B = ind.$ and $B \cap C = ind.$, where *ind.* means indeterminate.

Using the conjunctive rule to fusion m_1 and m_2 , we get $m_{12}(\cdot)$:

$$\forall A \in S^\Theta \quad \phi, m_{12}(A) = \sum_{\substack{X, Y \in S^\Theta \\ A = X \cap Y}} m_1(X)m_2(Y). \tag{13}$$

Whence $m_{12}(A) = 0.21, m_{12}(B) = 0.17, m_{12}(C) = 0.20, m_{12}(A \cup B \cup C) = 0.04$, and for the intersections:

$$m_{12}(A \cap B) = 0.14, m_{12}(A \cap C) = 0.11, m_{12}(B \cap C) = 0.13.$$

We then use the PCR5 fusion rule style to redistribute the masses of these three intersections. We recall PCR5 for two sources:

$$\begin{aligned} \forall A \in S^\Theta \quad \phi, \\ m_{12PCR5}(A) = m_{12}(A) \\ + \sum_{\substack{X \in S^\Theta \setminus \{A\} \\ X \cap A = \phi}} \left[\frac{m_1(A)^2 m_2(X)}{m_1(A) + m_2(X)} + \frac{m_2(A)^2 m_1(X)}{m_2(A) + m_1(X)} \right] \end{aligned} \tag{14}$$

a $m_{12}(A \cap C) = 0.11$ is redistributed back to A and C because $A \cap C = \phi$, according to the PCR5 style.

Let α_1 and α_2 be the parts of mass 0.11 redistributed back to A , and γ_1 and γ_2 be the parts of mass 0.11 redistributed back to C .

We have the following proportionalisations:

$$\frac{\alpha_1}{0.4} = \frac{\gamma_1}{0.2} = \frac{0.4 \cdot 0.2}{0.4 + 0.2} = 0.133333,$$

whence $\alpha_1 = 0.4(0.133333) = 0.053333$ and $\gamma_1 = 0.2(0.133333) = 0.026667$.

Similarly:

$$\frac{\alpha_2}{0.1} = \frac{\gamma_2}{0.3} = \frac{0.1 \cdot 0.3}{0.1 + 0.3} = 0.075,$$

whence $\alpha_2 = 0.1(0.075) = 0.0075$ and $\gamma_2 = 0.3(0.075) = 0.0225$.

Therefore, the mass of A , which can also be noted as $T(A)$ in a neutrosophic mass form, receives from 0.11 back:

$$\alpha_1 + \alpha_2 = 0.053333 + 0.0075 = 0.060833,$$

while the mass of C , or $T(C)$ in a neutrosophic form, receives from 0.11 back:

$$\gamma_1 + \gamma_2 = 0.026667 + 0.0225 = 0.049167.$$

We verify our calculations: $0.060833 + 0.049167 = 0.11$.

$m_{12}(A \cap B) = 0.14$ is redistributed back to the indeterminate parts of the masses of A and B respectively, namely $I(A)$ and $I(B)$ as noted in the neutrosophic mass form, because $A \cap B = Ind.$ We follow the same PCR5 style as done in classical PCR5 for empty intersections (as above).

Let α_3 and α_4 be the parts of mass 0.14 redistributed back to $I(A)$, and β_1 and β_2 be the parts of mass 0.14 redistributed back to $I(B)$.

We have the following proportionalisations:

$$\frac{\alpha_3}{0.4} = \frac{\beta_1}{0.3} = \frac{0.4 \cdot 0.3}{0.4 + 0.3} = 0.171429,$$

whence $\alpha_3 = 0.4(0.171429) = 0.068572$ and $\beta_1 = 0.3(0.171429) = 0.051428$.

Similarly:

$$\frac{\alpha_4}{0.1} = \frac{\beta_2}{0.2} = \frac{0.1 \cdot 0.2}{0.1 + 0.2} = 0.066667$$

whence $\alpha_4 = 0.1(0.066667) = 0.006667$ and $\beta_2 = 0.2(0.066667) = 0.013333$.

Therefore, the indeterminate mass of A , $I(A)$ receives from 0.14 back:

$$\alpha_3 + \alpha_4 = 0.068572 + 0.006667 = 0.075239$$

and the indeterminate mass of B , $I(B)$, receives from 0.14 back:

$$\beta_1 + \beta_2 = 0.051428 + 0.013333 = 0.064761.$$

Analogously, $m_{12}(B \cap C) = 0.13$ is redistributed back to the indeterminate parts of the masses of B and C respectively, namely $I(B)$ and $I(C)$ as noted in the neutrosophic mass form, because $B \cap C = Ind.$ also following the PCR5 style. Whence $I(B)$ gets back 0.065 and $I(C)$ also gets back 0.065.

Finally, we sum all results obtained from firstly using the conjunctive rule (Table 1) and secondly redistributing the intersections masses with PCR5 [sections (a), (b), and (c) from above]:

Table Second part of the fusion with indeterminate model

	$T(A)$	$T(B)$	$T(C)$	$T(\emptyset)$	$I(A)$	$I(B)$	$I(C)$
m_{12}	0.21	0.17	0.20	0.04			
Additions	0.0075		0.022		0.068	0.051	0.04
	0.053		5		572	428	0.045
	333		0.026		0.006	0.013	
			667		667	333	
					0.02		
					0.045		
$m_{12PCR51}$	0.270	0.17	0.249	0.04	0.075	0.129	0.065
	833		167		239	761	

where $A \cup B \cup C$ is the total ignorance.

Believe, disbelieve, and uncertainty

In classical fusion theory, there exist the following functions:

- *Belief in A* with respect to the bba $m(\cdot)$ is:

$$Bel(A) = \sum_{\substack{X \in S^\ominus \setminus \{\emptyset\} \\ X \subseteq A}} m(X) \tag{15}$$

- *Disbelief in A* with respect to the bba $m(\cdot)$ is:

$$Dis(A) = \sum_{\substack{X \in S^\ominus \setminus \{\emptyset\} \\ X \cap A = \emptyset}} m(X) \tag{16}$$

- *Uncertainty in A* with respect to the bba $m(\cdot)$ is:

$$U(A) = \sum_{\substack{X \in S^\ominus \setminus \{\emptyset\} \\ X \cap A \neq \emptyset \\ X \cap C(A) \neq \emptyset}} m(X), \tag{17}$$

where $C(A)$ is the complement of A with respect to the total ignorance .

- *Plausability of A* with respect to the bba $m(\cdot)$ is:

$$Pl(A) = \sum_{\substack{X \in S^\ominus \setminus \{\emptyset\} \\ X \cap A \neq \emptyset}} m(X) \tag{18}$$

Neutrosophic believe, neutrosophic disbelieve, and neutrosophic undecidability

Let us consider a neutrosophic mass $m_n(\cdot)$ as defined in formulas (7) and (8), $m_n(X) = (T(X), I(X), F(X))$ for all $X \in S$.

We extend formulas (15) to (18) from $m(\cdot)$ to $m_n(\cdot)$:

- *Neutrosophic Belief in A* with respect to the nbba $m_n(\cdot)$ is:

$$NeutBel(A) = \sum_{\substack{X \in S^\ominus \setminus \{\emptyset\} \\ X \subseteq A}} T(X) + \sum_{\substack{X \in S^\ominus \setminus \{\emptyset\} \\ X \cap A = \emptyset}} F(X) \tag{19}$$

- *Neutrosophic Disbelief in A* with respect to the nbba $m_n(\cdot)$ is:

$$NeutDis(A) = \sum_{\substack{X \in S^\ominus \setminus \{\emptyset\} \\ X \cap A = \emptyset}} T(X) + \sum_{\substack{X \in S^\ominus \setminus \{\emptyset\} \\ X \subseteq A}} F(X) \tag{20}$$

- *Neutrosophic uncertainty in A* with respect to the nbba $m_n(\cdot)$ is

$$NeutU(A) = \sum_{\substack{X \in S^\ominus \setminus \{\emptyset\} \\ X \cap A \neq \emptyset \\ X \cap C(A) \neq \emptyset}} T(X) + \sum_{\substack{X \in S^\ominus \setminus \{\emptyset\} \\ X \cap A \neq \emptyset \\ X \cap C(A) \neq \emptyset}} F(x) \tag{21}$$

$$= \sum_{\substack{X \in S^\ominus \setminus \{\emptyset\} \\ X \cap A \neq \emptyset \\ X \cap C(A) \neq \emptyset}} [T(X) + F(X)]$$

- We now introduce the *neutrosophic global indeterminacy in A* with respect to the nbba $m_n(\cdot)$ as a sum of local indeterminacies of the elements included in A :

$$NeutGlobInd(A) = \sum_{\substack{X \in S^\ominus \setminus \{\emptyset\} \\ X \subseteq A}} I(X) \tag{22}$$

- And afterwards we define another function called *neutrosophic undecidability about A* with respect to the nbba $m_n(\cdot)$:

$$NeutUnd(A) = NeutU(A) + NeutGlobInd(A) \tag{23}$$

or

$$NeutUnd(A) = \sum_{\substack{X \in S^\ominus \setminus \{\emptyset\} \\ X \cap A \neq \emptyset \\ X \cap C(A) \neq \emptyset}} [T(X) + F(X)] + \sum_{\substack{X \in S^\ominus \setminus \{\emptyset\} \\ X \subseteq A}} I(X) \tag{24}$$

- *Neutrosophic plausability of A* with respect to the nbba $m_n(\cdot)$ is:

$$NeutPl(A) = \sum_{\substack{X \in S^\ominus \setminus \{\emptyset\} \\ X \cap A \neq \emptyset}} T(X) + \sum_{\substack{Y \in S^\ominus \setminus \{\emptyset\} \\ C(Y) \cap A \neq \emptyset}} F(Y) \tag{25}$$

In the previous example, let us compute $NeutBel(\cdot)$, $NeutDis(\cdot)$, and $NeutUnd(\cdot)$:

Table Neutrosophic believe, disbelieve and undecidability

	A	B	C	$\frac{A \cup B}{\cup C}$
NeutBel	0.270833	0.17	0.249167	0.73
NeutDis	0.419167	0.52	0.440833	0
NeutGlobInd	0.115239	0.169761	0.105	0
Total	0.805239	0.859761	0.795	1
	1	1	1	1

As we see, for indeterminate model we cannot use the intuitionistic fuzzy set or IFL since the sum $NeutBel(X) + NeutDis(X) + NeutGlobInd(X)$ is less than 1. In this case, we use the neutrosophic set or logic which can deal with incomplete information.

The sum is less than 1 because there is missing information (we do not know if some intersections are empty or not).

For example:

$$NeutBel(B) + NeutDis(B) + NeutGlobInd(B) = 0.859761 = 1 - I(A) - I(C).$$

$$NeutBel(C) + NeutDis(C) + NeutGlobInd(C) = 0.795 = 1 - I(A) - I(B)$$

and

$$NeutBel(A \cup B \cup C) + NeutDis(A \cup B \cup C) + NeutGlobInd(A \cup B \cup C) = 0.73 = 1 - I(A) - I(B) - I(C).$$

Neutrosophic dynamic fusion

A neutrosophic dynamic fusion is a dynamic fusion where some indeterminacy occurs: with respect to the mass or with respect to some elements.

The solution of the above indeterminate model which has missing information, using the neutrosophic set, is consistent in the classical dynamic fusion in the case we receive part (or total) of the missing information.

In the above example, let us say we find out later in the fusion process that $A \cap B = \emptyset$. That means that the mass of indeterminacy of A , $I(A) = 0.075239$, is transferred to A , and the masses of indeterminacy of B (resulted from $A \cap B$ only) – i.e., 0.051428 and 0.13333 – are transferred to B . Thus, we get in Table 4.

Table First neutrosophic dynamic fusion

	A	B	C	\emptyset	$I(A)$	$I(B)$	$I(C)$	$A \cap B$	$A \cap C$
m	0.270	0.17	0.249	0.04	0	0.065	0.065	0	0
	833		167						
+	0.075	0.051							
	239	428							
		0.013							
		333							
mN	0.346	0.234	0.249	0.04	0	0.065	0.065	0	0
	072	761	167						

Note: Where $A \cup B \cup C$ is the total ignorance.

The sum $NeutBel(X) + NeutDis(X) + NeutBlogInd(X)$ increases towards 1, as indeterminacy $I(X)$ decreases towards 0, and reciprocally.

When we have complete information we get $NeutBel(X) + NeutDis(X) + NeutGlobInd(X) = 1$ and in this case we have an intuitionistic fuzzy set, which is a particular case of the neutrosophic set.

Let us suppose once more, considering the neutrosophic dynamic fusion, that afterwards we find out that $B \cap C = \emptyset$. Then, from Table 4 the masses of indeterminacies of B , $I(B) = (0.065 - 0.02) + 0.045$, resulted from $B \cap C$ which was considered indeterminate at the beginning of the neutrosophic dynamic fusion), and that of C , $I(C) = 0.065$, go now to $B \cap C$. Thus, we get in Table 5.

1 More redistribution versions for indeterminate intersections of determinate elements

Besides *PCR5*, it is also possible to employ other fusion rules for the redistribution, such as follows:

- a For the masses of the empty intersections we can use *PCR1-PCR4*, *URR*, *PURR*, *Dempster's Rule*, etc. (in general any fusion rule that first uses the conjunctive rule, and then a redistribution of the masses of empty intersections).
- b For the masses of the indeterminate intersections we can use *DSm Hybrid (DSmH)* rule to transfer the mass $m_{12}(X \cap Y \text{ ind.})$ to $X \cup Y$, since $X \cup Y$ is a kind of uncertainty related to X, Y . In our opinion, a better approach in this case would be to redistributing the empty intersection masses using the *PCR5* and the indeterminate intersection masses using the *DSmH*, so we can combine two fusion rules into one.

Table Second neutrosophic dynamic fusion

	A	B	C		I(A)	I(B)	I(C)	$A \cap B$	$A \cap C$	$B \cap C$
m_N	0.346	0.234	0.249	0.04	0	0.065	0.065	0	0	0
	072	761	167							
-/+						-0.065	-0.065			+0.065
										+0.065
m_{NN}	0.346	0.234	0.249	0.04	0	0	0	0	0	0.13
	072	761	167							

Let $m_1(\cdot)$ and $m_2(\cdot)$ be two masses. Then:

$$\begin{aligned}
 m_{12PCR5/DSmH}(A) &= \sum_{\substack{X, Y \in S^\Theta \setminus \{\phi\} \\ X \cap Y = A}} m_1(X)m_2(Y) \\
 &+ \sum_{\substack{X \in S^\Theta \setminus \{\phi\} \\ X \cap A = \phi}} \left[\frac{m(A)^2 m_2(X)}{m_1(A) + m_2(X)} + \frac{m_2(A)^2 m_1(X)}{m_2(A) + m_1(X)} \right] \\
 &+ \sum_{\substack{X, Y \in S^\Theta \setminus \{\phi\} \\ X \cap Y = ind. \\ Z \cup Y = A}} m_1(X)m_2(Y) \tag{26} \\
 &\sum_{\substack{X, Y \in S^\Theta \setminus \{\phi\} \\ \{X \cap Y = A\} \vee \{(X \cap Y = ind.) \wedge (X \cup Y = A)\}}} m_1(X)m_2(Y) \\
 &+ \sum_{\substack{X \in S^\Theta \setminus \{\phi\} \\ X \cap A = \phi}} \left[\frac{m_1(A)^2 m_2(X)}{m_1(A) + m_2(X)} + \frac{m_2(A)^2 m_1(X)}{m_2(A) + m_1(X)} \right]
 \end{aligned}$$

Yet, the best approach, for an indeterminate intersection resulted from the combination of two classical masses $m_1(\cdot)$ and $m_2(\cdot)$ defined on a determinate frame of discernment, is the first one:

- Use the PCR5 to combine the two sources: formula (14).
- Use the PCR5-ind [adjusted from classical PCR5 formula (14)] in order to compute the indeterminacies of each element involved in indeterminate intersections:

$$\begin{aligned}
 \forall A \in S^\Theta \setminus \phi, \\
 m_{12PCR5Ind}(I(A)) &= \tag{27} \\
 \sum_{\substack{X \in S^\Theta \setminus \{\phi\} \\ X \cap A = ind.}} \left[\frac{m_1(A)^2 m_2(X)}{m_1(A) + m_2(X)} + \frac{m_2(A)^2 m_1(X)}{m_2(A) + m_1(X)} \right]
 \end{aligned}$$

- Compute *NeutBel*(.), *NeutDis*(.), *NeutGlobInd*(.) of each element.

11 Conclusions

In order for the paper to be easier understanding, a short history of logics was made in the introduction. Connection between neutrosophy and NL were established.

In this paper, we introduced for the first time the notions of indeterminate mass (BBA), indeterminate element, indeterminate intersection, and so on. We gave an example of neutrosophic dynamic fusion using two classical masses,

defined on a determinate frame of discernment, but having indeterminate intersections in the super-power set S (the fusion space). We adjusted several classical fusion rules (PCR5 and DSmH) to work for indeterminate intersections instead of empty intersections.

Then we extended the classical *Bel*(.), *Dis*(.) {also called *Dou*(.), i.e., Dough} and the uncertainty *U*(.) functions to their respectively neutrosophic correspondent functions that use the neutrosophic masses, i.e., to the *NeutBel*(.), *NeutDis*(.), *NeutU*(.) and to the undecidability function *NeutUnd*(.). We have also introduced the neutrosophic global indeterminacy function, *NeutGlobInd*(.), which together with *NeutU*(.) form the *NeutUnd*(.) function.

In our first example, the mass of $A \cap B$ is determined (it is equal to 0.14), but the element $A \cap B$ is indeterminate (we do not know if it empty or not).

But there are cases when the element is determinate (let us say a suspect John), but its mass could be indeterminate as given by a source of information {for example, $m_n(John)$ (0.4, 0.1, 0.2), i.e., there is some mass indeterminacy: $I(John)$ 0.2 0}.

These are the distinctions between the indeterminacy of an element, and the indeterminacy of a mass.

Acknowledgements

The author would like to thank Dr. Jean Dezert for his comments related to the indeterminate models from our Fall 2011.

References

Anantachaisilp, P. and Lin, Z. (2013) An experimental study on PID tuning methods for active magnetic bearing systems', *International Journal of Advanced Mechatronic Systems*, Vol. 5, No. 2, pp.146–154, DOI: 10.1504/IJAMECHS.2013.055991.

Broumi, S. and Smarandache, F. (2013) Intuitionistic neutrosophic soft set', *Journal of Information and Computing Science*, Vol. 8, No. 2, pp.130–140, England, UK.

Dunn, J.M. (1976) Intuitive semantics for first degree entailment and coupled trees', *Philosophical Studies*, Vol. XXIX, pp.149–68.

Goguen, J.A. (1969) The logic of inexact concepts', *Synthese*, Vol. 19, pp.325–375.

- Golpira, H. and Golpira, H. (2013) Application of signal processing technique for the modification of a fruit sorting machine', *International Journal of Advanced Mechatronic Systems*, Vol. 5, No. 2, pp.122–128, DOI: 10.1504/IJAMECHS.2013.055998.
- Hallden, S. (1949) *The Logic of Nonsense*, Uppsala Universitets Arsskrift.
- Korner, S. (1960) *The Philosophy of Mathematics*, Hutchinson, London.
- Okuyama, K., Anasri, M., Smarandache, F. and Kroumov, V. (2013) *Mobile Robot Navigation Using Artificial Landmarks and GPS*, by Bulletin of the Research Institute of Technology, Okayama University of Science, Japan.
- Quine, W.V. (1981) What price bivalence?', *Journal of Philosophy*, Vol. 77, pp.90–95.
- Smarandache, F. (1998) *A Unifying Field in Logics: Neutrosophic Logic. Neutrosophy, Neutrosophic Probability and Statistics*, Amer. Res. Press.
- Smarandache, F. (2002) A unifying field in logics: neutrosophic logic', *Multiple Valued Logic/An International Journal*, Vol. 8, No. 3, pp.385–438.
- Smarandache, F. (2011a) *Foundations and Applications of Information Fusion to Robotics*, Seminar to the PhD students of the Institute of Mechanical Solids of the Romanian Academy, Bucharest, 13 December.
- Smarandache, F. (2011b) *Neutrosophic Logic and Set Applied to Robotics*, seminar to the PhD students of the Institute of Mechanical Solids of the Romanian Academy, Bucharest, 14 December.
- Smarandache, F. (2013) Generalization of the dependent function in extenics for nested sets with common endpoints to 2D-space, 3D-space, and generally to n-D-space', *Critical Review*, A Publication of Society for Mathematics of Uncertainty, Center for Mathematics of Uncertainty, Creighton University, USA, Vol. VII, pp.16–23.
- Smarandache, F. and Dezert, J. (Eds.) (2004–2009) *Advances and applications of DSMT for information fusion*, Am. Res. Press, Rehoboth 2004–2009 [online] <http://fs.gallup.unm.edu/DsmT.htm>.
- Smarandache, F. and Vladareanu, L. (2011) Applications of neutrosophic logic to robotics/an introduction', in Hong, T-P., Kudo, Y., Kudo, M., Lin, T-Y., Chien, B-C., Wang, S-L., Inuiguchi, M. and Liu, G. (Eds.): *2011 IEEE International Conference on Granular Computing*, IEEE Computer Society, National University of Kaohsiung, Taiwan, 8–10 November, pp.607–612.
- Tye, M. (1994) Sorites paradoxes and the semantics of vagueness', in Tomberlin, J. (Eds.): *Philosophical Perspectives: Logic and Language*, Ridgeview, Atascadero, USA.
- Vladareanu, L., Tont, G., Vladareanu, V., Smarandache, F. and Capitanu, L. (2012a) The navigation mobile robot systems using bayesian approach through the virtual projection method', *Proceedings of the International Conference on Advanced Mechatronic Systems [ICAMechS 2012]*, Tokyo, Japan, 18–21 September, pp.498–503.
- Vladareanu, L., Wen, C., Munteanu, R.I., Yang, C., Vladareanu, V., Munteanu, R.A., Li, W., Smarandache, F. and Gal, A.I. (2012b) Method and device for extension hybrid force-position control of the robotic and mechatronics systems', Patent, p.20, OSIM A2012 1077/28.12.2012, Bucharest, Romania.
- Vladareanu, V., Smarandache, F. and Vladareanu, L. (2013) Extension hybrid force-position robot control in higher dimensions', *Applied Mechanics and Materials*, Vol. 332, pp.260–269, Trans Tech Publications, Switzerland, DOI: 10.4028/www.scientific.net/AMM.332.260.
- Wang, Y. and Wu, H. (2013) Neural networks-based adaptive robust controllers and its applications to water pollution control systems', *International Journal of Advanced Mechatronic Systems*, Vol. 5, No. 2, pp.138–145, DOI: 10.1504/IJAMECHS.2013.055990.
- Zadeh, L. (1965) Fuzzy sets', *Information and Control*, Vol. 8, pp.338–353.
- Zadeh, L.A. (1975) Fuzzy logic and approximate reasoning', *Synthese*, Vol. 30, pp.407–428.

PCR5 and Neutrosophic Probability in Target Identification (revisited)

Florentin Smarandache, Nassim Abbas, Youcef Chibani, Bilal Hadjadji, Zayen Azzouz Omar

Florentin Smarandache, Nassim Abbas, Youcef Chibani, Bilal Hadjadji, Zayen Azzouz Omar (2017). PCR5 and Neutrosophic Probability in Target Identification (revisited). *Neutrosophic Sets and Systems* 16, 76-79

Abstract. In this paper, we use PCR5 in order to fusion the information of two sources providing subjective probabilities of an event A to occur in the following form: chance that A occurs, indeterminate chance of occurrence of A, chance that A does not occur.

Keywords. Target Identification, PCR5, neutrosophic measure, neutrosophic probability, normalized neutrosophic probability.

I. INTRODUCTION

Neutrosophic Probability [1] was defined in 1995 and published in 1998, together with neutrosophic set, neutrosophic logic, and neutrosophic probability.

The words “neutrosophy” and “neutrosophic” were introduced by F. Smarandache in his 1998 book. Etymologically, “neutrosophy” (noun) [French neutre Latin neuter, neutral, and Greek sophia, skill/wisdom] means knowledge of neutral thought. While “neutrosophic” (adjective), means having the nature of, or having the characteristic of Neutrosophy.

Neutrosophy is a new branch of philosophy which studies the origin, nature, and scope of neutralities, as well as their interactions with different ideational spectra.

Zadeh introduced the degree of membership/truth (t) in 1965 and defined the fuzzy set.

Atanassov introduced the degree of nonmembership/falsehood (f) in 1986 and defined the intuitionistic fuzzy set.

Smarandache introduced the degree of indeterminacy/neutrality (i) as independent component in 1995 (published in 1998) and defined the neutrosophic set. He has coined the words “neutrosophy” and “neutrosophic”. In 2013 he refined/split the neutrosophic set to n components: $t_1, t_2, \dots, t_j, i_1, i_2, \dots, i_k, f_1, f_2, \dots, f_l$, with $j+k+l = n - 3$. And, as particular cases of refined neutrosophic set, he split the fuzzy

set truth into t_1, t_2, \dots ; and the intuitionistic fuzzy set into t_1, t_2, \dots and f_1, f_2, \dots .

See: <http://fs.gallup.unm.edu/neutrosophy.htm>.

For single valued neutrosophic logic, the sum of the components is:

0 $t+i+f = 3$ when all three components are independent;

0 $t+i+f = 2$ when two components are dependent, while the third one is independent from them;

0 $t+i+f = 1$ when all three components are dependent.

When three or two of the components T, I, F are independent, one leaves room for incomplete information (sum < 1), paraconsistent and contradictory information (sum > 1), or complete information (sum $= 1$).

If all three components T, I, F are dependent, then similarly one leaves room for incomplete information (sum < 1), or complete information (sum $= 1$).

II. DEFINITION OF NEUTROSOPHIC MEASURE

A neutrosophic space is a set which has some indeterminacy with respect to its elements.

Let X be a neutrosophic space, and Σ a σ -neutrosophic algebra over X . A *neutrosophic measure* ν is defined by for neutrosophic set $A \in \Sigma$ by

$$\nu : X \rightarrow R^3, \quad \nu(A) = (m(A), m(neutA), m(antiA)), \quad (1)$$

with $antiA$ the opposite of A, and $neutA$ the neutral (indeterminacy), neither A nor anti A (as defined above); for any $A \subseteq X$ and $A \in \Sigma$,

$m(A)$ means *measure of the determinate part of A*;
 $m(neutA)$ means *measure of indeterminate part of A*;

and $m(antiA)$ means *measure of the determinate part of antiA*; where ν is a function that satisfies the following two properties:

- a) Null empty set: $\nu(\Phi) = (0, 0, 0)$.
- b) Countable additivity (or σ -additivity): For all countable collections $\{A_n\}_{n \in L}$ of disjoint neutrosophic sets in Σ , one has:

$$\nu\left(\bigcup_{n \in L} A_n\right) = \left(\sum_{n \in L} m(A_n), \sum_{n \in L} m(neutA_n), \sum_{n \in L} m(antiA_n) - (n-1)m(X)\right) \tag{2}$$

where X is the whole neutrosophic space, and

$$\sum_{n \in L} m(antiA_n) - (n-1)m(X) = m(X) - \sum_{n \in L} m(A_n) = m\left(\bigcap_{n \in L} antiA_n\right). \tag{3}$$

A neutrosophic measure space is a triplet (X, Σ, ν) .

III. NORMALIZED NEUTROSOPHIC MEASURE

A neutrosophic measure is called normalized if

$$\nu(X) = (m(X), m(neutX), m(antiX)) = (x_1, x_2, x_3), \tag{4}$$

with $x_1 + x_2 + x_3 = 1$, and $x_1 \geq 0, x_2 \geq 0, x_3 \geq 0$, where, of course, X is the whole neutrosophic measure space.

As a particular case of neutrosophic measure ν is the neutrosophic probability measure, i.e. a neutrosophic measure that measures probable/possible propositions

$$0 \leq \nu(X) \leq 3,$$

where X is the whole neutrosophic probability sample space.

For single valued neutrosophic logic, the sum of the components is:

- 0 $x_1 + x_2 + x_3 = 3$ when all three components are independent;
- 0 $x_1 + x_2 + x_3 = 2$ when two components are dependent, while the third one is independent from them;
- 0 $x_1 + x_2 + x_3 = 1$ when all three components are dependent.

When three or two of the components x_1, x_2, x_3 are independent, one leaves room for incomplete information (sum = 1), paraconsistent and contradictory information (sum = 1), or complete information (sum = 1).

If all three components x_1, x_2, x_3 are dependent, then similarly one leaves room for incomplete information (sum = 1), or complete information (sum = 1).

IV. NORMALIZED PROBABILITY

We consider the case when the sum of the components $m(A) + m(neutA) + m(antiA) = 1$.

We may denote the normalized neutrosophic probability of an event A as $NP(A) = (t, i, f)$, where t is the chance that A occurs, i is indeterminate chance of occurrence of A , and f is the chance that A does not occur.

V. THE PCR5 FORMULA

Let the frame of discernment $\Theta = \{\theta_1, \theta_2, \dots, \theta_n\}, n \geq 2$.

Let $G = (\Theta, \cup, \cap, C)$ be the super-power set, which is closed under union, intersection, and respectively complement.

Let's consider two masses provided by 2 sources:

$$m_1, m_2 : G \rightarrow [0, 1].$$

The conjunctive rule is defined as

$$m_{12}(X) = \sum_{X_1, X_2 \in G} m_1(X_1)m_2(X_2). \tag{5}$$

Then the Proportional Conflict Redistribution Rule (PCR) 5 formula for 2 sources of information is defined as follows:

$$\forall X \in G \setminus \{\emptyset\},$$

$$m_{PCR5}(X) = m_{12}(X) + \sum_{Y \in G \setminus \{X\}} \left[\frac{m_1(X)^2 m_2(Y)}{m_1(X) + m_2(Y)} + \frac{m_2(X)^2 m_1(Y)}{m_1(X) + m_2(Y)} \right] \tag{6}$$

where all denominators are different from zero.

If a denominator is zero, that fraction is discarded.

VI. APPLICATION IN INFORMATION FUSION

Suppose an airplane A is detected by the radar. What is the chance that A is friendly, neutrally, or enemy?

Let's have two sources that provide the following information:

$$NP_1^{(A)}(t_1, i_1, f_1), \text{ and } NP_2^{(A)}(t_2, i_2, f_2).$$

Then:

$$[NP_1 \oplus NP_2](t) = t_1 t_2 + \left(\frac{t_1^2 i_2}{t_1 + i_2} + \frac{t_2^2 i_1}{t_2 + i_1}\right) + \left(\frac{t_1^2 f_2}{t_1 + f_2} + \frac{t_2^2 f_1}{t_2 + f_1}\right) \tag{7}$$

Because: $t_1 i_2$ is redistributed back to the truth (t) and indeterminacy proportionally with respect to t_1 and respectively i_2 :

$$\frac{x_1}{t_1} = \frac{y_1}{i_2} = \frac{t_1 i_2}{t_1 + i_2}, \tag{8}$$

$$\text{whence } x_1 = \frac{t_1^2 i_2}{t_1 + i_2}, y_1 = \frac{t_1 i_2^2}{t_1 + i_2}. \tag{9}$$

Similarly, $t_2 i_1$ is redistributed back to t and i proportionally with respect to t_2 and respectively i_1 :

$$\frac{x_2}{t_2} = \frac{y_2}{i_1} = \frac{t_2 i_1}{t_2 + i_1}, \tag{10}$$

$$\text{whence } x_2 = \frac{t_2^2 i_1}{t_2 + i_1}, y_2 = \frac{t_2 i_1^2}{t_2 + i_1}. \quad (11)$$

Similarly, $t_1 f_2$ is redistributed back to t and f (falsehood) proportionally with respect to t_1 and respectively f_2 :

$$\frac{x_3}{t_1} = \frac{z_1}{f_2} = \frac{t_1 f_2}{t_1 + f_2}, \quad (12)$$

$$\text{whence } x_3 = \frac{t_1^2 f_2}{t_1 + f_2}, z_1 = \frac{t_1 f_2^2}{t_1 + f_2}. \quad (13)$$

Again, similarly $t_2 f_1$ is redistributed back to t and f proportionally with respect to t_2 and respectively f_1 :

$$\frac{x_4}{t_2} = \frac{z_2}{f_1} = \frac{t_2 f_1}{t_2 + f_1}, \quad (14)$$

$$\text{whence } x_4 = \frac{t_2^2 f_1}{t_2 + f_1}, z_2 = \frac{t_2 f_1^2}{t_2 + f_1}. \quad (15)$$

In the same way, $i_1 f_2$ is redistributed back to i and f proportionally with respect to i_1 and respectively f_2 :

$$\frac{y_3}{i_1} = \frac{z_3}{f_2} = \frac{i_1 f_2}{i_1 + f_2}, \quad (16)$$

$$\text{whence } y_3 = \frac{i_1^2 f_2}{i_1 + f_2}, z_3 = \frac{i_1 f_2^2}{i_1 + f_2}. \quad (17)$$

While $i_2 f_1$ is redistributed back to i and t proportionally with respect to i_2 and respectively f_1 :

$$\frac{y_4}{i_2} = \frac{z_4}{f_1} = \frac{i_2 f_1}{i_2 + f_1}, \quad (18)$$

$$\text{whence } y_4 = \frac{i_2^2 f_1}{i_2 + f_1}, z_4 = \frac{i_2 f_1^2}{i_2 + f_1}. \quad (19)$$

Then

$$[NP_1 \oplus NP_2](i) = i_1 i_2 + \left(\frac{i_1^2 t_2}{i_{11} + t_2} + \frac{i_2^2 t_1}{i_2 + t_1} \right) + \left(\frac{i_1^2 f_2}{i_1 + f_2} + \frac{i_2^2 f_1}{i_2 + f_1} \right), \quad (20)$$

and

$$[NP_1 \oplus NP_2](f) = f_1 f_2 + \left(\frac{f_1^2 t_2}{f_1 + t_2} + \frac{f_2^2 t_1}{f_2 + t_1} \right) + \left(\frac{f_1^2 i_2}{f_1 + i_2} + \frac{f_2^2 i_1}{f_2 + i_1} \right). \quad (21)$$

VII. EXAMPLE

Let's compute: $(0.6, 0.1, 0.3) \wedge_N (0.2, 0.3, 0.5)$.

$$t_1 = 0.6, i_1 = 0.1, f_1 = 0.3, \text{ and}$$

$$t_2 = 0.2, i_2 = 0.3, f_2 = 0.5,$$

are replaced into the three previous neutrosophic logic formulas:

- (using PCR5 rule)

$$[NP_1 \oplus nm_2](t) = 0.6(0.2) + \left(\frac{0.6^2(0.3)}{0.6+0.3} + \frac{0.2^2(0.1)}{0.2+0.1} \right) + \left(\frac{0.6^2(0.5)}{0.6+0.5} + \frac{0.2^2(0.3)}{0.2+0.3} \right) \approx 0.44097$$

$$[NP_1 \oplus NP_2](i) = 0.1(0.3) + \left(\frac{0.1^2(0.2)}{0.1+0.2} + \frac{0.3^2(0.6)}{0.3+0.6} \right) + \left(\frac{0.1^2(0.5)}{0.1+0.5} + \frac{0.3^2(0.3)}{0.3+0.3} \right) \approx 0.15000$$

$$[NP_1 \oplus NP_2](f) = 0.3(0.5) + \left(\frac{0.3^2(0.2)}{0.3+0.2} + \frac{0.5^2(0.6)}{0.5+0.6} \right) + \left(\frac{0.3^2(0.3)}{0.3+0.3} + \frac{0.5^2(0.1)}{0.5+0.1} \right) \approx 0.40903$$

- (using Dempster's rule)

Conj. rule:

0.12	0.03	0.15
------	------	------

Dempster's rule:

0.40	0.10	0.50
------	------	------

This is actually a PCR5 formula for a frame of discernment $\Omega = \{\theta_1, \theta_2, \theta_3\}$ whose all intersections are empty.

We can design a PCR6 formula too for the same frame.

Another method will be to use the neutrosophic N -norm, which is a generalization of fuzzy T -norm.

If we have two neutrosophic probabilities

	Friend	Neutral	Enemy
NP_1	t_1	i_1	f_1
NP_2	t_2	i_2	f_2

then

$$NP_1 \oplus NP_2 = (t_1 + i_1 + f_1) \cdot (t_2 + i_2 + f_2)$$

$$\begin{aligned} & t_1 t_2 + t_1 i_2 + t_2 i_1 + i_1 i_2 + t_1 f_1 + \\ & t_1 f_2 + t_2 f_1 + i_1 f_2 + i_2 f_1 + f_1 f_2 \end{aligned}$$

Of course, the quantity of $t_1 t_2$ will go to Friend,

quantity of $i_1 i_2$ will go to Neutral,

and quantity of $f_1 f_2$ will go to Enemy.

The other quantities will go depending on the pessimistic or optimistic way:

- a) In the pessimistic way (lower bound) $t_1 i_2 + t_2 i_1$ will go to Neutral, and $t_1 f_2 + t_2 f_1 + i_1 f_2 + i_2 f_1$ to Enemy.
 - b) In the optimistic way (upper bound) $t_1 i_2 + t_2 i_1$ will go to Friend, and $t_1 f_2 + t_2 f_1 + i_1 f_2 + i_2 f_1$ to Neutral. About $t_1 f_2 + t_2 f_1$, we can split it half-half to Friend and respectively Enemy.
- We afterwards put together the pessimistic and optimistic ways as an interval neutrosophic probability.
- c) Of course, the reader or expert can use different transfers of intermediate mixed quantities $t_1 i_2 + t_2 i_1$, and respectively $t_1 f_2 + t_2 f_1 + i_1 f_2 + i_2 f_1$ to Friend, Neutral, and Enemy.

CONCLUSION

We have introduced the application of neutrosophic probability into information fusion, using the combination of information provided by two sources using the PCR5.

Other approaches can be done, for example the combination of the information using the N-norm and N-conorm, which are generalizations of the T-norm and T-conorm from the fuzzy theory to the neutrosophic theory.

More research is needed in this direction.

References

- [1] F. Smarandache, Neutrosophy. Neutrosophic Probability, Set, and Logic, Amer. Res. Press, Rehoboth, USA, 105 p., 1998; <http://fs.gallup.unm.edu/eBook-neutrosophics4.pdf> (4th edition).
- [2] W. B. Vasantha Kandasamy, Florentin Smarandache, Fuzzy Cognitive Maps and Neutrosophic Cognitive Maps, Xiquan, Phoenix, 211 p., 2003; <http://fs.gallup.unm.edu/NCMs.pdf>
- [3] F. Smarandache, Introduction of Neutrosophic Measure, Neutrosophic Integral, and Neutrosophic Probability, Sytech, Craiova, 2013.
- [4] F. Smarandache, n-Valued Refined Neutrosophic Logic and Its Applications in Physics, Progress in Physics, 143-146, Vol. 4, 2013; <http://fs.gallup.unm.edu/n-ValuedNeutrosophicLogic.pdf>
- [5] F. Smarandache, (t,i,f)-Neutrosophic Structures and I-Neutrosophic Structures, Neutrosophic Sets and Systems, 3-10, Vol. 8, 2015.
- [6] F. Smarandache, J. Dezert, Information Fusion Based on New Proportional Conflict Redistribution Rules, Proceedings of the 8th International Conference on Information Fusion, Philadelphia, 25-29 July, 2005; IEEE Catalog Number: 05EX1120C.

An Evidence Fusion Method with Importance Discounting Factors based on Neutrosophic Probability Analysis in DS_mT Framework

Qiang Guo, Haipeng Wang, You He, Yong Deng, Florentin Smarandache

Qiang Guo, Haipeng Wang, You He, Yong Deng, Florentin Smarandache (2017). An Evidence Fusion Method with Importance Discounting Factors based on Neutrosophic Probability Analysis in DS_mT Framework. *Neutrosophic Sets and Systems* 17, 64-73

Abstract:

To obtain effective fusion results of multi source evidences with different importance, an evidence fusion method with importance discounting factors based on neutrosophic probability analysis in DS_mT framework is proposed. First, the reasonable evidence sources are selected out based on the statistical analysis of the pignistic probability functions of single focal elements. Secondly, the neutrosophic probability analysis is conducted based on the similarities of the pignistic probability functions from the prior evidence knowledge of the reasonable evidence sources. Thirdly, the importance discounting factors of the reasonable evidence sources are obtained based on the neutrosophic probability analysis and the reliability

discounting factors of the real-time evidences are calculated based on probabilistic-based distances. Fourthly, the real-time evidences are discounted by the importance discounting factors and then the evidences with the mass assignments of neutrosophic empty sets are discounted by the reliability discounting factors. Finally, DS_mT+PCR5 of importance discounted evidences is applied. Experimental examples show that the decision results based on the proposed fusion method are different from the results based on the existed fusion methods. Simulation experiments of recognition fusion are performed and the superiority of proposed method is testified well by the simulation results.

Keywords: Information fusion; Belief function; Dezert-Smarandache Theory; Neutrosophic probability; Importance discounting factors.

1. Introduction

As a high-level and commonly applicable key technology, information fusion can integrate partial information from multisource, and decrease potential redundant and incompatible information between different sources, thus reducing uncertainties and improving the quick and correct decision ability of high intelligence systems. It has drawn wide attention attention by scholars and has found many successful applications in the military and economy fields in recent years [1-9]. With the increment of information environmental complexity, effective highly conflict evidence reasoning has huge demands on information fusion. Belief function also called evidence theory which includes Dempster-Shafer theory (DST) and Dezert-Smarandache theory (DS_mT) has made great efforts and contributions to solve this problem. Dempster-Shafer theory (DST) [10,11] has been commonly applied in information fusion field since it can represent uncertainty and full ignorance effectively and includes Bayesian theory

as a special case. Although very attractive, DST has some limitations, especially in dealing with highly conflict evidences fusion [9]. DS_mT, jointly proposed by Dezert and Smarandache, can be considered as an extension of DST. DS_mT can solve the complex fusion problems beyond the exclusive limit of the DST discernment framework and it can get more reasonable fusion results when multisource evidences are highly conflicting and the refinement of the discernment framework is unavailable. Recently, DS_mT has many successful applications in many areas, such as, Map Reconstruction of Robot [12,13], Clustering [14,15], Target Type Tracking [16,17], Image Processing [18], Data Classification [19-21], Decision Making Support [22], Sonar Imagery [23], and so on. Recently the research on the discounting factors based on DST or DS_mT have been done by many scholars [24,25]. Smarandache and et al [24] put forward that discounting factors in the procedure of evidence fusion should conclude

importance discounting factors and reliability discounting factors, and they also proved that effective fusion could not be carried out by Dempster combination rules when the importance discounting factors were considered. However, the method for calculating the importance discounting factors was not mentioned. A method for calculating importance or reliability discounting factors was proposed in article [25]. However, the importance and reliability discounting factors could not be distinguished and the focal element of empty set or full ignorance was processed based on DST. As the exhaustive limit of DST, it could not process empty set effectively. So, the fusion results based on importance and reliability

discounting factors are the same in [25], which is not consist with real situation. In this paper, an evidence fusion method with importance discounting factors based on neutrosophic probability analysis in DSMT framework is proposed. In Section 2, basic theories including DST, DSMT and the dissimilarity measure of evidences are introduced briefly. In Section 3, the contents and procedure of the proposed fusion method are given. In Section 4, simulation experiments in the application background of recognition fusion are also performed for testifying the superiority of proposed method. In Section 5, the conclusions are given.

2. Basic Theories

2.1. DST

Let $\Theta = \{\theta_1, \theta_2, L, \theta_n\}$ be the discernment frame having n exhaustive and exclusive hypotheses $\theta_i, i = 1, 2, L, n$. The exhaustive and exclusive limits of DST assume that the refinement of the fusion problem is accessible and the hypotheses are

$$2^\Theta = \{\emptyset, \{\theta_1\}, \{\theta_2\}, L, \{\theta_n\}, \{\theta_1, \theta_2\}, L, \{\theta_1, \theta_2, L, \theta_n\}\}. \tag{1}$$

In Shafer’s model, a basic belief assignment (bba) $m(\cdot): 2^\Theta \rightarrow [0,1]$ which consists evidences is defined by $m_k(\emptyset) = 0$ and $\sum_{A \in 2^\Theta} m(A) = 1$. (2)

The DST rule of combination (also called the Dempster combination rule) can be considered as a conjunctive normalized rule on the power set 2^Θ . The fusion results based on the Dempster combination rule are obtained by the bba’s products

$$(m_1 \oplus m_2)(C) = \frac{1}{1-K} \sum_{A \cap B = C} m_1(A)m_2(B), \forall C \subseteq \Theta \tag{3}$$

$$K = \sum_{\substack{A, B \subseteq \Theta \\ A \cap B = \emptyset}} m_1(A)m_2(B) \tag{4}$$

In some applications of multisource evidences fusion, some evidences influenced by the noise or some other conditions are highly conflicting with the other evidences. The reliability of an evidence can represent its accuracy degree of describing the given problem. The reliability discounting factor α in $[0, 1]$ is considered as the quantization of the reliability of an evidence. The reliability discounting method of

of the focal elements from different evidences which intersect to get the focal elements of the results. DST also assumes that the evidences are independent. The i^{th} evidence source’s bba is denoted m_i . The Dempster combination rule is given by [10,11]:

DST (also called the Shafer’s discounting method) is widely accepted and applied. The method consists of two steps. First, the mass assignments of focal elements are multiplied by the reliability discounting factor α . Second, all discounted mass assignments of the evidence are transferred to the focal element of full ignorance Θ . The Shafer’s discounting method can be mathematically defined as follows [10,11]

$$\begin{cases} m_\alpha(X) = \alpha \cdot m(X), \text{ for } X \neq \Theta \\ m_\alpha(X) = \alpha \cdot m(\Theta) + (1 - \alpha) \end{cases} \tag{5}$$

where the reliability discounting factor is denoted by α and $0 \leq \alpha \leq 1, X$ denotes the focal element which is not the empty set, $m(\cdot)$ denotes the original bba of evidence, $m_\alpha(\cdot)$ denotes the bba after importance discounting.

2.2. DSMT

For many complex fusion problems, the elements can not be separated precisely and the refinement of discernment frame is inaccessible. For dealing with this situation, DSMT [9] which overcomes the exclusive limit of DST, is jointly proposed by Dezert and Smarandache. The hyper-power set in DSMT framework denoted by D^Θ consists of the unions and intersections elements in

Θ . Assume that $\Theta = \{\theta_1, \theta_2\}$, the hyper-power set of Θ can be defined as $D^\Theta = \{\emptyset, \theta_1, \theta_2, \theta_3, \theta_1 \cup \theta_2, \theta_1 \cap \theta_2\}$. The bba which consists the body of the evidence in DSMT framework is defined on the hyper-power set as $m(\cdot): D^\Theta \rightarrow [0,1]$.

Dezert Smarandache Hybrid (DSmH) combination rule transfers partial conflicting beliefs to the union of the corresponding elements in conflicts which can be considered as partial ignorance or uncertainty. However, the way of transferring the conflicts in DSmH increases the uncertainty of fusion results and it is not convenient for decision-making based on the fusion results. The

$$m_{1\oplus 2}(X_i) = \sum_{\substack{Y, Z \in G^\Theta \text{ and } Y, Z \neq \emptyset \\ Y \cap Z = X_i}} m_1(Y) \cdot m_2(Z) \tag{6}$$

$$m_{PCR5}(X_i) = \begin{cases} m_{1\oplus 2} + \sum_{\substack{X_j \in G^\Theta \text{ and } i \neq j \\ X_i \cap X_j = \emptyset}} \left[\frac{m_1(X_i)^2 \cdot m_2(X_j)}{m_1(X_i) + m_2(X_j)} + \frac{m_2(X_i)^2 \cdot m_1(X_j)}{m_2(X_i) + m_1(X_j)} \right] & X_i \in G^\Theta \text{ and } X_i \neq \emptyset \\ 0 & X_i = \emptyset \end{cases}$$

where all denominators are more than zero, otherwise the fraction is discarded, and where G^Θ can be regarded as a general power set which is equivalent to the power set 2^Θ , the hyper-power set D^Θ and the super-power set S^Θ , if discernment of the fusion problem satisfies the Shafer's model, the hybrid DSm model, and the minimal refinement Θ^{ref} of Θ respectively [9,26,27].

Although PCR5 rule can get more reasonable fusion results than the combination rule of DST, it still has two disadvantages, first, it is not associative which means that the fusion sequence of multiple (more than 2) sources of evidences can influence the fusion results, second, with the increment of the focal element number in discernment frame, the computational complexity increases exponentially.

It is pointed out in [24] that importances and reliabilities of multisources in evidence fusion are different. The reliability of a source in DSMT framework represents the ability of describing the given problem by its real-time evidence which is the same as the notion in DST framework. The

$$\begin{cases} m_\beta(X) = \beta \cdot m(X), \text{ for } X \neq \emptyset \\ m_\beta(\emptyset) = \beta(\emptyset) + (1 - \beta) \end{cases} \tag{7}$$

where the importance discounting factor is denoted by β and $0 \leq \beta \leq 1$, X denotes the focal element which is not the empty set, $m(\cdot)$ denotes the original bba of evidence, $m_\beta(\cdot)$ denotes the bba after importance discounting. The empty set \emptyset of Equation (7) is particular in DSMT discounted framework which is not the representation of unknown elements under the open-world assumption

$$m_{PCR5_\beta}(A) = \sum_{\substack{X_1, X_2 \in G^\Theta \\ X_1 \cap X_2 = A}} m_1(X_1) m_2(X_2) + \sum_{\substack{X \in G^\Theta \\ X \cap A = \emptyset}} \left[\frac{m_1(A)^2 \cdot m_2(X)}{m_1(A) + m_2(X)} + \frac{m_2(A)^2 \cdot m_1(X)}{m_2(A) + m_1(X)} \right] \tag{8}$$

Proportional Conflict Redistribution (PCR) 1-6 rules overcome the weakness of DSmH and gives a better way of transferring the conflicts in multisource evidence fusion. PCR 1-6 rules proportionally transfer conflicting mass beliefs to the involved elements in the conflicts [9,26,27]. Each PCR rule has its own and different way of proportional redistribution of conflicts and PCR5 rule is considered as the most accurate rule among these PCR rules [9,26,27]. The combination of two independent evidences by PCR5 rule is given as follows [9,26,27]:

importances of sources in DSMT framework represent the weight that the fusion system designer assigns to the sources. Since the notions of importances and reliabilities of sources make no difference in DST framework, Shafer's discounting method can not be applied to evidence fusion of multisources with unequal importances.

The importance of a source in DSMT framework [24] can be characterized by an importance discounting factor, denoted β in $[0,1]$. The importance discounting factor β is not related with the reliability discounting factor α which is defined the same as DST framework. β can be any value in $[0,1]$ chosen by the fusion system designer for his or her experience. The main difference of importance discounting method and reliability discounting method lies in the importance discounted mass beliefs of evidences are transferred to the empty set rather than the total ignorance Θ . The importance discounting method in DSMT framework can be mathematically defined as

(Smets model), but only the meaning of the discounted importance of a source. Obviously, the importance discounted mass beliefs are transferred to the empty set in DSMT discounted framework which leads to the Dempster combination rule is not suitable to solve this type of fusion problems. The fusion rule with importance discounting factors in DSMT framework for 2 sources is considered as the extension of PCR5 rule, defined as follows [24]:

The fusion rules with importance discounting factors considered as the extension of PCR6 and the

fusion rule for multisources ($s > 2$) as the extension of PCR5 can be seen referred in [24].

3. An Evidence Fusion Method with Importance Discounting Factors Based on Neutrosophic Probability Analysis in DSMT Framework

An evidence fusion method with importance discounting factors based on neutrosophic probability analysis in DSMT framework is proposed in this section. First, the reasonable evidence sources are selected out based on the statistical analysis of the pignistic probability functions of single focal elements. Secondly, the neutrosophic probability analysis is conducted based on the similarities of the pignistic probability functions from the prior evidence knowledge of the reasonable evidence sources. Thirdly, the importance discounting factors

of the reasonable evidence sources are obtained based on the neutrosophic probability analysis and the reliability discounting factors of the real-time evidences are calculated based on probabilistic-based distances. Fourthly, the real-time evidences are discounted by the importance discounting factors and then the evidences with the mass assignments of neutrosophic empty sets are discounted by the reliability discounting factors. Finally, DSMT+PCR5 of importance discounted evidences is applied.

3.1. The reasonable evidence sources are selected out

Definition 1: Extraction function for extracting focal elements from the the pignistic probability functions of single focal elements.

$$\chi(P(a_i)) = a_i, a_i \in \{a_1, a_2, L, a_z\} \quad (11)$$

Definition 2: Reasonable sources.

The evidence sources are defined as reasonable sources if and only if the focal element which has the maximum mean value of the pignistic probability functions of all single focal elements is the element a_j which is known in prior knowledge, denoted by

$$\chi(P(\theta)) = \max(\overline{P(a)}) = a_j, 1 \leq i \leq z \quad (12)$$

where θ represents that the focal element which has the maximum mean value of the pignistic probability functions of all single focal elements.

Based on *Definition 2* and the prior evidence knowledge, reasonable sources are selected out. The unreasonable sources are not suggested to be considered in the following procedure for they are imprecise and unbelievable.

3.2. The neutrosophic probability analysis of the sources and the importance discounting factors in DSMT framework

The neutrosophic probability theory is proposed by Smarandache [30]. In this section, the neutrosophic probability analysis is conducted based

on the similarities of the pignistic probability functions from the prior evidence knowledge of the reasonable evidence sources.

Definition 3: Similarity measure of the pignistic probability functions (SMPPF).

Assume that the distribution characteristics of pignistic probability functions of the focal elements $P(a_i): \{\overline{P(a_i)}, \sigma(a_i)\}, P(a_k): \{\overline{P(a_k)}, \sigma(a_k)\}$.

$a_i, 1 \leq i \leq z$ and $a_k, k \neq i, 1 \leq k \leq z$ are denoted by:

The similarity measure of the pignistic probability functions(SMPPF) is the function satisfying the following conditions:

(1) Symmetry:

$$\forall a_i, a_k \in \Theta, Sim(P(a_i), P(a_k)) = Sim(P(a_k), P(a_i));$$

(2) Consistency:

$$\forall a_i \in \Theta, Sim(P(a_i), P(a_i)) = Sim(P(a_i), P(a_i)) = 1;$$

(3) Nonnegativity:

$$\forall a_i, a_k \in \Theta, Sim(P(a_i), P(a_k)) > 0.$$

We will say that $P(a_i)$ is more similar to $P(a_k)$ than $P(a_g)$ if and only if:

$$Sim(P(a_i), P(a_k)) > Sim(P(a_i), P(a_g)).$$

The similarity measure of the pignistic probability functions based on the distribution

$$similarity(a_i, a_k) = \exp \left\{ -\frac{|P(a_i) - P(a_k)|}{2[\sigma(a_i) + \sigma(a_k)]} \right\} \quad (13)$$

Assume that a_j is known in prior knowledge, the diagram for the similarity of the pignistic probability functions of focal elements a_j and a_k which has the largest SMPPF to a_j is shown in Fig. 1. $P(a_j)$ is mapped to a circle in which $\overline{P(a_j)}$ is the center and $\sigma(a_j)$ is the radius. Similarly, $P(a_k)$ is mapped to a circle in which $\overline{P(a_k)}$ is the center and $\sigma(a_k)$ is the radius. All the evidences in the prior knowledge from the reasonable source are mapped to the drops in any circle which means that the mapping from drops in the circle of $P(a_j)$ to the prior evidences is one-to-one mapping and similarly the mapping from drops in the circle of $P(a_k)$ to the prior evidences is also one-to-one mapping. If $P(a_j)$ is very similar to $P(a_k)$, the shadow accounts for a

characteristics of the pignistic probability functions is defined as follows:

large proportion of $P(a_j)$ or $P(a_k)$. If $P(a_j)$ or $P(a_k)$ has the random values in the shadow of the diagram, the evidences of the reasonable source can not totally and correctly support decision-making for there are two possibilities which are $P(a_j) > P(a_k)$ and $P(a_j) \leq P(a_k)$. If $P(a_j) \leq P(a_k)$ in the evidences, the decisions are wrong. However, if $P(a_j)$ or $P(a_k)$ has the random values in the blank of the diagram, there is only one possibility which is $P(a_j) > P(a_k)$ for the sources are reasonable and the decisions by these evidences are totally correct. So, we define the neutrosophic probability and the absolutely right probability of the reasonable evidence source as probability of $P(a_j)$ in the shadow and blank of the diagram.

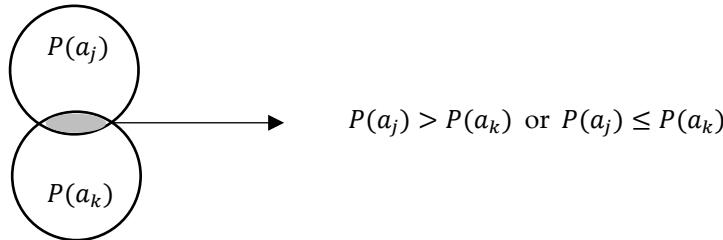

Figure 1. The diagram for the similarity.

Based on the above analysis, the neutrosophic probability and the absolutely right probability of the reasonable evidence source can be obtained by the similarity from the prior evidences for the mapping of the SMPPF of $P(a_j)$ and $P(a_k)$ to the probability of $P(a_j)$ in the shadow is one-to-one mapping.

As $\forall a_i, a_k \in \Theta, 0 < similarity(P(a_i) P(a_k)) \leq 1$, iff $a_i = P(S_k \text{ is neutral} | a_i) = \max_{1 < j < n, j \neq i} [similarity(P(a_i) P(a_k))]$ (14)

Then, the absolutely right probability of the reasonable evidence source in the prior condition that a_j is known can be calculated as follows:

$$(S_k \text{ is absolutely right} | a_i) = 1 - P(S_k \text{ is neutral} | a_i) = 1 - \max_{1 < j < n, j \neq i} [similarity(P(a_i) P(a_k))] \quad (15)$$

So, if the prior probability of each focal element can be obtained accurately, the absolutely right $P(S_k \text{ is absolutely right}) = \sum_{a_i \in \Theta, i=1,2,L,n} P(S_k \text{ is absolutely right} | a_i) g P(a_i)$. (16)

If the prior probability of each focal element can not be obtained accurately and any focal element has no advantage in the prior knowledge, denoted by

$$P(S_k \text{ is absolutely right}) = \frac{\sum_{a_i \in \Theta, i=1,2,L,n} P(S_k \text{ is absolutely right} | a_i)}{n} \quad (17)$$

We define the discounting factors of importances in DSmT framework $\alpha_{SIG}(S_k)$ as the normalization of the absolutely right probabilities of

$a_k, similarity(P(a_i))$, we define that the probability of $P(a_j)$ in the shadow is the same as $similarity(P(a_i) P(a_k))$.

Assume there are reasonable evidence sources for evidence fusion, denoted by $S_k, k = 1, 2, L, h$. So, the neutrosophic probability of the the reasonable evidence source in the prior condition that a_j is known can be calculated as follows:

probability of the reasonable evidence source can be calculated by the equation

$P(a_1) = P(a_2) = L = P(a_n)$, the absolutely right probability of the reasonable evidence source can be calculated as follows:

the the reasonable evidence sources $P(S_k \text{ is right}), k = 1, 2, L, h$, denoted by

$$\alpha_{SIG}(S_k) = \frac{P(S_k \text{ is absolutely right})}{\max_{k=1,2,L,h} [P(S_k \text{ is absolutely right})]} \quad (18)$$

3.3. The reliability discounting factors based on probabilistic-based distances

The Classical Pignistic Transformation(CPT) [9,10,11] is introduced briefly as follows:

$$P(A) = \sum_{X \in 2^\Theta} \frac{|X \cap A|}{|X|} m(X) \tag{19}$$

Based on CPT, if the mass assignments of the single focal elements which consist of the union set of single focal elements are equal divisions of the mass assignment of the union set of single focal elements in two evidences, the pignistic probability of two evidences are equal and the decisions of the two evidences based on CPT are also the same. From the view of decision, it is a good way to measure the similarity of the real-time evidences based on pignistic probability of evidences. Probabilistic distance based on Minkowski's distance [25] is applied in this paper to measure the similarity of real-time evidences. The method for calculating the

reliability discounting factors based on Minkowski's distance [25] ($t = 1$) is given as follows.

Assume that there are h evidence sources, denoted by $S_k, k = 1, 2, L, h$, the real-time 2 evidences from S_i and $S_j, i \neq j$ are denoted by $\mathbf{m}_i, \mathbf{m}_j$ the discernment framework of the sources is $\{\theta_1, \theta_2, L, \theta_n\}$, the pignistic probabilities of single focal elements from S_i are denoted by $P_{S_i}(\theta_w), 1 < w < n$ and the pignistic probabilities of single focal elements from S_j are denoted by $P_{S_j}(\theta_w), 1 < w < n$.

1) Minkowski's distance ($t = 1$) between two real-time evidences is calculated as follows:

$$DistP(\mathbf{m}_i, \mathbf{m}_j) = \frac{1}{2} \sum_{\substack{\theta_w \in \Theta \\ |\theta_w|=1}} |P_{S_i}(\theta_w) - P_{S_j}(\theta_w)|. \tag{20}$$

2) The similarity of the real-time evidences is obtained by

$$similarity(\mathbf{m}_i, \mathbf{m}_j) = 1 - DistP(\mathbf{m}_i, \mathbf{m}_j). \tag{21}$$

3) The similarity matrix of the real-time evidences from $S_k, k = 1, 2, L, h$ is given

$$S = \begin{bmatrix} 1 & similarity(\mathbf{m}_1, \mathbf{m}_2) & L & similarity(\mathbf{m}_1, \mathbf{m}_h) \\ similarity(\mathbf{m}_2, \mathbf{m}_1) & 1 & L & similarity(\mathbf{m}_2, \mathbf{m}_h) \\ M & M & M & M \\ similarity(\mathbf{m}_h, \mathbf{m}_1) & similarity(\mathbf{m}_h, \mathbf{m}_2) & L & 1 \end{bmatrix} \tag{22}$$

The average similarity of the real-time evidences from $S_k, k = 1, 2, L, h$ is given

$$\overline{similarity(S_k)} = \frac{\sum_{i=1,2,L,h, i \neq k} similarity(\mathbf{m}_i, \mathbf{m}_k)}{h-1} \tag{23}$$

4) The reliability discounting factors of the real-time evidences from $S_k, k = 1, 2, L, h$ is given

$$\alpha_{REL}(S_k) = \frac{\overline{similarity(S_k)}}{\max_{k=1,2,L,h} [\overline{similarity(S_k)}]} \tag{24}$$

3.4. The discounting method with both importance and reliability discounting factors in DSMT framework

1) Discounting evidences based on the discounting factors of importance.

Assume that the real-time evidence from the reasonable evidence source s_k is denoted by:

$$\mathbf{m}_k = \{m(A), A \subseteq D^\Theta\}, G^\Theta = \{a_1 L, a_2, a_1 I L I a_2, a_1 UL U a_2\}.$$

Based on the discounting factors of importances \mathbf{m}_k^{SIG} after importance-discounting by $\alpha_{SIG}(s_k)$ can be calculated by:

$$\mathbf{m}_k^{SIG} = \begin{cases} m^{SIG}(A) = \alpha_{SIG}(S_k)g(m(A)), A \subseteq G^\Theta \\ m^{SIG}(\emptyset) = 1 - \alpha_{SIG}(S_k) \end{cases} \tag{25}$$

where $m^{SIG}(A)$ are the mass assignments to all focal elements of the original evidence and $m^{SIG}(\emptyset)$ is the neutrosophic probability of the

source, which represents the mass assignment of paradox.

2) Discounting the real-time evidences based on reliability discounting factors after importance discounting.

As the property of the neutrosophic probability of the source, the pignistic probabilities of single focal elements are not changed after importance-discounting the real-time evidences in DSMT framework and the mass assignments of neutrosophic empty focal element which represent the importances degree of sources is added to the new

evidences. If some real-time evidence has larger conflict with the other real-time evidences, the evidence should be not reliable and the mass assignments of the focal elements of the evidence should be discounted based on the discounting factors of reliabilities. As one focal element of the new evidence, the mass assignment of neutrosophic

empty focal element of the unreliable evidence should also be discounted. So the new discounting method based on the discounting factors of

reliabilities after discounting by the discounting factors of importances is given as follows

$$m_K^{SIG} = \begin{cases} m^{\alpha SIG}(A) = \alpha_{REL}(S_k)g\alpha_{SIG}(S_k)g(m(A)), A \subseteq G^\Theta \\ m^{\alpha SIG}(\emptyset) = \alpha_{REL}(S_k)g[1 - \alpha_{SIG}(S_k)] \\ m^{\alpha SIG}(\Theta) = 1 - \alpha_{REL}(S_k) \end{cases} \quad (26)$$

3.5. The fusion method of PCR5₀ in DSMT framework is applied

After applying the new discounting method to the real-time evidences, the new evidences with the mass assignments of both the neutrosophic empty focal element and the total ignorance focal elements are obtained. The classic Dempster

fusion rules can not be sufficient to process these evidences in DSMT framework and PCR5 for 2 sources in DSMT framework is applied as our fusion method as follows:

$$m_{PCR5_0}(A) = \sum_{\substack{X_1, X_2 \in G^\Theta \\ X_1 \cap X_2 = A}} m_1(X_1)m_2(X_2) + \sum_{\substack{X \in G^\Theta \\ X \cap A = \emptyset}} \left[\frac{m_1(A)^2 \cdot m_2(X)}{m_1(A) + m_2(X)} + \frac{m_2(A)^2 \cdot m_1(X)}{m_2(A) + m_1(X)} \right], A \in G^\Theta \text{ or } \emptyset \quad (27)$$

The mass assignment of the neutrosophic empty focal element is included in the fusion results, which is not meaningful to decision. According to the

principle of proportion, $m_{PCR5_0}(\emptyset)$ in the fusion result is redistributed to the other focal elements of the fusion result as follows:

$$m'_{PCR5_0}(A) = m_{PCR5_0}(A) + \frac{m_{PCR5_0}(A)}{\sum_{A \in G^\Theta} m_{PCR5_0}(A)} \cdot m_{PCR5_0}(\emptyset), A \in G^\Theta$$

$$m'_{PCR5_0}(\emptyset) = 0 \quad (28)$$

where $m'_{PCR5_0}(A), A \in G^\Theta$ is the final fusion results of our method.

4. Simulation Experiments

The Monto Carlo simulation experiments of recognition fusion are carried out. Through the simulation experiment results comparison of the proposed method and the existed methods, included PCR5 fusion method, the method in [25] and PCR5 fusion method with the reliability discounting factors, the superiority of the proposed method is testified. (In this paper, all the simulation experiments are implemented by Matlab simulation in the hardware condition of Pentimu(R) Dual-Core CPU E5300 2.6GHz 2.59GHz, memory 1.99GB. Abscissas of the figures represent that the ratio of the the standard deviation of Gauss White noise to the

maximum standard deviation of the pignistic probabilities of focal elements in prior knowledge of the evidence sources, denoted by the ratio of the standard deviation of GWN to the pignistic probabilities of focal elements’.)

Assume that the prior knowledge of the evidence sources is counted as the random distributions of the pignistic probability when different focal element occurs. The prior knowledge is shown in *Table 3* and the characteristics of random distributions are denoted by $P(\cdot)$: (mean value, variance).

Table . Prior knowledge of evidence sources.

Evidence sources	Prior knowledge when a occurs	Prior knowledge when b occurs
S1	$P_1(a) \sim (0.6,0.3)$	$P_1(a) \sim (0.46,0.3)$
	$P_1(b) \sim (0.4,0.3)$	$P_1(b) \sim (0.54,0.3)$
S2	$P_2(a) \sim (0.6,0.3)$	$P_2(a) \sim (0.4,0.3)$
	$P_2(b) \sim (0.4,0.3)$	$P_2(b) \sim (0.6,0.3)$
S3	$P_3(a) \sim (0.8,0.05)$	$P_3(a) \sim (0.2,0.05)$
	$P_3(b) \sim (0.2,0.05)$	$P_3(b) \sim (0.8,0.05)$

5.1.1 Simulation experiments in the condition that importance discounting factors of most evidence sources are low

Assume that there are 3 evidence sources, denoted by s_1, s_2, s_3 , and the discernment framework

of the sources is 2 types of targets, denoted by $\{a,b\}$. The prior knowledge is shown in *Table 3*. Assume

that the pignistic probabilities of the focal elements are normally distributed. The real-time evidences of 3 sources are random selected out 1000 times based on the prior knowledge in *Table 3* in the condition that *a* occurs and *b* occurs respectively. The Moto-carlo simulation experiments of recognition fusion based on the proposed method and the existed methods are carried out. With the increment of the standard deviation of Gauss White noise in the mass assignments of evidences, the fusion results comparisons in different conditions are shown in *Fig. 3* and *Fig. 4*, and the mean value of the correct recognition rates and computation time are show in *Table 11* and *Table 12*.

The fusion results comparisons in the condition that importance discounting factors of most evidence sources are low show that:

1) The method proposed in this paper has the highest correct recognition rates among the existed methods. PCR5 fusion method has the secondly highest correct recognition rates, PCR5 fusion method with reliability discounting factors has the thirdly highest correct recognition rates, the method in [25] has the lowest correct recognition rates.

2) The method proposed in this paper has the largest computation time among the existed methods. the method in [25] has the secondly largest computation time, PCR5 fusion method with reliability discounting factors has the thirdly largest computation time, PCR5 fusion method has the lowest computation time.

Table 11. The mean value of correct recognition rates.

Prior conditions	The proposed method	PCR5 fusion method	The method in [25]	PCR5 fusion method with realibility-discounting factors
<i>a</i>	98.9%	88.6%	80.5%	84.3%
<i>b</i>	98.9%	87.6%	79.0%	82.9%

Table 1 . The mean value of computation time.

Prior conditions	The proposed method	PCR5 fusion method	The method in [25]	PCR5 fusion method with realibility-discounting factors
<i>a</i>	1.47×10^{-4}	0.48×10^{-4}	0.88×10^{-4}	0.67×10^{-4}
<i>b</i>	1.46×10^{-4}	0.47×10^{-4}	0.89×10^{-4}	0.66×10^{-4}

Table 1 . Prior knowledge of evidence sources.

Evidence sources	Prior knowledge when <i>a</i> occurs	Prior knowledge when <i>b</i> occurs
<i>s</i> ₁	$P_1(a) \sim (0.6,0.3)$	$P_1(a) \sim (0.46,0.3)$
	$P_1(b) \sim (0.4,0.3)$	$P_1(b) \sim (0.54,0.3)$
<i>s</i> ₂	$P_2(a) \sim (0.8,0.05)$	$P_2(a) \sim (0.2,0.05)$
	$P_2(b) \sim (0.2,0.05)$	$P_2(b) \sim (0.8,0.05)$
<i>s</i> ₃	$P_3(a) \sim (0.8,0.05)$	$P_3(a) \sim (0.2,0.05)$
	$P_3(b) \sim (0.2,0.05)$	$P_3(b) \sim (0.8,0.05)$

5.1.2 Simulation experiments in the condition that importance discounting factors of most evidence sources are high

Assume that there are 3 evidence sources, denoted by *s*₁, *s*₂, *s*₃, and the discernment framework of the sources is 2 types of targets, denoted by {*a*,*b*}. The prior knowledge is shown in *Table 13*. Assume

that the pignistic probabilities of the focal elements are normally distributed. The Moto-carlo simulation experiments are carried out similarly to the *Section 4.3.1*. With the increment of the standard deviation

of Gauss White noise in the mass assignments of evidences, the fusion results comparisons in different conditions are shown in Fig. 5 and Fig. 6, and the mean value of the correct recognition rates and

computation time are show in Table 14 and Table 15. The importance factors of the evidences are calculated by Equation (18). The importance factor of s_1 is 0.19, the importance factor of s_2 and s_3 is 1.

Table 1 . The mean value of correct recognition rates.

Prior conditions	The proposed method	PCR5 fusion method	The method in [25]	PCR5 fusion method with reliability-discounting factors
<i>a</i>	99.0%	98.8%	99.0%	99.0%
<i>b</i>	99.0%	98.8%	99.0%	99.0%

Table 1 . The mean value of computation time.

Prior conditions	The proposed method	PCR5 fusion method	The method in [25]	PCR5 fusion method with reliability-discounting factors
<i>a</i>	1.45×10^{-4}	0.47×10^{-4}	0.86×10^{-4}	0.67×10^{-4}
<i>b</i>	1.46×10^{-4}	0.47×10^{-4}	0.87×10^{-4}	0.65×10^{-4}

The fusion results comparisons in the condition that importance discounting factors of most evidence sources are high show that:

1) The correct recognition rates of four methods are similarly closed, PCR5 fusion method has the lowest correct recognition rates among four methods.

5. Conclusions

Based on the experiments results, we suggest that the fusion methods should be chosen based on the following conditions:

1) Judge whether the evidences are simple.

2) The method proposed in this paper has the largest computation time among the existed methods. the method in [25] has the secondly largest computation time, PCR5 fusion method with reliability discounting factors has the thirdly largest computation time, PCR5 fusion method has the lowest computation time.

2) The importance discounting factors of most evidences are low or not high, the method in this paper is chosen.

The importance discounting factors of most evidences are high, PCR5 fusion method with reliability discounting factors is chosen

References

- Alan J. Terry, Munir Zaman, John Illingworth. Sensor fusion by a novel algorithm for time delay estimation. *Digital Signal Processing*, 1, 22(3), 439-452.
- Yilmaz Kalkan, Buyurman Baykal. Multiple target localization & data association for frequency-only widely separated MIMO radar, *Digital Signal Processing*, 1, 25, 51-61.
- Donka Angelova, Lyudmila Mihaylova. Joint target tracking and classification with particle filtering and mixture Kalman filtering using kinematic radar information, *Digital Signal Processing*, 16(2), 180-204.
- Lauro Snidaro, Ingrid Visentini, Karna Bryan. Fusing uncertain knowledge and evidence for maritime situational awareness via Markov Logic Networks, *Information Fusion*. 21 (1) 159-172.
- Yi Yang, Deqiang Han, Chongzhao Han. Discounted combination of unreliable evidence using degree of disagreement, *International Journal of Approximate Reasoning*. 54(8) (1) 1197-1216.
- Ammar Cherchar, Messaoud Thameri, Adel Belouchrani. Performance improvement of direction finding algorithms in non-homogeneous environment through data fusion, *Digital Signal Processing*. 41 (1) 41-47.

7. X. Li, J. Dezert, F. Smarandache, X. Dai. Combination of qualitative information based on 2-Tuple modelings in DSMT, *Journal of Computer Science and Technology*. 24(4) () 786-798.
8. X. Li, J. Dezert, F. Smarandache. Fusion of imprecise qualitative information, *Applied Intelligence*. 33(3) (1) 340-351.
9. F. Smarandache, J. Dezert. *Advances and Applications of DSMT for Information Fusion*, American Research Press, Rehoboth, USA, Vol. 1, Vol. 2, Vol.3, 2004/2006/2009.
10. G. Shafer. *A Mathematical Theory of Evidence*, Princeton Univ. Press, Princeton, NJ, 1976.
11. G. Shafer, Perspectives on the Theory and Practice of Belief Functions, *International Journal of Approximate Reasoning*. 4 (1) 323-362.
12. R. Singh, M. Vatsa, A. Noore. Integrated multilevel image fusion and match score fusion of visible and infrared face images for robust face recognition, *Pattern Recognition*. 41(3) () 880-893.
13. X. Li, X. Huang, X. Dai, Z. Meng. Study on environment perception of mobile robots using DSMT-based fusion machine, *Journal of Huazhong University of Science and Technology*. 12(37) () 64-67 [Chinese].
14. Z. Liu, Q. Pan, J. Dezert, G. Mercier. Credal c-means clustering method based on belief functions, *Knowledge Based Syst*. 74 (1) 119-132.
15. T. Denoeux. Maximum likelihood estimation from Uncertain Data in the Belief Function Framework, *IEEE Transactions on Knowledge and Data Engineering*, 25(1) (1) 119-130.
16. T. Denoeux, N. El Zoghby, V. Cherfaoui, A. Jouglet. Optimal object association in the Dempster-Shafer framework, *IEEE Transactions on Cybernetics*. 44(22) (1) 2521-2531.
17. F. Faux, F. Luthon, Theory of evidence for face detection and tracking, *International Journal of Approximate Reasoning*. 53(5) (1) 728-746.
18. Z. Liu, J. Dezert, G. Mercier, Q. Pan. Dynamic Evidential Reasoning for Change Detection in Remote Sensing Images, *IEEE T. Geoscience and Remote Sensing*. 50(5) (1) 1955-1967.
19. Z. Liu, Q. Pan, J. Dezert, G. Mercier. Credal classification rule for uncertain data based on belief functions, *Pattern Recognition*. 47(7) (1) 2532-2541.
20. Z. Liu, Q. Pan, G. Mercier, J. Dezert. A New Incomplete Pattern Classification Method Based on Evidential Reasoning, *IEEE T. Cybernetics*. 45(4) (1) 635-646.
21. C. Lian, S. Ruan, T. Denoeux. An evidential classifier based on feature selection and two-step classification strategy, *Pattern Recognition*. 48 (1) 2318-2327.
22. Z. Liu, J. Dezert, Q. Pan, Gr goire Mercier. Combination of sources of evidence with different discounting factors based on a new dissimilarity measure, *Decision Support Systems*. 52(1) (11) 133-141.
23. X. Li, X. Huang, J. Dezert, et al. A successful application of DSMT in sonar grid map building and comparison with DST-based approach, *International Journal of Innovative Computing, Information and Control*. 3(3) () 539-551.
24. Smarandache F, Dezert J, Tacnet J.-M. Fusion of sources of evidence with different importances and reliabilities[C], in Proceedings of Fusion 2010 Conference, Edinburgh, UK, July 2010.
25. Liu Zhun-ga, Dezert J, Pan Quan. Mercier Gregoire. Combination of sources of evidence with different discounting factors based on a new dissimilarity measure, *Decision Support System* 52 (11), 133-141.
26. J. Dezert, F. Smarandache. DSMT: A new paradigm shift for information fusion, Cogis06 International Conference, Paris, France, 2006, pp. 15-17.
27. F. Smarandache, J. Dezert. Information Fusion Based on New Proportional Conflict Redistribution Rules, in: Proceedings of Fusion 2005 Conference, Philadelphia, July 26-29, 2005, pp. 907- 914.
28. M.C. Florea, E. Bosse, A.L. Jousselme. Metrics, distances and dissimilarity measures within Dempster-Shafer theory to characterize sources' reliability, Proceeding of Cognitive Systems with Interactive Sensors Conference (COGIS '09), 2009.
29. Anne-Laure Jousselme et al. A new distance between two bodies of evidence, *Information Fusion*. 2(2) (1) 91-101.
30. Florentin Smarandache. *A Unifying Field in Logics. Neutrosophy: Neutrosophic Probability, Set, and Logic*, American Research Press, Rehoboth, 1999.
31. F. Smarandache, *Neutrosophic Perspectives: Triplets, Duplets, Multisets, Hybrid Operators, Modal Logic, Hedge Algebras. And Applications*. Pons Editions, Bruxelles, 325 p., 2017.
32. Topal, S. and ner, T. Contrastings on Textual Entailmentness and Algorithms of Syllogistic Logics, *Journal of Mathematical Sciences*, Volume 2, Number 4, April 2015, pp 185-189.
33. Topal S. An Object- Oriented Approach to Counter-Model Constructions in A Fragment of Natural Language, *BEU Journal of Science*, 4(2), 103-111, 2015.

STATISTICS

Statistical Modeling of Primary Ewing Tumours of the Bone

Sreepurna Malakar, Florentin Smarandache, S. Bhattacharya

Sreepurna Malakar, Florentin Smarandache, S. Bhattacharya (2005). Statistical Modeling of Primary Ewing Tumours of the Bone. *International Journal of Tomography & Statistics* 3, JJ05, 81-88

ABSTRACT

This short technical paper advocates a bootstrapping algorithm from which we can form a statistically reliable opinion based on limited clinically observed data, regarding whether an osteo-hyperplasia could actually be a case of Ewing's osteosarcoma. The basic premise underlying our methodology is that a primary bone tumour, if it is indeed Ewing's osteosarcoma, cannot increase in volume beyond some critical limit without showing metastasis. We propose a statistical method to extrapolate such critical limit to primary tumour volume. Our model does not involve any physiological variables but rather is entirely based on time series observations of increase in primary tumour volume from the point of initial detection to the actual detection of metastases.

KEY WORDS

Ewing's bone tumour, multi-cellular spheroids, linear difference equations

INTRODUCTION

To date, oncogenetic studies of *EWS/FLI-11* induced malignant transformation have largely relied upon experimental manipulation of Ewing's bone tumour cell lines and fibroblasts that have been induced to express the oncogene. It has been shown that the biology of Ewing's tumour cells *in vitro* is dramatically different

between cells grown as mono-layers and cells grown as anchorage-independent, multi-cellular spheroids (MCS). The latter is more representative of primary Ewing's tumour *in vivo* (Lawlor et. al, 2002). MCS are clusters of cancer cells, used in the laboratory to study the early stages of avascular tumour growth. Mature MCS possess a well-defined structure, comprising a central core of necrotic i.e. dead cells, surrounded by a layer of non-proliferating, quiescent cells, with proliferating cells restricted to the outer, nutrient-rich layer of the tumour. As such, they are often used to assess the efficacy of new anti-cancer drugs and treatment therapies. The majority of mathematical models focus on the growth of MCS or avascular tumour growth. Most recent works have focused on the evolution of MCS growing in response to a single, externally-supplied nutrient, such as oxygen or glucose, and usually two growth inhibitors (Marusic et. al., 1994).

Mathematical models of MCS growth typically consist of an *ordinary differential equation* (ODE) coupled to one or more *reaction-diffusion equations* (RDEs). The ODE is derived from mass conservation and describes the evolution of the outer tumour boundary, whereas the RDEs describe the distribution within the tumour of vital nutrients such as oxygen and glucose and growth inhibitors (Dorman and Deutsch, 2002). However studies of this type, no matter how mathematically refined, often fall short of direct clinical applicability because of rather rigorous restrictions imposed on the boundary conditions. Moreover, these models focus more on the structural evolution of a tumour that is already positively classified as cancerous rather than on the clinically pertinent question of whether an initially benign growth can at a subsequent stage become invasive and show metastases (De Vita et. al., 2001).

What we therefore aim to devise in our present paper is a bootstrapping algorithm from which we can form an educated opinion based on clinically observed data, regarding whether a bone growth initially diagnosed as benign can subsequently prove to be malignant (i.e. specifically, a case of Ewing's osteosarcoma) . The strength of our proposed algorithm lies mainly in its computational simplicity – our model does not involve any physiological variables but is entirely based on time series observations of progression in tumour volume from the first observation point till detection of metastases.

LITERATURE SUPPORT

In a clinical study conducted by Hense et. al. (1999), restricted to patients with suspected Ewing's sarcoma, tumour volumes of more than 100 ml and the presence of primary metastases were identified as determinants of poor prognosis in patients with such tumours. Diagnoses of primary tumours were ascertained exclusively by biopsies. The diagnosis of primary metastases was based on *thoracic computed tomography* or on whole body bone scans. It was observed that of 559 of the patients (approx. 68% in a total sample size of 821) had a volume

above 100 ml with smaller tumours being more common in childhood than in late adolescence and early adulthood. Extensive volumes were observed in almost 90% of the tumours located in femur and pelvis while they were less common in other sites ($p < 0.001$). On average, 26% of all patients were detected with clinically apparent primary metastases.

The detection rate of metastases was markedly higher in patients diagnosed after 1991 ($p < 0.001$). Primary metastases were also significantly more common for tumours originating in the pelvis and for other tumours in the Ewing's family of tumours (EFT); mainly the peripheral neuro-ectodermal tumours (PNET); ($p < 0.01$). Tumours greater than 100 ml were positively associated with metastatic disease ($p < 0.001$). Multivariate analyses, which included simultaneously all univariate predictors in a *logistic regression model*, indicated the observed associations were mostly unconfounded. Further it has been found that the metastatic potential of human tumours is encoded in the bulk of a primary tumour, thus challenging the notion that metastases arise from sparse cells within a primary tumour that have the ability to metastasize (Sridhar Ramaswamy et. al., 2003). These studies lend credence to our fundamental premise about a critical primary tumour volume being used as a classification factor to distinguish between benign and potentially malignant bone growth.

STATISTICAL MODELLING METHODOLOGY

Assuming that the temporal drift process governing the progression in size of a primary Ewing tumour of the bone to be linear (the computationally simplest process), we suggest a straightforward computational technique to generate a large family of possible tumour propagation paths based on clinically observed growth patterns under laboratory conditions. In case the governing process is decidedly non-linear, then our proposed scheme would not be applicable and in such a case one will have to rely on a completely non-parametric classification technique like e.g. an Artificial Neural Network (ANN).

Our proposed approach is a bootstrapping one, whereby a linear autoregression model is fitted through the origin to the observation data in the first stage. If one or more beta coefficients are found to be significant at least at a 95% level for the fitted model then, in the second stage, the autoregression equation is formulated and solved as a *linear difference equation* to extract the governing equation.

In the final stage, the governing equation obtained as above is plotted, for different values of the constant coefficients, as a family of possible temporal progression curves generated to explain the propagation property of that particular strain of tumour. The critical volume of the primary growth can thereafter be visually extrapolated from the observed cluster of points where the generated family of primary tumour progression curves shows a *definite uptrend* vis-à-vis the actual progression curve.

If no beta coefficient is found to be significant in the first stage, a non-linear temporal progression process is strongly suspected and the algorithm terminates without proceeding onto the subsequent stages, thereby implicitly recommending the problem to a non-parametric classification model.

The mathematical structure of our proposed model may be given as follows:

Progression in primary Ewing tumour size over time expressed as an n-step general autoregressive process through the origin:

$$S_t = \sum_{j=1}^n \beta_j S_{t-j} + \varepsilon \tag{I}$$

Formulated as a linear, difference equation we can write:

$$-S_t + \beta_1 S_{t-1} + \beta_2 S_{t-2} + \dots + \beta_n S_{t-n} = -\varepsilon \tag{II}$$

Taking S_t common and applying the *negative shift operator* throughout, we get:

$$[-1 + \beta_1 E^{-1} + \beta_2 E^{-2} + \dots + \beta_n E^{-n}] S_t = -\varepsilon \tag{III}$$

Now applying the *positive shift operator* throughout we get:

$$[-E^n + \beta_1 E^{n-1} + \beta_2 E^{n-2} + \dots + \beta_n] S_t = -\varepsilon \tag{IV}$$

The *characteristic equation* of the above form is then obtained as follows:

$$-r^n + \beta_1 r^{n-1} + \beta_2 r^{n-2} + \dots + (\beta_n + \varepsilon) = 0 \tag{V}$$

Here r is the root of the characteristic equation. After solving for r , the governing equation can be derived in accordance with the well-known analytical solution techniques for ordinary linear difference equations (Kelly and Peterson, 2000).

SIMULATED CLINICAL STUDY

We set up a simulated clinical study applying our modeling methodology with the following hypothetical primary Ewing tumour progression data adapted from the clinical study of Hense et. al. (1999) as given in Table I below:

Table I

Observation (t)	Primary Ewing tumour volume (in ml.)
(At point of first detection)	
1	5
2	7
3	9
4	19
5	39
6	91
7	102
(At the point of detection of metastasis)	

Figure I

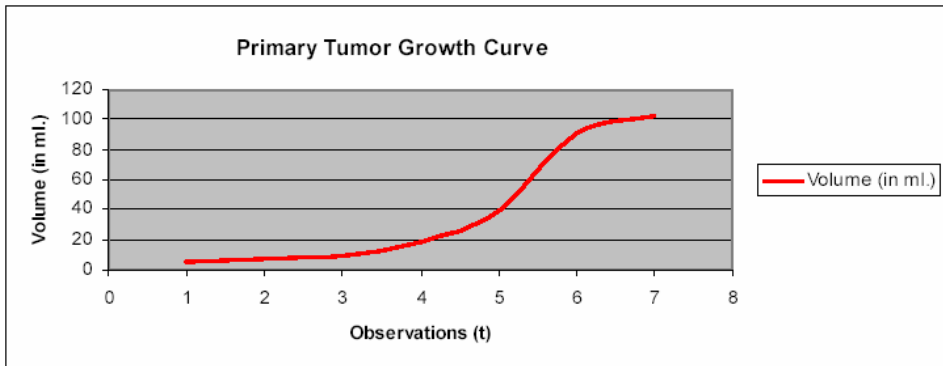

The temporal progression path of the primary growth from the point of first detection to the onset of metastasis is plotted above in Figure I.

We have fitted an AR (2) model to the primary tumour growth data as follows:

$$E(S_t) = -1.01081081S_{t-1} + 5.32365561S_{t-2} \quad (VI)$$

The R^2 of the fitted model is approximately 0.8311 and the F -statistic is 9.83832

with an associated p-value of approximately 0.04812. Therefore the fitted model definitely has an overall predictive utility at the 5% level of significance. The residuals of the above AR (2) fitted model are given in Table II as follows:

Table II

<i>Observation</i>	<i>Predicted S_t</i>	<i>Residuals</i>
1	-5.05405405	12.05405405
2	19.5426024	-10.5426024
3	28.168292	-9.168292003
4	28.7074951	10.29250488
5	61.7278351	29.27216495
6	115.638785	-13.63878518

The average of the residuals comes to 3.044841. Therefore the linear difference equation to be solved in this case is as follows:

$$X_t = -1.01081081X_{t-1} + 5.32365561X_{t-2} + 3.044841 \tag{VII}$$

Applying usual solution techniques, the general solution to equation (VII) is obtained as follows:

$$X_t = c_1 (2.43124756)^t + c_2 (-3.44205837)^t \tag{VIII}$$

Here c_1 and c_2 are the constant coefficients which may now be suitably varied to generate family of possible primary tumour progression curves as in Figure II below:

Figure II

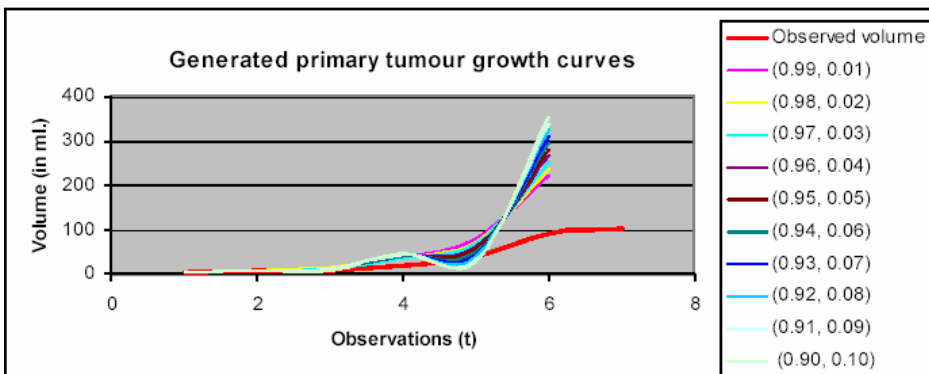

In the above plot, we have varied c_2 in the range 0.01 to 0.10 and imposed the condition $c_1 = 1 - c_2$. The other obvious condition is that choice of c_1 and c_2 would be such as to rule out any absurd case of negative volume. Of course the choice of the governing equation parameters would also depend on specific clinical considerations (King, 2000).

CONCLUSION

From Figure II, it becomes visually apparent that continuing increase in the observed size of the primary growth beyond approximately 52 ml. in volume would be potentially malignant as this would imply that the tumour would possibly keep exhibiting uncontrolled progression till it shows metastasis. This could also be obtained arithmetically as the average volume for $t = 5$. Therefore the critical volume could be fixed around 2 ml. as per the computational results obtained in our illustrative example.

Though our computational study is intended to be purely illustrative as we have worked with hypothetical figures and hence cannot yield any clinical conclusion, we believe we have hereby aptly demonstrated the essential algorithm of our statistical approach and justified its practical usability under laboratory settings. This is not intended to be a clinical paper and in defense, it may be stated that given the immense potential of computer modeling and simulation in present times, a number of mathematical tumor growth studies are being conducted now that are essentially theoretical rather than clinical in nature (Swanson et. al. 2003; Tabatabai, Williams and Bursac, 2005).

We have used a difference equation model rather than a differential equation one because under practical laboratory settings, observations cannot be made continuously but only at discrete time intervals. However, as already stated previously, the numerical example we have provided is purely demonstrative - its purpose is illustrating the computational modeling technique rather than drawing clinically viable conclusions based on the model coefficients. Having said that, we definitely feel that there is an immediate scope of taking our line of research further forward by actually implementing an autoregressive process to model *in vitro* growth of MCS with clinically observed data.

REFERENCES

- DeVita, V., T., S. Hellman, and S.A. Rosenberg, 2001, *Cancer – Principles & Practice of Oncology*, 6th Ed., Lippincott Williams & Wilkins, Philadelphia, USA
- Dormann, S. and A. Deutsch, 2003, *Modeling of self-organized, avascular tumour growth with a hybrid cellular automaton*, www.bioinfo.de/isb/2002/02/0035/main.html, (last accessed on 09/09/2003)
- Hense, H.W., S. Ahrens, M. Paulussen, M. Lehnert and H. Jurgens, 1999, *Factors associated with tumor volume and primary metastases in Ewing tumors: results from the (E1) CESS studies*, *Annals of Oncology*, 10(9), 1073-1077
- Kelly, Walter G. and Allan C. Peterson, 2000, *. Difference Equations – An Introduction with Applications*, 2nd Ed., Academic Press, Massachusetts, Burlington, USA
- King, Roger J.B., 2000, *Cancer Biology*, 2nd Ed., Pearson Education Limited, Essex, UK
- Lawlor E.R., C. Scheel, J. Irving, and P.H.B. Sorensen, 2002, *Anchorage-Independent multicellular spheroids as an in vitro model of growth signaling in Ewing tumors*, *Oncogene*, 21, 307-318
- Marusic, M., Z. Bajzer, S. Vuk-Pavlovic, and J.P. Freyer, 1994, *Tumor growth in vivo and as multicellular spheroids compared by mathematical models*, *Bulletin of Mathematical Biology*, 56(4), 617-31
- Ramaswamy, S., K.N. Ross, E.S. Lander and T.R. Golub, *Evidence for a Molecular Signature of Metastasis in Primary Solid Tumours*, www.genome.wi.mit.edu/cancer/solid_tumor_metastasis_1, (last accessed on 09/09/2003)
- Swanson, K.R., C. Bridge, J.D. Murray, and E.C. Alvord Jr., 2003, *Virtual and real brain tumors: using mathematical model to quantify glioma growth and invasion*, *Journal of the Neurological Sciences*, 216, 1 -10
- Tabatabai, M., D.K. Williams, and Z. Bursac, 2005, *Hyperbolastic growth models: theory and application*, *Theoretical Biology and Medical Modelling*, 2(14), (in print)

Effective Number of Parties in a Multi-Party Democracy under an entropic political equilibrium with floating voters

Sukanto Bhattacharya, Florentin Smarandache

Sukanto Bhattacharya, Florentin Smarandache (2007). Effective Number of Parties in a Multi-Party Democracy under an entropic political equilibrium with floating voters. *International Journal of Applied Mathematics* 20(3), 323-332

Abstract: In this short, technical paper we have sought to derive, under a posited formal model of political equilibrium, an expression for the effective number of political parties (ENP) that can contest elections in a multi-party democracy having a plurality voting system (also known as a first-past-the-post voting system). We have postulated a formal definition of political equilibrium borrowed from the financial market equilibrium whereby given the set of utility preferences of all eligible voters as well as of all the candidates, each and every candidate in an electoral fray stands the same objective chance of getting elected. Using an expected information paradigm, we show that under a condition of political equilibrium, the effective number of political parties is given by the reciprocal of the proportion of core electorate (non-floating voters). We have further argued that the formulated index agrees with a party system predicted by Duverger's law.

AMS Subject Classification: 91B12, 91F10, 91D30, 90B50

Key Words: plurality voting, entropic equilibrium, floating voters, Duverger's law

1. Introduction

Plurality voting systems are currently used in over forty countries worldwide which include some of the largest democracies like USA, Canada, India and UK. Under the basic plurality voting system, a country is divided into territorial single-member constituencies; voters within each constituency cast a single ballot (typically marked by a X) for one candidate; and the candidate with the largest share of votes in each seat is returned to office; and the political party (or a confederation of ideologically similar political parties) with an overall majority of seats forms the government. The fundamental feature of the plurality voting system is that single-member constituencies are based on the size of the electorate. For example, the US is divided into 435 Congressional districts each including roughly equal populations with one House representative per district. Boundaries of constituencies are reviewed at periodic intervals based on the national census to maintain the electorate balance. However the number of voters per constituency varies dramatically across countries, e.g. India has 545 representatives for a population of over nine hundred million, so each member of the Lok Sabha (House of the People) serves nearly two million people, while in contrast Ireland has 166 members in the Dial for a population slightly more than three-and-half million or approximately one seat for a little over twenty thousand people.

Under the first-past-the-post voting system candidates only need a simple plurality i.e. at least one more vote than their closest rival to get elected. Hence in three-way electoral contests, the winning candidate can theoretically have less than fifty percent of votes cast in his or her favor. For example, if the vote shares are 35%, 34% and 31%, the candidate with a 35% vote share will get elected. Therefore, although two-thirds of voters support other candidates, the candidate with a simple plurality of votes wins the contest (Norris, 1997).

We define political equilibrium as a condition in which the choices of voters and political parties are all compatible and in which no one group can improve its position by making a different choice. In essence therefore, political equilibrium may be said to exist when, given the set of utility preferences of all eligible voters as well as of all the candidates, each and every candidate in an electoral fray stands the same chance of getting elected. This definition is adequately broad to cover more specific conditional equilibrium models and is based on the principle of efficiency as applied to financial markets. Daniel Sutter (2002) defines political equilibrium as “a balance between demands by citizens on the political system and candidates compete for office”. There-

fore, translated to a multi-party democracy having a plurality voting system, political equilibrium can be thought to imply a state, where perfect balance of power exists between all contesting parties. Methodologically, we build our formal equilibrium model using an expected information approach used in a generalized financial market equilibrium model (Bhattacharya, 2001).

2. Computing an Effective Number of Political Parties

Is there a unique optimum for the number of political parties that have to compete in order to ensure a political equilibrium? If there indeed is such an optimal number then this number necessarily has to be central to any theoretical formalization of political equilibrium as we have defined. Rae (1967) advanced the first formal expression for political fractionalization in a multi-party democracy as follows:

$$F_s = 1 - z(s_i)^2 .$$

Here F_s is known as Rae's index of political fractionalization and s_i is the proportion of seats of the i -th political party in the Parliament. Conceptually, Rae's fractionalization index is adapted from the Herfindahl-Hirschman market power concentration index. F is 0 for a single-party system and F tends to 0.50 for a two-party system in equilibrium i.e. when both parties command same proportion of seats in the Parliament. Of course F asymptotically approaches unity as the party system becomes more and more fractionalized. Of course, one may adapt Rae's fractionalization index in terms of the proportion of votes secured in an election instead of seats in Parliament. In that case Rae's index of fractionalization may be represented as follows:

$$F_v = 1 - z(v_i)^2 .$$

Dumont and Caulier (2003) have recognized two major drawbacks of Rae's index. Firstly, the index is not linear for parties that are tied in strength; measured either as proportion of seats or proportion of votes. A two-party system in equilibrium produces an F of 0.50, whereas a four-party system in equilibrium produces 0.75 and a five-party system in equilibrium will have an F of 0.80. Dumont and Caulier (2003) point out that this feature makes the F untenable as an index as the operationalized measure and the phenomenon it measures follow different progression paths. Secondly, Rae's index is, like most other normalized indices of social phenomena, extremely difficult to interpret in objective terms as a unique variable characterizing a

party system. The effective number of parties (ENP) measure formulated by Laakso and Taagepera (1979) by improving on Rae's index is now commonly regarded as the classical numerical measure for the comparative analysis of party systems. This ENP formula takes both the number of parties and their relative weights into account when computing a unique variable characterizing a party system thereby making objective interpretation a lot easier as compared to Rae's fractionalization index. The ENP formula is simply stated as the reciprocal of the complement of Rae's fractionalization index i.e.

$$ENP_s = (1 - F_s)^{-1} \quad \text{and} \quad ENP_v = (1 - F_v)^{-1}.$$

In equilibrium, all political parties will command the same strength measured either as proportion of seats or votes and ENP will exactly equal the number of parties in fray. Taagepera and Shugart (1989) have argued that the ENP has become a widely-used index because it "usually tends to agree with our average intuition about the number of serious parties". However Molinar (1991) and Dunleavy and Boucek (2003) have argued that this index produces counter-intuitive and counter-empirical results under a number of circumstances. Taagepera (1999) himself suggested that in cases, where one party clearly dominates the political system (commanding more than 50% of the seats), an additional index called the LC (Largest Component) index should be used in conjunction with ENP. The LC is simply the reciprocal of the share of the largest party. When LC is greater than 2 for any party, that party clearly dominates the political system which would however be classified as a multi-party system if only the ENP was the sole classification criterion. Dunleavy and Boucek (2003) have advocated the averaging of ENP index with the LC index to yield a unique classification criterion. Dumont and Caulier (2003) advanced the effective number of relevant parties measure (ENRP) as an improvement over the ENP in a way that their measure yields a unique classification criterion that roughly corresponds to the ENP measure when there are more than two parties that can be considered as major contenders for victory in an electoral contest and collapses to unity if there are only one or two parties that can be seriously considered as a potential winner.

Irrespective of which variant of the ENP index we consider, it is obvious that an intuitive paradigm formalizing political equilibrium in a multi-party democracy having a plurality voting system may be constructed if it can be shown that in equilibrium, all parties in fray are indeed expected to command an equal strength measured either in terms of seats or votes. But such formalization would be considered somewhat limited if it did not take

into account the impact of floating voters on electoral outcomes. These are the quintessential fence-sitters who waver between parties during the course of a Parliament, or who do not make up their minds until very close to the election (or even until actually putting their stamps on the ballot paper). The impact of floating voters on electoral outcome is all the more an important issue for large-sized electorates as is the case for very populous countries like India. But none of the ENP indices consider floating voters.

Effective number of political parties with floating voters in entropic equilibrium Considering a finite fraction of floating voters in any electorate, we may define the following relationship as the (conservative) expected vote share of the i -th political party:

$$E(V_i) = [E(S_i)](1 - \lambda_i).$$

Here $E(S_i)$ is the i -th candidate's expected vote share as a proportion of the total electorate size and λ_i is the fraction of the i -th candidate's vote share that is deemed to come from floating voters. This is the fraction of electorate which is generally supportive of the i -th candidate but this support may or may not be translated into actual votes on the day of the election. Thus $E(S_i)$ is the expected proportion of votes to be cast in the i -th candidate's favor accepting the existence of floating voters in the electorate. Therefore we may write:

$$z_i E(V_i) = z_i [E(S_i)](1 - \lambda_i).$$

Let us denote $z_i E(V_i)$ as $E(V)$ and $z_i E(S_i)$ as $E(S)$. Therefore, rearranging (5) we get:

$$z_i [E(S_i)] \lambda_i = E(S) - E(V).$$

In the mathematical information theory, entropy or expected information from an event is measured using a logarithmic function borrowed from classical thermodynamics. There are two possible mutually exclusive and exhaustive outcomes for any individual event -either the event occurs or the event does not occur. If there are m candidates in an electoral fray the two events associated with each candidate in fray is that either the particular candidate wins the election or he/she does not win. If p_i is the probability of the i -th candidate winning the election, then the expected information content of a message that conveys the outcome of an election with $i = 1, 2, \dots, m$ candidates is obtained by the classical entropy function as formulated by Shannon (1948) as follows:

$$\psi(p) = (-C') z_i (p_i) \log_2(p_i).$$

Here C' is a positive scale factor (a negentropic counterpart of the Boltzmann constant in thermodynamic entropy). Under an m -party political equilibrium, the long run core (non-floating) vote shares of the $i = 1, 2, \dots, m$ candidates in electoral fray may be considered as equivalent to their long run winning probabilities. Thus $\psi(p)$ is re-writable as follows:

$$\psi(1 - \lambda) = (-C') \sum_i (1 - \lambda_i) \log_2(1 - \lambda_i). \tag{1}$$

Proposition. *If $\psi(1 - \lambda)$ is the expected information from the knowledge of an electoral outcome given the proportion of non-floating voters $(1 - \lambda_i)$ in the vote share of the i -th candidate, then the effective number of parties under entropic equilibrium is given as:*

$$ENP(\lambda) = (1 - \lambda^*)^{-1}; \quad \text{where } \lambda^* = 1 - E(V) / E(S)$$

Proof. Incorporating the Lagrangian multiplier L the objective function can be written as:

$$Z(1 - \lambda_i, L) = (-C') \sum_i z_i(1 - \lambda_i) \log_2(1 - \lambda_i) + L\{1 - \sum_i z_i(1 - \lambda_i)\}.$$

Taking partial derivative of Z with respect to $(1 - \lambda_i)$ and setting equal to zero as per the necessary condition of maximization, the following stationary condition is obtained:

$$\partial Z / \partial(1 - \lambda_i) = (-C')\{\log_2(1 - \lambda_i) + 1\} - L = 0.$$

Therefore at the point of maximum entropy one gets $\log_2(1 - \lambda_i) = -(L/C' + 1)$, i.e. $(1 - \lambda_i)$ becomes a constant value independent of i for all $i = 1, 2, \dots, m$ candidates in the electoral contest. Since necessarily the $1 - \lambda_i$ values must sum to unity, it implies that at the point of maximum entropy we must have $p_1 = p_2 = \dots = p_m = (1 - \lambda^*) = 1/m$.

Therefore

$$m \equiv ENP(\lambda) = (1 - \lambda^*)^{-1}.$$

Simplifying the expression for $z_i[E(S_i)]\lambda_i = E(S) - E(V)$ under equilibrium we may write: $\lambda^* E(S) = E(S) - E(V)$, i.e. $\lambda^* = 1 - E(V)/E(S)$. \square

λ^* is simply the total percentage of floating voters under an entropic political equilibrium. Thus $ENP(\lambda)$ is formally obtained (as expected intuitively) as the reciprocal of the equilibrium percentage of non-floating voters in the electorate. The higher the proportion of floating voters within the

electorate, the higher is the value of $ENP(\lambda)$. The intuitive reasoning is obvious - with a large number of floating votes to go around, more candidates could stay in the electoral fray than there would be if the electorate consisted of only a very small percentage of floating voters. When $\lambda = 50\%$, $ENP(\lambda) = 2$. If λ goes up to 75%, $ENP(\lambda)$ will go up to 4, i.e. with 25% more floating voters within the electorate, 2 more candidates can stay in electoral fray feeding off the floating votes.

Thus $ENP(\lambda)$ (the formula for which is structurally quite similar to Laakso and Taagepera's ENP index) is a generalized measure of ENP based on the entropic formalization of political equilibrium accepting the very real existence of floating voters.

3. Entropic Political Equilibrium and Duverger's Law

Duverger (1951) stated that the electoral contest in a single-seat electoral constituency following a plurality voting system tends to converge to a two-party system. *Duverger's law* basically stems from the premise of *strategic voting*. Palfrey (1989) has showed that in large electorates, equilibrium voting behavior implies that a voter will always vote for the most preferred candidate of the two frontrunners. For a given electorate of size n , Palfrey's model is stated in terms of the following inequality:

$$u_k > u_j [(z_{i \neq j} (p_{ij}^n / p_{kl}^n) / (z_{h \neq k} (p_{kh}^n / p_{kl}^n))] + z_{i \neq j, k} u_i [\{ (p_{ki}^n - p_{ij}^n) / p_{kl}^n \} / z_{h \neq k} (p_{kh}^n / p_{kl}^n)] .$$

In this model, u_k denotes the voter's utility of his/her first choice among the two frontrunners and u_l denotes the voter's utility for his/her second choice among the frontrunners so that $u_k > u_l$. Also j is any other candidate from among the $i = 1, 2, \dots, m$ candidates. The notation p_{ij}^n stands for the probability that the candidate i and candidate j are tied for the most votes and the interpretation is similar for notations p_{kh}^n and p^{nkl} . In the limiting case, the likelihood ratio p_{kh}^n / p^{nkl} tends to zero for all $ij \neq kl$. Thus the right-hand side of the inequality converges to u_l irrespective of j ; thereby mathematically establishing Duverger's law. Apart from Palfrey's theoretical formalization, Cox and Amorem Neto (1997) and Benoit (1998) and Schneider (2004) have provided empirical evidence generally supportive of Duverger's law.

It therefore seems rather appropriate that an intuitive model of political equilibrium in a multi-party democracy that follows a plurality voting system

should at least take Duverger's law into consideration if not actually have it embedded in some form within its formal structure. This is true for our entropic model, because as m increases $(1 - \lambda^*) = 1/m$ becomes smaller and smaller, thereby implying that for multi-party democracies that follow a plurality voting system, the political equilibrium most likely to prevail in the long run will tend to occur at the highest possible value of $(1 - \lambda^*) = 50\%$. In other words, although some relatively new democracies may start off with a number of political parties contesting elections and a very large percentage of floating voters in the electorate, the likelihood is very low that a very high proportion (exceeding 50%) of the electorate will be composed of floating voters in the long run which implies that in the long run, "mature" multi-party democracies having plurality voting systems will tend to have only two parties as serious contenders for victory in an election; corresponding to a two-party system as stated by Duverger's law.

4. Conclusion

We have proposed and mathematically derived a formula for the effective number of political parties that can be in electoral fray under a condition of political equilibrium in a multi-party democracy following a plurality voting system. We have posited the expected information approach to formalize the concept of political equilibrium in a parliamentary democracy. Our advocated model aims to improve upon existing ENP indices by incorporating the very realistic consideration of the impact of floating voters on elections. Of course, ours has been an entirely theoretical exercise and a potentially rewarding direction of future research would be to empirically investigate the veracity of $ENP(\lambda)$ possibly in conjunction with a suitable classification model to distinguish floating voters.

References

- [1] K. Benoit, The number of parties: New evidence from local elections, In: *Annual Meeting of the American Political Science Association*, Boston Marriott Copley Place and Sheraton Boston Hotel and Towers (September 3-6, 1998).
- [2] S. Bhattacharya, Mathematical modeling of a generalized securities market as a binary, stochastic system, *Journal of Statistics and Management Systems*, **4**, No. 2 (2001), 137-45.

- [3] G.W. Cox, O. Amorem Neto, Electoral institutions, cleavage structures and the number of parties, *American Journal of Political Science*, **41** (1997), 149-7.
- [4] P. Dumont, J.-F. Caulier, The effective number of relevant parties: How voting power improves Laakso-Taagepera's index, In: *Europlace Institute of Finance Working Papers*: <http://www.institut-europlace.com/mapping/ief.phtml?m=14&r=919> (2003).
- [5] P. Dunleavy, F. Boucek, Constructing the number of parties, *Party Politics*, **9**, No. 3 (2003), 291-315.
- [6] M. Duverger, *Political Parties: Their Organization and Activity in the Modern State*, London-Methuen-New York, John Wiley and Sons (1954).
- [7] N. Gabay, Decoding 'floating votes' in Israeli direct elections: Allocation model based on discriminant analysis technique, *Israeli Sociology A*, **2** (1999), 295-318.
- [8] M. Laakso, R. Taagepera, Effective number of parties: A measure with application to West Europe, *Comparative Political Studies*, **12** (1979), 3-27.
- [9] J. Molinar, Counting the number of parties: An alternative index, *American Political Science Review*, **85** (1991), 1383-91.
- [10] P. Norris, Choosing electoral systems: Proportional, majoritarian and mixed systems, *International Political Science Review*, **18** (1997), 297-312.
- [11] T.R. Palfrey, A mathematical proof of Duverger's Law, In: *Models of Strategic Choice in Politics* (Ed. P.C. Ordeshook), Ann Arbor: University of Mich. Press (1989), 69-92.
- [12] D. Rae, *The Political Consequences of Electoral Laws*, New Haven, Yale University Press (1967).
- [13] G. Schneider, Falling apart or flocking together? Left-right polarization in the OECD since World War II, *2004 Workshop of the Polarization and Conflict Network*, Barcelona, December 10-12 (2004).
- [14] C.E. Shannon, A mathematical theory of communication, *Bell System Technical Journal*, **27** (1948), 379-423.
- [15] D. Sutter, The democratic efficiency debate and definitions of political equilibrium, *The Review of Austrian Economics*, **15**, No. 3 (2002), 199-209.
- [16] R. Taagepera, M.S. Shugart, *Seats and Votes: The Effects and Determinants of Electoral Systems*, New Haven, Yale University Press (1989).

Short Note on Neutrosophic Statistics as a generalization of Classical Statistics

Florentin Smarandache

Florentin Smarandache (2021). Short Note on Neutrosophic Statistics as a generalization of Classical Statistics. *Journal of Rajasthan Statistical Association* 3(1), 159-171

While the Classical Statistics deals with determinate data and determinate inference methods only, the Neutrosophic Statistics deals with indeterminate data, i.e. data that has some degree of indeterminacy (unclear, vague, partially unknown, contradictory, incomplete, etc.), and indeterminate inference methods that contain degrees of indeterminacy as well (for example, instead of crisp arguments and values for the probability distributions, charts, diagrams, algorithms, functions etc. one may have inexact or ambiguous arguments and values).

The Neutrosophic Statistics was founded by Prof. Dr. Florentin Smarandache, from the University of New Mexico, United States, in 1998, who developed it in 2014 by introducing the Neutrosophic Descriptive Statistics (NDS). Further on, Prof. Dr. Muhammad Aslam, from the King Abdulaziz University, Saudi Arabia, introduced in 2018 the Neutrosophic Inferential Statistics (NIS), Neutrosophic Applied Statistics (NAS), and Neutrosophic Statistical Quality Control (NSQC).

The Neutrosophic Statistics is also a generalization of Interval Statistics, because of, among others, while Interval Statistics is based on Interval Analysis, Neutrosophic Statistics is based on Set Analysis (meaning all kind of sets, not only intervals).

Neutrosophic Statistics is more elastic than Classical Statistics. If all data and inference methods are determinate, then the Neutrosophic Statistics coincides with the Classical Statistics.

But, since in our world we have more indeterminate data than determinate data, therefore more neutrosophic statistical procedures are needed than classical ones.

Neutrosophic Numbers of the form $N = a + bI$ have been defined by W. B. VasanthaKandasamy and F. Smarandache in 2003 [see B2], and they were interpreted as "a" is the determinate part of the number N, and "bI" as the indeterminate part of the number N by F. Smarandache in 2014 [see B3].

Neutrosophic Statistics is the analysis of events described by the Neutrosophic Probability.

Neutrosophic Probability is a generalization of the classical probability and imprecise probability in which the chance that an event A occurs is $t\%$ true - where t varies in the subset T , $i\%$ indeterminate - where i varies in the subset I , and $f\%$ false - where f varies in the subset F . In classical probability the sum of all space probabilities is equal to 1, while in Neutrosophic Probability it is equal to 3.

In Imprecise Probability: the probability of an event is a subset T in $[0, 1]$, not a number p in $[0, 1]$, what's left is supposed to be the opposite, subset F (also from the unit interval $[0, 1]$); there is no indeterminate subset I in imprecise probability [see B9].

The function that models the Neutrosophic Probability of a random variable x is called *Neutrosophic distribution*: $NP(x) = (T(x), I(x), F(x))$, where $T(x)$ represents the probability that value x occurs, $F(x)$ represents the probability that value x does not occur, and $I(x)$ represents the indeterminate / unknown probability of value x [see B3].

More than 100 papers, nine books, one PhD thesis, and five international scientific seminars have been published or presented on neutrosophic statistics, including many journals by Elsevier and Springer of high impact factor.

REFERENCES

BOOKS

1. B1. Florentin Smarandache: A Unifying Field in Logics: Neutrosophic Logic. Neutrosophy, Neutrosophic Set, Neutrosophic Probability and Statistics (sixth edition). InfoLearnQuest, 1998 - 2007, 156 p. <http://fs.unm.edu/eBook-Neutrosophics6.pdf>
2. B2. W. B. VasanthaKandasamy, FlorentinSmarandache, *Fuzzy Cognitive Maps and Neutrosophic Cognitive Maps*, Xiquan, Phoenix, 211 p., 2003, <http://fs.unm.edu/NCMs.pdf>
3. B3. Florentin Smarandache: Introduction to Neutrosophic Statistics. Sitech & Education Publishing, 2014, 124 p. <http://fs.unm.edu/NeutrosophicStatistics.pdf>
4. B4. Florentin Smarandache: Neutrosophic Overset, Neutrosophic Underset, and Neutrosophic Offset. Similarly for Neutrosophic Over-/Under-/Off- Logic, Probability, and Statistics. Pons Editions, Brussels, 2016, 168 p. <http://fs.unm.edu/NeutrosophicOversetUndersetOffset.pdf>
5. B5. Maikel Leyva Vázquez, Florentin Smarandache: Neutrosofía: Nuevos avances en el tratamiento de la incertidumbre. Pons Editions, Bruselas, 2018, 74 p. <http://fs.unm.edu/NeutrososofiaNuevosAvances.pdf>
6. B6. Tatiana Veronica Gutierrez Quinonez, Fabian Andres Espinoza, Ingrid Kathyuska Giraldo, Angel Steven Asanza, Mauricio Daniel Montenegro: Estadística y Probabilidades: Una Vision Neutrosofica desde el Aprendizaje Basado en Problemas en la Construcción del Conocimiento. Pons Editions, Bruselas, 2020, 131 p. <http://fs.unm.edu/EstadisticaYProbabilidadNeutrososofica.pdf>

7. B7. F. Smarandache, Neutrosophic Statistics vs. Classical Statistics, section in *Nidus Idearum / Superluminal Physics*, Vol. 7, third edition, p. 117, 2019, <http://fs.unm.edu/NidusIdearum7-ed3.pdf>.
8. B8. F. Smarandache, *Nidus Idearum de Neutrosophia (Book Series)*, Editions Pons, Brussels, Belgium, Vols. 1-7, 2016-2019; <http://fs.unm.edu/ScienceLibrary.htm>
9. B9. F. Smarandache, *Introduction to Neutrosophic Measure, Neutrosophic Integral, and Neutrosophic Probability*, Sitech Publishing House, Craiova, 2013, <http://fs.unm.edu/NeutrosophicMeasureIntegralProbability.pdf>

Ph.D. THESIS

1. PhD1. Rafif Alhabib: Formulation of the classical probability and some probability distributions due to neutrosophic logic and its impact on Decision Making. PhD Thesis in Arabic, held under the supervision of Dr. M. M. Ranna, Dr. H. Farah, Dr. A. A. Salama, Faculty of Science, Department of Mathematical Statistics, University of Aleppo, Syrian Arab Republic, 2019. <http://fs.unm.edu/NS/FormulationOfTheClassicalProbability-PhDThesis.pdf>

ARTICLES

1. FlorentinSmarandache: Operators on Single-Valued Neutrosophic Oversets, Neutrosophic Undersets, and Neutrosophic Offsets. *Journal of Mathematics and Informatics*, Vol. 5, 2016, 63-67.
2. FlorentinSmarandache: Interval-Valued Neutrosophic Oversets, Neutrosophic Undersets, and Neutrosophic Offsets. *International Journal of Science and Engineering Investigations*, Vol. 5, issue 54, 2016, Paper ID: 55416-01, 4 p.
3. Nouran M. Radwan, M. BadrSenousy, Alaa El Din M. Riad: Approaches for Managing Uncertainty in Learning Management Systems. *Egyptian Computer Science Journal*, vol. 40, no. 2, May 2016, 10 p.
4. Muhammad Aslam: A Variable Acceptance Sampling Plan under Neutrosophic Statistical Interval Method. *Symmetry* 2019, 11, 114, DOI: 10.3390/sym11010114.
5. SoumyadipDhar, Malay K. Kundu: Accurate segmentation of complex document image using digital shearlet transform with neutrosophic set as uncertainty handling tool. *Applied Soft Computing*, vol. 61, 2017, 412–426.
6. B. Kavitha, S. Karthikeyan, P. SheebaMaybell: An ensemble design of intrusion system for handling uncertainty using Neutrosophic Logic Classifier. *Knowledge-Based Systems*, vol. 28, 2012, 88-96.
7. Muhammad Aslam: A new attribute sampling plan using neutrosophic statistical interval method. *Complex & Intelligent Systems*, 6 p. DOI: 10.1007/s40747-018-0088-6

8. Muhammad Aslam, Nasrullah Khan, Mohammed Albassam: Control Chart for Failure-Censored Reliability Tests under Uncertainty Environment. *Symmetry* 2018, 10, 690, DOI: 10.3390/sym10120690.
9. Muhammad Aslam, Nasrullah Khan, Ali Hussein AL-Marshadi: Design of Variable Sampling Plan for Pareto Distribution Using Neutrosophic Statistical Interval Method. *Symmetry* 2019, 11, 80, DOI: 10.3390/sym11010080.
10. Jun Ye, Jiqian Chen, Rui Yong, Shigui Du: Expression and Analysis of Joint Roughness Coefficient Using Neutrosophic Number Functions. *Information*, Volume 8, 2017, 13 pages.
11. Jiqian Chen, Jun Ye, Shigui Du, Rui Yong: Expressions of Rock Joint Roughness Coefficient Using Neutrosophic Interval Statistical Numbers. *Symmetry*, Volume 9, 2017, 7 pages.
12. Adrian Rubio-Solis, George Panoutsos: Fuzzy Uncertainty Assessment in RBF Neural Networks using neutrosophic sets for Multiclass Classification. Presented at 2014 IEEE International Conference on Fuzzy Systems (FUZZ-IEEE) July 6-11, 2014, Beijing, China, 8 pages.
13. Pierpaolo D'Urso: Informational Paradigm, management of uncertainty and theoretical formalisms in the clustering framework: A review. *Information Sciences*, 400–401 (2017), pp. 30-62, 33 pages.
14. Muhammad Aslam, Mohammed Albassam: Inspection Plan Based on the Process Capability Index Using the Neutrosophic Statistical Method. *Mathematics* 2019, 7, 631, DOI: 10.3390/math7070631.
15. Mirela Teodorescu, Florentin Smarandache, Daniela Gifu: Maintenance Operating System Uncertainties Approached through Neutrosophic Theory. 8 p.
16. Muhammad Aslam, Rashad A. R. Bantan, Nasrullah Khan: Monitoring the Process Based on Belief Statistic for Neutrosophic Gamma Distributed Product. *Processes* 2019, 7, 209, DOI: 10.3390/pr7040209.
17. Rafael Rojas-Gualdrón, Florentin Smarandache, Carlos Diaz-Bohorquez: Application of The Neutrosophical Theory to Deal with Uncertainty in Supply Chain Risk Management. *AGLALA* 2019; 10 (2): 1-19.
18. Florentin Smarandache, Gheorghe Savoiu: Neutrosophic Index Numbers: Neutrosophic Logic Applied In The Statistical Indicators Theory. *Critical Review*, Vol. XI, 2015, pp. 67-100.
19. Murat Kirisci, Necip Simsek: Neutrosophic normed spaces and statistical convergence. *Journal of Analysis*, 11 April 2020, DOI: 10.1007/s41478-020-00234-0.
20. S.K. Patro: The Neutrosophic Statistical Distribution: More Problems, More Solutions. 17 p.

21. DeepeshKunwar, Jayant Singh, FlorentinSmarandache: Neutrosophic statistical evaluation of migration with particular reference to Jaipur. *Octagon Mathematical Magazine*, vol. 26, no. 2, October 2018, 560-568.
22. DeepeshKunwar, Jayant Singh, FlorentinSmarandache: Neutrosophic statistical techniques to find migration pattern in Jaipur. *Octagon Mathematical Magazine*, vol. 26, no. 2, October 2018, 583-592.
23. Muhammad Aslam, Osama H. Arif, Rehan Ahmad Khan Sherwani: New Diagnosis Test under the Neutrosophic Statistics: An Application to Diabetic Patients. Hindawi, BioMed Research International, Volume 2020, Article ID 2086185, 7 pages; DOI: 10.1155/2020/2086185.
24. Jose L. Salmeron, FlorentinSmarandache: Processing Uncertainty and Indeterminacy in Information Systems success mapping. 13 p., arXiv:cs/0512047v2.
25. Wenzhong Jiang, Jun Ye, Wenhua Cui: Scale Effect and Anisotropic Analysis of Rock Joint Roughness Coefficient Neutrosophic Interval Statistical Numbers Based on Neutrosophic Statistics. *Journal of Soft Computing in Civil Engineering*, 2-4 / 2018, 62-71; DOI: 10.5281/zenodo.3130240.
26. Muhammad Aslam, P. Jeyadurga, SaminathanBalamurali, Ali Hussein Al-Marshadi: Time-Truncated Group Plan under aWeibull Distribution based on Neutrosophic Statistics. *Mathematics* 2019, 7, 905; DOI: 10.3390/math7100905
27. A.A. Salama, M. ElsayedWahed, EmanYousif: A Multi-objective Transportation Data Problems and their Based on Fuzzy Random Variables. *Neutrosophic Knowledge*, vol. 1, 2020, 41-53; DOI: 10.5281/zenodo.4269558.
28. Philippe Schweizer: Uncertainty: two probabilities for the three states of neutrosophy. *International Journal of Neutrosophic Science (IJNS)*, Volume 2, Issue 1, 2020, 18-26; DOI: 10.5281/zenodo.3989350.
29. Carlos N. Bouza-Herrera, Mir Subzar: Estimating the Ratio of a Crisp Variable and a Neutrosophic Variable. *International Journal of Neutrosophic Science (IJNS)*, Volume 11, Issue 1, 2020, 9-21; DOI: 10.5281/zenodo.4275712
30. Angel Carlos YumarCarralero, Darvin Manuel Ramirez Guerra, Giorver Perez Iribar: Analisis estadistico neutrosofico en la aplicacion de ejercicios fisicos en la rehabilitacion del adulto mayor con gonartrosis. *Neutrosophic Computing and Machine Learning*, Vol. 13, 1-9, 2020; DOI: <https://zenodo.org/record/3901770>.
31. Alexandra Dolores Molina Manzo, Rosa Leonor Maldonado Manzano, Blanca Esmeralda Brito Herrera, Johanna Irene Escobar Jara: Analisis estadistico neutrosofico de la incidencia del voto facultativo de los jovenes entre 16 y 18 anos en el proceso electoral del Ecuador. *Neutrosophic Computing and Machine Learning*, Vol. 11, 9-14, 2020; DOI: <https://zenodo.org/record/3474439>.
32. Johana Cristina Sierra Morán, Jenny Fernanda Enríquez Chuga, Wilmer Medardo Arias Collaguazo And Carlos Wilman Maldonado Gudiño: Neutrosophic statistics

- applied to the analysis of socially responsible participation in the community , Neutrosophic Sets and Systems, vol. 26, 2019, pp. 19 -28. DOI: 10.5281/zenodo.3244232
33. Paúl Alejandro Centeno Maldonado, Yusmany Puertas Martinez, Gabriela Stephanie Escobar Valverde, and Juan Danilo Inca Erazo: Neutrosophic statistics methods applied to demonstrate the extra-contractual liability of the state from the Administrative Organic Code, Neutrosophic Sets and Systems, vol. 26, 2019, pp. 29-34. DOI: 10.5281/zenodo.3244262
 34. S. K. Patro, F. Smarandache: The Neutrosophic Statistical Distribution - More Problems, More Solutions, Neutrosophic Sets and Systems, vol. 12, 2016, pp. 73-79. doi.org/10.5281/zenodo.571153
 35. Lilia Esther Valencia Cruzaty, Mariela Reyes Tomalá, Carlos Manuel Castillo Gallo and Florentin Smarandache, A Neutrosophic Statistic Method to Predict Tax Time Series in Ecuador, Neutrosophic Sets and Systems, vol. 34, 2020, pp. 33-39. DOI: 10.5281/zenodo.3843289; <http://fs.unm.edu/NSS/NeutrosophicStatisticMethod.pdf>
 36. Somen Deb Nath: Neutrosophication of statistical data in a study to assess the knowledge, attitude and symptoms on reproductive tract infection among women. *Journal of Fuzzy Extension & Applications (JFEA)*, Volume 2, Issue 1, Winter 2021, 33-40; DOI: 10.22105/JFEA.2021.272508.1073.
 37. Muhammad Aslam, Rashad A.R. Bantan, Nasrullah Khan: Design of tests for mean and variance under complexity-an application to rock measurement data. Elsevier: *Measurement*, Volume 177, June 2021, 109312; DOI: 10.1016/j.measurement.2021.109312.
 38. O.H. Arif, Muhammad Aslam: A new sudden death chart for the Weibull distribution under complexity. Springer: *Complex & Intelligent Systems* (2021); DOI: 10.1007/s40747-021-00316-x.
 39. Nasrullah Khan, Muhammad Aslam, Asma Arshad, Ambreen Shafqat: Tracking Temperature Under Uncertainty Using EWMA-MA Control Chart. Springer: *Journal of Metrology Society of India* (2021); DOI: 10.1007/s12647-021-00436-2.
 40. Muhammad Aslam: Analyzing wind power data using analysis of means under neutrosophic statistics. Springer: *Soft Computing* (2021); DOI: 10.1007/s00500-021-05661-0.
 41. Muhammad Aslam: On Testing Autocorrelation in Metrology Data Under Indeterminacy. Springer: *Journal of Metrology Society of India* (2021); DOI: 10.1007/s12647-021-00429-1.
 42. Muhammad Aslam, Nasrullah Khan: Normality Test of Temperature in Jeddah City Using Cochran's Test Under Indeterminacy. Springer: *Journal of Metrology Society of India* (2021); DOI: 10.1007/s12647-020-00428-8.

43. Muhammad Aslam, Gadde Srinivasa Rao, Nasrullah Khan, Liaquat Ahmad: Two-stage sampling plan using process loss index under neutrosophic statistics. Taylor&Francis: *Communications in Statistics - Theory and Methods* (2020); DOI: 10.1080/03610918.2019.1702212.
44. Ali Hussein Al-Marshadi, Ambreen Shafqat, Muhammad Aslam, Abdullah Alharbey: Performance of a New Time-Truncated Control Chart for Weibull Distribution Under Uncertainty. Atlantis Press: *International Journal of Computational Intelligence Systems*, Volume 14, Issue 1, 2021, 1256 - 1262; DOI: 10.2991/ijcis.d.210331.001.
45. Muhammad Aslam: Testing average wind speed using sampling plan for Weibull distribution under indeterminacy. Nature: *Scientific Reports*, 11, Article number: 7532 (2021); DOI: 10.1038/s41598-021-87136-8.
46. Muhammad Aslam, G. Srinivasa Rao, Nasrullah Khan: Single-stage and two-stage total failure-based group-sampling plans for the Weibull distribution under neutrosophic statistics. Springer: *Complex & Intelligent Systems*, 7, 891–900 (2021); DOI: 10.1007/s40747-020-00253-1.
47. Muhammad Aslam, G. Srinivasa Rao, Ambreen Shafqat, Liaquat Ahmad, Rehan Ahmad Khan Sherwani: Monitoring circuit boards products in the presence of indeterminacy. Elsevier: *Measurement*, Volume 168, 15 January 2021, 108404; DOI: 10.1016/j.measurement.2020.108404.
48. Mohammed Albassam, Nasrullah Khan, Muhammad Aslam: Neutrosophic D'Agostino Test of Normality: An Application to Water Data. Hindawi: *Journal of Mathematics - Theory, Algorithms, and Applications within Neutrosophic Modelling and Optimisation*, 2021, Article ID 5582102, 5 pages; DOI: 10.1155/2021/5582102.
49. Mohammed Albassam: Radar data analysis in the presence of uncertainty. Taylor&Francis: *European Journal of Remote Sensing*, 54:1, 140-144, 2021; DOI: 10.1080/22797254.2021.1886597.
50. Muhammad Aslam: A new goodness of fit test in the presence of uncertain parameters. Springer: *Complex & Intelligent Systems*, 7, 359–365, 2021; DOI: 10.1007/s40747-020-00214-8.
51. Abdullah M. Almarashi, Muhammad Aslam: Process Monitoring for Gamma Distributed Product under Neutrosophic Statistics Using Resampling Scheme. Hindawi: *Journal of Mathematics: Soft Computing Algorithms Based on Fuzzy Extensions*, Volume 2021, Article ID 6635846, 12 pages; DOI: 10.1155/2021/6635846.
52. Muhammad Aslam: A study on skewness and kurtosis estimators of wind speed distribution under indeterminacy. Springer: *Theoretical and Applied Climatology*, 143, 1227–1234, 2021; DOI: 10.1007/s00704-020-03509-5.

53. Muhammad Aslam, Ali Algarni: Analyzing the Solar Energy Data Using a New Anderson-Darling Test under Indeterminacy. Hindawi: *International Journal of Photoenergy*, Volume 2020, Article ID 6662389, 6 pages; DOI: 10.1155/2020/6662389.
54. Muhammad Aslam: Forecasting of the wind speed under uncertainty. Nature: *Scientific Reports*, Volume 10, Article number: 20300 (2020); DOI: 10.1038/s41598-020-77280-y.
55. Azhar Ali Janjua, Muhammad Aslam, Naheed Sultana: Evaluating the relationship between climate variability and agricultural crops under indeterminacy. Springer: *Theoretical and Applied Climatology*, Volume 142, pages 1641–1648 (2020); DOI: 10.1007/s00704-020-03398-8.
56. Rehan Ahmad Khan Sherwan, Mishal Naeem, Muhammad Aslam, Muhammad Ali Raza, Muhammad Abid, Shumaila Abbas: Neutrosophic Beta Distribution with Properties and Applications. University of New Mexico: *Neutrosophic Sets and Systems*, Vol. 41, 209-214, 2021; DOI: 10.5281/zenodo.4625715.
57. Muhammad Aslam, Ambreen Shafqat, Mohammed Albassam, Jean-Claude Malela-Majika, Sandile C. Shongwe: A new CUSUM control chart under uncertainty with applications in petroleum and meteorology. PLoS ONE 16(2): e0246185, 2021; DOI: 10.1371/journal.pone.0246185.
58. Muhammad Aslam: Monitoring the road traffic crashes using NEWMA chart and repetitive sampling. Taylor&Francis: *International Journal of Injury Control and Safety Promotion*, Volume 28, 2021 - Issue 1, 39-45; DOI: 10.1080/17457300.2020.1835990.
59. Muhammad Aslam: Analysing Gray Cast Iron Data using a New Shapiro-Wilks test for Normality under Indeterminacy. Taylor&Francis: *International Journal of Cast Metals Research*, Volume 34, 2021 - Issue 1, 1-5; DOI: 10.1080/13640461.2020.1846959.
60. Ishmal Shahzadi, Muhammad Aslam, Hussain Aslam: Neutrosophic Statistical Analysis of Income of YouTube Channels. University of New Mexico: *Neutrosophic Sets and Systems*, Vol. 39, 101-106, 2020.
61. Nasrullah Khan, Muhammad Aslam, P. Jeyadurga, S. Balamurali: Monitoring of production of blood components by attribute control chart under indeterminacy. Nature: *Scientific Reports*, volume 11, Article number: 922 (2021); DOI: 10.1038/s41598-020-79851-5.
62. Muhammad Aslam, Rashad A.R. Bantan: A study on measurement system analysis in the presence of indeterminacy. Elsevier: *Measurement*, Volume 166, December 2020, 108201; DOI: 10.1016/j.measurement.2020.108201.
63. Muhammad Aslam, Rashad A. R. Bantan, Nasrullah Khan: Design of NEWMA np control chart for monitoring neutrosophic nonconforming items. Springer:

- Soft Computing*, Volume 24, 16617–16626 (2020); DOI: 10.1007/s00500-020-04964-y.
64. M. Albassam, Muhammad Aslam: Monitoring Non-Conforming Products Using Multiple Dependent State Sampling Under Indeterminacy-An Application to Juice Industry. IEEE Access, vol. 8, pp. 172379-172386, 2020; DOI: 10.1109/ACCESS.2020.3024569.
 65. Ahmed Ibrahim Shawky , Muhammad Aslam, Khushnoor Khan: Multiple Dependent State Sampling-Based Chart Using Belief Statistic under Neutrosophic Statistics. Hindawi: *Journal of Mathematics*, Volume 2020, Article ID 7680286, 14 pages; DOI: 10.1155/2020/7680286.
 66. Muhammad Aslam: Introducing Grubbs's test for detecting outliers under neutrosophic statistics - An application to medical datas. Science Direct: *Journal of King Saud University - Science*, Volume 32, Issue 6, September 2020, 2696-2700; DOI: 10.1016/j.jksus.2020.06.003.
 67. Muhammad Aslam: A New Sampling Plan Using Neutrosophic Process Loss Consideration. MDPI: *Symmetry*, 2018, 10 (5), 132; DOI: 10.3390/sym10050132.
 68. Muhammad Aslam, Osama H. Arif: Testing of Grouped Product for the Weibull Distribution Using Neutrosophic Statistics. MDPI: *Symmetry*, 2018, 10 (9), 403; DOI: 10.3390/sym10090403.
 69. Muhammad Aslam, Nasrullah Khan, Muhammad Zahir Khan: Monitoring the Variability in the Process Using Neutrosophic Statistical Interval Method. MDPI: *Symmetry*, 2018, 10 (11), 562; DOI: 10.3390/sym10110562.
 70. Muhammad Zahir Khan, Muhammad Farid Khan, Muhammad Aslam, Abdur Razzaque Mughal: Design of Fuzzy Sampling Plan Using the Birnbaum-Saunders Distribution. MDPI: *Mathematics*, 2019, 7 (1), 9; DOI: 10.3390/math7010009.
 71. Muhammad Aslam, Ali Hussein Al-Marshadi: Design of Sampling Plan Using Regression Estimator under Indeterminacy. MDPI: *Symmetry*, 2018, 10 (12), 754; DOI: 10.3390/sym10120754.
 72. Muhammad Zahir Khan, Muhammad Farid Khan, Muhammad Aslam, Seyed Taghi Akhavan Niaki, Abdur Razzaque Mughal: A Fuzzy EWMA Attribute Control Chart to Monitor Process Mean. MDPI: *Information*, 2018, 9 (12), 312; DOI: 10.3390/info9120312.
 73. Muhammad Aslam, Nasrullah Khan, Mohammed Albassam: Control Chart for Failure-Censored Reliability Tests under Uncertainty Environment. MDPI: *Symmetry*, 2018, 10 (12), 690; DOI: 10.3390/sym10120690.
 74. Muhammad Aslam, Mohammed Albassam: Application of Neutrosophic Logic to Evaluate Correlation between Prostate Cancer Mortality and Dietary Fat Assumption. MDPI: *Symmetry*, 2019, 11 (3), 330; DOI: 10.3390/sym11030330.

75. Muhammad Aslam, Mansour Sattam Aldosari: Inspection Strategy under Indeterminacy Based on Neutrosophic Coefficient of Variation. MDPI: *Symmetry*, 2019, 11 (2), 193; DOI: 10.3390/sym11020193.
76. Muhammad Aslam: A Variable Acceptance Sampling Plan under Neutrosophic Statistical Interval Method. MDPI: *Symmetry*, 2019, 11 (1), 114; DOI: 10.3390/sym11010114.
77. Muhammad Aslam, Nasrullah Khan, Ali Hussein Al-Marshadi: Design of Variable Sampling Plan for Pareto Distribution Using Neutrosophic Statistical Interval Method. MDPI: *Symmetry*, 2019, 11 (1), 80; DOI: 10.3390/sym11010080.
78. Muhammad Aslam, Rashad A. R. Bantan, Nasrullah Khan: Design of S₂N—NEWMA Control Chart for Monitoring Process having Indeterminate Production Data. MDPI: *Processes*, 2019, 7 (10), 742; DOI: 10.3390/pr7100742.
79. Muhammad Aslam, Ali Hussein Al-Marshadi, Nasrullah Khan: A New X-Bar Control Chart for Using Neutrosophic Exponentially Weighted Moving Average. MDPI: *Mathematics*, 2019, 7 (10), 957; DOI: 10.3390/math7100957.
80. Muhammad Aslam, P. Jeyadurga, Saminathan Balamurali, Ali Hussein Al-Marshadi: Time-Truncated Group Plan under a Weibull Distribution based on Neutrosophic Statistics. MDPI: *Mathematics*, 2019, 7 (10), 905; DOI: 10.3390/math710090557.
81. Muhammad Aslam, Osama Hasan Arif: Classification of the State of Manufacturing Process under Indeterminacy. MDPI: *Mathematics*, 2019, 7 (9), 870; DOI: 10.3390/math7090870.
82. Muhammad Aslam, Mohammed Albassam: Inspection Plan Based on the Process Capability Index Using the Neutrosophic Statistical Method. MDPI: *Mathematics*, 2019, 7 (7), 631; DOI: 10.3390/math7070631.
83. Muhammad Aslam, Rashad A. R. Bantan, Nasrullah Khan: Monitoring the Process Based on Belief Statistic for Neutrosophic Gamma Distributed Product. MDPI: *Processes*, 2019, 7 (4), 209; DOI: 10.3390/pr7040209.
84. Muhammad Aslam: Product Acceptance Determination with Measurement Error Using the Neutrosophic Statistics. Hindawi: *Advances in Fuzzy Systems*, Volume 2019, Article ID 8953051, 8 pages; DOI: 10.1155/2019/8953051.
85. Muhammad Aslam, Rashad A. R. Bantan, Nasrullah Khan: Design of a New Attribute Control Chart Under Neutrosophic Statistics. Springer: *International Journal of Fuzzy Systems*, Volume 21, 433–440 (2019); DOI: 10.1007/s40815-018-0577-1.
86. Muhammad Aslam, Osama H. Arif: Test of Association in the Presence of Complex Environment. Hindawi: *Complexity*, Volume 2020, Article ID 2935435, 6 pages; DOI: 10.1155/2020/2935435.

87. Mohammed Albassam, Nasrullah Khan, Muhammad Aslam: The W/S Test for Data Having Neutrosophic Numbers: An Application to USA Village Population. Hindawi: *Complexity*, Volume 2020, Article ID 3690879, 8 pages; DOI: 10.1155/2020/3690879.
88. Muhammad Aslam, Osama H. Arif, Rehan Ahmad Khan Sherwani: New Diagnosis Test under the Neutrosophic Statistics: An Application to Diabetic Patients. Hindawi: *BioMed Research International*, Volume 2020, Article ID 2086185, 7 pages; DOI: 10.1155/2020/2086185.
88. Muhammad Aslam, Ali Hussein Al-Marshadi: Design of a Control Chart Based on COM-Poisson Distribution for the Uncertainty Environment. Hindawi: *Complexity*, Volume 2019, Article ID 8178067, 7 pages; DOI: 10.1155/2019/8178067.
89. Muhammad Aslam, Osama H. Arif: Multivariate Analysis under Indeterminacy: An Application to Chemical Content Data. Hindawi: *Journal of Analytical Methods in Chemistry*, Volume 2020, Article ID 1406028, 6 pages; DOI: 10.1155/2020/1406028.
90. Muhammad Aslam, Abdulmohsen Al-Shareef, Khushnoor Khan: Monitoring the temperature through moving average control under uncertainty environment. Nature: *Scientific Reports*, Volume 10, Article number: 12182 (2020); DOI: 10.1038/s41598-020-69192-8.
91. Muhammad Aslam: Design of Sampling Plan for Exponential Distribution Under Neutrosophic Statistical Interval Method. IEEE Access, vol. 6, pp. 64153-64158, 2018; DOI: 10.1109/ACCESS.2018.2877923.
92. Muhammad Aslam: Control Chart for Variance Using Repetitive Sampling Under Neutrosophic Statistical Interval System. IEEE Access, vol. 7, pp. 25253-25262, 2019; DOI: 10.1109/ACCESS.2019.2899020.
93. Muhammad Aslam, M. Azam, M. Albassam: Sampling Plan Using Process Loss Index Using Multiple Dependent State Sampling Under Neutrosophic Statistics. IEEE Access, vol. 7, pp. 38568-38576, 2019; DOI: 10.1109/ACCESS.2019.2906408.
94. Naeem Jan, Muhammad Aslam, Kifayat Ullah, Tahir Mahmood, Jun Wang: An approach towards decision making and shortest path problems using the concepts of interval-valued Pythagorean fuzzy information. Wiley: *International Journal of Intelligent Systems*, Volume 34, Issue 10, October 2019, 2403-2428; DOI: 10.1002/int.22154.
95. Muhammad Aslam: Attribute Control Chart Using the Repetitive Sampling Under Neutrosophic System. IEEE Access, vol. 7, 2019, 2163-3536; DOI: 10.1109/ACCESS.2019.2895162.

96. Muhammad Aslam, R. A. R. Bantan, N. Khan: Design of a Control Chart for Gamma Distributed Variables Under the Indeterminate Environment. IEEE Access, vol. 7, pp. 8858-8864, 2019; DOI: 10.1109/ACCESS.2019.2891005.
97. Muhammad Aslam, Muhammad Ali Raza: Design of New Sampling Plans for Multiple Manufacturing Lines Under Uncertainty. Springer: *International Journal of Fuzzy Systems*, volume 21, 978–992 (2019); DOI: 10.1007/s40815-018-0560-x.
98. Muhammad Aslam: A New Failure-Censored Reliability Test Using Neutrosophic Statistical Interval Method. Springer: *International Journal of Fuzzy Systems*, volume 21, 1214–1220 (2019); DOI: 10.1007/s40815-018-0588-y.
99. Muhammad Aslam: Neutrosophic analysis of variance: application to university students. Springer: *Complex & Intelligent Systems*, volume 5, 403–407 (2019); DOI: 10.1007/s40815-018-0588-y.
100. Muhammad Aslam, Mohammed Albassam: Presenting post hoc multiple comparison tests under neutrosophic statistics. Elsevier: *Journal of King Saud University - Science*, Volume 32, Issue 6, September 2020, 2728-2732; DOI: 10.1016/j.jksus.2020.06.008.
101. Muhammad Aslam, Mansour Sattam Aldosari: Analyzing alloy melting points data using a new Mann-Whitney test under indeterminacy. Elsevier: *Journal of King Saud University - Science*, Volume 32, Issue 6, September 2020, 2831-2834; DOI: 10.1016/j.jksus.2020.07.005.
102. Muhammad Aslam: On detecting outliers in complex data using Dixon's test under neutrosophic statistics. Elsevier: *Journal of King Saud University - Science*, Volume 32, Issue 3, April 2020, 2005-2008; DOI: 10.1016/j.jksus.2020.02.003.
103. Muhammad Aslam: A new attribute sampling plan using neutrosophic statistical interval method. Springer: *Complex & Intelligent Systems*, 5, 365–370 (2019); DOI: 10.1007/s40747-018-0088-6.
104. Muhammad Aslam, Saminathan Balamurali, Jeyadurga Periyasampandian, Ali Hussein Al-Marshadi: Plan for Food Inspection for Inflated-Pareto Data Under Uncertainty Environment. IEEE Access, vol. 7, 164186-164193, 2019; DOI: 10.1109/ACCESS.2019.2951019.
105. Muhammad Aslam, R. A. R. Bantan, N. Khan: Design of X-Bar Control Chart Using Multiple Dependent State Sampling Under Indeterminacy Environment. IEEE Access, vol. 7, pp. 152233-152242, 2019; DOI: 10.1109/ACCESS.2019.2947598.
106. Muhammad Aslam: Introducing Kolmogorov-Smirnov Tests under Uncertainty: An Application to Radioactive Data. American Chemical Society: ACS Omega 2020, 5, 1, 914-917; DOI: 10.1021/acsomega.9b03940.
107. Muhammad Aslam: Design of the Bartlett and Hartley tests for homogeneity of variances under indeterminacy environment. Taylor&Francis: *Journal of Taibah*

University for Science, Volume 14, 2020, Issue 1; DOI: 10.1080/16583655.2019.1700675.

108. Muhammad Aslam, Muhammad Ali Raza, Liaquat Ahmad: Acceptance sampling plans for two-stage process for multiple manufacturing lines under neutrosophic statistics. IOS Press: *Journal of Intelligent & Fuzzy Systems*, vol. 37, no. 6, pp. 7839-7850, 2019; DOI: 10.3233/JIFS-182849.
109. Muhammad Kashif, Hafiza Nida, Muhammad Imran Khan, Muhammad Aslam: Decomposition of Matrix under Neutrosophic Environment. University of New Mexico: *Neutrosophic Sets and Systems*, vol. 30, 143-148, 2019.
110. Muhammad Aslam, Nasrullah Khan: A new variable control chart using neutrosophic interval method-an application to automobile industry. University of New Mexico: *Journal of Intelligent & Fuzzy Systems*, vol. 36, no. 3, pp. 2615-2623, 2019; DOI: 10.3233/JIFS-181767.

SEMINARS ON NEUTROSOPHIC STATISTICS

- S1. *History of Neutrosophic Set, Logic, Probability and Statistics and their Applications*, Mathematics and Statistics Departments, King Abdulaziz University, Jeddah, Saudi Arabia, 19 December 2019.
- S2. *Neutrosophic Set and Logic / Interval Neutrosophic Set and Logic / Neutrosophic Probability and Neutrosophic Statistics / Neutrosophic Precalculus and Calculus / Symbolic Neutrosophic Theory / Open Challenges of Neutrosophic Set*, lecture series, by F. Smarandache, Nguyen Tat Thanh University, Ho Chi Minh City, Vietnam, 31st May - 3th June 2016.
- S3. *Neutrosophic Set and Logic / Interval Neutrosophic Set and Logic / Neutrosophic Probability and Neutrosophic Statistics / Neutrosophic Precalculus and Calculus / Symbolic Neutrosophic Theory / Open Challenges of Neutrosophic Set*, by F. Smarandache, Ho Chi Minh City University of Technology (HUTECH), Ho Chi Minh City, Vietnam, 30th May 2016.
- S4. *Neutrosophic Set and Logic / Interval Neutrosophic Set and Logic / Neutrosophic Probability and Neutrosophic Statistics / Neutrosophic Precalculus and Calculus / Symbolic Neutrosophic Theory / Open Challenges of Neutrosophic Set*, lecture series, by F. Smarandache, Vietnam national University, Vietnam Institute for Advanced Study in Mathematics, Hanoi, Vietnam, lecture series, 14th May – 26th May 2016.
- S5. *Foundations of Neutrosophic Logic, Set, Probability and Statistics and their Applications in Science. n-Valued Refined Neutrosophic Set, Logic, Probability and Statistics*, by F. Smarandache, Universidad Complutense de Madrid, Facultad de Ciencia Matematicas, Departamento de Geometria y Topologia, Instituto Matematico Interdisciplinar (IMI), Madrid, Spain, 9th July 2014.

DECISION MAKING

MASS - Modified Assignment Algorithm in Facilities Layout Planning

S. Bhattacharya, Florentin Smarandache, M. Khoshnevisan

S. Bhattacharya, Florentin Smarandache, M. Khoshnevisan (2005). MASS - Modified Assignment Algorithm in Facilities Layout Planning. *International Journal of Tomography & Statistics* 3, JJ05, 19-29

ABSTRACT

In this paper we have proposed a semi-heuristic optimization algorithm for designing optimal plant layouts in process-focused manufacturing/service facilities. Our proposed algorithm marries the well-known CRAFT (Computerized Relative Allocation of Facilities Technique) with the Hungarian assignment algorithm. Being a semi-heuristic search, MASS can be potentially more efficient in terms of CPU engagement time as it can converge on the global optimum faster than the traditional CRAFT, which is a pure heuristic. We also present a numerical illustration of our proposed algorithm.

KEY WORDS

CRAFT, facilities layout planning, Hungarian assignment algorithm.

INTRODUCTION

The fundamental integration phase in the design of productive systems is the layout of production facilities. A working definition of layout may be given as the arrangement of machinery and flow of materials from one facility to another, which minimizes material-handling costs while considering any physical restrictions on such arrangement.

Usually this layout design is based either on considerations of machine-time cost and product availability; thus making the production system *product-focused*, or on considerations of quality and flexibility; thereby making the system *process-focused*. It is natural that while *product-focused* systems are better off with a 'line layout' dictated by available technologies and prevailing job designs, *process-focused* systems, which are more concerned with job organization, opt for a 'functional layout'. Of course, in reality the actual facility layout often lies somewhere in between a pure line layout and a pure functional layout format; governed by the specific demands of a particular production plant. Since our present paper concerns only functional layout design for process-focused systems, this is the only layout design we will discuss here.

The main goal to keep in mind is to minimize material handling costs - therefore the departments that incur the most interdepartmental movement should be located closest to one another. The main type of design layouts is *Block diagramming*, which refers to the movement of materials in existing or proposed facility. This information is usually provided with a *from/to* chart or a *load summary* chart, which gives the average number of unit loads moved between departments. A load-unit can be a single unit, a pallet of material, a bin of material, or a crate of material. The next step is to design the layout by calculating the composite movements between departments and rank them from most movement to least movement. Composite movement refers to the back-and-forth movement between each pair of departments. Finally, trial layouts are placed on a grid that graphically represents the relative distances between departments. This grid then becomes the objective of optimization when determining the optimal plant layout. We give a schematic representation of the basic operational considerations in a *process-focused* system as follows:

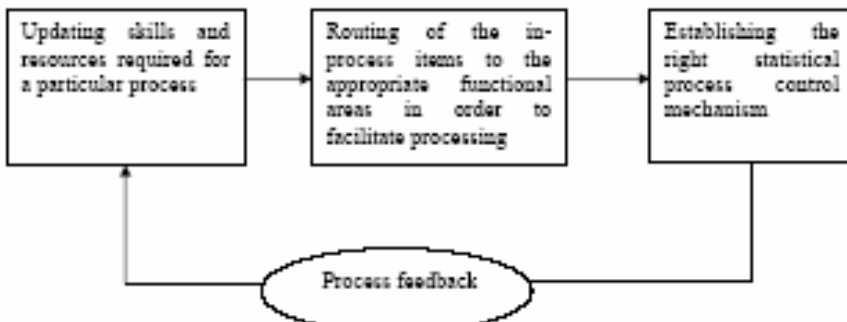

Figure 1

In designing the optimal functional layout, the fundamental question to be addressed is that of 'relative location of facilities'. The locations will depend on the need for one pair of facilities to be adjacent (or physically close) to each other relative to the need for all other pairs of facilities to be similarly adjacent (or physically close) to each other. Locations must be allocated based on the relative gains and losses for the alternatives and seek to minimize some indicative measure of the cost of having non-adjacent locations of facilities. Constraints of space prevents us from going into the details of the several criteria used to determine the gains or losses from the relative location of facilities and the available sequence analysis techniques for addressing the question; for which we advise the interested reader to look up *any* standard handbook of production/operations management.

COMPUTERIZED RELATIVE ALLOCATION OF FACILITIES TECHNIQUE

Computerized Relative Allocation of Facilities Technique (CRAFT) (Buffa, Armour and Vollman, 1964) is a computerized heuristic algorithm that takes in *load matrix* of interdepartmental flow and transaction costs with a representation of a block layout as the inputs. The block layout could either be an existing layout or; for a new facility, any arbitrary initial layout. The algorithm then computes the departmental locations and returns an estimate of the total interaction costs for the initial layout. The governing algorithm is designed to compute the impact on a cost measure for two-way or three-way swapping in the location of the facilities. For each swap, the various interaction costs are computed afresh and the load matrix and the change in cost (increase or decrease) is noted and stored in the RAM. The algorithm proceeds this way through all possible combinations of swaps accommodated by the software. The basic procedure is repeated a number of times resulting in a more efficient block layout every time till such time when no further cost reduction is possible. The final block layout is then printed out to serve as the basis for a detailed layout template of the facilities at a later stage. Since its formulation, more powerful versions of CRAFT have been developed but these too follow the same, basic heuristic routine and therefore tend to be highly CPU-intensive (Khalil, 1973; Hicks and Cowan, 1976).

The basic computational disadvantage of a CRAFT-type technique is that one always has got to start with an arbitrary initial solution (Carrie, 1980). This means that there is no mathematical certainty of attaining the desired optimal solution after a given number of iterations. If the starting solution is quite close to the optimal solution by chance, then the final solution is attained only after a few iterations. However, as there is no guarantee that the starting solution will be close to the global optimum, the expected number of iterations required to arrive at the final solution tend to be quite large thereby straining computing resources (Driscoll and Sangi, 1988).

In this paper we propose and illustrate the Modified Assignment (MASS) algorithm as an extension to the traditional CRAFT, to enable faster convergence to the optimal solution. This we propose to do by marrying CRAFT technique with the

Hungarian assignment algorithm. As our proposed algorithm is semi-heuristic, it is likely to be less CPU-intensive than any traditional, purely heuristic CRAFT-type algorithm.

THE HUNGARIAN ASSIGNMENT ALGORITHM

A general assignment problem may be framed as a special case of the *balanced transportation problem* with availability and demand constraints summing up to unity. Mathematically, it has the following *general linear programming* form:

$$\begin{aligned} & \text{Minimize } \sum \sum C_{ij} X_{ij} \\ & \text{Subject to } \sum X_{ij} = 1, \text{ for each } i, j = 1, 2 \dots n \end{aligned}$$

In terms of the classical assignment problem, C_{ij} is the cost of assigning the i^{th} job to the j^{th} individual and X_{ij} is the number of assignments of the i^{th} job to the j^{th} individual. In words, the problem may be stated as assigning each of n individuals to n jobs so that exactly one individual is assigned to each job in such a way as to minimize the total cost.

To ensure satisfaction of the basic requirements of the assignment problem, the basic feasible solutions of the corresponding balanced transportation problem must be integer valued. However, any such basic feasible solution will contain $(2n - 1)$ variables out of which $(n - 1)$ variables will be zero thereby introducing a high level of degeneracy in the solution making the usual solution technique of a transportation problem very inefficient.

This has resulted in mathematicians devising an alternative, more efficient algorithm for solving this class of problems, which has come to be commonly known as the *Hungarian assignment algorithm*. This algorithm is based on the following *optimality* theorem:

Theorem: *If a constant number is added to any row and/or column of the cost matrix of an assignment-type problem, then the resulting assignment-type problem has exactly the same set of optimal solutions as the original problem and vice versa.*

Proof: Let A_i and B_j ($i, j = 1, 2 \dots n$) be added to the i th row and/or j th column respectively of the cost matrix. Then the revised cost elements are $C_{ij} = C_{ij} + A_i + B_j$. The revised cost of assignment is $\sum \sum C_{ij}^* X_{ij} = \sum \sum (C_{ij} + A_i + B_j) X_{ij} = \sum \sum C_{ij} X_{ij} + \sum A_i \sum X_{ij} + \sum B_j \sum X_{ij}$. But by the imposed assignment constraint $\sum X_{ij} = 1$ (for $i, j = 1, 2 \dots n$), we have the revised cost as $\sum \sum C_{ij} X_{ij} + \sum A_i + \sum B_j$ i.e. the cost differs from the original by a constant. As the revised costs differ from the originals by a constant, which is independent of the decision variables, an optimal solution to one is also optimal solution to the other and vice versa.

The optimality theorem can be used in two different ways to solve the assignment problem. First, if in an assignment problem, some cost elements are negative, the problem may be converted into an equivalent assignment problem by adding a positive constant to each of the entries in the cost matrix so that they all become non-negative. Next, the important thing to look for is a feasible solution that has zero assignment cost after adding suitable constants to the rows and columns. Since it has been assumed that all entries are now non-negative, this assignment must be the globally optimal one (Mustafi, 1996).

Given a zero assignment, a straight line is drawn through it (a horizontal line in case of a row and a vertical line in case of a column), which prevents any other assignment in that particular row/column. The governing algorithm then seeks to find the minimum number of such straight lines, which would cover all the zero entries to avoid any redundancy. Let us say that k such lines are required to cover all the zeroes. Then the *necessary condition* for optimality is that number of zeroes assigned is equal to k and the *sufficient condition* for optimality is that k is equal to n for an $n \times n$ cost matrix.

MASS (MODIFIED ASSIGNMENT) ALGORITHM

The basic idea of our proposed algorithm is to develop a systematic scheme to arrive at the initial input block layout to be fed into the CRAFT program so that the program does not have to start off from any initial (and possibly inefficient) solution. Thus, by subjecting the problem of finding an initial block layout to a mathematical scheme, we in effect reduce the purely heuristic algorithm of CRAFT to a semi-heuristic one. Our proposed MASS algorithm follows the following *sequential* steps:

Step 1: We formulate the load matrix such that each entry l_{ij} represents the load carried from facility i to facility j .

Step 2: We insert $l_{ij} = M$, where M is a large positive number, into all the vacant cells of the load matrix signifying that no inter-facility load transportation is required or possible between the i^{th} and j^{th} vacant cells.

Step 3: We solve the problem on the lines of a standard assignment problem using the Hungarian assignment algorithm treating the load matrix as the cost matrix.

Step 4: We draft the initial block layout trying to keep the inter-facility distance d_{ij}^* between the i^{th} and j^{th} assigned facilities to the minimum possible magnitude, subject to the available floor area and architectural design of the shop floor.

Step 5: We proceed using the CRAFT program to arrive at the optimal layout by iteratively improving upon the starting solution provided by the Hungarian assignment algorithm till the overall load function $L = \sum \sum l_{ij} d_{ij}^*$ subject to any

particular bounds imposed on the problem.

The Hungarian assignment algorithm will ensure that the initial block layout is at least very close to the global optimum if not globally optimal itself. Therefore the subsequent CRAFT procedure will converge on the global optimum much faster starting from this near-optimal initial input block layout and will be much less CPU-intensive than any traditional CRAFT-type algorithm. Thus MASS is not a stand-alone optimization tool but rather a rider on the traditional CRAFT that tries to ensure faster convergence to the optimal block layout for process-focused systems, by making the search semi-heuristic.

That MASS will be an improvement over traditional CRAFT in terms of computational efficiency is rather intuitive. At its worst the computational efficiency of MASS will be same as that of traditional CRAFT (in the rather unlikely scenario that the CRAFT heuristic chances upon the best possible layout in its very first iteration). In all other scenarios, MASS will give an initial solution to CRAFT which is much more likely to be closer to the global optimal than any random initial solution as under traditional CRAFT.

We provide a numerical illustration of the MASS algorithm in the Appendix by designing the optimal block layout of a small, single-storied, process-focused manufacturing plant with six different facilities and a rectangular shop floor design. The model can however be extended to cover bigger plants with a higher number of facilities. Also the MASS approach we have advocated here can even be extended to deal with the multi-floor version of CRAFT (Johnson, 1982) by constructing a separate assignment table for each floor subject to any predecessor-successor relationship among the facilities.

.....

APPENDIX: NUMERICAL ILLUSTRATION OF MASS

We consider a small, single-storied process-focused manufacturing plant with a rectangular shop floor plan having six different facilities. We mark these facilities as F_I , F_{II} , F_{III} , F_{IV} , F_V and F_{VI} . The architectural design requires that there be an aisle of at least 2 meters width between two adjacent facilities and the total floor area of the plant is 64meters x 22meters. Based on the different types of jobs processed, the loads to be transported between the different facilities are supplied in the load matrix below:

TABLE 1

	F_I	F_{II}	F_{III}	F_{IV}	F_V	F_{VI}
F_I	-	20	-	-	-	25
F_{II}	10	-	15	-	-	-
F_{III}	-	-	-	30	-	-
F_{IV}	-	-	50	-	-	40
F_V	-	-	-	-	-	10
F_{VI}	-	-	-	-	15	-

We put in a very large positive value M in each of the vacant cells of the load matrix to signify that no inter-facility transfer of load is required or is permissible for these cells:

TABLE 2

	F_I	F_{II}	F_{III}	F_{IV}	F_V	F_{VI}
F_I	M	20	M	M	M	25
F_{II}	10	M	15	M	M	M
F_{III}	M	M	M	30	M	M
F_{IV}	M	M	50	M	M	40
F_V	M	M	M	M	M	10
F_{VI}	M	M	M	M	15	M

Next we apply the standard Hungarian assignment algorithm to obtain the initial solution:

TABLE 3

	F_I	F_{II}	F_{III}	F_{IV}	F_V	F_{VI}
F_I	M-20	0	M-25	M-20	M-20	5
F_{II}	0	M-10	0	M-10	M-10	M-10
F_{III}	M-30	M-30	M-35	0	M-30	M-30
F_{IV}	M-40	M-40	5	M-40	M-40	0
F_V	M-10	M-10	M-15	M-10	M-10	0
F_{VI}	M-15	M-15	M-20	M-15	0	M-15

Above is the assignment table after first iteration. There are two rows and three columns that are covered i.e. $k = 5$. But as this is a 6x6 load matrix, the above solution is sub-optimal. So we make a second iteration:

TABLE 4

	F_I	F_{II}	F_{III}	F_{IV}	F_V	F_{VI}
F_I	M-20	0	M-25	M-15	M-15	10
F_{II}	0	M-10	0	M-5	M-5	M-5
F_{III}	M-35	M-35	M-40	0	M-30	M-30
F_{IV}	M-45	M-45	0	M-40	M-40	0
F_V	M-15	M-15	M-20	M-10	M-10	0
F_{VI}	M-20	M-20	M-25	M-15	0	M-15

Now columns $F_I, F_{III}, F_{IV}, F_{VI}$ and rows F_I and F_{VI} are covered i.e. $k = 6$. As this is a 6x6 load matrix the above solution is optimal.

The optimal assignment table (subject to the 2 meters of aisle between adjacent facilities) is shown below:

TABLE 6

	F_I	F_{II}	F_{III}	F_{IV}	F_V	F_{VI}
F_I	-	*	-	-	-	-
F_{II}	*	-	-	-	-	-
F_{III}	-	-	-	*	-	-
F_{IV}	-	-	*	-	-	-
F_V	-	-	-	-	-	*
F_{VI}	-	-	-	-	*	-

Initial layout of facilities as dictated by the Hungarian assignment algorithm:

Figure 2

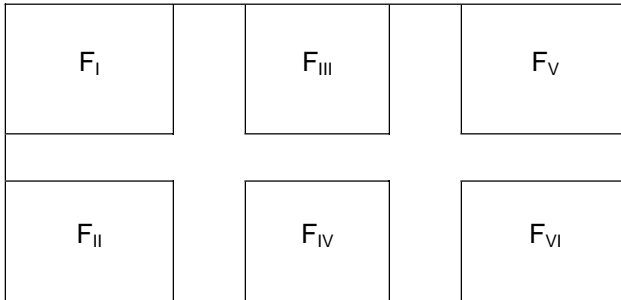

The above layout conforms to the rectangular floor plan of the plant and also places the assigned facilities adjacent to each other with an aisle of 2 meters width between them. Thus F_I is adjacent to F_{II} , F_{III} is adjacent to F_{IV} and F_V is adjacent to F_{VI} .

Based on the cost information provided in the load-matrix the total cost in terms of load-units for the above layout can be calculated as follows:

$$L = 2\{(20 + 10) + (50 + 30) + (10 + 15)\} + (44 \times 25) + (22 \times 40) + (22 \times 15) = 2580.$$

By feeding the above optimal solution into the CRAFT program the final, the global optimum is found in a single iteration. The final, best layout as obtained by CRAFT is:

Figure 3

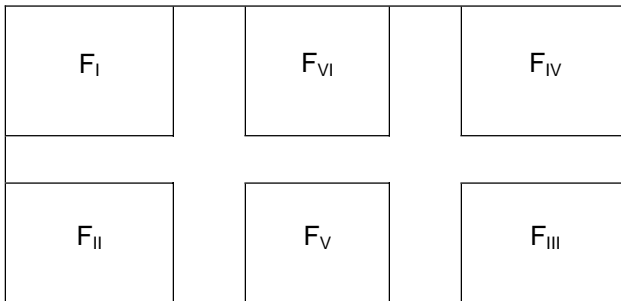

Based on the cost information provided in the load-matrix the total cost in terms of load-units for the optimal layout can be calculated as follows:

$$L^* = 2\{(10 + 20) + (15 + 10) + (5 + 30)\} + (22 \times 25) + (44 \times 15) + (22 \times 40) = 2360.$$

Therefore the final solution is an improvement of just 220 load-units over the initial solution! This shows that this initial solution fed into CRAFT is indeed near optimal and can thus ensure a faster convergence.

REFERENCES

Buffa, Elwood S., Armour G. C. and Vollmann, T. E., 1964, *Allocating Facilities with CRAFT*, Harvard Business Review, 42(2), 136-158

Carrie, A. S., 1980, *Computer-Aided Layout Planning – The Way Ahead*, International Journal of Production Research, 18(3), 283-294

Driscoll, J. and Sangi, N. A., 1988, *An International Survey of Computer-aided Facilities Layout – The Development And Application Of Software*, Proc. of the IXth International Conference on Production Research, Anil Mital (Ed.), Elsevier Science Publishers, N.Y. U.S.A., 315-336

Hicks, P. E. and Cowan, T. E., 1976, *CRAFT-M for Layout Rearrangement*,

Industrial Engineering, 8(5), 30-35

Johnson, R. V., 1982, *SPACECRAFT for Multi-Floor Layout Planning*, Management Science, 28(4), 407-417

Khalil, T. M., 1973, *Facilities Relative Allocation Technique (FRAT)*, International Journal of Production Research, 2(2), 174-183

Mustafi, C. K., 1996, *Operations Research: Methods and Practice*, 3rd Ed., New Age International Ltd., New Delhi, India, 124-131

IN-cross Entropy Based MAGDM Strategy under Interval Neutrosophic Set Environment

Shyamal Dalapati, Surapati Pramanik, Shariful Alam, Florentin Smarandache, Tapan Kumar Roy

Shyamal Dalapati, Surapati Pramanik, Sheriful Alam, Florentin Smarandache, Tapan Kumar Roy (2017). IN-cross Entropy Based MAGDM Strategy under Interval Neutrosophic Set Environment. *Neutrosophic Sets and Systems* 18, 43-57

Abstract. Cross entropy measure is one of the best way to calculate the divergence of any variable from the priori one variable. We define a new cross entropy measure under interval neutrosophic set (INS) environment, which we call IN-cross entropy measure and prove its basic properties. We also develop weighted IN-cross entropy measure and investigats its basic properties. Based on the weighted IN-cross entropy measure, we develop a novel strategy for multi attribute group decision

making (MAGDM) strategy under interval neutrosophic environment. The proposed multi attribute group decision making strategy is compared with the existing cross entropy measure based strategy in the literature under interval neutrosophic set environment. Finally, an illustrative example of multi attribute group decision making problem is solved to show the feasibility, validity and efficiency of the proposed MAGDM strategy.

Keywords: Interval neutrosophic set, IN-cross entropy measure, MAGDM strategy.

1. Introduction

In our daily life we frequently meet with the quantitative measure to take appropriate decision for solving many problems. Entropy measure provides us a quantitative measure of two variables. In 1968, Zadeh [1] introduced fuzzy entropy measure. According to Liu [2], under fuzzy environment, entropy should meet at least three basic following requirements: the entropy of a crisp number is zero; the entropy of an equipossible fuzzy variable is maximum and the entropy is applicable not only to finite and infinite cases but also to discrete and continuous cases. Shang and Jiang [3] proposed a cross entropy measure and symmetric discrimination measure between fuzzy sets. Atanassov [4] introduced intuitionistic fuzzy set (IFS) in 1989, which is the extension of fuzzy set. Some recent applications of IFS are found in [5-11] in the literature. Vlachos and Sergiadis [12] defined cross entropy measure in IFS environment and showed a mathematical connection between the notions of entropy for fuzzy sets and IFSs in terms of fuzziness and intuitionism. In 1998, Smarandache [13] introduced the concept of neutrosophic

set (NS) by introducing truth membership, falsity membership and indeterminacy membership functions as independent components and their sum lies $(-0, 3^+)$. Thereafter, Wang et al. [14] introduced single valued neutrosophic set (SVNS) as a subclass of NS. Thereafter, many researchers paid attention to apply NS and SVNS in many field of research such as conflict resolution [15], clustering analysis [16, 17], decision making [18-47], educational problem [48, 49], image processing [50, 52], medical diagnosis [53], optimization [54-59], social problem [60, 61]. Ye [62] introduced cross entropy measure in SVNS and applied it to multi criteria decision-making (MCDM) problems. Ye [63] defined an improved cross entropy measure for SVNS to overcome drawbacks in [62]. In 2005, Wang et al. [64] introduced interval neutrosophic set (INS) considering truth membership, indeterminate membership and falsity membership as interval number in $[0, 1]$. Broumi and Smarandache [65] defined correlation coefficient of INS and proved its basic properties. Zhang et al. [66] defined correlation coefficient for

interval neutrosophic number (INN) and applied it to solve MAGDM problems. Zhang et al. [67] presented an outranking approach for INS and applied its MCDM problems. Recently, Yu et al. [68] use VIKOR method to solve MAGDM problem with INN. Ye [69] defined similarity measure in INS environment and applied to solve MCDM problem. Pramanik and Mondal [70] extended the single valued neutrosophic grey relational analysis strategy to interval neutrosophic environment and applied it to multi-attribute decision-making (MADM) problems. Zhao et al. [71] proposed a MADM strategy based on generalized weighted aggregation operator with INS. Zhang et al. [72] proposed a MCDM strategy based on two interval neutrosophic number aggregation operators. Sahin [73] defined two cross entropy measures with INS based on fuzzy cross entropy measure and single valued neutrosophic cross entropy measure and applied for solving MCDM problem. Tian et al. [74] proposed a cross entropy measure with INS and TOPSIS for solving MCDM problems.

Sahin [73], Tian et al. [74] proposed cross entropy measures under the interval-valued neutrosophic set environment, which is suitable for single decision maker only. So multiple decision maker cannot participate in their strategies in [73, 74].

The aforementioned applications of cross entropy [63, 73, 74] can be effective in dealing with neutrosophic MADM problems. However, they also bear some limitations, which are outlined below:

- i. The strategies [63, 73, 74] are capable of solving neutrosophic MADM problems.
- ii. In the strategies [73, 74], interval-valued neutrosophic set are transformed to SVNS by suitable transform operators.
- iii. The strategies [63, 73, 74] have a single decision-making structure, and not enough attention is paid to improving robustness when processing the assessment information.

Research gap:

MAGDM strategy based on cross entropy measure.

This study answers the following research questions:

- i. Is it possible to define a new cross entropy measure under interval-valued neutrosophic set environment that is free from asymmetrical phenomena?
- ii. Is it possible to define a new weighted cross entropy measure under interval-valued neutrosophic set that is free from asymmetrical phenomena?
- iii. Is it possible to develop a new MAGDM strategy based on the proposed cross entropy measure under interval-valued neutrosophic set environment?

Is it possible to develop a new MAGDM strategy based on the proposed weighted cross entropy measure under interval-valued neutrosophic set environment?

Motivation:

The above-mentioned analysis describes the motivation behind proposing a novel IN-cross entropy-based strategy for tackling MAGDM under the interval-valued neutrosophic environment. This study develops a novel IN-cross entropy-based MAGDM strategy that can deal with multiple decision-makers and free from the drawbacks that exist in [63, 72, 73].

The objectives of the paper are:

1. i. To define a new cross entropy measure under interval-valued neutrosophic set environment without using any transformation operator and prove its basic properties,
2. ii. To define a new weighted cross measure and prove its basic properties.
3. iii. To develop a new MAGDM strategy based on weighted cross entropy measure under interval-valued neutrosophic set environment.

To fill the research gap, we propose IN-cross entropy-based MAGDM, which is capable of dealing with multiple decision-makers.

The main contributions of this paper are summarized below:

- i. We define a new IN-cross entropy measure and prove its basic properties. It is straightforward symmetric.
- ii. We define a new weighted IN-cross entropy measure in the single-valued neutrosophic set environment and prove its basic properties. It is straightforward symmetric
- iii. In this paper, we develop a new MAGDM strategy based on weighted IN cross entropy to solve MAGDM problems.
- iv. In this paper, we solve a MAGDM problem based on the proposed MAGDM strategy.

The paper unfolds as follows: In section 2, we describe the basic definitions and operations of SVNS, INS. In section 3, we present the definition of proposed IN-cross entropy measure, weighted IN-cross entropy measure and their basic properties. In section 4, we develop a MAGDM strategy with the proposed weighted IN-cross entropy measure. In section 5, we solve a MAGDM problem to show the feasibility, validity and efficiency of the proposed strategy. In section 6, we present conclusion and future direction of this study.

2. Preliminaries

2.1 Definition: Single valued neutrosophic set (SVNS) [14]

Assume that U be a space of points (objects) with generic elements $u \in U$. A SVNS H in U is characterized by a truth-membership function $T_H(u)$, an indeterminacy-membership function $I_H(u)$, and a falsity-membership function $F_H(u)$, where $T_H(u), I_H(u), F_H(u) \in [0, 1]$ for each point u in U . Therefore, a SVNS A can be expressed as $H = \{u, T_H(u), I_H(u), F_H(u) \mid u \in U\}$, whereas, the sums of $T_H(u), I_H(u)$ and $F_H(u)$ satisfy the condition $0 \leq T_H(u) + I_H(u) + F_H(u) \leq 3$.

2.2 Definition: Interval neutrosophic sets (INSs) [64]

Assume that U be a space of points (objects) with generic elements $u \in U$. An INSs J in U is characterized by a truth-membership measure $T_J(u)$, an indeterminacy-membership measure $I_J(u)$, and a falsity-membership measure $F_J(u)$, where,

$$T_J(u) = [T_J^-(u), T_J^+(u)], I_J(u) = [I_J^-(u), I_J^+(u)],$$

$F_J(u) = [F_J^-(u), F_J^+(u)]$ for each point u in U . Therefore, a

INSs J can be expressed as $J = \{u, [T_J^-(u), T_J^+(u)],$

$[I_J^-(u), I_J^+(u)], [F_J^-(u), F_J^+(u)] \mid u \in U\}$. Where,

$$T_J^-(u), T_J^+(u), I_J^-(u), I_J^+(u), F_J^-(u), F_J^+(u) \subseteq [0, 1].$$

2.3 Definition: Inclusion of two INSs [64]

Let $J_1 = \{u, [T_{J_1}^-(u), T_{J_1}^+(u)], [I_{J_1}^-(u), I_{J_1}^+(u)], [F_{J_1}^-(u), F_{J_1}^+(u)] \mid u \in U\}$ and $J_2 = \{u, [T_{J_2}^-(u), T_{J_2}^+(u)], [I_{J_2}^-(u), I_{J_2}^+(u)], [F_{J_2}^-(u), F_{J_2}^+(u)] \mid u \in U\}$ be any two INSs in U , then $J_1 \subseteq J_2$ iff $T_{J_1}^-(u) \leq T_{J_2}^-(u), T_{J_1}^+(u) \leq T_{J_2}^+(u), I_{J_1}^-(u) \geq I_{J_2}^-(u), I_{J_1}^+(u) \geq I_{J_2}^+(u), F_{J_1}^-(u) \geq F_{J_2}^-(u), F_{J_1}^+(u) \geq F_{J_2}^+(u)$ for all $u \in U$.

2.4 Definition: Complement of an INS [64]

The complement J^c of an INS $J = \{u, [T_J^-(u), T_J^+(u)], [I_J^-(u), I_J^+(u)], [F_J^-(u), F_J^+(u)] \mid u \in U\}$ is defined as follows:

$$J^c = \{u, [1 - T_J^+(u), 1 - T_J^-(u)], [1 - I_J^+(u), 1 - I_J^-(u)], [1 - F_J^+(u), 1 - F_J^-(u)] \mid u \in U\}.$$

2.5 Definition: Equality of two INSs [64]

Let $J_1 = \{u, [T_{J_1}^-(u), T_{J_1}^+(u)], [I_{J_1}^-(u), I_{J_1}^+(u)], [F_{J_1}^-(u), F_{J_1}^+(u)] \mid u \in U\}$ and $J_2 = \{u, [T_{J_2}^-(u), T_{J_2}^+(u)], [I_{J_2}^-(u), I_{J_2}^+(u)], [F_{J_2}^-(u), F_{J_2}^+(u)] \mid u \in U\}$ be any two INSs in U , then $J_1 = J_2$ iff $T_{J_1}^-(u) = T_{J_2}^-(u), T_{J_1}^+(u) = T_{J_2}^+(u), I_{J_1}^-(u) = I_{J_2}^-(u), I_{J_1}^+(u) = I_{J_2}^+(u), F_{J_1}^-(u) = F_{J_2}^-(u), F_{J_1}^+(u) = F_{J_2}^+(u)$ for all $u \in U$.

3. Definition: IN-cross-entropy measure

Let J_1 and J_2 be any two INSs in $U = \{u_1, u_2, u_3, \dots, u_n\}$. Then, the interval neutrosophic cross-entropy measure of J_1 and J_2 is denoted by $CE_{IN}(J_1, J_2)$ and defined as follows:

$$CE_{IN}(J_1, J_2) = \frac{1}{4} \sum_{i=1}^n \left\{ \frac{2|T_{J_1}^-(u_i) - T_{J_2}^-(u_i)|}{\sqrt{1 + |T_{J_1}^-(u_i)|^2} + \sqrt{1 + |T_{J_2}^-(u_i)|^2}} + \frac{2|(1 - T_{J_1}^-(u_i)) - (1 - T_{J_2}^-(u_i))|}{\sqrt{1 + |(1 - T_{J_1}^-(u_i))|^2} + \sqrt{1 + |(1 - T_{J_2}^-(u_i))|^2}} \right\} + \left\{ \frac{2|T_{J_1}^+(u_i) - T_{J_2}^+(u_i)|}{\sqrt{1 + |T_{J_1}^+(u_i)|^2} + \sqrt{1 + |T_{J_2}^+(u_i)|^2}} + \frac{2|(1 - T_{J_1}^+(u_i)) - (1 - T_{J_2}^+(u_i))|}{\sqrt{1 + |(1 - T_{J_1}^+(u_i))|^2} + \sqrt{1 + |(1 - T_{J_2}^+(u_i))|^2}} \right\} + \left\{ \frac{2|I_{J_1}^-(u_i) - I_{J_2}^-(u_i)|}{\sqrt{1 + |I_{J_1}^-(u_i)|^2} + \sqrt{1 + |I_{J_2}^-(u_i)|^2}} + \frac{2|(1 - I_{J_1}^-(u_i)) - (1 - I_{J_2}^-(u_i))|}{\sqrt{1 + |(1 - I_{J_1}^-(u_i))|^2} + \sqrt{1 + |(1 - I_{J_2}^-(u_i))|^2}} \right\} + \left\{ \frac{2|I_{J_1}^+(u_i) - I_{J_2}^+(u_i)|}{\sqrt{1 + |I_{J_1}^+(u_i)|^2} + \sqrt{1 + |I_{J_2}^+(u_i)|^2}} + \frac{2|(1 - I_{J_1}^+(u_i)) - (1 - I_{J_2}^+(u_i))|}{\sqrt{1 + |(1 - I_{J_1}^+(u_i))|^2} + \sqrt{1 + |(1 - I_{J_2}^+(u_i))|^2}} \right\} + \left\{ \frac{2|F_{J_1}^-(u_i) - F_{J_2}^-(u_i)|}{\sqrt{1 + |F_{J_1}^-(u_i)|^2} + \sqrt{1 + |F_{J_2}^-(u_i)|^2}} + \frac{2|(1 - F_{J_1}^-(u_i)) - (1 - F_{J_2}^-(u_i))|}{\sqrt{1 + |(1 - F_{J_1}^-(u_i))|^2} + \sqrt{1 + |(1 - F_{J_2}^-(u_i))|^2}} \right\} + \left\{ \frac{2|F_{J_1}^+(u_i) - F_{J_2}^+(u_i)|}{\sqrt{1 + |F_{J_1}^+(u_i)|^2} + \sqrt{1 + |F_{J_2}^+(u_i)|^2}} + \frac{2|(1 - F_{J_1}^+(u_i)) - (1 - F_{J_2}^+(u_i))|}{\sqrt{1 + |(1 - F_{J_1}^+(u_i))|^2} + \sqrt{1 + |(1 - F_{J_2}^+(u_i))|^2}} \right\} \quad (1)$$

Theorem 1.

Interval-valued neutrosophic cross entropy $CE_{IN}(J_1, J_2)$ for any two INSs J_1 and J_2 of U , satisfies the following properties:

- i) $CE_{IN}(J_1, J_2) \geq 0$.
- ii) $CE_{IN}(J_1, J_2) = 0$ if and only if

$$T_{J_1}^-(u_i) = T_{J_2}^-(u_i), T_{J_1}^+(u_i) = T_{J_2}^+(u_i), I_{J_1}^-(u_i) = I_{J_2}^-(u_i), I_{J_1}^+(u_i) = I_{J_2}^+(u_i), F_{J_1}^-(u_i) = F_{J_2}^-(u_i), F_{J_1}^+(u_i) = F_{J_2}^+(u_i) \text{ for all } \forall u_i \in U.$$

$$\text{iii) } CE_{IN}(J_1, J_2) = CE_{IN}(J_1^c, J_2^c)$$

$$\text{iv) } CE_{IN}(J_1, J_2) = CE_{IN}(J_2, J_1)$$

Proof: i)

For all values of $u_i \in U$, $|T_{J_1}^-(u_i)| \geq 0$, $|T_{J_2}^-(u_i)| \geq 0$,

$$|T_{J_1}^-(u_i) - T_{J_2}^-(u_i)| \geq 0, \sqrt{1 + |T_{J_1}^-(u_i)|^2} \geq 0, \sqrt{1 + |T_{J_2}^-(u_i)|^2} \geq 0,$$

$$|1 - T_{J_1}^-(u_i)| \geq 0, \quad |1 - T_{J_2}^-(u_i)| \geq 0,$$

$$|(1 - T_{J_1}^-(u_i)) - (1 - T_{J_2}^-(u_i))| \geq 0, \quad \sqrt{1 + |(1 - T_{J_1}^-(u_i))|^2} \geq 0,$$

$$\sqrt{1 + |(1 - T_{J_2}^-(u_i))|^2} \geq 0$$

$$\Rightarrow \left[\frac{2|T_{J_1}^-(u_i) - T_{J_2}^-(u_i)|}{\sqrt{1 + |T_{J_1}^-(u_i)|^2} + \sqrt{1 + |T_{J_2}^-(u_i)|^2}} + \frac{2|(1 - T_{J_1}^-(u_i)) - (1 - T_{J_2}^-(u_i))|}{\sqrt{1 + |(1 - T_{J_1}^-(u_i))|^2} + \sqrt{1 + |(1 - T_{J_2}^-(u_i))|^2}} \right] \geq 0$$

and $|T_{J_1}^+(u_i)| \geq 0$, $|T_{J_2}^+(u_i)| \geq 0$, $|T_{J_1}^+(u_i) - T_{J_2}^+(u_i)| \geq 0$,

$$\sqrt{1 + |T_{J_1}^+(u_i)|^2} \geq 0, \sqrt{1 + |T_{J_2}^+(u_i)|^2} \geq 0,$$

$$|1 - T_{J_1}^+(u_i)| \geq 0, |1 - T_{J_2}^+(u_i)| \geq 0,$$

$$|(1 - T_{J_1}^+(u_i)) - (1 - T_{J_2}^+(u_i))| \geq 0, \sqrt{1 + |(1 - T_{J_1}^+(u_i))|^2} \geq 0,$$

$$\sqrt{1 + |(1 - T_{J_2}^+(u_i))|^2} \geq 0$$

$$\Rightarrow \left[\frac{2|T_{J_1}^+(u_i) - T_{J_2}^+(u_i)|}{\sqrt{1 + |T_{J_1}^+(u_i)|^2} + \sqrt{1 + |T_{J_2}^+(u_i)|^2}} + \frac{2|(1 - T_{J_1}^+(u_i)) - (1 - T_{J_2}^+(u_i))|}{\sqrt{1 + |(1 - T_{J_1}^+(u_i))|^2} + \sqrt{1 + |(1 - T_{J_2}^+(u_i))|^2}} \right] \geq 0$$

Similarly, we can show that

$$\left[\frac{2|I_{J_1}(u_i) - I_{J_2}(u_i)|}{\sqrt{1 + |I_{J_1}(u_i)|^2} + \sqrt{1 + |I_{J_2}(u_i)|^2}} + \frac{2|(1 - I_{J_1}(u_i)) - (1 - I_{J_2}(u_i))|}{\sqrt{1 + |(1 - I_{J_1}(u_i))|^2} + \sqrt{1 + |(1 - I_{J_2}(u_i))|^2}} \right] \geq 0$$

$$\left[\frac{2|I_{J_1}^+(u_i) - I_{J_2}^+(u_i)|}{\sqrt{1 + |I_{J_1}^+(u_i)|^2} + \sqrt{1 + |I_{J_2}^+(u_i)|^2}} + \frac{2|(1 - I_{J_1}^+(u_i)) - (1 - I_{J_2}^+(u_i))|}{\sqrt{1 + |(1 - I_{J_1}^+(u_i))|^2} + \sqrt{1 + |(1 - I_{J_2}^+(u_i))|^2}} \right] \geq 0$$

$$\left[\frac{2|F_{J_1}^-(u_i) - F_{J_2}^-(u_i)|}{\sqrt{1 + |F_{J_1}^-(u_i)|^2} + \sqrt{1 + |F_{J_2}^-(u_i)|^2}} + \frac{2|(1 - F_{J_1}^-(u_i)) - (1 - F_{J_2}^-(u_i))|}{\sqrt{1 + |(1 - F_{J_1}^-(u_i))|^2} + \sqrt{1 + |(1 - F_{J_2}^-(u_i))|^2}} \right] \geq 0$$

and

$$\left[\frac{2|F_{J_1}^+(u_i) - F_{J_2}^+(u_i)|}{\sqrt{1 + |F_{J_1}^+(u_i)|^2} + \sqrt{1 + |F_{J_2}^+(u_i)|^2}} + \frac{2|(1 - F_{J_1}^+(u_i)) - (1 - F_{J_2}^+(u_i))|}{\sqrt{1 + |(1 - F_{J_1}^+(u_i))|^2} + \sqrt{1 + |(1 - F_{J_2}^+(u_i))|^2}} \right] \geq 0$$

Hence, we can conclude that $CE_{IN}(J_1, J_2) \geq 0$.

ii). For all values of $u_i \in U$,

$$\left[\frac{2|T_{J_1}^-(u_i) - T_{J_2}^-(u_i)|}{\sqrt{1 + |T_{J_1}^-(u_i)|^2} + \sqrt{1 + |T_{J_2}^-(u_i)|^2}} + \frac{2|(1 - T_{J_1}^-(u_i)) - (1 - T_{J_2}^-(u_i))|}{\sqrt{1 + |(1 - T_{J_1}^-(u_i))|^2} + \sqrt{1 + |(1 - T_{J_2}^-(u_i))|^2}} \right] = 0$$

$$\Leftrightarrow T_{J_1}^-(u_i) = T_{J_2}^-(u_i)$$

$$\left[\frac{2|T_{J_1}^+(u_i) - T_{J_2}^+(u_i)|}{\sqrt{1 + |T_{J_1}^+(u_i)|^2} + \sqrt{1 + |T_{J_2}^+(u_i)|^2}} + \frac{2|(1 - T_{J_1}^+(u_i)) - (1 - T_{J_2}^+(u_i))|}{\sqrt{1 + |(1 - T_{J_1}^+(u_i))|^2} + \sqrt{1 + |(1 - T_{J_2}^+(u_i))|^2}} \right] = 0$$

$$\Leftrightarrow T_{J_1}^+(u_i) = T_{J_2}^+(u_i)$$

$$\left[\frac{2|I_{J_1}(u_i) - I_{J_2}(u_i)|}{\sqrt{1 + |I_{J_1}(u_i)|^2} + \sqrt{1 + |I_{J_2}(u_i)|^2}} + \frac{2|(1 - I_{J_1}(u_i)) - (1 - I_{J_2}(u_i))|}{\sqrt{1 + |(1 - I_{J_1}(u_i))|^2} + \sqrt{1 + |(1 - I_{J_2}(u_i))|^2}} \right] = 0$$

$$\Leftrightarrow I_{J_1}(u_i) = I_{J_2}(u_i)$$

$$\left[\frac{2|I_{J_1}^+(u_i) - I_{J_2}^+(u_i)|}{\sqrt{1 + |I_{J_1}^+(u_i)|^2} + \sqrt{1 + |I_{J_2}^+(u_i)|^2}} + \frac{2|(1 - I_{J_1}^+(u_i)) - (1 - I_{J_2}^+(u_i))|}{\sqrt{1 + |(1 - I_{J_1}^+(u_i))|^2} + \sqrt{1 + |(1 - I_{J_2}^+(u_i))|^2}} \right] = 0$$

$$\Leftrightarrow I_{J_1}^+(u_i) = I_{J_2}^+(u_i)$$

$$\left[\frac{2|F_{J_1}^-(u_i) - F_{J_2}^-(u_i)|}{\sqrt{1 + |F_{J_1}^-(u_i)|^2} + \sqrt{1 + |F_{J_2}^-(u_i)|^2}} + \frac{2|(1 - F_{J_1}^-(u_i)) - (1 - F_{J_2}^-(u_i))|}{\sqrt{1 + |(1 - F_{J_1}^-(u_i))|^2} + \sqrt{1 + |(1 - F_{J_2}^-(u_i))|^2}} \right] = 0$$

$$\Leftrightarrow F_{J_1}^-(u_i) = F_{J_2}^-(u_i)$$

$$\left[\frac{2|F_{J_1}^+(u_i) - F_{J_2}^+(u_i)|}{\sqrt{1 + |F_{J_1}^+(u_i)|^2} + \sqrt{1 + |F_{J_2}^+(u_i)|^2}} + \frac{2|(1 - F_{J_1}^+(u_i)) - (1 - F_{J_2}^+(u_i))|}{\sqrt{1 + |(1 - F_{J_1}^+(u_i))|^2} + \sqrt{1 + |(1 - F_{J_2}^+(u_i))|^2}} \right] = 0$$

$$\Leftrightarrow F_{J_1}^+(u_i) = F_{J_2}^+(u_i)$$

So, $CE_{IN}(J_1, J_2) = 0$ if and only if

$$T_{J_1}^-(u_i) = T_{J_2}^-(u_i), \quad T_{J_1}^+(u_i) = T_{J_2}^+(u_i), \quad I_{J_1}^-(u_i) = I_{J_2}^-(u_i),$$

$$I_{J_1}^+(u_i) = I_{J_2}^+(u_i), \quad F_{J_1}^-(u_i) = F_{J_2}^-(u_i), \quad F_{J_1}^+(u_i) = F_{J_2}^+(u_i) \quad \forall u_i \in U.$$

Hence complete the proof.

iii). Using definition (2.4), we obtain the following expression:

$$CE_{IN}(J_1^c, J_2^c) = \frac{1}{4} \left[\sum_{i=1}^n \left(\frac{2|(1-T_{J_1}^-(u_i))-(1-T_{J_2}^-(u_i))|}{\sqrt{1+(1-T_{J_1}^-(u_i))^2} + \sqrt{1+(1-T_{J_2}^-(u_i))^2}} + \frac{2|T_{J_1}^-(u_i)-T_{J_2}^-(u_i)|}{\sqrt{1+|T_{J_1}^-(u_i)|^2} + \sqrt{1+|T_{J_2}^-(u_i)|^2}} \right) + \right. \\ \left. \frac{2|(1-T_{J_1}^+(u_i))-(1-T_{J_2}^+(u_i))|}{\sqrt{1+(1-T_{J_1}^+(u_i))^2} + \sqrt{1+(1-T_{J_2}^+(u_i))^2}} + \frac{2|T_{J_1}^+(u_i)-T_{J_2}^+(u_i)|}{\sqrt{1+|T_{J_1}^+(u_i)|^2} + \sqrt{1+|T_{J_2}^+(u_i)|^2}} \right] + \\ \left[\frac{2|(1-I_{J_1}^-(u_i))-(1-I_{J_2}^-(u_i))|}{\sqrt{1+(1-I_{J_1}^-(u_i))^2} + \sqrt{1+(1-I_{J_2}^-(u_i))^2}} + \frac{2|I_{J_1}^-(u_i)-I_{J_2}^-(u_i)|}{\sqrt{1+|I_{J_1}^-(u_i)|^2} + \sqrt{1+|I_{J_2}^-(u_i)|^2}} \right] + \\ \left[\frac{2|(1-I_{J_1}^+(u_i))-(1-I_{J_2}^+(u_i))|}{\sqrt{1+(1-I_{J_1}^+(u_i))^2} + \sqrt{1+(1-I_{J_2}^+(u_i))^2}} + \frac{2|I_{J_1}^+(u_i)-I_{J_2}^+(u_i)|}{\sqrt{1+|I_{J_1}^+(u_i)|^2} + \sqrt{1+|I_{J_2}^+(u_i)|^2}} \right] + \\ \left[\frac{2|(1-F_{J_1}^-(u_i))-(1-F_{J_2}^-(u_i))|}{\sqrt{1+(1-F_{J_1}^-(u_i))^2} + \sqrt{1+(1-F_{J_2}^-(u_i))^2}} + \frac{2|F_{J_1}^-(u_i)-F_{J_2}^-(u_i)|}{\sqrt{1+|F_{J_1}^-(u_i)|^2} + \sqrt{1+|F_{J_2}^-(u_i)|^2}} \right] + \\ \left. \left[\frac{2|(1-F_{J_1}^+(u_i))-(1-F_{J_2}^+(u_i))|}{\sqrt{1+(1-F_{J_1}^+(u_i))^2} + \sqrt{1+(1-F_{J_2}^+(u_i))^2}} + \frac{2|F_{J_1}^+(u_i)-F_{J_2}^+(u_i)|}{\sqrt{1+|F_{J_1}^+(u_i)|^2} + \sqrt{1+|F_{J_2}^+(u_i)|^2}} \right] \right] \\ \frac{1}{4} \left[\sum_{i=1}^n \left(\frac{2|T_{J_1}^-(u_i)-T_{J_2}^-(u_i)|}{\sqrt{1+|T_{J_1}^-(u_i)|^2} + \sqrt{1+|T_{J_2}^-(u_i)|^2}} + \frac{2|(1-T_{J_1}^-(u_i))-(1-T_{J_2}^-(u_i))|}{\sqrt{1+(1-T_{J_1}^-(u_i))^2} + \sqrt{1+(1-T_{J_2}^-(u_i))^2}} \right) + \right. \\ \left. \frac{2|T_{J_1}^+(u_i)-T_{J_2}^+(u_i)|}{\sqrt{1+|T_{J_1}^+(u_i)|^2} + \sqrt{1+|T_{J_2}^+(u_i)|^2}} + \frac{2|(1-T_{J_1}^+(u_i))-(1-T_{J_2}^+(u_i))|}{\sqrt{1+(1-T_{J_1}^+(u_i))^2} + \sqrt{1+(1-T_{J_2}^+(u_i))^2}} \right] + \\ \left[\frac{2|I_{J_1}^-(u_i)-I_{J_2}^-(u_i)|}{\sqrt{1+|I_{J_1}^-(u_i)|^2} + \sqrt{1+|I_{J_2}^-(u_i)|^2}} + \frac{2|(1-I_{J_1}^-(u_i))-(1-I_{J_2}^-(u_i))|}{\sqrt{1+(1-I_{J_1}^-(u_i))^2} + \sqrt{1+(1-I_{J_2}^-(u_i))^2}} \right] + \\ \left[\frac{2|I_{J_1}^+(u_i)-I_{J_2}^+(u_i)|}{\sqrt{1+|I_{J_1}^+(u_i)|^2} + \sqrt{1+|I_{J_2}^+(u_i)|^2}} + \frac{2|(1-I_{J_1}^+(u_i))-(1-I_{J_2}^+(u_i))|}{\sqrt{1+(1-I_{J_1}^+(u_i))^2} + \sqrt{1+(1-I_{J_2}^+(u_i))^2}} \right] + \\ \left[\frac{2|I_{J_1}^-(u_i)-I_{J_2}^-(u_i)|}{\sqrt{1+|I_{J_1}^-(u_i)|^2} + \sqrt{1+|I_{J_2}^-(u_i)|^2}} + \frac{2|(1-I_{J_1}^-(u_i))-(1-I_{J_2}^-(u_i))|}{\sqrt{1+(1-I_{J_1}^-(u_i))^2} + \sqrt{1+(1-I_{J_2}^-(u_i))^2}} \right] + \\ \left. \left[\frac{2|I_{J_1}^+(u_i)-I_{J_2}^+(u_i)|}{\sqrt{1+|I_{J_1}^+(u_i)|^2} + \sqrt{1+|I_{J_2}^+(u_i)|^2}} + \frac{2|(1-I_{J_1}^+(u_i))-(1-I_{J_2}^+(u_i))|}{\sqrt{1+(1-I_{J_1}^+(u_i))^2} + \sqrt{1+(1-I_{J_2}^+(u_i))^2}} \right] \right]$$

$$\left[\frac{2|F_{J_1}^-(u_i)-F_{J_2}^-(u_i)|}{\sqrt{1+|F_{J_1}^-(u_i)|^2} + \sqrt{1+|F_{J_2}^-(u_i)|^2}} + \frac{2|(1-F_{J_1}^-(u_i))-(1-F_{J_2}^-(u_i))|}{\sqrt{1+(1-F_{J_1}^-(u_i))^2} + \sqrt{1+(1-F_{J_2}^-(u_i))^2}} \right] + \\ \left. \left[\frac{2|F_{J_1}^+(u_i)-F_{J_2}^+(u_i)|}{\sqrt{1+|F_{J_1}^+(u_i)|^2} + \sqrt{1+|F_{J_2}^+(u_i)|^2}} + \frac{2|(1-F_{J_1}^+(u_i))-(1-F_{J_2}^+(u_i))|}{\sqrt{1+(1-F_{J_1}^+(u_i))^2} + \sqrt{1+(1-F_{J_2}^+(u_i))^2}} \right] \right\} CE_{IN}(J_1, J_2).$$

Hence complete the proof.

iv).

$$CE_{IN}(J_1, J_2) = \frac{1}{4} \left[\sum_{i=1}^n \left(\frac{2|T_{J_1}^-(u_i)-T_{J_2}^-(u_i)|}{\sqrt{1+|T_{J_1}^-(u_i)|^2} + \sqrt{1+|T_{J_2}^-(u_i)|^2}} + \frac{2|(1-T_{J_1}^-(u_i))-(1-T_{J_2}^-(u_i))|}{\sqrt{1+(1-T_{J_1}^-(u_i))^2} + \sqrt{1+(1-T_{J_2}^-(u_i))^2}} \right) + \right. \\ \left. \frac{2|T_{J_1}^+(u_i)-T_{J_2}^+(u_i)|}{\sqrt{1+|T_{J_1}^+(u_i)|^2} + \sqrt{1+|T_{J_2}^+(u_i)|^2}} + \frac{2|(1-T_{J_1}^+(u_i))-(1-T_{J_2}^+(u_i))|}{\sqrt{1+(1-T_{J_1}^+(u_i))^2} + \sqrt{1+(1-T_{J_2}^+(u_i))^2}} \right] + \\ \left[\frac{2|I_{J_1}^-(u_i)-I_{J_2}^-(u_i)|}{\sqrt{1+|I_{J_1}^-(u_i)|^2} + \sqrt{1+|I_{J_2}^-(u_i)|^2}} + \frac{2|(1-I_{J_1}^-(u_i))-(1-I_{J_2}^-(u_i))|}{\sqrt{1+(1-I_{J_1}^-(u_i))^2} + \sqrt{1+(1-I_{J_2}^-(u_i))^2}} \right] + \\ \left[\frac{2|I_{J_1}^+(u_i)-I_{J_2}^+(u_i)|}{\sqrt{1+|I_{J_1}^+(u_i)|^2} + \sqrt{1+|I_{J_2}^+(u_i)|^2}} + \frac{2|(1-I_{J_1}^+(u_i))-(1-I_{J_2}^+(u_i))|}{\sqrt{1+(1-I_{J_1}^+(u_i))^2} + \sqrt{1+(1-I_{J_2}^+(u_i))^2}} \right] + \\ \left[\frac{2|I_{J_1}^-(u_i)-I_{J_2}^-(u_i)|}{\sqrt{1+|I_{J_1}^-(u_i)|^2} + \sqrt{1+|I_{J_2}^-(u_i)|^2}} + \frac{2|(1-I_{J_1}^-(u_i))-(1-I_{J_2}^-(u_i))|}{\sqrt{1+(1-I_{J_1}^-(u_i))^2} + \sqrt{1+(1-I_{J_2}^-(u_i))^2}} \right] + \\ \left. \left[\frac{2|I_{J_1}^+(u_i)-I_{J_2}^+(u_i)|}{\sqrt{1+|I_{J_1}^+(u_i)|^2} + \sqrt{1+|I_{J_2}^+(u_i)|^2}} + \frac{2|(1-I_{J_1}^+(u_i))-(1-I_{J_2}^+(u_i))|}{\sqrt{1+(1-I_{J_1}^+(u_i))^2} + \sqrt{1+(1-I_{J_2}^+(u_i))^2}} \right] \right] \\ \frac{1}{4} \left[\sum_{i=1}^n \left(\frac{2|T_{J_2}^-(u_i)-T_{J_1}^-(u_i)|}{\sqrt{1+|T_{J_2}^-(u_i)|^2} + \sqrt{1+|T_{J_1}^-(u_i)|^2}} + \frac{2|(1-T_{J_2}^-(u_i))-(1-T_{J_1}^-(u_i))|}{\sqrt{1+(1-T_{J_2}^-(u_i))^2} + \sqrt{1+(1-T_{J_1}^-(u_i))^2}} \right) + \right. \\ \left. \frac{2|T_{J_2}^+(u_i)-T_{J_1}^+(u_i)|}{\sqrt{1+|T_{J_2}^+(u_i)|^2} + \sqrt{1+|T_{J_1}^+(u_i)|^2}} + \frac{2|(1-T_{J_2}^+(u_i))-(1-T_{J_1}^+(u_i))|}{\sqrt{1+(1-T_{J_2}^+(u_i))^2} + \sqrt{1+(1-T_{J_1}^+(u_i))^2}} \right] + \\ \left[\frac{2|I_{J_2}^-(u_i)-I_{J_1}^-(u_i)|}{\sqrt{1+|I_{J_2}^-(u_i)|^2} + \sqrt{1+|I_{J_1}^-(u_i)|^2}} + \frac{2|(1-I_{J_2}^-(u_i))-(1-I_{J_1}^-(u_i))|}{\sqrt{1+(1-I_{J_2}^-(u_i))^2} + \sqrt{1+(1-I_{J_1}^-(u_i))^2}} \right] + \\ \left[\frac{2|I_{J_2}^+(u_i)-I_{J_1}^+(u_i)|}{\sqrt{1+|I_{J_2}^+(u_i)|^2} + \sqrt{1+|I_{J_1}^+(u_i)|^2}} + \frac{2|(1-I_{J_2}^+(u_i))-(1-I_{J_1}^+(u_i))|}{\sqrt{1+(1-I_{J_2}^+(u_i))^2} + \sqrt{1+(1-I_{J_1}^+(u_i))^2}} \right] + \\ \left. \left[\frac{2|I_{J_2}^-(u_i)-I_{J_1}^-(u_i)|}{\sqrt{1+|I_{J_2}^-(u_i)|^2} + \sqrt{1+|I_{J_1}^-(u_i)|^2}} + \frac{2|(1-I_{J_2}^-(u_i))-(1-I_{J_1}^-(u_i))|}{\sqrt{1+(1-I_{J_2}^-(u_i))^2} + \sqrt{1+(1-I_{J_1}^-(u_i))^2}} \right] \right]$$

$$\left. \begin{aligned} & \left[\frac{2|I_{J_2}^+(u_i) - I_{J_1}^+(u_i)|}{\sqrt{1+|I_{J_1}^+(u_i)|^2} + \sqrt{1+|I_{J_2}^+(u_i)|^2}} + \frac{2|(1-I_{J_2}^+(u_i)) - (1-I_{J_1}^+(u_i))|}{\sqrt{1+|(1-I_{J_2}^+(u_i))|^2} + \sqrt{1+|(1-I_{J_1}^+(u_i))|^2}} \right] + \\ & \left[\frac{2|F_{J_2}^-(u_i) - F_{J_1}^-(u_i)|}{\sqrt{1+|F_{J_2}^-(u_i)|^2} + \sqrt{1+|F_{J_1}^-(u_i)|^2}} + \frac{2|(1-F_{J_2}^-(u_i)) - (1-F_{J_1}^-(u_i))|}{\sqrt{1+|(1-F_{J_2}^-(u_i))|^2} + \sqrt{1+|(1-F_{J_1}^-(u_i))|^2}} \right] + \\ & \left. \left[\frac{2|F_{J_2}^+(u_i) - F_{J_1}^+(u_i)|}{\sqrt{1+|F_{J_2}^+(u_i)|^2} + \sqrt{1+|F_{J_1}^+(u_i)|^2}} + \frac{2|(1-F_{J_2}^+(u_i)) - (1-F_{J_1}^+(u_i))|}{\sqrt{1+|(1-F_{J_2}^+(u_i))|^2} + \sqrt{1+|(1-F_{J_1}^+(u_i))|^2}} \right] \right\} \\ & = CE_{IN}(J_2, J_1). \end{aligned}$$

Hence complete the proof.

3.1 Definition: Weighted IN-cross-entropy measure

We consider the weight w_i ($i = 1, 2, 3, \dots, n$) of u_i ($i = 1, 2, 3, \dots, n$) with $w_i \in [0,1]$ and $\sum_{i=1}^n w_i = 1$.

Then the weighted cross entropy measure between J_1 and J_2 can be defined as follows:

$$CE_{IN}^w(J_1, J_2) = \frac{1}{4} \left(\sum_{i=1}^n w_i \left\{ \left[\frac{2|T_{J_1}^-(u_i) - T_{J_2}^-(u_i)|}{\sqrt{1+|T_{J_1}^-(u_i)|^2} + \sqrt{1+|T_{J_2}^-(u_i)|^2}} + \frac{2|(1-T_{J_1}^-(u_i)) - (1-T_{J_2}^-(u_i))|}{\sqrt{1+|(1-T_{J_1}^-(u_i))|^2} + \sqrt{1+|(1-T_{J_2}^-(u_i))|^2}} \right] + \right. \right. \\ \left. \left[\frac{2|T_{J_1}^+(u_i) - T_{J_2}^+(u_i)|}{\sqrt{1+|T_{J_1}^+(u_i)|^2} + \sqrt{1+|T_{J_2}^+(u_i)|^2}} + \frac{2|(1-T_{J_1}^+(u_i)) - (1-T_{J_2}^+(u_i))|}{\sqrt{1+|(1-T_{J_1}^+(u_i))|^2} + \sqrt{1+|(1-T_{J_2}^+(u_i))|^2}} \right] + \right. \\ \left. \left[\frac{2|I_{J_1}^-(u_i) - I_{J_2}^-(u_i)|}{\sqrt{1+|I_{J_1}^-(u_i)|^2} + \sqrt{1+|I_{J_2}^-(u_i)|^2}} + \frac{2|(1-I_{J_1}^-(u_i)) - (1-I_{J_2}^-(u_i))|}{\sqrt{1+|(1-I_{J_1}^-(u_i))|^2} + \sqrt{1+|(1-I_{J_2}^-(u_i))|^2}} \right] + \right. \\ \left. \left[\frac{2|I_{J_1}^+(u_i) - I_{J_2}^+(u_i)|}{\sqrt{1+|I_{J_1}^+(u_i)|^2} + \sqrt{1+|I_{J_2}^+(u_i)|^2}} + \frac{2|(1-I_{J_1}^+(u_i)) - (1-I_{J_2}^+(u_i))|}{\sqrt{1+|(1-I_{J_1}^+(u_i))|^2} + \sqrt{1+|(1-I_{J_2}^+(u_i))|^2}} \right] + \right. \\ \left. \left[\frac{2|F_{J_1}^-(u_i) - F_{J_2}^-(u_i)|}{\sqrt{1+|F_{J_1}^-(u_i)|^2} + \sqrt{1+|F_{J_2}^-(u_i)|^2}} + \frac{2|(1-F_{J_1}^-(u_i)) - (1-F_{J_2}^-(u_i))|}{\sqrt{1+|(1-F_{J_1}^-(u_i))|^2} + \sqrt{1+|(1-F_{J_2}^-(u_i))|^2}} \right] + \right. \\ \left. \left[\frac{2|F_{J_1}^+(u_i) - F_{J_2}^+(u_i)|}{\sqrt{1+|F_{J_1}^+(u_i)|^2} + \sqrt{1+|F_{J_2}^+(u_i)|^2}} + \frac{2|(1-F_{J_1}^+(u_i)) - (1-F_{J_2}^+(u_i))|}{\sqrt{1+|(1-F_{J_1}^+(u_i))|^2} + \sqrt{1+|(1-F_{J_2}^+(u_i))|^2}} \right] \right\} \right) \tag{2}$$

Theorem 2.

Interval neutrosophic weighted cross-entropy measure $CE_{IN}^w(J_1, J_2)$ satisfies the following properties:

i). $CE_{IN}^w(J_1, J_2) \geq 0$.

ii). $CE_{IN}^w(J_1, J_2) = 0$, if and only if

$$T_{J_1}^-(u_i) = T_{J_2}^-(u_i), \quad T_{J_1}^+(u_i) = T_{J_2}^+(u_i), \quad I_{J_1}^-(u_i) = I_{J_2}^-(u_i), \\ I_{J_1}^+(u_i) = I_{J_2}^+(u_i), \quad F_{J_1}^-(u_i) = F_{J_2}^-(u_i), \quad F_{J_1}^+(u_i) = F_{J_2}^+(u_i) \text{ for all } \\ \forall u_i \in U.$$

iii). $CE_{IN}^w(J_1, J_2) = CE_{IN}^w(J_1^c, J_2^c)$

iv). $CE_{IN}^w(J_1, J_2) = CE_{IN}^w(J_2, J_1)$

Proof:

i). For all values of $u_i \in U$, $|T_{J_1}^-(u_i)| \geq 0$, $|T_{J_2}^-(u_i)| \geq 0$,

$$|T_{J_1}^-(u_i) - T_{J_2}^-(u_i)| \geq 0, \quad \sqrt{1+|T_{J_1}^-(u_i)|^2} \geq 0,$$

$$\sqrt{1+|T_{J_2}^-(u_i)|^2} \geq 0, \quad |(1-T_{J_1}^-(u_i))| \geq 0, \quad |(1-T_{J_2}^-(u_i))| \geq 0,$$

$$|(1-T_{J_1}^-(u_i)) - (1-T_{J_2}^-(u_i))| \geq 0,$$

$$\sqrt{1+|(1-T_{J_1}^-(u_i))|^2} \geq 0, \quad \sqrt{1+|(1-T_{J_2}^-(u_i))|^2} \geq 0$$

$$\Rightarrow \left[\frac{2|T_{J_1}^-(u_i) - T_{J_2}^-(u_i)|}{\sqrt{1+|T_{J_1}^-(u_i)|^2} + \sqrt{1+|T_{J_2}^-(u_i)|^2}} + \frac{2|(1-T_{J_1}^-(u_i)) - (1-T_{J_2}^-(u_i))|}{\sqrt{1+|(1-T_{J_1}^-(u_i))|^2} + \sqrt{1+|(1-T_{J_2}^-(u_i))|^2}} \right] \geq 0$$

and $|T_{J_1}^+(u_i)| \geq 0$, $|T_{J_2}^+(u_i)| \geq 0$, $|T_{J_1}^+(u_i) - T_{J_2}^+(u_i)| \geq 0$,

$$\sqrt{1+|T_{J_1}^+(u_i)|^2} \geq 0, \quad \sqrt{1+|T_{J_2}^+(u_i)|^2} \geq 0,$$

$$|(1-T_{J_1}^+(u_i))| \geq 0, \quad |(1-T_{J_2}^+(u_i))| \geq 0, \quad |(1-T_{J_1}^+(u_i)) - (1-T_{J_2}^+(u_i))| \geq 0,$$

$$\sqrt{1+|(1-T_{J_1}^+(u_i))|^2} \geq 0, \quad \sqrt{1+|(1-T_{J_2}^+(u_i))|^2} \geq 0$$

$$\Rightarrow \left[\frac{2|T_{J_1}^+(u_i) - T_{J_2}^+(u_i)|}{\sqrt{1+|T_{J_1}^+(u_i)|^2} + \sqrt{1+|T_{J_2}^+(u_i)|^2}} + \frac{2|(1-T_{J_1}^+(u_i)) - (1-T_{J_2}^+(u_i))|}{\sqrt{1+|(1-T_{J_1}^+(u_i))|^2} + \sqrt{1+|(1-T_{J_2}^+(u_i))|^2}} \right] \geq 0$$

Similarly, we can show that

$$\left[\frac{2|I_{J_1}^-(u_i) - I_{J_2}^-(u_i)|}{\sqrt{1+|I_{J_1}^-(u_i)|^2} + \sqrt{1+|I_{J_2}^-(u_i)|^2}} + \frac{2|(1-I_{J_1}^-(u_i)) - (1-I_{J_2}^-(u_i))|}{\sqrt{1+|(1-I_{J_1}^-(u_i))|^2} + \sqrt{1+|(1-I_{J_2}^-(u_i))|^2}} \right] \geq 0$$

$$\left[\frac{2|I_{J_1}^+(u_i) - I_{J_2}^+(u_i)|}{\sqrt{1+|I_{J_1}^+(u_i)|^2} + \sqrt{1+|I_{J_2}^+(u_i)|^2}} + \frac{2|(1-I_{J_1}^+(u_i)) - (1-I_{J_2}^+(u_i))|}{\sqrt{1+|(1-I_{J_1}^+(u_i))|^2} + \sqrt{1+|(1-I_{J_2}^+(u_i))|^2}} \right] \geq 0$$

$$\left[\frac{2|F_{J_1}^-(u_i) - F_{J_2}^-(u_i)|}{\sqrt{1+|F_{J_1}^-(u_i)|^2} + \sqrt{1+|F_{J_2}^-(u_i)|^2}} + \frac{2|(1-F_{J_1}^-(u_i)) - (1-F_{J_2}^-(u_i))|}{\sqrt{1+|(1-F_{J_1}^-(u_i))|^2} + \sqrt{1+|(1-F_{J_2}^-(u_i))|^2}} \right] \geq 0$$

and

$$\left[\frac{2|F_{J_1}^+(u_i) - F_{J_2}^+(u_i)|}{\sqrt{1+|F_{J_1}^+(u_i)|^2} + \sqrt{1+|F_{J_2}^+(u_i)|^2}} + \frac{2|(1-F_{J_1}^+(u_i)) - (1-F_{J_2}^+(u_i))|}{\sqrt{1+|(1-F_{J_1}^+(u_i))|^2} + \sqrt{1+|(1-F_{J_2}^+(u_i))|^2}} \right] \geq 0$$

Since $w_i \in [0,1], \sum_{i=1}^n w_i = 1$, we have, $CE_{IN}^w(J_1, J_2) \geq 0$. Hence

complete the proof.

ii).

$$\left[\frac{2|T_{J_1}(u_i) - T_{J_2}(u_i)|}{\sqrt{1+|T_{J_1}(u_i)|^2} + \sqrt{1+|T_{J_2}(u_i)|^2}} + \frac{2|(1-T_{J_1}(u_i)) - (1-T_{J_2}(u_i))|}{\sqrt{1+|(1-T_{J_1}(u_i))|^2} + \sqrt{1+|(1-T_{J_2}(u_i))|^2}} \right] = 0$$

$$\Leftrightarrow T_{J_1}(u_i) = T_{J_2}(u_i)$$

$$\left[\frac{2|T_{J_1}^+(u_i) - T_{J_2}^+(u_i)|}{\sqrt{1+|T_{J_1}^+(u_i)|^2} + \sqrt{1+|T_{J_2}^+(u_i)|^2}} + \frac{2|(1-T_{J_1}^+(u_i)) - (1-T_{J_2}^+(u_i))|}{\sqrt{1+|(1-T_{J_1}^+(u_i))|^2} + \sqrt{1+|(1-T_{J_2}^+(u_i))|^2}} \right] = 0$$

$$\Leftrightarrow T_{J_1}^+(u_i) = T_{J_2}^+(u_i)$$

$$\left[\frac{2|I_{J_1}(u_i) - I_{J_2}(u_i)|}{\sqrt{1+|I_{J_1}(u_i)|^2} + \sqrt{1+|I_{J_2}(u_i)|^2}} + \frac{2|(1-I_{J_1}(u_i)) - (1-I_{J_2}(u_i))|}{\sqrt{1+|(1-I_{J_1}(u_i))|^2} + \sqrt{1+|(1-I_{J_2}(u_i))|^2}} \right] = 0$$

$$\Leftrightarrow I_{J_1}(u_i) = I_{J_2}(u_i)$$

$$\left[\frac{2|I_{J_1}^+(u_i) - I_{J_2}^+(u_i)|}{\sqrt{1+|I_{J_1}^+(u_i)|^2} + \sqrt{1+|I_{J_2}^+(u_i)|^2}} + \frac{2|(1-I_{J_1}^+(u_i)) - (1-I_{J_2}^+(u_i))|}{\sqrt{1+|(1-I_{J_1}^+(u_i))|^2} + \sqrt{1+|(1-I_{J_2}^+(u_i))|^2}} \right] = 0$$

$$\Leftrightarrow I_{J_1}^+(u_i) = I_{J_2}^+(u_i)$$

$$\left[\frac{2|F_{J_1}(u_i) - F_{J_2}(u_i)|}{\sqrt{1+|F_{J_1}(u_i)|^2} + \sqrt{1+|F_{J_2}(u_i)|^2}} + \frac{2|(1-F_{J_1}(u_i)) - (1-F_{J_2}(u_i))|}{\sqrt{1+|(1-F_{J_1}(u_i))|^2} + \sqrt{1+|(1-F_{J_2}(u_i))|^2}} \right] = 0$$

$$\Leftrightarrow F_{J_1}(u_i) = F_{J_2}(u_i)$$

$$\left[\frac{2|F_{J_1}^+(u_i) - F_{J_2}^+(u_i)|}{\sqrt{1+|F_{J_1}^+(u_i)|^2} + \sqrt{1+|F_{J_2}^+(u_i)|^2}} + \frac{2|(1-F_{J_1}^+(u_i)) - (1-F_{J_2}^+(u_i))|}{\sqrt{1+|(1-F_{J_1}^+(u_i))|^2} + \sqrt{1+|(1-F_{J_2}^+(u_i))|^2}} \right] = 0$$

$$\Leftrightarrow F_{J_1}^+(u_i) = F_{J_2}^+(u_i), \text{ For all values of } u_i \in U.$$

Since, $w_i \in [0,1], \sum_{i=1}^n w_i = 1, w_i \geq 0$, we can show that

$$CE_{IN}^w(J_1, J_2) = 0 \text{ iff } T_{J_1}(u_i) = T_{J_2}(u_i), T_{J_1}^+(u_i) = T_{J_2}^+(u_i),$$

$$I_{J_1}(u_i) = I_{J_2}(u_i), I_{J_1}^+(u_i) = I_{J_2}^+(u_i),$$

$$F_{J_1}(u_i) = F_{J_2}(u_i), F_{J_1}^+(u_i) = F_{J_2}^+(u_i) \text{ and}$$

$$T_{J_1}(u_i) = T_{J_2}(u_i), I_{J_1}(u_i) = I_{J_2}(u_i), F_{J_1}(u_i) = F_{J_2}(u_i) \text{ for all } u_i \in U.$$

iii).

Using definition (2.4), we obtain the following expression:

$$CE_{IN}^w(J_1^c, J_2^c) = \frac{1}{4} \left\langle \sum_{i=1}^n w_i \left[\frac{2|T_{J_1}^-(u_i) - T_{J_2}^-(u_i)|}{\sqrt{1+|T_{J_1}^-(u_i)|^2} + \sqrt{1+|T_{J_2}^-(u_i)|^2}} + \frac{2|(1-T_{J_1}^-(u_i)) - (1-T_{J_2}^-(u_i))|}{\sqrt{1+|(1-T_{J_1}^-(u_i))|^2} + \sqrt{1+|(1-T_{J_2}^-(u_i))|^2}} \right] + \right.$$

$$\left. \left[\frac{2|T_{J_1}^+(u_i) - T_{J_2}^+(u_i)|}{\sqrt{1+|T_{J_1}^+(u_i)|^2} + \sqrt{1+|T_{J_2}^+(u_i)|^2}} + \frac{2|(1-T_{J_1}^+(u_i)) - (1-T_{J_2}^+(u_i))|}{\sqrt{1+|(1-T_{J_1}^+(u_i))|^2} + \sqrt{1+|(1-T_{J_2}^+(u_i))|^2}} \right] + \right.$$

$$\left. \left[\frac{2|I_{J_1}^-(u_i) - I_{J_2}^-(u_i)|}{\sqrt{1+|I_{J_1}^-(u_i)|^2} + \sqrt{1+|I_{J_2}^-(u_i)|^2}} + \frac{2|(1-I_{J_1}^-(u_i)) - (1-I_{J_2}^-(u_i))|}{\sqrt{1+|(1-I_{J_1}^-(u_i))|^2} + \sqrt{1+|(1-I_{J_2}^-(u_i))|^2}} \right] + \right.$$

$$\left. \left[\frac{2|I_{J_1}^+(u_i) - I_{J_2}^+(u_i)|}{\sqrt{1+|I_{J_1}^+(u_i)|^2} + \sqrt{1+|I_{J_2}^+(u_i)|^2}} + \frac{2|(1-I_{J_1}^+(u_i)) - (1-I_{J_2}^+(u_i))|}{\sqrt{1+|(1-I_{J_1}^+(u_i))|^2} + \sqrt{1+|(1-I_{J_2}^+(u_i))|^2}} \right] + \right.$$

$$\left. \left[\frac{2|F_{J_1}^-(u_i) - F_{J_2}^-(u_i)|}{\sqrt{1+|F_{J_1}^-(u_i)|^2} + \sqrt{1+|F_{J_2}^-(u_i)|^2}} + \frac{2|(1-F_{J_1}^-(u_i)) - (1-F_{J_2}^-(u_i))|}{\sqrt{1+|(1-F_{J_1}^-(u_i))|^2} + \sqrt{1+|(1-F_{J_2}^-(u_i))|^2}} \right] + \right.$$

$$\left. \left[\frac{2|F_{J_1}^+(u_i) - F_{J_2}^+(u_i)|}{\sqrt{1+|F_{J_1}^+(u_i)|^2} + \sqrt{1+|F_{J_2}^+(u_i)|^2}} + \frac{2|(1-F_{J_1}^+(u_i)) - (1-F_{J_2}^+(u_i))|}{\sqrt{1+|(1-F_{J_1}^+(u_i))|^2} + \sqrt{1+|(1-F_{J_2}^+(u_i))|^2}} \right] \right\rangle$$

$$\frac{1}{4} \left\langle \sum_{i=1}^n w_i \left[\frac{2|(1-T_{J_1}^-(u_i)) - (1-T_{J_2}^-(u_i))|}{\sqrt{1+|(1-T_{J_1}^-(u_i))|^2} + \sqrt{1+|(1-T_{J_2}^-(u_i))|^2}} + \frac{2|T_{J_1}(u_i) - T_{J_2}(u_i)|}{\sqrt{1+|T_{J_1}(u_i)|^2} + \sqrt{1+|T_{J_2}(u_i)|^2}} \right] + \right.$$

$$\left. \left[\frac{2|(1-T_{J_1}^+(u_i)) - (1-T_{J_2}^+(u_i))|}{\sqrt{1+|(1-T_{J_1}^+(u_i))|^2} + \sqrt{1+|(1-T_{J_2}^+(u_i))|^2}} + \frac{2|T_{J_1}^+(u_i) - T_{J_2}^+(u_i)|}{\sqrt{1+|T_{J_1}^+(u_i)|^2} + \sqrt{1+|T_{J_2}^+(u_i)|^2}} \right] + \right.$$

$$\left. \left[\frac{2|(1-I_{J_1}(u_i)) - (1-I_{J_2}(u_i))|}{\sqrt{1+|(1-I_{J_1}(u_i))|^2} + \sqrt{1+|(1-I_{J_2}(u_i))|^2}} + \frac{2|I_{J_1}(u_i) - I_{J_2}(u_i)|}{\sqrt{1+|I_{J_1}(u_i)|^2} + \sqrt{1+|I_{J_2}(u_i)|^2}} \right] + \right.$$

$$\left. \left[\frac{2|(1-I_{J_1}^+(u_i)) - (1-I_{J_2}^+(u_i))|}{\sqrt{1+|(1-I_{J_1}^+(u_i))|^2} + \sqrt{1+|(1-I_{J_2}^+(u_i))|^2}} + \frac{2|I_{J_1}^+(u_i) - I_{J_2}^+(u_i)|}{\sqrt{1+|I_{J_1}^+(u_i)|^2} + \sqrt{1+|I_{J_2}^+(u_i)|^2}} \right] \right\rangle$$

$$\left[\frac{2|(1-F_{J_1}^-(u_i))-(1-F_{J_2}^-(u_i))|}{\sqrt{1+(1-F_{J_1}^-(u_i))^2} + \sqrt{1+(1-F_{J_2}^-(u_i))^2}} + \frac{2|F_{J_1}^-(u_i)-F_{J_2}^-(u_i)|}{\sqrt{1+|F_{J_1}^-(u_i)|^2} + \sqrt{1+|F_{J_2}^-(u_i)|^2}} \right] + \left. \left[\frac{2|(1-F_{Q_1}^+(u_i))-(1-F_{Q_2}^+(u_i))|}{\sqrt{1+(1-F_{Q_1}^+(u_i))^2} + \sqrt{1+(1-F_{Q_2}^+(u_i))^2}} + \frac{2|F_{Q_1}^+(u_i)-F_{Q_2}^+(u_i)|}{\sqrt{1+|F_{Q_1}^+(u_i)|^2} + \sqrt{1+|F_{Q_2}^+(u_i)|^2}} \right] \right\} \left[\frac{1}{4} \sum_{i=1}^n w_i \left\{ \frac{2|T_{J_1}(u_i)-T_{J_2}(u_i)|}{\sqrt{1+|T_{J_1}(u_i)|^2} + \sqrt{1+|T_{J_2}(u_i)|^2}} + \frac{2|(1-T_{J_1}(u_i))-(1-T_{J_2}(u_i))|}{\sqrt{1+(1-T_{J_1}(u_i))^2} + \sqrt{1+(1-T_{J_2}(u_i))^2}} \right\} \right] + \left[\frac{2|T_{J_1}^+(u_i)-T_{J_2}^+(u_i)|}{\sqrt{1+|T_{J_1}^+(u_i)|^2} + \sqrt{1+|T_{J_2}^+(u_i)|^2}} + \frac{2|(1-T_{J_1}^+(u_i))-(1-T_{J_2}^+(u_i))|}{\sqrt{1+(1-T_{J_1}^+(u_i))^2} + \sqrt{1+(1-T_{J_2}^+(u_i))^2}} \right] + \left[\frac{2|I_{J_1}(u_i)-I_{J_2}(u_i)|}{\sqrt{1+|I_{J_1}(u_i)|^2} + \sqrt{1+|I_{J_2}(u_i)|^2}} + \frac{2|(1-I_{J_1}(u_i))-(1-I_{J_2}(u_i))|}{\sqrt{1+(1-I_{J_1}(u_i))^2} + \sqrt{1+(1-I_{J_2}(u_i))^2}} \right] + \left[\frac{2|I_{J_1}^+(u_i)-I_{J_2}^+(u_i)|}{\sqrt{1+|I_{J_1}^+(u_i)|^2} + \sqrt{1+|I_{J_2}^+(u_i)|^2}} + \frac{2|(1-I_{J_1}^+(u_i))-(1-I_{J_2}^+(u_i))|}{\sqrt{1+(1-I_{J_1}^+(u_i))^2} + \sqrt{1+(1-I_{J_2}^+(u_i))^2}} \right] + \left[\frac{2|F_{J_1}(u_i)-F_{J_2}(u_i)|}{\sqrt{1+|F_{J_1}(u_i)|^2} + \sqrt{1+|F_{J_2}(u_i)|^2}} + \frac{2|(1-F_{J_1}(u_i))-(1-F_{J_2}(u_i))|}{\sqrt{1+(1-F_{J_1}(u_i))^2} + \sqrt{1+(1-F_{J_2}(u_i))^2}} \right] + \left. \left[\frac{2|F_{J_1}^+(u_i)-F_{J_2}^+(u_i)|}{\sqrt{1+|F_{J_1}^+(u_i)|^2} + \sqrt{1+|F_{J_2}^+(u_i)|^2}} + \frac{2|(1-F_{J_1}^+(u_i))-(1-F_{J_2}^+(u_i))|}{\sqrt{1+(1-F_{J_1}^+(u_i))^2} + \sqrt{1+(1-F_{J_2}^+(u_i))^2}} \right] \right\}$$

= CE_{IN}^w(J₁, J₂), ∀ u_i ∈ U.

Hence complete the proof.

iv).

Since,

$$\begin{aligned} |T_{J_1}(u_i) - T_{J_2}(u_i)| &= |T_{J_2}(u_i) - T_{J_1}(u_i)|, \\ |I_{J_1}(u_i) - I_{J_2}(u_i)| &= |I_{J_2}(u_i) - I_{J_1}(u_i)|, \\ |F_{J_1}(u_i) - F_{J_2}(u_i)| &= |F_{J_2}(u_i) - F_{J_1}(u_i)|, \\ |(1-T_{J_1}(u_i)) - (1-T_{J_2}(u_i))| &= |(1-T_{J_2}(u_i)) - (1-T_{J_1}(u_i))|, \\ |(1-I_{J_1}(u_i)) - (1-I_{J_2}(u_i))| &= |(1-I_{J_2}(u_i)) - (1-I_{J_1}(u_i))|, \\ |(1-F_{J_1}(u_i)) - (1-F_{J_2}(u_i))| &= |(1-F_{J_2}(u_i)) - (1-F_{J_1}(u_i))|. \end{aligned}$$

Then, we obtain

$$\begin{aligned} \sqrt{1+|T_{J_1}(u_i)|^2} + \sqrt{1+|T_{J_2}(u_i)|^2} &= \sqrt{1+|T_{J_2}(u_i)|^2} + \sqrt{1+|T_{J_1}(u_i)|^2}, \\ \sqrt{1+|I_{J_1}(u_i)|^2} + \sqrt{1+|I_{J_2}(u_i)|^2} &= \sqrt{1+|I_{J_2}(u_i)|^2} + \sqrt{1+|I_{J_1}(u_i)|^2}, \\ \sqrt{1+|F_{J_1}(u_i)|^2} + \sqrt{1+|F_{J_2}(u_i)|^2} &= \sqrt{1+|F_{J_2}(u_i)|^2} + \sqrt{1+|F_{J_1}(u_i)|^2}, \\ \sqrt{1+(1-T_{J_1}(u_i))^2} + \sqrt{1+(1-T_{J_2}(u_i))^2} &= \sqrt{1+(1-T_{J_2}(u_i))^2} + \sqrt{1+(1-T_{J_1}(u_i))^2}, \\ \sqrt{1+(1-I_{J_1}(u_i))^2} + \sqrt{1+(1-I_{J_2}(u_i))^2} &= \sqrt{1+(1-I_{J_2}(u_i))^2} + \sqrt{1+(1-I_{J_1}(u_i))^2}, \end{aligned}$$

$$\sqrt{1+(1-F_{J_1}(u_i))^2} + \sqrt{1+(1-F_{J_2}(u_i))^2} = \sqrt{1+(1-F_{J_2}(u_i))^2} + \sqrt{1+(1-F_{J_1}(u_i))^2}, \forall u_i \in U.$$

Similarly, |T_{J₁⁺(u_i) - T_{J₂⁺(u_i)| = |T_{J₂⁺(u_i) - T_{J₁⁺(u_i)|,}}}}

$$\begin{aligned} |I_{J_1}^+(u_i) - I_{J_2}^+(u_i)| &= |I_{J_2}^+(u_i) - I_{J_1}^+(u_i)|, \\ |F_{J_1}^+(u_i) - F_{J_2}^+(u_i)| &= |F_{J_2}^+(u_i) - F_{J_1}^+(u_i)|, \\ |(1-T_{J_1}^+(u_i)) - (1-T_{J_2}^+(u_i))| &= |(1-T_{J_2}^+(u_i)) - (1-T_{J_1}^+(u_i))|, \\ |(1-I_{J_1}^+(u_i)) - (1-I_{J_2}^+(u_i))| &= |(1-I_{J_2}^+(u_i)) - (1-I_{J_1}^+(u_i))|, \\ |(1-F_{J_1}^+(u_i)) - (1-F_{J_2}^+(u_i))| &= |(1-F_{J_2}^+(u_i)) - (1-F_{J_1}^+(u_i))|, \end{aligned}$$

then

$$\begin{aligned} \sqrt{1+|T_{Q_1}^+(u_i)|^2} + \sqrt{1+|T_{Q_2}^+(u_i)|^2} &= \sqrt{1+|T_{Q_2}^+(u_i)|^2} + \sqrt{1+|T_{Q_1}^+(u_i)|^2}, \\ \sqrt{1+|I_{J_1}^+(u_i)|^2} + \sqrt{1+|I_{J_2}^+(u_i)|^2} &= \sqrt{1+|I_{J_2}^+(u_i)|^2} + \sqrt{1+|I_{J_1}^+(u_i)|^2}, \\ \sqrt{1+|F_{J_1}^+(u_i)|^2} + \sqrt{1+|F_{J_2}^+(u_i)|^2} &= \sqrt{1+|F_{J_2}^+(u_i)|^2} + \sqrt{1+|F_{J_1}^+(u_i)|^2}, \\ \sqrt{1+(1-T_{J_1}^+(u_i))^2} + \sqrt{1+(1-T_{J_2}^+(u_i))^2} &= \sqrt{1+(1-T_{J_2}^+(u_i))^2} + \sqrt{1+(1-T_{J_1}^+(u_i))^2}, \\ \sqrt{1+(1-I_{J_1}^+(u_i))^2} + \sqrt{1+(1-I_{J_2}^+(u_i))^2} &= \sqrt{1+(1-I_{J_2}^+(u_i))^2} + \sqrt{1+(1-I_{J_1}^+(u_i))^2}, \\ \sqrt{1+(1-F_{J_1}^+(u_i))^2} + \sqrt{1+(1-F_{J_2}^+(u_i))^2} &= \sqrt{1+(1-F_{J_2}^+(u_i))^2} + \sqrt{1+(1-F_{J_1}^+(u_i))^2}, \end{aligned}$$

∀ u_i ∈ U.

And w_i ∈ [0, 1], ∑_{i=1}ⁿ w_i = 1, w_i ≥ 0.

So, CE_{IN}^w(J₁, J₂) = CE_{IN}^w(J₂, J₁). Hence complete the proof.

4. Multi attribute group decision making strategy using IN-cross entropy measure in interval neutrosophic set environment

In this section we develop a novel MAGDM strategy based on proposed IN- cross entropy measure.

The MAGDM problem can be consider as follows:

Let A = {A₁, A₂, A₃, ..., A_m} and G = {G₁, G₂, G₃, ..., G_n} be the discrete set of alternatives and attribute respectively. Let W = {w₁, w₂, w₃, ..., w_n} be the weight vector of attributes G_j

(j = 1, 2, 3, ..., n), where w_j ≥ 0 and ∑_{j=1}ⁿ w_j = 1. Let

E = {E₁, E₂, E₃, ..., E_ρ} be the set of decision makers who are employ to evaluate the alternative. The weight vector of the decision makers E_k (k = 1, 2, 3, ..., ρ) is

λ = {λ₁, λ₂, λ₃, ..., λ_ρ} (where, λ ≥ 0 and ∑_{k=1}^ρ λ_k = 1), which can be

determined according to the decision makers expertise, judgment quality and decision making knowledge.

Now, we describe the steps of the proposed MAGDM strategy (See Figure 1.) using weighted IN-cross entropy measure.

MAGDM strategy using IN-cross entropy measure

Step: 1. Formulate the decision matrices

For MAGDM with INSS information, the rating values of the alternatives A_i ($i=1,2,3,\dots,m$) on the basis of criteria G_j ($j=1,2,3,\dots,n$) by the k -th decision maker can be expressed in INN as $a_{ij}^k = \langle [-T_{ij}^k, +T_{ij}^k], [-I_{ij}^k, +I_{ij}^k], [-F_{ij}^k, +F_{ij}^k] \rangle$ ($i = 1, 2, 3, \dots, m; j = 1, 2, 3, \dots, n; k = 1, 2, 3, \dots, \rho$). We arrange these rating values of alternatives provided by the decision makers in matrix form as follows:

$$M^k = \begin{pmatrix} & G_1 & G_2 & \dots & G_n \\ A_1 & a_{11}^k & a_{12}^k & \dots & a_{1n}^k \\ A_2 & a_{21}^k & a_{22}^k & \dots & a_{2n}^k \\ \dots & \dots & \dots & \dots & \dots \\ A_m & a_{m1}^k & a_{m2}^k & \dots & a_{mn}^k \end{pmatrix} \quad (3)$$

Step: 2. Formulate the weighted aggregated decision matrix

For obtaining one group decision, we aggregate all individual decision matrices (M^k) to an aggregated decision matrix (M) using interval-valued neutrosophic weighted averaging (INNWA) operator ([72]) as follows:

$$a_{ij} = \text{INNWA}_\lambda (a_{ij}^1, a_{ij}^2, a_{ij}^3, \dots, a_{ij}^\rho) = (\lambda_1 a_{ij}^1 \oplus \lambda_2 a_{ij}^2 \oplus \lambda_3 a_{ij}^3 \oplus \dots \oplus \lambda_\rho a_{ij}^\rho) < [1 - \prod_{k=1}^\rho (1 - T_{ij}^k)^{\lambda_k}, 1 - \prod_{k=1}^\rho (1 - I_{ij}^k)^{\lambda_k}], [\prod_{k=1}^\rho (-I_{ij}^k)^{\lambda_k}, \prod_{k=1}^\rho (+I_{ij}^k)^{\lambda_k}], [\prod_{k=1}^\rho (-F_{ij}^k)^{\lambda_k}, \prod_{k=1}^\rho (+F_{ij}^k)^{\lambda_k}] > \quad (4)$$

($i = 1, 2, 3, \dots, m; j = 1, 2, 3, \dots, n; k = 1, 2, 3, \dots, \rho$).

Therefore, the aggregated decision matrix is defined as follows:

$$M = \begin{pmatrix} & G_1 & G_2 & \dots & G_n \\ A_1 & a_{11} & a_{12} & \dots & a_{1n} \\ A_2 & a_{21} & a_{22} & \dots & a_{2n} \\ \dots & \dots & \dots & \dots & \dots \\ A_m & a_{m1} & a_{m2} & \dots & a_{mn} \end{pmatrix} \quad (5)$$

Step: 3. Formulate priori/ ideal decision matrix

In the MAGDM processes, the priori decision matrix is used to select the best alternatives among the set of collected feasible alternatives. In this decision making processes we use the following decision matrix as priori decision matrix.

$$P = \begin{pmatrix} & G_1 & G_2 & \dots & G_n \\ A_1 & a_{11} & a_{12} & \dots & a_{1n} \\ A_2 & a_{21} & a_{22} & \dots & a_{2n} \\ \dots & \dots & \dots & \dots & \dots \\ A_m & a_{m1} & a_{m2} & \dots & a_{mn} \end{pmatrix} \dots \dots \dots (6)$$

Where, $a_{ij} = \langle [1, 1], [0, 0], [0, 0] \rangle$ for benefit type attributes and $a_{ij} = \langle [0, 0], [1, 1], [1, 1] \rangle$ for cost type attributes, ($i = 1, 2, 3, \dots, m; j = 1, 2, 3, \dots, n$).

Step: 4. Formulate the weighted IN-cross entropy matrix

Using equation (2), we calculate weighted cross entropy value between aggregate matrix and priori matrix. The cross entropy value can be present in matrix form as follows:

$${}^{INS}M_{CE}^w = \begin{pmatrix} CE_{IN}^w(A_1) \\ CE_{IN}^w(A_2) \\ \dots \\ CE_{IN}^w(A_m) \end{pmatrix} \dots (7)$$

Step: 5. Rank the priority

Smaller value of the cross entropy reflect that an alternative is closer to the ideal alternative. Therefore, the priority order of all the alternatives can be determined according to the increasing order of the cross entropy values $CE_{IN}^w(A_i)$ ($i = 1, 2, 3, \dots, m$). Smallest cross entropy value indicates the best alternative and greatest cross entropy value indicates the worst alternative.

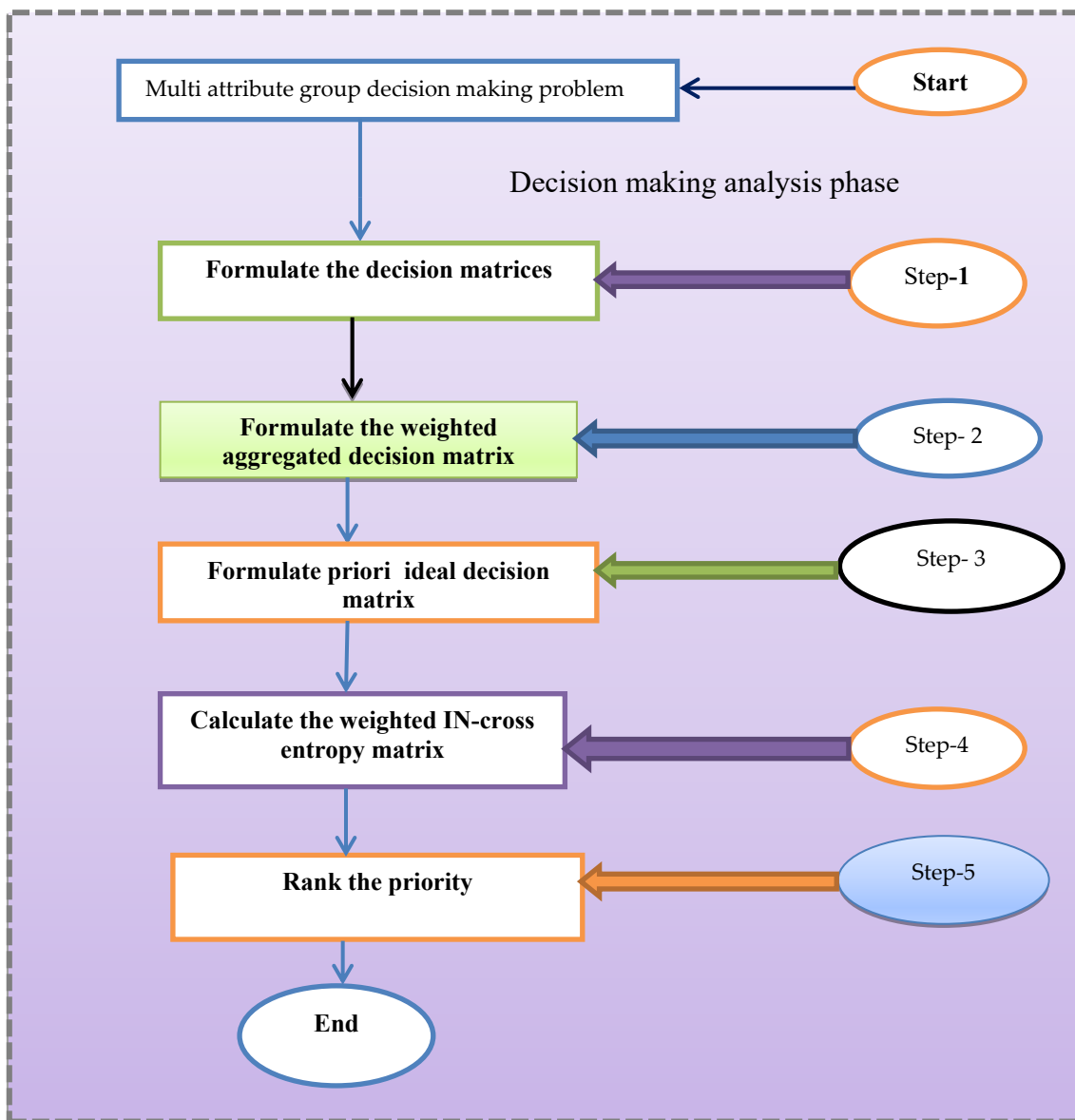

Figure.1 Decision making procedure of proposed MAGDM method

Illustrative example

In this section, we provide an illustrative example of MAGDM problems to reflect the validity and efficiency of our proposed strategy under INs environment. Now, we solve an illustrative example adapted from [9] for cultivation and analysis. A venture capital firm intends to make evaluation and selection to five enterprises with the investment potential:

- 1) Automobile company (A₁)
- 2) Military manufacturing enterprise (A₂)
- 3) TV media company (A₃)

- 4) Food enterprises (A₄)
 - 5) Computer software company (A₅)
- On the basis of four attributes namely:
- 1) Social and political factor (G₁)
 - 2) The environmental factor (G₂)
 - 3) Investment risk factor (G₃)
 - 4) The enterprise growth factor (G₄).

The investment firm makes a panel of three decision makers $E = \{E_1, E_2, E_3\}$ having their weights vector

$\lambda = \{0.42, 0.28, 0.30\}$ and weight vector of attributes is $W = \{0.24, 0.25, 0.23, 0.28\}$.

The steps of decision making strategy to rank alternatives are presented below:

Step: 1. Formulate the decision matrices

We represent the rating values of alternatives A_i ($i = 1, 2, 3, 4, 5$) with respects to the attributes G_j ($j = 1, 2, 3, 4$) provided by the decision-makers E_k ($k = 1, 2, 3$) in matrix form as follows:

Decision matrix for E_1 decision maker

$$M^1 = \begin{pmatrix} & G_1 & G_2 & G_3 & G_4 \\ A_1 & \langle [0.7, 0.9], [0.3, 4], [0.3, 4] \rangle & \langle [0.6, 7], [0.3, 4], [0.4, 5] \rangle & \langle [0.6, 7], [0.2, 3], [0.2, 4] \rangle & \langle [0.4, 5], [0.3, 4], [0.7, 8] \rangle \\ A_2 & \langle [0.6, 7], [0.1, 2], [0.2, 3] \rangle & \langle [0.7, 8], [0.2, 4], [0.2, 3] \rangle & \langle [0.7, 9], [0.5, 6], [0.4, 5] \rangle & \langle [0.7, 9], [0.1, 2], [0.1, 3] \rangle \\ A_3 & \langle [0.6, 8], [0.2, 4], [0.3, 4] \rangle & \langle [0.5, 7], [0.3, 4], [0.1, 2] \rangle & \langle [0.8, 9], [0.5, 7], [0.3, 6] \rangle & \langle [0.6, 7], [0.1, 3], [0.2, 3] \rangle \\ A_4 & \langle [0.4, 5], [0.7, 8], [0.6, 7] \rangle & \langle [0.3, 6], [0.2, 3], [0.3, 4] \rangle & \langle [0.6, 7], [0.1, 2], [0.4, 5] \rangle & \langle [0.4, 5], [0.3, 4], [0.6, 7] \rangle \\ A_5 & \langle [0.7, 8], [0.3, 4], [0.2, 3] \rangle & \langle [0.4, 5], [0.2, 4], [0.3, 5] \rangle & \langle [0.5, 6], [0.2, 4], [0.3, 4] \rangle & \langle [0.7, 9], [0.6, 7], [0.4, 5] \rangle \end{pmatrix} \quad (8)$$

Decision matrix for E_2 decision maker

$$M^2 = \begin{pmatrix} & G_1 & G_2 & G_3 & G_4 \\ A_1 & \langle [0.6, 7], [0.1, 2], [0.2, 3] \rangle & \langle [0.3, 5], [0.2, 4], [0.4, 5] \rangle & \langle [0.7, 9], [0.3, 4], [0.3, 5] \rangle & \langle [0.4, 6], [0.4, 5], [0.2, 3] \rangle \\ A_2 & \langle [0.4, 7], [0.2, 4], [0.3, 4] \rangle & \langle [0.6, 7], [0.2, 3], [0.3, 4] \rangle & \langle [0.5, 7], [0.1, 3], [0.3, 4] \rangle & \langle [0.4, 6], [0.3, 4], [0.2, 3] \rangle \\ A_3 & \langle [0.3, 6], [0.2, 4], [0.3, 4] \rangle & \langle [0.4, 5], [0.2, 3], [0.3, 5] \rangle & \langle [0.8, 9], [0.2, 5], [0.3, 4] \rangle & \langle [0.5, 6], [0.3, 5], [0.3, 6] \rangle \\ A_4 & \langle [0.5, 7], [0.3, 5], [0.1, 3] \rangle & \langle [0.5, 6], [0.1, 3], [0.4, 6] \rangle & \langle [0.4, 7], [0.1, 4], [0.3, 4] \rangle & \langle [0.6, 8], [0.3, 5], [0.3, 4] \rangle \\ A_5 & \langle [0.6, 9], [0.3, 4], [0.2, 3] \rangle & \langle [0.3, 6], [0.3, 4], [0.2, 5] \rangle & \langle [0.6, 8], [0.3, 5], [0.4, 6] \rangle & \langle [0.3, 5], [0.3, 4], [0.4, 5] \rangle \end{pmatrix} \quad (9)$$

Decision matrix for E_3 decision maker

$$M^3 = \begin{pmatrix} & G_1 & G_2 & G_3 & G_4 \\ A_1 & \langle [0.4, 7], [0.1, 2], [0.3, 5] \rangle & \langle [0.3, 6], [0.2, 4], [0.3, 4] \rangle & \langle [0.6, 7], [0.2, 4], [0.3, 5] \rangle & \langle [0.8, 9], [0.2, 4], [0.1, 3] \rangle \\ A_2 & \langle [0.3, 6], [0.4, 5], [0.4, 5] \rangle & \langle [0.7, 9], [0.1, 3], [0.3, 4] \rangle & \langle [0.5, 7], [0.2, 4], [0.2, 3] \rangle & \langle [0.6, 8], [0.2, 4], [0.3, 5] \rangle \\ A_3 & \langle [0.7, 8], [0.1, 3], [0.4, 5] \rangle & \langle [0.8, 9], [0.1, 3], [0.3, 4] \rangle & \langle [0.6, 8], [0.2, 3], [0.3, 4] \rangle & \langle [0.6, 7], [0.2, 3], [0.3, 4] \rangle \\ A_4 & \langle [0.6, 9], [0.2, 3], [0.2, 4] \rangle & \langle [0.5, 6], [0.1, 3], [0.2, 4] \rangle & \langle [0.3, 5], [0.1, 2], [0.2, 4] \rangle & \langle [0.5, 7], [0.2, 3], [0.3, 5] \rangle \\ A_5 & \langle [0.7, 8], [0.1, 3], [0.2, 3] \rangle & \langle [0.5, 6], [0.2, 4], [0.1, 3] \rangle & \langle [0.4, 6], [0.1, 3], [0.2, 4] \rangle & \langle [0.5, 7], [0.2, 3], [0.3, 5] \rangle \end{pmatrix} \quad (10)$$

Step: 2. Formulate the weighted aggregated decision matrix

Using equation (4), the aggregated decision matrix is presented below:

Aggregated decision matrix

$$M = \begin{pmatrix} & G_1 & G_2 & G_3 & G_4 \\ A_1 & \langle [0.6, 8], [0.2, 3], [0.3, 4] \rangle & \langle [0.5, 6], [0.2, 4], [0.4, 4] \rangle & \langle [0.6, 8], [0.2, 3], [0.2, 4] \rangle & \langle [0.6, 7], [0.3, 4], [0.3, 4] \rangle \\ A_2 & \langle [0.5, 7], [0.2, 3], [0.3, 4] \rangle & \langle [0.7, 8], [0.2, 3], [0.2, 4] \rangle & \langle [0.6, 8], [0.2, 4], [0.3, 4] \rangle & \langle [0.6, 8], [0.2, 3], [0.2, 3] \rangle \\ A_3 & \langle [0.6, 8], [0.2, 4], [0.3, 4] \rangle & \langle [0.6, 8], [0.2, 3], [0.2, 3] \rangle & \langle [0.8, 9], [0.3, 5], [0.3, 5] \rangle & \langle [0.6, 7], [0.2, 3], [0.2, 4] \rangle \\ A_4 & \langle [0.5, 7], [0.4, 5], [0.3, 5] \rangle & \langle [0.4, 6], [0.1, 3], [0.3, 4] \rangle & \langle [0.5, 6], [0.1, 2], [0.3, 4] \rangle & \langle [0.5, 7], [0.3, 4], [0.4, 5] \rangle \\ A_5 & \langle [0.7, 8], [0.2, 4], [0.2, 3] \rangle & \langle [0.4, 6], [0.2, 4], [0.2, 4] \rangle & \langle [0.5, 7], [0.2, 4], [0.3, 4] \rangle & \langle [0.6, 8], [0.4, 5], [0.4, 5] \rangle \end{pmatrix} \quad (11)$$

Step: 3. Formulate priori ideal decision matrix

Priori/ ideal decision matrix

$$M^1 = \begin{pmatrix} & G_1 & G_2 & G_3 & G_4 \\ A_1 & \langle [1, 1], [0, 0], [0, 0] \rangle & \langle [1, 1], [0, 0], [0, 0] \rangle & \langle [1, 1], [0, 0], [0, 0] \rangle & \langle [1, 1], [0, 0], [0, 0] \rangle \\ A_2 & \langle [1, 1], [0, 0], [0, 0] \rangle & \langle [1, 1], [0, 0], [0, 0] \rangle & \langle [1, 1], [0, 0], [0, 0] \rangle & \langle [1, 1], [0, 0], [0, 0] \rangle \\ A_3 & \langle [1, 1], [0, 0], [0, 0] \rangle & \langle [1, 1], [0, 0], [0, 0] \rangle & \langle [1, 1], [0, 0], [0, 0] \rangle & \langle [1, 1], [0, 0], [0, 0] \rangle \\ A_4 & \langle [1, 1], [0, 0], [0, 0] \rangle & \langle [1, 1], [0, 0], [0, 0] \rangle & \langle [1, 1], [0, 0], [0, 0] \rangle & \langle [1, 1], [0, 0], [0, 0] \rangle \\ A_5 & \langle [1, 1], [0, 0], [0, 0] \rangle & \langle [1, 1], [0, 0], [0, 0] \rangle & \langle [1, 1], [0, 0], [0, 0] \rangle & \langle [1, 1], [0, 0], [0, 0] \rangle \end{pmatrix} \quad (12)$$

Step: 4. Calculate the weighted IN-cross entropy matrix

Using equation (2), we calculate the interval neutrosophic weighted cross entropy values between ideal matrixes (12) and weighted aggregated decision matrix (11).

$${}^{IN}M_{CE}^w = \begin{pmatrix} 0.86 \\ 0.77 \\ 0.78 \\ 0.95 \\ 0.90 \end{pmatrix} \quad (13)$$

Step: . Rank the priority

The position of cross entropy values of alternatives arranging in increasing order is

0.77 0.78 0.86 0.90 0.95. Since, smallest values of cross entropy indicate the alternative is closer to

the ideal alternative. Thus the ranking priority of alternatives is $A_2 A_3 A_1 A_5 A_4$. Hence, military manufacturing enterprise (A_2) is the best alternative for investment.

In Figure 2, we draw a bar diagram to represent the cross entropy values of alternatives which shows that A_2 is the

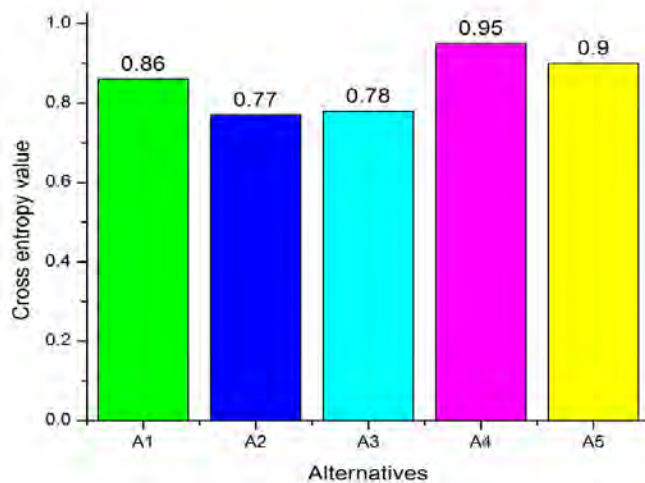

Figure.2. Bar diagram of alternatives versus cross entropy values of alternatives

Conclusion

In this paper we have defined IN-cross entropy measure in INS environment which is free from all the drawback of existence cross entropy measures under interval neutrosophic set environment. We have proved the basic properties of the cross entropy measures. We have also defined weighted IN- cross entropy measure and proved its basic properties. Based on the weighted IN-cross entropy measure, we have proposed a novel MAGDM strategy. Finally, we solve a MAGDM problem to show the feasibility and efficiency of the proposed MAGDM making strategy. The proposed IN-cross entropy based MAGDM strategy can be employed to solve a variety of problems such as logistics center selection, teacher selection, renewable energy selection, fault diagnosis, etc.

References

[1] L. A. Zadeh. Probability measures of fuzzy events. *Journal of Mathematical Analysis and Applications*, 23 (1968), 421–427.
 [2] B. Liu. A survey of entropy of fuzzy variables. *Journal of Uncertain Systems*, 1(1) (2007), 4–13.
 [3] X. G. Shang, and W. S. Jiang. A note on fuzzy information measures. *Pattern Recognition Letters*, 18 (1997), 425-432.

[4] K. T. Atanassov. Intuitionistic fuzzy sets. *Fuzzy Sets and Systems*, 20 (1986), 87-96.
 [5] M. D. Wade, A. Telik, D. S. Malik, and J. N. Mordeson. Political stability: analysis using TOPSIS and intuitionistic fuzzy sets. *New Mathematics and Natural Computation*, 13 (1) (2017), 1-11. doi: 10.1142/s1793005717500016.
 [6] S. Pramanik, and D. Mukhopadhyaya. Grey relational analysis based intuitionistic fuzzy multi-criteria group decision-making approach for teacher selection in higher education. *International Journal of Computer Applications*, 34 (10) (2011), 21-29. doi: 10.5120/4138-5985.
 [7] K. Mondal, and S. Pramanik. Intuitionistic fuzzy multi criteria group decision making approach to quality-brick selection problem. *Journal of Applied Quantitative Methods*, 9 (2) (2014), 35–50.
 [8] P. P. Dey, S. Pramanik, and B. C. Giri. Multi-criteria group decision making in intuitionistic fuzzy environment based on grey relational analysis for weaver selection in Khadi institution. *Journal of Applied Quantitative Methods*, 10 (4) (2015), 1–14.
 [9] X. He, and W. F. Liu. An intuitionistic fuzzy multi-attribute decision-making method with preference on alternatives. *Operations Research & Management Science*, 22 (2013), 36–40.

- [10] K. Mondal, S. Pramanik. Intuitionistic fuzzy similarity measure based on tangent function and its application to multi-attribute decision making. *Global Journal of Advanced Research*, 2 (2), (2015), 464-471.
- [11] P. Biswas, S. Pramanik, and B. C. Giri. A study on information technology professionals' health problem based on intuitionistic fuzzy cosine similarity measure. *Swiss Journal of Statistical and Applied Mathematics*, 2 (1) (2014), 44-50.
- [12] I. K. Vlachos, and G. D. Sergiadis. Intuitionistic fuzzy information applications to pattern recognition. *Pattern Recognition Letters*, 28 (2007), 197-206.
- [13] F. Smarandache. A unifying field of logics. *Neutrosophy: neutrosophic probability, set and logic*, American Research Press, Rehoboth, (1998).
- [14] H. Wang, F. Smarandache, Y. Zhang, and R. Sunderraman. Single valued neutrosophic sets. *Multi-space and Multi-structure*, 4 (2010), 410-413.
- [15] S. Pramanik, and T. K. Roy. Neutrosophic game theoretic approach to Indo-Pak conflict over Jammu-Kashmir. *Neutrosophic Sets and Systems*, 2 (2014) 82-101.
- [16] J. Ye. Single valued neutrosophic minimum spanning tree and its clustering method. *Journal of Intelligent Systems*, 23(2014), 311–324.
- [17] J. Ye. Clustering methods using distance-based similarity measures of single-valued neutrosophic sets. *Journal of Intelligent Systems*, 23 (2014), 379–389.
- [18] P. Biswas, S. Pramanik, and B. C. Giri. Entropy based grey relational analysis method for multi-attribute decision making under single valued neutrosophic assessments. *Neutrosophic Sets and Systems*, 2 (2014), 102–110.
- [19] P. Biswas, S. Pramanik, and B. C. Giri. A new methodology for neutrosophic multi-attribute decision making with unknown weight information. *Neutrosophic Sets and Systems*, 3 (2014), 42–52.
- [20] P. Biswas, S. Pramanik, and B. C. Giri. TOPSIS method for multi-attribute group decision-making under single valued neutrosophic environment. *Neural Computing and Applications*, (2015), doi: 10.1007/s00521-015-1891-2.
- [21] P. Biswas, S. Pramanik, and B. C. Giri. Aggregation of triangular fuzzy neutrosophic set information and its application to multi-attribute decision making. *Neutrosophic Sets and Systems*, 12 (2016), 20-40.
- [22] P. Biswas, S. Pramanik, and B. C. Giri. Value and ambiguity index based ranking method of single-valued trapezoidal neutrosophic numbers and its application to multi-attribute decision making. *Neutrosophic Sets and Systems* 12 (2016), 127-138.
- [23] P. Biswas, S. Pramanik, and B. C. Giri. Multi-attribute group decision making based on expected value of neutrosophic trapezoidal numbers. *New Trends in Neutrosophic Theory and Applications-Vol-II*. Pons Editions, Brussels (2017). In Press.
- [24] P. Biswas, S. Pramanik, and B. C. Giri. Non-linear programming approach for single-valued neutrosophic TOPSIS method. *New Mathematics and Natural Computation*, (2017). In Press.
- [25] I. Deli, and Y. Subas. A ranking method of single valued neutrosophic numbers and its applications to multi-attribute decision making problems. *International Journal of Machine Learning and Cybernetics*, (2016), doi:10.1007/s13042016-0505-3.
- [26] P. Ji , J. Q. Wang, and H. Y. Zhang. Frank prioritized Bonferroni mean operator with single-valued neutrosophic sets and its application in selecting third-party logistics providers. *Neural Computing and Applications*, (2016). doi:10.1007/s00521-016-2660-6.
- [27] A. Kharal. A neutrosophic multi-criteria decision making method. *New Mathematics and Natural Computation*, 10 (2014), 143–162.
- [28] R. X. Liang, J. Q. Wang, and L. Li. Multi-criteria group decision making method based on interdependent inputs of single valued trapezoidal neutrosophic information. *Neural Computing and Applications*, (2016), doi:10.1007/s00521-016-2672-2.
- [29] R. X. Liang, J. Q. Wang, and H. Y. Zhang. A multi-criteria decision-making method based on single-valued trapezoidal neutrosophic preference relations with complete weight information. *Neural Computing and Applications*, (2017). Doi: 10.1007/s00521-017-2925-8.
- [30] P. Liu, Y. Chu, Y. Li, and Y. Chen. Some generalized neutrosophic number Hamacher aggregation operators and their application to group decision making. *International Journal of Fuzzy System*, 16(2) (2014), 242–255.
- [31] P. D. Liu, and H. G. Li. Multiple attribute decision-making method based on some normal neutrosophic Bonferroni mean operators. *Neural Computing and Applications*, 28 (2017), 179–194.
- [32] P. Liu, and Y. Wang. Multiple attribute decision-making method based on single-valued neutrosophic normalized weighted Bonferroni mean. *Neural Computing and Applications*, 25(7) (2014), 2001–2010.
- [33] J. J. Peng, J. Q. Wang, J. Wang, H. Y. Zhang, and X. H. Chen. Simplified neutrosophic sets and their applications in multi-criteria group decision-making problems. *International Journal of Systems Science*, 47 (10) (2016), 2342-2358.

- [34] J. Peng, J. Wang, H. Zhang, and X. Chen. An outranking approach for multi-criteria decision-making problems with simplified neutrosophic sets. *Applied Soft Computing*, 25:336–346.
- [35] S. Pramanik, D. Banerjee, and B. C. Giri. Multi – criteria group decision making model in neutrosophic refined set and its application. *Global Journal of Engineering Science and Research Management*, 3(6) (2016), 12-18.
- [36] S. Pramanik, S. Dalapati, and T. K. Roy. Logistics center location selection approach based on neutrosophic multi-criteria decision making. *New Trends in Neutrosophic Theories and Applications*. Pons-Editions, Brussels, 2016, 161-174.
- [37] R. Sahin, and M. Karabacak. A multi attribute decision making method based on inclusion measure for interval neutrosophic sets. *International Journal of Engineering and Applied Sciences*, 2(2) (2014), 13–15.
- [38] R. Sahin, and A. Kucuk. Subsethood measure for single valued neutrosophic sets. *Journal of Intelligent and Fuzzy System*, (2014), doi:10.3233/IFS-141304.
- [39] R. Sahin, and P. Liu. Maximizing deviation method for neutrosophic multiple attribute decision making with incomplete weight information. *Neural Computing and Applications*, (2015), doi: 10.1007/s00521-015-1995-8.
- [40] M. Sodenkamp. Models, methods and applications of group multiple-criteria decision analysis in complex and uncertain systems. *Dissertation*, University of Paderborn, (2013), Germany.
- [41] J. Ye. Multi criteria decision-making method using the correlation coefficient under single-valued neutrosophic environment. *International Journal of General Systems*, 42 (2013), 386–394.
- [42] E. K. Zavadskas, R. Baušys, and M. Lazauskas. Sustainable assessment of alternative sites for the construction of a waste incineration plant by applying WASPAS method with single-valued neutrosophic set. *Sustainability*, 7 (2015), 15923-15936.
- [43] J. Ye. A multi criteria decision-making method using aggregation operators for simplified neutrosophic sets. *Journal of Intelligent and Fuzzy Systems*, 26 (2014), 2459–2466.
- [44] J. Ye. Trapezoidal neutrosophic set and its application to multiple attribute decision-making. *Neural Computing and Applications*, 26 (2015), 1157–1166.
- [45] J. Ye. Bidirectional projection method for multiple attribute group decision making with neutrosophic number. *Neural Computing and Applications*, (2015), doi: 10.1007/s00521-015-2123-5.
- [46] J. Ye. Projection and bidirectional projection measures of single valued neutrosophic sets and their decision – making method for mechanical design scheme. *Journal of Experimental and Theoretical Artificial Intelligence*, (2016), doi:10.1080/0952813X.2016.1259263.
- [47] S. Pramanik, P. Biswas, and B. C. Giri. Hybrid vector similarity measures and their applications to multi-attribute decision making under neutrosophic environment. *Neural Computing and Applications*, 28 (2017), 1163–1176. doi:10.1007/s00521-015-2125-3.
- [48] K. Mondal, and S. Pramanik. Multi-criteria group decision making approach for teacher recruitment in higher education under simplified Neutrosophic environment. *Neutrosophic Sets and Systems*, 6 (2014), 28-34.
- [49] K. Mondal, and S. Pramanik. Neutrosophic decision making model of school choice. *Neutrosophic Sets and Systems*, 7 (2015), 62-68.
- [50] H. D. Cheng, and Y. Guo. A new neutrosophic approach to image thresholding. *New Mathematics and Natural Computation*, 4 (2008), 291–308.
- [51] Y. Guo, and H. D. Cheng. New neutrosophic approach to image segmentation. *Pattern Recognition*, 42 (2009), 587–595.
- [52] Y. Guo, A. Sengur, and J. Ye. A novel image thresholding algorithm based on neutrosophic similarity score. *Measurement*, 58 (2014), 175–186.
- [53] J. Ye. Improved cosine similarity measures of simplified neutrosophic sets for medical diagnoses. *Artificial Intelligence in Medicine*, 63 (2015b), 171–179.
- [54] M. Abdel-Baset, I.M. Hezam, and F. Smarandache. Neutrosophic goal programming, *Neutrosophic Sets and Systems*, 11 (2016), 112-118.
- [55] P. Das, and T. K. Roy. Multi-objective non-linear programming problem based on neutrosophic optimization technique and its application in riser design problem. *Neutrosophic Sets and Systems*, 9 (2015), 88-95.
- [56] I.M. Hezam, M. Abdel-Baset, and F. Smarandache. Taylor series approximation to solve neutrosophic multiobjective programming problem. *Neutrosophic Sets and Systems*, 10 (2015), 39-45.
- [57] S. Pramanik. Neutrosophic multi-objective linear programming. *Global Journal of Engineering Science and Research Management*, 3(8) (2016), 36-46.
- [58] S. Pramanik. Neutrosophic linear goal programming, *Global Journal of Engineering Science and Research Management*, 3(7) (2016), 01-11.
- [59] R. Roy, and P. Das. A multi-objective production planning problem based on neutrosophic linear programming approach. *Internal Journal of Fuzzy Mathematical Archive*, 8(2) (2015), 81-91.

- [60] K. Mondal, and S. Pramanik. A study on problems of Hijras in West Bengal based on neutrosophic cognitive maps. *Neutrosophic Sets and Systems*, 5(2014), 21-26.
- [61] S. Pramanik, and S. Chakrabarti. A study on problems of construction workers in West Bengal based on neutrosophic cognitive maps. *International Journal of Innovative Research in Science, Engineering and Technology*, 2(11) (2013), 6387-6394.
- [62] J. Ye. Single valued neutrosophic cross-entropy for multi criteria decision making problems. *Applied Mathematical Modelling*, 38 (3) (2014), 1170 – 1175.
- [63] J. Ye. Improved cross entropy measures of single valued neutrosophic sets and interval neutrosophic sets and their multi criteria decision making methods. *Cybernetics and Information Technologies*, 15 (2015), 13-26. doi: 10.1515/cait-2015-0051.
- [64] H. Wang, F. Smarandache, Y. Q. Zhang, and R. Sunderraman. Interval neutrosophic sets and logic: theory and applications in computing. *Hexis; Neutrosophic book series*, No. 5 (2005).
- [65] S. Broumi, and F. Smarandache. Correlation coefficient of interval neutrosophic set. *Applied Mechanics and Materials*, 436 (2013), 511–517.
- [66] H.Y. Zhang, P. Ji, J. Wang, and X.H. Chen. An improved weighted correlation coefficient based on integrated weight for interval neutrosophic sets and its application in multi-criteria decision-making problems. *International Journal of Computational Intelligence Systems*, 8 (2015), 1027–1043.
- [67] H.Y. Zhang, J.Q. Wang, and X.H. Chen. An outranking approach for multi-criteria decision-making problems with interval-valued neutrosophic sets. *Neural Computing and Applications*, 17 (2016), 615–627.
- [68] Y. Huang, G. Wei, and C. Wei. VIKOR method for interval neutrosophic multiple attribute group decision-making. *Information* 8 (2017), 144; doi:10.3390/info8040144.
- [69] J. Ye. Similarity measures between interval neutrosophic sets and their applications in multi criteria decision-making. *Journal of Intelligent and Fuzzy Systems*, 26 (2014), 165–172.
- [70] S. Pramanik and K. Mondal. Interval neutrosophic multi-attribute decision-making based on grey relational analysis. *Neutrosophic Sets and Systems*, 9 (2015), 13-22.
- [71] A. W. Zhao, J. G. Du, and H. J. Guan. Interval valued neutrosophic sets and multi-attribute decision-making based on generalized weighted aggregation operator. *Journal of Intelligent and Fuzzy Systems*, 29 (2015), 2697–2706.
- [72] H.Y. Zhang, J.Q. Wang, and X. H. Chen. Interval neutrosophic sets and their application in multi-criteria decision making problems. *The Scientific World Journal*, 2014 (2014), Article ID 645953. <http://dx.doi.org/10.1155/2014/645953>.
- [73] R. Sahin. Cross-entropy measure on interval neutrosophic sets and its applications in multi criteria decision making. *Neural Computing and Applications*, 2015, doi 10.1007/s00521-015-2131-5.
- [74] Z. P. Tian, H. Y. Zhang, J. Wang, J. Q. Wang, and X. H. Chen. Multi-criteria decision-making method based on a cross-entropy with interval neutrosophic sets. *International Journal of Systems Science*, 2015. doi:10.1080/00207721.2015.1102359.

Generalized Single Valued Triangular Neutrosophic Numbers and Aggregation Operators for Application to Multi-attribute Group Decision Making

Mehmet Şahin, Abdullah Kargin, Florentin Smarandache

Mehmet Şahin, Abdullah Kargin, Florentin Smarandache (2018). Generalized Single Valued Triangular Neutrosophic Numbers and Aggregation Operators for Application to Multi-attribute Group Decision Making. In F. Smarandache, S. Pramanik (eds.): *New Trends in Neutrosophic Theory and Applications*, II, 51-84

ABSTRACT

In this study we define the generalizing single valued triangular neutrosophic number. In addition, single valued neutrosophic numbers are transformed into single valued triangular neutrosophic numbers according to the values of truth, indeterminacy and falsity. Furthermore, we extended the Hamming distance given for triangular intuitionistic fuzzy numbers to single valued triangular neutrosophic numbers. We have defined new score functions based on the Hamming distance. We then extended some operators given for intuitionistic fuzzy numbers to single valued triangular neutrosophic numbers. Finally, we developed a new solution to multi-attribute group decision making problems for single valued neutrosophic numbers with operators and scoring functions and we checked the suitability of our new method by comparing the results we obtained with previously obtained results. We have also mentioned for the first time that there is a solution for multi-attribute group decision making problems for single valued triangular neutrosophic numbers.

Keywords: Hamming distance, single valued neutrosophic number, generalized single valued neutrosophic number, multi-attribute group decision making

1. INTRODUCTION

There are many uncertainties in daily life. However, classical mathematical logic is insufficient to account for these uncertainties. In order to explain these uncertainties mathematically and to use them in practice, Zadeh (1965) first proposed a fuzzy logic theory. Although fuzzy logic is used in many field applications, the lack of membership is not explained because it is only a membership function. Then Atanassov (1986) introduced the theory of intuitionistic fuzzy logic. In this theory, he states membership, non-membership and indeterminacy, and has been used in many fields and applications. Later, Li (2010) defined triangular intuitionistic fuzzy numbers. However, in the intuitionistic fuzzy logic, membership, non-membership, and indeterminacy are all completely dependent in each other. Finally, Smarandache (1998 and 2016) proposed the neutrosophic set theory, which is the more general form of intuitionistic fuzzy logic. Many studies have been done on this theory

and have been used in many field applications. In this theory, the values of truth, indeterminacy and falsity of a situation are considered and these three values are defined completely independently of each other Smarandache, Wang, Zhang, and Sunderraman (2010) defined single valued neutrosophic sets. Subas (2015) defined single valued triangular neutrosophic numbers is a special form of single valued neutrosophic numbers. Many uncertainties and complex situations arise in decision-making applications. It is impossible to come up with these uncertainties and complexities, especially with known numbers. For example, in multi-attribute decision making (MADM), multiple objects are evaluated according to more than one property and there is a choice of the most suitable one. Particularly in multi-attribute group decision making (MAGDM), the most appropriate object selection is made according to the data received from more than one decision maker. Multi - attribute decision making group and multi-attribute decision making problems have been found by many researchers using various methods using intuitionistic fuzzy numbers. For example; Wan and Dong (2015) studied trapezoidal intuitionistic fuzzy numbers and application to multi attribute group decision making. Wan, Wang, Li and Dong (2016) studied triangular intuitionistic fuzzy numbers and application to multi attribute group decision making. Biswas, Pramanik, and Giri (2016) have studied trapezoidal fuzzy neutrosophic numbers and its application to multi-attribute decision making (MADM) and triangular fuzzy neutrosophic set and its application to multi-attribute decision making (MADM).

However, these methods and solutions are not suitable for neutrosophic sets and neutrosophic numbers. Therefore, many researchers have tried to find solutions to multi-attribute group decision making and multi-attribute decision making problems using neutrosophic sets and neutrosophic numbers. Recently, Liu and Luo (2017) have proposed multi-attribute group decision making problems using power aggregation operators of simplifield neutrosophic sets ; Sahin, Uluçay, Kargın and Ecemiş (2017) studied centroid single valued triangular neutrosophic numbers and their applications in multi-attribute decision making; Sahin and Liu (2017) used multi-criteria decision making problems using exponential operations of simplest neutrosophic numbers; Liu and Li have produced solutions to multi-criteria decision making problems with some normal neutrosophic Bonferroni mean operators (2017). Smarandache (2016) have produced neutrosophic overset, neutrosophic underset, and neutrosophic offset. Biswas, Pramanik, and Giri (2016) have studied single-valued trapezoidal neutrosophic numbers and its application to multi-attribute decision making (MADM). Ye (2015) have studied multi-attribute decision making (MADM).

Subas (2015) defined $\tilde{a} = ((a_1, b_1, c_1); w_{\tilde{a}}, u_{\tilde{a}}, y_{\tilde{a}})$ as a positive single valued triangular neutrosophic number for $a_1, b_1, c_1 \in \mathbb{R}^+$ or a negative single valued triangular neutrosophic number for $a_1, b_1, c_1 \in \mathbb{R}^-$. However, the condition $a_1, b_1, c_1 \in \mathbb{R} - \{0\}$ has not been defined. This narrows the applications of single valued triangular neutrosophic numbers. In this study we first define the condition of $a_1, b_1, c_1 \in \mathbb{R}$ for single valued triangular neutrosophic numbers and gave basic operations on these conditions. These basic operations we have given also include operations where $a_1, b_1, c_1 \in \mathbb{R}^-$ and $a_1, b_1, c_1 \in \mathbb{R}^+$. Thus, by generalizing single valued triangular neutrosophic numbers, we made it more useful. Then, single valued neutrosophic numbers were converted to single valued triangular neutrosophic numbers. Thus, we made single valued neutrosophic numbers more useful by carrying single valued triangular neutrosophic numbers, which have rich application fields. We then extended the Hamming distance for triangular intuitionistic fuzzy numbers to single valued triangular neutrosophic numbers and showed some properties. Besides, we defined the scoring and certainty functions for the single-valued neutrosophic numbers and for the single valued triangular neutrosophic numbers based on the Hamming distance according to the truth, indeterminacy and falsity values. We compared the results of the score and certainty functions we obtained with the score and certainty functions. We also made some operators for triangular intuitionistic fuzzy numbers available for single valued triangular neutrosophic numbers and showed some properties of these operators. We mentioned similarities and differences with the operators. Finally, we have found a new solution to the multi-attribute group decision making problems by using the transformation of single valued neutrosophic numbers, new scoring functions and using the operators we have obtained. Since the transformations and the scoring functions are separate according to the values of truth, indeterminacy and falsity, we obtained results separately for each of the three values for multi-attribute group decision making problems. We compared our result with the result of a multi-attribute group decision making problem for single valued neutrosophic numbers. We have checked the applicability of the method we have achieved.

In this study, we gave some definitions of triangular intuitionistic fuzzy numbers and related definitions about neutrosophic sets, single valued neutrosophic sets and numbers, single valued triangular neutrosophic numbers, and some related definitions in section 2. In Section 3, we generalized the single valued triangular neutrosophic numbers to make them more usable and described the basic operations. In Section 3, we gave transformations for single valued neutrosophic numbers based on their truth, indeterminacy and falsity values. In section 4, we made the Hamming distance for triangular intuitionistic fuzzy numbers available for single valued triangular neutrosophic numbers and showed some properties.

In addition, we have separately defined the score and certainty functions according to the values of truth, indeterminacy and falsity depending on the generalized Hamming distance and compared with the score and certainty functions given before. In Section 5, we made some operators for triangular intuitionistic fuzzy numbers available with single valued triangular neutrosophic numbers, and we showed some properties of these operators and discussed the similarities and differences with the previously given operators . In Section 6, we gave a new method for solving multi-attribute group decision making problems for single valued neutrosophic numbers using the transform functions and operators that we have achieved in this work. In Section 7, we looked at the applicability of our method by comparing the result of a previous multi-attribute group decision making problem with the result of our method. Finally, in Section 8 we briefly discussed the results of our work.

. PRELIMINARIES

Definition .1: A triangular intuitionistic fuzzy number $\tilde{a} = ((\underline{a}, a, \bar{a}); w_{\tilde{a}}, u_{\tilde{a}})$ is a special intuitionistic fuzzy set on the real number set R, whose truth-membership and falsity-membership functions are defined as follows:

$$\mu_{\tilde{a}}(x) = \begin{cases} (x-\underline{a})w_{\tilde{a}}/(a-\underline{a}) & (\underline{a} \leq x < a) \\ w_{\tilde{a}} & (x = a) \\ (\bar{a}-x)w_{\tilde{a}}/(\bar{a}-a) & (a < x \leq \bar{a}) \\ 0 & \text{otherwise} \end{cases}$$

$$\nu_{\tilde{a}}(x) = \begin{cases} (a-x+u_{\tilde{a}}(x-\underline{a}))/(\bar{a}-\underline{a}) & (\underline{a} \leq x < a) \\ u_{\tilde{a}} & (x = a) \\ (x-a+u_{\tilde{a}}(\bar{a}-x))/(\bar{a}-a) & (a < x \leq \bar{a}) \\ 1 & \text{otherwise} \end{cases}$$

respectively. (Li, 2010)

Definition . . : Let $\tilde{a}_i = ((\underline{a}_i, a_i, \bar{a}_i); w_{\tilde{a}_i}, u_{\tilde{a}_i})$ (i = 1,2) be two triangular intuitionistic fuzzy numbers. The Hamming distance between \tilde{a}_1 and \tilde{a}_2 is

$$d_n(\tilde{a}_1, \tilde{a}_2) = \frac{1}{16} [|(1 + w_{\tilde{a}_1} - u_{\tilde{a}_1})\underline{a}_1 - (1 + w_{\tilde{a}_2} - u_{\tilde{a}_2})\underline{a}_1| + |(1 + w_{\tilde{a}_1} - u_{\tilde{a}_1})a_1 - (1 + w_{\tilde{a}_2} - u_{\tilde{a}_2})a_2| + |(1 + w_{\tilde{a}_1} - u_{\tilde{a}_1})\bar{a}_1 - (1 + w_{\tilde{a}_2} - u_{\tilde{a}_2})\bar{a}_2|]$$

(Wan, Wang, Li and Dang, 2016)

Definition . : Let $\tilde{a}_i = \langle (\underline{a}_i, a_i, \overline{a}_i); w_{\tilde{a}_i}, u_{\tilde{a}_i} \rangle$ (i = 1,2,3, ...,n) be a collection of triangular intuitionistic fuzzy numbers. Then triangular intuitionistic fuzzy generalized ordered weighted averaging operator is defined as;

$$\text{TIFGOWA} : \mathbf{U}^n \rightarrow \mathbf{U}, \text{TIFGOWA} (\tilde{a}_1, \tilde{a}_2, \dots, \tilde{a}_n) = \mathbf{g}^{-1} \left(\sum_{j=1}^n w_j \mathbf{g}(\tilde{a}_{(\sigma(j))}) \right)$$

Where \mathbf{g} is a continuous strictly monotone increasing function, $w = (w_1, w_2, \dots, w_n)^T$ is a weight vector associated with the TIFGOWA operator, with $w_j \geq 0, j = 1,2,3, \dots, n$ and $\sum_{j=1}^n w_j = 1$ and $((1), (2), \dots, (n))$ is a permutation of $(1,2, \dots, n)$ such that $\tilde{a}_{(\sigma(i))} \geq \tilde{a}_{(\sigma(i+1))}$ for all i . (Wan, Wang, Li and Dang, 2016)

Definition . : Let $\tilde{a}_i = \langle (\underline{a}_i, a_i, \overline{a}_i); w_{\tilde{a}_i}, u_{\tilde{a}_i} \rangle$ (i = 1,2,3, ...,n) be a collection of triangular intuitionistic fuzzy numbers. Then triangular intuitionistic fuzzy generalized hybrid weighted averaging operator is defined as;

$$\text{TIFGHWA} : \mathbf{U}^n \rightarrow \mathbf{U}, \text{TIFGHWA} (\tilde{a}_1, \tilde{a}_2, \dots, \tilde{a}_n) = \mathbf{g}^{-1} \left(\sum_{j=1}^n w_j \mathbf{g}(\tilde{b}_{(\sigma(j))}) \right)$$

Where \mathbf{g} is a continuous strictly monotone increasing function, $w = (w_1, w_2, \dots, w_n)^T$ is a weight vector associated with the TIFGHWA operator, with $w_i \geq 0, i = 1,2,3, \dots, n, \sum_{i=1}^n w_i = 1, (\omega_1, \omega_2, \dots, \omega_n)^T$ is a weight vector of \tilde{a}_i and $\tilde{b}_{(\sigma(i))} = \omega_1 \cdot \tilde{a}_i$. (Wan, Wang, Li and Dang, 2016)

Definition . : Let U be an universe of discourse then the neutrosophic set A is on object having the form $A = \{ (x: T_A(x), I_A(x), F_A(x)) \mid x \in U \}$ where the functions $T, I, F: U \rightarrow]-0, 1^+[$ respectively the degree of membership, the degree of indeterminacy and degree of non-membership of the element $x \in U$ to the set A with the condition.

$$0^- \leq T_{A(x)} + I_{A(x)} + F_{A(x)} \leq 3^+ . \text{ (Smarandache, 2016)}$$

Definition . : Let U be an universe of discourse then the single valued neutrosophic set A is on object having the form $A = \{ (x: T_A(x), I_A(x), F_A(x)) \mid x \in U \}$ where the functions $T, I, F: U \rightarrow [0, 1]$ respectively the degree of membership, the degree of indeterminacy and degree of non-membership of the element $x \in U$ to the set A with the condition.

$$0 \leq T_{A(x)} + I_{A(x)} + F_{A(x)} \leq 3$$

For convenience, we can simply use $x = (T, I, F)$ to represent an element x in single valued neutrosophic numbers and the element x can be called a single valued neutrosophic number. (Wang, Smarandache, Zhang, Sunderraman, 2010)

Definition . : Let $x = (T, I, F)$ be a single valued triangular neutrosophic number and then

- 1) $sc(x) = T+1-I+1-F;$
- 2) $ac(x) = T-F;$

Where $sc(x)$ represents the score function of the single valued neutrosophic number and $ac(x)$ represent certainty function of the single valued neutrosophic number. (Liu, Chu, Li and Chen, 2014)

Definition . : Let $x = (T_1, I_1, F_1)$ and $y = (T_2, I_2, F_2)$ be two single valued neutrosophic numbers, the comparison approach can be defined as follows.

- 1) If $sc(x) > sc(y)$, then x is greater than y and denoted $x \succ y$.
- 2) If $sc(x) = sc(y)$ and $ac(x) > ac(y)$, then x is greater than y and denoted $x \succ y$.
- 3) If $sc(x) = sc(y)$ and $ac(x) = ac(y)$, then x is equal to y and denoted by $x \sim y$.

(Liu, Chu, Li and Chen, 2014)

Definition . : Let $w_{\tilde{a}}, u_{\tilde{a}}, y_{\tilde{a}} \in [0, 1]$. A single valued triangular neutrosophic number $\tilde{a} = ((a_1, b_1, c_1); w_{\tilde{a}}, u_{\tilde{a}}, y_{\tilde{a}})$ is a special neutrosophic set on the real number set R , whose truth-membership, indeterminacy-membership and falsity-membership functions are defined as follows:

$$\mu_{\tilde{a}}(x) = \begin{cases} (x-a_1)w_{\tilde{a}}/(b_1-a_1) & (a_1 \leq x < b_1) \\ w_{\tilde{a}} & (x = b_1) \\ (c_1-x)w_{\tilde{a}}/(c_1-b_1) & (b_1 < x \leq c_1) \\ 0 & otherwise \end{cases}$$

$$v_{\tilde{a}}(x) = \begin{cases} (b_1-x+u_{\tilde{a}}(x-a_1))/(b_1-a_1) & (a_1 \leq x < b_1) \\ u_{\tilde{a}} & (x = b_1) \\ (x-b_1+u_{\tilde{a}}(c_1-x))/(c_1-b_1) & (b_1 < x \leq c_1) \\ 1 & otherwise \end{cases}$$

$$\lambda_{\tilde{a}}(x) = \begin{cases} (b_1-x+y_{\tilde{a}}(x-a_1))/(b_1-a_1) & (a_1 \leq x < b_1) \\ y_{\tilde{a}} & (x = b_1) \\ (x-b_1+y_{\tilde{a}}(c_1-x))/(c_1-b_1) & (b_1 < x \leq c_1) \\ 1 & otherwise \end{cases}$$

respectively.

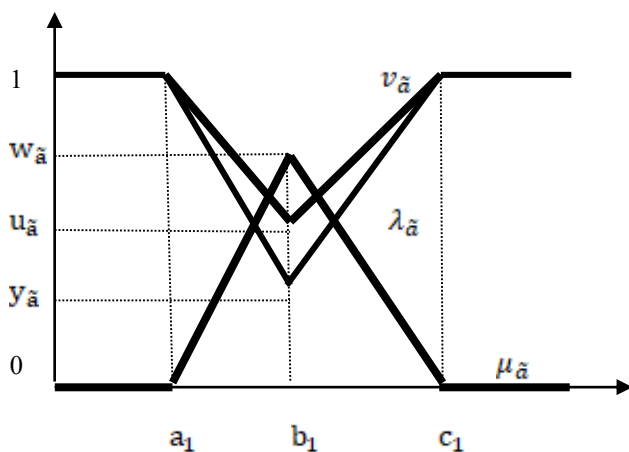

Fig. 1. $(\tilde{a} = ((a_1, b_1, c_1); w_{\tilde{a}}, u_{\tilde{a}}, y_{\tilde{a}}))$ single valued triangular neutrosophic number

If $a_1 \geq 0$ and at least $c_1 \geq 0$, then $\tilde{a} = \langle (a_1, b_1, c_1); w_{\tilde{a}}, u_{\tilde{a}}, y_{\tilde{a}} \rangle$ is called a positive triangular neutrosophic number, denoted by $\tilde{a} \geq 0$. Likewise, If $c_1 \leq 0$ and at least $a_1 \leq 0$, then $\tilde{a} = \langle (a_1, b_1, c_1); w_{\tilde{a}}, u_{\tilde{a}}, y_{\tilde{a}} \rangle$ is called a negative triangular neutrosophic number, denoted by $\tilde{a} \leq 0$.

A triangular neutrosophic number $\tilde{a} = \langle (a_1, b_1, c_1); w_{\tilde{a}}, u_{\tilde{a}}, y_{\tilde{a}} \rangle$ may express an ill-known quantity about a , which is approximately equal to a . (Subas, 2017)

Definition .1 : Let $\tilde{a} = \langle (a_1, b_1, c_1); w_{\tilde{a}}, u_{\tilde{a}}, y_{\tilde{a}} \rangle$ and $\tilde{b} = \langle (a_2, b_2, c_2); w_{\tilde{b}}, u_{\tilde{b}}, y_{\tilde{b}} \rangle$, be two single valued triangular neutrosophic numbers and $\gamma \neq 0$ be any real number. Then,

1. $\tilde{a} + \tilde{b} = \langle (a_1 + a_2, b_1 + b_2, c_1 + c_2); w_{\tilde{a}} \wedge w_{\tilde{b}}, u_{\tilde{a}} \vee u_{\tilde{b}}, y_{\tilde{a}} \vee y_{\tilde{b}} \rangle$
2. $\tilde{a} - \tilde{b} = \langle (a_1 - a_2, b_1 - b_2, c_1 - c_2); w_{\tilde{a}} \wedge w_{\tilde{b}}, u_{\tilde{a}} \vee u_{\tilde{b}}, y_{\tilde{a}} \vee y_{\tilde{b}} \rangle$
3. $\tilde{a} \tilde{b} = \begin{cases} \langle (a_1 a_2, b_1 b_2, c_1 c_2); w_{\tilde{a}} \wedge w_{\tilde{b}}, u_{\tilde{a}} \vee u_{\tilde{b}}, y_{\tilde{a}} \vee y_{\tilde{b}} \rangle & (c_1 > 0, c_2 > 0) \\ \langle (a_1 c_2, b_1 b_2, c_1 a_2); w_{\tilde{a}} \wedge w_{\tilde{b}}, u_{\tilde{a}} \vee u_{\tilde{b}}, y_{\tilde{a}} \vee y_{\tilde{b}} \rangle & (c_1 < 0, c_2 > 0) \\ \langle (c_1 c_2, b_1 b_2, a_1 a_2); w_{\tilde{a}} \wedge w_{\tilde{b}}, u_{\tilde{a}} \vee u_{\tilde{b}}, y_{\tilde{a}} \vee y_{\tilde{b}} \rangle & (c_1 < 0, c_2 < 0) \end{cases}$
4. $\tilde{a} / \tilde{b} = \begin{cases} \langle (a_1/c_2, b_1/b_2, c_1/a_2); w_{\tilde{a}} \wedge w_{\tilde{b}}, u_{\tilde{a}} \vee u_{\tilde{b}}, y_{\tilde{a}} \vee y_{\tilde{b}} \rangle & (c_1 > 0, c_2 > 0) \\ \langle (c_1/c_2, b_1/b_2, a_1/a_2); w_{\tilde{a}} \wedge w_{\tilde{b}}, u_{\tilde{a}} \vee u_{\tilde{b}}, y_{\tilde{a}} \vee y_{\tilde{b}} \rangle & (c_1 < 0, c_2 > 0) \\ \langle (c_1/a_2, b_1/b_2, a_1/c_2); w_{\tilde{a}} \wedge w_{\tilde{b}}, u_{\tilde{a}} \vee u_{\tilde{b}}, y_{\tilde{a}} \vee y_{\tilde{b}} \rangle & (c_1 < 0, c_2 < 0) \end{cases}$
5. $\gamma \tilde{a} = \begin{cases} \langle (\gamma a_1, \gamma b_1, \gamma c_1); w_{\tilde{a}}, u_{\tilde{a}}, y_{\tilde{a}} \rangle & (\gamma > 0) \\ \langle (\gamma c_1, \gamma b_1, \gamma a_1); w_{\tilde{a}}, u_{\tilde{a}}, y_{\tilde{a}} \rangle & (\gamma < 0) \end{cases}$
6. $\tilde{a}^{-1} = \langle (1/c_1, 1/b_1, 1/a_1); w_{\tilde{a}}, u_{\tilde{a}}, y_{\tilde{a}} \rangle$ ($\tilde{a} \neq 0$). (Subas, 2017)

Definition .11: We defined a method to compare any two single valued triangular neutrosophic numbers which is based on the score function and the certainty function. Let $\tilde{a}_1 = \langle (a_1, b_1, c_1); w_{\tilde{a}_1}, u_{\tilde{a}_1}, y_{\tilde{a}_1} \rangle$ be any single valued triangular neutrosophic number, then

$$S(\tilde{a}_1) = \frac{1}{8}[a_1 + b_1 + c_1] \times (2 + w_{\tilde{a}_1} - u_{\tilde{a}_1} - y_{\tilde{a}_1})$$

and

$$A(\tilde{a}_1) = \frac{1}{8}[a_1 + b_1 + c_1] \times (2 + w_{\tilde{a}_1} - u_{\tilde{a}_1} + y_{\tilde{a}_1})$$

is called the score and certainty degrees of \tilde{a}_1 , respectively. (Subas, 2017)

Definition .1 : Let \tilde{a}_1 and \tilde{a}_2 be two single valued triangular neutrosophic numbers,

1. If $S(\tilde{a}_1) < S(\tilde{a}_2)$, then \tilde{a}_1 is smaller than \tilde{a}_2 , denoted by $\tilde{a}_1 < \tilde{a}_2$.

2. If $S(\tilde{a}_1) \leq S(\tilde{a}_2)$;

(a) If $A(\tilde{a}_1) \leq A(\tilde{a}_2)$, then \tilde{a}_1 is smaller than \tilde{a}_2 , denoted by $\tilde{a}_1 < \tilde{a}_2$.

(b) If $A(\tilde{a}_1) = A(\tilde{a}_2)$, then \tilde{a}_1 and \tilde{a}_2 are the same, denoted by $\tilde{a}_1 = \tilde{a}_2$.

(Subas, 2017)

Definition .1 : Let $\tilde{a}_j = \langle (a_j, b_j, c_j); w_{\tilde{a}_j}, u_{\tilde{a}_j}, y_{\tilde{a}_j} \rangle$ ($j = 1, 2, 3, \dots, n$) be a collection of single valued triangular neutrosophic numbers. Then single valued triangular neutrosophic weight averaging operator (SVTNWAO) is defined as;

$$\text{SVTNWAO: } \bar{N}_R^n \rightarrow \bar{N}_R, \quad \text{SVTNWAO}(\tilde{a}_1, \tilde{a}_2, \dots, \tilde{a}_n) = \sum_{j=1}^n w_j \tilde{a}_j$$

where $w = (w_1, w_2, \dots, w_n)^T$ is a weight vector associated with the SVTNWAO operator, with $w_j \geq 0$, $j = 1, 2, 3, \dots, n$ and $\sum_{j=1}^n w_j = 1$. (Subas, 2017)

Definition .1 : Let $\tilde{a}_j = \langle (a_j, b_j, c_j); w_{\tilde{a}_j}, u_{\tilde{a}_j}, y_{\tilde{a}_j} \rangle$ ($j = 1, 2, 3, \dots, n$) be a collection of single valued triangular neutrosophic numbers and $w = (w_1, w_2, \dots, w_n)^T$ is a weight vector associated with $w_j \geq 0$, and $\sum_{j=1}^n w_j = 1$. Then single valued triangular neutrosophic ordered averaging operator (SVTNOAO) is defined as;

$$\text{SVTNOAO: } \bar{N}_R^n \rightarrow \bar{N}_R, \quad \text{SVTNOAO}(\tilde{a}_1, \tilde{a}_2, \dots, \tilde{a}_n) = \sum_{j=1}^n w_j \tilde{b}_j$$

where $\tilde{a}_k = \langle (a_k, b_k, c_k); w_{\tilde{a}_k}, u_{\tilde{a}_k}, y_{\tilde{a}_k} \rangle$, $k \in \{1, 2, 3, \dots, n\}$ is the single valued triangular neutrosophic number obtained by using the score and certainty function and For $\tilde{b}_j; \tilde{a}_j = \langle (a_j, b_j, c_j); w_{\tilde{a}_j}, u_{\tilde{a}_j}, y_{\tilde{a}_j} \rangle$ is the maximum value of K . (Subas, 2017)

. GENERALIZED SINGLE VALUED TRIANGULAR NEUTROSOPHIC NUMBERS

In this section we will generalize single valued triangular neutrosophic numbers to make them more usable. Because definition 2.9 for a single valued triangular neutrosophic number $\tilde{a} = \langle (a_1, b_1, c_1); w_{\tilde{a}}, u_{\tilde{a}}, y_{\tilde{a}} \rangle$; The values a_1, b_1, c_1 must either be negative real numbers or positive real numbers. However, some of these values are not defined as negative real numbers or some of them are positive real numbers. This situation narrows the field of use of single valued triangular neutrosophic numbers. We will abolish this limited situation with definitions given in this section.

Definition .1: Let $w_{\tilde{a}}, u_{\tilde{a}}, y_{\tilde{a}} \in [0, 1]$ and $a_1, b_1, c_1 \in \mathbb{R} - \{0\}$. A generalized single valued triangular neutrosophic number $\tilde{a} = \langle (a_1, b_1, c_1); w_{\tilde{a}}, u_{\tilde{a}}, y_{\tilde{a}} \rangle$ is a special neutrosophic set on the real number set \mathbb{R} , whose truth-membership, indeterminacy-membership and falsity-membership functions are defined as follows:

$$\mu_{\tilde{a}}(x) \begin{cases} (x-a_1)w_{\tilde{a}}/(b_1-a_1) & (a_1 \leq x < b_1) \\ w_{\tilde{a}} & (x = b_1) \\ (c_1-x)w_{\tilde{a}}/(c_1-b_1) & (b_1 < x \leq c_1) \\ 0 & \text{otherwise} \end{cases}$$

$$v_{\tilde{a}}(x) \begin{cases} (b_1-x+u_{\tilde{a}}(x-a_1))/(b_1-a_1) & (a_1 \leq x < b_1) \\ u_{\tilde{a}} & (x = b_1) \\ (x-b_1+u_{\tilde{a}}(c_1-x))/(c_1-b_1) & (b_1 < x \leq c_1) \\ 1 & \text{otherwise} \end{cases}$$

$$\lambda_{\tilde{a}}(x) \begin{cases} (b_1-x+y_{\tilde{a}}(x-a_1))/(b_1-a_1) & (a_1 \leq x < b_1) \\ y_{\tilde{a}} & (x = b_1) \\ (x-b_1+y_{\tilde{a}}(c_1-x))/(c_1-b_1) & (b_1 < x \leq c_1) \\ 1 & \text{otherwise} \end{cases}$$

respectively.

The most important and only difference of this definition from definition 2.9 is that $a_1, b_1, c_1 \in -\{0\}$. For example $\langle(-2, -1, 3); w_{\tilde{a}}, u_{\tilde{a}}, y_{\tilde{a}}\rangle, \langle(-2, 1, 3); w_{\tilde{a}}, u_{\tilde{a}}, y_{\tilde{a}}\rangle$ cannot be single valued triangular neutrosophic numbers according to the previous definition, it is a generalized single valued triangular neutrosophic number according to this new definition. In addition, negative single valued triangular neutrosophic numbers and positive single valued triangular neutrosophic numbers are covered by single valued triangular neutrosophic numbers according to this definition.

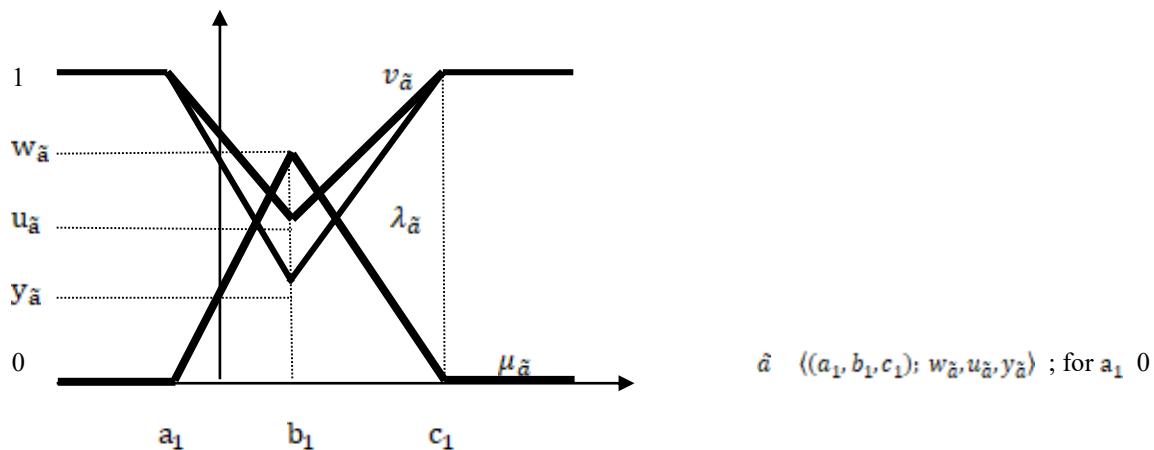

Fig. : $(\tilde{a} \langle(a_1, b_1, c_1); w_{\tilde{a}}, u_{\tilde{a}}, y_{\tilde{a}}\rangle ; \text{for } a_1 < 0, \text{ generalized single valued triangular neutrosophic number})$

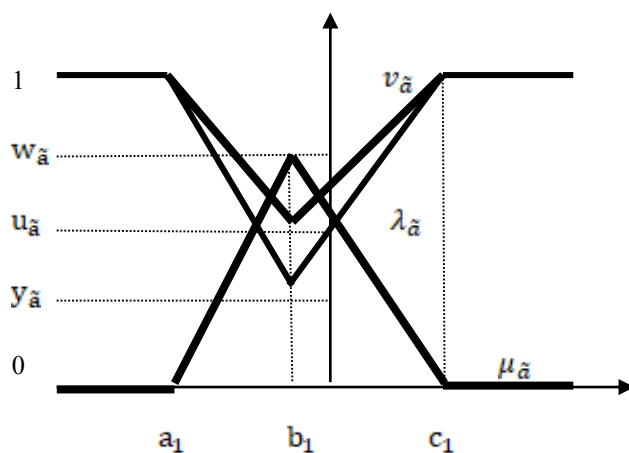

Fig. : $(\tilde{a} \langle(a_1, b_1, c_1); w_{\tilde{a}}, u_{\tilde{a}}, y_{\tilde{a}}\rangle ; a_1, b_1 < 0 \text{ generalized single valued triangular neutrosophic number})$

Now let's define the basic operations for generalized single valued triangular neutrosophic numbers.

Degrees of membership / indeterminacy / nonmembership $\in [0, 1]$ have been proposed by Smarandache since 2007.

Definition 2.10 : Let $\tilde{a} = \langle (a_1, b_1, c_1); w_{\tilde{a}}, u_{\tilde{a}}, y_{\tilde{a}} \rangle$ and $\tilde{b} = \langle (a_2, b_2, c_2); w_{\tilde{b}}, u_{\tilde{b}}, y_{\tilde{b}} \rangle$, be two generalized single valued triangular neutrosophic numbers and $\gamma \in [0, 1]$ be any real number. Then,

$$1. \tilde{a} + \tilde{b} = \langle (a_1 + a_2, b_1 + b_2, c_1 + c_2); w_{\tilde{a}} \wedge w_{\tilde{b}}, u_{\tilde{a}} \vee u_{\tilde{b}}, y_{\tilde{a}} \vee y_{\tilde{b}} \rangle$$

$$2. \tilde{a} - \tilde{b} = \langle (a_1 - a_2, b_1 - b_2, c_1 - c_2); w_{\tilde{a}} \wedge w_{\tilde{b}}, u_{\tilde{a}} \vee u_{\tilde{b}}, y_{\tilde{a}} \vee y_{\tilde{b}} \rangle$$

3. For the set $\mathcal{L} = \{a_1 a_2, c_1 c_2, a_1 c_2, c_1 a_2\}$;

λ_1 : is the minimum value of \mathcal{L}

λ_2 : be the largest element of \mathcal{L} ;

$$\tilde{a} \tilde{b} = \langle (\lambda_1, b_1 b_2, \lambda_2); w_{\tilde{a}} \wedge w_{\tilde{b}}, u_{\tilde{a}} \vee u_{\tilde{b}}, y_{\tilde{a}} \vee y_{\tilde{b}} \rangle .$$

4. For the set $\mathcal{L} = \{a_1/a_2, c_1/c_2, a_1/c_2, c_1/a_2\}$;

λ_1 : is the minimum value of \mathcal{L} ,

λ_2 : be the largest element of \mathcal{L} ;

$$\tilde{a} / \tilde{b} = \langle (\lambda_1, b_1/b_2, \lambda_2); w_{\tilde{a}} \wedge w_{\tilde{b}}, u_{\tilde{a}} \vee u_{\tilde{b}}, y_{\tilde{a}} \vee y_{\tilde{b}} \rangle$$

5. For the set $\mathcal{L} = \{\gamma a_1, \gamma c_1\}$;

λ_1 : is the minimum value of \mathcal{L} ,

λ_2 : be the largest element of \mathcal{L} ;

$$\gamma \tilde{a} = \langle (\lambda_1, \gamma b_1, \lambda_2); w_{\tilde{a}} \wedge w_{\tilde{b}}, u_{\tilde{a}} \vee u_{\tilde{b}}, y_{\tilde{a}} \vee y_{\tilde{b}} \rangle$$

6. For the set $\mathcal{L} = \{1/a_1, 1/c_1\}$;

λ_1 : is the minimum value of \mathcal{L} ,

λ_2 : be the largest element of \mathcal{L} ;

$$\tilde{a}^{-1} = \langle (\lambda_1, 1/b_1, \lambda_2); w_{\tilde{a}} \wedge w_{\tilde{b}}, u_{\tilde{a}} \vee u_{\tilde{b}}, y_{\tilde{a}} \vee y_{\tilde{b}} \rangle$$

These operations also give the same results as the operations in definition 2.10. Namely, these operations are a generalized description of the operations in Definition 2.10.

TRANSFORMED SINGLE VALUED TRIANGULAR NEUTROSOPHIC NUMBERS, HAMMING DISTANCE AND A NEW SCORE FUNCTION BASED ON HAMMING DISTANCE FOR GENERALIZED SINGLE VALUED TRIANGULAR NEUTROSOPHIC NUMBER

In this section, we define single valued triangular neutrosophic numbers by transforming single valued neutrosophic numbers in the definition 2.6. However, since single valued neutrosophic numbers consist of independent truth, falsity, and indeterminacy states, we have defined a separate transformation for each case. However, we have generalized the Hamming distance to single valued triangular neutrosophic numbers in the definition 2.2 for the triangular intuitionistic fuzzy numbers and gave some properties. We then defined new score functions based on the Hamming distance measure. We compared the results obtained with these scoring functions to the results of the scoring functions in definition 2.7 and definition 2.11.

Definition .1 $\tilde{a} (T_{\tilde{a}}, I_{\tilde{a}}, F_{\tilde{a}})$ conversion to a generalized single valued triangular neutrosophic number according to the truth value for a single valued neutrosophic number;

$$a_1 = T_{\tilde{a}} - I_{\tilde{a}} - F_{\tilde{a}}$$

$$b_1 = a_1 + (1 + T_{\tilde{a}} - F_{\tilde{a}}) - 1 + 2 T_{\tilde{a}} - I_{\tilde{a}} - 2 F_{\tilde{a}}$$

$$c_1 = b_1 + (1 + T_{\tilde{a}} - I_{\tilde{a}}) - 2 + 3 T_{\tilde{a}} - 2 I_{\tilde{a}} - 2 F_{\tilde{a}} \quad \text{and}$$

$$T_{\tilde{a}} = w_{\tilde{a}}, I_{\tilde{a}} = u_{\tilde{a}}, F_{\tilde{a}} = y_{\tilde{a}} ;$$

$$\tilde{a} (T_{\tilde{a}}, I_{\tilde{a}}, F_{\tilde{a}}) \xrightarrow{\text{Transformed}} \tilde{a}_T ((a_1, b_1, c_1); w_{\tilde{a}}, u_{\tilde{a}}, y_{\tilde{a}}). \text{ Namely}$$

$$\tilde{a}_T ((T_{\tilde{a}} - I_{\tilde{a}} - F_{\tilde{a}}, 1 + 2 T_{\tilde{a}} - I_{\tilde{a}} - 2 F_{\tilde{a}}, 2 + 3 T_{\tilde{a}} - 2 I_{\tilde{a}} - 2 F_{\tilde{a}}); T_{\tilde{a}}, I_{\tilde{a}}, F_{\tilde{a}}).$$

Thus we obtained the number of \tilde{a}_T generalized single valued triangular neutrosophic number from \tilde{a} single valued neutrosophic number. Hence, $1 + T_{\tilde{a}} - F_{\tilde{a}} \geq 0$ and $1 + T_{\tilde{a}} - I_{\tilde{a}} \geq 0$ for $a_1, b_1 \leq c_1$. Because of this each \tilde{a}_T number obtained from the definition of single valued neutrosophic number is a generalized single valued triangular neutrosophic number.

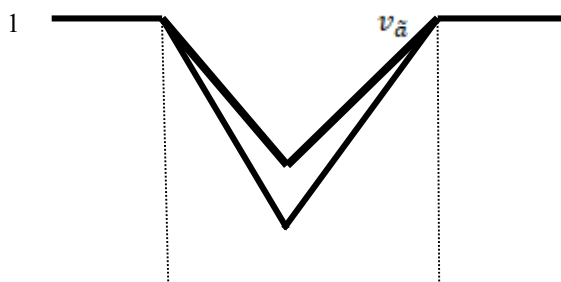

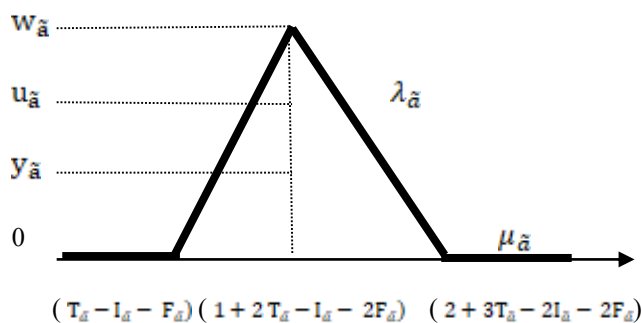

Fig. : $(\tilde{a}_T \langle (a_1, b_1, c_1); w_a, u_a, y_a \rangle)$ generalized single valued triangular neutrosophic number)

Definition . $\tilde{a} (T_a, I_a, F_a)$ conversion to a generalized single valued triangular neutrosophic number according to the indeterminacy value for the single valued neutrosophic number;

$$a_1 = T_a - I_a - F_a$$

$$b_1 = a_1 + (1 + I_a - F_a) = 1 + T_a - 2F_a$$

$$c_1 = b_1 + (1 + I_a - T_a) = 2 + I_a - 2F_a \quad \text{and}$$

$$T_a = w_a, I_a = u_a, F_a = y_a ;$$

transformed

$$\tilde{a} (T_a, I_a, F_a) \rightleftarrows \tilde{a}_I \langle (a_1, b_1, c_1); w_a, u_a, y_a \rangle. \text{ Namely}$$

$$\tilde{a}_I \langle (T_a - I_a - F_a, 1 + T_a - 2F_a, 2 + I_a - 2F_a); T_a, I_a, F_a \rangle.$$

Thus we obtained the number of \tilde{a}_I generalized single valued triangular neutrosophic number from \tilde{a} single valued neutrosophic number. Hence $1 + I_a - F_a \geq 0$ and $1 + I_a - T_a \geq 0$; $a_1 \leq b_1 \leq c_1$. Because of this each \tilde{a}_I number obtained from the definition of single valued neutrosophic number is a generalized single valued triangular neutrosophic number.

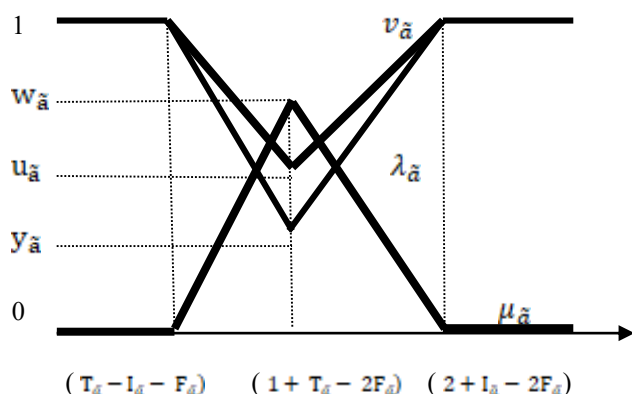

Fig. : $(\tilde{a}_I \langle (a_1, b_1, c_1); w_a, u_a, y_a \rangle)$ generalized single valued triangular neutrosophic number)

Definition . $\tilde{a} (T_{\tilde{a}}, I_{\tilde{a}}, F_{\tilde{a}})$ conversion to a generalized single valued triangular neutrosophic number according to the falsity value for the single valued neutrosophic number;

$$a_1 = T_{\tilde{a}} - I_{\tilde{a}} - F_{\tilde{a}}$$

$$b_1 = a_1 + (1 + F_{\tilde{a}} - I_{\tilde{a}}) = 1 + T_{\tilde{a}} - 2I_{\tilde{a}}$$

$$c_1 = b_1 + (1 + F_{\tilde{a}} - T_{\tilde{a}}) = 2 + F_{\tilde{a}} - 2I_{\tilde{a}} \quad \text{and}$$

$$T_{\tilde{a}} = w_{\tilde{a}}, I_{\tilde{a}} = u_{\tilde{a}}, F_{\tilde{a}} = y_{\tilde{a}} ;$$

Transformed

$$\tilde{a} (T_{\tilde{a}}, I_{\tilde{a}}, F_{\tilde{a}}) \xrightarrow{\hspace{2cm}} \tilde{a}_F ((a_1, b_1, c_1); w_{\tilde{a}}, u_{\tilde{a}}, y_{\tilde{a}}). \text{ Namely}$$

$$\tilde{a}_F ((T_{\tilde{a}} - I_{\tilde{a}} - F_{\tilde{a}}, 1 + T_{\tilde{a}} - 2I_{\tilde{a}}, 2 + F_{\tilde{a}} - 2I_{\tilde{a}}); T_{\tilde{a}}, I_{\tilde{a}}, F_{\tilde{a}}).$$

Thus we obtained the number of \tilde{a}_F generalized single valued triangular neutrosophic number from \tilde{a} single valued neutrosophic number. Hence, $1 + F_{\tilde{a}} - I_{\tilde{a}} \geq 0$ and $1 + F_{\tilde{a}} - T_{\tilde{a}} \geq 0$ for $a_1 \leq b_1 \leq c_1$. Because of this each \tilde{a}_F number obtained from the definition of single valued neutrosophic number is a generalized single valued triangular neutrosophic number.

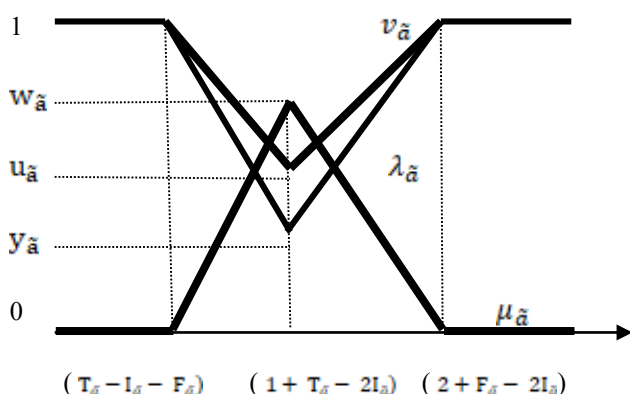

Fig. $(\tilde{a}_F ((a_1, b_1, c_1); w_{\tilde{a}}, u_{\tilde{a}}, y_{\tilde{a}}))$ generalized single valued triangular neutrosophic number

Definition . :

a) $\tilde{a} (T_{\tilde{a}}, I_{\tilde{a}}, F_{\tilde{a}})$ ideal generalized single valued triangular neutrosophic number according to the truth value for single valued neutrosophic numbers;

$$T_{\tilde{a}} = 1, I_{\tilde{a}} = 0 \text{ and } F_{\tilde{a}} = 0; \tilde{a}_T^i$$

$$((T_{\tilde{a}} - I_{\tilde{a}} - F_{\tilde{a}}, 1 + 2T_{\tilde{a}} - I_{\tilde{a}} - 2F_{\tilde{a}}, 2 + 3T_{\tilde{a}} - 2I_{\tilde{a}} - 2F_{\tilde{a}}); T_{\tilde{a}}, I_{\tilde{a}}, F_{\tilde{a}})) = ((1, 3, 5); 1, 0, 0).$$

b) $\tilde{a} (T_{\tilde{a}}, I_{\tilde{a}}, F_{\tilde{a}})$ ideal generalized single valued triangular neutrosophic number according to the indeterminacy value for single valued neutrosophic numbers;

$$T_{\tilde{\alpha}} = 1, I_{\tilde{\alpha}} = 0 \text{ and } F_{\tilde{\alpha}} = 0; \tilde{\alpha}_1^i$$

$$\langle (T_{\tilde{\alpha}} - I_{\tilde{\alpha}} - F_{\tilde{\alpha}}, 1 + T_{\tilde{\alpha}} - 2F_{\tilde{\alpha}}, 2 + I_{\tilde{\alpha}} - 2F_{\tilde{\alpha}}); T_{\tilde{\alpha}}, I_{\tilde{\alpha}}, F_{\tilde{\alpha}} \rangle \quad \langle (1,2,3); 1,0,0 \rangle.$$

c) $\tilde{\alpha} = (T_{\tilde{\alpha}}, I_{\tilde{\alpha}}, F_{\tilde{\alpha}})$ ideal generalized single valued triangular neutrosophic number according to the falsity value for single valued neutrosophic numbers;

$$T_{\tilde{\alpha}} = 1, I_{\tilde{\alpha}} = 0 \text{ and } F_{\tilde{\alpha}} = 0; \tilde{\alpha}_1^i$$

$$\langle (T_{\tilde{\alpha}} - I_{\tilde{\alpha}} - F_{\tilde{\alpha}}, 1 + T_{\tilde{\alpha}} - 2I_{\tilde{\alpha}}, 2 + F_{\tilde{\alpha}} - 2I_{\tilde{\alpha}}); T_{\tilde{\alpha}}, I_{\tilde{\alpha}}, F_{\tilde{\alpha}} \rangle \quad \langle (1,2,3); 1,0,0 \rangle.$$

It can be seen from b) and c), $\tilde{\alpha}_1^i = \tilde{\alpha}_1^i$.

Definition 4.5 : Let $\tilde{\alpha}_1 = \langle (a_1, b_1, c_1); w_{\tilde{\alpha}_1}, u_{\tilde{\alpha}_1}, y_{\tilde{\alpha}_1} \rangle$ and $\tilde{\alpha}_2 = \langle (a_2, b_2, c_2); w_{\tilde{\alpha}_2}, u_{\tilde{\alpha}_2}, y_{\tilde{\alpha}_2} \rangle$ be two generalized single valued triangular neutrosophic numbers. The Hamming distance between $\tilde{\alpha}_1$ and $\tilde{\alpha}_2$ is

$$d_n(\tilde{\alpha}_1, \tilde{\alpha}_2) = \frac{1}{12} [|(2 + w_{\tilde{\alpha}_1} - u_{\tilde{\alpha}_1} - y_{\tilde{\alpha}_1})a_1 - (2 + w_{\tilde{\alpha}_2} - u_{\tilde{\alpha}_2} - y_{\tilde{\alpha}_2})a_2| + |(2 + w_{\tilde{\alpha}_1} - u_{\tilde{\alpha}_1} - y_{\tilde{\alpha}_1})b_1 - (2 + w_{\tilde{\alpha}_2} - u_{\tilde{\alpha}_2} - y_{\tilde{\alpha}_2})b_2| + |(2 + w_{\tilde{\alpha}_1} - u_{\tilde{\alpha}_1} - y_{\tilde{\alpha}_1})c_1 - (2 + w_{\tilde{\alpha}_2} - u_{\tilde{\alpha}_2} - y_{\tilde{\alpha}_2})c_2|]$$

This definition is the expansion of the Hamming distance given to the triangular intuitionistic fuzzy numbers given in the definition to generalized single valued triangular neutrosophic numbers.

Proposition 4.6 : The Hamming distance $d_n(\tilde{\alpha}_1, \tilde{\alpha}_2)$ satisfies the following properties.

- 1) $d_n(\tilde{\alpha}_1, \tilde{\alpha}_2) \geq 0$
- 2) $d_n(\tilde{\alpha}_1, \tilde{\alpha}_2) = 0$, if $\tilde{\alpha}_1 = \tilde{\alpha}_2$, for all $\tilde{\alpha}_1, \tilde{\alpha}_2 \in \bar{N}_R$
- 3) $d_n(\tilde{\alpha}_1, \tilde{\alpha}_2) = d_n(\tilde{\alpha}_2, \tilde{\alpha}_1)$
- 4) Let $\tilde{\alpha}_j = \langle (a_j, b_j, c_j); w_{\tilde{\alpha}_j}, u_{\tilde{\alpha}_j}, y_{\tilde{\alpha}_j} \rangle$, $\tilde{b}_j = \langle (e_j, f_j, g_j); w_{\tilde{b}_j}, u_{\tilde{b}_j}, y_{\tilde{b}_j} \rangle$ and $\tilde{c}_j = \langle (h_j, l_j, m_j); w_{\tilde{c}_j}, u_{\tilde{c}_j}, y_{\tilde{c}_j} \rangle$ be three single valued triangular neutrosophic numbers.

If $a_j \leq e_j \leq h_j, b_j \leq f_j \leq l_j, c_j \leq g_j \leq m_j, w_{\tilde{\alpha}_j} \leq w_{\tilde{b}_j} \leq w_{\tilde{c}_j}, u_{\tilde{\alpha}_j} \leq u_{\tilde{b}_j} \leq u_{\tilde{c}_j}, y_{\tilde{\alpha}_j} \leq y_{\tilde{b}_j} \leq y_{\tilde{c}_j}$ then;

$$d_n(\tilde{\alpha}_j, \tilde{c}_j) \leq d_n(\tilde{\alpha}_j, \tilde{b}_j) \quad \text{and} \quad d_n(\tilde{\alpha}_j, \tilde{c}_j) \leq d_n(\tilde{b}_j, \tilde{c}_j)$$

Proof: The proof of 1), 2), 3) can easily be done by the definition 4.5. Now let's prove 4).

Let's show that $d_n(\tilde{\alpha}_j, \tilde{c}_j) \leq d_n(\tilde{\alpha}_j, \tilde{b}_j)$.

$$d_n(\tilde{\alpha}_j, \tilde{c}_j)$$

$$\frac{1}{12} [|(2 + w_{\tilde{a}_j} - u_{\tilde{a}_j} - y_{\tilde{a}_j}) a_j - (2 + w_{\tilde{c}_j} - u_{\tilde{c}_j} - y_{\tilde{c}_j}) h_j| + |(2 + w_{\tilde{a}_j} - u_{\tilde{a}_j} - y_{\tilde{a}_j}) b_j - (2 + w_{\tilde{c}_j} - u_{\tilde{c}_j} - y_{\tilde{c}_j}) l_j| + |(2 + w_{\tilde{a}_j} - u_{\tilde{a}_j} - y_{\tilde{a}_j}) c_j - (2 + w_{\tilde{c}_j} - u_{\tilde{c}_j} - y_{\tilde{c}_j}) m_j|]$$

And $a_j, e_j, h_j, b_j, f_j, l_j, c_j, g_j, m_j, w_{\tilde{a}_j}, w_{\tilde{b}_j}, w_{\tilde{c}_j}, u_{\tilde{a}_j}, u_{\tilde{b}_j}, u_{\tilde{c}_j}, y_{\tilde{a}_j}, y_{\tilde{b}_j}, y_{\tilde{c}_j}$ hence;

$2 + w_{\tilde{a}_j} - u_{\tilde{a}_j} - y_{\tilde{a}_j} \geq 2 + w_{\tilde{c}_j} - u_{\tilde{c}_j} - y_{\tilde{c}_j}$ and a_j, e_j, h_j . Hence;

$$(2 + w_{\tilde{a}_j} - u_{\tilde{a}_j} - y_{\tilde{a}_j}) a_j \leq (2 + w_{\tilde{c}_j} - u_{\tilde{c}_j} - y_{\tilde{c}_j}) h_j. \text{ Similarly;}$$

$$(2 + w_{\tilde{a}_j} - u_{\tilde{a}_j} - y_{\tilde{a}_j}) b_j \leq (2 + w_{\tilde{c}_j} - u_{\tilde{c}_j} - y_{\tilde{c}_j}) l_j;$$

$$(2 + w_{\tilde{a}_j} - u_{\tilde{a}_j} - y_{\tilde{a}_j}) c_j \leq (2 + w_{\tilde{c}_j} - u_{\tilde{c}_j} - y_{\tilde{c}_j}) m_j. \text{ From here;}$$

$d_n(\tilde{a}_j, \tilde{c}_j)$

$$\frac{1}{12} [((2 + w_{\tilde{c}_j} - u_{\tilde{c}_j} - y_{\tilde{c}_j}) h_j - (2 + w_{\tilde{a}_j} - u_{\tilde{a}_j} - y_{\tilde{a}_j}) a_j) + ((2 + w_{\tilde{c}_j} - u_{\tilde{c}_j} - y_{\tilde{c}_j}) l_j - (2 + w_{\tilde{a}_j} - u_{\tilde{a}_j} - y_{\tilde{a}_j}) b_j) + ((2 + w_{\tilde{c}_j} - u_{\tilde{c}_j} - y_{\tilde{c}_j}) m_j - (2 + w_{\tilde{a}_j} - u_{\tilde{a}_j} - y_{\tilde{a}_j}) c_j)] \dots (1)$$

$d_n(\tilde{a}_j, \tilde{b}_j)$

$$\frac{1}{12} [|(2 + w_{\tilde{a}_j} - u_{\tilde{a}_j} - y_{\tilde{a}_j}) a_j - (2 + w_{\tilde{b}_j} - u_{\tilde{b}_j} - y_{\tilde{b}_j}) e_j| + |(2 + w_{\tilde{a}_j} - u_{\tilde{a}_j} - y_{\tilde{a}_j}) b_j - (2 + w_{\tilde{b}_j} - u_{\tilde{b}_j} - y_{\tilde{b}_j}) f_j| + |(2 + w_{\tilde{a}_j} - u_{\tilde{a}_j} - y_{\tilde{a}_j}) c_j - (2 + w_{\tilde{b}_j} - u_{\tilde{b}_j} - y_{\tilde{b}_j}) g_j|]$$

and $a_j, e_j, h_j, b_j, f_j, l_j, c_j, g_j, m_j, w_{\tilde{a}_j}, w_{\tilde{b}_j}, w_{\tilde{c}_j}, u_{\tilde{a}_j}, u_{\tilde{b}_j}, u_{\tilde{c}_j}, y_{\tilde{a}_j}, y_{\tilde{b}_j}, y_{\tilde{c}_j}$ hence;

$2 + w_{\tilde{a}_j} - u_{\tilde{a}_j} - y_{\tilde{a}_j} \geq 2 + w_{\tilde{b}_j} - u_{\tilde{b}_j} - y_{\tilde{b}_j}$ and a_j, e_j, h_j hence;

$$(2 + w_{\tilde{a}_j} - u_{\tilde{a}_j} - y_{\tilde{a}_j}) a_j \leq (2 + w_{\tilde{b}_j} - u_{\tilde{b}_j} - y_{\tilde{b}_j}) e_j. \text{ Similarly,}$$

$$(2 + w_{\tilde{a}_j} - u_{\tilde{a}_j} - y_{\tilde{a}_j}) b_j \leq (2 + w_{\tilde{b}_j} - u_{\tilde{b}_j} - y_{\tilde{b}_j}) f_j;$$

$$(2 + w_{\tilde{a}_j} - u_{\tilde{a}_j} - y_{\tilde{a}_j}) c_j \leq (2 + w_{\tilde{b}_j} - u_{\tilde{b}_j} - y_{\tilde{b}_j}) g_j. \text{ From here;}$$

$d_n(\tilde{a}_j, \tilde{b}_j)$

$$\frac{1}{12} [((2 + w_{\tilde{b}_j} - u_{\tilde{b}_j} - y_{\tilde{b}_j}) e_j - (2 + w_{\tilde{a}_j} - u_{\tilde{a}_j} - y_{\tilde{a}_j}) a_j) +$$

$$\begin{aligned} & ((2 + w_{\tilde{b}_j} - u_{\tilde{b}_j} - y_{\tilde{b}_j}) f_j - (2 + w_{\tilde{a}_j} - u_{\tilde{a}_j} - y_{\tilde{a}_j}) b_j) + \\ & ((2 + w_{\tilde{b}_j} - u_{\tilde{b}_j} - y_{\tilde{b}_j}) g_j - (2 + w_{\tilde{a}_j} - u_{\tilde{a}_j} - y_{\tilde{a}_j}) c_j) \end{aligned} \tag{2}$$

From (1) and (2) $d_n(\tilde{a}_j, \tilde{c}_j) - d_n(\tilde{a}_j, \tilde{b}_j)$

$$\begin{aligned} & \frac{1}{12} [(2 + w_{\tilde{e}_j} - u_{\tilde{e}_j} - y_{\tilde{e}_j}) h_j - (2 + w_{\tilde{a}_j} - u_{\tilde{a}_j} - y_{\tilde{a}_j}) a_j] - (2 + w_{\tilde{b}_j} - u_{\tilde{b}_j} - y_{\tilde{b}_j}) e_j + \\ & (2 + w_{\tilde{a}_j} - u_{\tilde{a}_j} - y_{\tilde{a}_j}) a_j] \\ & + \frac{1}{12} [(2 + w_{\tilde{a}_j} - u_{\tilde{a}_j} - y_{\tilde{a}_j}) b_j - (2 + w_{\tilde{e}_j} - u_{\tilde{e}_j} - y_{\tilde{e}_j}) l_j - (2 + w_{\tilde{b}_j} - u_{\tilde{b}_j} - y_{\tilde{b}_j}) f_j + \\ & (2 + w_{\tilde{a}_j} - u_{\tilde{a}_j} - y_{\tilde{a}_j}) b_j] \\ & + \frac{1}{12} [(2 + w_{\tilde{e}_j} - u_{\tilde{e}_j} - y_{\tilde{e}_j}) m_j - (2 + w_{\tilde{a}_j} - u_{\tilde{a}_j} - y_{\tilde{a}_j}) c_j - (2 + w_{\tilde{b}_j} - u_{\tilde{b}_j} - y_{\tilde{b}_j}) g_j + \\ & (2 + w_{\tilde{a}_j} - u_{\tilde{a}_j} - y_{\tilde{a}_j}) c_j] \\ & \frac{1}{12} [(2 + w_{\tilde{e}_j} - u_{\tilde{e}_j} - y_{\tilde{e}_j}) h_j - (2 + w_{\tilde{b}_j} - u_{\tilde{b}_j} - y_{\tilde{b}_j}) e_j] \\ & + \frac{1}{12} [(2 + w_{\tilde{a}_j} - u_{\tilde{a}_j} - y_{\tilde{a}_j}) b_j - (2 + w_{\tilde{b}_j} - u_{\tilde{b}_j} - y_{\tilde{b}_j}) f_j] \\ & + \frac{1}{12} [(2 + w_{\tilde{e}_j} - u_{\tilde{e}_j} - y_{\tilde{e}_j}) m_j - (2 + w_{\tilde{b}_j} - u_{\tilde{b}_j} - y_{\tilde{b}_j}) g_j]. \text{ Here;} \end{aligned}$$

$a_j, e_j, h_j, b_j, f_j, l_j, c_j, g_j, m_j, w_{\tilde{a}_j}, w_{\tilde{b}_j}, w_{\tilde{e}_j}, u_{\tilde{a}_j}, u_{\tilde{b}_j}, u_{\tilde{e}_j}, y_{\tilde{a}_j}, y_{\tilde{b}_j}, y_{\tilde{e}_j}$. Hence;

$$\frac{1}{12} [(2 + w_{\tilde{e}_j} - u_{\tilde{e}_j} - y_{\tilde{e}_j}) h_j - (2 + w_{\tilde{b}_j} - u_{\tilde{b}_j} - y_{\tilde{b}_j}) e_j] \geq 0 \tag{3}$$

$$\frac{1}{12} [(2 + w_{\tilde{a}_j} - u_{\tilde{a}_j} - y_{\tilde{a}_j}) b_j - (2 + w_{\tilde{b}_j} - u_{\tilde{b}_j} - y_{\tilde{b}_j}) f_j] \geq 0 \tag{4}$$

$$\frac{1}{12} [(2 + w_{\tilde{e}_j} - u_{\tilde{e}_j} - y_{\tilde{e}_j}) m_j - (2 + w_{\tilde{b}_j} - u_{\tilde{b}_j} - y_{\tilde{b}_j}) g_j] \geq 0 \tag{5}$$

From (3), (4) and (5) $d_n(\tilde{a}_j, \tilde{c}_j) - d_n(\tilde{a}_j, \tilde{b}_j) \geq 0$. Namely; $d_n(\tilde{a}_j, \tilde{c}_j) \geq d_n(\tilde{a}_j, \tilde{b}_j)$.

$d_n(\tilde{a}_j, \tilde{c}_j) \geq d_n(\tilde{b}_j, \tilde{c}_j)$ can be showed a similar way to the proof of $d_n(\tilde{a}_j, \tilde{c}_j) \geq d_n(\tilde{a}_j, \tilde{b}_j)$.

Definition . : $\tilde{a} = (T_{\tilde{a}}, I_{\tilde{a}}, F_{\tilde{a}})$ single valued neutrosophic number, $\tilde{a}_T = ((T_{\tilde{a}} - I_{\tilde{a}} - F_{\tilde{a}}, 1 + 2T_{\tilde{a}} - I_{\tilde{a}} - 2F_{\tilde{a}}, 2 + 3T_{\tilde{a}} - 2I_{\tilde{a}} - 2F_{\tilde{a}}); T_{\tilde{a}}, I_{\tilde{a}}, F_{\tilde{a}})$ generalized single valued triangular neutrosophic number transformed according to the truth value of \tilde{a} , $\tilde{a}_T^i = ((1,3,5); 1,0,0)$, ideal generalized single valued triangular neutrosophic number transformed according to the truth value of \tilde{a} , and let

d_n be the Hamming distance for generalized single valued triangular neutrosophic number. According to the truth value of single valued neutrosophic numbers certainty and score functions are

$$S_T(\tilde{\alpha}) \quad d_n(\tilde{\alpha}_T, \tilde{\alpha}_T^i)$$

$A_T(\tilde{\alpha}) \quad \min\{|T_{\tilde{\alpha}} - I_{\tilde{\alpha}}|, |T_{\tilde{\alpha}} - F_{\tilde{\alpha}}|\}$ respectively. Here;

$$S_T(\tilde{\alpha})$$

$$\begin{aligned} & \frac{1}{12}[|(2 + T_{\tilde{\alpha}} - I_{\tilde{\alpha}} - F_{\tilde{\alpha}})(T_{\tilde{\alpha}} - I_{\tilde{\alpha}} - F_{\tilde{\alpha}}) - (2 + 1 - 0 - 0). 1| + \\ & |(2 + T_{\tilde{\alpha}} - I_{\tilde{\alpha}} - F_{\tilde{\alpha}})(2 T_{\tilde{\alpha}} - I_{\tilde{\alpha}} - 2F_{\tilde{\alpha}}) - (2 + 1 - 0 - 0). 3| + \\ & |(2 + T_{\tilde{\alpha}} - I_{\tilde{\alpha}} - F_{\tilde{\alpha}})(2 + 3T_{\tilde{\alpha}} - 2I_{\tilde{\alpha}} - 2F_{\tilde{\alpha}}) - (2 + 1 - 0 - 0). 5|] \\ & = \frac{1}{12}[|(2 + T_{\tilde{\alpha}} - I_{\tilde{\alpha}} - F_{\tilde{\alpha}})(T_{\tilde{\alpha}} - I_{\tilde{\alpha}} - F_{\tilde{\alpha}}) - 3| + |(2 + T_{\tilde{\alpha}} - I_{\tilde{\alpha}} - F_{\tilde{\alpha}})(2 T_{\tilde{\alpha}} - I_{\tilde{\alpha}} - 2F_{\tilde{\alpha}}) - 9| + \\ & |(2 + T_{\tilde{\alpha}} - I_{\tilde{\alpha}} - F_{\tilde{\alpha}})(2 + 3T_{\tilde{\alpha}} - 2I_{\tilde{\alpha}} - 2F_{\tilde{\alpha}}) - 15|]. \end{aligned}$$

Definition . : Let $\tilde{\alpha} \quad (T_{\tilde{\alpha}}, I_{\tilde{\alpha}}, F_{\tilde{\alpha}})$ be single valued neutrosophic number, $\tilde{\alpha}_I \quad ((T_{\tilde{\alpha}} - I_{\tilde{\alpha}} - F_{\tilde{\alpha}}, 1 + T_{\tilde{\alpha}} - 2F_{\tilde{\alpha}}, 2 + I_{\tilde{\alpha}} - 2F_{\tilde{\alpha}}); T_{\tilde{\alpha}}, I_{\tilde{\alpha}}, F_{\tilde{\alpha}})$; be generalized single valued triangular neutrosophic number transformed according to the indeterminacy value of $\tilde{\alpha}$, $\tilde{\alpha}_I^i \quad ((1,2,2); 1,0,0)$, be ideal generalized single valued triangular neutrosophic number transformed according to the indeterminacy value of $\tilde{\alpha}$, and d_n be hamming distance for generalized single valued triangular neutrosophic number. According to the indeterminacy value of single valued neutrosophic numbers certainty and score functions are;

$$S_I(\tilde{\alpha}) \quad d_n(\tilde{\alpha}_I, \tilde{\alpha}_I^i)$$

$A_I \quad \min\{|I_{\tilde{\alpha}} - T_{\tilde{\alpha}}|, |I_{\tilde{\alpha}} - F_{\tilde{\alpha}}|\}$, } respectively. Here;

$$S_I(\tilde{\alpha})$$

$$\begin{aligned} & \frac{1}{12}[|(2 + T_{\tilde{\alpha}} - I_{\tilde{\alpha}} - F_{\tilde{\alpha}})(T_{\tilde{\alpha}} - I_{\tilde{\alpha}} - F_{\tilde{\alpha}}) - (2 + 1 - 0 - 0). 1| + \\ & |(2 + T_{\tilde{\alpha}} - I_{\tilde{\alpha}} - F_{\tilde{\alpha}})(1 + T_{\tilde{\alpha}} - 2F_{\tilde{\alpha}}) - (2 + 1 - 0 - 0). 2| + \\ & |(2 + T_{\tilde{\alpha}} - I_{\tilde{\alpha}} - F_{\tilde{\alpha}})(2 + I_{\tilde{\alpha}} - 2F_{\tilde{\alpha}}) - (2 + 1 - 0 - 0). 2|] \\ & = \frac{1}{12}[|(2 + T_{\tilde{\alpha}} - I_{\tilde{\alpha}} - F_{\tilde{\alpha}})(T_{\tilde{\alpha}} - I_{\tilde{\alpha}} - F_{\tilde{\alpha}}) - 2| + |(2 + T_{\tilde{\alpha}} - I_{\tilde{\alpha}} - F_{\tilde{\alpha}})(1 + T_{\tilde{\alpha}} - 2F_{\tilde{\alpha}}) - 6| + \\ & |(2 + T_{\tilde{\alpha}} - I_{\tilde{\alpha}} - F_{\tilde{\alpha}})(2 + I_{\tilde{\alpha}} - 2F_{\tilde{\alpha}}) - 6|] \end{aligned}$$

Definition . : Let $\tilde{\alpha} \quad (T_{\tilde{\alpha}}, I_{\tilde{\alpha}}, F_{\tilde{\alpha}})$ be single valued neutrosophic number, $\tilde{\alpha}_F \quad ((T_{\tilde{\alpha}} - I_{\tilde{\alpha}} - F_{\tilde{\alpha}}, 1 + T_{\tilde{\alpha}} - 2I_{\tilde{\alpha}}, 2 + F_{\tilde{\alpha}} - 2I_{\tilde{\alpha}}); T_{\tilde{\alpha}}, I_{\tilde{\alpha}}, F_{\tilde{\alpha}})$; be generalized single valued triangular neutrosophic number transformed according to the falsity value of $\tilde{\alpha}$, $\tilde{\alpha}_F^i \quad ((1,2,2); 1,0,0)$, be ideal generalized single valued triangular neutrosophic number transformed according to the falsity value of $\tilde{\alpha}$, and d_n be Hamming distance for generalized single valued triangular neutrosophic number. According to the falsity value of single valued neutrosophic numbers certainty and score functions are;

$$S_F(\tilde{a}) \quad d_n(\tilde{a}_F, \tilde{a}_F^i)$$

$A_F \min\{|F_{\tilde{a}} - I_{\tilde{a}}|, |F_{\tilde{a}} - F_{\tilde{a}}|\}$, respectively. Here;

$$S_F(\tilde{a})$$

$$\begin{aligned} & \frac{1}{12}[|(2 + T_{\tilde{a}} - I_{\tilde{a}} - F_{\tilde{a}})(T_{\tilde{a}} - I_{\tilde{a}} - F_{\tilde{a}}) - (2 + 1 - 0 - 0). 1| + \\ & |(2 + T_{\tilde{a}} - I_{\tilde{a}} - F_{\tilde{a}})(1 + T_{\tilde{a}} - 2I_{\tilde{a}}) - (2 + 1 - 0 - 0). 2| + \\ & |(2 + T_{\tilde{a}} - I_{\tilde{a}} - F_{\tilde{a}})(2 + F_{\tilde{a}} - 2I_{\tilde{a}}) - (2 + 1 - 0 - 0). 2|] \\ & = \frac{1}{12}[|(2 + T_{\tilde{a}} - I_{\tilde{a}} - F_{\tilde{a}})(T_{\tilde{a}} - I_{\tilde{a}} - F_{\tilde{a}}) - 2| + |(2 + T_{\tilde{a}} - I_{\tilde{a}} - F_{\tilde{a}})(1 + T_{\tilde{a}} - 2I_{\tilde{a}}) - 6| + \\ & |(2 + T_{\tilde{a}} - I_{\tilde{a}} - F_{\tilde{a}})(2 + F_{\tilde{a}} - 2I_{\tilde{a}}) - 6|] \end{aligned}$$

Definition .1 : Let $\tilde{a} (T_{\tilde{a}}, I_{\tilde{a}}, F_{\tilde{a}})$ and $\tilde{b} (T_{\tilde{b}}, I_{\tilde{b}}, F_{\tilde{b}})$ be two single valued neutrosophic numbers and S_T, A_T be score and certainty functions according to truth value.

- i) If $S_T(\tilde{a}) > S_T(\tilde{b})$, then \tilde{a} is greater than \tilde{b} and denoted by $\tilde{a} \succ \tilde{b}$.
- ii) If $S_T(\tilde{a}) = S_T(\tilde{b})$ and $A_T(\tilde{a}) > A_T(\tilde{b})$, then \tilde{a} is greater than \tilde{b} and denoted by $\tilde{a} \succ \tilde{b}$.
- iii) If $S_T(\tilde{a}) = S_T(\tilde{b})$ and $A_T(\tilde{a}) = A_T(\tilde{b})$, then \tilde{a} is equal to \tilde{b} and denoted by $\tilde{a} \sim \tilde{b}$.

This definition can also be done for S_I, A_I score and certainty functions in case of indeterminacy and for S_F, A_F score and certainty functions in case of falsity.

Definition .11: Let $\tilde{a}_j \langle (a_j, b_j, c_j); w_{\tilde{a}_j}, u_{\tilde{a}_j}, y_{\tilde{a}_j} \rangle$ and d_n be Hamming distance for the generalized single valued triangular neutrosophic numbers.

- i) $\tilde{a}_T^i \langle (1,3,5); 1,0,0 \rangle$, be ideal generalized single valued triangular neutrosophic number according to the truth value of \tilde{a} ; depending on the Hamming distance \tilde{a}_j generalized single valued triangular neutrosophic numbers according to the truth value score and certainty functions are;

$$S_{TT}(\tilde{a}_j) \quad d_n(\tilde{a}_j, \tilde{a}_T^i)$$

$A_{TT}(\tilde{a}_j) \quad \min\{|T_{\tilde{a}} - I_{\tilde{a}}|, |T_{\tilde{a}} - F_{\tilde{a}}|\}$ respectively.

- ii) $\tilde{a}_I^i \langle (1,2,2); 1,0,0 \rangle$, be ideal generalized single valued triangular neutrosophic number according to the indeterminacy value of \tilde{a} ; depending on the hamming distance \tilde{a}_j generalized single valued triangular neutrosophic numbers according to the indeterminacy value score and certainty functions are;

$$S_{TI}(\tilde{a}_j) \quad d_n(\tilde{a}_j, \tilde{a}_I^i)$$

$$A_{TF}(\tilde{a}_j) = \min\{|I_{\tilde{a}} - T_{\tilde{a}}|, |T_{\tilde{a}} - F_{\tilde{a}}|\} \text{ respectively.}$$

iii) i) $\tilde{a}_F^i = \langle (1,2,2); 1,0,0 \rangle$, be ideal generalized single valued triangular neutrosophic number according to the falsity value of \tilde{a} ; depending on the Hamming distance \tilde{a}_j generalized single valued triangular neutrosophic numbers according to the falsity value score and certainty functions are;

$$S_{TF}(\tilde{a}_j) = d_n(\tilde{a}_j, \tilde{a}_F^i)$$

$$A_{TF}(\tilde{a}_j) = \min\{|F_{\tilde{a}} - T_{\tilde{a}}|, |F_{\tilde{a}} - I_{\tilde{a}}|\} \text{ respectively.}$$

Thus, for generalized single valued triangular neutrosophic numbers we have also defined a new scoring function based on the Hamming distance.

Definition .1 : Let $\tilde{a}_j = \langle (a_j, b_j, c_j); w_{\tilde{a}_j}, u_{\tilde{a}_j}, y_{\tilde{a}_j} \rangle$ and $\tilde{b}_j = \langle (d_j, e_j, f_j); w_{\tilde{b}_j}, u_{\tilde{b}_j}, y_{\tilde{b}_j} \rangle$ be two generalized single valued triangular neutrosophic numbers and S_{TT}, A_{TT} be score and certainty functions according to truth value.

- i) If $S_{TT}(\tilde{a}) > S_{TT}(\tilde{b})$, then \tilde{a} is greater than \tilde{b} and denoted by $\tilde{a} \succ \tilde{b}$.
- ii) If $S_{TT}(\tilde{a}) = S_{TT}(\tilde{b})$ and $A_{TT}(\tilde{a}) > A_{TT}(\tilde{b})$, then \tilde{a} is greater than \tilde{b} and denoted by $\tilde{a} \succ \tilde{b}$.
- iii) if $S_{TT}(\tilde{a}) = S_{TT}(\tilde{b})$ and $A_{TT}(\tilde{a}) = A_{TT}(\tilde{b})$, then \tilde{a} is equal to \tilde{b} and denoted by $\tilde{a} \sim \tilde{b}$.

Example .1 : Now let's compare the score and certainty function in definition 4.7 with the S_{TT}, A_{TT} score and certainty function according to the truth value, S_I, A_I score and certainty function in definition 4.8 according to the indeterminacy value and S_F, A_F score and certainty function in definition 4.9 according to the falsity value.

Let $\tilde{a}_1 = (0.9, 0.4, 0.3)$, $\tilde{a}_2 = (0.8, 0.4, 0.2)$ and $\tilde{a}_3 = (0.7, 0.4, 0.1)$ be three single valued neutrosophic number.

i) For score and certainty functions in Definition 2.7;

$$\begin{aligned} ac(\tilde{a}_1) &= 2.2 & sc(\tilde{a}_1) &= 0.6 \\ ac(\tilde{a}_2) &= 2.2 & sc(\tilde{a}_2) &= 0.6 \\ ac(\tilde{a}_3) &= 2.2 & sc(\tilde{a}_3) &= 0.6 \end{aligned} \text{ hence; } \tilde{a}_1 \sim \tilde{a}_2 \sim \tilde{a}_3.$$

ii) For the score function according to the truth value in Definition 4.7;

$$S_T(\tilde{a}_1) = 1.42 \quad S_T(\tilde{a}_2) = 1.44 \quad S_T(\tilde{a}_3) = 1.46 \text{ hence } \tilde{a}_1 \sim \tilde{a}_2 \sim \tilde{a}_3$$

iii) For the score function according to the indeterminacy value in Definition 4.8;

$$S_I(\tilde{a}_1) = 0.51 \quad S_I(\tilde{a}_2) = 0.49 \quad S_I(\tilde{a}_3) = 0.47 \quad \text{hence } \tilde{a}_3 \succ \tilde{a}_2 \succ \tilde{a}_1.$$

iv) For the score function according to the falsity value in Definition 4.9;

$$S_F(\tilde{a}_1) = 0.51 \quad S_F(\tilde{a}_2) = 0.49 \quad S_F(\tilde{a}_3) = 0.47 \quad \text{hence } \tilde{a}_3 \succ \tilde{a}_2 \succ \tilde{a}_1.$$

Table 1: (Results of scoring functions for single valued triangular neutrosophic numbers)

The result of the score and certainty function in Definition 2.7	$\tilde{a}_1 \succ \tilde{a}_2 \succ \tilde{a}_3$
The result of the score function according to the truth value in definition 4.7	$\tilde{a}_1 \succ \tilde{a}_2 \succ \tilde{a}_3$
The result of the score function according to the indeterminacy value in definition 4.8	$\tilde{a}_3 \succ \tilde{a}_2 \succ \tilde{a}_1$
The result of the score function according to the falsity value in Definition 4.9	$\tilde{a}_3 \succ \tilde{a}_2 \succ \tilde{a}_1$

Example .1 : Now let's compare the score and certainty function in definition 4.3 with the S_{TT} , score and certainty function in definition 2.1 according to the truth value, S_{TI}, A_{TI} score and certainty function according to the indeterminacy value and S_{TF}, A_{TF} score and certainty function according to the falsity value.

Let $\tilde{a}_1 \langle (2,5,6); 0.9, 0.6, 0 \rangle$, $\tilde{a}_2 \langle (3,4,6); 0.8, 0.5, 0 \rangle$ and $\tilde{a}_3 \langle (1,5,7); 0.7, 0.4, 0 \rangle$ be three single valued triangular neutrosophic numbers.

i) For the score and certainty functions in Definition 2.11;

$$\begin{aligned} S(\tilde{a}_1) = 3.73 & \quad A(\tilde{a}_1) = 3.73 \\ S(\tilde{a}_2) = 3.73 & \quad A(\tilde{a}_2) = 3.73 \\ S(\tilde{a}_3) = 3.73 & \quad A(\tilde{a}_3) = 3.73 \quad \text{hence } \tilde{a}_1 \succ \tilde{a}_2 \succ \tilde{a}_3. \end{aligned}$$

ii) For the score function according to the truth value in Definition 4.11;

$$S_{TT}(\tilde{a}_1) = 0,458 \quad S_{TT}(\tilde{a}_2) = 0,450 \quad S_{TT}(\tilde{a}_3) = 0,358 \quad \text{hence } \tilde{a}_3 \succ \tilde{a}_2 \succ \tilde{a}_1.$$

iii) For the score function according to the indeterminacy value in Definition 4.8;

$$S_{TI}(\tilde{a}_1) = 1,458 \quad S_{TI}(\tilde{a}_2) = 1,350 \quad S_{TI}(\tilde{a}_3) = 1,358 \quad \text{hence } \tilde{a}_2 \succ \tilde{a}_3 \succ \tilde{a}_1.$$

iv) For the score function according to the falsity value in Definition 4.9;

$$S_{TF}(\tilde{a}_1) = 1,458 \quad S_{TF}(\tilde{a}_2) = 1,350 \quad S_{TF}(\tilde{a}_3) = 1,358 \quad \text{hence } \tilde{a}_2 \succ \tilde{a}_3 \succ \tilde{a}_1.$$

Table : (Results of scoring functions for single valued triangular neutrosophic numbers)

The result of the score and certainty function in Definition 2.11	$\tilde{a}_1 \quad \tilde{a}_2 \quad \tilde{a}_3$
The result of score function according to the truth value in Definition 4.11	$\tilde{a}_3 \quad \tilde{a}_2 \quad \tilde{a}_1$
The result of score function according to the indeterminacy value in Definition 4.11	$\tilde{a}_2 \quad \tilde{a}_3 \quad \tilde{a}_1$
The result of score function according to the falsity value in Definition 4.11	$\tilde{a}_2 \quad \tilde{a}_3 \quad \tilde{a}_1$

. SOME NEW GENERALIZED AGGREGATION OPERATORS BASED ON GENERALIZED SINGLE VALUED TRIANGULAR NEUTROSOPHIC NUMBERS FOR APPLICATION TO MULTI-ATTRIBUTE GROUP DECISION MAKING

In this section we have generalized some operators given for triangular intuitionistic fuzzy numbers in Definition 2.3 and Definition 2.4 for generalized single valued triangular neutrosophic numbers and showed some properties. We have shown that the new operators we have acquired include operators in definitions 2.13 and 2.14. Additionally, we showed the generalized single valued triangular neutrosophic numbers in this section.

Definition .1: Let $\tilde{a}_j = \langle (a_j, b_j, c_j); w_{\tilde{a}_j}, u_{\tilde{a}_j}, y_{\tilde{a}_j} \rangle$ ($j = 1, 2, 3, \dots, n$) be a collection of generalized single valued triangular neutrosophic numbers. Then generalized single valued triangular neutrosophic generalized weight averaging operator (SVTNGWAO) is defined as;

$$\text{GSVTNGWAO: } \bar{N}_R^n \rightarrow \bar{N}_R, \quad \text{GSVTNGWAO}(\tilde{a}_1, \tilde{a}_2, \dots, \tilde{a}_n) = g^{-1}\left(\sum_{j=1}^n w_j g(\tilde{a}_{(j)})\right)$$

where g is a continuous strictly monotone increasing function, $w = (w_1, w_2, \dots, w_n)^T$ is a weight vector associated with the GSVTNGWAO operator, with $w_j \geq 0, j = 1, 2, 3, \dots, n$ and $\sum_{j=1}^n w_j = 1$ ($j = 1, 2, 3, \dots, n$).

Theorem . : Let $\tilde{a}_j = \langle (a_j, b_j, c_j); w_{\tilde{a}_j}, u_{\tilde{a}_j}, y_{\tilde{a}_j} \rangle$ ($j = 1, 2, 3, \dots, n$) be a collection of generalized single valued triangular neutrosophic numbers and $w = (w_1, w_2, \dots, w_n)^T$ is a weight vector associated with $w_j \geq 0$, and $\sum_{j=1}^n w_j = 1$. Then their aggregated value by using SVTNGWAO operator is also a neutrosophic number and

$$\text{GSVTNGWAO}(\tilde{a}_1, \tilde{a}_2, \dots, \tilde{a}_n)$$

$$\langle [g^{-1}\left(\sum_{j=1}^n w_j g(a_{(j)})\right), g^{-1}\left(\sum_{j=1}^n w_j g(b_{(j)})\right), g^{-1}\left(\sum_{j=1}^n w_j g(c_{(j)})\right)]; \wedge_{j=1}^n w_{\tilde{a}_j} \vee_{j=1}^n u_{\tilde{a}_j} \vee_{j=1}^n y_{\tilde{a}_j} \rangle$$

Where, g is a continuous strictly monotone increasing function.

Proof: We proof this by using the method of mathematical induction. For this;

i) For $n = 2$

$\tilde{a}_1 = \langle (a_1, b_1, c_1); w_{\tilde{a}_1}, u_{\tilde{a}_1}, y_{\tilde{a}_1} \rangle$ and $\tilde{a}_2 = \langle (a_2, b_2, c_2); w_{\tilde{a}_2}, u_{\tilde{a}_2}, y_{\tilde{a}_2} \rangle$ be two single valued triangular neutrosophic numbers by definition;

$$g^{-1}(w_1 g(\tilde{a}_1)) + g^{-1}(w_2 g(\tilde{a}_2))$$

$$\begin{aligned}
 &g^{-1}(w_1g(\langle (a_1, b_1, c_1); w_{\tilde{a}_1}, u_{\tilde{a}_1}, y_{\tilde{a}_1} \rangle)) + g^{-1}(w_2g(\langle (a_2, b_2, c_2); w_{\tilde{a}_2}, u_{\tilde{a}_2}, y_{\tilde{a}_2} \rangle)) \\
 &g^{-1}(\langle (w_1g(a_1), w_1g(b_1), w_1g(c_1)); w_{\tilde{a}_1}, u_{\tilde{a}_1}, y_{\tilde{a}_1} \rangle) + \\
 &g^{-1}(\langle (w_2g(a_2), w_2g(b_2), w_2g(c_2)); w_{\tilde{a}_2}, u_{\tilde{a}_2}, y_{\tilde{a}_2} \rangle) \\
 &g^{-1}(\langle (w_1g(a_1), w_1g(b_1), w_1g(c_1)); w_{\tilde{a}_1}, u_{\tilde{a}_1}, y_{\tilde{a}_1} \rangle) + \langle (w_2g(a_2), w_2g(b_2), w_2g(c_2)); w_{\tilde{a}_2}, u_{\tilde{a}_2}, y_{\tilde{a}_2} \rangle) \\
 &\langle [g^{-1}(\sum_{j=1}^2 w_jg(a_{(j)}), g^{-1}(\sum_{j=1}^2 w_jg(b_{(j)}), g^{-1}(\sum_{j=1}^2 w_jg(c_{(j)}))]; \wedge_{j=1}^2 w_{\tilde{a}_j}, \vee_{j=1}^2 u_{\tilde{a}_j}, \vee_{j=1}^2 y_{\tilde{a}_j} \rangle \\
 &\text{it's true.}
 \end{aligned}$$

Let it be true for n = k that is we assumed

$$\begin{aligned}
 &g^{-1}(w_1g(\tilde{a}_1)) + g^{-1}(w_2g(\tilde{a}_2)) + \dots + g^{-1}(w_kg(\tilde{a}_k)) \\
 &\langle [g^{-1}(\sum_{j=1}^k w_jg(a_{(j)}), g^{-1}(\sum_{j=1}^k w_jg(b_{(j)}), g^{-1}(\sum_{j=1}^k w_jg(c_{(j)}))]; \wedge_{j=1}^k w_{\tilde{a}_j}, \vee_{j=1}^k u_{\tilde{a}_j}, \vee_{j=1}^k y_{\tilde{a}_j} \rangle \\
 &\text{equation is true and let show that it is also true for n+1 .then}
 \end{aligned}$$

$$\begin{aligned}
 &g^{-1}(w_1g(\tilde{a}_1)) + g^{-1}(w_2g(\tilde{a}_2)) + \dots + g^{-1}(w_{k+1}g(\tilde{a}_{k+1})) \\
 &\langle [g^{-1}(\sum_{j=1}^k w_jg(a_{(j)}), g^{-1}(\sum_{j=1}^k w_jg(b_{(j)}), g^{-1}(\sum_{j=1}^k w_jg(c_{(j)}))]; \wedge_{j=1}^k w_{\tilde{a}_j}, \vee_{j=1}^k u_{\tilde{a}_j}, \vee_{j=1}^k y_{\tilde{a}_j} \rangle \\
 &+ g^{-1}(\langle (w_{k+1}g(a_{k+1}), w_2g(b_{k+1}), w_2g(c_{k+1})); w_{\tilde{a}_{k+1}}, u_{\tilde{a}_{k+1}}, y_{\tilde{a}_{k+1}} \rangle) \\
 &\langle [g^{-1}(\sum_{j=1}^{k+1} w_jg(a_{(j)}), g^{-1}(\sum_{j=1}^{k+1} w_jg(b_{(j)}), g^{-1}(\sum_{j=1}^{k+1} w_jg(c_{(j)}))]; \wedge_{j=1}^{k+1} w_{\tilde{a}_j}, \vee_{j=1}^{k+1} u_{\tilde{a}_j}, \vee_{j=1}^{k+1} y_{\tilde{a}_j} \rangle
 \end{aligned}$$

Hence the expression is true for n = k+1 as required.

As a result, the proof of the theorem is completed.

Lemma 1.1 : Let $\tilde{a}_j = \langle (a_j, b_j, c_j); w_{\tilde{a}_j}, u_{\tilde{a}_j}, y_{\tilde{a}_j} \rangle$ and $\tilde{b}_2 = \langle (d_j, e_j, f_j); w_{\tilde{b}_j}, u_{\tilde{b}_j}, y_{\tilde{b}_j} \rangle$ (j = 1, 2, 3, ..., n) be a collection of generalized single valued triangular neutrosophic numbers and $\tilde{a} = \langle (a, b, c); w_{\tilde{a}}, u_{\tilde{a}}, y_{\tilde{a}} \rangle$ be a generalized single valued triangular neutrosophic number. $w = (w_1, w_2, \dots, w_n)^T$ be a weight vector associated with $w_j \geq 0$, and $\sum_{j=1}^n w_j = 1$.

- 1) If $\tilde{a}_j \tilde{a}$ (j = 1, 2, 3, ..., n), then $GSVTNGWAO(\tilde{a}_1, \tilde{a}_2, \dots, \tilde{a}_n) = \tilde{a}$
- 2) If $\tilde{a}_j^- = \langle (\min\{a_j\}, \min\{b_j\}, \min\{c_j\}); \min\{w_{\tilde{a}_j}\}, \max\{u_{\tilde{a}_j}\}, \max\{y_{\tilde{a}_j}\} \rangle$
 $\tilde{a}_j^+ = \langle (\max\{a_j\}, \max\{b_j\}, \max\{c_j\}); \max\{w_{\tilde{a}_j}\}, \min\{u_{\tilde{a}_j}\}, \min\{y_{\tilde{a}_j}\} \rangle$

Then,

$$\tilde{a}_j^- \text{ GSVTNGWAO}(\tilde{a}_1, \tilde{a}_2, \dots, \tilde{a}_n) = \tilde{a}_j^+$$

- 3) If $a_j \geq d_j, b_j \geq e_j, c_j \geq f_j, w_{\tilde{a}_j} \geq w_{\tilde{b}_j}, u_{\tilde{a}_j} \leq u_{\tilde{b}_j}, y_{\tilde{a}_j} \leq y_{\tilde{b}_j}$ for all j then,

$$\text{GSVTNGWAO}(\tilde{a}_1, \tilde{a}_2, \dots, \tilde{a}_n) \quad \text{GSVTNGWAO}(\tilde{b}_1, \tilde{b}_2, \dots, \tilde{b}_n)$$

Proof:

1) From theorem 5.2 GSVTNGWAO $(\tilde{a}_1, \tilde{a}_2, \dots, \tilde{a}_n)$

$$\langle [g^{-1}(\sum_{j=1}^n w_j g(a_{(j)})), g^{-1}(\sum_{j=1}^n w_j g(b_{(j)})), g^{-1}(\sum_{j=1}^n w_j g(c_{(j)}))]; \bigwedge_{j=1}^n w_{\tilde{a}_j} \bigvee_{j=1}^n u_{\tilde{a}_j} \bigvee_{j=1}^n y_{\tilde{a}_j} \rangle$$

$$\langle [g^{-1}(\sum_{j=1}^n w_j g(a)), g^{-1}(\sum_{j=1}^n w_j g(b)), g^{-1}(\sum_{j=1}^n w_j g(b))]; \bigwedge_{j=1}^n w_{\tilde{a}} \bigvee_{j=1}^n w_{\tilde{a}} \bigvee_{j=1}^n w_{\tilde{a}} \rangle$$

$\sum_{j=1}^n w_j = 1$. Hence;

$$\text{GSVTNGWAO}(\tilde{a}_1, \tilde{a}_2, \dots, \tilde{a}_n) \langle (g^{-1}(g(a)), g^{-1}(g(b)), g^{-1}(g(c))); w_{\tilde{a}}, u_{\tilde{a}}, y_{\tilde{a}} \rangle \langle (a, b, c); w_{\tilde{a}}, u_{\tilde{a}}, y_{\tilde{a}} \rangle$$

The proof of 2) and 3) can easily be done from the proposition 4.6 given for the scoring function according to the center of the Hamming distance in the definition 5.1 and section 4.

Definition . : Let $\tilde{\alpha}_j \langle (a_j, b_j, c_j); w_{\tilde{\alpha}_j}, u_{\tilde{\alpha}_j}, y_{\tilde{\alpha}_j} \rangle$ ($j = 1, 2, 3, \dots, n$) be a collection of generalized single valued triangular neutrosophic numbers. Then generalized single valued triangular neutrosophic generalized ordered averaging operator (GSVTNGOAO) is defined as;

$$\text{GSVTNGOAO}: \bar{N}_R^n \rightarrow \bar{N}_R, \quad \text{GSVTNGOAO}(\tilde{a}_1, \tilde{a}_2, \dots, \tilde{a}_n) = g^{-1}(\sum_{j=1}^n w_j g(\tilde{b}_{(j)}))$$

where g is a continuous strictly monotone increasing function, $w = (w_1, w_2, \dots, w_n)^T$ is a weight vector associated with the GSVTNGOAO operator, with $w_j \geq 0, j = 1, 2, 3, \dots, n$ and $\sum_{j=1}^n w_j = 1$ ($j = 1, 2, 3, \dots, n$) and k is the largest generalized single valued triangular neutrosophic number obtained by using the new score function of $\tilde{b}_{(j)}; \tilde{\alpha}_j \langle (a_j, b_j, c_j); w_{\tilde{\alpha}_j}, u_{\tilde{\alpha}_j}, y_{\tilde{\alpha}_j} \rangle$ for $k \in \{1, 2, 3, \dots, n\}$.

Theorem . Let $\tilde{\alpha}_j \langle (a_j, b_j, c_j); w_{\tilde{\alpha}_j}, u_{\tilde{\alpha}_j}, y_{\tilde{\alpha}_j} \rangle$ ($j = 1, 2, 3, \dots, n$) be a collection of single valued triangular neutrosophic numbers and $w = (w_1, w_2, \dots, w_n)^T$ is a weight vector associated with $w_j \geq 0$, and $\sum_{j=1}^n w_j = 1$. Then their aggregated value by using GSVTNGOAO operator is also a neutrosophic number and

$$\text{GSVTNGOAO}(\tilde{a}_1, \tilde{a}_2, \dots, \tilde{a}_n)$$

$$g^{-1}(\sum_{j=1}^n w_j g(\tilde{b}_{(j)}))$$

$$\langle [g^{-1}(\sum_{j=1}^n w_j g(a_{(j)})), g^{-1}(\sum_{j=1}^n w_j g(b_{(j)})), g^{-1}(\sum_{j=1}^n w_j g(c_{(j)}))]; \bigwedge_{j=1}^n w_{\tilde{a}_j} \bigvee_{j=1}^n u_{\tilde{a}_j} \bigvee_{j=1}^n y_{\tilde{a}_j} \rangle$$

where g is a continuous strictly monotone increasing function and k is the largest generalized single valued triangular neutrosophic number obtained by using the new score function of $\tilde{b}_{(j)}; \tilde{\alpha}_j \langle (a_j, b_j, c_j); w_{\tilde{\alpha}_j}, u_{\tilde{\alpha}_j}, y_{\tilde{\alpha}_j} \rangle$ for $k \in \{1, 2, 3, \dots, n\}$.

Proof: Proof is made similar to Theorem 5.2 using Definition 5.4.

Lemma . Let $\tilde{a}_j = \langle (a_j, b_j, c_j); w_{\tilde{a}_j}, u_{\tilde{a}_j}, y_{\tilde{a}_j} \rangle$ and $\tilde{b}_2 = \langle (d_j, e_j, f_j); w_{\tilde{b}_j}, u_{\tilde{b}_j}, y_{\tilde{b}_j} \rangle$ ($j = 1, 2, 3, \dots, n$) be collections of generalized single valued triangular neutrosophic numbers and $\tilde{a} = \langle (a, b, c); w_{\tilde{a}}, u_{\tilde{a}}, y_{\tilde{a}} \rangle$ be a generalized single valued triangular neutrosophic number. $w = (w_1, w_2, \dots, w_n)^T$ be a weight vector associated with $w_j \geq 0$, and $\sum_{j=1}^n w_j = 1$.

1) If $\tilde{a}_j \tilde{a}$ ($j = 1, 2, 3, \dots, n$), then $GSVTNGOAO(\tilde{a}_1, \tilde{a}_2, \dots, \tilde{a}_n) = \tilde{a}$

2) If $\tilde{a}_j^- = \langle (\min\{a_j\}, \min\{b_j\}, \min\{c_j\}); \min\{w_{\tilde{a}_j}\}, \max\{u_{\tilde{a}_j}\}, \max\{y_{\tilde{a}_j}\} \rangle$

$$\tilde{a}_j^+ = \langle (\max\{a_j\}, \max\{b_j\}, \max\{c_j\}); \max\{w_{\tilde{a}_j}\}, \min\{u_{\tilde{a}_j}\}, \min\{y_{\tilde{a}_j}\} \rangle$$

Then,

$$\tilde{a}_j^- \text{GSVTNGOAO}(\tilde{a}_1, \tilde{a}_2, \dots, \tilde{a}_n) = \tilde{a}_j^+$$

3) If $a_j \geq d_j, b_j \geq e_j, c_j \geq f_j, w_{\tilde{a}_j} \geq w_{\tilde{b}_j}, u_{\tilde{a}_j} \leq u_{\tilde{b}_j}, y_{\tilde{a}_j} \leq y_{\tilde{b}_j}$ for all j then,

$$GSVTNGOAO(\tilde{a}_1, \tilde{a}_2, \dots, \tilde{a}_n) \geq GSVTNGOAO(\tilde{b}_1, \tilde{b}_2, \dots, \tilde{b}_n)$$

Proof:

The proof of 1) can be done similar to the proof of the theorem 5.3.

The proof of 2) and 3) can easily be done from proposition 4.6 given for the Hamming distance depending on the scoring function in the definition 5.4 and in the section 6.

Corollary . : If $g(x) = x^r$ ($r \geq 1$) is taken in Definition 5.1, the operator in Definition 2.13 is obtained. Similarly, if $g(x) = x^r$ ($r \geq 1$) is taken in 5.2, the operator in Definition 2.14 is obtained.

Note . : If $g(x) = x^r$ is taken in the operators in Definition 5.1 and Definition 5.2; r value should not be taken as an odd number. Indeterminacy emerges when any of the values a_j, b_j, c_j of a generalized single valued triangular neutrosophic number $\tilde{a}_j = \langle (a_j, b_j, c_j); w_{\tilde{a}_j}, u_{\tilde{a}_j}, y_{\tilde{a}_j} \rangle$ takes a negative real number value.

. MULTI ATTRIBUTE GROUP DECISION MAKING METHOD BASED ON THE SVTNGWAO OPERATOR

For a multi-attribute group decision making problem, let $E = \{e_1, e_2, \dots, e_n\}$ be a set of experts (or DMs), $A = \{A_1, A_2, \dots, A_m\}$ be set of alternatives, $X = \{x_1, x_2, \dots, x_p\}$ be set of attributes. Assume that the rating of alternative A_i on attribute x_j given by expert e_k is represented by single valued neutrosophic number $\tilde{a}_{ij}^k = (a_{ij}^k, b_{ij}^k, c_{ij}^k)$ ($i = 1, 2, \dots, m; j = 1, 2, \dots, p; k = 1, 2, \dots, n$). Additionally, let g be a continuous strictly monotone

increasing function. Now let's take the steps we will follow to solve the multi-attribute group decision making problem.

- i) The decision matrices obtained by the decision makers are found as $\tilde{D}^k = (\tilde{a}_{ij}^k)_{m \times p}$ ($i = 1, 2, \dots, m; j = 1, 2, \dots, p; k = 1, 2, \dots, n$).
- ii) \tilde{D}^k decision matrices; for \tilde{a}_{ij}^k single valued neutrosophic numbers, \tilde{D}^k_T matrices are formed that consist of \tilde{a}_{ij}^k converted single valued triangular neutrosophic numbers.
- iii) Let $(\omega_1, \omega_2, \dots, \omega_n)^T$ be the weight vector of decision makers with $\omega_j \geq 0$, and $\sum_{j=1}^n \omega_j = 1$. Accordingly, the weighted decision matrix is $\tilde{D}^k_w = (\omega_k \tilde{a}_{ij}^k)_{m \times p}$ ($i = 1, 2, \dots, m; j = 1, 2, \dots, p; k = 1, 2, \dots, n$).
- iv) GSVTNGWAO is the operator in the definition 5.1; the unified decision matrix $\tilde{D}_u = (\tilde{d}_{u,ij})_{m \times p}$ obtained from the weighted decision matrices. Here;

$$\tilde{d}_{u,i1} = \text{GSVTNGWAO}(\varphi_k \tilde{a}_{i1}^k, \varphi_k \tilde{a}_{i1}^k, \dots, \varphi_k \tilde{a}_{i1}^k),$$

$$\tilde{d}_{u,i2} = \text{GSVTNGWAO}(\varphi_k \tilde{a}_{i2}^k, \varphi_k \tilde{a}_{i2}^k, \dots, \varphi_k \tilde{a}_{i2}^k),$$

...

$$\tilde{d}_{u,ip} = \text{GSVTNGWAO}(\varphi_k \tilde{a}_{ip}^k, \varphi_k \tilde{a}_{ip}^k, \dots, \varphi_k \tilde{a}_{ip}^k). \text{ Where; } (i = 1, 2, 3, \dots, m).$$

Also here, the weight vector to be used for the GSVTNGWAO operator is $(\varphi_1, \varphi_2, \dots, \varphi_n)^T$ with $\varphi_j \geq 0$, and $\sum_{j=1}^n \varphi_j = 1$.

- v) $\tilde{D}_u = (\tilde{d}_{u,ij})_{m \times p}$ be the unified decision matrix; let $w = (w_1, w_2, \dots, w_p)^T$ weight vector of $\{x_1, x_2, \dots, x_p\}$ with $w_j \geq 0$, and $\sum_{j=1}^p w_j = 1$. single valued triangular neutrosophic numbers for the $\{A_1, A_2, \dots, A_m\}$ alternatives is ;

$$\tilde{A}_t = \text{GSVTNGWAO}_t(\tilde{d}_{u,t1}, \tilde{d}_{u,t2}, \dots, \tilde{d}_{u,tp}) \quad (t = 1, 2, \dots, m).$$

- vi) Single valued triangular neutrosophic numbers \tilde{A}_t ($t = 1, 2, \dots, m$) for the $\{A_1, A_2, \dots, A_m\}$ alternatives are compared with one of the new score functions in definition 4.7, definition 4.8 or definition 4.9, and the best alternative is found. Here; there is a score function according to the truth value in definition 4.7, according to the indeterminacy value in definition 4.8 and according to the falsity value in definition 4.9.

Corollary .1: In this method for single valued neutrosophic numbers, starting directly from the second step, single valued triangular neutrosophic numbers can be taken and processed. Thus the method we have obtained can be used for single valued triangular neutrosophic numbers or generalized single valued triangular neutrosophic numbers.

Example . : A pharmaceutical company wants to choose the most appropriate diabetes drug from four alternatives $\{A_1, A_2, A_3, A_4\}$. For this, a decision committee of three pharmacological specialists $\{e_1, e_2, e_3\}$ was established. This decision commission will review alternative medicines in three qualities. These qualities are; the dose rate of the drug is x_1 , suitable for all ages x_2 and its cost is x_3 . For the decision committee $\{e_1, e_2, e_3\}$ weight vector $(0.4, 0.3, 0.3)^T$, (x_1, x_2, x_3) . Weight vector for qualities are $w = (0.4, 0.3, 0.3)^T$ and $(\frac{1}{3}, \frac{1}{3}, \frac{1}{3})$. Additionally, let $g(x) = x^r$ is a continuous strictly monotone increasing function. Now let $g(x)$ for $r = 1$ and then perform the steps in section 5.1 according to the truth value of the transformations and scoring function.

i) The table showing single valued neutrosophic numbers for the alternatives evaluated by the decision makers is as follows.

Table : (Decision matrix created by e_1 decision maker)

	u_1	u_2	u_3
x_1	(0.8,0.5,0.3)	(0.3,0.8,0.6)	(0.8,0.1,0.3)
x_2	(0.3,0.4,0.5)	(0.8,0.2,0.3)	(0.6,0.2,0.3)
x_3	(0.7,0.2,0.3)	(0.6,0.1,0.3)	(0.4,0.2,0.6)
x_4	(0.4,0.5,0.3)	(0.9,0.1,0.1)	(0.8,0.4,0.1)
x_5	(0.4,0.3,0.2)	(0.7,0.1,0.3)	(0.9,0.1,0.0)

Table : (decision matrix created by e_2 decision maker)

	u_1	u_2	u_3
x_1	(0.6,0.3,0.3)	(0.5,0.3,0.3)	(0.7,0.2,0.3)
x_2	(0.6,0.2,0.3)	(0.6,0.3,0.2)	(0.4,0.3,0.4)
x_3	(0.8,0.2,0.1)	(0.6,0.2,0.2)	(0.5,0.3,0.3)
x_4	(0.6,0.2,0.2)	(0.7,0.3,0.1)	(0.8,0.2,0.2)
x_5	(0.7,0.2,0.2)	(0.8,0.1,0.2)	(0.7,0.3,0.1)

Table : (decision matrix created by e_3 decision maker)

	u_1	u_2	u_3
x_1	(0.7,0.2,0.2)	(0.7,0.2,0.2)	(0.9,0.1,0.1)
x_2	(0.7,0.2,0.3)	(0.7,0.1,0.2)	(0.5,0.3,0.2)
x_3	(0.7,0.1,0.3)	(0.5,0.3,0.3)	(0.6,0.2,0.3)
x_4	(0.5,0.1,0.3)	(0.8,0.1,0.2)	(0.9,0.1,0.2)
x_5	(0.8,0.1,0.1)	(0.6,0.3,0.2)	(0.8,0.2,0.1)

ii) Transformed decision-making matrices created by decision makers;

Table : (transformed decision matrix created by e_1 decision maker)

	u_1	u_2	u_3
x_1	$\langle\langle 0.0,1.5,2.8 \rangle\rangle; 0.8,0.5,0.3$	$\langle\langle -1.1, -0.4,0.1 \rangle\rangle; 0.3,0.8,0.6$	$\langle\langle 0.4,1.9,3.6 \rangle\rangle; 0.8,0.1,0.3$
x_2	$\langle\langle -0.6,0.2,1.1 \rangle\rangle; 0.3,0.4,0.5$	$\langle\langle 0.3,1.8,3.4 \rangle\rangle; 0.8,0.2,0.3$	$\langle\langle 0.1,1.4,2.8 \rangle\rangle; 0.6,0.2,0.3$
x_3	$\langle\langle 0.2,1.6,3.1 \rangle\rangle; 0.7,0.2,0.3$	$\langle\langle 0.2,1.5,3.0 \rangle\rangle; 0.6,0.1,0.3$	$\langle\langle -0.4,0.4,1.6 \rangle\rangle; 0.4,0.2,0.6$
x_4	$\langle\langle -0.4,0.7,1.6 \rangle\rangle; 0.4,0.5,0.3$	$\langle\langle 0.7,2.5,4.3 \rangle\rangle; 0.9,0.1,0.1$	$\langle\langle 0.3,2.0,3.4 \rangle\rangle; 0.8,0.4,0.1$
x_5	$\langle\langle -0.1,1.1,2.2 \rangle\rangle; 0.4,0.3,0.2$	$\langle\langle 0.3,1.7,3.3 \rangle\rangle; 0.7,0.1,0.3$	$\langle\langle 0.8,2.7,4.5 \rangle\rangle; 0.9,0.1,0.0$

Table : (transformed decision matrix created by e_2 decision maker)

	u_1	u_2	u_3
x_1	$\langle\langle 0.0,1.3,2.6 \rangle\rangle; 0.6,0.3,0.3$	$\langle\langle -0.1,1.1,2.3 \rangle\rangle; 0.5,0.3,0.3$	$\langle\langle 0.2,1.6,3.1 \rangle\rangle; 0.7,0.2,0.3$
x_2	$\langle\langle 0.1,1.4,2.8 \rangle\rangle; 0.6,0.2,0.3$	$\langle\langle 0.1,1.5,2.8 \rangle\rangle; 0.6,0.3,0.2$	$\langle\langle -0.3,0.7,1.8 \rangle\rangle; 0.4,0.3,0.4$
x_3	$\langle\langle 0.5,2.2,3.8 \rangle\rangle; 0.8,0.2,0.1$	$\langle\langle 0.2,1.6,3.0 \rangle\rangle; 0.6,0.2,0.2$	$\langle\langle -0.1,1.1,2.3 \rangle\rangle; 0.5,0.3,0.3$
x_4	$\langle\langle 0.2,1.6,3.0 \rangle\rangle; 0.6,0.2,0.2$	$\langle\langle 0.3,1.9,3.3 \rangle\rangle; 0.7,0.3,0.1$	$\langle\langle 0.4,2.0,3.6 \rangle\rangle; 0.8,0.2,0.2$
x_5	$\langle\langle 0.3,1.8,3.3 \rangle\rangle; 0.7,0.2,0.2$	$\langle\langle 0.5,2.1,3.8 \rangle\rangle; 0.8,0.1,0.2$	$\langle\langle 0.3,1.9,3.3 \rangle\rangle; 0.7,0.3,0.1$

Table : (transformed decision matrix created by e_3 decision maker)

	u_1	u_2	u_3
x_1	$\langle(0.3,1.8,3.3); 0.7,0.2,0.2\rangle$	$\langle(0.3,1.8,3.3); 0.7,0.2,0.2\rangle$	$\langle(0.7,2.5,4.3); 0.9,0.1,0.1\rangle$
x_2	$\langle(0.2,1.6,3.1); 0.7,0.2,0.3\rangle$	$\langle(0.4,1.9,3.5); 0.7,0.1,0.2\rangle$	$\langle(0.0,1.3,2.5); 0.5,0.3,0.2\rangle$
x_3	$\langle(0.3,1.7,3.3); 0.7,0.1,0.3\rangle$	$\langle(-0.1,1.1,2.3); 0.5,0.3,0.3\rangle$	$\langle(0.1,1.4,2.8); 0.6,0.2,0.3\rangle$
x_4	$\langle(0.1,1.3,2.7); 0.5,0.1,0.3\rangle$	$\langle(0.5,2.1,3.8); 0.8,0.1,0.2\rangle$	$\langle(0.6,2.3,4.1); 0.9,0.1,0.2\rangle$
x_5	$\langle(0.6,2.3,4.0); 0.8,0.1,0.1\rangle$	$\langle(0.1,1.5,2.8); 0.6,0.3,0.2\rangle$	$\langle(0.5,2.2,3.8); 0.8,0.2,0.1\rangle$

iii) Transformed weighted decision matrices generated by decision makers;

Table : (transformed weighted decision matrix created by e_1 decision maker)

	u_1	u_2	u_3
x_1	$\langle(0.00,0.60,1.12); 0.8,0.5,0.3\rangle$	$\langle(-0.44, -0.16,0.04); 0.3,0.8,0.6\rangle$	$\langle(0.16,0.76,1.44); 0.8,0.1,0.3\rangle$
x_2	$\langle(-0.24,0.08,0.44); 0.3,0.4,0.5\rangle$	$\langle(0.12,0.72,1.36); 0.8,0.2,0.3\rangle$	$\langle(0.04,0.56,1.12); 0.6,0.2,0.3\rangle$
x_3	$\langle(0.08,0.64,1.24); 0.7,0.2,0.3\rangle$	$\langle(0.08,0.60,1.20); 0.6,0.1,0.3\rangle$	$\langle(-0.16,0.16,0.64); 0.4,0.2,0.6\rangle$
x_4	$\langle(-0.16,0.28,0.64); 0.4,0.5,0.3\rangle$	$\langle(0.28,1.00,1.72); 0.9,0.1,0.1\rangle$	$\langle(0.12,0.80,1.36); 0.8,0.4,0.1\rangle$
x_5	$\langle(-0.04,0.44,0.88); 0.4,0.3,0.2\rangle$	$\langle(0.12,0.68,1.32); 0.7,0.1,0.3\rangle$	$\langle(0.32,1.08,1.80); 0.9,0.1,0.0\rangle$

Table 1 : (transformed weighted decision matrix created by e_2 decision maker)

	u_1	u_2	u_3
x_1	$\langle(0.00,0.39,0.78); 0.6,0.3,0.3\rangle$	$\langle(-0.03,0.33,0.69); 0.5,0.3,0.3\rangle$	$\langle(0.06,0.48,0.93); 0.7,0.2,0.3\rangle$
x_2	$\langle(0.03,0.42,0.84); 0.6,0.2,0.3\rangle$	$\langle(0.03,0.45,0.84); 0.6,0.3,0.2\rangle$	$\langle(-0.09,0.21,0.54); 0.4,0.3,0.4\rangle$
x_3	$\langle(0.15,0.66,1.14); 0.8,0.2,0.1\rangle$	$\langle(0.06,0.48,0.90); 0.6,0.2,0.2\rangle$	$\langle(-0.03,0.33,0.69); 0.5,0.3,0.3\rangle$
x_4	$\langle(0.06,0.48,0.90); 0.6,0.2,0.2\rangle$	$\langle(0.09,0.57,0.99); 0.7,0.3,0.1\rangle$	$\langle(0.12,0.60,1.08); 0.8,0.2,0.2\rangle$
x_5	$\langle(0.09,0.54,0.99); 0.7,0.2,0.2\rangle$	$\langle(0.15,0.63,1.14); 0.8,0.1,0.2\rangle$	$\langle(0.09,0.57,0.99); 0.7,0.3,0.1\rangle$

Table 11: (transformed weighted decision matrix created by e_3 decision maker)

	u_1	u_2	u_3
x_1	$\langle\langle(0.09,0.54,0.99); 0.7,0.2,0.2\rangle\rangle$	$\langle\langle(0.09,0.54,0.99); 0.7,0.2,0.2\rangle\rangle$	$\langle\langle(0.21,0.75,1.29); 0.9,0.1,0.1\rangle\rangle$
x_2	$\langle\langle(0.06,0.48,0.93); 0.7,0.2,0.3\rangle\rangle$	$\langle\langle(0.12,0.57,1.05); 0.7,0.1,0.2\rangle\rangle$	$\langle\langle(0.00,0.39,0.75); 0.5,0.3,0.2\rangle\rangle$
x_3	$\langle\langle(0.09,0.51,0.99); 0.7,0.1, .0.3\rangle\rangle$	$\langle\langle(-0.03,0.33,0.69); 0.5, ,0.3,0.3\rangle\rangle$	$\langle\langle(0.03,0.42,0.84); 0.6,0.2,0.3\rangle\rangle$
x_4	$\langle\langle(0.03,0.39,0.81); 0.5,0.1,0.3\rangle\rangle$	$\langle\langle(0.15,0.63,1.14); 0.8,0.1,0.2\rangle\rangle$	$\langle\langle(0.18,0.69,1.23); 0.9,0.1,0.2\rangle\rangle$
x_5	$\langle\langle(0.18,0.69,1.20); 0.8,0.1,0.1\rangle\rangle$	$\langle\langle(0.03,0.45,0.84); 0.6,0.3,0.2\rangle\rangle$	$\langle\langle(0.15,0.66,1.14); 0.8,0.2,0.1\rangle\rangle$

iv)The resulting unified decision matrix;

Table 1 : (unified decision matrix)

	u_1	u_2	u_3
x_1	$\langle\langle(0.027,0.459,0.867); 0.6,0.5,0.3\rangle\rangle$	$\langle\langle(-0.144,0.213,0.516); 0.3,0.8,0.6\rangle\rangle$	$\langle\langle(0.129,0.597,1.98); 0.7,0.2,0.3\rangle\rangle$
x_2	$\langle\langle(-0.045,0.294,0.663); 0.3,0.4,0.5\rangle\rangle$	$\langle\langle(0.081,0.522,0.975); 0.6,0.3,0.3\rangle\rangle$	$\langle\langle(-0.015,0.348,0.723); 0.4,0.3,0.4\rangle\rangle$
x_3	$\langle\langle(0.096,0.543,1.011); 0.7,0.2,0.3\rangle\rangle$	$\langle\langle(0.033,0.423,0.837); 0.5,0.3,0.3\rangle\rangle$	$\langle\langle(-0.048,0.273,0.651); 0.4,0.3,0.6\rangle\rangle$
x_4	$\langle\langle(-0.021,0.345,0.705); 0.4,0.5,0.3\rangle\rangle$	$\langle\langle(0.156,0.660,1.155); 0.7,0.3,0.2\rangle\rangle$	$\langle\langle(0.126,0.627,1.101); 0.8,0.4,0.2\rangle\rangle$
x_5	$\langle\langle(0.069,0.501,0.921); 0.4,0.3,0.2\rangle\rangle$	$\langle\langle(0.009,0.528,0.990); 0.6,0.3,0.3\rangle\rangle$	$\langle\langle(0.168,0.693,1.179); 0.7,0.3,0.1\rangle\rangle$

v) Generalized single valued triangular neutrosophic numbers obtained from the unified decision matrix for the alternatives;

$$\widetilde{A}_1 = \text{GSVTNGWAO}_{x_1}(u_1, u_2, u_3) \quad \langle\langle(0.015,0.426,0.831); 0.3,0.8,0.6\rangle\rangle$$

$$\widetilde{A}_2 = \text{GSVTNGWAO}_{x_2}(u_1, u_2, u_3) \quad \langle\langle(0.001,0.378, ,0.774); 0.3,0.4,0.5\rangle\rangle$$

$$\widetilde{A}_3 = \text{GSVTNGWAO}_{x_3}(u_1, u_2, u_3) \quad \langle\langle(0.033,0.426,0.850); 0.4,0.3,0.6\rangle\rangle$$

$$\widetilde{A}_4 = \text{GSVTNGWAO}_{x_4}(u_1, u_2, u_3) \quad \langle\langle(0.076,0.524,0.958); 0.4,0.5,0.3\rangle\rangle$$

$$\widetilde{A}_5 = \text{GSVTNGWAO}_{x_5}(u_1, u_2, u_3) \quad \langle\langle(0.105,0.566,1.019); 0.4,0.3,0.3\rangle\rangle$$

vi) According to the values in v);

$$S_T(\widetilde{A}_1) \quad 2,15$$

$$S_T(\widetilde{A}_2) \quad 2,11$$

$$S_T(\widetilde{A}_3) \quad 2,08$$

$$S_T(\widetilde{A}_4) \quad 2,04$$

$$S_T(\widetilde{A}_5) \quad 1,99$$

Hence $x_1 < x_2 < x_3 < x_4 < x_5$. So the best alternative drug is x_5 .

If $g(x) = x^2$ is taken in example 6.2 for $r = 2$;

$$S_T(\widetilde{A}_1) \quad 2,12$$

$$S_T(\widetilde{A}_2) \quad 2,08$$

$$S_T(\widetilde{A}_3) \quad 2,06$$

$$S_T(\widetilde{A}_4) \quad 2,01$$

$$S_T(\widetilde{A}_5) \quad 1,97$$

Hence, $x_1 < x_2 < x_3 < x_4 < x_5$. So the best alternative drug is x_5 .

If $g(x) = x^5$ is taken in example 6.2 for $r = 5$;

$$S_T(\widetilde{A}_1) \quad 2,14$$

$$S_T(\widetilde{A}_2) \quad 2,09$$

$$S_T(\widetilde{A}_3) \quad 2,04$$

$$S_T(\widetilde{A}_4) \quad 1,97$$

$$S_T(\widetilde{A}_5) \quad 1,92$$

Hence, $x_1 < x_2 < x_3 < x_4 < x_5$. So the best alternative drug is x_5 .

If $g(x) = x^{0.04}$ is taken in example 6.2 for $r = 0.04$;

$$S_T(\widetilde{A}_1) \quad 2,246$$

$$S_T(\widetilde{A}_2) \quad 2,240$$

$$S_T(\widetilde{A}_3) \quad 2,237$$

$$S_T(\widetilde{A}_4) \quad 2,234$$

$$S_T(\widetilde{A}_5) \quad 2,231$$

Hence, $x_1 < x_2 < x_3 < x_4 < x_5$. So the best alternative drug is x_5 .

Example . : If the same assumption in Example 6.2 applies to decision making based on indeterminacy;
 i) If $g(x) = x$ is taken for $r = 1$;

$$S_I(\widetilde{A}_1) \quad 1,185$$

$$S_I(\widetilde{A}_2) \quad 1,160$$

$$S_I(\widetilde{A}_3) \quad 1,148$$

$$S_I(\widetilde{A}_4) \quad 1,113$$

$$S_I(\widetilde{A}_5) \quad 1,087$$

Hence, $x_1 < x_2 < x_3 < x_4 < x_5$. So the best alternative drug is x_5 .

ii) If $g(x) = x^2$ is taken for $r = 2$;

$$S_I(\widetilde{A}_1) \quad 1,169$$

$$S_I(\widetilde{A}_2) \quad 1,140$$

$$S_I(\widetilde{A}_3) \quad 1,133$$

$$S_I(\widetilde{A}_4) \quad 1,094$$

$$S_I(\widetilde{A}_5) \quad 1,071$$

Hence, $x_1 < x_2 < x_3 < x_4 < x_5$. So the best alternative drug is x_5 .

iii) If $g(x) = x^5$ is taken for $r = 5$;

$$S_I(\widetilde{A}_1) \quad 1,195$$

$$S_I(\widetilde{A}_2) \quad 1,163$$

$$S_I(\widetilde{A}_3) \quad 1,127$$

$$S_I(\widetilde{A}_4) \quad 1,072$$

$$S_I(\widetilde{A}_5) \quad 1,045$$

Hence, $x_1 < x_2 < x_3 < x_4 < x_5$. So the best alternative drug is x_5 .

iv) If $g(x) = x^{0.04}$ is taken for $r = 0.04$;

$$S_I(\widetilde{A}_1) = 1,245$$

$$S_I(\widetilde{A}_2) = 1,243$$

$$S_I(\widetilde{A}_3) = 1,242$$

$$S_I(\widetilde{A}_4) = 1,241$$

$$S_I(\widetilde{A}_5) = 1,238$$

Hence, $x_1 < x_2 < x_3 < x_4 < x_5$. So the best alternative drug is x_5 .

Example . : If the same assumption in Example 6.2 applies to decision making based on falsity;

i) If $g(x) = x$ is taken for $r = 1$;

$$S_F(\widetilde{A}_1) = 1,173$$

$$S_F(\widetilde{A}_2) = 1,127$$

$$S_F(\widetilde{A}_3) = 1,104$$

$$S_F(\widetilde{A}_4) = 1,094$$

$$S_F(\widetilde{A}_5) = 1,063$$

Hence, $x_1 < x_2 < x_3 < x_4 < x_5$. So the best alternative drug is x_5 .

ii) If $g(x) = x^2$ is taken for $r = 2$;

$$S_F(\widetilde{A}_1) = 1,154$$

$$S_F(\widetilde{A}_2) = 1,106$$

$$S_F(\widetilde{A}_3) = 1,087$$

$$S_F(\widetilde{A}_4) = 1,073$$

$$S_F(\widetilde{A}_5) = 1,046$$

Hence, $x_1 < x_2 < x_3 < x_4 < x_5$. So the best alternative drug is x_5 .

iii) If $g(x) = x^5$ is taken for $r = 5$;

$$S_F(\widetilde{A}_1) = 1,179$$

$$S_F(\widetilde{A}_2) = 1,129$$

$$S_F(\widetilde{A}_3) = 1,076$$

$$S_F(\widetilde{A}_4) = 1,055$$

$$S_F(\widetilde{A}_5) = 1,027$$

Hence, $x_1 < x_2 < x_3 < x_4 < x_5$. So the best alternative drug is x_5 .

iv) If $g(x) = x^{0.04}$ is taken for $r = 0.04$;

$$S_F(\widetilde{A}_1) = 1,246$$

$$S_F(\widetilde{A}_2) = 1,240$$

$$S_F(\widetilde{A}_3) = 1,238$$

$$S_F(\widetilde{A}_4) = 1,239$$

$S_F(\widetilde{A}_5) = 1,236$ hence $x_1 < x_2 < x_4 < x_3 < x_5$. So the best alternative drug is x_5 .

Table 1 : (Results obtained according to r in Example 6.2, example6.3 and example 6.4)

Value of R	The result according to the value of truth	The result according to the value of indeterminacy	The result according to the value of falsity
r 1	$x_1 < x_2 < x_3 < x_4 < x_5$	$x_1 < x_2 < x_3 < x_4 < x_5$	$x_1 < x_2 < x_3 < x_4 < x_5$
r 2	$x_1 < x_2 < x_3 < x_4 < x_5$	$x_1 < x_2 < x_3 < x_4 < x_5$	$x_1 < x_2 < x_3 < x_4 < x_5$
r 5	$x_1 < x_2 < x_3 < x_4 < x_5$	$x_1 < x_2 < x_3 < x_4 < x_5$	$x_1 < x_2 < x_3 < x_4 < x_5$
r 0.04	$x_1 < x_2 < x_3 < x_4 < x_5$	$x_1 < x_2 < x_3 < x_4 < x_5$	$x_1 < x_2 < x_4 < x_3 < x_5$

. COMPARISON ANALYSIS AND DISCUSSION

Table 1 : (Results obtained from methods)

	r 1	r 2	r 5
Method 1	$x_1 < x_2 < x_3 < x_4$	$x_2 < x_1 < x_3 < x_4$	$x_1 < x_2 < x_3 < x_4$
Method 2	$x_2 < x_1 < x_3 < x_4$	$x_2 < x_1 < x_3 < x_4$	$x_2 < x_1 < x_3 < x_4$
Method 3	$x_3 < x_1 < x_2 < x_4$	$x_3 < x_2 < x_1 < x_4$	$x_1 < x_3 < x_2 < x_4$
Method 4	$x_1 < x_2 < x_3 < x_4$	$x_1 < x_2 < x_3 < x_4$	$x_1 < x_2 < x_3 < x_4$

To be able to see the effect of the method given in section 6; we compared the results of the method with those of the method in Section 6. For the same r values were comparable a method obtained according to the truth value, indeterminacy value and falsity value in section 6. According to Table 14; the best alternative to the results from all methods is the same and it is x_4 . Besides; Hamacher aggregation operators are used for single valued neutrosophic numbers. In the chapter 5, we used generalized single valued triangular neutrosophic numbers obtained by transformed single valued neutrosophic numbers. With these numbers, we used the

operators we have generalized to the operators given for intuitionistic fuzzy numbers. These operators include previously given operators for single valued triangular neutrosophic numbers. Thus, in section 6 we used single valued triangular neutrosophic numbers and more general operators used in many decision making methods. We also compared the score and certainty functions used in Table 1 and used in Section 6. In this comparison, the values are not equal according to the scoring functions in Section 6 and therefore we have achieved different results. In addition, we have the possibility to obtain separate results according to the value of truth, falsity and indeterminacy in order to decide on the method in section 6. Thus, we have obtained a more comprehensive result. For this reason, the method in section 6 is effective and applicable.

. CONCLUSION

In this study, we generalized single valued triangular neutrosophic numbers. Thus, we have defined a new set of numbers that can be more useful and can be very applicable. We have also obtained generalized single valued triangular neutrosophic numbers by converting single valued neutrosophic numbers according to their truth, indeterminacy and falsity values separately. Thus, single valued neutrosophic numbers are transformed into generalized single valued triangular neutrosophic numbers, which are a special case and have a lot of application field. We then defined the Hamming distance for single valued triangular neutrosophic numbers and gave some properties. We have defined the scoring and certainty functions based on this defined distance. We also extended operators for intuitionistic fuzzy numbers to single valued triangular neutrosophic numbers. Finally, we compared multi-attribute group decision making with generalized operators and new score functions, and compared the results with a previous multi-attribute group decision making application. In addition to this, the applied multi-attribute group decision making method can be used in many different scientific researches.

REFERENCES

- Atanassov, K. (1986). Intuitionistic fuzzy sets, *Fuzzy Sets Systems*, 20, 87–96
- Biswas, P., Pramanik, S. & Giri, B., C. (2016). Value and ambiguity index based ranking method of single-valued trapezoidal neutrosophic numbers and its application to multi-attribute decision making, *Neutrosophic Sets System*, 12, 127–138
- Biswas, P., Pramanik, S., & Giri, B.C. (2016). Cosine similarity measure based multi-attribute decision-making with trapezoidal fuzzy neutrosophic numbers, *Neutrosophic Sets System*, 8, 47–57
- Biswas, P., Pramanik, S., & Giri, B.C. (2016). Aggregation of triangular fuzzy neutrosophic set information and its application to multi-attribute decision making, *Neutrosophic Sets System*, 12, 20–40
- Liu, P. & Li, H. (2017). Multi attribute decision-making method based on some normal neutrosophic Bonferroni mean operators, *Neural Computing and Applications*, 28, 1, 179-194, DOI 10.1007/s00521-015-2048-z
- Liu, C. & Luo, Y. (2017). Power aggregation operators of simplifield neutrosophic sets and their use in multi-attribute group decision making, *IEE/CAA Journal of Automatica Sinica*, 99, DOI: 10.1109/JAS.2017.7510424
- Liu, P., Chu, Y., Li, Y. & Chen, Y. (2014). Some generalized neutrosophic number Hamacher aggregation operators and their application to group decision making, *International Journal of fuzzy systems*, 16, 2
- Li, D., F. (2010). A ratio ranking method of triangular intuitionistic fuzzy numbers and its application to MADM problems, *Computer and Mathematics with applications*, 60, 1557-1570.
- Şahin M., Ecemiş O., Uluçay V., & Kargin, A. (2017). Some new generalized aggregation operators based on centroid single valued triangular neutrosophic numbers and their applications in multi-attribute decision making,
- Sahin, R. & Liu, P. (2017). Some approaches to multi criteria decision making based on exponential operations of simplified neutrosophic numbers, *Journal of Intelligent & Fuzzy Systems*, 32, 3, 2083-2099, DOI: 10.3233/JIFS-161695
- Smarandache, F. (1998). *A unifying field in logics, neutrosophy: neutrosophic probability, set and logic*, Rehoboth, American Research Press
- Smarandache F. (2006). *Neutrosophic set, a generalization of the intuitionistic fuzzy set*, In 2006 IEEE international conference on granular computing, 38-42, DOI: 10.1109/GRC.2006.1635754.

- Abdel-Basset, M., Mohamed, M., Smarandache, F., & Chang, V. (2018). Neutrosophic Association Rule Mining Algorithm for Big Data Analysis. *Symmetry*, 10(4), 106.
- Abdel-Basset, M., & Mohamed, M. (2018). The Role of Single Valued Neutrosophic Sets and Rough Sets in Smart City: Imperfect and Incomplete Information Systems. Measurement. Volume 124, August 2018, Pages 47-55
- Abdel-Basset, M., Gunasekaran, M., Mohamed, M., & Smarandache, F. A novel method for solving the fully neutrosophic linear programming problems. *Neural Computing and Applications*, 1-11.
- Abdel-Basset, M., Manogaran, G., Gamal, A., & Smarandache, F. (2018). A hybrid approach of neutrosophic sets and DEMATEL method for developing supplier selection criteria. *Design Automation for Embedded Systems*, 1-22.
- Abdel-Basset, M., Mohamed, M., & Chang, V. (2018). NMCDA: A framework for evaluating cloud computing services. *Future Generation Computer Systems*, 86, 12-29.
- Abdel-Basset, M., Mohamed, M., Zhou, Y., & Hezam, I. (2017). Multi-criteria group decision making based on neutrosophic analytic hierarchy process. *Journal of Intelligent & Fuzzy Systems*, 33(6), 4055-4066.
- Abdel-Basset, M.; Mohamed, M.; Smarandache, F. An Extension of Neutrosophic AHP–SWOT Analysis for Strategic Planning and Decision-Making. *Symmetry* 2018, 10, 116.
- Smarandache, F. (1998). Neutrosophy: neutrosophic probability, set, and logic, *ProQuest Information & Learning*, Ann Arbor, Michigan, USA, 105; <http://fs.gallup.unm.edu/eBook-neutrosophics6.pdf> (online edition); reviewed in Zentralblatt fuer Mathematik (Berlin, Germany): <https://zbmath.org/?q=an:01273000>
- Smarandache F. (2016). Neutrosophic overset, neutrosophic underset, and neutrosophic offset, *Similarly for Neutrosophic Over-/Under-/Off- Logic, Probability, and Statistics*, 168, Pons Editions, Brussels, Belgium, , on Cornell University's website: <https://arxiv.org/ftp/arxiv/papers/1607/1607.00234.pdf> and in France at the international scientific database: <https://hal.archives-ouvertes.fr/hal-01340830>
- Subas, Y. (2015). *Neutrosophic Numbers and their application to Multi attribute decision making problems* Unpublished doctoral dissertation or master's theses, Kilis 7 Aralık University, Graduate School of Natural and Applied Science, Turkey
- Wang, H., Smarandache, F., Zhang, Y., Q. & Sunderraman, R. (2010). Single valued neutrosophic sets. *Multispace Multistructure*, 4, 410–413.
- Wan S. P. & Dong J. Y. (2015). Power geometric operators of trapezoidal intuitionistic fuzzy numbers and application to multi attribute group decision making, *Applied Soft Computing*, 29, 153-168.
- Wan, S., P., Wang, F., Li, L. & Dong., J., Y. (2016). Some generalized aggregation operators for triangular intuitionistic fuzzy numbers and application to multi attribute group decision making, *Computer & Industrial Engineering*, 286-301.
- Ye, J. (2015). Trapezoidal neutrosophic set and its application to multiple attribute decision-making. *Neural Computing and Applications*, doi: 10.1007/s00521-014-1787-6
- Zadeh, L., A. (1965). Fuzzy sets, *Information and Control*, 8, 338–353

Special issue on “Applications of neutrosophic theory in decision making-recent advances and future trends”

Mohamed Abdel-Basset, Florentin Smarandache, Jun Ye

Mohamed Abdel-Basset, Florentin Smarandache, Jun Ye (2019). Special issue on “Applications of neutrosophic theory in decision making-recent advances and future trends”. *Complex & Intelligent Systems*, 2; DOI: 10.1007/s40747-019-00127-1

Multicriteria decision-making (MCDM) is a modeling and methodological tool for dealing with complex engineering problems. In these problems, sometimes, it is challenging for decision-makers to find solutions because the information they get may be incomplete and vague.

The management of uncertainty within decision-making problems is still a very challenging research issue despite the different proposals developed across the time. One of the most interesting research topics in recent years is the use of neutrosophic sets in decision-making processes. Neutrosophic sets and logic are generalizations of fuzzy and intuitionistic fuzzy sets and logic.

Neutrosophic logic and set are gaining significant attention in solving many real-life problems that involve uncertainty, impreciseness, vagueness, incompleteness, inconsistent, and indeterminacy. A number of new neutrosophic theories have been proposed and have been applied in computational intelligence, multiple-attribute decision-making, image processing, medical diagnosis, fault diagnosis, optimization design, and so on.

This special issue includes seven papers on decision-making theory and applications using neutrosophic theory.

They have been selected after a peer-review process with at least three reviewers per papers.

The first paper titled *A New Attribute Sampling Plan Using Neutrosophic Statistical Interval Method*, by Muhammad Aslam, proposed a new attribute sampling plan using the neutrosophic interval method. The lot acceptance, rejection, and indeterminate probabilities are computed using the neutrosophic binomial distribution at various specified parameters such as sample size and acceptance number. The efficiency of the proposed sampling plan is also discussed. A real example is also added to explain the proposed sampling plan.

The second paper titled *Shortest Path Problem in Fuzzy, Intuitionistic Fuzzy and Neutrosophic Environment: An Overview*, by Said et al., introduced a survey on a shortest path problem with various existing algorithms in fuzzy, intuitionistic fuzzy and neutrosophic environment. This paper will be very helpful to the new researchers to propose novel concepts to solve the shortest path problem. In the future, based on this paper, new algorithms and frameworks will be designed to find the shortest path for a given network under various types of set environments.

The third paper titled *TODIM Strategy for Multi Attribute Group Decision Making in Trapezoidal Neutrosophic Number Environment*, by Surapati Pramanik and Rama Mallick, proposed a trapezoidal neutrosophic multiple-attribute group decision-making strategy, namely TODIM strategy in which the evaluation values of alternatives over the attributes assume the form of trapezoidal neutrosophic numbers. The advantage of the proposed strategy is that it is more suitable for solving multiple-attribute group decision-making problems with trapezoidal neutrosophic information because trapezoidal neutrosophic number can handle indeterminate and inconsistent information and are the extension of trapezoidal intuitionistic fuzzy numbers. A comparison analysis is also provided.

The fourth paper titled *The Shortest Path Problem In Interval Valued Trapezoidal and Triangular Neutrosophic*

Environment, by Broumi et al., proposed a new score function for interval-valued neutrosophic numbers and shortest path problem is solved using interval-valued neutrosophic numbers. Also, novel algorithms are proposed to find the neutrosophic shortest path by considering interval valued neutrosophic number, trapezoidal and triangular interval-valued neutrosophic numbers for the length of the path in a network with illustrative example. A comparative analysis has been done for the proposed algorithm with the existing method with the shortcoming and advantage of the proposed method and it shows the effectiveness of the proposed algorithm.

The fifth paper titled *Neutrosophic Analysis of Variance: Application to University Students*, by Muhammad Aslam, introduced a new concept called, neutrosophic analysis of variance (NANOVA). The proposed NANOVA is the generalization of the existing ANOVA under classical statistics. The proposed method has the ability to be applied effectively than the existing under uncertainty. A NANOVA table from a real example shows that sum squares were in indeterminacy interval.

The sixth paper titled *Shortest Path Problem using Bellman Algorithm under Neutrosophic Environment*, by Broumi et al., proposed a novel algorithm to obtain the neutrosophic shortest path between each pair of nodes. Length of all the edges is accredited an interval-valued neutrosophic set. For the validation of the proposed algorithm, a numerical

example has been offered. A comparative analysis has been done with the existing methods which exhibit the advantages of the new algorithm.

The seventh paper titled *A New Approach on Differential Equations Via Trapezoidal Neutrosophic Number*, by I. R. Sumathi and C. Antony Crispin, derived the solution of the second-order differential equation in neutrosophic environment. An example is given to demonstrate the strong solution of the same.

We hope this issue will provide a useful resource of ideas, techniques, and methods for the research on the theory and applications of neutrosophic theory and the decision-making problems. We thank all the authors whose contributions and efforts made the publication of this issue possible. We are also grateful to the referees for their valuable and highly appreciated works contributed to select the high quality of papers published in this issue. Finally, our sincere thanks go to Prof. Yaochu Jin, Editor-in-Chief, for his support throughout the process of editing this issue.

A Bipolar Neutrosophic Multi Criteria Decision Making Framework for Professional Selection

Mohamed Abdel-Basset, Abdullallah Gamal, Le Hoang Son, Florentin Smarandache

Mohamed Abdel-Basset, Abdullallah Gamal, Le Hoang Son, Florentin Smarandache (2020). A Bipolar Neutrosophic Multi Criteria Decision Making Framework for Professional Selection. *Applied Sciences*, 10, 1202; DOI: 10.3390/app10041202

Abstract: Professional selection is a significant task for any organization that aims to select the most appropriate candidates to fill well-defined vacancies up. In the recruitment process, various individual characteristics are involved, such as leadership, analytical skills, independent thinking, innovation, stamina and personality, ambiguity and imprecision. It outlines staff contribution and therefore plays a significant part in human resources administration. Additionally, in the era of the Internet of Things and Big Data (IoTBD), professional selection would face several challenges not only to the safe selection and security but also to make wise and prompt decisions especially in the large-scale candidates and criteria from the Cloud. However, the process of professional selection is often led by experience, which contains vague, ambiguous and uncertain decisions. It is therefore necessary to design an efficient decision-making algorithm, which could be further escalated to IoTBD. In this paper, we propose a new hybrid neutrosophic multi criteria decision making (MCDM) framework that employs a collection of neutrosophic analytical network process (ANP), and order preference by similarity to ideal solution (TOPSIS) under bipolar neutrosophic numbers. The MCDM framework is applied for chief executive officer (CEO) selection in a case study at the Elsewedy Electric Group, Egypt. The proposed approach allows us to assemble individual evaluations of the decision makers and therefore perform accurate personnel selection. The outcomes of the proposed method are compared with those of the related works such as weight sum model (WSM), weight product model (WPM), analytical hierarchy process (AHP), multi-objective optimization based on simple ratio analysis (MOORA) and ANP methods to prove and validate the results.

Keywords: personnel selection; neutrosophic ANP; neutrosophic TOPSIS; bipolar neutrosophic numbers; chief executive officer

1. Introduction

Human resources are considered as one of the most important assets for an organization to improve its advantages of real wealth in knowledge economy [1,2]. The interest of organizations and large institutions in human capitals contributes to significant investment. Therefore, many organizations give a clear interest in the process of personnel selection to represent a positive turning point in relation to the organization, relying on them to achieve growth rates; thus supporting in the acquisition of the entire business sector in which the company is located, determining the input quality of human resources and personnel recruitments and choosing directly [3]. Personnel selection

is the procedure of selecting candidates who accord the desired employees and match the skills, knowledge and experience for the respective jobs [4]. Certainly, one of the major causes for the down grade of performance and the productivity of the enterprise is due to poor personnel selection. Inappropriate choices affect not only the level of the individual, but also the production [5–8].

Personnel selection is complicated in the real world, as decision makers tend to decide and forecast based on the qualitative methods, such as interviewing the candidates and knowing them well through conversations and group activities. In contrast, they may have poor judgment on the team and individual performance based on their quantitative metrics, such as productivity, outputs of their contributions and so on. Most often, there are vague expressions and imprecise terms used throughout the process that can make the judgment imprecise and investment on human capitals less productive. To make this forward, a neutrosophic theory is usually applied in decision problems. Neutrosophic research has been well established and demonstrated in supplier selection [9], developing supplier selection criteria [10,11], smart medical device selection [12] or quantifying risks in supply chain [13]. A neutrosophic set is also used to solve complex problems and design interrelationships and interdependencies among criteria and alternatives.

In real life, personnel selection is a Multi-Criteria Decision Making (MCDM) problem, and from the MCDM perspective, it has attracted the attention of many researchers [14]. Jasemi et al. [15] used a new fuzzy ELimination Et Choix Traduisant la REalité (ELECTRE) method for personnel selection. Karabasevic et al. [16] presented an approach for the selection of personnel. Ji et al. [17] used multi-valued neutrosophic sets with a projection-based difference measurement in an acronym in Portuguese for Interactive and Multicriteria Decision Making (TODIM) method. A collection of extensions of the order preference by similarity to ideal solution by Technique for Order of Preference by Similarity to Ideal Solution (TOPSIS) for personnel selection using the interval neutrosophic set has been presented in [18]. Pramanik et al. [19] raised the idea of personal biases in decision making. Personnel selection for IT using Evaluation based on Distance from Average Solution (EDAS) has been demonstrated by [20]. Apart from these researches, other researchers' works could be found in the literature.

Based on the observation, the hybridization could offer better results than the standalone method. The objective of this study is to develop a decision-making approach to a multiple information sources problem, which enables us to incorporate neutrosophic data represented as linguistic variables or bipolar neutrosophic numbers into the analysis, and disregards the troublesome neutrosophic number ranking process that may yield inconsistent results when different ranking methods are used.

In this paper, we propose a new hybrid neutrosophic multi criteria decision making (MCDM) framework that employs a collection of neutrosophic analytical network process (ANP), and order preference by similarity to ideal solution (TOPSIS) under bipolar neutrosophic numbers. This paper hence aims at extending the neutrosophic ANP–TOPSIS for linguistic reasoning under decision making. The extended neutrosophic ANP–TOPSIS is applied for solving a personnel selection problem. Here, neutrosophic ANP can be applied to handle the difficulty of dependency in the problem, in addition to feedback between each quantification criteria. TOPSIS is lastly used to find the best alternative or candidate for professional selection. The MCDM framework is applied for chief executive officer (CEO) selection in a case study at the Elsewedy Electric Group, Egypt. The proposed approach allows us to assemble individual evaluations of the decision makers and therefore perform stronger personnel selection procedures. The outcomes of the proposed method are compared with those of the related works such as weight sum model (WSM), weight product model (WPM), analytical hierarchy process (AHP), multi-objective optimization based on simple ratio analysis (MOORA) and ANP methods to prove and validate the results.

The article is planned as follows: Section 2 presents the literature review. Section 3 describes the background theory including some inceptions on bipolar neutrosophic numbers and proposed model. Section 4 describes a case study to approve the practicality of the ANP–TOPSIS method. Section 5 provides the comparative results. In Section 6, a sensitivity analysis is recognized. Lastly, we conclude our research with some observations.

2. Literature Review

ANP is an inclusive decision-making approach that depends on the dependency between criteria [21]. ANP is an extension for analytical hierarchy process (AHP). By pairwise comparisons, weights or priorities are determined as in AHP. The priority determined to each prospect and criterion may be predestined subjectively by decision makers (DMs), or from the data. ANP provides a scale by the consistency ratio (CR), which is a pointer of the dependability of the method or model, and it is preferred to measure the CR of the DMs' comparison judgment. The CR is determined in such a way that the ratio equals 0.1, denoting compatible judgment, in the case that the ratio overrides 0.1, it denotes incompatible judgment [22]. ANP works for complicated interrelationships between rules, decisions and attributes [21]. ANP method can solve complex problems as in Figure 1.

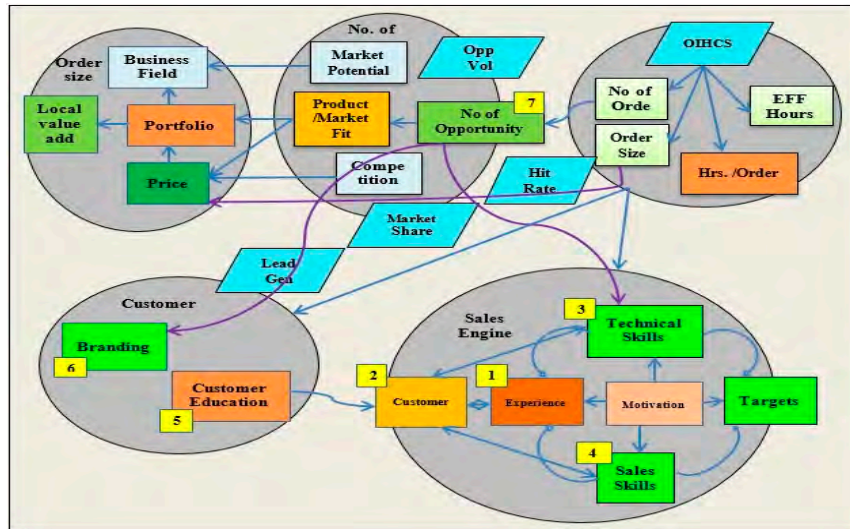

Figure 1. Complex decision problem by the analytical network process (ANP) method.

The ANP method structure allows for feedback and enables us to deal with direct and indirect problems, as in Figure 2. In the ANP method, the relationships and interrelationships among criteria, sub criteria and alternatives cannot be simply designed as direct or indirect, predominant or subsidiary [23].

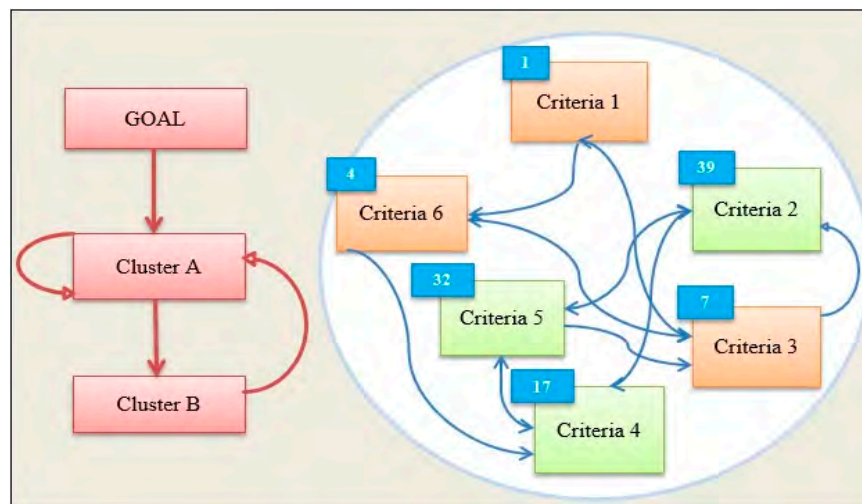

Figure 2. Feedback connections and loop in the ANP method.

TOPSIS depends on the idea that the preferable candidate should not just have the shortest path from the favorable ideal solution, but also has the longest path from the negative ideal solution [24]. The preferable candidate would be the one that is closest to the positive ideal solution and furthest from the negative ideal solution, according to this method [25]. We show that TOPSIS depends on Euclidean distance as in Figure 3.

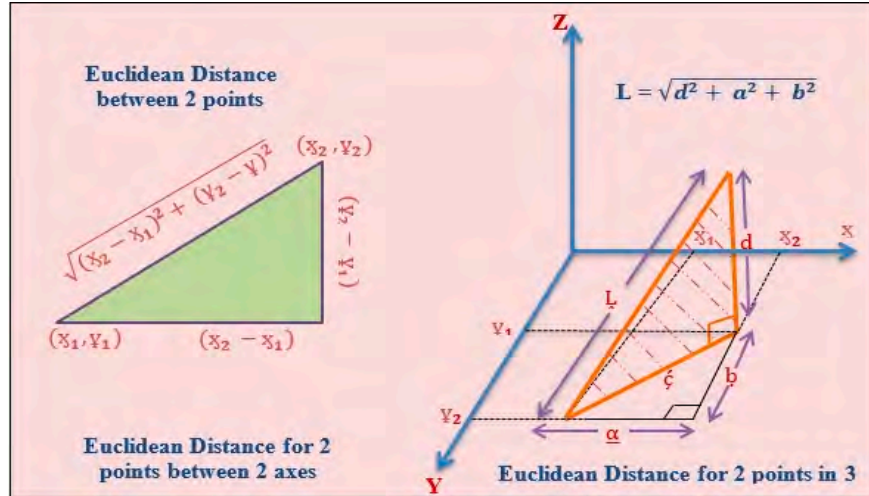

Figure 3. Euclidean distance in the order preference by similarity to ideal solution (TOPSIS) method.

3. Proposed Methodology

In this section, we proposed definitions of bipolar neutrosophic set (BNS), score, accuracy and certainty functions [26–30].

Definition 2.1: A BNS A in X is defined as an object of the form $A = \{ \langle x, T^+(x), I^+(x), F^+(x), T^-(x), I^-(x), F^-(x) \rangle : x \in X \}$, where $T^+, I^+, F^+ : X \rightarrow [1, 0]$ and $T^-, I^-, F^- : X \rightarrow [-1, 0]$. The certain membership standards $T^+(x), I^+(x), F^+(x)$ denote the truth, indeterminate and falsity memberships of a component $x \in X$ corresponding to a BNS A , and the uncertain membership standards $T^-(x), I^-(x)$ and $F^-(x)$ denote the truth, indeterminate and falsity memberships of an element $x \in X$ to some implicit counter property corresponding to a BNS A .

Definition 2.2: Let $A_1 = \{ \langle x, T_1^+(x), I_1^+(x), F_1^+(x), T_1^-(x), I_1^-(x), F_1^-(x) \rangle$ and $A_2 = \{ \langle x, T_2^+(x), I_2^+(x), F_2^+(x), T_2^-(x), I_2^-(x), F_2^-(x) \rangle$ be two bipolar neutrosophic numbers (BNNs). Then their union is distinct as: $(A_1 \cup A_2)(x) = (\max(T_1^+(x), T_2^+(x)), \frac{I_1^+(x) + I_2^+(x)}{2}, \min(F_1^+(x), F_2^+(x)), \min(T_1^-(x), T_2^-(x)), \frac{I_1^-(x) + I_2^-(x)}{2}, \max(F_1^-(x), F_2^-(x)))$ for all $x \in X$.

Definition 2.3: Let $\tilde{a}_1 = (T_1^+, I_1^+, F_1^+, T_1^-, I_1^-, F_1^-)$ then $\tilde{a}_2 = (T_2^+, I_2^+, F_2^+, T_2^-, I_2^-, F_2^-)$ be two BNNs. After that the procedures for NNs are explained as follows:

$$\begin{aligned} \gamma \tilde{a}_1 &= (1 - (1 - T_1^+)^\gamma, (I_1^+)^\gamma, (F_1^+)^\gamma, -(1 - T_1^-)^\gamma, -(1 - I_1^-)^\gamma, -(1 - (1 - F_1^-))^\gamma) \\ \tilde{a}_1^\gamma &= ((T_1^+)^\gamma, 1 - (1 - I_1^+)^\gamma, 1 - (1 - F_1^+)^\gamma, -(1 - (1 - T_1^-))^\gamma, -(1 - I_1^-)^\gamma, -(1 - F_1^-)^\gamma) \\ \tilde{a}_1 + \tilde{a}_2 &= (T_1^+ + T_2^+ - T_1^+ T_2^+, I_1^+ I_2^+, F_1^+ F_2^+, -T_1^- T_2^-, -(1 - I_1^- - I_2^- - I_1^- I_2^-), -(1 - F_1^- - F_2^- - F_1^- F_2^-)) \\ \tilde{a}_1 \cdot \tilde{a}_2 &= (T_1^+ T_2^+, I_1^+ + I_2^+ - I_1^+ I_2^+ + F_1^+ + F_2^+ - F_1^+ F_2^+, -(1 - T_1^- - T_2^- - T_1^- T_2^-), -I_1^- I_2^-, -F_1^- F_2^-) \text{ when } \gamma > 0. \end{aligned}$$

Definition 2.4: Let $\tilde{a}_1 = (T_1^+, I_1^+, F_1^+, T_1^-, I_1^-, F_1^-)$ be a BNN. Then, the score, accuracy and certainty functions $P(\tilde{a}_1), A(\tilde{a}_1)$ and $C(\tilde{a}_1)$ respectively, of an NBN \tilde{a}_1 are well-defined as below:

$$\tilde{P}(\tilde{a}_1) = (T_1^+ + 1 - I_1^+ + 1 - F_1^+ + 1 + T_1^- - I_1^- - F_1^-) / 6 \tag{1}$$

$$\tilde{A}(\tilde{a}_1) = T_1^+ - F_1^+ + T_1^- - F_1^- \tag{2}$$

$$\tilde{C}(\tilde{a}_1) = T_1^+ - F_1^- \tag{3}$$

Definition 2.5: Let $\tilde{a}_1 = (T_1^+, I_1^+, F_1^+, T_1^-, I_1^-, F_1^-)$ and $\tilde{a}_2 = (T_2^+, I_2^+, F_2^+, T_2^-, I_2^-, F_2^-)$ be two BNNs. We will present the comparisons as follows:

if $\tilde{P}(\tilde{a}_1) > \tilde{P}(\tilde{a}_2)$, then $\tilde{a}_1 > \tilde{a}_2$;

$\tilde{P}(\tilde{a}_1) = \tilde{P}(\tilde{a}_2)$ and $\tilde{A}(\tilde{a}_1) > \tilde{A}(\tilde{a}_2)$, then $\tilde{a}_1 > \tilde{a}_2$;

if $\tilde{P}(\tilde{a}_1) = \tilde{P}(\tilde{a}_2)$, $\tilde{A}(\tilde{a}_1) = \tilde{A}(\tilde{a}_2)$ and $\tilde{C}(\tilde{a}_1) > \tilde{C}(\tilde{a}_2)$, then $\tilde{a}_1 > \tilde{a}_2$;

if $\tilde{P}(\tilde{a}_1) = \tilde{P}(\tilde{a}_2)$, $\tilde{A}(\tilde{a}_1) = \tilde{A}(\tilde{a}_2)$ and $\tilde{C}(\tilde{a}_1) > \tilde{C}(\tilde{a}_2)$, then $\tilde{a}_1 = \tilde{a}_2$.

Definition 2.6: Let $\tilde{a}_j = (T_j^+, I_j^+, F_j^+, T_j^-, I_j^-, F_j^-)$ ($j = 1, 2, \dots, n$) be a collection of BNNs. A mapping $A_w: Q_n \rightarrow Q$ is named bipolar neutrosophic weighted average factor if it fulfills the condition:

$$A_w(\tilde{a}_1, \tilde{a}_2, \dots, \tilde{a}_n) = \sum_{j=1}^n w_j \tilde{a}_j = \left\langle 1 - \prod_{j=1}^n (1 - T_j^+)^{w_j}, \prod_{j=1}^n I_j^{+w_j}, \prod_{j=1}^n F_j^{+w_j}, - \prod_{j=1}^n (-T_j^-)^{w_j}, - \prod_{j=1}^n (-I_j^-)^{w_j}, - (1 - \prod_{j=1}^n (1 - (-F_j^-)^{w_j})) \right\rangle$$

when w_j is the weight of \tilde{a}_j ($j = 1, 2, \dots, n$), $w_j \in [0, 1]$ and $\sum_{j=1}^n w_j = 1$.

Then, the steps of the suggested ANP with TOPSIS under neutrosophic environment are presented in details. Illustration of the suggested technique for CEO selection is exhibited in Figure 4.

Step 1. Build the structure of a problem.

The problem or issue should be obviously pointed, and the hierarchy framework established. The hierarchy framework can be designed by DMs' judgments via exchanges of ideas or other suitable techniques, as shown in literature reviews.

Step 2. Estimate of the criteria priority using the pairwise comparisons.

The committee comprises the DMs, collecting pairwise comparisons to determine the proportional weight of criteria and perspectives. In pairwise comparisons, we depended on the scale exhibited in Table 1. In the comparison matrix, the result of a_{ij} illustrates the relative significance of the element on row (i) over the element on column (j), i.e., $a_{ij} = w_i/w_j$. The reciprocal value of the term $\frac{1}{a_{ij}}$, which we replaced by $1/\Delta$ in our comparison matrices, was utilized when the element (j) was more significant than the element (i). The comparison judgment matrix A is outlined below:

$$A = \begin{bmatrix} w_1/w_1 & w_1/w_2 & \dots & w_1/w_n \\ w_2/w_1 & w_2/w_2 & \dots & w_2/w_n \\ \vdots & \vdots & \ddots & \vdots \\ w_n/w_1 & w_n/w_2 & \dots & w_n/w_n \end{bmatrix} = \begin{bmatrix} 0.5 & a_{12} & \dots & a_{1n} \\ 1/a_{21} & 0.5 & \dots & a_{2n} \\ \vdots & \vdots & 0.5 & \vdots \\ 1/a_{n1} & 1/a_{n2} & \dots & 0.5 \end{bmatrix} \tag{4}$$

Table 1. Indications expression for the significance weight of all criteria.

Linguistic Expressions	Bipolar Neutrosophic Numbers Scale for Proportional Significance of Comparison Matrix [$T^+(x), I^+(x), F^+(x), T^-(x), I^-(x), F^-(x)$]
Absolutely Significant (AS)	[0.90, 0.10, 0.10, -0.40, -0.80, -0.90]

Very Highly Significant (VHS)	[0.80, 0.50, 0.50, -0.30, -0.80, -0.80]
Equally Significant (ES)	[0.50, 0.50, 0.50, -0.50, -0.50, -0.50]
Significant (S)	[0.40, 0.20, 0.70, -0.50, -0.20, -0.10]
Almost Significant (ALS)	[0.10, 0.80, 0.70, -0.90, -0.20, -0.10]

Step 3. Build the super matrix.

The acquired vectors are normalized to explain the native priority vector. The super matrix is constructed, and the native priority vectors are entered in the suitable columns of the matrix of impact between the components, to gain comprehensive weights. The super matrix is formed of three stages as follows:

$$w = \begin{matrix} & \begin{matrix} G & C & A \end{matrix} \\ \begin{matrix} Goal (G) \\ Criteria (C) \\ Alternative (A) \end{matrix} & \begin{bmatrix} 0 & 0 & 0 \\ w_{21} & w_{22} & 0 \\ 0 & w_{32} & I \end{bmatrix} \end{matrix} \tag{5}$$

Zero in the super matrix can be exchanged by a matrix if there is an interdependency of components in a group or among to groups. I is the symmetry matrix, w_{21} illustrates the influence of the goal on the criteria, w_{22} illustrates the influence of the interrelationships between criteria and w_{32} illustrates the influence of criteria on each of substitutions.

Step 4. Construct the weighted super matrix.

The obtained eigenvector from the pairwise comparison matrix of the row clusters with esteem to the column cluster, which in transformation yields an eigenvector for each column cluster.

In physical situations, DMs cannot present their decisions about confirmed characteristics, like being healthy, etc. So, we defined neutrosophic scales and measures. In our application, BNNs, as in Table 1, were applied by DMs to indicate their judgments to compare characteristics and attributes to determine the priorities of criteria. In the suggested approach, pairwise comparison judgments are created with the aid of BNNS, and the neutrosophic ANP is utilized to settle the problem of personnel selection. The neutrosophic ANP can simply accommodate interdependencies existent between the activities. The notion of super matrices is used to acquire the composite priorities that cope with the existent interdependencies [31,32]. We use BNNs [$T^+(x)$, $I^+(x)$, $F^+(x)$, $T^-(x)$, $I^-(x)$, $F^-(x)$] to construct pairwise comparison matrices, the neutrosophic matrix being constructed as follows:

$$\tilde{A} = \begin{bmatrix} \langle a_{11}^{T^+}, a_{11}^{I^+}, a_{11}^{F^+}, a_{11}^{T^-}, a_{11}^{I^-}, a_{11}^{F^-} \rangle & \dots & \dots & \langle a_{1n}^{T^+}, a_{1n}^{I^+}, a_{1n}^{F^+}, a_{1n}^{T^-}, a_{1n}^{I^-}, a_{1n}^{F^-} \rangle \\ \langle a_{21}^{T^+}, a_{21}^{I^+}, a_{21}^{F^+}, a_{21}^{T^-}, a_{21}^{I^-}, a_{21}^{F^-} \rangle & \dots & \dots & \langle a_{2n}^{T^+}, a_{2n}^{I^+}, a_{2n}^{F^+}, a_{2n}^{T^-}, a_{2n}^{I^-}, a_{2n}^{F^-} \rangle \\ \vdots & \vdots & \vdots & \vdots \\ \langle a_{n1}^{T^+}, a_{n1}^{I^+}, a_{n1}^{F^+}, a_{n1}^{T^-}, a_{n1}^{I^-}, a_{n1}^{F^-} \rangle & \dots & \dots & \langle a_{nn}^{T^+}, a_{nn}^{I^+}, a_{nn}^{F^+}, a_{nn}^{T^-}, a_{nn}^{I^-}, a_{nn}^{F^-} \rangle \end{bmatrix} \tag{6}$$

The pairwise comparison matrix \tilde{A} is supposed as reciprocal

$$\tilde{A} = \begin{bmatrix} \langle 0.5, 0.5, 0.5, -0.5, -0.5, -0.5 \rangle & \langle a_{1n}^{T^+}, a_{1n}^{I^+}, a_{1n}^{F^+}, a_{1n}^{T^-}, a_{1n}^{I^-}, a_{1n}^{F^-} \rangle \\ & \frac{1}{\Delta_{21}} & 0.5 & \langle a_{2n}^{T^+}, a_{2n}^{I^+}, a_{2n}^{F^+}, a_{2n}^{T^-}, a_{2n}^{I^-}, a_{2n}^{F^-} \rangle \\ & \vdots & & \vdots \\ & \frac{1}{\Delta_{n1}} & & \langle 0.5, 0.5, 0.5, -0.5, -0.5, -0.5 \rangle \end{bmatrix} \tag{7}$$

The ANP method can be applied to compute the priority of criteria and rank of the alternatives. In the suggested technique, neutrosophic ANP will be applied only to compute the weights of the criteria. Equation (8) will be applied to help neutrosophic TOPSIS for ranking the candidates.

$$w = \begin{bmatrix} 0 & 0 \\ w_{21} & w_{22} \end{bmatrix} \tag{8}$$

Step 5. Determine the linguistic valuations $\tilde{X} = \{\tilde{x}_{ij}, i = 1, 2, 3, \dots, n, j = 1, 2, 3, \dots, j\}$ for alternatives with regard to criteria and construct matrix as in Equation (9). Bipolar neutrosophic numbers, as in Table 2, have also been used by DMs to indicate their judgments on the alternatives according to each criterion. The linear measure conversion is utilized here to convert the different criteria measures into comparable measures to avert difficulty of mathematical procedures in a decision process.

The trouble can be presented by the next sets:

A collection of j potential applicant described $A = \{A_1, A_2, A_3, \dots, A_j\}$;

A collection of n criteria, $C = \{C_1, C_2, C_3, \dots, C_i\}$;

A collection of performance valuations of A_j ($j = 1, 2, 3, \dots, j$) with regard to criteria C_j ($i = 1, 2, 3, \dots, n$) described $\tilde{X} = \{\tilde{x}_{ij}, i = 1, 2, 3, \dots, n, j = 1, 2, 3, \dots, j\}$;

A collection of significant priorities of every criterion $w_i = (i = 1, 2, 3, \dots, n)$.

As mentioned, a professional selection issue can be briefly stated in matrix shape as follows:

$$\tilde{X} = \begin{bmatrix} \tilde{X}_{11} & \tilde{X}_{12} & \dots & \tilde{X}_{1n} \\ \tilde{X}_{21} & \tilde{X}_{22} & \dots & \tilde{X}_{2n} \\ \vdots & \vdots & \ddots & \vdots \\ \tilde{X}_{j1} & \tilde{X}_{j2} & \dots & \tilde{X}_{jn} \end{bmatrix} \tag{9}$$

Table 2. Linguistic expressions for valuation.

Linguistic Expressions	Bipolar Neutrosophic Numbers Scale for Proportional Significance of Comparison Matrix
	$[T^+(x), I^+(x), F^+(x), T^-(x), I^-(x), F^-(x)]$
Extremely Low (EL)	[0.15, 0.90, 0.80, 0.65, -0.10, -0.10]
Very Low (VL)	[0.25, 0.70, 0.80, -0.55, -0.15, -0.30]
Low (L)	[0.30, 0.40, 0.60, -0.30, -0.20, -0.10]
Medium (M)	[0.50, 0.50, 0.50, -0.50, -0.50, -0.50]
Perfect (P)	[0.75, 0.20, 0.25, -0.25, -0.60, -0.50]
Very Perfect (VP)	[0.85, 0.15, 0.20, -0.20, -0.70, -0.90]
Extremely Perfect (EP)	[1.00, 0.00, 0.10, -0.10, -0.90, -1.00]

Step 6. Construct the normalized matrix.

$$r_{ij} = \frac{x_{ij}}{\sqrt{\sum_{i=1}^m x_{ij}^2}} \tag{10}$$

where i refers to the alternatives, j refers to the choosing criteria and x_{ij} refers to the i alternative under the j criterion to be evaluated.

Step 7. Build the weighted united assessment matrix.

Priorities of choosing criteria $w = (w_1, w_2, w_3, \dots, w_n)$ multiplied by the normalized matrix, may be presented as

$$V = \begin{bmatrix} V_{11} & V_{12} & \dots & V_{1n} \\ V_{21} & V_{22} & \dots & V_{2n} \\ \vdots & \vdots & \ddots & \vdots \\ V_{j1} & V_{j2} & \dots & V_{jn} \end{bmatrix} = \begin{bmatrix} w_1 V_{11} & w_2 V_{12} & \dots & w_n V_{1n} \\ w_1 V_{21} & w_2 V_{22} & \dots & w_n V_{2n} \\ \vdots & \vdots & \ddots & \vdots \\ w_1 V_{j1} & w_2 V_{j2} & \dots & w_n V_{jn} \end{bmatrix} \tag{11}$$

Step 8. Determine the positive and negative ideal solution.

We could define the neutrosophic positive ideal solution (NPIS, A^*) and the neutrosophic negative ideal solution (NNIS, A^-)

$$I^+ = \{V_1^*, V_2^*, \dots, V_j^*, \dots, V_n^*\} = \left\{ \left(\max_j V_{ij} \mid j \in J \right) \mid i = 1, \dots, m \right\}, \tag{12}$$

$$I^- = \{V_1^-, V_2^-, \dots, V_j^-, \dots, V_n^-\} = \left\{ \left(\min_j V_{ij} \mid j \in J \right) \mid i = 1, \dots, m \right\}, \tag{13}$$

Step 9. Compute the Euclidean distance between the positive ideal solution (D^*_i) and negative ideal solution (D^-_i) for all alternatives.

$$D^*_i = \sqrt{\sum_{j=1}^n (V_{ij} - V_i^*)^2}, \quad i = 1, 2, \dots, m, \tag{14}$$

$$D^-_i = \sqrt{\sum_{j=1}^n (V_{ij} - V_i^-)^2}, \quad i = 1, 2, \dots, m, \tag{15}$$

Step 10. Compute the proportional closeness to the positive ideal solution for each alternative. A closeness coefficient is outlined to locate the classification order of all potential alternatives where D^*_i and D^-_i of each alternative A_j ($j = 1, 2, 3, \dots, j$) has been computed.

$$CC_i = \frac{D^-_i}{D^*_i + D^-_i}; \quad i = 1, 2, \dots, m \tag{16}$$

Rank the alternatives according to CC_i ; major index values refer to the best selection of the alternatives.

4. Case Study

We presented a practical application to apply the suggested approach in real world problems. The case study was based on the Elsewedy Electric Group. The employment department needs to hire a new CEO every five years, according to Elsewedy Electric Group’s policy. The judgment commission consists of three DMs. They recommend four candidates from all the applicants. The general criteria for selections are mentioned in Table 3. The criteria were divided according to three factors, which were the physical factor, functional factor and personal factor.

The suggested technique for the professional selection difficult is comprised of neutrosophic ANP and neutrosophic TOPSIS techniques, composed of three major points: (1) determine the criteria to be utilized in the suggested approach, (2) neutrosophic ANP calculations and (3) valuation of appropriate applicant with neutrosophic TOPSIS, which we will divide into several steps:

Step 1. For the valuation process, the DMs decided to select 10 criteria for the selection of the CEO from four current alternatives (efficient managers).

Step 2. Determine the subordination among the criteria according to the group decision, as in Table 4.

Step 3. Establish the structure of the problem.

In our research, criteria could impact the goal with dependency for each other. The alternatives are also influenced by the criteria to confirm a dependency among the components of the problem. Obviously, the ANP method is more capable of dealing with the problem than AHP. We presented a schematic diagram of the problem in Figure 5.

Table 3. Criteria for CEO selection.

Factors	Criteria	A Shortened Form of a Phrase
Physical	C ₁	Stamina and physical strength
	C ₂	Good health
Functional	C ₃	Leadership and analytical thinking ability

	C ₄	Communication skills
	C ₅	Being good at marketing
	C ₆	Sentimental stability
	C ₇	Self confidence
Personal	C ₈	Ability to work independently
	C ₉	Patience
	C ₁₀	Quietness

Table 4. Mutuality through criteria.

Subordinate Criteria	Relying On	Subordinate Criteria	Relying On
C ₁	C ₂ , C ₇ , C ₉	C ₆	C ₇ , C ₈ , C ₉ , C ₁₀
C ₂	C ₁ , C ₆ , C ₁₀	C ₇	C ₁ , C ₃ , C ₅
C ₃	C ₂ , C ₆ , C ₇ , C ₈	C ₈	C ₁ , C ₃ , C ₅ , C ₆
C ₄	C ₃ , C ₆ , C ₁₀	C ₉	C ₆ , C ₈ , C ₁₀
C ₅	C ₁ , C ₃ , C ₇	C ₁₀	C ₄ , C ₆ , C ₉

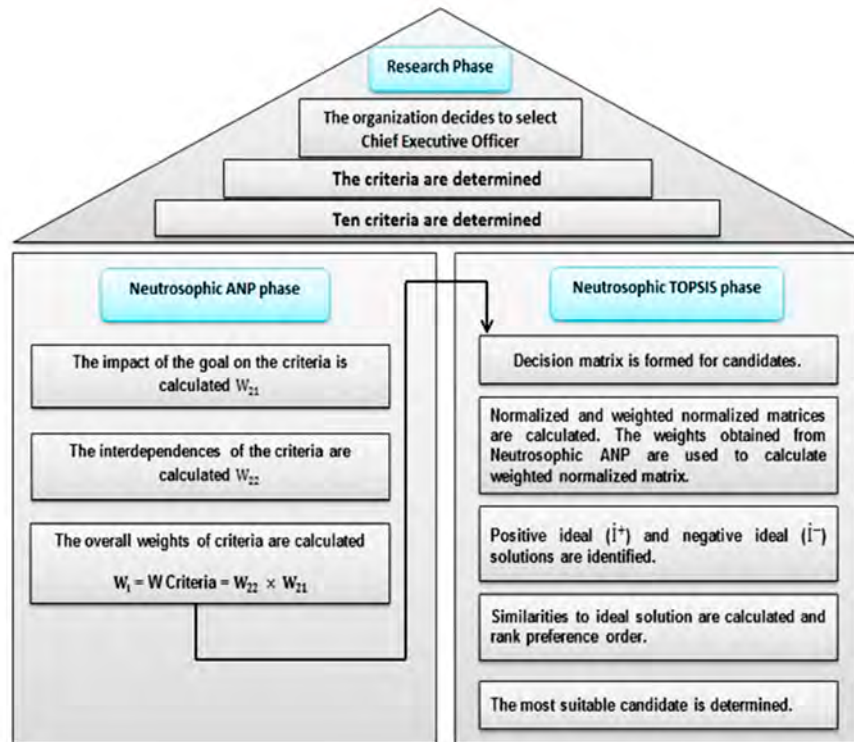

Figure 4. Suggested method.

Step 4. Construct the comparison matrices among criteria and calculate weights of the criteria

Using the scales mentioned previously in Table 1, we constructed the pairwise comparison matrix between criteria.

- We used Equation (1) to calculate the score value of linguistic terms.
- Computed the CR of the comparison matrices with less or equal 0.1.
- Computed W_{21} as presented in Table 5.
- Calculated the interdependences for criteria C_i ($i = 1, 2, 3, \dots, 10$) as exhibited in Tables 6–15.
- Constructed the pair-wise comparison for values of W_{22} as presented in Table 16.
- Constructed the weight matrix using Equation (8).
- We calculated the final weight of criteria by $W_{criteria} = W_{21} \times W_{22}$, as shown in Table 16 and exhibited in Figure 6.

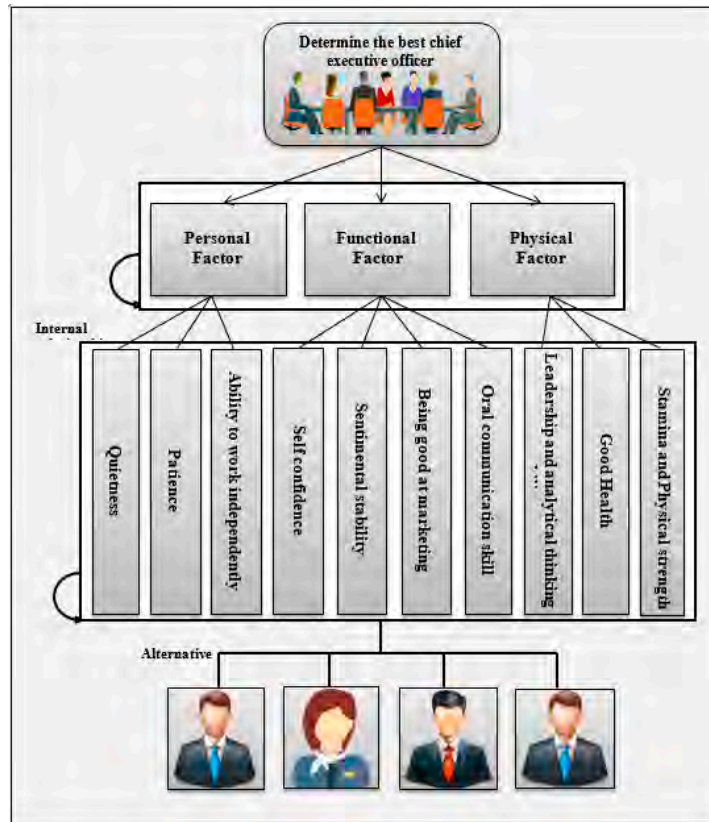

Figure 5. The analytic network process model for selecting CEO.

Table 5. Pairwise discrimination for W_{21} .

	C_{i_1}	C_{i_2}	C_{i_3}	C_{i_4}
C_{i_1}	[0.50, 0.50, 0.50, -0.50, -0.50, -0.5]	$1/\Delta$	[0.10, 0.80, 0.70, -0.90, -0.20, -0.1]	$1/\Delta$
C_{i_2}	[0.40, 0.20, 0.70, -0.50, -0.20, -0.1]	[0.50, 0.50, 0.50, -0.50, -0.50, -0.5]	$1/\Delta$	$1/\Delta$
C_{i_3}	$1/\Delta$	[0.80, 0.50, 0.50, -0.30, -0.80, -0.8]	[0.50, 0.50, 0.50, -0.50, -0.50, -0.5]	[0.90, 0.10, 0.10, -0.40, -0.80, -0.9]
C_{i_4}	[0.90, 0.10, 0.10, -0.40, -0.80, -0.9]	[0.10, 0.80, 0.70, -0.90, -0.20, -0.1]	$1/\Delta$	[0.50, 0.50, 0.50, -0.50, -0.50, -0.5]
C_{i_5}	$1/\Delta$	[0.80, 0.50, 0.50, -0.30, -0.80, -0.8]	[0.90, 0.10, 0.10, -0.40, -0.80, -0.9]	$1/\Delta$
C_{i_6}	$1/\Delta$	$1/\Delta$	$1/\Delta$	$1/\Delta$
C_{i_7}	[0.10, 0.80, 0.70, -0.90, -0.20, -0.1]	[0.90, 0.10, 0.10, -0.40, -0.80, -0.9]	$1/\Delta$	$1/\Delta$
C_{i_8}	$1/\Delta$	$1/\Delta$	$1/\Delta$	[0.10, 0.80, 0.70, -0.90, -0.20, -0.1]
C_{i_9}	[0.50, 0.50, 0.50, -0.50, -0.50, -0.5]	$1/\Delta$	$1/\Delta$	[0.10, 0.80, 0.70, -0.90, -0.20, -0.1]
$C_{i_{10}}$	$1/\Delta$	[0.80, 0.50, 0.50, -0.30, -0.80, -0.8]	$1/\Delta$	$1/\Delta$

	C_{i_5}	C_{i_6}	C_{i_7}
C_{i_1}	[0.90, 0.10, 0.10, -0.40, -0.80, -0.90]	[0.90, 0.10, 0.10, -0.40, -0.80, -0.90]	$1/\Delta$
C_{i_2}	$1/\Delta$	[0.10, 0.80, 0.70, -0.90, -0.20, -0.10]	$1/\Delta$
C_{i_3}	$1/\Delta$	[0.90, 0.10, 0.10, -0.40, -0.80, -0.90]	[0.50, 0.50, 0.50, -0.50, -0.50, -0.50]
C_{i_4}	[0.10, 0.80, 0.70, -0.90, -0.20, -0.10]	[0.10, 0.80, 0.70, -0.90, -0.20, -0.10]	[0.90, 0.10, 0.10, -0.40, -0.80, -0.90]
C_{i_5}	[0.50, 0.50, 0.50, -0.50, -0.50, -0.50]	[0.80, 0.50, 0.50, -0.30, -0.80, -0.80]	[0.90, 0.10, 0.10, -0.40, -0.80, -0.90]
C_{i_6}	$1/\Delta$	[0.50, 0.50, 0.50, -0.50, -0.50, -0.50]	$1/\Delta$
C_{i_7}	$1/\Delta$	[0.90, 0.10, 0.10, -0.40, -0.80, -0.90]	[0.50, 0.50, 0.50, -0.50, -0.50, -0.50]
C_{i_8}	[0.40, 0.20, 0.70, -0.50, -0.20, -0.10]	$1/\Delta$	$1/\Delta$
C_{i_9}	[0.90, 0.10, 0.10, -0.40, -0.80, -0.90]	$1/\Delta$	[0.50, 0.50, 0.50, -0.50, -0.50, -0.50]

$C_{i_{10}}$	[0.90, 0.10, 0.10, -0.40, -0.80, -0.90]	$1/\Delta$	$1/\Delta$
--------------	---	------------	------------

	C_{i_8}	C_{i_9}	$C_{i_{10}}$	N weight W_{21}
C_{i_1}	[0.80, 0.50, 0.50, -0.30, -0.80, -0.80]	$1/\Delta$	[0.50, 0.50, 0.50, -0.50, -0.50, -0.50]	0.098
C_{i_2}	[0.10, 0.80, 0.70, -0.90, -0.20, -0.10]	[0.80, 0.50, 0.50, -0.30, -0.80, -0.80]	$1/\Delta$	0.091
C_{i_3}	[0.90, 0.10, 0.10, -0.40, -0.80, -0.90]	[0.50, 0.50, 0.50, -0.50, -0.50, -0.50]	[0.10, 0.80, 0.70, -0.90, -0.20, -0.10]	0.084
C_{i_4}	$1/\Delta$	$1/\Delta$	[0.10, 0.80, 0.70, -0.90, -0.20, -0.10]	0.094
C_{i_5}	$1/\Delta$	$1/\Delta$	$1/\Delta$	0.104
C_{i_6}	[0.50, 0.50, 0.50, -0.50, -0.50, -0.50]	[0.90, 0.10, 0.10, -0.40, -0.80, -0.90]	[0.80, 0.50, 0.50, -0.30, -0.80, -0.80]	0.114
C_{i_7}	[0.90, 0.10, 0.10, -0.40, -0.80, -0.90]	$1/\Delta$	[0.10, 0.80, 0.70, -0.90, -0.20, -0.10]	0.071
C_{i_8}	[0.50, 0.50, 0.50, -0.50, -0.50, -0.50]	[0.90, 0.10, 0.10, -0.40, -0.80, -0.90]	$1/\Delta$	0.108
C_{i_9}	$1/\Delta$	[0.50, 0.50, 0.50, -0.50, -0.50, -0.50]	[0.10, 0.80, 0.70, -0.90, -0.20, -0.10]	0.071
$C_{i_{10}}$	[0.90, 0.10, 0.10, -0.40, -0.80, -0.90]	$1/\Delta$	[0.50, 0.50, 0.50, -0.50, -0.50, -0.50]	0.165

Table 6. Interior interdependencies matrix of factor C_1 .

	C_{i_2}	C_{i_7}	C_{i_9}	W_{22}
C_{i_2}	[0.50, 0.50, 0.50, -0.50, -0.50, -0.50]	[0.10, 0.80, 0.70, -0.90, -0.20, -0.10]	$1/\Delta$	0.23
C_{i_7}	$1/\Delta$	[0.50, 0.50, 0.50, -0.50, -0.50, -0.50]	[0.80, 0.50, 0.50, -0.30, -0.80, -0.80]	0.43
C_{i_9}	[0.90, 0.10, 0.10, -0.40, -0.80, -0.90]	$1/\Delta$	[0.50, 0.50, 0.50, -0.50, -0.50, -0.50]	0.34

The prior matrix $a(CR) = 0.099$.

Table 7. Interior interdependencies matrix of factor C_2 .

	C_{i_1}	C_{i_6}	$C_{i_{10}}$	W_{22}
C_{i_1}	[0.50, 0.50, 0.50, -0.50, -0.50, -0.50]	[0.90, 0.10, 0.10, -0.40, -0.80, -0.90]	$1/\Delta$	0.44
C_{i_6}	$1/\Delta$	[0.50, 0.50, 0.50, -0.50, -0.50, -0.50]	[0.50, 0.50, 0.50, -0.50, -0.50, -0.50]	0.29
$C_{i_{10}}$	[0.10, 0.80, 0.70, -0.90, -0.20, -0.10]	$1/\Delta$	[0.50, 0.50, 0.50, -0.50, -0.50, -0.50]	0.27

The prior matrix $a(CR) = 0.020$.

Table 8. Interior interdependencies matrix of factor C_3 .

	C_{i_2}	C_{i_6}	C_{i_7}	C_{i_8}	W_{22}
C_{i_2}	[0.50, 0.50, 0.50, -0.50, -0.50, -0.50]	[0.50, 0.50, 0.50, -0.50, -0.50, -0.50]	[0.80, 0.50, 0.50, -0.30, -0.80, -0.80]	$1/\Delta$	0.16
C_{i_6}	$1/\Delta$	[0.50, 0.50, 0.50, -0.50, -0.50, -0.50]	$1/\Delta$	[0.40, 0.20, 0.70, -0.50, -0.20, -0.10]	0.31
C_{i_7}	$1/\Delta$	[0.40, 0.20, 0.70, -0.50, -0.20, -0.10]	[0.50, 0.50, 0.50, -0.50, -0.50, -0.50]	$1/\Delta$	0.26
C_{i_8}	[0.90, 0.10, 0.10, -0.40, -0.80, -0.90]	$1/\Delta$	[0.40, 0.20, 0.70, -0.50, -0.20, -0.10]	[0.50, 0.50, 0.50, -0.50, -0.50, -0.50]	0.27

The prior matrix $a(CR) = 0.1$.

Table 9. Interior interdependencies matrix of factor C_4 .

	C_{i_3}	C_{i_6}	$C_{i_{10}}$	W_{22}
C_{i_3}	[0.50, 0.50, 0.50, -0.50, -0.50, -0.50]	$1/\Delta$	[0.90, 0.10, 0.10, -0.40, -0.80, -0.90]	0.45
C_{i_6}	[0.10, 0.80, 0.70, -0.90, -0.20, -0.10]	[0.50, 0.50, 0.50, -0.50, -0.50, -0.50]	$1/\Delta$	0.24
$C_{i_{10}}$	$1/\Delta$	[0.80, 0.50, 0.50, -0.30, -0.80, -0.80]	[0.50, 0.50, 0.50, -0.50, -0.50, -0.50]	0.31

The prior matrix $a(CR) = 0.1$.

Table 10. Interior interdependencies matrix of factor C_5 .

	C_{i_1}	C_{i_3}	C_{i_7}	W_{22}
C_{i_1}	[0.50, 0.50, 0.50, -0.50, -0.50, -0.50]	$1/\Delta$	[0.80, 0.50, 0.50, -0.30, -0.80, -0.80]	0.38
C_{i_3}	[0.40, 0.20, 0.70, -0.50, -0.20, -0.10]	[0.50, 0.50, 0.50, -0.50, -0.50, -0.50]	$1/\Delta$	0.29
C_{i_7}	$1/\Delta$	[0.80, 0.50, 0.50, -0.30, -0.80, -0.80]	[0.50, 0.50, 0.50, -0.50, -0.50, -0.50]	0.33

The prior matrix $a(CR) = 0.005$.

Table 11. Interior interdependencies matrix of factor C_6 .

	C_{i_7}	C_{i_8}	C_{i_9}	$C_{i_{10}}$	W_{22}
C_{i_7}	[0.50, 0.50, 0.50, -0.50, -0.50, -0.50]	[0.50, 0.50, 0.50, -0.50, -0.50, -0.50]	[0.80, 0.50, 0.50, -0.30, -0.80, -0.80]	$1/\Delta$	0.18
C_{i_9}	$1/\Delta$	[0.50, 0.50, 0.50, -0.50, -0.50, -0.50]	$1/\Delta$	[0.40, 0.20, 0.70, -0.50, -0.20, -0.10]	0.32
C_{i_9}	$1/\Delta$	[0.40, 0.20, 0.70, -0.50, -0.20, -0.10]	[0.50, 0.50, 0.50, -0.50, -0.50, -0.50]	$1/\Delta$	0.24
$C_{i_{10}}$	[0.80, 0.50, 0.50, -0.30, -0.80, -0.80]	$1/\Delta$	[0.50, 0.50, 0.50, -0.50, -0.50, -0.50]	[0.50, 0.50, 0.50, -0.50, -0.50, -0.50]	0.26

The prior matrix $a(CR) = 0.1$.

Table 12. Interior interdependencies matrix of factor C_7 .

	C_{i_1}	C_{i_3}	C_{i_5}	W_{22}
C_{i_1}	[0.50, 0.50, 0.50, -0.50, -0.50, -0.50]	[0.10, 0.80, 0.70, -0.90, -0.20, -0.10]	$1/\Delta$	0.23
C_{i_3}	$1/\Delta$	[0.50, 0.50, 0.50, -0.50, -0.50, -0.50]	[0.80, 0.50, 0.50, -0.30, -0.80, -0.80]	0.43
C_{i_5}	[0.90, 0.10, 0.10, -0.40, -0.80, -0.90]	$1/\Delta$	[0.50, 0.50, 0.50, -0.50, -0.50, -0.50]	0.34

The prior matrix $a(CR) = 0.080$.

Table 13. Interior interdependencies matrix of factor C_8 .

	C_{i_1}	C_{i_3}	C_{i_5}	C_{i_6}	W_{22}
C_{i_1}	[0.50, 0.50, 0.50, -0.50, -0.50, -0.50]	[0.50, 0.50, 0.50, -0.50, -0.50, -0.50]	[0.80, 0.50, 0.50, -0.30, -0.80, -0.80]	$1/\Delta$	0.18
C_{i_3}	$1/\Delta$	[0.50, 0.50, 0.50, -0.50, -0.50, -0.50]	$1/\Delta$	[0.40, 0.20, 0.70, -0.50, -0.20, -0.10]	0.32
C_{i_5}	$1/\Delta$	[0.40, 0.20, 0.70, -0.50, -0.20, -0.10]	[0.50, 0.50, 0.50, -0.50, -0.50, -0.50]	$1/\Delta$	0.24
C_{i_6}	[0.80, 0.50, 0.50, -0.30, -0.80, -0.80]	$1/\Delta$	[0.50, 0.50, 0.50, -0.50, -0.50, -0.50]	[0.50, 0.50, 0.50, -0.50, -0.50, -0.50]	0.26

The prior matrix $a(CR) = 0.020$.

Table 14. Interior interdependencies matrix of factor C_9 .

	C_{i_6}	C_{i_8}	$C_{i_{10}}$	W_{22}
C_{i_6}	[0.50, 0.50, 0.50, -0.50, -0.50, -0.50]	$1/\Delta$	[0.90, 0.10, 0.10, -0.40, -0.80, -0.90]	0.45
C_{i_8}	[0.10, 0.80, 0.70, -0.90, -0.20, -0.10]	[0.50, 0.50, 0.50, -0.50, -0.50, -0.50]	$1/\Delta$	0.24
$C_{i_{10}}$	$1/\Delta$	[0.80, 0.50, 0.50, -0.30, -0.80, -0.80]	[0.50, 0.50, 0.50, -0.50, -0.50, -0.50]	0.31

The prior matrix $a(CR) = 0.080$.

Table 15. Interior interdependencies matrix of factor C_{10} .

	C_{i_6}	C_{i_9}	Neutrosophic weight W_{22}
C_{i_6}	[0.50, 0.50, 0.50, -0.50, -0.50, -0.50]	$1/\Delta$	0.59
C_{i_9}	[0.80, 0.50, 0.50, -0.30, -0.80, -0.80]	[0.50, 0.50, 0.50, -0.50, -0.50, -0.50]	0.41

The prior matrix $a(CR) = 0.005$.

Step 5. Essentially, all the previous steps were within the neutrosophic ANP phase for calculating the weights of criteria. In the second stage of the study, the neutrosophic TOPSIS stage began by initiating neutrosophic valuations of alternatives candidates A_1, A_2, A_3, A_4 with regard to the criteria by applying bipolar neutrosophic numbers.

- Table 17 indicates the performance classification of the candidates with respect to the criteria using Equation (9).
- Applying the linguistic expressions in Table 2 to establish the decision matrix.
- Deneutrosophication values of judgments matrix using Equation (1) as in Table 18.
- After establishing the decision matrix, by using Equation (10) a normalized decision matrix was computed, as represented in Table 19.
- Multiply the weights $W_{criteria}$ of criteria from Table 16 by the normalized matrix in order to produce the weighted matrix in Table 20, by using Equation (11).
- Furthermore, the positive (I^+) and negative (I^-) ideal solutions were specified. The neutrosophic positive and negative ideal solution (NPIS, I^+) and (NNIS, I^-) were computed using Equations (12) and (13) as presented in Table 21.
- Compute the Euclidean distance between positive (D^*_i) and negative (D^-_i) ideal solution by applying Equations (14) and (15), as presented in Table 21.
- Compute the closeness coefficient and rank the candidates ascending according to the maximum index of CC_i , by using Equation (16) as in Table 21 and in Figure 7.

Step 6. Lastly, after completing the steps of the solution, we found that the candidate A_4 is the most appropriate candidate to occupy the role of CEO of the company in accordance with all the criteria that were approved by DMs.

The candidate A_4 was considered to be the best because his features met the judgments of DMs and criteria to achieve goals in a company. We believed that we had successfully passed this step in selecting the best candidate for the job. Given, we had taken most of the important criteria in consideration, which we mentioned earlier to choose any candidate for this problem. The numerical example exhibited possibilities for improvement of human resources management by applying ANP-TOPSIS. However, further studies might be useful for extending the method by introducing both application of different aggregation operators and application of neutrosophic numbers.

Table 16. Final weight for criteria using the ANP method.

	Pair-Wise Comparison for Values of W_{22}										Neutrosophic Weight W_{21}	W_i criteria
	Ci_1	Ci_2	Ci_3	Ci_4	Ci_5	Ci_6	Ci_7	Ci_8	Ci_9	Ci_{10}		
Ci_1	0.00	0.44	0.00	0.00	0.38	0.00	0.23	0.18	0.00	0.00	0.098	0.12
Ci_2	0.23	0.00	0.16	0.00	0.00	0.00	0.00	0.00	0.00	0.00	0.091	0.04
Ci_3	0.00	0.00	0.00	0.45	0.29	0.00	0.43	0.32	0.00	0.00	0.084	0.14
Ci_4	0.00	0.00	0.00	0.00	0.00	0.00	0.00	0.00	0.00	0.00	0.094	0.00
Ci_5	0.00	0.00	0.00	0.00	0.00	0.00	0.34	0.24	0.00	0.00	0.104	0.05
Ci_6	0.00	0.29	0.31	0.24	0.00	0.00	0.00	0.26	0.45	0.59	0.114	0.23
Ci_7	0.43	0.00	0.26	0.00	0.33	0.18	0.00	0.00	0.00	0.00	0.071	0.11
Ci_8	0.00	0.00	0.27	0.00	0.00	0.32	0.00	0.00	0.24	0.00	0.108	0.08
Ci_9	0.34	0.00	0.00	0.00	0.00	0.24	0.00	0.00	0.00	0.41	0.071	0.13
Ci_{10}	0.00	0.27	0.00	0.31	0.00	0.26	0.00	0.00	0.31	0.00	0.165	0.10

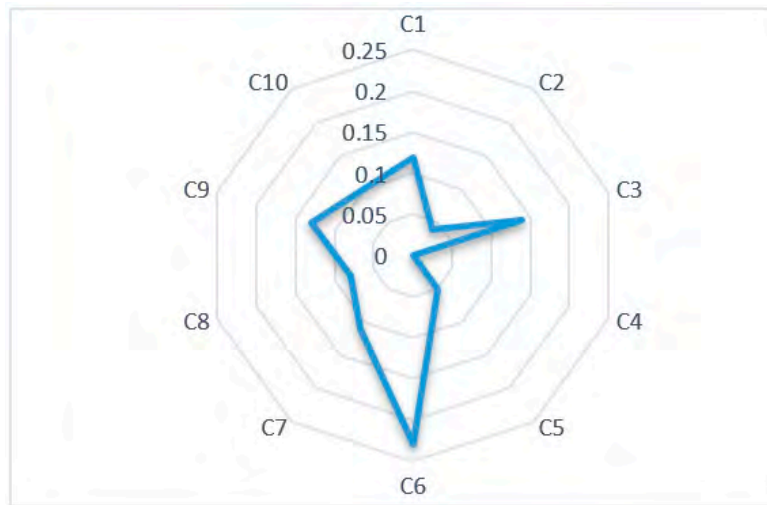

Figure 6. The weight of personnel selection criteria

Table 17. Judgments matrix for alternatives.

	C_{i_1}	C_{i_2}	C_{i_3}	C_{i_4}	C_{i_5}	C_{i_6}	C_{i_7}	C_{i_8}	C_{i_9}	$C_{i_{10}}$
A_1	EP)	VP)	EL)	EL)	P)	M)	EP)	L)	EP)	P)
A_2	VL)	P)	M)	L)	EP)	VL)	L)	M)	VL)	EL)
A_3	P)	L)	VP)	P)	M)	EL)	VP)	P)	VP)	M)
A_4	VP)	M)	VP)	VL)	M)	VP)	EP)	VP)	VL)	VL)

Table 18. Deneutrosophication values of the judgments matrix.

	C_{i_1}	C_{i_2}	C_{i_3}	C_{i_4}	C_{i_5}	C_{i_6}	C_{i_7}	C_{i_8}	C_{i_9}	$C_{i_{10}}$
A_1	0.95	0.82	0.17	0.17	0.69	0.50	0.95	0.38	0.95	0.69
A_2	0.28	0.69	0.50	0.38	0.95	0.28	0.38	0.50	0.28	0.17
A_3	0.69	0.38	0.82	0.69	0.50	0.17	0.82	0.69	0.82	0.50
A_4	0.82	0.50	0.82	0.28	0.50	0.82	0.95	0.82	0.28	0.28

Table 19. The normalized values of the judgments matrix.

	C_{i_1}	C_{i_2}	C_{i_3}	C_{i_4}	C_{i_5}	C_{i_6}	C_{i_7}	C_{i_8}	C_{i_9}	$C_{i_{10}}$
A_1	0.65	0.66	0.13	0.20	0.50	0.49	0.59	0.31	0.72	0.76
A_2	0.19	0.56	0.39	0.46	0.69	0.28	0.23	0.40	0.21	0.19
A_3	0.47	0.31	0.64	0.81	0.36	0.18	0.51	0.56	0.62	0.55
A_4	0.56	0.40	0.64	0.33	0.36	0.81	0.59	0.66	0.21	0.31

Table 20. The weighted values of the judgments matrix.

	C_{i_1}	C_{i_2}	C_{i_3}	C_{i_4}	C_{i_5}	C_{i_6}	C_{i_7}	C_{i_8}	C_{i_9}	$C_{i_{10}}$
A_1	0.08	0.03	0.02	0.00	0.03	0.11	0.06	0.02	0.09	0.08
A_2	0.02	0.02	0.05	0.00	0.03	0.06	0.03	0.03	0.03	0.02
A_3	0.06	0.01	0.09	0.00	0.02	0.04	0.06	0.04	0.08	0.06
A_4	0.07	0.02	0.09	0.00	0.02	0.19	0.06	0.05	0.03	0.03

Table 21. The final result of the judgments matrix.

	Ci_1	Ci_2	Ci_3	Ci_4	Ci_5	Ci_6	Ci_7	Ci_8	Ci_9	Ci_{10}	S_i^+	S_i^-	P_i	Normalized	Rank
A_1	0.08	0.03	0.02	0.00	0.03	0.11	0.06	0.02	0.09	0.08	0.11	0.13	0.54	0.29	4
A_2	0.02	0.02	0.05	0.00	0.03	0.06	0.03	0.03	0.03	0.02	0.08	0.04	0.18	0.10	1
A_3	0.06	0.01	0.09	0.00	0.02	0.04	0.06	0.04	0.08	0.06	0.15	0.11	0.42	0.23	3
A_4	0.07	0.02	0.09	0.00	0.02	0.19	0.06	0.05	0.03	0.03	0.08	0.11	0.69	0.38	2
I^+	0.08	0.03	0.09	0.00	0.03	0.11	0.06	0.02	0.09	0.08	Final Result				
I^-	0.02	0.02	0.05	0.00	0.03	0.06	0.03	0.03	0.03	0.02					

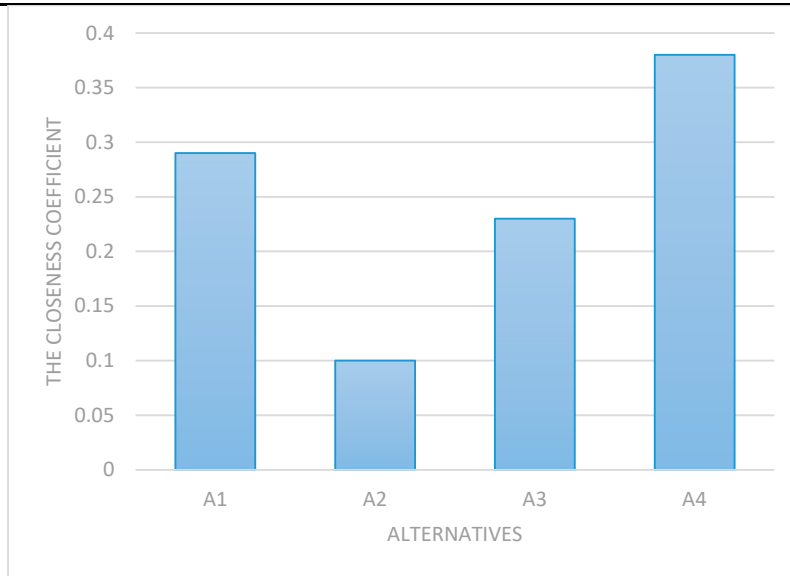

Figure 7. Final ranking using the suggested method.

5. Analysis Using Other Methods

In this section, we reviewed some MCDM methods, which would combine with the neutrosophic set to solve the same problem in order to prove the effectiveness and efficiency of the proposed method. On the other hand, we clarified the importance of the problem that we had mentioned, and that it had an important role in the success of any organization or system in the real world.

5.1. Analysis Using WSM and WPM Methods

In this subsection, we compared the results and ranking of candidates obtained from the proposed method with the obtained results from the weight sum model (WSM) and the weight product model (WPM) as follows:

- Here, we utilized the obtained weights $W_{criteria}$ of the criteria using ANP method as mentioned in Table 16.
- The normalized judgments matrix of candidates relevant to all criteria is exhibited in Table 22 as follows.
- In the last, the final result of ranking candidates exhibited in Table 23 and in Figure 8. More details on the two MCDM methods in [33].

Table 22. The normalized judgments matrix using the weight sum model (WSM) and weight product model (WPM) methods.

	Ci_1	Ci_2	Ci_3	Ci_4	Ci_5	Ci_6	Ci_7	Ci_8	Ci_9	Ci_{10}
A_1	1	1	0.21	0.25	0.73	0.61	1	0.46	1	1
A_2	0.29	0.84	0.61	0.55	1	0.34	0.40	0.61	0.29	0.25
A_3	0.73	0.46	1	1	0.53	0.21	0.86	0.84	0.86	0.72
A_4	0.86	0.61	1	0.41	0.53	1	1	1	0.29	0.41

Table 23. The final result of the judgments matrix using the WSM and WPM methods.

	$\sum_{i=1}^n w_j x_{ij}$	Normalized values	Ranking WSM	$\prod_{i=1}^n x_{ij}^{w_j}$	Normalized values	Ranking WPM
A_1	0.7430	0.28	4	9.620	0.25	4
A_2	0.4375	0.17	1	9.156	0.24	1
A_3	0.6664	0.25	3	9.517	0.25	3
A_4	0.7928	0.30	2	9.697	0.26	2

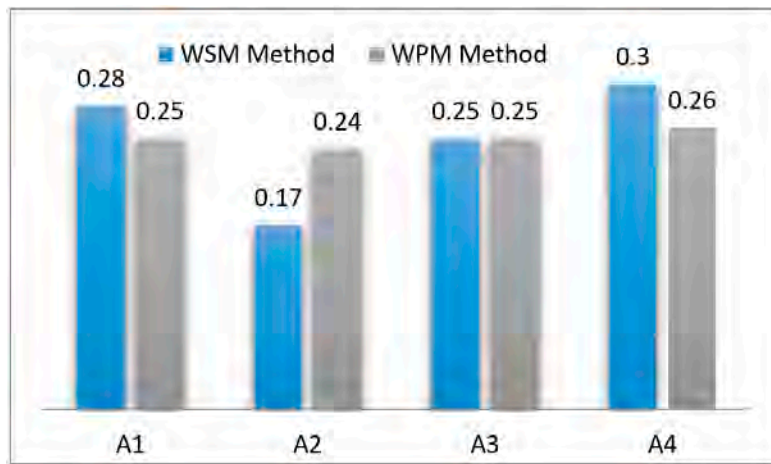

Figure 8. Final ranking using the WSM and WPM methods.

5.2. Analysis Using the AHP Method

In this subsection, we compared the results and ranking of candidates obtained from the proposed method with the results from the analytical hierarchy process (AHP) as follows:

- Here, we utilized the obtained weights of the criteria without considering the interdependencies and feedback between elements' of the problem as follows: $W = [0.098, 0.091, 0.084, 0.094, 0.104, 0.114, 0.071, 0.108, 0.071, 0.165]^T$.
- The judgment matrix of candidates related to all criteria for professional selection of chief executive officer as follows in Table 24.
- In the last, the final result of ranking candidates exhibited in Table 25 and in Figure 9.

Table 24. Judgments matrix for alternatives relevant to criteria using the analytical hierarchy process (AHP).

	Ci_1	Ci_2	Ci_3	Ci_4	Ci_5	Ci_6	Ci_7	Ci_8	Ci_9	Ci_{10}
A_1	0.95	0.82	0.17	0.17	0.69	0.50	0.95	0.38	0.95	0.69
A_2	0.28	0.69	0.50	0.38	0.95	0.28	0.38	0.50	0.28	0.17
A_3	0.69	0.38	0.82	0.69	0.50	0.17	0.82	0.69	0.82	0.50
A_4	0.82	0.50	0.82	0.28	0.50	0.82	0.95	0.82	0.28	0.28

Table 25. The final result of the judgments matrix using the AHP method.

Alternatives.	values	Normalized values	Ranking
A ₁	0.6165	0.28	1
A ₂	0.4276	0.19	4
A ₃	0.5808	0.26	3
A ₄	0.5886	0.27	2



Figure 9. Final ranking using the AHP method.

5.3. Analysis Using the MOORA Method

In this subsection, we compared the results and ranking of candidates obtained from the proposed method with the obtained results from the multi-objective optimization based on simple ratio analysis (MOORA) as follows:

- Here, we utilized the obtained weights $W_{criteria}$ of the criteria using ANP method as mentioned in Table 16.
- The normalized weighted judgment matrix of candidates related to each criterion for professional selection of chief executive officer as follows in Table 26.
- Lastly, the final result of ranking candidates is presented in Table 27 and in Figure 10. More details on the equations that we used in MOORA method are accessible with the specifics in [34].
- To facilitate the problem and give a background on the results obtained from all the methods used to solve the problem, we compared the results of all applied methods used in this paper, as shown in Figure 11.

Table 26. The normalized weighted values of judgments matrix using the multi-objective optimization based on simple ratio analysis (MOORA).

	Ci ₁	Ci ₂	Ci ₃	Ci ₄	Ci ₅	Ci ₆	Ci ₇	Ci ₈	Ci ₉	Ci ₁₀
A ₁	0.08	0.03	0.02	0.00	0.03	0.11	0.06	0.02	0.09	0.08
A ₂	0.02	0.02	0.05	0.00	0.03	0.06	0.03	0.03	0.03	0.02
A ₃	0.06	0.01	0.09	0.00	0.02	0.04	0.06	0.04	0.08	0.06
A ₄	0.07	0.02	0.09	0.00	0.02	0.19	0.06	0.05	0.03	0.03

Table 27. The normalized weighted values of judgments matrix using the MOORA.

Alternatives	values	Normalized values	Ranking
A ₁	0.61	0.27	3
A ₂	0.57	0.24	1
A ₃	0.63	0.29	2
A ₄	0.51	0.20	4

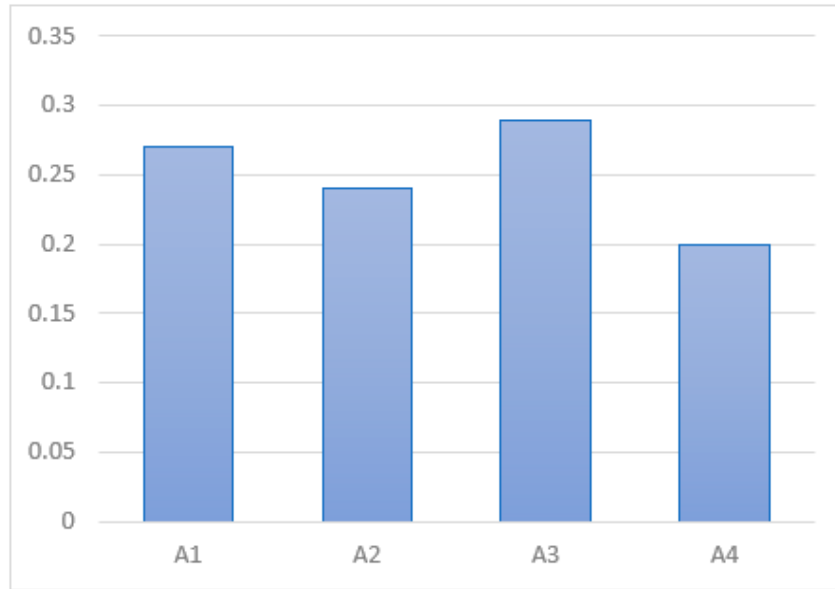

Figure 10. Final ranking using the MOORA method.

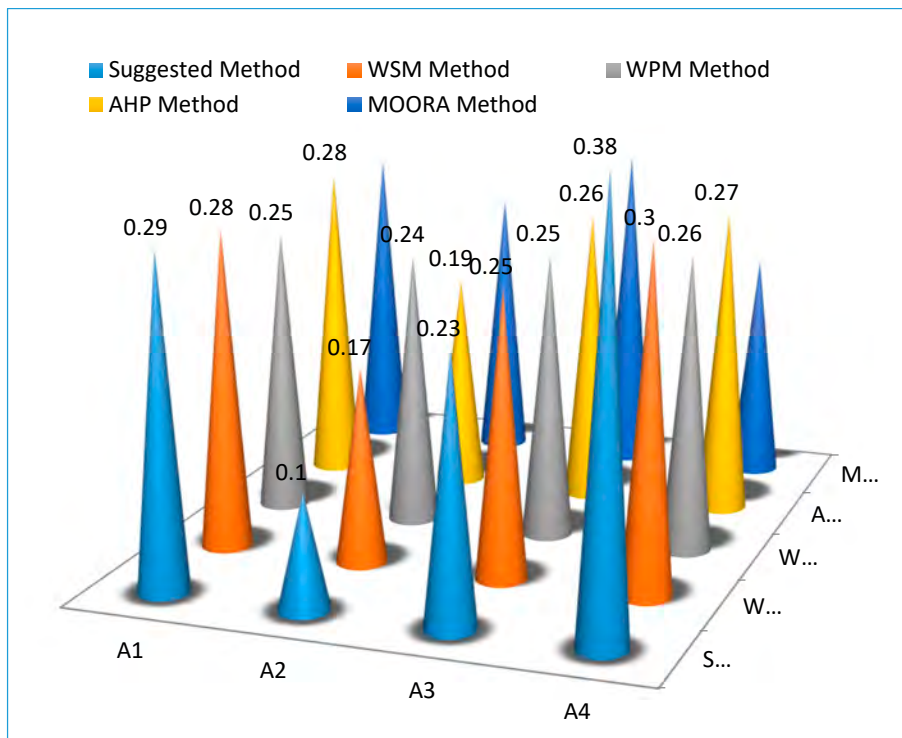

Figure 11. Final ranking using the various applied methods.

6. Sensitivity Analysis

We conducted a sensitivity analysis using various criteria weights. Five extra cases were tested so that the rank of the substitutes varied in each once. Figure 12 illustrates the obtained results. The first case in Figure 12 was the rank of the proposed method while the others were the results of the sensitivity analysis. The criteria weights were given as the following in the tested cases. The current weights of the proposed method as following:

- Case 1: $W^1 = (0.12, 0.04, 0.14, 0.00, 0.05, 0.23, 0.11, 0.08, 0.13, 0.10)$,
- Case 2: $W^2 = (0.16, 0.08, 0.02, 0.04, 0.12, 0.08, 0.10, 0.15, 0.10, 0.15)$,
- Case 3: $W^3 = (0.20, 0.15, 0.05, 0.05, 0.20, 0.10, 0.05, 0.05, 0.05, 0.10)$,
- Case 4: $W^4 = (0.20, 0.10, 0.05, 0.10, 0.11, 0.15, 0.03, 0.06, 0.10, 0.10)$,
- Case 5: $W^5 = (0.25, 0.06, 0.06, 0.05, 0.20, 0.05, 0.05, 0.08, 0.10, 0.10)$.

When we saw Figure 12 observe that the cases in the sensitivity analysis, which were compared with respect to case 1, the following outcomes were obtained:

In case 2, considerable decreases in the weight of the criterion being good at marketing and increases in the weight of the criterion stamina and physical strength caused alternative 1 and alternatives 3 to switch their ranks.

This also caused alternative 2 and alternative 4 to remain at the same ranking. In Case 3, alternative 3 took the first order while alternative 4 moved one level lower, alternative 2 moved one level higher and alternative moved two levels lower to become the last in ordering.

In Case 4, alternative 4 moved to a level lower while alternative 2 moved one level higher. In Case 5, a slight increase in the other criteria and an unexpected increase in the weight of the criterion being good at marketing and slight decreases in good health criterion and sentimental stability caused alternative 4 to become the best choice.

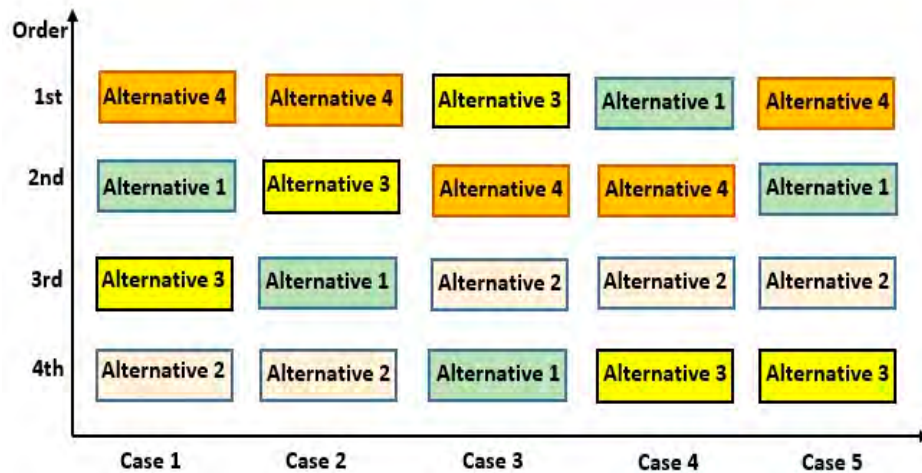

Figure 12. Results of the sensitivity analysis.

7. Conclusions

An organizational success depends on selecting the utmost suitable personnel, which is considered as the most significant factor for any organization. The personnel selection’s issue, affected by individual attributes of impreciseness and vagueness, could be considered as an extremely substantial decision-making problem. The traditional MCDM techniques to estimate inevitable or indiscriminate procedures should not efficaciously exhaust decision-making problems consisted of unspecific, indistinct imprecise and linguistic information. A sound MCDM procedure applied for personnel selection should be capable to combine quantitative as well as qualitative information. In this research, a neutrosophic MCDM technique was introduced to handle challenges when applying traditional decision-making procedures. The suggested method was appropriate to

handle estimated information using both numerical and linguistic measurement in a decision-making context.

A proposed model has practical implications as integrating two MCDM methods was adopted by CEO selection as an example of personnel selection. The neutrosophic set was used with all methods so as to make the valuation procedure more resilient and more accurate for the DMs. In other words, the use of the neutrosophic could determine characterizing vagueness in various factors. It could also facilitate the complicated structure of the judgment phase. The suggested neutrosophic hybrid MCDM technique included neutrosophic ANP and neutrosophic TOPSIS. The hybridization of the two MCDM methods, the comparison of results with the other MCDM methods and the proposed MCDM technique for CEO selection provided the most significant features of this research. Furthermore, the suggested technique could enable leaders or managers to deal with uncertain and unclear information. It could also create a suitable environment for the use of various semantic styles by DMs. The model provided the use of both qualitative and quantitative factors. As mentioned before the proposed hybrid structure of two MCDM techniques and proposing a MCDM approach for the professional real selection case were the unique features of the study.

The future work will include prediction of the influential factors by advanced decision-making algorithms that affect organizations by apply of variant multi criteria decision analysis techniques, so that our research contributions can be transferrable to other fields.

Author Contributions: Conceptualization, M.A.-B. and A.G.; Data curation, M.A.-B; Methodology, M.A.-B. and F.S.; Project administration, M.A.-B.; Resources, A.G.; Supervision, M.A.-B and F.S.; Validation, M.A.-B. and F.S.; Writing – original draft, M.A.-B. and A.G.; Writing – review & editing, M.A.-B., A.G., L.H.S. and F.S. All authors have read and agreed to the published version of the manuscript.

References

1. Lin, H.-T. Personnel selection using analytic network process and fuzzy data envelopment analysis approaches. *Comput. Ind. Eng.* **2010**, *59*, 937–944.
2. Liang, G.-S.; Wang, J.M.-J. Personnel selection using fuzzy MCDM algorithm. *Eur. J. Oper. Res.* **1994**, *78*, 22–33.
3. Baležentis, A.; Baležentis, T.; Brauers, K.W. Personnel selection based on computing with words and fuzzy MULTIMOORA. *Expert Syst. Appl.* **2012**, *39*, 7961–7967.
4. Dursun, M.; Karsak, E.E. A fuzzy MCDM approach for personnel selection. *Expert Syst. Appl.* **2010**, *37*, 4324–4330, doi:10.1016/j.eswa.2009.11.067.
5. Canós, L.; Liern, V. Soft computing-based aggregation methods for human resource management. *Eur. J. Oper. Res.* **2008**, *189*, 669–681, doi:10.1016/j.ejor.2006.01.054.
6. Robertson, I.T.; Smith, M. Personnel selection. *J. Occup. Organ. Psychol.* **2001**, *74*, 441–472.
7. Zainurita, M.A. *Supplier Selection for Solar Photovoltaic (PV) Module using Analytical Hierarchy Process: Perlis Solar Plant Project*; Universiti Utara Malaysia: Changlun, Malaysia, 2016.
8. Ansoff, H.I. *Implanting strategic management*; Springer: Berlin/Heidelberg, Germany, 2019.
9. Abdel-Baset, M.; Changb, V.; Gamala, A.; Smarandache, F. An integrated neutrosophic ANP and VIKOR method for achieving sustainable supplier selection: A case study in importing field. *Comput. Ind.* **2019**, *106*, 94–110.
10. Abdel-Basset, M.; Manogaran, G.; Gamala, A.; Smarandache, F. A hybrid approach of neutrosophic sets and DEMATEL method for developing supplier selection criteria. *Des. Autom. Embed. Syst.* **2018**, *22*, 257–278.
11. Abdel-Basset, M.; Saleh, M.; Gamal, A.; Smarandache, F. An approach of TOPSIS technique for developing supplier selection with group decision making under type-2 neutrosophic number. *Appl. Soft Comput.* **2019**, *77*, 438–452.

12. Abdel-Basset, M.; Manogaran, G.; Gamala, A.; Smarandache, F. A group decision making framework based on neutrosophic TOPSIS approach for smart medical device selection. *J. Med. Syst.* **2019**, *43*, 38.
13. Abdel-Basset, M.; Gunasekaran, M.; Mohamed, M.; Chilamkurti, N. A framework for risk assessment, management and evaluation: Economic tool for quantifying risks in supply chain. *Future Gener. Comput. Syst.* **2019**, *90*, 489–502.
14. Şenel, B.; Şenel, M.; Aydemir, G. Use and Comparison of Topis and Electre Methods In Personnel Selection. In *Proceedings of the ITM Web of Conferences*; EDP Sciences: Les Ulis, France, 2018.
15. Jasemi, M.; Ahmadi, E. A New Fuzzy ELECTRE Based Multiple Criteria Method for Personnel Selection. *Sci. Iran.* **2018**, *25*, 943–953.
16. Karabasevic, D.; Zavadskas, E.K.; Turskis, Z.; Stanujkic, D. The framework for the selection of personnel based on the SWARA and ARAS methods under uncertainties. *Informatica* **2016**, *27*, 49–65.
17. Ji, P.; Zhang, H.-Y.; Wang, J.-Q. A projection-based TODIM method under multi-valued neutrosophic environments and its application in personnel selection. *Neural Comput. Appl.* **2018**, *29*, 221–234.
18. Dung, V.; Thuy, L.T.; Mai, P.Q.; Van Dan, N.; Lan, N.T.M. *TOPSIS Approach Using Interval Neutrosophic Sets for Personnel Selection*; Infinite Study: Coimbatore, India, 2018.
19. Pramanik, S.; Dalapati, S.; Roy, T.K. Neutrosophic multi-attribute group decision making strategy for logistics center location selection. *Neutrosophic Oper. Res.* **2018**, *3*, 13–32.
20. Karabasevic, D.; Zavadskas, E.K.; Stanujkic, D.; Popovic, G.; Brzakovic, M. An approach to personnel selection in the IT industry based on the edas method. *Transform. Bus. Econ.* **2018**, *17*, 44.
21. Saaty, T.L. *Decision Making with Dependence and Feedback: The Analytic Network Process*; RWS Publ: 1996; Volume 4922.
22. Saaty, T.L. *The Analytic Hierarchy Process*; McGraw Hill: New York, NY, USA, 1980.
23. Meade, L.; Sarkis, J. Analyzing organizational project alternatives for agile manufacturing processes: An analytical network approach. *Int. J. Prod. Res.* **1999**, *37*, 241–261.
24. Hwang, C.-L.; Yoon, K. Methods for Multiple Attribute Decision Making. In *Multiple Attribute Decision Making*; Springer: Berlin/Heidelberg, Germany, 1981; pp. 58–191.
25. Ertuğrul, İ.; Karakaşoğlu, N. Performance evaluation of Turkish cement firms with fuzzy analytic hierarchy process and TOPSIS methods. *Expert Syst. Appl.* **2009**, *36*, 702–715.
26. Gallego Lupianez, F. Interval neutrosophic sets and topology. *Kybernetes* **2009**, *38*, 621–624.
27. Hezam, I.M.; Abdel-Baset, M.; Smarandache, F. *Taylor Series Approximation to Solve Neutrosophic Multi-Objective Programming Problem*; Infinite Study: Coimbatore, India, 2015.
28. Haibin, W.; Smarandache, F.; Zhang, Y.; Sunderraman, R. *Single Valued Neutrosophic Sets*; Infinite Study: Coimbatore, India, 2010.
29. Peng, J.-J.; Wang, J.-Q.; Wang, J.; Zhang, H.-Y.; Chen, X.-H. Simplified neutrosophic sets and their applications in multi-criteria group decision-making problems. *Int. J. Syst. Sci.* **2016**, *47*, 2342–2358.
30. Manemaran, S.; Chellappa, B. Structures on bipolar fuzzy groups and bipolar fuzzy D-ideals under (T, S) norms. *Int. J. Comput. Appl.* **2010**, *9*, 7–10.
31. Önüt, S.; Kara, S.S.; Işık, E. Long term supplier selection using a combined fuzzy MCDM approach: A case study for a telecommunication company. *Expert Syst. Appl.* **2009**, *36*, 3887–3895.
32. Mohanty, R.P.; Agarwal, R.; Choudhury, A.K.; Tiwari, M.K. A fuzzy ANP-based approach to R&D project selection: A case study. *Int. J. Prod. Res.* **2005**, *43*, 5199–5216.
33. Triantaphyllou, E. Multi-criteria decision making methods. In *Multi-Criteria Decision Making Methods: A Comparative Study*; Springer: Berlin/Heidelberg, Germany, 2000; pp. 5–21.
34. Brauers, W.K.; Zavadskas, E.K. The MOORA method and its application to privatization in a transition economy. *Control Cybern.* **2006**, *35*, 445–469.

Linear and Non-Linear Decagonal Neutrosophic numbers: Alpha Cuts, Representation, and solution of large MCDM problems

Sara Farooq, Ali Hamza, Florentin Smarandache

Sara Farooq, Ali Hamza, Florentin Smarandache (2021). Linear and Non-Linear Decagonal Neutrosophic numbers: Alpha Cuts, Representation, and solution of large MCDM problems. *International Journal of Neutrosophic Science* 14(1), 24-41; DOI: 10.5281/zenodo.4721629

Abstract

The postulation of neutrosophic numbers has been analyzed from different angles in this paper. In this current era, our main purpose is to mention Decagonal Neutrosophic numbers. The types of linear and non-linear generalized decagonal neutrosophic numbers play a very critical role in the theory related to uncertainty. This approach is helpful in getting a crisp number from a neutrosophic number. The definitions regarding Linear, Non-Linear, symmetry, Asymmetry, alpha cuts have been introduced and large decision-making problems using fuzzy TOPSIS have been solved.

Keywords: Accuracy Functions, Neutrosophic number, Decagonal Neutrosophic numbers (DNN), MCDM, TOPSIS.

1. Introduction

In the line of remarkable researches from fuzzy to neutrosophic, each concept has its unique importance and flexibility. The traditional mathematics based on crisp (e.g. Yes or No) has a well defined [1] property. Fuzzy Set was first established by Zadeh [2], and further extended by Zadeh [3]. In fuzzy set, each element has its corresponding membership function. Molodtsov established soft sets [4], which opened new possibilities for researches and soft sets have been used widely in engineering, medical, economics. Moreover, we introduced 'The best technique to lose weight' [5], by using soft sets.

The techniques to deal with vagueness and uncertainty were introduced by Smarandache [6] and the generalization of soft to hyper soft sets was also introduced by him. Smarandache [7-9] also discussed the extensions of neutrosophic sets in MCDM and TOPSIS and in other researches it is also mentioned [10-15]. The applicability of these applications is also found in the fields of operational research [16-17].

The neutrosophic numbers from triangular to nonagonal have been published and have established their use in real-life. Triangular and pentagonal have membership function [18-20]. Wang [21] introduced that single-valued neutrosophic sets are an extension of NSs. Ye [22] developed its aggregate operations and Peng [23-24] introduced the applications of neutrosophic sets. The other remarkable MCDM researches have been presented by Abdel-Basset [25] and Riaz [26-27].



Motivation

The motivation for writing this article arose keeping in perspective the mutli dimensional problems associated with decision-making. So what makes the decognal approach different? This approach can be useful in solving mutli criteria decision-making problems associated with uncertain condition in a neutrosophic environment. Already triangular neutrosophic numbers to Nonagonal neutrosophic numbers are being used in the fields of medical, engineering, accounting, cryptography. But they carry with them some limitations in their functions. The limitations of using Triangular to nonagonal neutrosophic numbers in solving MCDM are low edges. They solve less complex problems, such as decision making based on less than ten edges. In order to overcome these limitations, Decagonal Neutrosophic numbers are introduced to deal with big and complex problems pertaining to decision-making. Each neutrosophic numbers have its edges and capability to deal with fluctuations e.g. triangular has three edges, pentagonal have five, octagonal has eight, and nonagonal have nine edges for truthiness, indeterminacy, and falsity. With decagonal we have ten edges. So, it is suitable to solve decision-making problems in a better way by having ten edges as it gives us a slight edge.

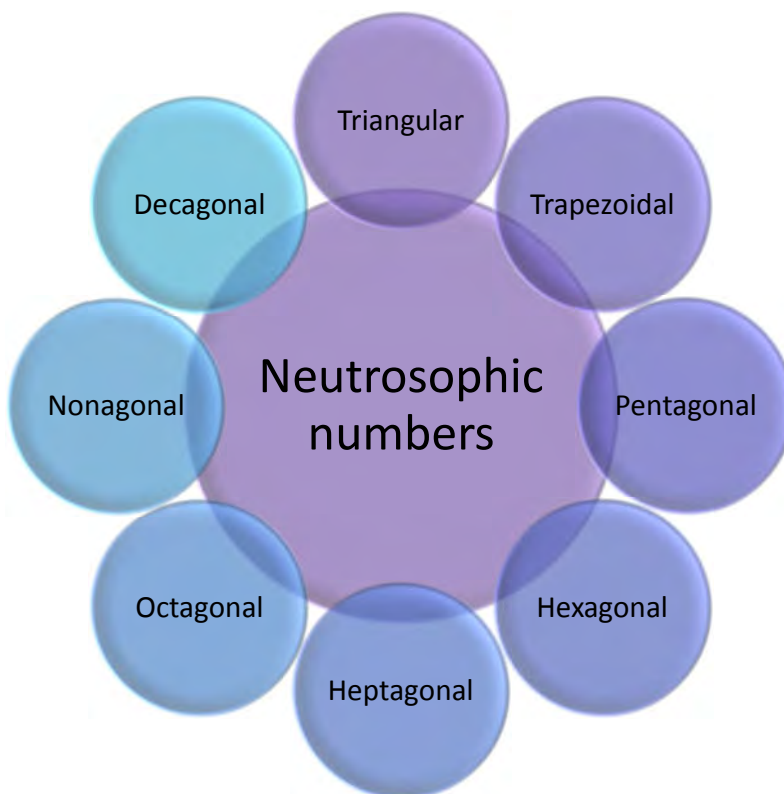

1.1 Contribution: From the beginning of human life, decision-making is a common activity and the complication arises when we have to decide multi-criteria. For this purpose, we give some researches (e.g. octagonal and

nonagonal neutrosophic numbers), but these have limitations. Now with decagonal, we can deal with maximum large and multi-criteria problems. Moreover, we present representations, alpha cuts, linear, and nonlinear. Now the MCDM problems solve much better and in a decent way. The decagonal is extremely handy, effective, accurate, and can deal with more fluctuations, mentioned below.

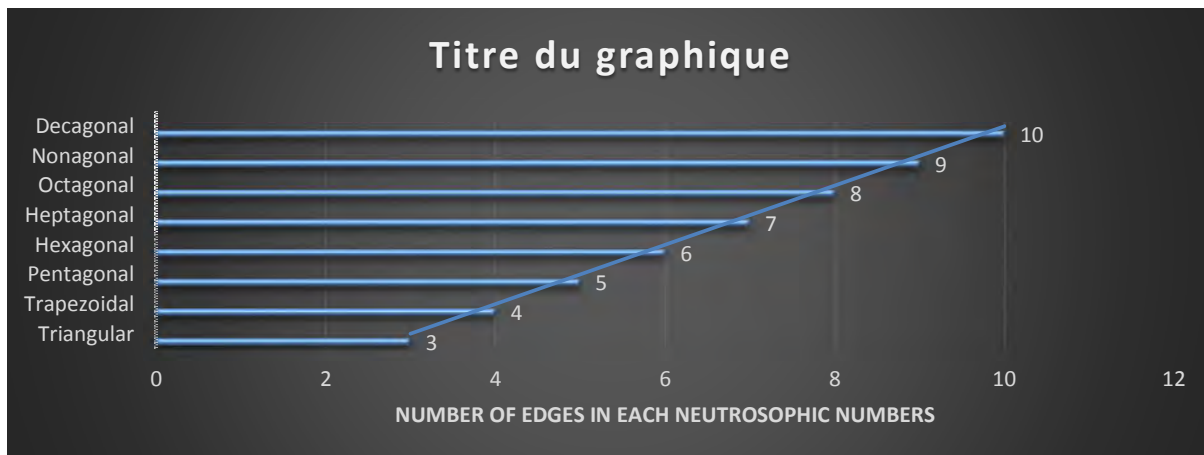

Structure of Article:

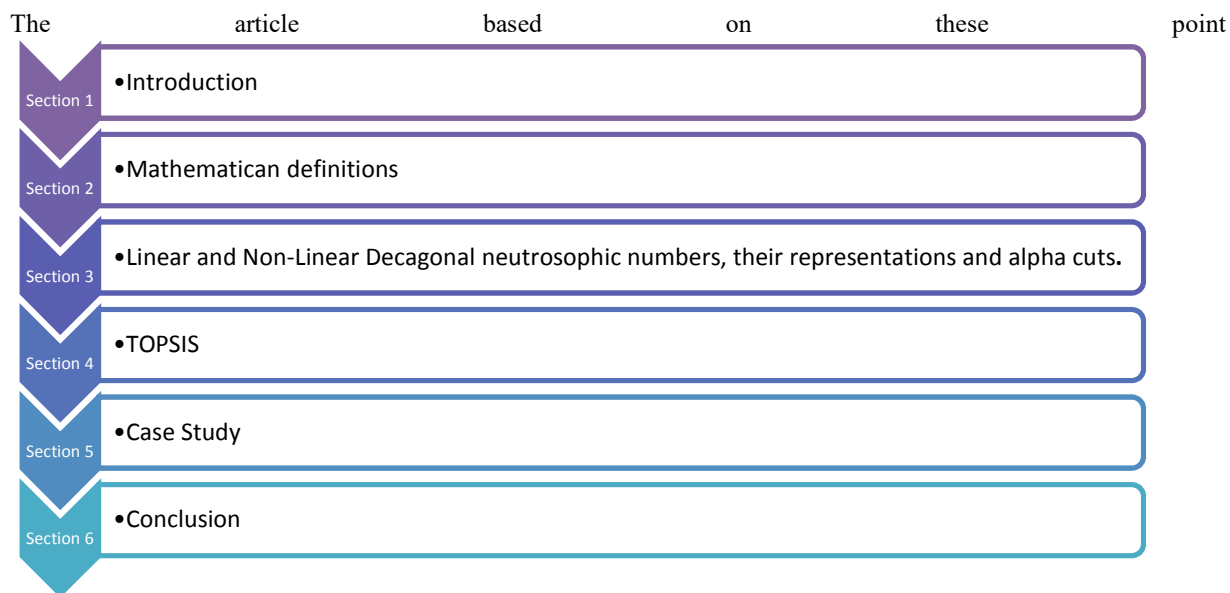

2. Definition

In this section we proposed necessary definitions, which will further use in article.

Definition 2.1: Soft sets: Let $\tilde{\xi}$ as universal set and the set of attributes is $\tilde{\epsilon}$ and $P(\tilde{\xi})$ as power set and $\subseteq \tilde{\epsilon}$. A pair (\tilde{F}, \tilde{A}) is soft set over $\tilde{\xi}$ and mapping is defined as:

$$\tilde{F}, P(\tilde{\xi})$$

Moreover,

$$(\vec{F}, \cdot) \{ \vec{F}(e) \in P(\vec{X}) : e \in \vec{E}, \vec{F}(e) = \emptyset \text{ if } e \neq A \}$$

Definition 2.2 Neutrosophic sets: Set $\vec{n}\hat{A}$ as neutrosophic if $\vec{n}\hat{A} = \{ \vec{x}; \langle [T_{\vec{n}\hat{A}}(\vec{x}), I_{\vec{n}\hat{A}}(\vec{x}), F_{\vec{n}\hat{A}}(\vec{x})] : \vec{x} \in \vec{X} \}$ where, for membership of truthiness $T_{\vec{n}\hat{A}}(\vec{x}) \rightarrow [0,1]$, for membership of indeterminacy $I_{\vec{n}\hat{A}}(\vec{x})$, for membership of falsity $F_{\vec{n}\hat{A}}(\vec{x})$ and the relation given following,

$$0^- \leq T_{\vec{n}\hat{A}}(\vec{x}) + I_{\vec{n}\hat{A}}(\vec{x}) + F_{\vec{n}\hat{A}}(\vec{x}) \leq 3^+$$

Definition 2.3: Triangular neutrosophic numbers: Triangular single value neutrosophic number is given as:

$A_{N\hat{e}u} = (P_1, P_2, P_3; r_1, r_2, r_3,)$ moreover, truthiness, indeterminacy and falsity are given as:

$$T_{A_{N\hat{e}u}}(\hat{x}) = \begin{cases} \frac{\hat{x} - p_1}{p_2 - p_1} & \text{for } p_1 \leq \hat{x} < p_2 \\ 1 & \text{when } \hat{x} = p_2 \\ \frac{p_3 - \hat{x}}{p_3 - p_2} & \text{for } p_2 < \hat{x} \leq p_3 \\ 0 & \text{otherwise} \end{cases}$$

$$I_{A_{N\hat{e}u}}(\hat{x}) = \begin{cases} \frac{q_2 - \hat{x}}{q_2 - q_1} & \text{for } q_1 \leq \hat{x} < q_2 \\ 0 & \text{when } \hat{x} = q_2 \\ \frac{\hat{x} - q_2}{q_3 - q_2} & \text{for } q_2 < \hat{x} \leq q_3 \\ 1 & \text{otherwise} \end{cases}$$

$$F_{A_{N\hat{e}u}}(\hat{x}) = \begin{cases} \frac{\hat{x} - p_1}{p_1 - p_2} & \text{for } p_1 \leq \hat{x} < p_2 \\ 1 & \text{when } \hat{x} = p_2 \\ \frac{p_3 - \hat{x}}{p_3 - p_2} & \text{for } p_2 < \hat{x} \leq p_3 \\ 0 & \text{otherwise} \end{cases}$$

Where,

$$0^- \leq T_{A_{N\hat{e}u}}(\hat{x}) + I_{A_{N\hat{e}u}}(\hat{x}) + F_{A_{N\hat{e}u}}(\hat{x}) \leq 3^+; \hat{x} \in A_{N\hat{e}u}$$

Parameter type: $(A_{N\hat{e}u})_{\hat{\alpha}, \hat{\beta}, \hat{\gamma}} = [T_{N\hat{e}u1}(\hat{\alpha}), T_{N\hat{e}u2}(\hat{\alpha}); I_{N\hat{e}u1}(\hat{\beta}), I_{N\hat{e}u2}(\hat{\beta}); F_{N\hat{e}u1}(\hat{\gamma}), F_{N\hat{e}u2}(\hat{\gamma})]$ where, $T_{N\hat{e}u1}(\hat{\alpha}) = p_1 + \hat{\alpha}(p_2 - p_1)$, $T_{N\hat{e}u2}(\hat{\alpha}) = p_3 - \hat{\alpha}(p_3 - p_2)$, $I_{N\hat{e}u1}(\hat{\beta}) = q_2 - \hat{\beta}(q_2 - q_1)$, $T_{N\hat{e}u1}(\hat{\beta}) = q_2 + \hat{\beta}(q_3 - q_2)$, $F_{N\hat{e}u1}(\hat{\gamma}) = r_2 - \hat{\gamma}(r_2 - r_1)$, $T_{N\hat{e}u1}(\hat{\gamma}) = r_2 + \hat{\gamma}(r_3 - r_2)$, where, $0 < \hat{\alpha} \leq 1, 0 < \hat{\beta} \leq 1, 0 < \hat{\gamma} \leq 1$ and $0 < \hat{\alpha} + \hat{\beta} + \hat{\gamma} < 3$.

Definition 2.4: Trapezoidal neutrosophic numbers: If \hat{X} be universe of discourse, define as: $\hat{N} = \{ \langle \hat{X}, T_{\hat{N}}(\hat{x}), I_{\hat{N}}(\hat{x}), F_{\hat{N}}(\hat{x}) \rangle : \hat{x} \in \hat{X} \}$ where $T_{\hat{N}}(\hat{x}) \in [0,1]$, $I_{\hat{N}}(\hat{x}) \in [0,1]$, $F_{\hat{N}}(\hat{x}) \in [0,1]$ as three trapezoidal numbers $T_{\hat{N}}(\hat{x}) = (t_N^1(\hat{x}), t_N^2(\hat{x}), t_N^3(\hat{x}), t_N^4(\hat{x})) : \hat{x} \rightarrow [0,1]$, $I_{\hat{N}}(\hat{x}) = (i_N^1(\hat{x}), i_N^2(\hat{x}), i_N^3(\hat{x}), i_N^4(\hat{x})) : \hat{x} \rightarrow [0,1]$, $F_{\hat{N}}(\hat{x}) = (f_N^1(\hat{x}), f_N^2(\hat{x}), f_N^3(\hat{x}), f_N^4(\hat{x})) : \hat{x} \rightarrow [0,1]$

With condition $0 \leq t_N^1(\hat{x}) + i_N^1(\hat{x}) + f_N^1(\hat{x}) \leq 3, 0 \leq t_N^2(\hat{x}) + i_N^2(\hat{x}) + f_N^2(\hat{x}) \leq 3 \hat{x} \in \hat{X}$.

DOI: 10.5281/zenodo.4721629

Definition 2.5: Pentagonal neutrosophic numbers : For single value it is given as:

$\mathcal{S} = \langle [m^1, n^1, o^1, p^1, q^1; \pi] [m^2, n^2, o^2, p^2, q^2; \xi] [m^3, n^3, o^3, p^3, q^3, \delta] \rangle$ where, $\pi, \xi, \delta \in [0,1]$. The Truth membership function (T_S): $\mathbb{R} \rightarrow [0, \pi]$, indeterminacy (I_S): $\mathbb{R} \rightarrow [0, \xi]$, and falsity (F_S): $\mathbb{R} \rightarrow [0, \delta]$ and given as:

$$T_S(x) = \begin{cases} T_{S1}(x) & m^1 \leq x < n^1 \\ T_{S2}(x) & n^1 \leq x < o^1 \\ \dot{\mu} & x = o^1 \\ T_{S2}(x) & o^1 \leq x < p^1 \\ T_{S1}(x) & p^1 \leq x < q^1 \\ 0 & \text{otherwise} \end{cases} \quad I_S(x) = \begin{cases} I_{S1}(x) & m^2 \leq x < n^2 \\ I_{S2}(x) & n^2 \leq x < o^2 \\ \dot{\theta} & x = o^2 \\ I_{S2}(x) & o^2 \leq x < p^2 \\ I_{S1}(x) & p^2 \leq x < q^2 \\ 1 & \text{otherwise} \end{cases}$$

$$F_S(x) = \begin{cases} F_{S1}(x) & m^3 \leq x < n^3 \\ F_{S2}(x) & n^3 \leq x < o^3 \\ \dot{\epsilon} & x = o^3 \\ F_{S2}(x) & o^3 \leq x < p^3 \\ F_{S1}(x) & p^3 \leq x < q^3 \\ 1 & \text{otherwise} \end{cases}$$

Where, $\langle [m^1 < n^1 < o^1 < p^1 < q^1]: \dot{\mu} [m^2 < n^2 < o^2 < p^2 < q^2]: \dot{\theta} [m^3 < n^3 < o^3 < p^3 < q^3]: \dot{\epsilon} \rangle$

Definition 2.6: Octagonal neutrosophic numbers : A neutrosophic number denoted by \mathcal{S} and defined as:

$\mathcal{S} = \langle [(\dots, \dots, \dots): \dot{\mu}], [(\dots, \dots, \dots, \dots, \dots, \dots, \dots, \dots): \dot{\theta}] [(\dots, \dots, \dots, \dots, \dots, \dots, \dots, \dots): \dot{\epsilon}] \rangle$ where, $\dot{\mu}, \dot{\epsilon}, \dot{\theta} \in [0,1]$.

Truth membership function as, ($\dot{\mu}_S$): $\mathbb{R} \rightarrow [0,1]$, Indeterminacy membership function as, ($\dot{\theta}_S$): $\mathbb{R} \rightarrow [0,1]$.

Falsity membership function as, ($\dot{\epsilon}_S$): $\mathbb{R} \rightarrow [0,1]$.

$$\dot{\mu}_S(x) = \begin{cases} \dot{\mu}_{S0}(x) & \leq x < \dots \\ \dot{\mu}_{S1}(x) & \leq x < \dots \\ \dot{\mu}_{S2}(x) & \leq x < \dots \\ \dot{\mu}_{S3}(x) & \leq x < \dots \\ \dot{\mu}_{S3}(x) & x = \mathcal{E} \\ \dot{\mu}_{S3}(x) & \leq x < \dots \\ \dot{\mu}_{S2}(x) & \leq x < \dots \\ \dot{\mu}_{S1}(x) & \leq x < \dots \\ 0 & \text{otherwise} \end{cases} \quad \dot{\theta} = \begin{cases} \dot{\theta}_{S0}(x) & 1 \leq x < 1 \\ \dot{\theta}_{S1}(x) & 1 \leq x < 1 \\ \dot{\theta}_{S2}(x) & 1 \leq x < 1 \\ \dot{\theta}_{S3}(x) & 1 \leq x < 1 \\ \dot{\theta}_{S3}(x) & x = \mathcal{E}^1 \\ \dot{\theta}_{S3}(x) & 1 \leq x < 1 \\ \dot{\theta}_{S2}(x) & 1 \leq x < 1 \\ \dot{\theta}_{S1}(x) & 1 \leq x < 1 \\ 1 & \text{otherwise} \end{cases} \quad \dot{\epsilon} = \begin{cases} \dot{\epsilon}_{S0}(x) & 2 \leq x < 2 \\ \dot{\epsilon}_{S1}(x) & 2 \leq x < 2 \\ \dot{\epsilon}_{S2}(x) & 2 \leq x < 2 \\ \dot{\epsilon}_{S3}(x) & 2 \leq x < 2 \\ \dot{\epsilon}_{S3}(x) & x = \mathcal{E}^2 \\ \dot{\epsilon}_{S3}(x) & 2 \leq x < 2 \\ \dot{\epsilon}_{S2}(x) & 2 \leq x < 2 \\ \dot{\epsilon}_{S1}(x) & 2 \leq x < 2 \\ 1 & \text{otherwise} \end{cases}$$

$\mathcal{S} = \langle [(\dots < \dots < \dots < \dots < \dots < \dots < \dots < \dots < \dots < \dots < \dots < \dots < \dots < \dots < \dots < \dots): \dot{\mu}], [(\dots < \dots < \dots < \dots < \dots < \dots < \dots < \dots < \dots < \dots < \dots < \dots < \dots < \dots < \dots < \dots): \dot{\theta}] [(\dots < \dots < \dots < \dots < \dots < \dots < \dots < \dots < \dots < \dots < \dots < \dots < \dots < \dots < \dots < \dots): \dot{\epsilon}] \rangle$

Definition 2.7: Nona gonal neutrosophic numbers : A neutrosophic number denoted by \mathcal{S} and defined as:

$\mathcal{S} = \langle [(\dots, \dots, \dots, \dots, \dots, \dots, \dots, \dots, \dots): \dot{\mu}], [(\dots, \dots, \dots, \dots, \dots, \dots, \dots, \dots, \dots): \dot{\theta}] [(\dots, \dots, \dots, \dots, \dots, \dots, \dots, \dots, \dots): \dot{\epsilon}] \rangle$

where, $\hat{\mu}, \hat{\epsilon}, \hat{\theta} \in [0,1]$. $\hat{S} = \langle [(\hat{\mu}_1, \hat{\mu}_2, \dots, \hat{\mu}_n), (\hat{\epsilon}_1, \hat{\epsilon}_2, \dots, \hat{\epsilon}_n), (\hat{\theta}_1, \hat{\theta}_2, \dots, \hat{\theta}_n)] \rangle$

Truth membership function as, $(\hat{\mu}_S): \mathbb{R} \rightarrow [0,1]$.

Indeterminacy membership function as, $(\hat{\theta}_S): \mathbb{R} \rightarrow [0,1]$.

Falsity membership function as, $(\hat{\epsilon}_S): \mathbb{R} \rightarrow [0,1]$.

$$\hat{\mu}_S(x) = \begin{cases} \hat{\mu}_{S0}(x) & \leq x < \dots \\ \hat{\mu}_{S1}(x) & \leq x < \dots \\ \hat{\mu}_{S2}(x) & \leq x < \dots \\ \hat{\mu}_{S3}(x) & \leq x < \dots \\ \hat{\theta} & x = \mathcal{E} \\ \hat{\mu}_{S3}(x) & \leq x < \dots \\ \hat{\mu}_{S2}(x) & \leq x < \dots \\ \hat{\mu}_{S1}(x) & \leq x < \dots \\ \hat{\mu}_{S0}(x) & \leq x < \mathbb{Q}^1 \\ 0 & \text{otherwise} \end{cases} \quad \hat{\theta} = \begin{cases} \hat{\theta}_{S0}(x) & 1 \leq x < 1 \\ \hat{\theta}_{S1}(x) & 1 \leq x < 1 \\ \hat{\theta}_{S2}(x) & 1 \leq x < 1 \\ \hat{\theta}_{S3}(x) & 1 \leq x < 1 \\ \hat{\theta} & x = \mathcal{E} \\ \hat{\theta}_{S3}(x) & 1 \leq x < 1 \\ \hat{\theta}_{S2}(x) & 1 \leq x < 1 \\ \hat{\theta}_{S1}(x) & 1 \leq x < 1 \\ \hat{\mu}_{S0}(x) & 1 \leq x < \mathbb{Q}^1 \\ 1 & \text{otherwise} \end{cases} \quad \hat{\epsilon} = \begin{cases} \hat{\epsilon}_{S0}(x) & 2 \leq x < 2 \\ \hat{\epsilon}_{S1}(x) & 2 \leq x < 2 \\ \hat{\epsilon}_{S2}(x) & 2 \leq x < 2 \\ \hat{\epsilon}_{S3}(x) & 2 \leq x < 2 \\ \hat{\theta} & x = \mathcal{E}^2 \\ \hat{\epsilon}_{S3}(x) & 2 \leq x < 2 \\ \hat{\epsilon}_{S2}(x) & 2 \leq x < 2 \\ \hat{\epsilon}_{S1}(x) & 2 \leq x < 2 \\ \hat{\mu}_{S0}(x) & 2 \leq x < \mathbb{Q}^2 \\ 1 & \text{otherwise} \end{cases}$$

3. Representation and Properties.

3.1 Linear Decagonal neutrosophic numbers with symmetry

$A_{LS} = (\hat{a}, \hat{b}, \hat{c}, \hat{d}, \hat{e}, \hat{f}, \hat{g}, \hat{h}, \hat{i})$ as linear DNN with these membership function:

$$Truth = T_L(\hat{X}) = \begin{cases} 0 & \hat{x} < \hat{a} \\ k \left(\frac{\hat{x} - \hat{a}}{\hat{b} - \hat{a}} \right) & \hat{a} < \hat{x} < \hat{b} \\ k \left(\frac{\hat{x} - \hat{b}}{\hat{c} - \hat{b}} \right) & \hat{b} < \hat{x} < \hat{c} \\ k & \hat{c} < \hat{x} < \hat{d} \\ k + (1 - k) \left(\frac{\hat{x} - \hat{d}}{\hat{e} - \hat{d}} \right) & \hat{d} < \hat{x} < \hat{e} \\ 1 & \hat{e} < \hat{x} < \hat{f} \\ k + (1 - k) \left(\frac{\hat{g} - \hat{x}}{\hat{g} - \hat{f}} \right) & \hat{f} < \hat{x} < \hat{g} \\ k & \hat{g} < \hat{x} < \hat{h} \\ k \left(\frac{\hat{i} - \hat{x}}{\hat{i} - \hat{h}} \right) & \hat{h} < \hat{x} < \hat{i} \\ k \left(\frac{\hat{j} - \hat{x}}{\hat{j} - \hat{i}} \right) & \hat{i} < \hat{x} < \hat{j} \\ 0 & \hat{x} > \hat{j} \end{cases}$$

$$\begin{aligned}
 \text{Falsity} = F_L(\dot{X}) &= \begin{cases} 0 & \dot{x} < a^1 \\ k \left(\frac{\dot{x} - a^1}{b^1 - a^1} \right) & a^1 < \dot{x} < b^1 \\ k \left(\frac{\dot{x} - b^1}{c^1 - b^1} \right) & b^1 < \dot{x} < c^1 \\ k & c^1 < \dot{x} < d^1 \\ k + (1 - k) \left(\frac{\dot{x} - d^1}{e^1 - d^1} \right) & d^1 < \dot{x} < e^1 \\ 1 & e^1 < \dot{x} < f^1 \\ k + (1 - k) \left(\frac{g^1 - \dot{x}}{g^1 - f^1} \right) & f^1 < \dot{x} < g^1 \\ k & g^1 < \dot{x} < h^1 \\ k \left(\frac{i^1 - \dot{x}}{i^1 - h^1} \right) & h^1 < \dot{x} < i^1 \\ k \left(\frac{j^1 - \dot{x}}{j^1 - i^1} \right) & i^1 < \dot{x} < j^1 \\ 1 & \dot{x} > j^1 \end{cases} \\
 \text{Indeterminacy} = I_L(\dot{X}) &= \begin{cases} 0 & \dot{x} < a^2 \\ k \left(\frac{\dot{x} - a^2}{b^2 - a^2} \right) & a^2 < \dot{x} < b^2 \\ k \left(\frac{\dot{x} - b^2}{c^2 - b^2} \right) & b^2 < \dot{x} < c^2 \\ k & c^2 < \dot{x} < d^2 \\ k + (1 - k) \left(\frac{\dot{x} - d^2}{e^2 - d^2} \right) & d^2 < \dot{x} < e^2 \\ 1 & e^2 < \dot{x} < f^2 \\ k + (1 - k) \left(\frac{g^2 - \dot{x}}{g^2 - f^2} \right) & f^2 < \dot{x} < g^2 \\ k & g^2 < \dot{x} < h^2 \\ k \left(\frac{i^2 - \dot{x}}{i^2 - h^2} \right) & h^2 < \dot{x} < i^2 \\ k \left(\frac{j^2 - \dot{x}}{j^2 - i^2} \right) & i^2 < \dot{x} < j^2 \\ 1 & \dot{x} > j^2 \end{cases}
 \end{aligned}$$

As, $0 < k < 1$

$$A_\alpha = \{ \dot{x} \in \dot{X} \mid T_L(\dot{X}), F_L(\dot{X}), I_L(\dot{X}) \geq \alpha \}$$

3.2 α – cut of Linear DNN with symmetry: We can express as:

$$\begin{aligned}
 \text{Truth} = \hat{T}_L(\hat{X}) &= \left\{ \begin{aligned}
 A'_{1L}(\hat{\alpha}) &= \hat{a} + \frac{\hat{\alpha}}{\hat{b}_1}(\hat{b} - \hat{a}) \quad \text{for } \hat{\alpha} \in [0, \hat{b}_1] \\
 A'_{2L}(\hat{\alpha}) &= \hat{b} + \frac{1 - \hat{\alpha}}{1 - \hat{b}_2}(\hat{c} - \hat{b}) \quad \text{for } \hat{\alpha} \in [\hat{b}_2, 1] \\
 A'_{3L}(\hat{\alpha}) &= \hat{c} + \frac{1 - \hat{\alpha}}{1 - \hat{b}_3}(\hat{d} - \hat{c}) \quad \text{for } \hat{\alpha} \in [\hat{b}_3, 1] \\
 A'_{4L}(\hat{\alpha}) &= \hat{d} + \frac{1 - \hat{\alpha}}{1 - \hat{b}_4}(\hat{e} - \hat{d}) \quad \text{for } \hat{\alpha} \in [\hat{b}_4, 1] \\
 A'_{5L}(\hat{\alpha}) &= \hat{e} + \frac{1 - \hat{\alpha}}{1 - \hat{b}_5}(\hat{f} - \hat{e}) \quad \text{for } \hat{\alpha} \in [\hat{b}_5, 1] \\
 A'_{4R}(\hat{\alpha}) &= \hat{f} - \frac{\hat{\alpha}}{\hat{b}_4}(\hat{g} - \hat{f}) \quad \text{for } \hat{\alpha} \in [0, \hat{b}_4] \\
 A'_{3R}(\hat{\alpha}) &= \hat{g} - \frac{\hat{\alpha}}{\hat{b}_3}(\hat{h} - \hat{g}) \quad \text{for } \hat{\alpha} \in [0, \hat{b}_3] \\
 A'_{2R}(\hat{\alpha}) &= \hat{h} - \frac{\hat{\alpha}}{\hat{b}_2}(\hat{i} - \hat{h}) \quad \text{for } \hat{\alpha} \in [0, \hat{b}_2] \\
 A'_{1R}(\hat{\alpha}) &= \hat{i} - \frac{\hat{\alpha}}{\hat{b}_1}(\hat{j} - \hat{i}) \quad \text{for } \hat{\alpha} \in [0, \hat{b}_1]
 \end{aligned} \right. \\
 \\
 \text{Falsity} = \hat{F}_L(\hat{X}) &= \left\{ \begin{aligned}
 A'_{1L}(\hat{\alpha}) &= \hat{a}^1 + \frac{\hat{\alpha}}{\hat{b}_1}(\hat{b}^1 - \hat{a}^1) \quad \text{for } \hat{\alpha} \in [0, \hat{b}_1] \\
 A'_{2L}(\hat{\alpha}) &= \hat{b}^1 + \frac{1 - \hat{\alpha}}{1 - \hat{b}_2}(\hat{c}^1 - \hat{b}^1) \quad \text{for } \hat{\alpha} \in [\hat{b}_2, 1] \\
 A'_{3L}(\hat{\alpha}) &= \hat{c}^1 + \frac{1 - \hat{\alpha}}{1 - \hat{b}_3}(\hat{d}^1 - \hat{c}^1) \quad \text{for } \hat{\alpha} \in [\hat{b}_3, 1] \\
 A'_{4L}(\hat{\alpha}) &= \hat{d}^1 + \frac{1 - \hat{\alpha}}{1 - \hat{b}_4}(\hat{e}^1 - \hat{d}^1) \quad \text{for } \hat{\alpha} \in [\hat{b}_4, 1] \\
 A'_{5L}(\hat{\alpha}) &= \hat{e}^1 + \frac{1 - \hat{\alpha}}{1 - \hat{b}_5}(\hat{f}^1 - \hat{e}^1) \quad \text{for } \hat{\alpha} \in [\hat{b}_5, 1] \\
 A'_{4R}(\hat{\alpha}) &= \hat{f}^1 - \frac{\hat{\alpha}}{\hat{b}_4}(\hat{g}^1 - \hat{f}^1) \quad \text{for } \hat{\alpha} \in [0, \hat{b}_4] \\
 A'_{3R}(\hat{\alpha}) &= \hat{g}^1 - \frac{\hat{\alpha}}{\hat{b}_3}(\hat{h}^1 - \hat{g}^1) \quad \text{for } \hat{\alpha} \in [0, \hat{b}_3] \\
 A'_{2R}(\hat{\alpha}) &= \hat{h}^1 - \frac{\hat{\alpha}}{\hat{b}_2}(\hat{i}^1 - \hat{h}^1) \quad \text{for } \hat{\alpha} \in [0, \hat{b}_2] \\
 A'_{1R}(\hat{\alpha}) &= \hat{i}^1 - \frac{\hat{\alpha}}{\hat{b}_1}(\hat{j}^1 - \hat{i}^1) \quad \text{for } \hat{\alpha} \in [0, \hat{b}_1]
 \end{aligned} \right.
 \end{aligned}$$

$$Indeterminacy = I_L(\dot{X}) = \begin{cases} A'_{1L}(\dot{\alpha}) = \dot{\alpha}^2 + \frac{\dot{\alpha}}{b_1}(b^2 - \dot{\alpha}^2) & \text{for } \dot{\alpha} \in [0, \dot{b}_1] \\ A'_{2L}(\dot{\alpha}) = \dot{b}^2 + \frac{1 - \dot{\alpha}}{1 - b_2}(c^2 - \dot{b}^2) & \text{for } \dot{\alpha} \in [\dot{b}_2, 1] \\ A'_{3L}(\dot{\alpha}) = c^2 + \frac{1 - \dot{\alpha}}{1 - b_3}(d^2 - c^2) & \text{for } \dot{\alpha} \in [\dot{b}_3, 1] \\ A'_{4L}(\dot{\alpha}) = d^2 + \frac{1 - \dot{\alpha}}{1 - b_4}(e^2 - d^2) & \text{for } \dot{\alpha} \in [\dot{b}_4, 1] \\ A'_{5L}(\dot{\alpha}) = e^2 + \frac{1 - \dot{\alpha}}{1 - b_5}(f^2 - e^2) & \text{for } \dot{\alpha} \in [\dot{b}_5, 1] \\ A'_{4R}(\dot{\alpha}) = f^2 - \frac{\dot{\alpha}}{b_4}(g^2 - f^2) & \text{for } \dot{\alpha} \in [0, \dot{b}_4] \\ A'_{3R}(\dot{\alpha}) = g^2 - \frac{\dot{\alpha}}{b_3}(h^2 - g^2) & \text{for } \dot{\alpha} \in [0, \dot{b}_3] \\ A'_{2R}(\dot{\alpha}) = h^2 - \frac{\dot{\alpha}}{b_2}(i^2 - h^2) & \text{for } \dot{\alpha} \in [0, \dot{b}_2] \\ A'_{1R}(\dot{\alpha}) = i^2 - \frac{\dot{\alpha}}{b_1}(j^2 - i^2) & \text{for } \dot{\alpha} \in [0, \dot{b}_1] \end{cases}$$

Increasing are $A'_{1L}(\dot{\alpha}), A'_{2L}(\dot{\alpha}), A'_{3L}(\dot{\alpha}), A'_{4L}(\dot{\alpha}), A'_{5L}(\dot{\alpha})$ and decreasing are $A'_{1R}(\dot{\alpha}), A'_{2R}(\dot{\alpha}), A'_{3R}(\dot{\alpha}), A'_{4R}(\dot{\alpha})$.

3.3 Non-Linear Decagonal neutrosophic numbers with symmetry:

$A_{LS} = (\dot{\alpha}, \dot{b}, \dot{c}, \dot{d}, \dot{e}, \dot{f}, \dot{g}, \dot{h}, \dot{i})_{(n_1, n_2, n_3, m_1, m_2, m_3)}$ as non-linear DNN with these membership function:

$$Truth = T_L(\dot{X}) = \begin{cases} 0 & \dot{x} < \dot{\alpha} \\ k \left(\frac{\dot{x} - \dot{\alpha}}{\dot{b} - \dot{\alpha}} \right)^{n_1} & \dot{\alpha} < \dot{x} < \dot{b} \\ k \left(\frac{\dot{x} - \dot{b}}{\dot{c} - \dot{b}} \right)^{n_2} & \dot{b} < \dot{x} < \dot{c} \\ k & \dot{c} < \dot{x} < \dot{d} \\ k + (1 - k) \left(\frac{\dot{x} - \dot{d}}{\dot{e} - \dot{d}} \right)^{n_3} & \dot{d} < \dot{x} < \dot{e} \\ 1 & \dot{e} < \dot{x} < \dot{f} \\ k + (1 - k) \left(\frac{\dot{g} - \dot{x}}{\dot{g} - \dot{f}} \right)^{m_1} & \dot{f} < \dot{x} < \dot{g} \\ k & \dot{g} < \dot{x} < \dot{h} \\ k \left(\frac{\dot{i} - \dot{x}}{\dot{i} - \dot{h}} \right)^{m_2} & \dot{h} < \dot{x} < \dot{i} \\ k \left(\frac{\dot{j} - \dot{x}}{\dot{j} - \dot{i}} \right)^{m_3} & \dot{i} < \dot{x} < \dot{j} \\ 0 & \dot{x} > \dot{j} \end{cases}$$

$$Falsity = F_L(\dot{X}) = \begin{cases} 0 & \dot{x} < a^1 \\ k \left(\frac{\dot{x} - a^1}{b^1 - a^1} \right)^{m_1} & a^1 < \dot{x} < b^1 \\ k \left(\frac{\dot{x} - b^1}{c^1 - b^1} \right)^{m_2} & b^1 < \dot{x} < c^1 \\ k & c^1 < \dot{x} < d^1 \\ k + (1 - k) \left(\frac{\dot{x} - d^1}{e^1 - d^1} \right)^{m_3} & d^1 < \dot{x} < e^1 \\ 1 & e^1 < \dot{x} < f^1 \\ k + (1 - k) \left(\frac{g^1 - \dot{x}}{g^1 - f^1} \right)^{n_1} & f^1 < \dot{x} < g^1 \\ k & g^1 < \dot{x} < h^1 \\ k \left(\frac{i^1 - \dot{x}}{i^1 - h^1} \right)^{n_2} & h^1 < \dot{x} < i^1 \\ k \left(\frac{j^1 - \dot{x}}{j^1 - i^1} \right)^{n_3} & i^1 < \dot{x} < j^1 \\ 1 & \dot{x} > j^1 \end{cases}$$

$$Indeterminacy = I_L(\dot{X}) = \begin{cases} 0 & \dot{x} < a^2 \\ k \left(\frac{\dot{x} - a^2}{b^2 - a^2} \right)^{m_1} & a^2 < \dot{x} < b^2 \\ k \left(\frac{\dot{x} - b^2}{c^2 - b^2} \right)^{m_2} & b^2 < \dot{x} < c^2 \\ k & c^2 < \dot{x} < d^2 \\ k + (1 - k) \left(\frac{\dot{x} - d^2}{e^2 - d^2} \right)^{m_3} & d^2 < \dot{x} < e^2 \\ 1 & e^2 < \dot{x} < f^2 \\ k + (1 - k) \left(\frac{g^2 - \dot{x}}{g^2 - f^2} \right)^{n_1} & f^2 < \dot{x} < g^2 \\ k & g^2 < \dot{x} < h^2 \\ k \left(\frac{i^2 - \dot{x}}{i^2 - h^2} \right)^{n_2} & h^2 < \dot{x} < i^2 \\ k \left(\frac{j^2 - \dot{x}}{j^2 - i^2} \right)^{n_3} & i^2 < \dot{x} < j^2 \\ 1 & \dot{x} > j^2 \end{cases}$$

As, $0 < k < 1 \quad A_\alpha = \{\dot{x} \in \dot{X} | T_L(\dot{X}), F_L(\dot{X}), I_L(\dot{X}) \geq \alpha\}$

3.4 α – cut óf Non –Linear DNN with symmetry:

α – cut óf Non –Linear DNN can be defined as $A_\alpha = \{\dot{x} \in X | T_L(X), F_L(X), I_L(X) \geq \alpha\}$

$$\text{Truth} = T_L(X) = \left\{ \begin{array}{l}
 A'_{1L}(\alpha) = a + \left(\frac{\alpha}{b_1}\right)^{n_1} (b - a) \quad \text{for } \alpha \in [0, \hat{b}_1] \\
 A'_{2L}(\alpha) = b + \left(\frac{1 - \alpha}{1 - b_2}\right)^{n_2} (c - b) \quad \text{for } \alpha \in [\hat{b}_2, 1] \\
 A'_{3L}(\alpha) = c + \left(\frac{1 - \alpha}{1 - b_3}\right)^{n_3} (d - c) \quad \text{for } \alpha \in [\hat{b}_3, 1] \\
 A'_{4L}(\alpha) = d + \left(\frac{1 - \alpha}{1 - b_4}\right)^{n_4} (e - d) \quad \text{for } \alpha \in [\hat{b}_4, 1] \\
 A'_{5L}(\alpha) = e + \left(\frac{1 - \alpha}{1 - b_5}\right)^{n_5} (f - e) \quad \text{for } \alpha \in [\hat{b}_5, 1] \\
 A'_{4R}(\alpha) = f - \left(\frac{\alpha}{b_4}\right)^{m_1} (g - f) \quad \text{for } \alpha \in [0, \hat{b}_4] \\
 A'_{3R}(\alpha) = g - \left(\frac{\alpha}{b_3}\right)^{m_2} (h - g) \quad \text{for } \alpha \in [0, \hat{b}_3] \\
 A'_{2R}(\alpha) = h - \left(\frac{\alpha}{b_2}\right)^{m_3} (i - h) \quad \text{for } \alpha \in [0, \hat{b}_2] \\
 A'_{1R}(\alpha) = i - \left(\frac{\alpha}{b_1}\right)^{m_4} (j - i) \quad \text{for } \alpha \in [0, \hat{b}_1]
 \end{array} \right.$$

$$\text{Falsity} = F_L(X) = \left\{ \begin{array}{l}
 A'_{1L}(\alpha) = a^1 + \left(\frac{\alpha}{b_1}\right)^{m_1} (b^1 - a^1) \quad \text{for } \alpha \in [0, \hat{b}_1] \\
 A'_{2L}(\alpha) = b^1 + \left(\frac{1 - \alpha}{1 - b_2}\right)^{m_2} (c^1 - b^1) \quad \text{for } \alpha \in [\hat{b}_2, 1] \\
 A'_{3L}(\alpha) = c^1 + \left(\frac{1 - \alpha}{1 - b_3}\right)^{m_3} (d^1 - c^1) \quad \text{for } \alpha \in [\hat{b}_3, 1] \\
 A'_{4L}(\alpha) = d^1 + \left(\frac{1 - \alpha}{1 - b_4}\right)^{m_4} (e^1 - d^1) \quad \text{for } \alpha \in [\hat{b}_4, 1] \\
 A'_{5L}(\alpha) = e^1 + \left(\frac{1 - \alpha}{1 - b_5}\right)^{m_5} (f^1 - e^1) \quad \text{for } \alpha \in [\hat{b}_5, 1] \\
 A'_{4R}(\alpha) = f^1 - \left(\frac{\alpha}{b_4}\right)^{n_1} (g^1 - f^1) \quad \text{for } \alpha \in [0, \hat{b}_4] \\
 A'_{3R}(\alpha) = g^1 - \left(\frac{\alpha}{b_3}\right)^{n_2} (h^1 - g^1) \quad \text{for } \alpha \in [0, \hat{b}_3] \\
 A'_{2R}(\alpha) = h^1 - \left(\frac{\alpha}{b_2}\right)^{n_3} (i^1 - h^1) \quad \text{for } \alpha \in [0, \hat{b}_2] \\
 A'_{1R}(\alpha) = i^1 - \left(\frac{\alpha}{b_1}\right)^{n_4} (j^1 - i^1) \quad \text{for } \alpha \in [0, \hat{b}_1]
 \end{array} \right.$$

$$\text{Indeterminacy} = I_L(\dot{X}) = \left\{ \begin{array}{l} A'_{1L}(\dot{\alpha}) = \dot{a}^2 + \left(\frac{\dot{\alpha}}{\dot{b}_1}\right)^{m_1} (\dot{b}^2 - \dot{a}^2) \quad \text{for } \dot{\alpha} \in [0, \dot{b}_1] \\ A'_{2L}(\dot{\alpha}) = \dot{b}^2 + \left(\frac{1-\dot{\alpha}}{1-\dot{b}_2}\right)^{m_2} (\dot{c}^2 - \dot{b}^2) \quad \text{for } \dot{\alpha} \in [\dot{b}_2, 1] \\ A'_{3L}(\dot{\alpha}) = \dot{c}^2 + \left(\frac{1-\dot{\alpha}}{1-\dot{b}_3}\right)^{m_3} (\dot{d}^2 - \dot{c}^2) \quad \text{for } \dot{\alpha} \in [\dot{b}_3, 1] \\ A'_{4L}(\dot{\alpha}) = \dot{d}^2 + \left(\frac{1-\dot{\alpha}}{1-\dot{b}_4}\right)^{m_4} (\dot{e}^2 - \dot{d}^2) \quad \text{for } \dot{\alpha} \in [\dot{b}_4, 1] \\ A'_{5L}(\dot{\alpha}) = \dot{e}^2 + \left(\frac{1-\dot{\alpha}}{1-\dot{b}_5}\right)^{m_5} (\dot{f}^2 - \dot{e}^2) \quad \text{for } \dot{\alpha} \in [\dot{b}_5, 1] \\ A'_{4R}(\dot{\alpha}) = \dot{f}^2 - \left(\frac{\dot{\alpha}}{\dot{b}_4}\right)^{n_1} (\dot{g}^2 - \dot{f}^2) \quad \text{for } \dot{\alpha} \in [0, \dot{b}_4] \\ A'_{3R}(\dot{\alpha}) = \dot{g}^2 - \left(\frac{\dot{\alpha}}{\dot{b}_3}\right)^{n_2} (\dot{h}^2 - \dot{g}^2) \quad \text{for } \dot{\alpha} \in [0, \dot{b}_3] \\ A'_{2R}(\dot{\alpha}) = \dot{h}^2 - \left(\frac{\dot{\alpha}}{\dot{b}_2}\right)^{n_3} (\dot{i}^2 - \dot{h}^2) \quad \text{for } \dot{\alpha} \in [0, \dot{b}_2] \\ A'_{1R}(\dot{\alpha}) = \dot{i}^2 - \left(\frac{\dot{\alpha}}{\dot{b}_1}\right)^{n_4} (\dot{j}^2 - \dot{i}^2) \quad \text{for } \dot{\alpha} \in [0, \dot{b}_1] \end{array} \right.$$

Increasing are $A'_{1L}(\dot{\alpha}), A'_{2L}(\dot{\alpha}), A'_{3L}(\dot{\alpha}), A'_{4L}(\dot{\alpha}), A'_{5L}(\dot{\alpha})$ and decreasing are $A'_{1R}(\dot{\alpha}), A'_{2R}(\dot{\alpha}), A'_{3R}(\dot{\alpha}), A'_{4R}(\dot{\alpha})$.

$$\text{Truth} = T_L(\dot{X}) = \left\{ \begin{array}{ll} 0 & \dot{x} < \dot{a} \\ \dot{p} \left(\frac{\dot{x}-\dot{a}}{\dot{b}-\dot{a}}\right)^{n_1} & \dot{a} < \dot{x} < \dot{b} \\ \dot{p} \left(\frac{\dot{x}-\dot{b}}{\dot{c}-\dot{b}}\right)^{n_2} & \dot{b} < \dot{x} < \dot{c} \\ \dot{k} & \dot{c} < \dot{x} < \dot{d} \\ \dot{k} - (\dot{k} - \dot{p}) \left(\frac{\dot{x}-\dot{d}}{\dot{e}-\dot{d}}\right)^{n_3} & \dot{d} < \dot{x} < \dot{e} \\ 1 & \dot{e} < \dot{x} < \dot{f} \\ \dot{k} - (\dot{k} - \dot{r}) \left(\frac{\dot{g}-\dot{x}}{\dot{g}-\dot{f}}\right)^{m_1} & \dot{f} < \dot{x} < \dot{g} \\ \dot{k} & \dot{g} < \dot{x} < \dot{h} \\ \dot{r} \left(\frac{\dot{i}-\dot{x}}{\dot{i}-\dot{h}}\right)^{m_2} & \dot{h} < \dot{x} < \dot{i} \\ \dot{r} \left(\frac{\dot{j}-\dot{x}}{\dot{j}-\dot{i}}\right)^{m_3} & \dot{i} < \dot{x} < \dot{j} \\ 0 & \dot{x} > \dot{j} \end{array} \right.$$

$$Indeterminacy = I_L(\dot{X}) = \begin{cases} 0 & \dot{x} < a^1 \\ y \left(\frac{\dot{x} - a^1}{b^1 - a^1} \right)^{m_1} & a^1 < \dot{x} < b^1 \\ y \left(\frac{\dot{x} - b^1}{c^1 - b^1} \right)^{m_2} & b^1 < \dot{x} < c^1 \\ X & c^1 < \dot{x} < d^1 \\ X - (X \dot{-} y) \left(\frac{\dot{x} - d^1}{e^1 - d^1} \right)^{m_3} & d^1 < \dot{x} < e^1 \\ 1 & e^1 < \dot{x} < f^1 \\ X - (X \dot{-} Z) \left(\frac{g^1 - \dot{x}}{g^1 - f^1} \right)^{n_1} & f^1 < \dot{x} < g^1 \\ z & g^1 < \dot{x} < h^1 \\ z \left(\frac{i^1 - \dot{x}}{i^1 - h^1} \right)^{n_2} & h^1 < \dot{x} < i^1 \\ z \left(\frac{j^1 - \dot{x}}{j^1 - i^1} \right)^{n_3} & i^1 < \dot{x} < j^1 \\ 1 & \dot{x} > j^1 \end{cases}$$

$$Falsity = F_L(\dot{X}) = \begin{cases} 0 & \dot{x} < a^2 \\ q \left(\frac{\dot{x} - a^2}{b^2 - a^2} \right)^{m_1} & a^2 < \dot{x} < b^2 \\ q \left(\frac{\dot{x} - b^2}{c^2 - b^2} \right)^{m_2} & b^2 < \dot{x} < c^2 \\ k & c^2 < \dot{x} < d^2 \\ w - (w \dot{-} q) \left(\frac{\dot{x} - d^2}{e^2 - d^2} \right)^{m_3} & d^2 < \dot{x} < e^2 \\ 1 & e^2 < \dot{x} < f^2 \\ w - (w \dot{-} s) \left(\frac{g^2 - \dot{x}}{g^2 - f^2} \right)^{n_1} & f^2 < \dot{x} < g^2 \\ w & g^2 < \dot{x} < h^2 \\ s \left(\frac{i^2 - \dot{x}}{i^2 - h^2} \right)^{n_2} & h^2 < \dot{x} < i^2 \\ s \left(\frac{j^2 - \dot{x}}{j^2 - i^2} \right)^{n_3} & i^2 < \dot{x} < j^2 \\ 1 & \dot{x} > j^2 \end{cases}$$

As, $0 < k < 1 \quad A_\alpha = \{ \dot{x} \in \dot{X} \mid F_L(\dot{X}), I_L(\dot{X}) \geq \alpha \}$

Accuracy function

The accuracy function is given below:

$$D^{INO_N} = \left(\frac{a + b + c + d + e + f + g + h + i + j}{10} \right)$$

$$D^{INO_N} = \left(\frac{\hat{a}^1 + \hat{b}^1 + \hat{c}^1 + \hat{d}^1 + \hat{e}^1 + \hat{f}^1 + \hat{g}^1 + \hat{h}^1 + \hat{i}^1 + \hat{j}^1}{10} \right)$$

$$D^{FNO_N} = \left(\frac{\hat{a}^2 + \hat{b}^2 + \hat{c}^2 + \hat{d}^2 + \hat{e}^2 + \hat{f}^2 + \hat{g}^2 + \hat{h}^2 + \hat{i}^2 + \hat{j}^2}{10} \right)$$

4. Case Study

We will estimate the flexibility and outcome of decagonal neutrosophic numbers. We will show the strength of the decagonal by the real-life problem. With ten edges we can handle huge problems easily. Suppose a real-life problem with maximum parameters.

Numerical problem: Here U as the universe. A student wants to study abroad. So, he decided to compare different countries. It's a big multi-criteria decision and the method to avail the solution given below:

The different countries are \hat{A} , \hat{B} , and \hat{C} . Choice parameters are \hat{C}_1 , \hat{C}_2 , and \hat{C}_3 .

\hat{A}	\hat{B}	\hat{C}
$\{\hat{C}_1(0.69,0.59,0.21,0.35,0.47,0.85,0.32,0.13,0.48,0.64)$ (0.65,0.87,0.33,0.29,0.31,0.48,0.67,0.45,0.63,0.21) (0.28,0.58,0.88,0.38,0.55,0.36,0.78,0.24,0.36,0.95))	$\{\hat{C}_1(0.21,0.31,0.41,0.51,0.61,0.71,0.76,0.52,0.36,0.46)$ (0.79,0.87,0.67,0.98,0.78,0.58,0.48,0.69,0.24,0.62) (0.98,0.95,0.94,0.93,0.90,0.92,0.99,0.88,0.78,0.58)	$\{\hat{C}_1(0.21,0.31,0.41,0.51,0.61,0.72,0.84,0.33,0.30,0.24)$ (0.25,0.41,0.67,0.75,0.85,0.47,0.67,0.41,0.31,0.49) (0.98,0.97,0.96,0.94,0.87,0.81,0.89,0.48,0.61,0.13)
$\{\hat{C}_2(0.11,0.21,0.19,0.28,0.52,0.36,0.57,0.36,0.38,0.25)$ (0.74,0.24,0.34,0.21,0.98,0.75,0.41,0.58,0.32,0.27) (0.33,0.44,0.55,0.66,0.45,0.87,0.88,0.97,0.23,0.45))	$\{\hat{C}_2(0.41,0.51,0.13,0.23,0.43,0.33,0.17,0.58,0.21,0.67)$ (0.25,0.35,0.45,0.55,0.65,0.75,0.85,0.95,0.21,0.34) (0.12,0.97,0.85,0.81,0.86,0.79,0.75,0.61,0.66,0.68)	$\{\hat{C}_2(0.31,0.27,0.47,0.59,0.92,0.50,0.47,0.38,0.14,0.27)$ (0.17,0.28,0.78,0.71,0.94,0.95,0.68,0.74,0.71,0.92) (0.21,0.94,0.92,0.97,0.93,0.82,0.81,0.87,0.24,0.93)
$\{\hat{C}_3(0.45,0.87,0.36,0.45,0.36,0.54,0.63,0.28,0.13,0.11)$ (0.51,0.29,0.27,0.19,0.23,0.47,0.18,0.72,0.23,0.22) (0.90,0.96,0.11,0.24,0.34,0.87,0.21,0.36,0.78,0.11))	$\{\hat{C}_3(0.27,0.58,0.34,0.13,0.23,0.25,0.34,0.22,0.71,0.62)$ (0.67,0.24,0.31,0.45,0.65,0.74,0.39,0.52,0.41,0.31) (0.57,0.67,0.37,0.47,0.57,0.67,0.77,0.97,0.27,0.68)	$\{\hat{C}_3(0.14,0.13,0.17,0.27,0.34,0.57,0.19,0.58,0.19,0.74)$ (0.37,0.47,0.97,0.24,0.87,0.82,0.92,0.67,0.58,0.71) (0.81,0.91,0.96,0.92,0.97,0.82,0.81,0.79,0.88,0.67)

In above matrix ($\hat{C}_1, \hat{C}_2, \hat{C}_3$) mentioned as row and countries as (\hat{A}, \hat{B} , and \hat{C}) in column.

Step 1: Defuzzification of Decagonal neutrosophic number by using accuracy function:

$$D^{\tilde{T}NO_N} = \left(\frac{\hat{a} + \hat{b} + \hat{c} + \hat{d} + \hat{e} + \hat{f} + \hat{g} + \hat{h} + \hat{i} + \hat{j}}{10} \right), D^{INO_N} = \left(\frac{\hat{a}^1 + \hat{b}^1 + \hat{c}^1 + \hat{d}^1 + \hat{e}^1 + \hat{f}^1 + \hat{g}^1 + \hat{h}^1 + \hat{i}^1 + \hat{j}^1}{10} \right), \text{ and}$$

$$D^{FNO_N} = \left(\frac{\hat{a}^2 + \hat{b}^2 + \hat{c}^2 + \hat{d}^2 + \hat{e}^2 + \hat{f}^2 + \hat{g}^2 + \hat{h}^2 + \hat{i}^2 + \hat{j}^2}{10} \right)$$

By using these formulas, Neutrosophic soft Matrix given below:

Enrollment in local colleges, 2005

Criteria	\hat{A}	\hat{B}	\hat{C}
\hat{C}_1	(0.4,0.4,0.5)	(0.4,0.6,0.8)	(0.4,0.5,0.7)
\hat{C}_2	(0.3,0.4,0.5)	(0.3,0.5,0.7)	(0.4,0.6,0.7)
\hat{C}_3	(0.4,0.3,0.4)	(0.3,0.4,0.6)	(0.3,0.6,0.8)

Step 2: For normalized aggregate fuzzy decision matrix.

$$\tilde{r}_{ij} = \left(\frac{\tilde{a}_{ij}}{\tilde{c}_{ij}}, \frac{\tilde{b}_{ij}}{\tilde{c}_{ij}}, \frac{\tilde{c}_{ij}}{\tilde{c}_{ij}} \right)$$

Criteria	\tilde{A}	\tilde{B}	\tilde{C}
\tilde{C}_1	(0.8,0.8,1.0)	(0.5,0.7,1.0)	(0.5,0.7,1.0)
\tilde{C}_1	(0.6,0.8,1.0)	(0.4,0.7,1.0)	(0.5,0.8,1.0)
\tilde{C}_3	(1.0,0.7,1.0)	(0.5,0.6,1.0)	(0.3,0.7,1.0)

For criteria weighting, aggregate decision matrix given below:

$$\tilde{W}_1 = (0.3,0.4,0.5), \tilde{W}_2 = (0.5,0.6,0.7), \text{ and } \tilde{W}_3 = (0.1,0.2,0.3)$$

Step 3: $\tilde{p}_{ij} = \tilde{r}_{ij}$ will multiply by \tilde{w}_j moreover, weighted normalized decision matrix.

Criteria	\tilde{A}	\tilde{B}	\tilde{C}
\tilde{C}_1	(0.2,0.3,0.5)	(0.1,0.2,0.5)	(0.1,0.2,0.5)
\tilde{C}_1	(0.3,0.4,0.7)	(0.2,0.4,0.7)	(0.2,0.4,0.7)
\tilde{C}_3	(0.1,0.1,0.3)	(0.5,0.1,0.3)	(0.3,0.1,0.3)

Step 4: Find $\tilde{F}NIS$ and $\tilde{F}PIS$

$$\tilde{A}^+ = (\tilde{p}_1^+, \tilde{p}_2^+, \tilde{p}_3^+, \dots, \tilde{p}_n^+)$$

$$\tilde{p}_j^+ = \max(\tilde{p}_{ij}) \quad i = 1, 2, \dots, m \text{ and } j = 1, 2, \dots, n$$

$$\tilde{A}^- = (\tilde{p}_1^-, \tilde{p}_2^-, \tilde{p}_3^-, \dots, \tilde{p}_n^-)$$

$$\tilde{p}_j^- = \max(\tilde{p}_{ij}) \quad i = 1, 2, \dots, m \text{ and } j = 1, 2, \dots, n$$

$$\tilde{A}^+ = \tilde{p}_1^+(0.5,0.5,0.5), \tilde{p}_2^+(0.7,0.7,0.7), \tilde{p}_3^+(0.3,0.3,0.3)$$

$$\tilde{A}^- = \tilde{p}_1^-(0.2,0.1,0.1), \tilde{p}_2^-(0.3,0.2,0.2), \tilde{p}_3^-(0.1,0.1,0.1)$$

$$d(\tilde{x}, \tilde{y}) = \sqrt{\frac{1}{3}(\tilde{a}_1 - \tilde{a}_2)^2 + (\tilde{b}_1 - \tilde{b}_2)^2 + (\tilde{c}_1 - \tilde{c}_2)^2}$$

Ideal positive solution

Criteria	\tilde{A}	\tilde{B}	\tilde{C}
\tilde{C}_1	(0.2)	(0.4)	(0.2)
\tilde{C}_1	(0.2)	(0.1)	(0.4)
\tilde{C}_3	(0.3)	(0.3)	(0.2)

Negative Ideal solution

Criteria	\tilde{A}	\tilde{B}	\tilde{C}
\tilde{C}_1	(0.3)	(0.3)	(0.3)
\tilde{C}_1	(0.2)	(0.5)	(0.3)
\tilde{C}_3	(0.1)	(0.1)	(0.2)

Now calculate the distance between every weighted alternative.

$$d_i^* = \sum_{j=1}^n d(v_{ij}, v_j^*), d_i^- = \sum_{j=1}^n d(v_{ij}, v_j^-)$$

$$d_1^+ = 0.7 \quad d_1^- = 0.6$$

$$d_2^+ = 0.8 \quad d_2^- = 0.9$$

$$d_3^+ = 0.8 \quad d_3^- = 0.8$$

Closeness coefficient

$$\hat{C}C_i = \frac{d_i^-}{d_i^- + d_i^+}$$

$$\hat{C}C_1 = 0.4615$$

$$\hat{C}C_2 = 0.5294$$

$$\hat{C}C_3 = 0.5000$$

Strategy	Results	Rank
$\hat{C}C_1$	(0.4615)	(3)
$\hat{C}C_2$	(0.5294)	(1)
$\hat{C}C_3$	(0.5000)	(2)

Clearly $\hat{B} > \hat{C} > \hat{A}$, The best country is \hat{B} .

5. Conclusion

In this article, we introduce decagonal neutrosophic numbers (Linear, Non-Linear, Symmetric, Asymmetric). In the environment of MCDM, decagonal neutrosophic numbers will be very effective because of their ten edges. By using decagonal neutrosophic numbers we can deal with daily-life problems more effectively. Decagonal neutrosophic numbers have ten edges to deal with more fluctuations. In order to show the reliability and the working of this tool, we introduce an application based on MCDM. We solve the problem with the TOPSIS technique of MCDM. Moreover, we present aggregate operators of decagonal neutrosophic numbers with matrix notations and operations.

References

[1]. Nguyen, HP, Kreinovich, V: Fuzzy logic and its applications in medicine. Int. J. Med. Inform. 62, 165-173 (2001).
 [2]. L. Zadeh, "Fuzzy sets", Information and Control, 8, 338- 353. 1965.
 [3]. L. Zadeh, "Fuzzy sets as a basis for a theory of possibility", Fuzzy sets and system, 1 (1), 3-28. 1978.
 [4]. Molodtsov. D, "Soft set theory-first results". Computer. Math. Appl. 37(4-5), 19-31,1999.
 [5]. Jafar. N. M, Hamza. A, Farooq. S. "A Best Technique of Weight Lose using Fuzzy Soft Systems", 'International Journal of Computer Applications (0975 – 8887)', vol 176 (16), April 2020.

- [1] F. Smarandache, Extension of Soft Set to Hypersoft Set, and then to Plithogenic Hypersoft Set, Neutrosophic sets and system. 22(2018), 168-170.
- [2] Abdel-Basset, M., Manogaran, G., Gamal, A., & Smarandache, F. (2018). A hybrid approach of neutrosophic sets and DEMATEL method for developing supplier selection criteria. *Design Automation for Embedded Systems*, 1-22.
- [3] Nabeeh, N. A., Smarandache, F., Abdel-Basset, M., El-Ghareeb, H. A., & Aboelfetouh, A. (2019). An Integrated Neutrosophic-TOPSIS Approach and Its Application to Personnel Selection: A New Trend in Brain Processing and Analysis. *IEEE Access*, 7, 29734-29744.
- [4] F. Smarandache, Neutrosophy. Neutrosophic probability, set, and logic, ProQuest Information & Learning, Ann Arbor, Michigan, USA, 1998.
- [5] Riaz. M., Saqlain. M. and Saeed. M. (2019). Application of Generalized Fuzzy TOPSIS in Decision Making for Neutrosophic Soft set to Predict the Champion of FIFA 2018: A Mathematical Analysis, *Punjab University Journal of Mathematics*, 51(8): 111-126.
- [6] I. Deli and S. Broumi, Neutrosophic Soft Matrices and NSM-decision Making, *Journal of Intelligent and Fuzzy Systems*, 28(5), (2015), 2233-2241. *Neutrosophic Sets and Systems*, Vol. 32, 2020 306
- [7] P. Biswas, S. Pramanik, and B. C. Giri. A new methodology for neutrosophic multi-attribute decision making with unknown weight information. *Neutrosophic Sets and Systems*, 3(2014), 42-52. 36. K. Mondal, and S. Pramanik. Neutrosophic decision making model of school choice. *Neutrosophic Sets and Systems*, 7 , pp.62-68, 2015.
- [8] M. G. Gafar, M Elhoseny, & M.Gunasekaran, Modeling neutrosophic variables based on particle swarm optimization and information theory measures for forest fires. *The Journal of Supercomputing*, pp.1-18, 2018.
- [9] S. Pramanik, P. P. Dey and B. C. Giri, TOPSIS for single valued neutrosophic soft expert set based multiattribute decision making problems, *Neutrosophic Sets and Systems*, 10, pp.88-95, 2015.
- [10] I. Turksen, Interval valued fuzzy sets based on normal forms, *Fuzzy Sets and Systems*, 20 pp.191–210, 1986.
- [11] Pratihar, J.; Kumar, R.; Dey, A.; Broumi, S. Transportation problem in neutrosophic environment. In *Neutrosophic Graph Theory and Algorithms*; IGI Global, pp.180-212, 2020.
- [12] F. Smarandache, Neutrosophy. Neutrosophic probability, set, and logic, ProQuest Information & Learning, Ann Arbor, Michigan, USA, 1998.
- [13] Chakraborty, A.; Mondal, S. P.; Ahmadian, A.; Senu, N.; Alam, S.; and Salahshour, S.; Different Forms of Triangular Neutrosophic Numbers, De-Neutrosophication Techniques, and their Applications, *Symmetry*, vol 10, 327, 2018.; doi:10.3390/sym10080327.
- [14] Chakraborty, A.; Mondal, S. P; Mahata, A.; Alam, S.; Different linear and non-linear form of Trapezoidal Neutrosophic Numbers, De-Neutrosophication Techniques and its Application in time cost optimization technique, sequencing problem; *RAIRO Operation Research*, vol 11, 327, 2018. doi:10.1051/ro/2019090.
- [15] Chakraborty. A., Sankar P. Mondal, Shariful A. Ali A., Norazak S., Debashis De. and Soheil S., The Pentagonal Fuzzy Number:Its Different Representations, Properties, Ranking, Defuzzification and Application in Game Problems, *Symmetry*, vol 10, pp 248, 2018.
- [16] Wang, H.B.; Smarandache, F.; Zhang, Y.Q.; Sunderraman, R. Single Valued Neutrosophic Sets. *Tech. Sci. Appl. Math.* 2010.
- [17] Ye, J. A multicriteria decision-making method using aggregation operators for simplified neutrosophic sets. *J. Int. Fuzzy Syst.*, vol 26, pp. 2459–2466, 2014.
- [18] Peng, J.J.; Wang, J.Q.; Wang, J.; Zhang, H.Y.; Chen, X.H. Simplified neutrosophic sets and their applications in multi-criteria group decision making problems. *Int. J. Syst. Sci.*, vol 47, pp. 2342–2358, 2016.
- [19] Peng, J.J.; Wang, J.Q.; Wu, X.H.; Zhang, H.Y.; Chen, X.H. The fuzzy cross-entropy for intuitionistic hesitant fuzzy sets and their applications multi-criteria decision-making. *Int. J. Syst. Sci.* vol 46, pp. 2335– 2350, 2015.

- [20] Abdel-Basset, M., Saleh, M., Gamal, A., & Smarandache, F. An approach of the TOPSIS technique for developing supplier selection with group decision making under type-2 neutrosophic number. *Applied Soft Computing*, vol77, pp. 438-452, 2019.
- [21] Riaz.M., Saeed.M. Saqlain.M. and Jafar.N,” Impact of Water Hardness in Instinctive Laundry System based on Fuzzy Logic Controller,” *Punjab University Journal of Mathematics*, vol 51(4), pp. 73-84, 2018.
- [22] Riaz. M., Saqlain. M. and Saeed. M., “Application of Generalized Fuzzy TOPSIS in Decision Making for Neutrosophic Soft set to Predict the Champion of FIFA 2018: A Mathematical Analysis,” *Punjab University Journal of Mathematics*, vol 51(8), pp.111-126, 2019.

Prioritizing Energy Blockchain Use Cases Using Type-2 Neutrosophic Number Based EDAS

Umit Cali, Muhammet Deveci, Shammya Shananda Saha, Ugur Halden, Florentin Smarandache

Umit Cali, Muhammet Deveci, Shammya Shananda Saha, Ugur Halden, Florentin Smarandache (2021). Prioritizing Energy Blockchain Use Cases Using Type-2 Neutrosophic Number Based EDAS. *IEEE Access* 4, 17; DOI: 10.1109/ACCESS.2022.3162190

ABSTRACT The modern power systems are evolving in parallel to the development of other technological trends such as decarbonization and digitalization. While the penetration of renewable energy resources is increasing within the national and regional energy mix, emerging digitalization technologies, such as artificial intelligence and blockchain technology are shaping modern power systems. Especially blockchain technology has a very high potential to disrupt the current and future energy sector landscape by enabling various use cases in this domain. This paper aims to prioritize different energy use cases where blockchain technology can actively be utilized to create additional value. This study proposes a Type-2 Neutrosophic Number (T2NN) based Evaluation based on Distance from Average Solution (EDAS) to evaluate and rank a set of existing use cases of an energy blockchain system. Testing and validation of the model is done through a comparison against one alternative T2NN based Multi-Criteria Decision Making (MCDM) model and an existing approach from literature. In addition, a sensitivity analysis is performed, revealing that changing criteria weightings do not affect the ranking order of the use cases of the energy blockchain system. Prioritizing the use cases can assist the companies, standardization bodies, and related government authorities to make better decisions for their operations, such as ranking the investment decisions.

INDEX TERMS Blockchain, Distributed Ledger Technology, Energy Use Case, Fuzzy Sets, Multi-Criteria Decision Making, Neutrosophic Numbers

I. INTRODUCTION

THE traditional power system was designed highly centralized, which in return led to unidirectional power flow. However, rapid integration of Distributed Energy Resources (DERs), Electrical Vehicles (EVs), Energy Storage Systems (ESSs), responsive loads, and demand response programs are causing a paradigm shift in the grid's behavior, leading to a Transactive Energy system [1], [2]. Transactive energy is defined as a system of economic and control mechanisms that allows the dynamic balance of supply and demand across the entire electrical infrastructure using value as a critical operational parameter [3]. As this transactive network is already designed as an interconnected matrix of devices, Blockchain is an excellent fit, operating in a matrix structure of nodes with no centralized authority. This trend is also being accelerated due to the integration of smart meters, IoT devices and other ICT technologies leading to the dereg-

ulation, decentralization, decarbonization, digitalization, and democratization of the market participants. The inclusion of Distributed Ledger Technology (DLT) in energy markets can further utilize digitalization to achieve more control and consensus across the prosumers, allowing an open market.

DLT can be considered an umbrella term for distributed databases across different locations with multiple users [4]. The first widespread application of DLT was concentrated on cryptocurrencies acting as an alternative medium of exchange. The second utilization of DLT enabled distributed data storage with online ledgers, as the name of the technology also suggests. The third and current application of DLT focuses on smart contracts for scaled and distributed computing. Even though in industry and media the terms are using interchangeably, the blockchain technology is a heavily used sub-category of DLT [5]. In blockchain, as the name suggests the information is stored in "blocks" which

connects to each other via cryptographic hash functions, hence the “chain” connection. Blockchain is a specific format of DLT with potential applications in supply chain management, telecommunications, transportation, medical, energy systems, and more [6]. For energy systems, there is a vast number of use cases for blockchain¹. With the inclusion of DLT, energy sector can further utilize the digitalization for achieving more control and consensus across the multiple participants which will lead to reduced operational, planning and infrastructure costs. Detailed review of application of blockchain and challenges lying ahead can be found in [7]–[9].

Work done in [10], [11] proposed a systematic methodology to demonstrate the value of blockchain in various power system use cases. However, there has not been any systemic study or consensus among the experts to indicate which one of these use cases has the highest priority in implementing and creating blockchain applications for energy systems. Prioritization of the possible use cases can provide various solutions to the industry, academia, and the standardization bodies. As Business-as-Usual practice, the companies planning innovative digitalization investments like integrating blockchain technology into their ongoing or new processes spend several months even years to make the most effective decisions for their investments. The decision-making process relies on various, primarily sophisticated investigations and analyses considering multiple technical, economic, sustainability, and political issues. However, some criteria and aspects can be quantifiable, making the decision-making process relatively less complicated and manageable. Furthermore, standardization bodies like IEEE Standards Association (SA) have dedicated working groups (WGs) that focus on various industrial verticals such as health, energy, and supply chain management. IEEE SA P2418.5 a WG that intends to propose an open, common, and interoperable standard reference framework for the potential use of blockchain in the energy sector. The ranking of the high potential energy blockchain use cases plays an important role for such organizations to proceed with a clean workflow based on solid consensus-based methodologies.

Ranking all the potential uses cases of blockchain for energy systems is essentially a Multi-Criteria Decision-Making (MCDM) problem as the evaluation of use cases relies on the chosen criteria. In decision-making problems, it is not easy to accurately characterize evaluation information with exact numbers. Decision-makers may have different opinions, and this may reveal uncertainty in information [12]. Type-2 Neutrosophic Numbers (T2NNs) was introduced in [13] as an efficient tool to handle vagueness, imprecision, ambiguity, and inconsistency of such MCDM problems [14]. T2NNs have been successfully implemented in various MCDM problems such as: developing supplier selection using a T2NN based TOPSIS (Technique for Order of Preference by Similarity to

¹In this work, DLT and blockchain are used interchangeably to stay inline with the trend in academia and industry.

Ideal Solution) approach [13], a public transportation pricing system selection using a two-stage hybrid MCDM model including CRITIC (CRiteria Importance Through Intercriteria Correlation) and MABAC (Multi-Attributive Border Approximation area Comparison) approach under T2NNs [15], two-stage decision model for the location selection of an Automobile Lithium-ion battery [16], and more. However, literature review shows that there has not been any research to apply advanced decision-making methods approach in energy blockchain.

A. CONTRIBUTIONS

This work proposes two T2NN based models to evaluate and rank the use cases of an energy blockchain system. This work does not propose a new energy DLT use case but explores the application of Fuzzy set theory to rank/prioritize the existing and commonly implemented use cases where DLT/blockchain is utilized in the field of energy domain. To the best of our knowledge, this work is the first in this category to merge emerging topics such as energy blockchain and advanced decision-making methods in an orchestrated manner. The proposed models use neutrosophic numbers, which can handle uncertainties such as vagueness, imprecision, and inconsistency [13]. The first proposed model is a T2NN based EDAS which is a very effective method in case of having some incompatible parameters. The second proposed model is a T2NN based hybrid model that includes WASPAS, MABAC, and CODAS. We use the distance measures in the second model to calculate the difference degree between T2NNs. Comparison of the two proposed models against a T2NN based CODAS model [16] is also completed along with sensitivity analysis of the two proposed models with respect to a threshold parameter (can be set by a decision-maker).

The paper is organized as follows. Section II details the use cases considered in the work where Section III illustrates the criteria used to evaluate the use cases for prioritizing them. Section IV provides preliminaries on fuzzy set and the proposed methodology. Section V shows the application of the proposed methodology on survey results collected from various experts on the application of blockchain on energy systems and shows the ranking based on the survey results. The results of the analysis indicate that the use case **Grid Management and Transactions** is the most suitable alternative among six alternative use cases. Note that the proposed methodology is independent of the number of collected survey results and can be extended for a different set of use cases evaluated with respect to a different set of evaluation criteria.

II. ENERGY BLOCKCHAIN USE CASES

The global energy landscape is rapidly digitalizing alongside "Industry 4.0" technologies such as artificial intelligence (AI), advanced ICT, quantum computing, and DLT as integral parts of the daily business and operations. The digital transition leverages various digital technologies and tools

to increase the efficiency of existing processes, create new revenue streams, and increase the safe and secure operation of the businesses. DLT is among the most disruptive digital technologies with the potential to impact the existing energy market and systems as an enabler. It is possible to eliminate unnecessary third parties, increase transaction and processing speeds, improve the operations' cyber-physical security, and even create new unlocked business territories by effective use of DLT. However, DLT can not be proposed as a unique solution to multiple energy-related problems but can be considered one of the most promising enablers of digital solutions besides other digital technologies. While designing a DLT-based system, one shall consider the potential limitations of existing DLTs, such as interoperability, transaction speeds, energy consumption levels, and transaction fees of the selected DLT ecosystems. If the investigated use case does not necessarily require decentralized databases like DLT, it is better not to increase the complexity of the existing system and overload the ecosystem. Figure 1 visualizes the segmentation for the following energy blockchain use cases alongside with the entire value chain of power systems and markets.

- Energy financing,
- Renewable energy certificate (REC) trading,
- Labelling and energy provenience,
- EV charging and payment settlement,
- Retail trading,
- Wholesale trading,
- Flexibility management,
- Grid management and operation
- P2P energy trading,

Each energy use case is cross-segmented under the relevant value chain section. For instance, EV charging use case can be operated between grid edge (prosumer and consumers) to power distribution system depending on the location of the EV charging station. Moreover, DLT accommodates three dimensions in terms of flow: data, financial, and power transactions, which can be beneficial for the P2P energy trading use case. In this use case scenario, electrical power flows as a physical commodity, and smart metering-based systems can be used to track-record the energy transaction feature immutably to the blocks or on-chain databases of the cryptonetwork. Besides, financial transactions can be accomplished via DLT-based cryptocurrencies or classical fiat currency as a medium, depending on the preference of the business owners.

Among variety of use cases, this work shows the proposed methodology based on the following short-listed use cases based on popularity [7]–[9]:

- A1:** P2P Energy Trading
- A2:** Sustainability Attributions and Green Energy Certification
- A3:** EV Charging and E-Mobility
- A4:** Grid Management and Transactions
- A5:** E-Metering and Payment Settlement
- A6:** Energy Finance

A. P2P ENERGY TRADING

Increasing utilization of DER, smart meters, and two-way communication technologies allows the classical customers to be more active in the electrical energy supply chain [17]. In return, this phenomenon results in the reconstruction of classical energy markets from a top-down approach to a bottom-up approach where customers can act as producers, resulting in the new term “prosumers.” Utilizing blockchain can accelerate the transition securely while removing Trusted Third Parties, thus providing faster transaction validations and more privacy to market participants. Additionally, blockchain can act as an enabler for achieving multiple Local Energy Markets (LEM) across different communities where prosumers can sell their excess energy to their communities (ideally for a cheaper price than the spot electricity prices) or towards the main grid.

Currently, transforming the existing grid network into an operational P2P energy network is the most utilized application of blockchain in the energy industry [18]. The P2P market structure can be classified into fully decentralized markets, community-based markets, and hybrid markets [19]–[21]. However, a fully functional and scaled real-world P2P energy network is unlikely to be achieved soon despite various startups and businesses because many projects are still in the virtual domain and depend on the existing grid structure. Blockchain networks enabled with communication technologies that have a bandwidth of smaller than 1000 kbit/s such as Narrow-Band IoT (NB-IoT), LoRa, Wireless Personal Area Network (WPAN) will lead to bottlenecks and low output in real-life scenarios [22]. Therefore, more technological maturity is needed before various blockchain-enabled markets can be realized in real-world applications. However, for the areas without a grid and with low population density, P2P networks can prove to be beneficial earlier than expected by connecting local homes for faster and more secure energy transactions [23].

B. SUSTAINABILITY ATTRIBUTIONS AND GREEN ENERGY CERTIFICATION

DER is expected to present unprecedented advantages compared to traditional centralized approaches such as lowered electrical transmission losses, security of supply, and advanced efficiency [24]. Individuals (either residential, industrial, or commercial) or a collective entity (aggregator, [25]) can be the source of local generation which then can act as a generator agent or can perform various ancillary services (such as load shaving) [26]. However, due to several economic, technical, social, and regulatory problems, the worldwide deployment rate of DER is still relatively low despite the advantages [27].

By the laws of physics, once power is injected into the main grid, the energy from Renewable Energy Sources (RES) and classical generation techniques are indistinguishable. Thus, there is no way for a consumer to ensure that the consumed electricity comes from RES-based DER. However, by utilizing Green Certificates (also known as Renewable

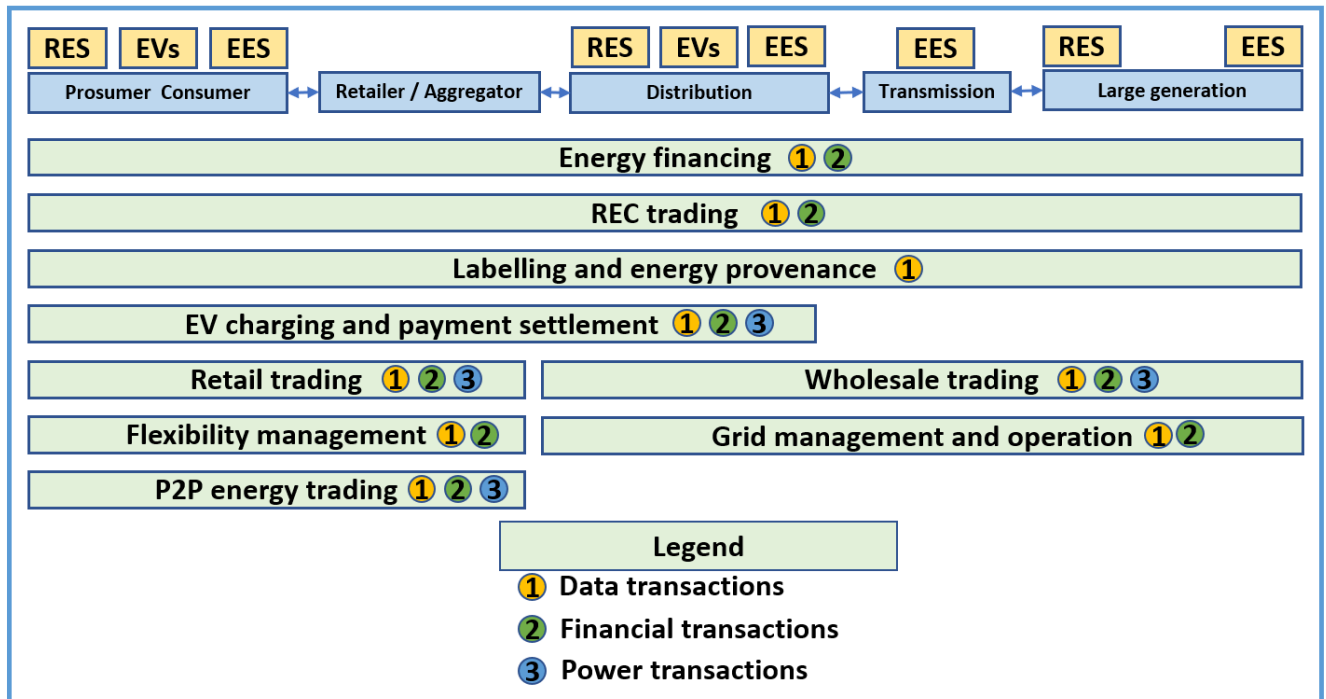

FIGURE 1: Energy blockchain segmentation analysis.

Energy Certificates or REC), the origin of energy can be logged in an immutable and distributed manner [28]. This will allow the consumers to feel a sense of support towards DER integration by ensuring that the energy being consumed is coming from RES [29], thus acting as an encouraging agent for consumers to prioritize renewable energy over conventional methods.

REC trading is a credible way to buy and sell renewable energy. The framework works by assigning a REC certificate to the energy produced and fed to the grid (usually a certificate per MWh), which can later be traded. The price per certificate depends on various parameters such as electricity supply and demand, certificate generation frequency, and scarcity. Currently, various REC trading market places exist across different regions such as China, the European Union (EU), the United States of America (USA), and India [30]–[33]. Integration of DLT can pave the development of efficient, transparent, and secure trading of REC. It is currently an active research field where various consensus mechanisms such as Proof of Generation (PoG) are being developed for efficient and scalable trading across participating agents [34].

C. EV CHARGING AND E-MOBILITY

Although the worldwide adaptation of EVs is relatively low due to the scarcity of public charging infrastructure, the utilization rate of EVs is still increasing [35] due to innovations in the development of such as autonomous vehicles and shared mobility. However, this increased utilization of EVs is posing challenges for the management of modern power

systems in the areas of; increased peak demand, voltage instabilities, higher rate of equipment degradation, cyber security, and more [36]. Therefore, securing new mobility, developing efficient data management, and handling quick complex transactions are necessary. Blockchain can act as an enabler with distributed and immutable track recording, allowing many small transactions to be performed securely and privately for small power units [37]. Blockchain can ensure a secure identity, communication through a standard messaging format, and automatic recording of charging, generation, and exchange transactions on a distributed ledger for EVs, chargers, and electricity producers. Smart contracts can allow users who have excess electricity to sell to the charging stations. In addition, EV users can leverage electronic wallets to pay the charging bills. The development of such an automatic-payment system using DLT can reduce human interaction and increase trust, transparency, and privacy among EV participants [38].

However, a real-world system should be scalable, considering that the number of EVs on the road increases due to wide-scale adaptation [39]. Thus the proposed blockchain-based systems must be able to perform a higher number of Transactions per Second (TPS) [40]. EV charging and E-mobility is an active research field in DLT; thus, many start-ups and organizations are working on real-world deployments and realization [41], [42].

D. GRID MANAGEMENT AND TRANSACTIONS

Compared to the P2P network, grid transactions are less radical in decentralization and are a research field supported by energy companies. These transactions happen in a way that keeps the power grid integrated even if its function fundamentally changes, such as wholesale energy markets where transactions can be verified quickly and efficiently while being transparent to market participants, hence increasing the efficiency [5]. Compared to the classical wholesale markets, these markets can handle smaller transactions in a quicker way which would put increased pressure on centralized systems [43]. In addition to wholesale power markets, new ancillary markets can be realized by DLT, which will allow distribution network balancing by DER without the need for expensive infrastructure upgrades [40].

Unlike “traditional” centralized generating units, DERs at the prosumer level come in small capacities and are connected to low and medium voltage electricity distribution grids. The distributed nature of these resources can enable new services through DER aggregation to create economic value by providing these services at scale [44]. By acting as intermediaries between prosumers and a deregulated energy market, aggregators can provide hedging solutions by procuring demands from consumers and selling to purchasers, thus reducing risk to individual market participants [45]. [46]. Ensuring security, transparency, and privacy in an aggregator-based market is achievable by integrating blockchain while reducing communication latency and computation time [25].

E. E-METERING AND PAYMENT SETTLEMENT

Grid operators must be aware of the electricity consumption patterns of their users for an efficient and stable electricity market [47]. Thus, information security is even more critical amid the decentralized markets with multiple smaller participants. This change leads to the need of answering who oversees the following parameters in the power market such as:

- The owner of the customer data,
- Regulation of the use and access of the customer data,
- The data security and privacy

By utilizing a smart meter, market participants can share information (energy consumption, production, voltage, current, power factor, and more) to their utility. Blockchain integrated with metering infrastructure can pave the path for an automated billing in energy services for prosumers, with the potential of administrative cost reduction. Traceability of energy produced and consumed can inform prosumers about the origins and cost of their energy supply, making energy charges more transparent, thus incentivizing behavioral change and demand response. After the data acquisition, a blockchain-based information system can provide data consistency, and security [48] against communication dropouts [49], and cyber-attacks [37] and can ensure a robust state verification [25]. Moreover, recent development has shown

the application of a proof-of-authority consensus mechanism for metering infrastructure that uses significantly less energy than computation-heavy and energy-intensive proof-of-work blockchain systems [50].

F. ENERGY FINANCE

Additional utilization of blockchain in the energy sector is the capital funding via crowdfunding for various energy-related investments such as solar PV, energy storage, and more. The main idea behind this type of energy finance is the allowance of digital partial ownership of the said investments by the investors in exchange for cryptocurrencies, Initial Coin Offerings (ICOs), Security Token Offerings (STOs) [51]–[53] and more. The currency ownership and transaction records can be kept in a distributed digital ledger across every node via various consensus mechanisms for cryptocurrencies. However, utilizing cryptocurrencies in capital funding can lead to unsuccessful financing due to their inherited market volatility. ICO can be defined as utility tokens offered in an unregulated environment, mainly to circumnavigate the required regulatory government bodies, making them more prone to market volatility and fraud. Unlike ICOs, STOs can be launched only after passing the required controls from various government regulatory bodies. Therefore, STOs anchored to a fiat currency are more protected from market speculations and frauds. Also, there are prior works [54] developing decentralized digital currency that is generated by injecting energy into the grid and offers numerous advantages over fiat currency.

Thus, blockchain based crowdfunding has the benefit of allowing multiple smaller investors to participate in a clean energy related investment for easier capital raising and provide a feeling of support towards RES and increase their utilization factor [55] with the added benefit of lowering LCOE values of various energy investments such as PV panels and wind turbines and allowing additional countries to achieve grid parity [51].

III. EVALUATION CRITERIA OF ENERGY BLOCKCHAIN USE CASES

This section describes the set of criteria used to evaluate the blockchain energy use cases described in Section II.

C₁-Technological Maturity: Technological maturity is an essential convention in research and development, emerging technology-centered strategic planning, and the decision-making process related to digital infrastructure investments. Technology maturity stages are used to indicate and address a given technology’s position on the evolutionary curve.

C₂-Interoperability Interoperability in blockchain for energy applications refers to various cyber-physical components’ interconnection and interaction within a multi-dimensional and multi-layer ecosystem, which satisfies the safe and robust operation of the proposed system and sub-systems.

C₃-Scalability: For energy blockchain use cases, the scalability aspects refer to multiple dimensions such as an upper

limit on the number of stakeholders of the energy market or systems landscape like power generators, utilities, power traders, prosumers and in some business models, aggregators that can actively participate in the blockchain network. Therefore, for an energy blockchain network, an essential evaluation criterion is to ensure that a vast number of customers can participate in the blockchain-enabled energy market at the same time.

C₄-Transaction Speed: Transaction speed for energy blockchain use case refers to how fast the power market and systems related operations and transactions can be performed with respect to transaction numbers [25]. For a day-ahead market for instance, the effect of transaction speed is less compared to an hourly market or a 15-min market. Hence, any blockchain solution needs to be evaluated with respect to the maximum parallel transactions per second it can allow at any given time without overloading the network.

C₅-Cybersecurity: Cybersecurity aspects investigate risks associated with the cross-sectional fields between cybersecurity, Blockchain DLT and energy use cases. Cryptographic and performance aspects including the management of key generation, storage, transmission, update, escrow, revocation and distribution as well as various corresponding metrics, the various scalability and permission related fields such as the identifying the thresholds for Blockchain DLT scalability and functionality of permission mechanisms and their impacts can be considered as important elements of cybersecurity analysis. Furthermore, evaluation of the Smart Contracts in terms of cybersecurity and attack surface aspects of Blockchain DLT use cases in the field of Energy are other perspectives to be improved.

C₆-Economic Viability (OPEX and CAPEX): Like any other investment, it is essential to check the economic viability of a digitalization investment project that uses some form of DLT. Capital Expenditures (CAPEX) of such investments may include project management, system design, and development of both the hardware and the software component. Meanwhile, the Operational Expenditures (OPEX) are the cost components associated with the operation and maintenance of the established system. For energy blockchain, OPEX can also include the associated transaction fees.

C₇-Economic Value Creation: This criterion is related to the degree of value created by using DLT for a specific use case by eliminating the third parties, accelerating the processes, increasing the efficiencies, reducing the costs, and/or increasing the benefits.

C₈-Energy Consumption: A growing concern of adopting blockchain for various solutions is its high energy requirement [56]. A permissioned DLT framework (for instance, Hyperledger Fabric) allows consensus protocols that are far less energy-intensive than the consensus protocols (for example, proof-of-work) employed by a permissionless DLT architecture [25], [57]. While both types of architectures have a possible application in energy blockchain, it is crucial to evaluate the use cases with respect to their corresponding effect on overall energy consumption.

C₉-Contribution to UN SDG: This work also proposes to evaluate the use cases with respect to some of the goals of the 17 Sustainable Development Goals (SDGs) [58]. For example, the adoption of blockchain for energy can lead to innovating new technologies towards industry practice (goal number 9), resulting in affordable and clean energy (goal number 7) and paving the way to develop sustainable cities and communities (goal number 11).

C₁₀-Legal and Legislative Interoperability: Legal and legislative aspects are regulating the rules of the game. The policy-makers are responsible to regulate any official market in a country. Legal documents and laws are used to declare the specific sets of the rules. Various legal and legislative shall successfully interoperated between each other and various regions where different set of legislative documents are valid.

C₁₁-Political Support: Support of the policy makers and the dynamics behind them such as public acceptance are among important criteria which have potential to influence the investment decisions.

IV. APPLICATION OF FUZZY SET FOR RANKING BLOCKCHAIN ENERGY USE CASES

A. PRELIMINARIES ON FUZZY SETS

Fuzzy set theory was introduced in [59] to deal with the uncertainties in the information. Later, work done in [60] extended the theory of intuitionistic fuzzy set, as a generalisation of fuzzy sets, which characterize with membership and non-membership degrees. The concept of neutrosophic sets was introduced as an extension of fuzzy sets in [61]. Various types of fuzzy sets and their membership functions are depicted in Figure 2. Membership functions were first introduced in [59]. Membership functions can be characterize the fuzziness; in other words, a membership function represents the degree of truth.

1) Type-1 Neutrosophic set

A neutrosophic set can be represented by three membership functions including truth membership function T , an indeterminacy membership function I , and a falsity membership function F [13].

Definition 1. Let \check{X} be a fixed set. A neutrosophic set Q in \check{X} denoted by \check{x} [62].

$$\check{Q} = \{ \langle \check{x} : \omega_{\check{Q}}(\check{x}), \phi_{\check{Q}}(\check{x}), \pi_{\check{Q}}(\check{x}) \rangle | \check{x} \in \check{X} \}, \quad (1)$$

where $\omega, \phi, \pi : \check{X} \rightarrow]^{-}0, 1^{+}[$ represent the degree of truth membership (T), the degree of indeterminacy I , and the degree of falsity membership (F) of the element $\check{x} \in \check{X}$ to the set \check{Q} , respectively. There is no restriction on the sum of $\omega_{\check{Q}}(\check{x})$, $\phi_{\check{Q}}(\check{x})$, and $\pi_{\check{Q}}(\check{x})$ [63]. Therefore, the sum of all three membership values changes $0^{-} \leq \omega_{\check{Q}}(\check{x}) + \phi_{\check{Q}}(\check{x}) + \pi_{\check{Q}}(\check{x}) \leq 3^{+}$.

2) Type-2 Neutrosophic Set

Some fundamental definitions of T2NN are as follows:

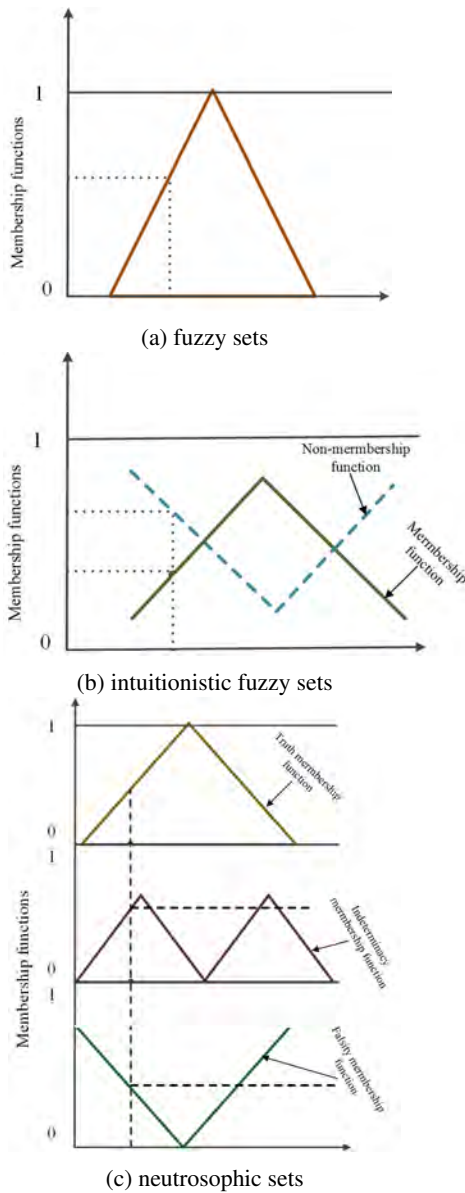

FIGURE 2: Various types of fuzzy sets and their membership functions.

Definition 2. A type-2 neutrosophic number \check{Q} are characterized by a truth $\omega_{\check{Q}}$, indeterminacy $\phi_{\check{Q}}$, and falsity $\pi_{\check{Q}}$ membership functions [64]. A T2NN set \check{Q} in \check{X} is defined by [13]:

$$\check{Q} = \left\{ \left\langle \check{x}, \omega_{\check{Q}}(\check{x}), \phi_{\check{Q}}(\check{x}), \pi_{\check{Q}}(\check{x}) \right\rangle \mid \check{x} \in \check{X} \right\}, \quad (2)$$

where $\omega_{\check{Q}}(\check{x}), \phi_{\check{Q}}(\check{x}), \pi_{\check{Q}}(\check{x}) : \check{X} \rightarrow [0, 1]^3$. The elements of the T2NN set can be defined as follows:

$$\begin{aligned} \omega_{\check{Q}}(\check{x}) &= (\omega_{\omega_{\check{Q}}}(\check{x}), \omega_{\phi_{\check{Q}}}(\check{x}), \omega_{\pi_{\check{Q}}}(\check{x})) \\ \phi_{\check{Q}}(\check{x}) &= (\phi_{\omega_{\check{Q}}}(\check{x}), \phi_{\phi_{\check{Q}}}(\check{x}), \phi_{\pi_{\check{Q}}}(\check{x})) \\ \pi_{\check{Q}}(\check{x}) &= (\pi_{\omega_{\check{Q}}}(\check{x}), \pi_{\phi_{\check{Q}}}(\check{x}), \pi_{\pi_{\check{Q}}}(\check{x})) \end{aligned}$$

Another way of representing a T2NN set is:

$$\begin{aligned} A &= \left((\omega_{\omega}, \omega_{\phi}, \omega_{\pi}), (\phi_{\omega}, \phi_{\phi}, \phi_{\pi}), (\pi_{\omega}, \pi_{\phi}, \pi_{\pi}) \mid \check{x} \in \check{X} \right) \\ \omega_{\check{Q}}(\check{x}) &= (\omega_{\check{Q}}^1(\check{x}), \omega_{\check{Q}}^2(\check{x}), \omega_{\check{Q}}^3(\check{x})) \\ \phi_{\check{Q}}(\check{x}) &= (\phi_{\check{Q}}^1(\check{x}), \phi_{\check{Q}}^2(\check{x}), \phi_{\check{Q}}^3(\check{x})) \\ \pi_{\check{Q}}(\check{x}) &= (\pi_{\check{Q}}^1(\check{x}), \pi_{\check{Q}}^2(\check{x}), \pi_{\check{Q}}^3(\check{x})) \end{aligned}$$

where $\omega_{\check{Q}}(\check{x}), \phi_{\check{Q}}(\check{x})$ and $\pi_{\check{Q}}(\check{x})$ are $\check{X} \rightarrow [0, 1]^3$. For every $\check{x} \in \check{X} : 0 \leq \omega_{\check{Q}}^1(\check{x}) + \phi_{\check{Q}}^1(\check{x}) + \pi_{\check{Q}}^1(\check{x}) \leq 3, 0 \leq \omega_{\check{Q}}^2(\check{x}) + \phi_{\check{Q}}^2(\check{x}) + \pi_{\check{Q}}^2(\check{x}) \leq 3,$ and $0 \leq \omega_{\check{Q}}^3(\check{x}) + \phi_{\check{Q}}^3(\check{x}) + \pi_{\check{Q}}^3(\check{x}) \leq 3$ are stated.

Let two T2NNs \check{Q}_1 and \check{Q}_2 be defined as the following:

$$\begin{aligned} \check{Q}_1 &= \left\langle \left((\omega_{\omega_{\check{Q}_1}}(\check{x}), \omega_{\phi_{\check{Q}_1}}(\check{x}), \omega_{\pi_{\check{Q}_1}}(\check{x})), \right. \right. \\ &\quad \left. \left(\phi_{\omega_{\check{Q}_1}}(\check{x}), \phi_{\phi_{\check{Q}_1}}(\check{x}), \phi_{\pi_{\check{Q}_1}}(\check{x}) \right), \right. \\ &\quad \left. \left(\pi_{\omega_{\check{Q}_1}}(\check{x}), \pi_{\phi_{\check{Q}_1}}(\check{x}), \pi_{\pi_{\check{Q}_1}}(\check{x}) \right) \right\rangle, \end{aligned}$$

$$\begin{aligned} \check{Q}_2 &= \left\langle \left((\omega_{\omega_{\check{Q}_2}}(\check{x}), \omega_{\phi_{\check{Q}_2}}(\check{x}), \omega_{\pi_{\check{Q}_2}}(\check{x})), \right. \right. \\ &\quad \left. \left(\phi_{\omega_{\check{Q}_2}}(\check{x}), \phi_{\phi_{\check{Q}_2}}(\check{x}), \phi_{\pi_{\check{Q}_2}}(\check{x}) \right), \right. \\ &\quad \left. \left(\pi_{\omega_{\check{Q}_2}}(\check{x}), \pi_{\phi_{\check{Q}_2}}(\check{x}), \pi_{\pi_{\check{Q}_2}}(\check{x}) \right) \right\rangle \end{aligned}$$

Definition 3. The addition of two T2NNs is given by [13], [15], [65]:

$$\begin{aligned} \check{Q}_1 \oplus \check{Q}_2 &= \left\langle \left((\omega_{\omega_{\check{Q}_1}}(\check{x}) + \omega_{\omega_{\check{Q}_2}}(\check{x}) - \omega_{\omega_{\check{Q}_1}}(\check{x}) \cdot \omega_{\omega_{\check{Q}_2}}(\check{x}), \right. \right. \\ &\quad \omega_{\phi_{\check{Q}_1}}(\check{x}) + \omega_{\phi_{\check{Q}_2}}(\check{x}) - \omega_{\phi_{\check{Q}_1}}(\check{x}) \cdot \omega_{\phi_{\check{Q}_2}}(\check{x}), \\ &\quad \omega_{\pi_{\check{Q}_1}}(\check{x}) + \omega_{\pi_{\check{Q}_2}}(\check{x}) - \omega_{\pi_{\check{Q}_1}}(\check{x}) \cdot \omega_{\pi_{\check{Q}_2}}(\check{x})), \\ &\quad \left(\phi_{\omega_{\check{Q}_1}}(\check{x}) \cdot \phi_{\omega_{\check{Q}_2}}(\check{x}), \phi_{\phi_{\check{Q}_1}}(\check{x}) \cdot \phi_{\phi_{\check{Q}_2}}(\check{x}), \right. \\ &\quad \left. \phi_{\pi_{\check{Q}_1}}(\check{x}) \cdot \phi_{\pi_{\check{Q}_2}}(\check{x}) \right), \left(\pi_{\omega_{\check{Q}_1}}(\check{x}) \cdot \pi_{\omega_{\check{Q}_2}}(\check{x}), \right. \\ &\quad \left. \pi_{\phi_{\check{Q}_1}}(\check{x}) \cdot \pi_{\phi_{\check{Q}_2}}(\check{x}), \pi_{\pi_{\check{Q}_1}}(\check{x}) \cdot \pi_{\pi_{\check{Q}_2}}(\check{x}) \right) \right\rangle. \end{aligned} \quad (3)$$

Definition 4. The multiplication of two T2NNs is given by [13], [15], [65]:

$$\begin{aligned} \check{Q}_1 \otimes \check{Q}_2 &= \left\langle \left((\omega_{\omega_{\check{Q}_1}}(\check{x}) \cdot \omega_{\omega_{\check{Q}_2}}(\check{x}), \omega_{\phi_{\check{Q}_1}}(\check{x}) \cdot \omega_{\phi_{\check{Q}_2}}(\check{x}), \right. \right. \\ &\quad \omega_{\pi_{\check{Q}_1}}(\check{x}) \cdot \omega_{\pi_{\check{Q}_2}}(\check{x})), (\phi_{\omega_{\check{Q}_1}}(\check{x}) + \phi_{\omega_{\check{Q}_2}}(\check{x}) - \phi_{\omega_{\check{Q}_1}}(\check{x}) \cdot \\ &\quad \phi_{\omega_{\check{Q}_2}}(\check{x})), (\phi_{\phi_{\check{Q}_1}}(\check{x}) + \phi_{\phi_{\check{Q}_2}}(\check{x}) - \phi_{\phi_{\check{Q}_1}}(\check{x}) \cdot \phi_{\phi_{\check{Q}_2}}(\check{x})), \\ &\quad \left. (\phi_{\pi_{\check{Q}_1}}(\check{x}) + \phi_{\pi_{\check{Q}_2}}(\check{x}) - \phi_{\pi_{\check{Q}_1}}(\check{x}) \cdot \phi_{\pi_{\check{Q}_2}}(\check{x})) \right), \\ &\quad \left((\pi_{\omega_{\check{Q}_1}}(\check{x}) + \pi_{\omega_{\check{Q}_2}}(\check{x}) - \pi_{\omega_{\check{Q}_1}}(\check{x}) \cdot \pi_{\omega_{\check{Q}_2}}(\check{x})), \right. \\ &\quad \left. (\pi_{\phi_{\check{Q}_1}}(\check{x}) + \pi_{\phi_{\check{Q}_2}}(\check{x}) - \pi_{\phi_{\check{Q}_1}}(\check{x}) \cdot \pi_{\phi_{\check{Q}_2}}(\check{x})), \right. \\ &\quad \left. (\pi_{\pi_{\check{Q}_1}}(\check{x}) + \pi_{\pi_{\check{Q}_2}}(\check{x}) - \pi_{\pi_{\check{Q}_1}}(\check{x}) \cdot \pi_{\pi_{\check{Q}_2}}(\check{x})) \right) \right\rangle. \end{aligned} \quad (4)$$

Definition 5. The arithmetic operation for a T2NN can be expressed by [13], [15], [65]:

$$\check{Q} = \left\langle \left(1 - (1 - \omega_{\omega_{\check{Q}}}(\check{x}))^\alpha, \right. \right. \\ \left. \left. 1 - (1 - \omega_{\phi_{\check{Q}}}(\check{x}))^\alpha, 1 - (1 - \omega_{\pi_{\check{Q}}}(\check{x}))^\alpha \right), \right. \\ \left. \left((\phi_{\omega_{\check{Q}}}(\check{x}))^\alpha, (\phi_{\phi_{\check{Q}}}(\check{x}))^\alpha, (\phi_{\pi_{\check{Q}}}(\check{x}))^\alpha \right), \right. \\ \left. \left((\pi_{\omega_{\check{Q}_1}}(\check{x}))^\alpha, (\pi_{\phi_{\check{Q}}}(\check{x}))^\alpha, (\pi_{\pi_{\check{Q}}}(\check{x}))^\alpha \right) \right\rangle, \quad (5)$$

where $\alpha > 0$.

Definition 6. The exponent of a T2NN is given by [13], [15], [65]:

$$\check{Q}^\alpha = \left\langle \left((\omega_{\omega_{\check{Q}}}(\check{x}))^\alpha, (\omega_{\phi_{\check{Q}}}(\check{x}))^\alpha, (\omega_{\pi_{\check{Q}}}(\check{x}))^\alpha \right), \right. \\ \left(1 - (1 - \phi_{\omega_{\check{Q}}}(\check{x}))^\alpha, 1 - (1 - \phi_{\phi_{\check{Q}}}(\check{x}))^\alpha, 1 - (1 - \phi_{\pi_{\check{Q}}}(\check{x}))^\alpha \right), \\ \left(1 - (1 - \pi_{\omega_{\check{Q}}}(\check{x}))^\alpha, 1 - (1 - \pi_{\phi_{\check{Q}}}(\check{x}))^\alpha, 1 - (1 - \pi_{\pi_{\check{Q}}}(\check{x}))^\alpha \right) \right\rangle \text{T2NNs:} \quad (6)$$

where, $\alpha > 0$.

The convergent classification values of each alternative are arranged with the help of score and accuracy values in order to identify the superior alternative [13].

Definition 7. The score function $S(\check{Q}_1)$ of T2NN \check{Q}_1 is defined as follows [13]:

$$S(\check{Q}_1) = \frac{1}{12} \left\langle 8 + (\omega_{\omega_{\check{Q}_1}}(\check{x}) + 2\omega_{\phi_{\check{Q}_1}}(\check{x}) + \omega_{\pi_{\check{Q}_1}}(\check{x})) \right. \\ \left. - (\phi_{\omega_{\check{Q}_1}}(\check{x}) + 2\phi_{\phi_{\check{Q}_1}}(\check{x}) + \phi_{\pi_{\check{Q}_1}}(\check{x})) \right. \\ \left. - (\pi_{\omega_{\check{Q}_1}}(\check{x}) + 2\pi_{\phi_{\check{Q}_1}}(\check{x}) + \pi_{\pi_{\check{Q}_1}}(\check{x})) \right\rangle \quad (7)$$

It can be said that the larger the score value, the more appropriately the corresponding alternative meets the expectation of the decision maker [66].

Definition 8. If the score values of two q-ROFs are equal, then the accuracy values are checked. The accuracy function $A(\check{Q}_1)$ of T2NN \check{Q}_1 is defined as follows [13]:

$$A(\check{Q}_1) = \frac{1}{4} \left\langle (\omega_{\omega_{\check{Q}_1}}(\check{x}) + 2(\omega_{\phi_{\check{Q}_1}}(\check{x})) + \omega_{\pi_{\check{Q}_1}}(\check{x})) - \right. \\ \left. (\pi_{\omega_{\check{Q}_1}}(\check{x}) + 2(\pi_{\phi_{\check{Q}_1}}(\check{x})) + \pi_{\pi_{\check{Q}_1}}(\check{x})) \right\rangle \quad (8)$$

Definition 9. The relations between $S(\check{Q}_i)$ and $A(\check{Q}_i)$ can be defined as follows [13]:

- 1) If $S(\check{Q}_1) > S(\check{Q}_2)$, then \check{Q}_1 is bigger than \check{Q}_2 , denoted $\check{Q}_1 > \check{Q}_2$
- 2) If $S(\check{Q}_1) = S(\check{Q}_2)$, then their accuracy values are compared as follows:
 - a) $A(\check{Q}_1) > A(\check{Q}_2)$, then $\check{Q}_1 > \check{Q}_2$,
 - b) $A(\check{Q}_1) = A(\check{Q}_2)$, then $\check{Q}_1 = \check{Q}_2$.

For example, consider two T2NNs in the group of real numbers:

$$\check{Q}_1 = (0.7, 0.8, 0.9), (0.25, 0.2, 0.35), (0.1, 0.15, 0.05) \\ \check{Q}_2 = (0.4, 0.35, 0.5), (0.3, 0.4, 0.25), (0.2, 0.3, 0.35)$$

Following Eqs. (7) and (8), score and accuracy values can be calculated as follows:

- 1) Score value of \check{Q}_1 , $S(\check{Q}_1) = (8 + (3.2 - 1.0 - 0.45))/12 = 0.81$, and of \check{Q}_2 , $S(\check{Q}_2) = (8 + (1.6 - 1.35 - 1.15))/12 = 0.59$;
- 2) Accuracy value of \check{Q}_1 , $A(\check{Q}_1) = (83.2 - 0.45)/4 = 0.69$, and of \check{Q}_2 , $A(\check{Q}_2) = (1.6 - 1.15)/4 = 0.11$.

It can be clearly seen that $\check{Q}_1 > \check{Q}_2$.

Definition 10. Distance methods basically calculate crisp distance values between two fuzzy numbers. However, a logical problem arises when the distance is calculated in an uncertain frame due to the presence of uncertainty. Therefore, a measure of distance is used for uncertain numbers [67] and can be defined as follow considering the followings two T2NNs:

$$\check{Q}_1 = ((\omega_1, \omega_2, \omega_3), (\phi_1, \phi_2, \phi_3), (\pi_1, \pi_2, \pi_3)) \\ \check{Q}_2 = ((T_1, T_2, T_3), (I_1, I_2, I_3), (F_1, F_2, F_3))$$

The distance measure $F(\check{Q}_1, \check{Q}_2)$ between them is defined as follows [68]:

$$F(\check{Q}_1, \check{Q}_2) = 1 - \frac{\sum_{i=1}^3 (\omega_i T_i + \phi_i I_i + \pi_i F_i)}{\left(\sum_{i=1}^3 [\omega_i^2 + \phi_i^2 + \pi_i^2] \right) \times \left(\sum_{i=1}^3 [T_i^2 + I_i^2 + F_i^2] \right)} \quad (9)$$

B. PROPOSED METHODOLOGIES

In this section, two different models using T2NN have been proposed to rank the use cases and then select the best DLT use case using reviews from experts. The flowchart of proposed models is shown in Figure 3.

1) Model-I: T2NN Based EDAS

Model-I is structured based on EDAS approach introduced in [69] under T2NN. The steps of the proposed model are as follows:

Step 1: Construct the fuzzy decision matrix $\tilde{X} = (x_{ij})_{m \times n}$. x_{ij} is the evaluation value of the alternative a_i ($i = 1, 2, \dots, m$) according to the criteria s_j ($j = 1, 2, \dots, n$),

$$\tilde{X} = (x_{ij})_{m \times n} = \begin{matrix} & A_1 & A_2 & \cdots & A_m \\ \begin{matrix} P_1 \\ P_2 \\ \vdots \\ P_n \end{matrix} & \begin{pmatrix} x_{11} & x_{12} & \cdots & x_{1n} \\ x_{21} & x_{22} & \cdots & x_{2n} \\ \vdots & \vdots & \ddots & \vdots \\ x_{1m} & x_{2m} & \cdots & x_{mn} \end{pmatrix} \end{matrix} \quad (10)$$

where m indicates the number of alternatives and n indicates the number of criteria.

Step 2: Calculate the score values of alternatives in terms of each criterion using decision matrix with the help of score function $S(\check{Q}_1)$ in given in Eq. (7).

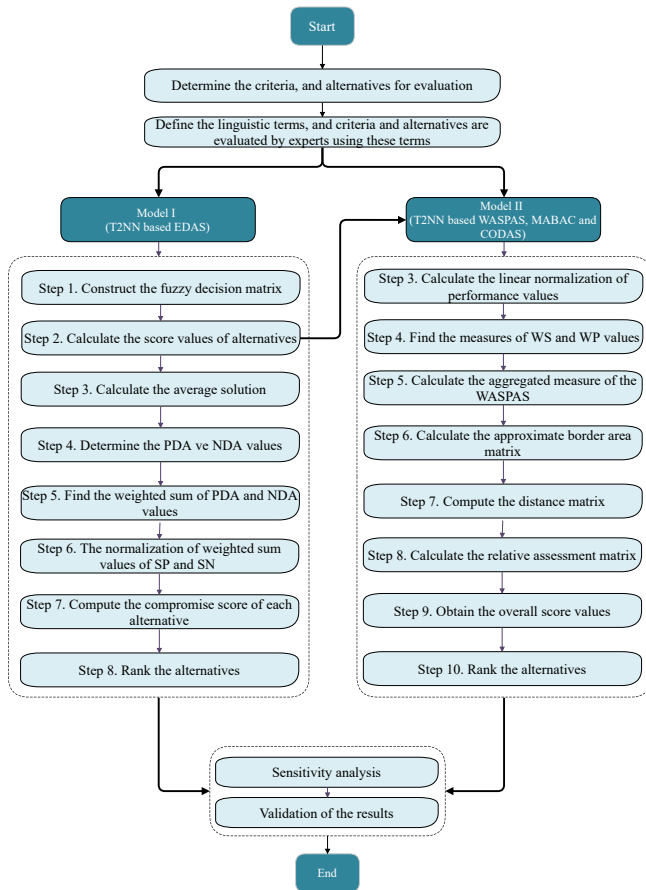

FIGURE 3: T2NN based proposed models.

Step 3: Calculate the average solution $AV = [AV_j]_{1 \times m}$ considering all criteria. Average solution of each criterion is found using (11).

$$AV_j = \frac{\sum_i^n x_{ij}}{n} \tag{11}$$

Step 4: Two important measures of the EDAS, the positive distance from average (PDA) and the negative distance from average (NDA) matrix are structured based on the type of criteria (benefit and cost).

If j^{th} criterion belongs to benefit group, then PDA and NDA values are calculated using Eqs. ((12)-(13):

$$PDA_{ij} = \frac{\max(0, x_{ij} - AV_j)}{AV_j} \tag{12}$$

$$NDA_{ij} = \frac{\max(0, AV_j - x_{ij})}{AV_j} \tag{13}$$

If j^{th} criterion belongs to cost group, then PDA and NDA values are calculated using Eqs. (14)-(15):

$$PDA_{ij} = \frac{\max(0, AV_j - x_{ij})}{AV_j} \tag{14}$$

$$NDA_{ij} = \frac{\max(0, x_{ij} - AV_j)}{AV_j} \tag{15}$$

where PDA_{ij} and NDA_{ij} represent the positive and negative distance of i^{th} alternative from average solution with respect to j^{th} criterion, respectively.

Step 5: Weighted sum of PDA and NDA values are found using Eqs. (16)-(17) with the help of weight coefficient of each criteria (w_j):

$$SP_i = \sum_j^m w_j PDA_{ij} \tag{16}$$

$$SN_i = \sum_j^m w_j NDA_{ij} \tag{17}$$

Step 6: The normalization of weighted sum values of SP and SN are calculated using Eqs. (18) and (19), respectively.

$$NSP_i = \frac{SP_i}{\max_i(SP_i)} \tag{18}$$

$$NSN_i = 1 - \frac{SN_i}{\max_i(SN_i)} \tag{19}$$

Step 7: Compromise score of each alternative is found by (20).

$$AS_i = \frac{1}{2}(NSP_i + NSN_i) \tag{20}$$

Step 8: Alternatives are ranked by the descending order of values of their AS , i.e., the alternative with the highest value of the compromise score is the highest ranked alternative.

2) Model-II: T2NN Based Model Including WASPAS, MABAC, and CODAS

This proposed model is designed as an integrated model including WASPAS [70], MABAC [71], and CODAS [72] based on T2NN. The proposed model can be described in the following steps.

Steps 1-2: Same as the first two steps of Model-I.

Step 3: Linear normalization of performance values are obtained as follows [70]:

$$\tilde{r}_{ij} = \begin{cases} x_{ij}/\max_i x_{ij} & \forall i \text{ if } j \in B \\ \min_i x_{ij}/x_{ij} & \forall i \text{ if } j \in C \end{cases} \tag{21}$$

where B and C denote sets of benefit and cost criteria, respectively. Alternatives and criteria are defined by $i = 1, 2, \dots, m$ and $j = 1, 2, \dots, n$, respectively.

Step 4: The measures of weighted sum (WS) (Δ_i^1) and weighted product (WP) (Δ_i^2) for each alternative are defined as follows [70]:

$$\Delta_{ij}^1 = \sum_{j=1}^m w_j \tilde{r}_{ij} \quad \forall i \tag{22}$$

$$\Delta_{ij}^2 = \prod_{j=1}^m (\tilde{r}_{ij})^{w_j} \quad \forall i \tag{23}$$

Step 5: The aggregated measure of the WASPAS method are calculated as follows [70]:

$$\Delta_{ij} = \mu \Delta_{ij}^1 + (1 - \mu) \Delta_{ij}^2 \quad \forall i \tag{24}$$

where μ is defined as the parameter of the WASPAS method and this parameter is the set of numbers between 0 and 1. If μ is 1, WASPAS method is transformed into WS, whereas $\mu = 0$ leads to WP.

Step 6: Calculate the approximate border area matrix H . Border Approximate Area (BAA) for each criterion is obtained as follows [71]:

$$h_j = \left(\prod_{i=1}^m \Delta_{ij} \right)^{1/m} \quad (25)$$

where h_j and m represent the border approximation area for criterion C_j and the total number of alternatives, respectively. The border approximation area vector H can be also expressed in another form ($1 \times n$) as in the following:

$$H = \begin{pmatrix} P_1 & P_2 & \dots & P_m \\ h_1 & h_2 & \dots & h_n \end{pmatrix}$$

Step 7: Calculate distance matrix $\rho = (d_{ij})_{m \times n}$. The distances of alternative from the border approximation area are calculated as follows [71]:

$$\rho^1 = \Delta - H \Rightarrow \begin{bmatrix} \Delta_{11} - h_1 & \Delta_{12} - h_2 & \dots & \Delta_{1n} - h_n \\ \Delta_{21} - h_1 & \Delta_{22} - h_2 & \dots & \Delta_{2n} - h_n \\ \vdots & \vdots & \ddots & \vdots \\ \Delta_{m1} - h_1 & \Delta_{m2} - h_2 & \dots & \Delta_{mn} - h_n \end{bmatrix} \quad (26)$$

Calculate the ideal distance as follows:

$$F = [f_j]_{1 \times m} \quad \text{and} \quad f_j = \min \{ \Delta_{ij} \}, \quad (27)$$

where f_j represents the distance.

$$\rho^2 = \Delta - F \Rightarrow \begin{bmatrix} \Delta_{11} - f_1 & \Delta_{12} - f_2 & \dots & \Delta_{1n} - f_n \\ \Delta_{21} - f_1 & \Delta_{22} - f_2 & \dots & \Delta_{2n} - f_n \\ \vdots & \vdots & \ddots & \vdots \\ \Delta_{m1} - f_1 & \Delta_{m2} - f_2 & \dots & \Delta_{mn} - f_n \end{bmatrix} \quad (28)$$

The alternative Z_i may belong to the upper approximate area (H^+) and (F^+), lower approximate area (H^-) and (F^-) or border approximation area, respectively $\forall i \in \{H \vee H^+ \vee H^-\}$ and $\{F \vee F^+ \vee F^-\}$ as shown in Figure 4. H^+ and F^+ are an area in which the ideal alternative is found (Z^+), while the H^- and F^- are an area in which the anti-ideal alternative (Z^-).

Belonging of the alternative (Z_i) to the approximate area (H^+, H or H^-) and (F^+, F or F^-) are calculated by:

$$Z_i \in \begin{cases} H^+ & \text{if } d_{ij} > 0 \\ H & \text{if } d_{ij} = 0 \\ H^- & \text{if } d_{ij} < 0 \end{cases} \quad \text{and} \quad Z_i \in \begin{cases} F^+ & \text{if } d_{ij} > 0 \\ F & \text{if } d_{ij} = 0 \\ F^- & \text{if } d_{ij} < 0 \end{cases} \quad (29)$$

Step 8: Calculate the relative assessment matrix (ϑ) as follows [72]:

$$\vartheta = [v_{il}]_{m \times m} \quad \text{where, } v_{il} = (\rho_i^1 - \rho_l^1) + (\Psi(\rho_i^1 - \rho_l^1) \times (\rho_i^2 - \rho_l^2)) \quad (30)$$

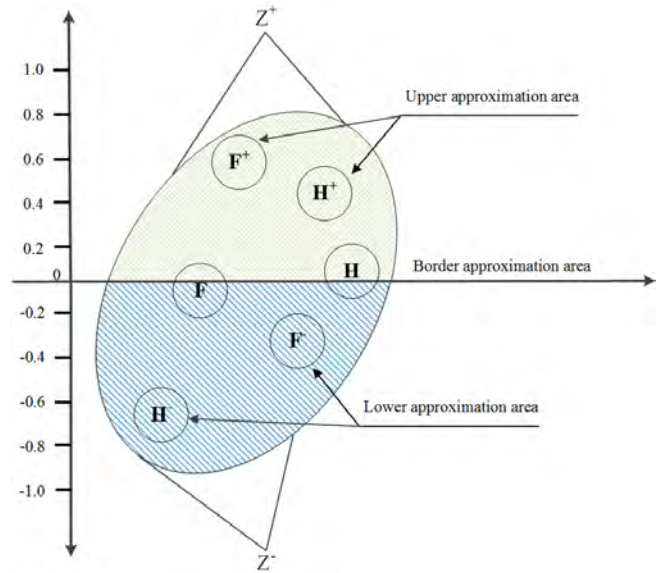

FIGURE 4: The upper (H^+) and (F^+), lower (H^-) and (F^-), and border (H) and (F) approximation areas.

Here $l \in \{i = 1, 2, \dots, m\}$ and Ψ is a threshold function that can be defined as follows:

$$\Psi(x) = \begin{cases} 1 & \text{if } |x| \geq \psi \\ 0 & \text{if } |x| < \psi \end{cases} \quad (31)$$

ψ denotes the threshold parameter of Ψ function which can be set by decision makers.

Step 9: Obtain the overall score (λ_i) for each alternative as follow:

$$\lambda_i = \sum_{l=1}^m v_{il} \quad (32)$$

Step 10: The alternative are ranked according to the descending ordering of the overall score values, i.e., the alternative with highest λ is the highest ranked alternative.

V. EXPERIMENTAL RESULTS

In this section, we present the results of applying the two proposed models on survey results collected from experts. Firstly, each criterion is evaluated by four experts using the linguistic terms presented in Table 1. The expert evaluations for each criterion are presented in Table 13 in Appendix A. Secondly, the experts provide their opinions (reported in Table 14 in Appendix A) about the ratings of six energy blockchain use case alternatives (refer to Section II) with respect to eleven criteria using the linguistic terms (shown in Table 2).

A. RESULTS OF THE T2NN BASED EDAS APPROACH

Step 1: The fuzzy decision matrix is structured using the evaluation of alternatives given in Table 14 with the help of the T2NNs values in Table 2.

TABLE 1: Linguistic terms and their corresponding values for weighting of criteria [Weakly important (WI); Equal important (EI); Strong important (SI); Very strongly important (VSI); Absolutely important (AI)].

Linguistic terms	T2NN
WI	((0.20,0.30,0.20), (0.60,0.70,0.80), (0.45,0.75,0.75))
EI	((0.40,0.30,0.25), (0.45,0.55,0.40), (0.45,0.60,0.55))
SI	((0.50,0.55,0.55), (0.40,0.45,0.55), (0.35,0.40,0.35))
VSI	((0.80,0.75,0.70), (0.20,0.15,0.30), (0.15,0.10,0.20))
AI	((0.90,0.85,0.95), (0.10,0.15,0.10), (0.05,0.05,0.10))

TABLE 2: Linguistic terms and their corresponding values for rating of alternative.

Linguistic terms	T2NN
Very bad (VB)	((0.20,0.20,0.10), (0.65,0.80,0.85), (0.45,0.80,0.70))
Bad (B)	((0.35,0.35,0.10), (0.50,0.75,0.80), (0.50,0.75,0.65))
Medium bad (MB)	((0.50,0.30,0.50), (0.50,0.35,0.45), (0.45,0.30,0.60))
Medium (M)	((0.40,0.45,0.50), (0.40,0.45,0.50), (0.35,0.40,0.45))
Medium good (MG)	((0.60,0.45,0.50), (0.20,0.15,0.25), (0.10,0.25,0.15))
Good (G)	((0.70,0.75,0.80), (0.15,0.20,0.25), (0.10,0.15,0.20))
Very good (VG)	((0.95,0.90,0.95), (0.10,0.10,0.05), (0.05,0.05,0.05))

TABLE 3: The score values of alternatives for each criterion.

Alternatives	Criteria					
	C_1	C_2	C_3	C_4	C_5	C_6
A1	0.898	0.898	0.911	0.889	0.906	0.889
A2	0.846	0.827	0.846	0.807	0.875	0.875
A3	0.890	0.889	0.911	0.858	0.911	0.875
A4	0.911	0.911	0.911	0.911	0.914	0.898
A5	0.846	0.875	0.906	0.878	0.898	0.872
A6	0.903	0.897	0.884	0.899	0.911	0.908

Alternatives	Criteria				
	C_7	C_8	C_9	C_{10}	C_{11}
A1	0.890	0.886	0.875	0.860	0.838
A2	0.898	0.872	0.906	0.875	0.860
A3	0.875	0.863	0.860	0.857	0.835
A4	0.875	0.898	0.878	0.842	0.853
A5	0.838	0.856	0.853	0.863	0.838
A6	0.908	0.794	0.826	0.910	0.739

Step 2: The score values of alternatives for each criteria are calculated using Eq. (7) and are presented in Table 3.

Step 3: The average solution matrix (AV_j) calculated using the score values in Table 3 and Eq. (11) is presented in Table 4

TABLE 4: The average solution matrix.

Criteria	C_1	C_2	C_3	C_4	C_5	C_6
AV_j	0.882	0.883	0.895	0.874	0.902	0.886

Criteria	C_7	C_8	C_9	C_{10}	C_{11}
AV_j	0.881	0.862	0.866	0.868	0.827

Step 4: Using the values in Table 3 and Table 4, the positive and negative distance from average for each alternative are calculated using Eqs. (12)-(15) and reported in Table 5 and Table 6, respectively.

TABLE 5: The values of positive distance from average of DLT alternatives.

Alternatives	Criteria					
	C_1	C_2	C_3	C_4	C_5	C_6
A1	0.018	0.018	0.018	0.017	0.004	0.003
A2	0.000	0.000	0.000	0.000	0.000	0.000
A3	0.008	0.007	0.018	0.000	0.009	0.000
A4	0.032	0.032	0.018	0.042	0.012	0.014
A5	0.000	0.000	0.012	0.005	0.000	0.000
A6	0.024	0.016	0.000	0.029	0.010	0.025

Alternatives	Criteria				
	C_7	C_8	C_9	C_{10}	C_{11}
A1	0.010	0.000	0.010	0.000	0.013
A2	0.020	0.000	0.045	0.008	0.039
A3	0.000	0.000	0.000	0.000	0.009
A4	0.000	0.000	0.014	0.000	0.031
A5	0.000	0.007	0.000	0.000	0.013
A6	0.031	0.078	0.000	0.049	0.000

TABLE 6: The values negative distance from average of the alternatives.

Alternatives	Criteria					
	C_1	C_2	C_3	C_4	C_5	C_6
A1	0.000	0.000	0.000	0.000	0.000	0.000
A2	0.041	0.063	0.055	0.077	0.031	0.013
A3	0.000	0.000	0.000	0.017	0.000	0.013
A4	0.000	0.000	0.000	0.000	0.000	0.000
A5	0.041	0.009	0.000	0.000	0.005	0.016
A6	0.000	0.000	0.012	0.000	0.000	0.000

Alternatives	Criteria				
	C_7	C_8	C_9	C_{10}	C_{11}
A1	0.000	0.029	0.000	0.009	0.000
A2	0.000	0.012	0.000	0.000	0.000
A3	0.007	0.002	0.007	0.013	0.000
A4	0.007	0.043	0.000	0.029	0.000
A5	0.048	0.000	0.015	0.006	0.000
A6	0.000	0.000	0.046	0.000	0.107

Step 5: The weights of criteria are determined using Eq. (7) and the normalized criteria weights are presented in Table 7. Later, following Eqs. (16)-(17), the weighted PDA and NDA are calculated using the Tables 5-6 and are presented in Tables 8 and 9, respectively. After that, the weighted sum of PDA and NDA (SP_i and SN_i) are obtained and reported in Table 10.

TABLE 7: The normalized weights of eleven criteria.

Criteria	C_1	C_2	C_3	C_4	C_5	C_6
Weights	0.094	0.093	0.093	0.088	0.093	0.093

Criteria	C_7	C_8	C_9	C_{10}	C_{11}
Weights	0.094	0.089	0.084	0.092	0.086

Steps 6-7: The values of SP_i and SN_i given in Table 10 are normalized using Eqs. (18)-(19), respectively. Later, the compromise score of each alternative is calculated using Eq.

TABLE 8: The weighted PDA.

Alternatives	Criteria					
	C_1	C_2	C_3	C_4	C_5	C_6
A1	0.002	0.002	0.002	0.002	0.000	0.000
A2	0.000	0.000	0.000	0.000	0.000	0.000
A3	0.001	0.001	0.002	0.000	0.001	0.000
A4	0.003	0.003	0.002	0.004	0.001	0.001
A5	0.000	0.000	0.001	0.000	0.000	0.000
A6	0.002	0.002	0.000	0.003	0.001	0.002

Alternatives	C_7	C_8	C_9	C_{10}	C_{11}
A1	0.001	0.000	0.001	0.000	0.001
A2	0.002	0.000	0.004	0.001	0.003
A3	0.000	0.000	0.000	0.000	0.001
A4	0.000	0.000	0.001	0.000	0.003
A5	0.000	0.001	0.000	0.000	0.001
A6	0.003	0.007	0.000	0.004	0.000

TABLE 9: The weighted NDA.

Alternatives	Criteria					
	C_1	C_2	C_3	C_4	C_5	C_6
A1	0.000	0.000	0.000	0.000	0.000	0.000
A2	0.004	0.006	0.005	0.007	0.003	0.001
A3	0.000	0.000	0.000	0.002	0.000	0.001
A4	0.000	0.000	0.000	0.000	0.000	0.000
A5	0.004	0.001	0.000	0.000	0.000	0.001
A6	0.000	0.000	0.001	0.000	0.000	0.000

Alternatives	C_7	C_8	C_9	C_{10}	C_{11}
A1	0.000	0.003	0.000	0.001	0.000
A2	0.000	0.001	0.000	0.000	0.000
A3	0.001	0.000	0.001	0.001	0.000
A4	0.001	0.004	0.000	0.003	0.000
A5	0.005	0.000	0.001	0.001	0.000
A6	0.000	0.000	0.004	0.000	0.009

(20). The normalized values (NSP_i and NSN_i) and the compromise score (AS_i) are given in Table 10.

Step 8: Based on the results of AS_i , the alternatives are ranked. The rank of six alternatives is $A4 > A6 > A1 > A3 > A5 > A2$. Table 10 shows that $A4$ is the best among the six DLT alternatives because it has the highest value of AS , while $A2$ is the worst alternative.

TABLE 10: The ranking results of T2NN based EDAS model.

Alternatives	SP_i	SP_i	NSP_i	NSN_i	AS_i	Rank
A1	0.010	0.003	0.424	0.872	0.648	3
A2	0.010	0.027	0.413	0.000	0.206	6
A3	0.005	0.005	0.198	0.801	0.500	4
A4	0.018	0.007	0.738	0.733	0.735	1
A5	0.003	0.013	0.142	0.516	0.329	5
A6	0.024	0.014	1.000	0.468	0.734	2

TABLE 11: The ranking results of T2NN based WASPAS, MABAC and CODAS model.

Alternatives	A1	A2	A3	A4	A5	A6	λ	Rank
A1	0.000	0.022	0.007	-0.004	0.016	-0.003	0.041	3
A2	-0.022	0.000	-0.016	-0.055	-0.008	-0.053	-0.100	6
A3	-0.007	0.016	0.000	-0.011	0.009	-0.010	0.007	4
A4	0.004	0.055	0.011	0.000	0.020	0.001	0.089	1
A5	-0.016	0.008	-0.009	-0.020	0.000	-0.019	-0.038	5
A6	0.003	0.053	0.010	-0.001	0.019	0.000	0.083	2

B. RESULTS OF THE T2NN BASED MODEL INCLUDING WASPAS, MABAC, AND CODAS

The survey results are used with the model proposed in Section IV-B2 and the final ranking results of proposed Model-II is shown in Table 11. Ranking results from best to worst are $A_4 > A_6 > A_1 > A_3 > A_5 > A_2$. Each model found A_4 to be the best alternative while A_2 is the less suitable alternative for two proposed model. The main reason for A_2 being the worst alternative is that it has the lowest transaction speed and highest power consumption.

C. COMPARISON WITH EXISTING METHOD

This section shows a comparison of the two proposed models with the following two existing MCDM methods:

Existing MCDM-1 : T2NN based CODAS approach presented in [16]

Existing MCDM-2 : T2NN based fuzzy TOPSIS [13]

The ranking results for each of model and existing MCDM models are given in Table 12 and shown in Fig. 5.

The existing MCDM-1 is not based on weighted sum and product. Comparison with the proposed models indicate that A_4 is still the most suitable use case of energy blockchain system for the three models while A_2 is the worst alternative for the two proposed models. The only difference found between the models and existing MCDM model is the ranking of A_2 and A_5 . The main reason for this small difference lies in the properties of the distance calculations of the existing MCDM model-1. The proposed hybrid model uses a linear normalization to eliminate the units of criterion values. The measures of weighted sum and weighted product using WASPAS approach are implemented to aggregate the fuzzy values. The border approximation area is applied to close the ideal solution. Using the MABAC method as a reliable tool for rational decision making allows comprehensive evaluation of the potential value of gains and losses [71]. CODAS which includes two types of distances are used to evaluate the desirability of alternatives [73]. Thus combining all three to form the proposed hybrid MCDM model can better express uncertainty.

Applying the existing MCDM-2 method shows the ranking of alternatives to be $A_6 > A_2 > A_4 > A_3 > A_5 > A_2$, which shows a bigger difference with the proposed two models. The results of this model were different from other models as the normalization technique used has a different structure.

TABLE 12: The comparison ranking of the proposed models and two existing MCDM models.

Alt.	Proposed Model I		Proposed Model II		Existing MCDM-1		Existing MCDM-2	
	Score	Ranking	Score	Ranking	Score	Ranking	Score	Ranking
A1	0.648	3	0.041	3	0.004	3	0.617	2
A2	0.206	6	-0.100	6	-0.006	5	0.466	6
A3	0.500	4	0.007	4	-0.004	4	0.578	4
A4	0.735	1	0.089	1	0.013	1	0.609	3
A5	0.329	5	-0.038	5	-0.007	6	0.527	5
A6	0.734	2	0.083	2	0.010	2	0.661	1

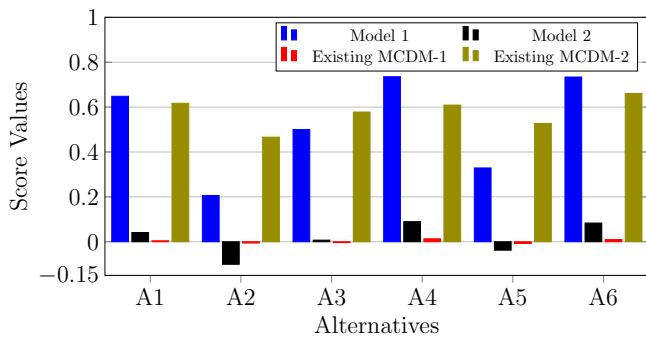

FIGURE 5: Comparative analysis of proposed models against existing MCDM models

D. STABILITY ANALYSIS

Sensitivity analysis is performed with respect to change in priority weights to investigate the stability of the solution. The sensitivity analysis process is completed by changing the weights of each criterion with other criteria weights. Therefore, experiments are done with 20 different sets. In each experiment, we examine the overall scores. Results of each experiment are illustrated in Figure 6 that illustrates that varying criteria weights did not affect the ranking results. In addition, the impact of different values of the threshold parameter on the ranking results of the T2NN based integrated WASPAS, MABAC, and CODAS model is shown in Figure 7. The results indicate that the ranking of the alternatives is not changed for different threshold values.

E. DISCUSSION

The outcome of the proposed algorithm yielded the following results: $A4 > A6 > A1 > A3 > A5 > A2$. According to the finding of this study, **Grid Management and Transactions** use case yielded as the most significant use case among the six alternatives/use cases. This use case accommodate various multi-layer, sophisticated and interconnected tasks

Likewise, **Sustainability Attributions and Green Energy Certification** use case landed to the last position in terms of ranking among the other five options. As stated in Section I, the contribution of the paper is to apply complex decision-making frameworks to a multi-criteria decision making problem, and the results illustrated here depend on the reviews of the experts. The framework and proposed

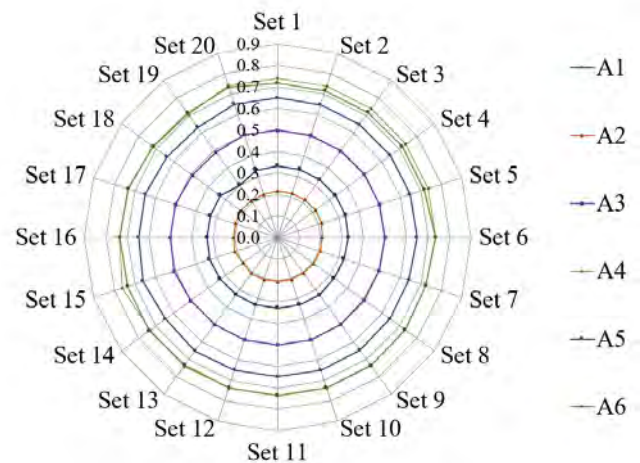

(a) T2NN based EDAS

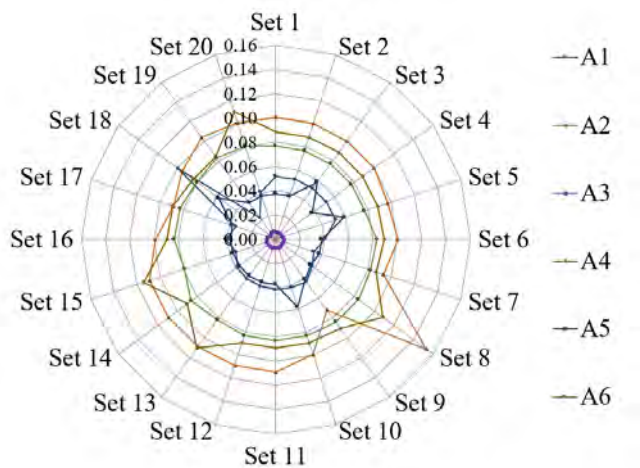

(b) T2NN based WASPAS, MABAC and CODAS

FIGURE 6: Sensitivity analysis for the proposed models.

methods are independent of the choice of use cases, evaluation criteria and number of expert reviews.

VI. CONCLUSION

This study presented two models – a T2NN based EDAS model and a T2NN based integrated WASPAS, MABAC, and CODAS model to evaluate and rank the use cases of

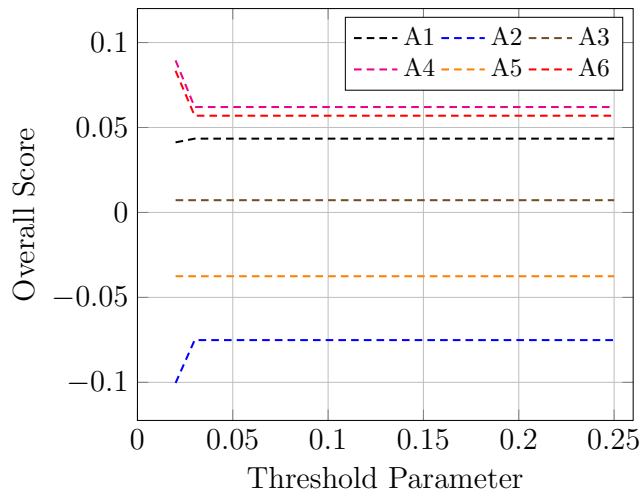

FIGURE 7: The analysis of the impact of the parameter ψ .

an energy blockchain system. Comparison against a T2NN based CODAS approach is illustrated too to test the applicability of the two proposed models. Moreover, a sensitivity analysis is performed with a set of weights for each criterion to investigate the effect of the weightings on the ranking order of the alternatives.

This work aims to develop a methodology that can be used to prioritize the energy blockchain use cases. The proposed approach is based on advanced decision-making algorithms that can capture consensus-based expert opinion via a dedicated survey as an interface. The main contributions of this study are: (i) representing and handling higher degrees of uncertainties such as vagueness, imprecision, and inconsistency in the decision process of prioritizing energy blockchain under T2NNs, (ii) handling multiple uncertainties in the decision-making problem through a new type-2 neutrosophic fuzzy numbers (T2NN) based EDAS and hybrid model, and, (iii) proposing alternatives and evaluation criteria for energy blockchain use cases. However, since the study uses only four experts' opinions, primarily academicians, the ranking result does not reflect a comprehensive and representative ranking result. Nevertheless, this work can be considered an early prototype of a functional decision-support tool that can incorporate a more diversified and higher number of expert opinions to yield better results.

The energy blockchain use cases considered in this work represents a small subset of numerous possible use cases of DLT for power systems. Also, the set of criteria used is limited, and the formulation has been tested with only four survey results. Therefore, wider adoption of the presented formulation will require evaluating the proposed models with more use cases, a broader set of criteria and more survey results, which will increase the complexity of the calculation. One path to resolve This limitation will require solving the presented algorithm with more user-friendly software. Secondly, the λ value for Model-II does not affect the results after a certain value which may depend upon the use of

chosen values shown in Table 1 and Table 2.

The future research includes using Type-3 and higher Neutrosophic Numbers, extending the model using Pythagorean Fuzzy sets [74], using MACBETH or Best Worst Method to calculate criterion weights instead of T2NN score function, and more. These approaches are well-known approaches in decision-making to determine criteria weights. Further comparison will be completed by applying the EDAS method to calculate the alternatives. Moreover, the authors are currently working on extending the scope of the work by adding more use cases and criteria while increasing the collected survey results. Furthermore, the developed models can also be applied in other decision-making problems such as transportation, manufacturing, healthcare management, business management, and other management decisions problems.

APPENDIX A DATA USED FOR IMPLEMENTING T2NN REFERENCES

- [1] Petter Johansson, Martin Vendel, and Cali Nuur. Integrating distributed energy resources in electricity distribution systems: An explorative study of challenges facing DSOs in Sweden. *Utilities Policy*, 67(August):101117, 2020.
- [2] G. Ferro, F. Laureri, R. Minciardi, and M. Robba. An optimization model for electrical vehicles scheduling in a smart grid. *Sustainable Energy, Grids and Networks*, 14:62–70, 2018.
- [3] PNNL. Connected campuses to test transactive energy. Technical report, Pacific Northwest National Lab, 2015.
- [4] Riham Altawy, Muhammad Elsheikh, Amr M. Youssef, and Guang Gong. Lelantos: A blockchain-based anonymous physical delivery system. *Proceedings - 2017 15th Annual Conference on Privacy, Security and Trust, PST 2017*, pages 15–24, 2018.
- [5] Umit Cali and Ozan Cakir. Energy Policy Instruments for Distributed Ledger Technology Empowered Peer-to-Peer Local Energy Markets. *IEEE Access*, 7:82888–82900, 2019.
- [6] Tharaka Hewa, Mika Ylianttila, and Madhusanka Liyanage. Survey on blockchain based smart contracts: Applications, opportunities and challenges. *Journal of Network and Computer Applications*, page 102857, 2020.
- [7] Merlinda Andoni, Valentin Robu, David Flynn, Simone Abram, Dale Geach, David Jenkins, Peter McCallum, and Andrew Peacock. Blockchain technology in the energy sector: A systematic review of challenges and opportunities. *Renewable and Sustainable Energy Reviews*, 100:143–174, 2019.
- [8] Bernd Teufel, Anton Sentic, and Mathias Barmet. Blockchain energy: Blockchain in future energy systems. *Journal of Electronic Science and Technology*, 17(4):100011, 2019.
- [9] Tonghe Wang, Haochen Hua, Zhiqian Wei, and Junwei Cao. Challenges of blockchain in new generation energy systems and future outlooks. *International Journal of Electrical Power & Energy Systems*, 135:107499, 2022.
- [10] Umit Cali, Claudio Lima, Xuefei Li, and Yasuhiko Ogushi. DLT / Blockchain in Transactive Energy Use Cases Segmentation and Standardization Framework. In 2019 IEEE PES Transactive Energy Systems Conference (TESC), pages 1–5, 2019.
- [11] Umit Cali and Claudio Lima. Energy Informatics Using the Distributed Ledger Technology and Advanced Data Analytics. In Peter Yang, editor, *Cases on Green Energy and Sustainable Development*, pages 438–481. IGI Global, 2020.
- [12] Limei Liu, Wenzhi Cao, Biao Shi, and Ming Tang. Large-scale green supplier selection approach under a q-rung interval-valued orthopair fuzzy environment. *Processes*, 7(9):573, 2019.
- [13] Mohamed Abdel-Basset, M Saleh, Abdullallah Gamal, and Florentin Smarandache. An approach of TOPSIS technique for developing supplier selection with group decision making under type-2 neutrosophic number. *Applied Soft Computing*, 77:438–452, 2019.

TABLE 13: The importance ratings of the criteria by experts.

Experts	Criteria										
	C_1	C_2	C_3	C_4	C_5	C_6	C_7	C_8	C_9	C_{10}	C_{11}
E1	AI	VSI	VSI	SI	VSI	VSI	AI	SI	SI	VSI	SI
E2	VSI	VSI	VSI	SI	AI	AI	AI	VSI	EI	EI	SI
E3	AI	AI	AI	VSI	AI	VSI	AI	VSI	SI	AI	VSI
E4	AI	AI	AI	SI	VSI	AI	VSI	SI	SI	AI	EI

TABLE 14: The ratings of the DLT alternatives in terms of criterion and each experts.

Alternatives	Experts	Criteria										
		C_1	C_2	C_3	C_4	C_5	C_6	C_7	C_8	C_9	C_{10}	C_{11}
A1	E1	G	G	VG	G	MG	G	G	G	VG	G	MG
	E2	VG	VG	VG	VG	VG	G	G	G	MG	M	M
	E3	G	G	VG	G	VG	MG	G	VG	G	MG	G
	E4	G	G	G	MG	VG	VG	G	M	MG	G	M
A2	E1	MG	MG	MG	B	MG	MG	G	MG	VG	G	MG
	E2	MG	MG	MG	MG	MG	VG	VG	VG	VG	M	G
	E3	MG	MG	G	MG	G	MG	G	G	G	G	G
	E4	G	MG	MG	M	VG	G	G	M	G	G	M
A3	E1	G	G	VG	MG	VG	G	VG	MG	G	G	G
	E2	G	VG	G	MG	G	MG	MG	MG	M	MB	MB
	E3	G	MG	VG	VG	VG	MG	MG	G	MG	MG	MG
	E4	G	G	VG	MG	VG	VG	G	G	G	G	M
A4	E1	VG	VG	G	VG	VG	VG	VG	G	G	G	G
	E2	VG	VG	VG	VG	VG	MG	MG	VG	MG	M	M
	E3	VG	G	VG	VG	VG	G	MG	G	G	MG	G
	E4	G	VG	VG	G	VG	VG	G	G	G	MG	MB
A5	E1	MG	G	VG	MB	MG	G	M	M	MB	MG	MG
	E2	MG	M	M	M	G	M	M	M	M	G	M
	E3	G	G	VG	VG	VG	MG	MG	G	G	G	G
	E4	MG	G	VG	VG	VG	VG	G	G	G	MG	M
A6	E1	G	MB	M	MG	VG	VG	G	MG	VG	VG	MG
	E2	G	MG	MG	MG	G	G	G	M	M	VG	G
	E3	MG	MG	G	MG	G	G	VG	MG	G	MG	G
	E4	G	MG	G	MG	VG	G	G	MG	MG	G	M

[14] Nouran M. Radwan, M. Badr Senousy, and Alaa Eldin M. Riad. A new expert system for learning management systems evaluation based on neutrosophic sets. *Expert Systems*, 33(6):548–558, 2016.

[15] Vladimir Simic, Ilgin Gokasar, Muhammet Deveci, and Ahmet Karakurt. An integrated CRITIC and MABAC based Type-2 neutrosophic model for public transportation pricing system selection. *Socio-Economic Planning Sciences*, page 101157, 2021.

[16] Muhammet Deveci, Vladimir Simic, and Ali Ebadi Torkayesh. Re-manufacturing facility location for automotive lithium-ion batteries: an integrated neutrosophic decision-making model. *Journal of Cleaner Production*, 317:128438, 2021.

[17] Ayman Esmat, Martijn de Vos, Yashar Ghiassi-Farrokhfal, Peter Palensky, and Dick Epema. A novel decentralized platform for peer-to-peer energy trading market with blockchain technology. *Applied Energy*, 282(PA):116123, 2021.

[18] Merlinda Andoni, Valentin Robu, David Flynn, Simone Abram, Dale Geach, David Jenkins, Peter McCallum, and Andrew Peacock. Blockchain technology in the energy sector: A systematic review of challenges and opportunities. *Renewable and Sustainable Energy Reviews*, 100(October 2018):143–174, 2019.

[19] Tiago Sousa, Tiago Soares, Pierre Pinson, Fabio Moret, Thomas Baroche, and Etienne Sorin. Peer-to-peer and community-based markets: A comprehensive review. *Renewable and Sustainable Energy Reviews*, 104:367–378, 2019.

[20] Esther Mengelkamp, Johannes Gärtner, Kerstin Rock, Scott Kessler, Lawrence Orsini, and Christof Weinhardt. Designing microgrid energy markets : A case study : The Brooklyn Microgrid. *Applied energy*, 210:870–880, 2018.

[21] Sonam Norbu, Benoit Couraud, Valentin Robu, Merlinda Andoni, and David Flynn. Modelling the redistribution of benefits from joint in-

- vestments in community energy projects. *Applied Energy*, 287(February):116575, 2021.
- [22] Arne Meeuw, Sandro Schopfer, Anselma Wörner, Verena Tiefenbeck, Liliane Ableitner, Elgar Fleisch, and Felix Wortmann. Implementing a blockchain-based local energy market: Insights on communication and scalability. *Computer Communications*, 160(March):158–171, 2020.
- [23] IEEE Spectrum. Startup Profile: ME SOLshare’s “Swarm Electrification” Powers Villages in Bangladesh, 2018.
- [24] Fabio Moret and Pierre Pinson. Energy Collectives: A Community and Fairness Based Approach to Future Electricity Markets. *IEEE Transactions on Power Systems*, 34(5):3994–4004, 2019.
- [25] Shammya Saha, Nikhil Ravi, Kári Hreinsson, Jaejong Baek, Anna Scaglione, and Nathan G. Johnson. A secure distributed ledger for transactive energy: The Electron Volt Exchange (EVE) blockchain. *Applied Energy*, 282, 2021.
- [26] Juan Cuenca, Emad Jamil, and Barry Hayes. Energy Communities and Sharing Economy Concepts in the Electricity Sector: A Survey. In 2020 IEEE International Conference on Environment and Electrical Engineering and 2020 IEEE Industrial and Commercial Power Systems Europe (EEEIC / I CPS Europe), pages 1–6, 2020.
- [27] Qiang Tu, Jianlei Mo, Regina Betz, Lianbiao Cui, Ying Fan, and Yu Liu. Achieving grid parity of solar PV power in China- The role of Tradable Green Certificate. *Energy Policy*, 144(May):111681, 2020.
- [28] Yuting Pan, Xiaosong Zhang, Yi Wang, Junhui Yan, Shuonv Zhou, Guanghua Li, and Jiexiong Bao. Application of Blockchain in Carbon Trading. *Energy Procedia*, 158:4286–4291, 2019.
- [29] United States Environmental Protection Agency. Renewable Energy Certificate Monetization. <https://www.epa.gov/repowertoolbox/renewable-energy-certificate-monetization>, 2021. [Online; accessed 17-December-2021].
- [30] Power System Operation Corporation Limited. Renewable Energy Certificate Registry of INDIA. <https://www.recregistryindia.nic.in>, 2021. [Online; accessed 17-December-2021].
- [31] Chrisman, Katherine and Cao, Yiyan. RMI Buys Renewable Energy Certificates in China’s Pilot Market. <https://rmi.org/rmi-buys-renewable-energy-certificates-chinas-pilot-market/>, 2021. [Online; accessed 17-December-2021].
- [32] AIB. Certification. {<https://www.aib-net.org/certification>}, 2021. [Online; accessed 17-December-2021].
- [33] A Perez, Enzo Sauma, Francisco Munoz, and Ben Hobbs. The Economic Effects of Interregional Trading of Renewable Energy Certificates in the U.S. *WECC. The Energy Journal*, 37, 2016.
- [34] Fangyuan Zhao, Xin Guo, and Wai Kin (Victor) Chan. Individual Green Certificates on Blockchain: A Simulation Approach. *Sustainability*, 12(9), 2020.
- [35] Shao-Chao Ma and Ying Fan. A deployment model of EV charging piles and its impact on EV promotion. *Energy Policy*, 146:111777, 2020.
- [36] Sri Nikhil Gupta Gouriseti, Ümit Cali, Kim-Kwang Raymond Choo, Elizabeth Escobar, Christopher Gorog, Annabelle Lee, Claudio Lima, Michael Mylrea, Marco Pasetti, Farokh Rahimi, Ramesh Reddi, and Abubakar Sadiq Sani. Standardization of the Distributed Ledger Technology cybersecurity stack for power and energy applications. *Sustainable Energy, Grids and Networks*, page 100553, 2021.
- [37] Eric Münsing, Jonathan Mather, and Scott Moura. Blockchains for decentralized optimization of energy resources in microgrid networks. In 2017 IEEE Conference on Control Technology and Applications (CCTA), pages 2164–2171, 8 2017.
- [38] Prince Waqas Khan and Yung-Cheol Byun. Blockchain-based peer-to-peer energy trading and charging payment system for electric vehicles. *Sustainability*, 13(14):7962, Jul 2021.
- [39] Zhengtang Fu, Peiwu Dong, Siyao Li, Yanbing Ju, and Hanbo Liu. How blockchain renovate the electric vehicle charging services in the urban area? A case study of Shanghai, China. *Journal of Cleaner Production*, 315:128172, 2021.
- [40] Clean Tech. Autonomous Datasets and V2X Transactions: Blockchain in Mobility Pilots Getting Traction, 2018.
- [41] Ben Schiller. Need a car charging infrastructure? How about peer-to-peer and on the blockchain?, 2017. [Online; accessed 17-December-2021].
- [42] Godwin C Okwuibe, Zeguang Li, Thomas Brenner, and Ole Langniss. A Blockchain Based Electric Vehicle Smart Charging System with Flexibility. *IFAC-PapersOnLine*, 53(2):13557–13561, 2020.
- [43] Murat Kuzlu, Salih Sarp, Manisa Pipattanasomporn, and Umit Cali. Realizing the potential of blockchain technology in smart grid applications. 2020 IEEE Power and Energy Society Innovative Smart Grid Technologies Conference, ISGT 2020, pages 1–5, 2020.
- [44] Martin Braun and Philipp Strauss. A review on aggregation approaches of controllable distributed energy units in electrical power systems. *International Journal of Distributed Energy Resources*, 4, 2008.
- [45] Stephan Koch. Chapter 2 - assessment of revenue potentials of ancillary service provision by flexible unit portfolios. In Pengwei Du and Ning Lu, editors, *Energy Storage for Smart Grids*, pages 35 – 66. Academic Press, Boston, 2015.
- [46] N. Mahmoudi, T. K. Saha, and M. Eghbal. A new trading framework for demand response aggregators. In 2014 IEEE PES General Meeting 1 Conference Exposition, pages 1–5, 2014.
- [47] Shaomin Zhang, Jieqi Rong, and Baoyi Wang. A privacy protection scheme of smart meter for decentralized smart home environment based on consortium blockchain. *International Journal of Electrical Power & Energy Systems*, 121:106140, 2020.
- [48] Aron Laszka, Abhishek Dubey, Michael Walker, and Douglas Schmidt. Providing Privacy, Safety, and Security in IoT-Based Transactive Energy Systems using Distributed Ledgers. 2017.
- [49] Pierluigi Siano, Giuseppe De Marco, Alejandro Rolan, and Vincenzo Loia. A Survey and Evaluation of the Potentials of Distributed Ledger Technology for Peer-to-Peer Transactive Energy Exchanges in Local Energy Markets. *IEEE Systems Journal*, 13(3):3454–3466, 2019.
- [50] Energy Web. We build operating systems for energy grids. <https://www.energyweb.org/>, 2022. [Online; accessed 28-January-2022].
- [51] Ugur Halden, Umit Cali, Marthe Fogstad Dyne, Joseph Stekli, and Linquan Bai. DLT-based equity crowdfunding on the techno-economic feasibility of solar energy investments. *Solar Energy*, 227(August):137–150, 2021.
- [52] Cristiano Bellavitis, Christian Fisch, and Johan Wiklund. A comprehensive review of the global development of initial coin offerings (ICOs) and their regulation. *Journal of Business Venturing Insights*, 15:e00213, 2021.
- [53] Sebastian Gryglewicz, Simon Mayer, and Erwan Morellec. Optimal financing with tokens. *Journal of Financial Economics*, 142(3):1038–1067, 2021.
- [54] Mihail Mihaylov, Sergio Jurado, Narcís Avellana, Kristof Van Moffaert, Ildefons Magrans de Abril, and Ann Nowé. Nrgcoin: Virtual currency for trading of renewable energy in smart grids. In 11th International Conference on the European Energy Market (EEM14), pages 1–6, 2014.
- [55] Fernando García-Monleón, Ignacio Danvila-del Valle, and Francisco J. Lara. Intrinsic value in crypto currencies. *Technological Forecasting and Social Change*, 162(June 2020):120393, 2021.
- [56] Gagandeep Kaur and Charu Gandhi. Chapter 15 - scalability in blockchain: Challenges and solutions. In Saravanan Krishnan, Valentina E. Balas, E. Golden Julie, Y. Harold Robinson, S. Balaji, and Raghvendra Kumar, editors, *Handbook of Research on Blockchain Technology*, pages 373–406. Academic Press, 2020.
- [57] Shen Wang, Ahmad F. Taha, and Jianhui Wang. Blockchain-assisted crowdsourced energy systems. In 2018 IEEE Power Energy Society General Meeting (PESGM), pages 1–5, 2018.
- [58] United Nations. The 17 Goals. <https://sdgs.un.org/goals>, 2021. [Online; accessed 14-November-2021].
- [59] Lotfi Asker Zadeh. Fuzzy sets. *Information and Control*, 8(3):338–353, 1965.
- [60] Krassimir T. Atanassov. Intuitionistic fuzzy sets. *Fuzzy Sets and Systems*, 20(1):87–96, 1986.
- [61] Florentin Smarandache. Neutrosophy: neutrosophic probability, set, and logic: analytic synthesis & synthetic analysis. 1998.
- [62] Zdzislaw Pawlak. Rough sets. *International of Computer and Information Science*, 11:341–356, 1982.
- [63] Muhammet Deveci, Nuh Erdogan, Umit Cali, Joseph Stekli, and Shuya Zhong. Type-2 neutrosophic number based multi-attributive border approximation area comparison (MABAC) approach for offshore wind farm site selection in USA. *Engineering Applications of Artificial Intelligence*, 103:104311, 2021.
- [64] Florentin Smarandache. Neutrosophic set-a generalization of the intuitionistic fuzzy set. *International journal of pure and applied mathematics*, 24(3):287, 2005.
- [65] Pranab Biswas, Surapati Pramanik, and Bibhas C Giri. Aggregation of triangular fuzzy neutrosophic set information and its application to multi-attribute decision making. *Neutrosophic sets and systems*, 12:20–40, 2016.
- [66] Xindong Peng and Jingguo Dai. Research on the assessment of classroom teaching quality with q-rung orthopair fuzzy information based on multi-

- parametric similarity measure and combinative distance-based assessment. *International Journal of Intelligent Systems*, 34(7):1588–1630, 2019.
- [67] Chandan Chakraborty and Debjani Chakraborty. A theoretical development on a fuzzy distance measure for fuzzy numbers. *Mathematical and Computer Modelling*, 43(3-4):254–261, 2006.
- [68] Tan RuiPu and Zhang Wende. Multiple attribute group decision making methods based on trapezoidal fuzzy neutrosophic numbers. *Journal of Intelligent & Fuzzy Systems*, 33(4):2547–2564, 2017.
- [69] Mehdi Keshavarz Ghorabae, Edmundas Kazimieras Zavadskas, Laya Olfat, and Zenonas Turskis. Multi-criteria inventory classification using a new method of evaluation based on distance from average solution (EDAS). *Informatica*, 26(3):435–451, 2015.
- [70] Edmundas Kazimieras Zavadskas, Zenonas Turskis, Jurgita Antucheviciene, and Algimantas Zakarevicius. Optimization of weighted aggregated sum product assessment. *Elektronika ir elektrotechnika*, 122(6):3–6, 2012.
- [71] Dragan Pamučar, Ivan Petrović, and Goran Čirović. Modification of the Best–Worst and MABAC methods: A novel approach based on interval-valued fuzzy-rough numbers. *Expert systems with applications*, 91:89–106, 2018b.
- [72] Mehdi Keshavarz Ghorabae, Edmundas Kazimieras Zavadskas, Zenonas Turskis, and Jurgita Antucheviciene. A New Combinative Distance-Based Assessment (CODAS) Method for Multi-Criteria Decision-Making. *Economic Computation & Economic Cybernetics Studies & Research*, 50(3), 2016.
- [73] Kaan Deveci, Rabia Cin, and Ahmet Kağızman. A modified interval valued intuitionistic fuzzy codas method and its application to multi-criteria selection among renewable energy alternatives in turkey. *Applied Soft Computing*, 96:106660, 2020.
- [74] Lei Wang and Harish Garg. Algorithm for multiple attribute decision-making with interactive archimedean norm operations under pythagorean fuzzy uncertainty. *International Journal of Computational Intelligence Systems*, 14(1):503–527, 2021.

Developing of a Novel Integrated MCDM MULTIMOOSRAL Approach for Supplier Selection

Alptekin Ulutaş, Dragiša Stanujkić, Darjan Karabašević, Gabrijela Popović, Edmundas Kazimieras Zavadskas, Florentin Smarandache, Willem K.M. Brauers

Alptekin Ulutaş, Dragiša Stanujkić, Darjan Karabašević, Gabrijela Popović, Edmundas Kazimieras Zavadskas, Florentin Smarandache, Willem K.M. Brauers (2021). Developing of a Novel Integrated MCDM MULTIMOOSRAL Approach for Supplier Selection. *Informatica* 32(1), 145–161; DOI: 10.15388/21-INFOR445

Abstract. The main aim of the article is to propose a new multiple criteria decision-making approach for selecting alternatives, the newly-developed MULTIMOOSRAL approach, which integrates advantages of the three well-known and prominent multiple-criteria decision-making methods: MOOSRA, MOORA, and MULTIMOORA. More specifically, the MULTIMOOSRAL method has been further upgraded with an approach that can be clearly seen in the well-known WASPAS and CoCoSo methods, which rely on the integration of weighted sum and weighted product approaches. In addition to the above approaches, the MULTIMOOSRAL method also integrates a logarithmic approximation approach. The expectation from the development of this method is that the integration of several approaches can provide a much more reliable selection of the most appropriate alternative, which can be very important in cases where the performance of alternatives obtained by using some other method does not differ much. Finally, the ranking of alternatives based on the dominance theory, used in the MOORA and MULTIMOORA methods, is replaced by a new original approach that should allow a much simpler final ranking of alternatives in order to reach a stronger result with five different techniques. The suitability and efficacy of the proposed MULTIMOOSRAL approach are presented through an illustrative case study of the supplier selection.

Key words: MOOSRA, MOORA, MULTIMOORA, logarithmic approximation, MULTIMOOSRAL, MCDM.

1. Introduction

The increasing competitiveness and complexity of the market, the accelerated development of information and communication technologies have caused the decision-making process in many organizations to become of crucial and decisive importance. Decision-making involves human judgments and logic. Therefore, increasingly complex business conditions require a multi-criteria approach to solving business problems, which allows an objective comparison of several alternatives evaluated in a system of multiple heterogeneous and different criteria with other extremization requirements and different relative importance. Consequently, multi-criteria decision-making (MCDM) methods are useful for facilitation of decision-making process in situations when there are a number of often conflicting criteria (Karamaşa *et al.*, 2020; Stanujkic *et al.*, 2019). Hafezalkotob *et al.* (2019a) emphasizes three categories of the MCDM techniques, such as: Value Measurement Methods (the SAW method; the WASPAS method etc.); Goal or Reference Level Models (the VIKOR method, the TOPSIS method etc.); and Outranking Techniques (the ELECTRE method; the PROMETHEE method etc.).

Accelerated growth and the existence of numerous methods of multi-criteria decision-making can improve the decision-making process in all areas of life. Solving problems by utilizing MCDM is based on quantitative analyses and represent elegant solutions when making decisions between multiple alternatives based on multiple-criteria. Therefore, in due course of time, there are prominent and most common developed MCDM methods, among the dozens of approaches proposed over time for solving complex-decision making problems, such as the Maxmax method, the Maxmin method, the SAW method, the AHP method, the ELECTRE method, the PROMETHEE method, the TOPSIS method, the VIKOR method, the COPRAS method, the MACBETH method, the ANP method, the MOORA method, the MULTIMOORA method, and so forth (Zavadskas *et al.*, 2020; Ulutaş *et al.*, 2020; Jauković-Jocić *et al.*, 2020).

The need to solve as wide a range of real-world problems has led to the creation of a new generation of MCDM methods and approaches, such as: the HEBIN method (Zavadskas *et al.*, 2021); the MARCOS method (Stević *et al.*, 2020); the CoCoSo method (Yazdani *et al.*, 2019); the SECA method (Keshavarz-Ghorabae *et al.*, 2018); the FUCOM method (Pamučar *et al.*, 2018); the ARCAS (Stanujkic *et al.*, 2017a); the PIPRECIA method (Stanujkić *et al.*, 2017b); the MABAC method (Pamučar and Čirović, 2015); the EDAS method (Keshavarz Ghorabae *et al.*, 2015), and so forth. Some of the aforementioned methods were used for ranking of alternatives whereas some of them for the purpose of weight determination.

The MOOSRA method (Multi-Objective Optimization on the basis of Simple Ratio Analysis) belongs to the group of multi-objective optimization methods and is developed by Brauers (2004). The main difference between the MOOSRA method and the MOORA method is reflected in the negative performance scores that do not appear in the MOOSRA method, unlike the MOORA method. Besides, the MOOSRA method is less sensitive to the large variation in the values of the criteria (Adalı and Işık, 2017). So far, the MOOSRA method has been applied for solving of a various complex decision-making problems,

such as: the laptop selection problem (Adalı and Işık, 2017); project-critical path selection (Dorfeshan *et al.*, 2018); bio-medical waste disposal assessment (Narayanamoorthy *et al.*, 2020); machine selection (Sarkar *et al.*, 2015), and so forth. The simplicity of the calculation procedure of the MOOSRA method, which is based on the ratio between weighted ratings of beneficial and non-beneficial criteria, can be mentioned as an important characteristic of this method.

Brauers (2004) also developed the MOORA method (Multi-Objective on the basis of Ratio Analysis). Somewhat later, based on the ideas of the MOORA method, Brauers and Zavadskas (2010) have proposed the MULTIMOORA method (Multi-Objective Optimization by Ratio Analysis plus Full Multiplicative Form). Both methods have been proposed to cope with subjectivity problems. The usability of the MOORA method has been demonstrated in numerous cases, such as: credit evaluation model using MOORA method (İç, 2020); evaluation of the work performance (Fadli and Imtihan, 2019); decision-making in the production system (Attri and Grover, 2014); supplier selection (Karande and Chakraborty, 2012); decision-making in a manufacturing environment (Chakraborty, 2011); privatization in a transition economy (Brauers and Zavadskas, 2006), and so on. When it comes to the MULTIMOORA method, the same has also been applied in various and numerous cases, such as: personnel selection (Karabasevic *et al.*, 2015; Baležentis *et al.*, 2012); risk assessment (Liu *et al.*, 2014); project management (Brauers and Zavadskas, 2010); strategy assessment (Fedajev *et al.*, 2020); ranking of the renewable energy sources (Alkan and Albayrak, 2020); site selection (Rahimi *et al.*, 2020); hybrid vehicle engine selection (Hafezalkotob *et al.*, 2019b), and so on. Integration of several proven multicriteria approaches for ranking alternatives and the use of dominance theory for the final ranking of alternatives can be mentioned as an important characteristic of these methods, which is also proven in the above-mentioned articles.

The main motivation of this research is to develop a new simpler and much more reliable MCDM approach for selecting alternatives. Accordingly, the paper aims to propose a new MCDM-based technique that is based in some segments on previous well-known MCDM techniques (MOOSRA, MOORA, MULTIMOORA), and as a novelty also includes the logarithmic approximation (LA) approach. Therefore, it is also important to state that there are four arithmetic operations in the proposed MULTIMOOSRAL method. These are as follows: addition, subtraction, multiplication, and division. In addition to these arithmetic operations, a fifth evaluation technique, which is the logarithmic approach has been added to the MULTIMOOSRAL method. Thus, unlike other methods (MULTIMOORA, MOORA, and MOOSRA), the MULTIMOOSRAL method was tried to reach a stronger result with five different techniques. For example, MULTIMOORA method uses only three arithmetic operations, which are subtraction, division, and multiplication. On the other hand, MOORA and MOOSRA use only two arithmetic operations. However, the MULTIMOOSRAL method uses all arithmetic operations and a logarithmic approach to reach much more valid and rigorous results.

Further, highlights of the logarithmic normalization are emphasized by Zavadskas and Turskis (2008). Therefore, the newly-developed, so-called MULTIMOOSRAL method integrates five approaches for ranking alternatives. In order to apply and test the new approach, an illustrative case study of the supplier selection is conducted. Accordingly, the

paper is structured as follows: in Section 1, the introductory consideration are given. In Section 2, the MOOSRA method, the MOORA method and the MULTIMOORA method are presented. The new MULTIMOOSRAL approach is presented in Section 3, whereas in Section 4, a conducted case study is demonstrated. Finally, at the end of the article, conclusions are given.

2. Methodology

2.1. The MOOSRA Method

The overall performance score of each alternative v_i in the MOOSRA method is calculated as follows Kumar and Ray (2015):

$$v_i = \frac{\sum_{j \in \theta_{\max}} w_j r_{ij}}{\sum_{j \in \theta_{\min}} w_j r_{ij}}, \tag{1}$$

where w_j denotes weight of criterion j , r_{ij} denotes normalized rating of alternative i in relation to criterion j , θ_{\max} and θ_{\min} denote set of beneficial and set of non-beneficial criteria.

The MOOSRA method uses vector normalization procedure for normalization as follows:

$$r_{ij} = \frac{x_{ij}}{\sqrt{\sum_{i=1}^m (x_{ij})^2}}, \tag{2}$$

where x_{ij} denotes rating of alternative i in relation to criterion j , and m denotes the number of alternatives.

In the MOOSRA method, the alternatives are ranked on the basis of values of v_i in descending order, and the alternative with a higher value of v_i is the most preferable.

2.2. The MOORA Method

The MOORA method combines two approaches to ranking alternatives. The first approach, named the Ratio System (RS) approach, calculates the difference between the ratings of beneficial and non-beneficial criteria as follows:

$$y_i = \sum_{j \in \theta_{\max}} w_j r_{ij} - \sum_{j \in \theta_{\min}} w_j r_{ij}, \tag{3}$$

where y_i denotes an overall importance of the alternative i .

The alternative with a higher value of y_i is the most appropriate alternative in this approach, i.e. alternatives are ranked based on y_i in descending order.

The second approach, named the Reference Point (RP) approach, is based on Tchebycheff Min–Max metric. A maximal distance between alternative and the reference point t_i is determined as follows:

$$t_i = \max_j (w_j |r_j^* - r_{ij}|), \tag{4}$$

where r_j^* denotes j th coordinate of reference point, and it is determined as follows:

$$r_j = \begin{cases} \max_i r_{ij}, & j \in \theta_{\max}, \\ \min_i r_{ij}, & j \in \theta_{\min}. \end{cases} \tag{5}$$

The alternative with the lowest value of t_i is the most appropriate alternative in this approach, i.e. alternatives are ranked based on t_i in ascending order.

The final ranking of the alternatives in the MOORA method is based on the dominance theory, i.e. the alternative with the highest number of appearances in the first positions on two ranking lists is the most appropriate alternative.

2.3. The MULTIMOORA Method

The MULTIMOORA method combines three approaches, where two are adopted from the MOORA method, as shown in Fig. 1. The third approach, named Full Multiplicative Form (FMF), calculates the ratio between ratings of beneficial and non-beneficial criteria as follows:

$$u_i = \frac{\prod_{j \in \theta_{\max}} w_j r_{ij}}{\prod_{j \in \theta_{\min}} w_j r_{ij}}, \tag{6}$$

where u_i denotes an overall utility of the alternative i .

The alternative with a higher value of u_i is the most appropriate alternative in this approach, i.e. alternatives are ranked based on u_i in descending order.

Similarly as in the MOORA method, as a result of the evaluation of the alternatives using the MULTIMOORA method, three ranking orders of alternatives are formed, obtained using three approaches, and the final ranking order, as well as the selection of the most suitable alternative, is made based on the dominance theory.

However, it should be noted that Dahooie *et al.* (2019) considered an approach for ranking alternatives that is not based on the dominance theory.

3. The MULTIMOOSRAL Method

The newly proposed MULTIMOOSRAL method integrates five approaches for ranking alternatives. In addition to the previously discussed approaches, applied in MOOSRA, MOORA and MULTIMOORA methods, the MULTIMOOSRAL method also includes

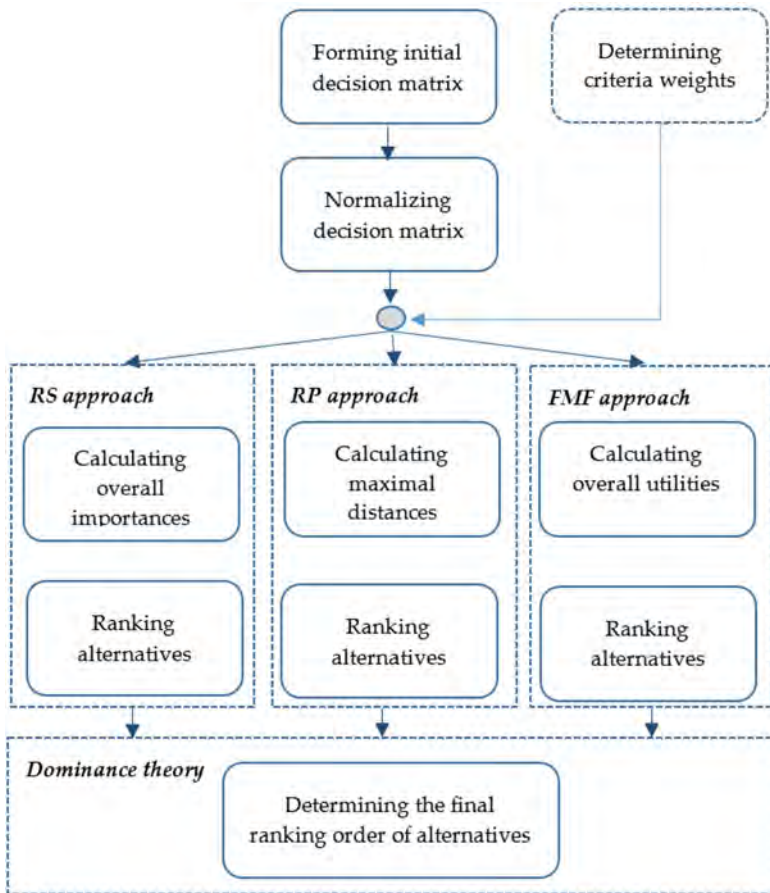

Fig. 1. Computational procedure of the MULTIMOORA method.

the LA approach. In addition, an important characteristic of MULTIMOOSRAL method can be mentioned, that is, it uses a new approach for determining the final ranking order of alternatives, which is not based on the dominance theory.

The computational procedure of the MULTIMOOSRAL method, presented in Fig. 2, can be precisely presented using the following steps:

Step 1. Forming the initial decision matrix and determining criteria weights.

Step 2. Forming the normalized decision matrix. The normalized decision matrix is formed using Eq. (7), which is:

$$r_{ij} = \frac{x_{ij}}{\sqrt{\sum_{i=1}^n (x_{ij})^2}}. \tag{7}$$

Step 3. Calculating the normalized overall utilities of alternatives based on the five approaches included in the MULTIMOOSRAL method, as follows:

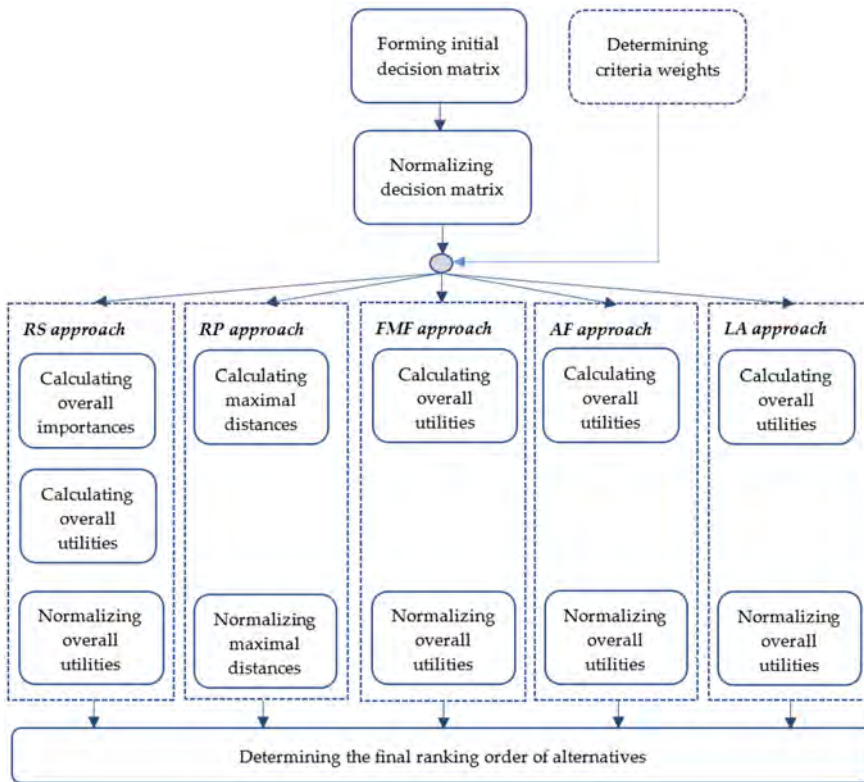

Fig. 2. Computational procedure of the MULTIMOOSRAL method.

Step 3.1. Determining the utility of alternatives based on the RS approach by applying the following substeps:

Substep 3.1.1. Calculating the overall importance of considered alternatives is performed using Eq. (8), which is:

$$y_i = \sum_{j \in \theta_{\max}} w_j r_{ij} - \sum_{j \in \theta_{\min}} w_j r_{ij}. \tag{8}$$

Substep 3.1.2. Calculating the overall utility of considered alternatives as follows:

$$m_i = \begin{cases} y_i, & \max_i(y_i) > 0, \\ y_i + 1, & \max_i(y_i) = 0, \\ -1/y_i, & \max_i(y_i) < 0, \end{cases} \tag{9}$$

where m_i denotes overall utility of alternative i obtained on the basis of RS approach.

Substep 3.1.3. Normalizing the overall utilities obtained on the basis of RS approach as follows:

$$m'_i = \frac{m_i - \min(m_i)}{\max(m_i) - \min(m_i)}, \tag{10}$$

where m'_i denotes normalized overall utility of alternative i obtained on the basis of RS approach.

Step 3.2. Determining the utility of alternatives based on the RP approach by applying the following substeps:

Substep 3.2.1. Determining reference point r^* as follows:

$$r^* = (r_1^*, r_2^*, \dots, r_n^*) = \{ \max_i r_{ij} | j \in \theta_{\max}, \min_i r_{ij} | j \in \theta_{\min} \}. \tag{11}$$

Substep 3.2.2. Calculating the maximal distance between each alternative and the reference point using Eq. (12), which is:

$$t_i = \max_j (w_j | r_j^* - r_{ij} |). \tag{12}$$

Substep 3.2.3. Normalizing maximal distances as follows as follows:

$$t'_i = \frac{\max(t_i) - t_i}{\max(t_i) - \min(t_i)}, \tag{13}$$

where t'_i denotes normalized overall utility of alternative i obtained on the basis of RP approach.

Step 3.3. Determining the utility of alternatives based on the FMF approach by applying the following substeps:

Substep 3.3.1. Calculating the overall utility of the alternatives using Eq. (14), which is:

$$u_i = \frac{\prod_{j \in \theta_{\max}} w_j r_{ij}}{\prod_{j \in \theta_{\min}} w_j r_{ij}}. \tag{14}$$

Substep 3.3.2. Normalizing the overall utilities obtained on the basis of FMF approach as follows:

$$u'_i = \frac{u_i - \min(u_i)}{\max(u_i) - \min(u_i)}, \tag{15}$$

where u'_i denotes normalized overall utility of alternative i obtained on the basis of FMF approach.

Step 3.4. Determining the utility of alternatives based on an addition form (AF) approach by applying the following substeps:

Substep 3.4.1. Calculating the overall utility of each alternative using Eq. (16), which is:

$$v_i = \frac{\sum_{j \in \theta_{\max}} w_j r_{ij}}{\sum_{j \in \theta_{\min}} w_j r_{ij}}. \tag{16}$$

Substep 3.3.2. Normalizing the overall utilities obtained on the basis of AF approach as follows:

$$v'_i = \frac{v_i - \min(v_i)}{\max(v_i) - \min(v_i)}, \tag{17}$$

where v'_i denotes normalized overall utility of alternative i obtained on the basis of AF approach.

Step 3.5. Determining the utility of alternatives based on the LA approach by applying the following substeps:

Substep 3.5.1. Calculating the overall utility of alternatives based on the LA approach k_i as follows:

$$k_i = \sum_{j \in \theta_{\max}} \ln(1 + w_j r_{ij}) + \frac{1}{\sum_{j \in \theta_{\min}} \ln(1 + w_j r_{ij})}. \tag{18}$$

Substep 3.5.2. Normalizing the overall utilities obtained on the basis of AF approach as follows:

$$k'_i = \frac{k_i - \min(k_i)}{\max(k_i) - \min(k_i)}, \tag{19}$$

where k'_i denotes normalized overall utility of alternative i obtained on the basis of AF approach.

Step 4. Determining the final ranking orders of alternatives. The final ranking of alternatives is determined based on their total utility S_i , which is calculated as follows:

$$S_i = m'_i + t'_i + u'_i + v'_i + k'_i. \tag{20}$$

After that, the alternatives are ranked on the basis of values of S_i in descending order and the alternative with higher value of S_i is the most preferable.

4. An Illustrative Case Study

In this study the usability of the MULTIMOOSRAL method was demonstrated on supplier selection problem for a textile company. All data were collected from three managers of the company and the actual data of company. Managers of the company evaluated the criteria (indicated in Table 1) to obtain criteria weights. The evaluation criteria, as well as their weights (obtained by using the SWARA method, Keršuliene *et al.*, 2010), are shown in Table 1.

The data of the first three criteria are actual data and the data of the other criteria are obtained from managers of the company. The ratings of suppliers and normalized decision matrix are shown in Table 2 and Table 3.

Table 1
Evaluation criteria and their weights.

Criterion	Abbreviation	Weight	Type
Reject ratio	RjR	0.163	Non-beneficial
Purchasing cost	PCo	0.166	Non-beneficial
Late delivery ratio	LDT	0.161	Non-beneficial
Discount opportunity	DO	0.130	Beneficial
Technical assistance	TA	0.139	Beneficial
Technological capability	TecC	0.123	Beneficial
Supplier reputation	SRe	0.117	Beneficial

Table 2
Initial decision matrix.

Criteria suppliers	RjR	PCo	LDT	DO	TA	TecC	SRe
Supplier 1	0.02	2.64	0.02	6.3	7.7	7.3	8.3
Supplier 2	0.04	2.45	0.03	7	6.3	5	6.7
Supplier 3	0.04	2.40	0.04	6.7	6.3	5	6.7
Supplier 4	0.03	2.64	0.01	4.7	8.3	7.7	8
Supplier 5	0.04	2.26	0.04	7.7	5.7	7	7

Table 3
Normalized decision matrix.

Criterian suppliers	RjR	PCo	LDT	DO	TA	TecC	SRe
Supplier 1	0.256	0.476	0.294	0.430	0.497	0.502	0.504
Supplier 2	0.513	0.441	0.441	0.477	0.407	0.344	0.407
Supplier 3	0.513	0.432	0.588	0.457	0.407	0.344	0.407
Supplier 4	0.385	0.476	0.147	0.321	0.536	0.529	0.485
Supplier 5	0.513	0.407	0.588	0.525	0.368	0.481	0.425

Table 4
Computational details obtained on the basis of RS approach.

Suppliers	Overall importance	Overall utility	Normalized overall utility
Supplier 1	0.078	0.078	1.000
Supplier 2	-0.019	-0.019	0.211
Supplier 3	-0.045	-0.045	0.000
Supplier 4	0.073	0.073	0.959
Supplier 5	-0.019	-0.019	0.211

The overall importance of alternatives, overall utilities and normalized overall utilities obtained on the basis of RS approach, calculated by Eqs. (8), (9) and (10), are shown in Table 4.

The reference point, obtained using Eq. (11) and data from Table 3, is shown in Table 5.

After that, the maximal distances and normalized maximal distances are calculated, using Eq. (12) and Eq. (13), as shown in Table 6.

The overall utility and normalized overall utility of alternatives obtained on the basis of FMF approach, using Eqs. (14) and (15), are shown in Table 7.

Table 5
The reference point.

	RjR	PCo	LDT	DO	TA	TecC	SRe
r^*	0.256	0.407	0.147	0.525	0.536	0.529	0.504

Table 6
Computational details obtained on the basis of RP approach.

Suppliers	Maximal distance	Normalized maximal distance
Supplier 1	0.024	1.000
Supplier 2	0.047	0.511
Supplier 3	0.071	0.000
Supplier 4	0.027	0.936
Supplier 5	0.071	0.000

Table 7
Computational details obtained on the basis of FMF approach.

Suppliers	Overall utility	Normalized overall utility
Supplier 1	0.0906	0.918
Supplier 2	0.0164	0.053
Supplier 3	0.0118	0.000
Supplier 4	0.0977	1.000
Supplier 5	0.0189	0.082

Table 8
Computational details obtained on the basis of AF approach.

Suppliers	Overall utility	Normalized overall utility
Supplier 1	1.4643	1.000
Supplier 2	0.9167	0.149
Supplier 3	0.8207	0.000
Supplier 4	1.4398	0.962
Supplier 5	0.9231	0.159

The overall utility and normalized overall utility of alternatives obtained on the basis of AF approach, using Eqs. (16) and (17), are shown in Table 8.

The overall utility and normalized overall utility of alternatives obtained on the basis of LA approach, using Eqs. (18) and (19), are shown in Table 9.

Finally, in Table 10 results obtained using five approaches integrated in MULTI-MOOSRAL method, overall utility of considered alternatives, calculated using Eq. (20), and ranking order of alternatives are presented.

Table 9
Computational details obtained on the basis of LA approach.

Suppliers	Overall utility	Normalized overall utility
Supplier 1	6.3697	0.962
Supplier 2	4.7551	0.193
Supplier 3	4.3512	0.000
Supplier 4	6.4490	1.000
Supplier 5	4.4375	0.041

Table 10
Computational details obtained using the MULTIMOOSRAL method.

Suppliers	m'_i	t'_i	u'_i	v'_i	k'_i	Si	Rank
Supplier 1	1.000	1.000	0.918	1.000	0.962	4.880	1
Supplier 2	0.211	0.511	0.053	0.149	0.193	1.117	3
Supplier 3	0.000	0.000	0.000	0.000	0.000	0.000	5
Supplier 4	0.959	0.936	1.000	0.962	1.000	4.857	2
Supplier 5	0.211	0.000	0.082	0.159	0.041	0.494	4

Table 11
Ranking of alternatives using the MOOSRA method.

Suppliers	v_i	Rank
Supplier 1	1.4643	1
Supplier 2	0.9167	4
Supplier 3	0.8207	5
Supplier 4	1.4398	2
Supplier 5	0.9231	3

Table 12
Ranking of alternatives using the MOORA method.

Suppliers	RS	RS Rank	RP	RP Rank	Rank
Supplier 1	0.078	1	0.024	1	1
Supplier 2	-0.019	3	0.047	3	3
Supplier 3	-0.045	5	0.071	4	4-5
Supplier 4	0.073	2	0.027	2	2
Supplier 5	-0.019	4	0.071	4	4

As it can be seen from Table 10, the best supplier selected using the MULTIMOOSRAL method is supplier denoted as “Supplier 1”.

In order to further verify the obtained results, a comparison with the results obtained using the MOOSRA, MOORA and MULTIMOORA methods was performed below. The results obtained using the above methods are shown in Tables 11, 12 and 13.

From Tables 11, 12 and 13 it can be seen that the ranking results obtained using the MULTIMOOSRAL method are identical to the results obtained using the MOOSRA, MOORA and MULTIMOORA methods.

Table 13
Ranking of alternatives using the MULTIMOORA method.

Suppliers	RS	RS Rank	RP	RP Rank	FMF	FMF Rank	Rank
Supplier 1	0.078	1	0.024	1	0,0906	2	1
Supplier 2	-0.019	3	0.047	3	0,0164	4	3
Supplier 3	-0.045	5	0.071	4	0,0118	5	5
Supplier 4	0.073	2	0.027	2	0,0977	1	2
Supplier 5	-0.019	4	0.071	4	0,0189	3	4

Table 14
Comparative analysis of ranking orders obtained using different MCDM methods.

Suppliers	MULTIMOOSRAL	TOPSIS	MULTIMOORA	CoCoSo
Supplier 1	1	1	1	1
Supplier 2	3	3	3	3
Supplier 3	5	5	5	4
Supplier 4	2	2	2	2
Supplier 5	4	4	4	5

In order to finally verify the results obtained using the MULTIMOOSRAL method, a comparative analysis was performed with several well-known MCDM methods, such as TOPSIS, MULTIMOORA, and CoCoSo methods, as shown in Table 14.

It can be observed from Table 14, that the MULTIMOOSRAL method gives the same ranking orders as the TOPSIS and MULTIMOORA methods. Some discrepancy in the rank of the alternative can be observed in the case of the use of the CoCoSo method, which refers to the fourth and fifth-ranked alternatives. However, such phenomena are expected because the newly proposed MULTIMOOSRAL method integrates more ranking approaches and because of that, it should allow a more accurate ranking of the alternatives.

5. Conclusions

This paper proposes a new MCDM technique called MULTIMOOSRAL that is based on the approaches in MOOSRA, MOORA, and MULTIMOORA methods and LA approach for the facilitation of a decision-making process. The main incentive for proposing the new method reflects the desire to develop such an approach that will contribute to the increasing of the credibility of the obtained results. In this case, by involving five approaches (RS, RP, FMF, AF, and LA) the reliability of the final ranking order as well as its stability is raised to a higher level.

In order to demonstrate the applicability and usefulness of the proposed method, the illustrative case study pointed to the selection of the adequate supplier of the textile company is presented. The evaluation process, entrusted to 3 managers, is based on the 7 criteria and 5 alternatives. The gained result revealed that supplier 1 is the most suitable to work within the present conditions, while supplier 3 is the worst choice according to the given performances.

To acknowledge the reliability of the obtained ranking order, the MOOSRA, MOORA, and MULTIMOORA methods are applied. The results from all three used techniques confirmed that one was obtained by using the newly proposed MULTIMOOSRAL method. Namely, in all three observations, supplier 1 is ranked as the best alternative, while supplier 3 is ranked as the last and worst option. In this way, the stability of the proposed MCDM method is verified as well as its suitability for applying in the decision-making process.

Although this novel method contributes to the reliability of the performed decision process by involving more approaches, the same thing could be considered as its main deficiency, too. Namely, the computational procedure could be considered as complex for application by the users that are not familiar with the MCDM field. Additionally, in order to better incorporate the uncertainty, this model could be extended by involving the fuzzy, grey, or neutrosophic numbers. But, despite the mentioned imperfections, the MULTIMOOSRAL method proved its efficiency in enhancing the decision-making process and its possibilities should be further examined.

References

- Adalı, E.A., Işık, A.T. (2017). The multi-objective decision making methods based on MULTIMOORA and MOOSRA for the laptop selection problem. *Journal of Industrial Engineering International*, 13(2), 229–237.
- Alkan, Ö., Albayrak, Ö.K. (2020). Ranking of renewable energy sources for regions in Turkey by fuzzy entropy based fuzzy COPRAS and fuzzy MULTIMOORA. *Renewable Energy*, 162, 712–726.
- Attri, R., Grover, S. (2014). Decision making over the production system life cycle: MOORA method. *International Journal of System Assurance Engineering and Management*, 5(3), 320–328.
- Baležentis, A., Baležentis, T., Brauers, W.K. (2012). Personnel selection based on computing with words and fuzzy MULTIMOORA. *Expert Systems with Applications*, 39(9), 7961–7967.
- Brauers, W.K.M. (2004). *Optimization Methods for a Stakeholder Society. A Revolution in Economic Thinking by Multiobjective Optimization*. Kluwer, Boston, MA.
- Brauers, W.K., Zavadskas, E.K. (2006). The MOORA method and its application to privatization in a transition economy. *Control and Cybernetics*, 35, 445–469.
- Brauers, W.K.M., Zavadskas, E.K. (2010). Project management by MULTIMOORA as an instrument for transition economies. *Technological and Economic Development of Economy*, 16(1), 5–24.
- Chakraborty, S. (2011). Applications of the MOORA method for decision making in manufacturing environment. *The International Journal of Advanced Manufacturing Technology*, 54(9–12), 1155–1166.
- Dahooie, J.H., Zavadskas, E.K., Firoozfar, H.R., Vanaki, A.S., Mohammadi, N., Brauers, W.K.M. (2019). An improved fuzzy MULTIMOORA approach for multi-criteria decision making based on objective weighting method (CCSD) and its application to technological forecasting method selection. *Engineering Applications of Artificial Intelligence*, 79, 114–128.
- Dorfeshan, Y., Mousavi, S.M., Mohagheghi, V., Vahdani, B. (2018). Selecting project-critical path by a new interval type-2 fuzzy decision methodology based on MULTIMOORA, MOOSRA and TPOP methods. *Computers & Industrial Engineering*, 120, 160–178.
- Fadli, S., Imtihan, K. (2019). Implementation of MOORA method in evaluating work performance of honorary teachers. *Sinkron*, 4(1), 128–135.
- Fedajev, A., Stanujkic, D., Karabašević, D., Brauers, W.K., Zavadskas, E.K. (2020). Assessment of progress towards “Europe 2020” strategy targets by using the MULTIMOORA method and the Shannon Entropy Index. *Journal of Cleaner Production*, 244, 118895.
- Hafezalkotob, A., Hafezalkotob, A., Liao, H., Herrera, F. (2019a). Interval MULTIMOORA method integrating interval Borda rule and interval best–worst-method-based weighting model: case study on hybrid vehicle engine selection. *IEEE Transactions on Cybernetics*, 50(3), 1157–1169.

- Hafezalkotob, A., Hafezalkotob, A., Liao, H., Herrera, F. (2019b). An overview of MULTIMOORA for multi-criteria decision-making: theory, developments, applications, and challenges. *Information Fusion*, 51, 145–177.
- İç, Y.T. (2020). A multi-objective credit evaluation model using MOORA method and goal programming. *Arabian Journal for Science and Engineering*, 45(3), 2035–2048.
- Jauković-Jocić, K., Karabašević, D., Jocić, G. (2020). The use of the PIPRECIA method for assessing the quality of e-learning materials. *Ekonomika*, 66(3), 37–45.
- Karabasevic, D., Stanujkic, D., Urosevic, S., Maksimovic, M. (2015). Selection of candidates in the mining industry based on the application of the SWARA and the MULTIMOORA methods. *Acta Montanistica Slovaca*, 20(2), 116–124.
- Karamaşa, Ç., Demir, E., Memiş, S., Korucuk, S. (2020). Weighting the factors affecting logistics outsourcing. *Decision Making: Applications in Management and Engineering*, 4(1), 19–32.
- Karande, P., Chakraborty, S. (2012). Decision making for supplier selection using the MOORA method. *IUP Journal of Operations Management*, 11(2), 6–18.
- Keršulienė, V., Zavadskas, E.K., Turskis, Z. (2010). Selection of rational dispute resolution method by applying new step-wise weight assessment ratio analysis (SWARA). *Journal of Business Economics and Management*, 11(2), 243–258.
- Keshavarz Ghorabae, M., Zavadskas, E.K., Olfat, L., Turskis, Z. (2015). Multi-criteria inventory classification using a new method of evaluation based on distance from average solution (EDAS). *Informatica*, 26(3), 435–451.
- Keshavarz-Ghorabae, M., Amiri, M., Zavadskas, E.K., Turskis, Z., Antucheviciene, J. (2018). Simultaneous evaluation of criteria and alternatives (SECA) for multi-criteria decision-making. *Informatica*, 29(2), 265–280.
- Kumar, R., Ray, A. (2015). Selection of material under conflicting situation using simple ratio optimization technique. In: *Proceedings of Fourth International Conference on Soft Computing for Problem Solving*. Springer, New Delhi, pp. 513–519.
- Liu, H.C., Fan, X.J., Li, P., Chen, Y.Z. (2014). Evaluating the risk of failure modes with extended MULTIMOORA method under fuzzy environment. *Engineering Applications of Artificial Intelligence*, 34, 168–177.
- Narayanamoorthy, S., Annapoorani, V., Kang, D., Baleanu, D., Jeon, J., Kureethara, J.V., Ramya, L. (2020). A novel assessment of bio-medical waste disposal methods using integrating weighting approach and hesitant fuzzy MOOSRA. *Journal of Cleaner Production*, 275, 122587.
- Pamučar, D., Čirović, G. (2015). The selection of transport and handling resources in logistics centers using Multi-Attributive Border Approximation area Comparison (MABAC). *Expert Systems with Applications*, 42(6), 3016–3028.
- Pamučar, D., Stević, Ž., Sremac, S. (2018). A new model for determining weight coefficients of criteria in MCDM models: full consistency method (FUCOM). *Symmetry*, 10(9), 393.
- Rahimi, S., Hafezalkotob, A., Monavari, S.M., Hafezalkotob, A., Rahimi, R. (2020). Sustainable landfill site selection for municipal solid waste based on a hybrid decision-making approach: fuzzy group BWM-MULTIMOORA-GIS. *Journal of Cleaner Production*, 248, 119186.
- Sarkar, A., Panja, S.C., Das, D., Sarkar, B. (2015). Developing an efficient decision support system for non-traditional machine selection: an application of MOORA and MOOSRA. *Production & Manufacturing Research*, 3(1), 324–342.
- Stanujkic, D., Zavadskas, E.K., Karabasevic, D., Turskis, Z., Keršulienė, V. (2017a). New group decision-making ARCAS approach based on the integration of the SWARA and the ARAS methods adapted for negotiations. *Journal of Business Economics and Management*, 18(4), 599–618.
- Stanujkić, D., Zavadskas, E.K., Karabašević, D., Smarandache, F., Turskis, Z. (2017b). The use of Pivot Pair-wise Relative Criteria Importance Assessment method for determining weights of criteria. *Romanian Journal of Economic Forecasting*, 20(4), 116–133.
- Stanujkic, D., Karabasevic, D., Zavadskas, E.K., Smarandache, F., Brauers, W.K. (2019). A bipolar fuzzy extension of the MULTIMOORA method. *Informatica*, 30(1), 135–152.
- Stević, Ž., Pamučar, D., Puška, A., Chatterjee, P. (2020). Sustainable supplier selection in healthcare industries using a new MCDM method: measurement of alternatives and ranking according to compromise solution (MARCOS). *Computers & Industrial Engineering*, 140, 106231.
- Ulutaş, A., Popovic, G., Stanujkic, D., Karabasevic, D., Zavadskas, E.K., Turskis, Z. (2020). A new hybrid MCDM model for personnel selection based on a novel grey PIPRECIA and grey OCRA methods. *Mathematics*, 8(10), 1698.

- Yazdani, M., Zarate, P., Zavadskas, E.K., Turskis, Z. (2019). A combined compromise solution (CoCoSo) method for multi-criteria decision-making problems. *Management Decision*, 57, 2501–2519.
- Zavadskas, E.K., Turskis, Z. (2008). A new logarithmic normalization method in games theory. *Informatica*, 19(2), 303–314.
- Zavadskas, E.K., Turskis, Z., Stević, Ž., Mardani, A. (2020). Modelling procedure for the selection of steel pipes supplier by applying fuzzy AHP method. *Operational Research in Engineering Sciences: Theory and Applications*, 3(2), 39–53.
- Zavadskas, E.K., Bausys, R., Lescauskiene, I., Usovaite, A. (2021). MULTIMOORA under interval-valued neutrosophic sets as the basis for the quantitative heuristic evaluation methodology HEBIN. *Mathematics*, 9(1), 66.

A Single Valued Neutrosophic Extension of the Simple WISP Method

Dragiša Stanujkić, Darjan Karabašević, Gabrijela Popović, Florentin Smarandache,
Predrag S. Stanimirović, Muzafer Saračević, Vasilios N. Katsikis

Dragiša Stanujkić, Darjan Karabašević, Gabrijela Popović, Florentin Smarandache,
Predrag S. Stanimirović, Muzafer Saračević, Vasilios N. Katsikis (2022). A Single
Valued Neutrosophic Extension of the Simple WISP Method. *Informatica*, 17; DOI:
10.15388/22-INFOR483

Abstract. An extension of the Integrated Simple Weighted Sum Product (WISP) method is pre-sented in this article, customized for the application of single-valued neutrosophic numbers. The extension is suggested to take advantage that the application of neutrosophic sets provides in terms of solving complex decision-making problems, as well as decision-making problems associated with assessments, prediction uncertainty, imprecision, and so on. In addition, an adapted questionnaire and appropriate linguistic variables are also proposed in the article to enable a simpler and more precise collection of respondents' attitudes using single-valued neutrosophic numbers. An approach for deneutrosophication, i.e. the transformation of a single-valued neutrosophic number into a crisp number is also proposed in the article. Detailed use and characteristics of the presented improvement are shown on an example of the evaluation of rural tourist tours.

Key words: neutrosophic set, single-valued neutrosophic number, Simple WISP, deneutrosophication, MCDM.

1. Introduction

According to numerous similar definitions, multiple criteria decision-making (MCDM) is a process of evaluating or ranking alternatives based on a set of mutually conflicting criteria (Levy, 2005; Gebrezgabher *et al.*, 2014; Qin *et al.*, 2020; Ardil *et al.*, 2021). Similar definitions of MCDM can be found in Özdağoğlu *et al.* (2021) and Popovic (2021).

Since the end of the last century, MCDM has been used for solving many decision-making problems, and as a result, numerous MCDM methods have been proposed, such as SAW (MacCrimon, 1968), ELECTRE (Roy, 1968), AHP (Saaty, 1977), TOPSIS (Hwang and Yoon, 1981), PROMETHEE (Brans, 1982).

In addition to the mentioned MCDM methods, a significant emergence of newly proposed MCDM methods can also be observed, such as ARAS (Zavadskas and Turskis, 2010), WASPAS (Zavadskas *et al.*, 2012), EDAS (Keshavarz Ghorabae *et al.*, 2015), ARCAS method (Stanujkic *et al.*, 2017b), CoCoSo Yazdani *et al.* (2018), and so on.

However, it should be noted that the emergence of fuzzy sets, introduced by Zadeh (1965), had a significant impact on the use of the MCDM method. The fuzzy set theory enabled the use of a membership function $\mu_A(x)$, whose value lies in the interval $[0, 1]$, that is $\mu_A(x) \in [0, 1]$.

In order to solve the decision-making problems associated with uncertainties and predictions, many MCDM methods have been extended to allow the use of fuzzy numbers. However, the use of only one membership function did not allow solving some types of complex decision-making problems, which is why certain extensions of the fuzzy set theory were proposed, as, for example, interval-valued fuzzy sets (Turksen, 1986), intuitionistic fuzzy sets (Atanassov, 1986) and so on.

In intuitionistic fuzzy set theory, Atanassov (1986) originated the non-membership function $\nu_A(x)$, $\nu_A(x) \in [0, 1]$, with the following restriction $0 \leq \mu_A(x) + \nu_A(x) \leq 1$. As a logical sequence of the membership function in fuzzy sets, a non-membership function discloses non-membership to a set, thus having initiated a fundament for deal with a wider class of decision-making problems. Usage of two functions, the membership and the non-membership function, enabled solving more complex decision-making problems, which also caused the development of appropriate extensions of some MCDM methods.

The membership and non-membership functions in relation to an intuitionistic fuzzy set are also known as truth-membership and falsity-membership functions.

In 1998, Smarandache (1998) further extended fuzzy and intuitionistic fuzzy set theory by introducing the indeterminacy-membership function. Consequently, in neutrosophic set theory (Smarandache, 1998, 1999), each element of a set is defined by three independent membership functions: the truth-membership $T_A(x)$, the indeterminacy-membership $I_A(x)$, and the falsity-membership $F_A(x)$ functions, where the values of the mentioned functions are not limited to the interval $[0, 1]$, and there is also no restriction regarding their sum $0 \leq T_A(x) + I_A(x) + F_A(x) \leq 3^+$, as in intuitionistic fuzzy sets. Compared to fuzzy and intuitionistic fuzzy sets, neutrosophic sets are much more flexible and applicable for forming mathematical models designed for solving problems related to uncertainty, vagueness, ambiguity, imprecision, incompleteness, inconsistency, and so on (Smarandache, 1999; Ansari *et al.*, 2011).

To facilitate usage of neutrosophic sets for solving scientific and engineering problems, Wang *et al.* (2010) proposed a Single-Valued Neutrosophic (SVN) set, by introducing significantly stricter restrictions on the set of values that membership functions can have $T_A(x), I_A(x), F_A(x) : X \rightarrow [0, 1]$, as well as the sum of their values $0 \leq T_A(x) + I_A(x) + F_A(x) \leq 3$.

So far, numerous studies have been conducted to apply SVN sets for solving decision-making problems (Garg, 2020a, 2020b, 2020c, 2022), and as a result, they have been used to solve various problems in a number of decision-making areas such as the economy (Meng *et al.*, 2020), medicine (Zhang *et al.*, 2018; Abdel-Basset *et al.*, 2020), air quality evaluation (Li *et al.*, 2016; Bera and Mahapatra, 2021), and so on. Appropriate extensions that allow the use of SVN sets have also been proposed for a number of MCDM methods, such as TOPSIS (Biswas *et al.*, 2016), PROMETHEE (Xu *et al.*, 2020), AHP (Kahraman *et al.*, 2020), WASPAS (Zavadskas *et al.*, 2015), MULTIMOORA (Stanujkic *et al.*, 2017c), CoCoSo (Rani *et al.*, 2021), and so on.

Stanujkic *et al.* (2021) proposed a new MCDM method entitled the Integrated Simple Weighted Sum Product (WISP) method. Since there is no extension for this method that allows its use with SVN sets, an appropriate extension is provided in this research.

Therefore, the remaining sections are subject to the subsequent organization. In Section 2, some pivotal facts of the SVN sets, as well as some contents relevant to the development of a new improvement and extension of the WISP method are given. The single-valued neutrosophic extension of the WISP technique is presented in Section 3, while Section 4 presents the detailed use of the suggested extension on the example of selecting a rural tourist tour in Romania. Conclusions, limitations of the proposed extension and directions of further development are presented in the final section.

2. Introductory Observations

Some fundamental elements about neutrosophic sets, important for the development of the proposed extension, are presented in this section. In addition, some other contents that are also important for the development of the proposed extension are also discussed in this section.

2.1. The Basis of the Single-Valued Neutrosophic Sets

DEFINITION 1. Let X be the universe of discourse. A neutrosophic set A in X is an object with entries of the form (Smarandache, 1999)

$$A = \{x \langle T_A(x), I_A(x), F_A(x) \rangle \mid x \in X\}, \tag{1}$$

where: $T_A(x)$ denotes the truth-membership function, $I_A(x)$ denotes the indeterminacy-membership function, and $F_A(x)$ denotes the falsity-membership function, $T_A(x), I_A(x), F_A(x) : X \rightarrow]^{-}0, 1^{+}[$, and $^{-}0 \leq T_A(x) + I_A(x) + F_A(x) \leq 3^{+}$.

DEFINITION 2 (Wang *et al.*, 2010; Smarandache, 2005). If X is the universe of discourse, then the SVN set A in X is an object possessing the form

$$A = \{x \langle T_A(x), I_A(x), F_A(x) \rangle \mid x \in X\}, \tag{2}$$

where: $T_A(x), I_A(x), F_A(x) : X \rightarrow [0, 1]$, and $0 \leq T_A(x) + I_A(x) + F_A(x) \leq 3$.

DEFINITION 3. For an SVN set A in X , the triple $\langle t_A, i_A, f_A \rangle$ is called the SVN number (Smarandache, 1999).

DEFINITION 4. Let $x_1 = \langle t_1, i_1, f_1 \rangle$ and $x_2 = \langle t_2, i_2, f_2 \rangle$ be two SVN numbers and $\alpha > 0$. The basic operations on SVN numbers are as follows:

$$x_1 + x_2 = \langle t_1 + t_2 - t_1 t_2, i_1 i_2, f_1 f_2 \rangle, \tag{3}$$

$$x_1 \cdot x_2 = \langle t_1 t_2, i_1 + i_2 - i_1 i_2, f_1 + f_2 - f_1 f_2 \rangle, \tag{4}$$

$$\alpha \cdot x_1 = \langle 1 - (1 - t_1)^\alpha, i_1^\alpha, f_1^\alpha \rangle, \tag{5}$$

$$x_1^\alpha = \langle t_1^\alpha, i_1^\alpha, 1 - (1 - f_1)^\alpha \rangle. \tag{6}$$

DEFINITION 5. Let $x = \langle t, i, f \rangle$ be an SVN number. The score function $s_{(x)}$ of x is defined by Smarandache (2020)

$$s_{(x)} = \frac{t + (1 - i) + (1 - f)}{3} = \frac{2 + t - i - f}{3}, \tag{7}$$

where $s_{(x)} \in [0, 1]$.

DEFINITION 6. Let $x = \langle t, i, f \rangle$ be an SVN number. The reliability of the information $r_{(x)}$ included in x is defined by Stanujkic *et al.* (2020):

$$r_{(x)} = \begin{cases} \frac{|t-f|}{i+i+f} & t + i + f \neq 0, \\ 0 & t + i + f = 0, \end{cases} \tag{8}$$

where $r_{(x)} \in [0, 1]$.

DEFINITION 7. Let $A_{ij} = \langle t_{ij}, i_{ij}, f_{ij} \rangle$ be a stream of SVN numbers, $i = 1, 2, \dots, m$; $j = 1, 2, \dots, n$. Then the average reliability of the information $\bar{r}(A_{ij})$ contained in the collection of SVN numbers can be calculated as

$$\bar{r}(A_{ij}) = \sum_{i=1}^m \sum_{j=1}^n r_{(x)}, \tag{9}$$

where $r_{(x)}$ denotes the reliability of the information contained in an SVN number x .

DEFINITION 8. Let $A_j = \langle t_j, i_j, f_j \rangle$ be a cluster of SVN S s. The SVN Weighted Average (WA_{svn}) function of A_j is defined by Sahin (2014)

$$WA_{svn}(A_j) = \sum_{j=1}^n A_j w_j = \left\langle 1 - \prod_{j=1}^n (1 - t_j)^{w_j}, \prod_{j=1}^n i_j^{w_j}, \prod_{j=1}^n f_j^{w_j} \right\rangle, \quad (10)$$

where w_j denotes the weight of element j of the collection A_j , $w_j \in [0, 1]$, and $\sum_{j=1}^n w_j = 1$.

DEFINITION 9. Let $A_j = \langle t_j, i_j, f_j \rangle$ be a set of SVN S s. The SVN Weighted Geometric (WG_{svn}) operator of A_j is defined by Sahin (2014)

$$WG_{svn}(A_j) = \prod_{j=1}^n A_j^{w_j} = \left\langle \prod_{j=1}^n t_j^{w_j}, 1 - \prod_{j=1}^n (1 - i_j)^{w_j}, 1 - \prod_{j=1}^n (1 - f_j)^{w_j} \right\rangle, \quad (11)$$

where w_j means a weight corresponding to the element j of the collection A_j , $w_j \in [0, 1]$, and $\sum_{j=1}^n w_j = 1$.

2.2. Questionnaire Designed for Using SVN Numbers

The use of SVN numbers for collecting respondents' attitudes also requires the use of a specially designed questionnaire. It has already been stated that SVN numbers use three membership functions, which allows the use of complex evaluation criteria. Instead of using ordinary questionnaires based on questions prepared for collecting ratings of alternatives concerning the selected criteria, the proposed questionnaire uses affirmative sentences whose truthfulness should be assessed using three membership functions.

For example, the first criterion, used in numerical illustration, Destination attractiveness, integrates the natural attractions of a tourist destination, such as natural beauties, mountain ranges, lakes, rivers, landscapes, environmental protection, diversity of flora and fauna, and others. Using the three affiliation functions provided by neutrosophic numbers, the respondent can express the level of his agreement with the confirmatory sentence, the level of his disagreement, and the level of his uncertainty regarding the statements included in the confirmatory sentence. It should be noted that the evaluation based on the use of SVN numbers does not require the mandatory use of all three membership functions for evaluation. Depending on their opinions, respondents can use three, two, or even one membership function. In cases when one or two membership functions are not used in the evaluation the values of unused membership functions are automatically set to value 0.

Finally, using Eq. (9), the average reliability of the information collected from the respondents can be assessed, and based on that a decision can be made on the usability of the questionnaire, i.e. its use for evaluation or its rejection as useless.

Table 1
Linguistic variables for expressing confidence levels.

Linguistic variable	Abbreviation	Crisp numerical value	Permissible value range
Extremely High	EH	9	[8, 10]
Very High	VH	8	[7, 9]
High	H	7	[6, 8]
Moderate High	MH	6	[5, 7]
Moderate	M	5	[4, 6]
Moderate Low	ML	4	[3, 5]
Low	L	3	[2, 4]
Very Low	VL	2	[1, 3]
Extremely Low	EL	1	[0, 2]

2.3. Linguistic Variables

Linguistic variables are often used in various extensions of grey, fuzzy, intuitionistic fuzzy, and neutrosophic extensions of MCDM methods to facilitate and enable decision-makers, i.e. respondents, to more accurately evaluate alternatives.

For the purposes of this research, the following nine-point scale, shown in Table 1, was chosen.

In addition to the use of linguistic variables, i.e. their abbreviations, respondents can express their attitudes using the recommended crisp numerical values. However, if they want it or it is necessary, the respondents can express their attitudes more precisely using numbers from the interval [0, 10].

2.4. Deneutrosophication

Similar to defuzzification in fuzzy sets, in the neutrosophy, a deneutrosophication is the process of transforming information contained in neutrosophic numbers into crisp values.

The transformation of neutrosophic information into a crisp value can be easily performed using Eq. (7). However, much better results, primarily in terms of analysis of different scenarios, can be achieved by applying the following equation:

$$df_{(x)} = \frac{2 + \alpha t - \beta i - \gamma f}{3}, \tag{12}$$

where: $x = \langle t, i, f \rangle$ is an SVN, $\alpha, \beta,$ and γ are coefficients, and $\alpha, \beta, \gamma \in [0, 1]$.

In the case when all three coefficients tend to a value of one, $\alpha, \beta, \gamma \cong 1$, Eq. (12) gives similar values as Eq. (7). In contrast, when all three values of the coefficients tend to zero, $\alpha, \beta, \gamma \cong 0$, all the information contained in the neutrosophic numbers is meaningless.

3. A Single-Valued Neutrosophic Extension of the WISP method

The Simple WISP method was proposed in Stanujkic *et al.* (2021). Based on this method, a procedure for ranking alternatives based on using SVNns can be presented using the following steps:

Step 1. Construct a single-valued neutrosophic initial decision-making matrix and determine criteria weights. In this step, the single-valued neutrosophic initial decision matrix is formed using linguistic variables proposed in Section 2.3. Criteria weights can be determined using some of several MCDM methods primarily intended for specifying criteria weights such as the AHP method (Saaty, 1980), SWARA method (Kersulienne *et al.*, 2010), Best-Worst method (Rezaei, 2015), or PIPRECIA method (Stanujkic *et al.*, 2017a).

Step 2. Generate a normalized intuitionistic decision-making matrix as

$$r_{ij} = \langle t_{ij}, i_{ij}, f_{ij} \rangle = \left\langle \frac{xt_{ij}}{10}, \frac{xi_{ij}}{10}, \frac{xf_{ij}}{10} \right\rangle, \tag{13}$$

where: xt_{ij} , xi_{ij} and xf_{ij} denote the affiliation level of alternative i regarding criterion j expressed using three membership functions, respectively.

Denominators used in Eq. (13) were chosen according to the 9-point linguistic scale proposed in Table 1.

Step 3. Compute the sum and product of the weight-normalized neutrosophic performance of each alternative, for the beneficial and non-beneficial criteria, using Eqs. (10) and (11), as follows:

$$S_i^{\max} = \left\langle 1 - \prod_{j \in \phi_{\max}} (1 - t_j)^{w_j}, \prod_{j \in \phi_{\max}} i_j^{w_j}, \prod_{j \in \phi_{\max}} f_j^{w_j} \right\rangle, \tag{14}$$

$$S_i^{\min} = \left\langle 1 - \prod_{j \in \phi_{\min}} (1 - t_j)^{w_j}, \prod_{j \in \phi_{\min}} i_j^{w_j}, \prod_{j \in \phi_{\min}} f_j^{w_j} \right\rangle, \tag{15}$$

$$P_i^{\max} = \left\langle \prod_{j \in \phi_{\max}} t_j^{w_j}, 1 - \prod_{j \in \phi_{\max}} (1 - i_j)^{w_j}, 1 - \prod_{j \in \phi_{\max}} (1 - f_j)^{w_j} \right\rangle, \tag{16}$$

$$P_i^{\min} = \left\langle \prod_{j \in \phi_{\min}} t_j^{w_j}, 1 - \prod_{j \in \phi_{\min}} (1 - i_j)^{w_j}, 1 - \prod_{j \in \phi_{\min}} (1 - f_j)^{w_j} \right\rangle, \tag{17}$$

where: $S_i^{\max} = \langle t_i, i_i, f_i \rangle$ and $S_i^{\min} = \langle t_i, i_i, f_i \rangle$ denote the sum of the weight-normalized neutrosophic performances of alternative i , achieved based on beneficial and non-beneficial criteria, respectively, and $P_i^{\max} = \langle t_i, i_i, f_i \rangle$ and $P_i^{\min} = \langle t_i, i_i, f_i \rangle$ denote the product of the weight-normalized neutrosophic performances of alternative i , achieved based on beneficial and non-beneficial criteria, respectively, ϕ_{\max} and ϕ_{\min} denote sets of beneficial and nonbeneficial criteria, respectively.

Step 4. Calculate the values of four utility measures u_i^{sd} , u_i^{pd} , u_i^{sr} , and u_i^{pr} . The subtraction and division operations required for determining the four utility measures used in the WISP method are not primarily defined for SVNNS. Therefore, values of S_i^{\max} , S_i^{\min} , P_i^{\max} , and P_i^{\min} , should be transformed into crisp values before calculating the four utility measures.

Deneutrosophication can be performed using Eq. (7) or Eq. (12), after which the values of the four utility measures can be calculated as follows:

$$u_i^{sd} = S_i^{\max} - S_i^{\min}, \tag{18}$$

$$u_i^{pd} = P_i^{\max} - P_i^{\min}, \tag{19}$$

$$u_i^{sr} = \frac{S_i^{\max}}{S_i^{\min}}, \quad \text{and} \tag{20}$$

$$u_i^{pr} = \frac{P_i^{\max}}{P_i^{\min}}. \tag{21}$$

Step 5. Recalculate values of four utility measures, as follows:

$$\vartheta_i^{sd} = \frac{1 + u_i^{sd}}{1 + \max_i u_i^{sd}}, \tag{22}$$

$$\vartheta_i^{pd} = \frac{1 + u_i^{pd}}{1 + \max_i u_i^{pd}}, \tag{23}$$

$$\vartheta_i^{sr} = \frac{1 + u_i^{sr}}{1 + \max_i u_i^{sr}}, \quad \text{and} \tag{24}$$

$$\vartheta_i^{pr} = \frac{1 + u_i^{pr}}{1 + \max_i u_i^{pr}}, \tag{25}$$

where: ϑ_i^{sd} , ϑ_i^{pd} , ϑ_i^{sr} , and ϑ_i^{pr} denote recalculated values of u_i^{sd} , u_i^{pd} , u_i^{sr} and u_i^{pr} , respectively, and $\max_i u_i^{sd}$, $\max_i u_i^{pd}$, $\max_i u_i^{sr}$ and $\max_i u_i^{pr}$ denote the maximum values of the right end points of four utility measures, respectively.

Step 6. Evaluate the total utility ϑ_i for each alternative by the rule

$$\vartheta_i = \frac{1}{4}(\vartheta_i^{sd} + \vartheta_i^{pd} + \vartheta_i^{sr} + \vartheta_i^{pr}). \tag{26}$$

Step 7. Rank available alternatives and choose the most justifiable one. In cases of evaluating alternatives in the Simple WISP method, the alternative with the highest overall utility is the most admissible one.

Using the approach presented above, decision-makers can take advantage of the previously discussed benefits that SVN sets provide when gathering respondents' attitudes. Also, using Eq. (12) decision-makers can vary the impact of truth, indeterminacy, and falsity membership functions and consider different scenarios, from very pessimistic to very optimistic. The possibility of considering different scenarios candidates the proposed approach for using in the process of the project evaluation and selection where it is important and necessary to overview every circumstance that may occur.

4. An Illustrative Example

In order to give a demonstration of the applicability of the presented extension of the WISP procedure, one example of selecting a tourist destination for Nature & Rural Tourism was considered.

After considering alternatives from Serbia, Montenegro, Albania, Bulgaria, and Romania, it is determined that the demonstration was carried out on the example of choosing a tourist tour of Natural and Rural Tourism in Romania. One of the main reasons for choosing Romania was a wealth of useful information regarding tourist tours, including a wealth of photographs that enchant the natural beauties of the Transylvania region located in central Romania.

To attest the applicability of the proposed extension of the WISP method, an example of evaluation of a tourist destination, that is evaluation of rural tourist tours, is discussed in this section. The evaluation of several below mentioned alternatives was performed according to the following criteria:

- C_1 , Destination attractiveness,
- C_2 , Additional facilities,
- C_3 , Accommodation and comfort,
- C_4 , Transportation and accessibility, and
- C_5 , Price.

The evaluation criteria were selected based on the criteria proposed by Ryglova *et al.* (2017). In their research, Ryglova *et al.* (2017) considered the application, i.e. significance, of 19 criteria for determining the quality of rural tourism destinations. However, the use of a large number of evaluation criteria, without their hierarchical organization, maybe impractical for MCDM evaluation. In addition, the use of three membership functions allows utilization of a smaller number of complex criteria, which is why more significant criteria considered by Ryglova *et al.* (2017) are aggregated to the previously mentioned five criteria.

The meaning of the above criteria can be described as follows: the criterion Destination attractiveness includes the presence of natural attractions, mountain ranges, lakes, rivers, landscapes, beauties of untouched nature, diversity of flora and fauna, and so on. The criterion Additional facilities include facilities such as hiking, climbing, visiting man-made facilities such as castles and fortifications, cultural and social attractions, and so on, while the criterion Accommodation and comfort include the type of accommodation and additional amenities such as the Internet, Wi-Fi, television, and so on. The criterion Transportation and accessibility includes the way of arriving at the starting points of the tourist tour from the residence of the respondents. Finally, since the considered tours have different durations, the Price criterion is considered as a complex criterion that includes the price on a daily basis and the total price of the tourist tour.

In this research, the following rural tourist tours were selected for evaluation:

- Wildlife Tour in Romania,
- Family Tour of Romania,

Table 2
The questionnaire obtained from the selected respondent.

	C ₁			C ₂			C ₃			C ₄			C ₅		
	t	i	f	t	i	f	t	i	f	t	i	f	t	i	f
A ₁	6.5	EL	1.5	M		EL	5.5			ML	1.5	M			2.5
A ₂	VH			VH		EL	MH			M			VL	0.5	6.5
A ₃	MH		EL	EH	EL	VL	ML	EL	VL	ML			L		MH
A ₄	MH		0.7	VH	EL	EL	L	ML	ML	ML			L		M
A ₅	EH			VH		EL	M	VL	EL	VH			ML	0.5	M
A ₆	EH			H			H	VL	VL	VH			ML		VH

Table 3
A transformed questionnaire with the attitudes of the selected respondent.

	C ₁			C ₂			C ₃			C ₄			C ₅		
	t	i	f	t	i	f	t	i	f	t	i	f	t	i	f
A ₁	6.5	1	1.5	5	0	1	5.5	0	0	4	0	1.5	5	0	2.5
A ₂	8	0	0	8	0	1	6	0	0	5	0	0	2	0.5	6.5
A ₃	6	0	1	9	1	2	4	1	2	4	0	0	3	0	6
A ₄	6	0	0.7	8	1	1	3	4	4	4	0	0	3	0	5
A ₅	9	0	0	8	0	1	5	2	1	8	0	0	4	0.5	5
A ₆	9	0	0	7	0	0	7	2	2	8	0	0	4	0	8

- Maramures and Bucovina Tour, and
- 4-Day Carpathian Trek: Bucegi Mountains and Piatra Craiului National Park,
- Village Life in Transylvanian Carpathian Mountains, and
- 14 Days Full Donau Delta, Braşov and Apuseni Tour.

Information regarding the above rural tourist tours is available on the following web-sites:

- <https://true-romania.tours/rural-tourism/> (True-Romania) and,
- <https://www.viator.com/Romania-tours/Nature-and-Wildlife/> (Romania-tours).

The evaluation of alternatives, i.e. checking the usability and efficacy of the proposed procedure, was done on a small number of respondents. More precisely, the examination was performed on a sample of fifteen examinees. From the collected questionnaires, one characteristic was chosen to show in detail the steps of the proposed calculation procedure.

The completed questionnaire with the attitudes of the selected respondents, filled in with the combined use of linguistic variables and numbers, is shown in Table 2. After the transformation of linguistic variables into numerical values, as well as filling in the values of unused membership functions, the transformed questionnaire is shown in Table 3.

A normalized intuitionistic decision matrix, generated utilizing Eq. (12), is arranged in Table 4. The average reliability of the data contained in the SVNNS in Table 4, determined using Eq. (9), is 0.674.

For further applying the proposed calculation procedure, the weights of the criteria are necessary after this step. In the observed case, the weights of criteria were defined

Table 4
A normalized intuitionistic decision-making matrix.

	C_1	C_2	C_3	C_4	C_5
A_1	(0.7, 0.1, 0.2)	(0.5, 0.0, 0.1)	(0.6, 0.0, 0.0)	(0.4, 0.0, 0.2)	(0.5, 0.0, 0.3)
A_2	(0.8, 0.0, 0.0)	(0.8, 0.0, 0.1)	(0.6, 0.0, 0.0)	(0.5, 0.0, 0.0)	(0.2, 0.1, 0.7)
A_3	(0.6, 0.0, 0.1)	(0.9, 0.1, 0.2)	(0.4, 0.1, 0.2)	(0.4, 0.0, 0.0)	(0.3, 0.0, 0.6)
A_4	(0.6, 0.0, 0.1)	(0.8, 0.1, 0.1)	(0.3, 0.4, 0.4)	(0.4, 0.0, 0.0)	(0.3, 0.0, 0.5)
A_5	(0.9, 0.0, 0.0)	(0.8, 0.0, 0.1)	(0.5, 0.2, 0.1)	(0.8, 0.0, 0.0)	(0.4, 0.1, 0.5)
A_6	(0.9, 0.0, 0.0)	(0.7, 0.0, 0.0)	(0.7, 0.2, 0.2)	(0.8, 0.0, 0.0)	(0.4, 0.0, 0.8)

Table 5
The weights of the criteria.

	C_1	C_2	C_3	C_4	C_5
w_j	0.23	0.18	0.20	0.18	0.22

Table 6
Sums and products of weight-normalized neutrosophic ratings of alternatives achieved based on beneficial and non-beneficial criteria.

	S_i^{\max}	S_i^{\min}	P_i^{\max}	P_i^{\min}
A_1	(0.39, 0.00, 0.00)	(0.14, 0.00, 0.73)	(0.61, 1.00, 1.00)	(0.86, 1.00, 0.27)
A_2	(0.27, 0.00, 0.00)	(0.30, 0.51, 0.91)	(0.73, 1.00, 1.00)	(0.70, 0.49, 0.09)
A_3	(0.38, 0.00, 0.00)	(0.23, 0.00, 0.89)	(0.62, 1.00, 1.00)	(0.77, 1.00, 0.11)
A_4	(0.43, 0.00, 0.00)	(0.23, 0.00, 0.86)	(0.57, 1.00, 1.00)	(0.77, 1.00, 0.14)
A_5	(0.21, 0.00, 0.00)	(0.18, 0.51, 0.86)	(0.79, 1.00, 1.00)	(0.82, 0.49, 0.14)
A_6	(0.18, 0.00, 0.00)	(0.18, 0.00, 0.95)	(0.82, 1.00, 1.00)	(0.82, 1.00, 0.05)

by means of the PIPRECIA method. The weights calculated based on the attitudes of the selected respondent are shown in Table 5.

After determining criteria weights, the sums and products of weighted normalized neutrosophic ratings of the alternatives were calculated, for beneficial and non-beneficial criteria, as presented in Table 6.

Deneutrosophied values of sums and products of the weighted normalized neutrosophic ratings are shown in Table 7. In this case, deneutrosophization, i.e. transformation of SVNNS into crisp values, was performed using Eq. (7), but it can also be performed using Eq. (12), as mentioned above.

The values of four utility measures u_i^{sd} , u_i^{pd} , u_i^{sr} , and u_i^{pr} , calculated using Eqs. (18) to (21) are also shown in Table 7.

The recalculated values of four utility measures ϑ_i^{sd} , ϑ_i^{pd} , ϑ_i^{sr} , and ϑ_i^{pr} are shown in Table 8.

As it can be concluded on the basis of data in Table 8, the alternative A_5 is the most suitable rural tourist tour, based on the attitudes obtained from the selected respondent. From Table 8, it can also be observed that all considered alternatives have approximately similar values of the overall utilities, which indicates that the use of Eq. (12), for deneutrosophization, could cause changes in the ranking order of considered alternatives.

Table 7
Deneutrosophied values of sums and products of weighted normalized neutrosophic ratings.

	S_i^{\max}	S_i^{\min}	P_i^{\max}	P_i^{\min}	u_i^{sd}	u_i^{pd}	u_i^{sr}	u_i^{pr}
A ₁	0.80	0.47	0.20	0.53	0.33	-0.33	1.70	0.38
A ₂	0.76	0.29	0.24	0.71	0.46	-0.46	2.58	0.34
A ₃	0.79	0.45	0.21	0.55	0.35	-0.35	1.77	0.37
A ₄	0.81	0.46	0.19	0.54	0.35	-0.35	1.76	0.35
A ₅	0.74	0.27	0.26	0.73	0.47	-0.47	2.72	0.36
A ₆	0.73	0.41	0.27	0.59	0.32	-0.32	1.77	0.46

Table 8
Recalculated values of four utility measures, overall utility measures, and ranking order of alternatives.

	ϑ_i^{sd}	ϑ_i^{pd}	ϑ_i^{sr}	ϑ_i^{pr}	ϑ_i	Rank
A ₁	0.91	0.98	0.73	0.94	0.889	5
A ₂	1.00	0.78	0.96	0.92	0.916	2
A ₃	0.92	0.96	0.75	0.94	0.889	4
A ₄	0.92	0.95	0.74	0.92	0.884	6
A ₅	1.00	0.78	1.00	0.93	0.927	1
A ₆	0.90	1.00	0.74	1.00	0.910	3

Similar evaluations, done again with the attitudes of the remaining respondents, showed that there were some differences in the ranks of considered alternatives, which was expected. However, it also emphasizes the need for developing a neutrosophic extension of the WISP method that can be used for group decision-making. Unfortunately, the development of such an extension has not yet been considered.

Numerous articles and studies dealing with the application of MCDM methods in the tourism and hospitality industry can be found in scientific and professional journals. A comprehensive overview of previously conducted research in this area can be found in Ahmad (2016).

A similar approach to choosing a tourist destination was considered in Genç and Filipe (2016), where they applied a fuzzy MCDM approach for evaluating a tourist destination in Portugal. Besides, Alptekin and Büyüközkan (2011) considered the use of MCDM system for web-based tourism destination planning, while Peng and Tzeng (2012) considered the use of MCDM model for evaluating strategies for promoting tourism competitiveness. Stanujkic *et al.* (2015, 2019) evaluate the quality of websites in a rural tourism and hospitality industry using Atanassov intuitionistic fuzzy sets, bipolar neutrosophic sets. Popovic *et al.* (2021) applied the PIPRECIA model for identifying key determinants of tourism development in Serbia while Hosseini and Paydar (2022) prioritized the factors affecting tourist absorption for ecotourism centres using MCDM methods.

5. Conclusion

An upgrading of the Simple WISP method based on the usage of single-valued neutrosophic numbers is proposed in this article.

The SVN numbers use three membership functions for expressing truth, indeterminacy, and falsity which is why they can be used for expressing beliefs, uncertainties, and doubts about some occurrences, conditions, or events. For this reason, these numbers can be very useful for collecting respondents' attitudes because they provide respondents with a very flexible way of expressing attitudes. It is known that the three membership functions are mutually independent and that each function can have a value from the interval $[0, 1]$. Based on this, respondents can express their preferences using three zeros or three ones, or with any other combination of numbers from the interval $[0, 1]$.

The use of SVN numbers for collecting respondents' attitudes also allows the use of complex criteria for evaluating alternatives. Of course, the use of these numbers requires the use of customized questionnaires, as well as adapted linguistic variables for expressing the respondents' preferences, which are also discussed in the article.

Some initial research conducted during the development of the proposed approach pointed to certain problems related to the collection of attitudes from respondents who are not familiar with the use of neutrosophic sets. The questionnaire proposed in this article is certainly not suitable for collecting the views of respondents "on the street", but can be used to collect the views of respondents who are familiar with the basic elements of fuzzy, intuitionistic, and neutrosophic sets.

Therefore, the intention to conduct a study with a significantly larger number of respondents using the proposed approach can be stated as one of the directions of future research. Adoption of the proposed approach for use in a group decision-making environment can also be mentioned as one of the further potential directions of research regarding the proposed approach.

An approach for deneutrosophication, i.e. the transformation of information contained in SVN numbers into crisp numbers is also considered in the article. Using this approach, decision-makers can analyse a variety of scenarios, from pessimistic to optimistic, similar as in many fuzzy and intuitionistic extensions of other MCDM methods.

Using the proposed approach, decision-makers can take advantage of the fact SVN sets provide for gathering respondents' attitudes based on a smaller number of complex evaluation criteria. Also, using approach proposed for deneutrosophication, decision-makers can vary the impact of truth, indeterminacy, and falsity membership functions and consider different scenarios, from very pessimistic to very optimistic. And finally, the evaluations performed with the proposed extension of the Simple WISP method confirmed its applicability and efficiency.

Besides the outlined usefulness of the proposed approach, it could not be denied that it has some limitations, as well. Maybe the crucial shortcoming of the proposed approach reflects in its complexity for application by ordinary decision-makers that are not familiar with neutrosophic sets logic. In that sense, its application is limited only to those decision-makers who understand and successfully work with this type of decision-making aiding technique.

The results of conducted research proved the reliability and usability of the proposed extension, so it is considered that it would be also an adequate decision-making aid in other business fields such as project management, human resource management, production

management, and so on. Besides, the recommendation of the future work involves the proposing of the extension of the WISP method based on the multi-valued neutrosophic numbers to acknowledge the vagueness and uncertainty of the environment to a greater extent.

References

- Abdel-Basset, M., Gamal, A., Manogaran, G., Son, L.H., Long, H.V. (2020). A novel group decision making model based on neutrosophic sets for heart disease diagnosis. *Multimedia Tools and Applications*, 79(15), 9977–10002.
- Ahmad, U. (2016). Application of multiple criteria decision making techniques in tourism and hospitality industry: a systematic review. *Transformations in Business & Economics*, 15(1), 37.
- Alptekin, G.I., Büyükožkan, G. (2011). An integrated case-based reasoning and MCDM system for Web based tourism destination planning. *Expert Systems with Applications*, 38(3), 2125–2132.
- Ansari, A.Q., Biswas, R., Aggarwal, S. (2011). Proposal for applicability of neutrosophic set theory in medical AI. *International Journal of Computer Applications*, 27(5), 5–11.
- Ardil, C., Pashaev, A.M., Sadiqov, R.A., Abdullayev, P. (2021). Multiple criteria decision making analysis for selecting and evaluating fighter aircraft. *International Journal of Transport and Vehicle Engineering*, 13(11), 683–694.
- Atanassov, K.T. (1986). Intuitionistic fuzzy sets. *Fuzzy sets and systems*, 20(1), 87–96.
- Bera, T., Mahapatra, N.K. (2021). Ranking of thermal power plants focusing on air pollution: a neutrosophic assessment. *Journal of Cleaner Production*, 316, 128250.
- Biswas, P., Pramanik, S., Giri, B.C. (2016). TOPSIS method for multi-attribute group decision-making under single-valued neutrosophic environment. *Neural computing and Applications*, 27(3), 727–737.
- Brans, J.P. (1982). L'ingénierie de la décision. Elaboration d'instruments d'aide à la décision. Méthode PROMETHEE. In: Nadeau, R., Landry, M. (Eds.), *L'aide à la Décision: Nature, Instruments et Perspectives d'avenir*. Presses de l'Université, Laval, Québec, Canada, pp. 183–214.
- Garg, H. (2020a). Decision making analysis based on sine trigonometric operational laws for single-valued neutrosophic sets and their applications. *Applied and Computational Mathematics*, 19(2), 255–276.
- Garg, H. (2020b). Multiple attribute decision making based on immediate probabilities aggregation operators for single-valued and interval neutrosophic sets. *Journal of Applied Mathematics and Computing*, 63(1), 619–653.
- Garg, H. (2020c). Novel neutrality aggregation operators-based multiattribute group decision making method for single-valued neutrosophic numbers. *Soft Computing*, 24(14), 10327–10349.
- Garg, H. (2022). SVNMPR: a new single-valued neutrosophic multiplicative preference relation and their application to decision-making process. *International Journal of Intelligent Systems*, 37(3), 2089–2130.
- Gebrezgabher, S.A., Meuwissen, M.P., Lansink, A.G.O. (2014). A multiple criteria decision making approach to manure management systems in the Netherlands. *European Journal of Operational Research*, 232(3), 643–653.
- Genç, T., Filipe, J.A. (2016). A fuzzy MCDM approach for choosing a tourism destination in Portugal. *International Journal of Business and Systems Research*, 10(1), 23–44.
- Hosseini, S.M., Paydar, M.M. (2022). Examining and prioritizing the factors affecting tourist absorption for ecotourism centers utilizing MCDM tools. *Journal of Optimization in Industrial Engineering*, 15(1), 17–30.
- Hwang, C.L., Yoon, K. (1981). *Multiple Attribute Decision Making Methods and Applications*. Springer-Verlag, Berlin.
- Kahraman, C., Oztaysi, B., Cevik Onar, S. (2020). Single & interval-valued neutrosophic AHP methods: performance analysis of outsourcing law firms. *Journal of Intelligent & Fuzzy Systems*, 38(1), 749–759.
- Keršulienė, V., Zavadskas, E.K., Turskis, Z. (2010). Selection of rational dispute resolution method by applying new step-wise weight assessment ratio analysis (SWARA). *Journal of Business Economics and Management*, 11(2), 243–258.
- Keshavarz Ghorabae, M., Zavadskas, E.K., Olfat, L., Turskis, Z. (2015). Multi-criteria inventory classification using a new method of Evaluation Based on Distance from Average Solution (EDAS). *Informatica*, 26(3), 435–451.

- Levy, J.K. (2005). Multiple criteria decision making and decision support systems for flood risk management. *Stochastic Environmental Research and Risk Assessment*, 19(6), 438–447.
- Li, Y., Liu, P., Chen, Y. (2016). Some single valued neutrosophic number heronian mean operators and their application in multiple attribute group decision making. *Informatica*, 27(1), 85–110.
- MacCrimon, K.R. (1968). Decision Making among Multiple Attribute Alternatives: A Survey and Consolidated Approach. *Rand memorandum*. RM-4823-ARPA.
- Meng, F., Tang, J., Zhang, S., Xu, Y. (2020). Public-private partnership decision making based on correlation coefficients of single-valued neutrosophic hesitant fuzzy sets. *Informatica*, 31(2), 359–397.
- Özdağoğlu, A., Keleş, M.K., nata A, A., Ulutaş, A. (2021). Combining different MCDM methods with the Copeland method: an investigation on motorcycle selection. *Journal of Process Management and New Technologies*, 9(3–4), 13–27.
- Peng, K.H., Tzeng, G.H. (2012). Strategies for promoting tourism competitiveness using a hybrid MCDM model. In: *Intelligent Decision Technologies*. Springer, Berlin, Heidelberg, pp. 107–115.
- Popovic, G., Stanujkic, D., Mimovic, P., Milovanovic, G., Karabasevic, D., Brzakovic, P., Brzakovic, A. (2021). An integrated SWOT–extended PIPRECIA model for identifying key determinants of tourism development: the case of Serbia. *Acta Geographica Slovenica*, 61(2), 23–40.
- Popovic, M. (2021). An MCDM approach for personnel selection using the CoCoSo method. *Journal of Process Management and New Technologies*, 9(3–4), 78–88.
- Qin, Y., Qi, Q., Shi, P., Scott, P.J., Jiang, X. (2020). Novel operational laws and power Muirhead mean operators of picture fuzzy values in the framework of Dempster–Shafer theory for multiple criteria decision making. *Computers & Industrial Engineering*, 149, 106853.
- Rani, P., Ali, J., Krishankumar, R., Mishra, A.R., Cavallaro, F., Ravichandran, K.S. (2021). An integrated single-valued neutrosophic combined compromise solution methodology for renewable energy resource selection problem. *Energies*, 14(15), 4594.
- Rezaei, J. (2015). Best-worst multi-criteria decision-making method. *Omega*, 53, 49–57.
- Romania-tours Available online: <https://www.viator.com/Romania-tours/Nature-and-Wildlife/> (accessed on 29 September 2021).
- Roy, B. (1968). Classement et choix en présence de points de vue multiples. *Revue française d'informatique et de recherche opérationnelle*, 2(8), 57–75.
- Ryglóva, K., Rasovská, I., Sacha, J. (2017). Rural tourism-evaluating the quality of destination. *European Countryside*, 9(4), 769–788.
- Saaty, T.L. (1977). A scaling method for priorities in hierarchical structures. *Journal of Mathematical Psychology*, 15(3), 234–281.
- Saaty, L.T. (1980). *The Analytic Hierarchy Process*. McGraw Hill Company, New York, NY, USA.
- Sahin, R. (2014). Multi-criteria neutrosophic decision making method based on score and accuracy functions under neutrosophic environment. *Preprint*. arXiv:1412.5202.
- Smarandache, F. (1998). *Neutrosophy Probability Set and Logic*. American Research Press, Rehoboth.
- Smarandache, F. (1999). *A Unifying Field in Logics. Neutrosophy: Neutrosophic Probability, Set and Logic*. American Research Press, Rehoboth.
- Smarandache, F. (2005). Neutrosophic set—a generalization of the intuitionistic fuzzy set. *International Journal of Pure and Applied Mathematics*, 24(3), 287.
- Smarandache, F. (2020). The score, accuracy, and certainty functions determine a total order on the set of neutrosophic triplets (T, I, F). *Neutrosophic Sets and Systems*, 38(1), 1–14.
- Stanujkic, D., Zavadskas, K.E., Tamošaitienė, J. (2015). An approach to measuring website quality in the rural tourism industry based on Atanassov intuitionistic fuzzy sets. *E+M Ekonomie a Management*, 18(4), 461–470.
- Stanujkic, D., Zavadskas, E.K., Karabasevic, D., Smarandache, F., Turskis, Z. (2017a). The use of the pivot pairwise relative criteria importance assessment method for determining the weights of criteria. *Romanian Journal of Economic Forecasting*, 20, 116–133.
- Stanujkic, D., Zavadskas, E.K., Karabasevic, D., Turskis, Z., Keršulienė, V. (2017b). New group decision-making ARCAS approach based on the integration of the SWARA and the ARAS methods adapted for negotiations. *Journal of Business Economics and Management*, 18(4), 599–618.
- Stanujkic, D., Zavadskas, E.K., Smarandache, F., Brauers, W.K., Karabasevic, D. (2017c). A neutrosophic extension of the MULTIMOORA method. *Informatica*, 28(1), 181–192.
- Stanujkic, D., Karabasevic, D., Smarandache, F., Zavadskas, E.K., Maksimovic, M. (2019). An innovative approach to evaluation of the quality of websites in the tourism industry: a novel MCDM approach based on

- bipolar neutrosophic numbers and the hamming distance. *Transformations in Business & Economics*, 18, 1(46), 149–162.
- Stanujkic, D., Karabasevic, D., Smarandache, F., Popovic, G. (2020). A novel approach for assessing the reliability of data contained in a single valued neutrosophic number and its application in multiple criteria decision making. *International Journal of Neutrosophic Science*, 11(1), 22–29.
- Stanujkic, D., Popovic, G., Karabasevic, D., Meidute-Kavaliauskiene, I., Ulutaş, A. (2021). An Integrated Simple Weighted Sum Product Method – WISP. In: *IEEE Transactions on Engineering Management*, 1–12.
- True-Romania Available online: <https://true-romania.tours/rural-tourism/> (accessed on 27 September 2021).
- Turksen, I.B. (1986). Interval valued fuzzy sets based on normal forms. *Fuzzy Sets and Systems*, 20(2), 191–210.
- Wang, H., Smarandache, F., Zhang, Y., Sunderraman, R. (2010). Single valued neutrosophic sets. *Review of the Air Force Academy*, 1(16), 10–14.
- Xu, D., Wei, X., Ding, H., Bin, H. (2020). A new method based on PROMETHEE and TODIM for multi-attribute decision-making with single-valued neutrosophic sets. *Mathematics*, 8(10), 1816.
- Yazdani, M., Zarate, P., Zavadskas, E.K., Turskis, Z. (2018). A Combined Compromise Solution (CoCoSo) method for multi-criteria decision-making problems. *Management Decision*, 57(3), 2501–2519.
- Zadeh, L.A. (1965). Fuzzy sets. *Information and Control*, 8(3), 338–353.
- Zavadskas, E.K., Turskis, Z. (2010). A new additive ratio assessment (ARAS) method in multicriteria decision making. *Technological and Economic Development of Economy*, 16(2), 159–172.
- Zavadskas, E.K., Turskis, Z., Antucheviciene, J., Zakarevicius, A. (2012). Optimization of weighted aggregated sum product assessment. *Elektronika ir elektrotechnika*, 122(6), 3–6.
- Zavadskas, E.K., Baušys, R., Lazauskas, M. (2015). Sustainable assessment of alternative sites for the construction of a waste incineration plant by applying WASPAS method with single-valued neutrosophic set. *Sustainability*, 7(12), 15923–15936.
- Zhang, C., Li, D., Broumi, S., Sangaiah, A.K. (2018). Medical diagnosis based on single-valued neutrosophic probabilistic rough multisets over two universes. *Symmetry*, 10(6), 213.

EXTENICS

Generalizations of the Distance and Dependent Function in Extenics to 2D, 3D, and $n - D$

Florentin Smarandache

Florentin Smarandache (2012). Generalizations of the Distance and Dependent Function in Extenics to 2D, 3D, and n-D. *Progress in Physics* 3, 54-61

Dr. Cai Wen defined in his 1983 paper: — the distance formula between a point x_0 and a one-dimensional (1D) interval $\langle a, b \rangle$; — and the dependence function which gives the degree of dependence of a point with respect to a pair of included 1D-intervals. His paper inspired us to generalize the Extension Set to two-dimensions, i.e. in plane of real numbers R^2 where one has a rectangle (instead of a segment of line), determined by two arbitrary points $A(a_1, a_2)$ and $B(b_1, b_2)$. And similarly in R^3 , where one has a prism determined by two arbitrary points $A(a_1, a_2, a_3)$ and $B(b_1, b_2, b_3)$. We geometrically define the linear and non-linear distance between a point and the 2D and 3D-extension set and the dependent function for a nest of two included 2D and 3D-extension sets. Linearly and non-linearly attraction point principles towards the optimal point are presented as well. The same procedure can be then used considering, instead of a rectangle, any bounded 2D-surface and similarly any bounded 3D-solid, and any bounded $(n - D)$ -body in R^n . These generalizations are very important since the Extension Set is generalized from one-dimension to 2, 3 and even n -dimensions, therefore more classes of applications will result in consequence.

1 Introduction

Extension Theory (or Extenics) was developed by Professor Cai Wen in 1983 by publishing a paper called Extension Set and Non-Compatible Problems. Its goal is to solve contradictory problems and also nonconventional, nontraditional ideas in many fields. Extenics is at the confluence of three disciplines: philosophy, mathematics, and engineering. A contradictory problem is converted by a transformation function into a non-contradictory one. The functions of transformation are: extension, decomposition, combination, etc. Extenics has many practical applications in Management, Decision-Making, Strategic Planning, Methodology, Data Mining, Artificial Intelligence, Information Systems, Control Theory, etc. Extenics is based on matter-element, affair-element, and relation-element.

2 Extension Distance in 1D-space

Let's use the notation $\langle a, b \rangle$ for any kind of closed, open, or half-closed interval $[a, b]$, (a, b) , $(a, b]$, $[a, b)$. Prof. Cai Wen has defined the extension distance between a point x_0 and a real interval $X = \langle a, b \rangle$, by

$$\rho(x_0, X) = \left| x_0 - \frac{a+b}{2} \right| - \frac{b-a}{2}, \tag{1}$$

where in general:

$$\rho : (R, R^2) \rightarrow (-\infty, +\infty). \tag{2}$$

Algebraically studying this extension distance, we find that actually the range of it is:

$$\rho(x_0, X) \in \left[-\frac{b-a}{2}, +\infty \right] \tag{3}$$

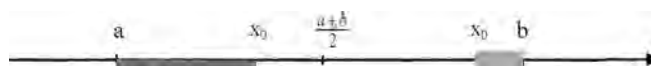

Fig. 1:

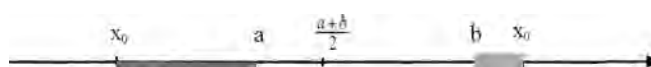

Fig. 2:

or its minimum range value $-\left(\frac{b-a}{2}\right)$ depends on the interval X extremities a and b , and it occurs when the point x_0 coincides with the midpoint of the interval X , i.e. $x_0 = \frac{a+b}{2}$. The closer is the interior point x_0 to the midpoint of the interval $\langle a, b \rangle$, the negatively larger is $\rho(x_0, X)$.

In Fig. 1, for interior point x_0 between a and $\frac{a+b}{2}$, the extension distance $\rho(x_0, X) = a - x_0$ is the negative length of the brown line segment [left side]. Whereas for interior point x_0 between $\frac{a+b}{2}$ and b , the extension distance $\rho(x_0, X) = x_0 - b$ is the negative length of the blue line segment [right side]. Similarly, the further is exterior point x_0 with respect to the closest extremity of the interval $\langle a, b \rangle$ to it (i.e. to either a or b), the positively larger is $\rho(x_0, X)$.

In Fig. 2, for exterior point $x_0 < a$, the extension distance $\rho(x_0, X) = a - x_0$ is the positive length of the brown line segment [left side]. Whereas for exterior point $x_0 > b$, the extension distance $\rho(x_0, X) = x_0 - b$ is the positive length of the blue line segment [right side].

3 Principle of the Extension 1D-Distance

Geometrically studying this extension distance, we find the following principle that Prof. Cai Wen has used in 1983

defining it:

$\rho(x_0, X)$ is the geometric distance between the point x_0 and the closest extremity point of the interval $\langle a, b \rangle$ to it (going in the direction that connects x_0 with the optimal point), distance taken as negative if $x_0 \in \langle a, b \rangle$, and as positive if $x_0 \notin \langle a, b \rangle$.

This principle is very important in order to generalize the extension distance from 1D to 2D (two-dimensional real space), 3D (three-dimensional real space), and n -D (n -dimensional real space).

The extremity points of interval $\langle a, b \rangle$ are the point a and b , which are also the boundary (frontier) of the interval $\langle a, b \rangle$.

4 Dependent Function in 1D-Space

Prof. Cai Wen defined in 1983 in 1D the Dependent Function $K(y)$. If one considers two intervals X_0 and X , that have no common end point, and $X_0 \subset X$, then:

$$K(y) = \frac{\rho(y, X)}{\rho(y, X) - \rho(y, X_0)}. \tag{4}$$

Since $K(y)$ was constructed in 1D in terms of the extension distance $\rho(\cdot, \cdot)$, we simply generalize it to higher dimensions by replacing $\rho(\cdot, \cdot)$ with the generalized in a higher dimension.

5 Extension Distance in 2D-Space

Instead of considering a segment of line AB representing the interval $\langle a, b \rangle$ in $1R$, we consider a rectangle $AMBN$ representing all points of its surface in 2D. Similarly as for 1D-space, the rectangle in 2D-space may be closed (i.e. all points lying on its frontier belong to it), open (i.e. no point lying on its frontier belong to it), or partially closed (i.e. some points lying on its frontier belong to it, while other points lying on its frontier do not belong to it).

Let's consider two arbitrary points $A(a_1, a_2)$ and $B(b_1, b_2)$. Through the points A and B one draws parallels to the axes of the Cartesian system XY and one thus one forms a rectangle $AMBN$ whose one of the diagonals is just AB .

Let's note by O the midpoint of the diagonal AB , but O is also the center of symmetry (intersection of the diagonals) of the rectangle $AMBN$. Then one computes the distance between a point $P(x_0, y_0)$ and the rectangle $AMBN$. One can do that following the same principle as Dr. Cai Wen did:

- compute the distance in 2D (two dimensions) between the point P and the center O of the rectangle (intersection of rectangle's diagonals);
- next compute the distance between the point P and the closest point (let's note it by P') to it on the frontier (the rectangle's four edges) of the rectangle $AMBN$.

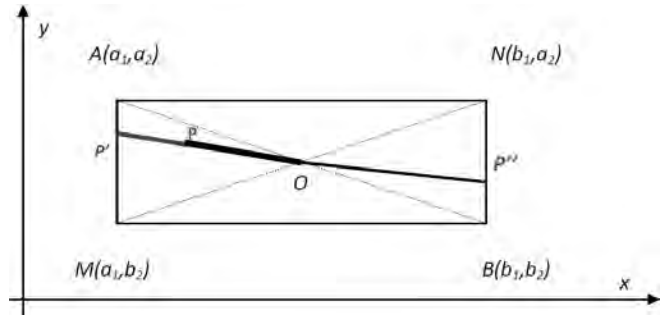

Fig. 3: P is an interior point to the rectangle $AMBN$ and the optimal point O is in the center of symmetry of the rectangle.

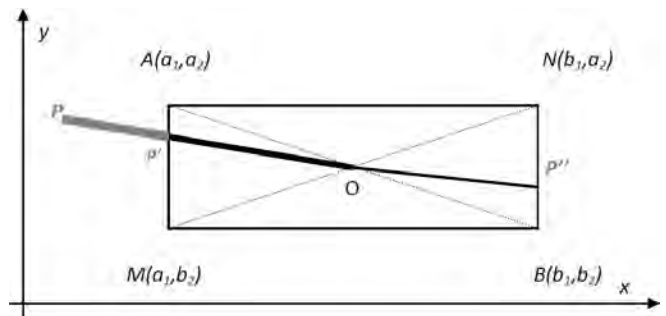

Fig. 4: P is an exterior point to the rectangle $AMBN$ and the optimal point O is in the center of symmetry of the rectangle.

This step can be done in the following way: considering P' as the intersection point between the line PO and the frontier of the rectangle, and taken among the intersection points that point P' which is the closest to P ; this case is entirely consistent with Dr. Cai's approach in the sense that when reducing from a 2D-space problem to two 1D-space problems, one exactly gets his result.

The Extension 2D-Distance, for $P \neq O$, will be:

$$\rho((x_0, y_0), AMBN) = d(\text{point } P, \text{rectangle } AMBN) = |PO| - |P'O| = \pm |PP'|, \tag{5}$$

- i) which is equal to the negative length of the red segment $|PP'|$ in Fig. 3, when P is interior to the rectangle $AMBN$;
- ii) or equal to zero, when P lies on the frontier of the rectangle $AMBN$ (i.e. on edges AM , MB , BN , or NA) since P coincides with P' ;
- iii) or equal to the positive length of the blue segment $|PP'|$ in Fig. 4, when P is exterior to the rectangle $AMBN$, where $|PO|$ means the classical 2D-distance between the point P and O , and similarly for $|P'O|$ and $|PP'|$.

The Extension 2D-Distance, for the optimal point, i.e. $P = O$, will be

$$\rho(O, AMBN) = d(\text{point } O, \text{rectangle } AMBN) = -\max d(\text{point } O, \text{point } M \text{ on the frontier of } AMBN). \tag{6}$$

The last step is to devise the Dependent Function in 2D-space similarly as Dr. Cai's defined the dependent function in 1D. The midpoint (or center of symmetry) O has the coordinates

$$O\left(\frac{a_1 + b_1}{2}, \frac{a_2 + b_2}{2}\right). \tag{7}$$

Let's compute the

$$|PO| - |P'O|. \tag{8}$$

In this case, we extend the line OP to intersect the frontier of the rectangle AMB_N . P' is closer to P than P'' , therefore we consider P' . The equation of the line PO , that of course passes through the points $P(x_0, y_0)$ and $O\left(\frac{a_1+b_1}{2}, \frac{a_2+b_2}{2}\right)$, is:

$$y - y_0 = \frac{\frac{a_2+b_2}{2} - y_0}{\frac{a_1+b_1}{2} - x_0} (x - x_0). \tag{9}$$

Since the x -coordinate of point P' is a_1 because P' lies on the rectangle's edge AM , one gets the y -coordinate of point P' by a simple substitution of $x_{P'} = a_1$ into the above equality:

$$y_{P'} = y_0 + \frac{a_2 + b_2 - 2y_0}{a_1 + b_1 - 2x_0} (a_1 - x_0). \tag{10}$$

Therefore P' has the coordinates

$$P'\left[x_{P'} = a_1, y_{P'} = y_0 + \frac{a_2 + b_2 - 2y_0}{a_1 + b_1 - 2x_0} (a_1 - x_0)\right]. \tag{11}$$

The distance

$$d(PQ) = |PQ| = \sqrt{\left(x_0 - \frac{a_1 + b_1}{2}\right)^2 + \left(y_0 - \frac{a_2 + b_2}{2}\right)^2}, \tag{12}$$

while the distance

$$\begin{aligned} d(P', Q) &= |P'Q| = \\ &= \sqrt{\left(a_1 - \frac{a_1 + b_1}{2}\right)^2 + \left(y_{P'} - \frac{a_2 + b_2}{2}\right)^2} = \\ &= \sqrt{\left(\frac{a_1 - b_1}{2}\right)^2 + \left(y_{P'} - \frac{a_2 + b_2}{2}\right)^2}. \end{aligned} \tag{13}$$

Also, the distance

$$d(PP') = |PP'| = \sqrt{(a_1 - x_0)^2 + (y_{P'} - y_0)^2}. \tag{14}$$

Whence the Extension 2D-distance formula

$$\begin{aligned} \rho[(x_0, y_0), AMB_N] &= \\ &= d[P(x_0, y_0), A(a_1, a_2)MB(b_1, b_2)N] = \\ &= |PQ| - |P'Q| \\ &= \sqrt{\left(x_0 - \frac{a_1+b_1}{2}\right)^2 + \left(y_0 - \frac{a_2+b_2}{2}\right)^2} - \sqrt{\left(\frac{a_1-b_1}{2}\right)^2 + \left(y_{P'} - \frac{a_2+b_2}{2}\right)^2} \\ &= \pm |PP'| \\ &= \pm \sqrt{(a_1 - x_0)^2 + (y_{P'} - y_0)^2}, \end{aligned}$$

where

$$y_{P'} = y_0 + \frac{a_2 + b_2 - 2y_0}{a_1 + b_1 - 2x_0} (a_1 - x_0). \tag{19}$$

6 Properties

As for 1D-distance, the following properties hold in 2D:

6.1 Property 1

- a) $(x, y) \in \text{Int}(AMB_N)$ if $\rho[(x, y), AMB_N] < 0$, where $\text{Int}(AMB_N)$ means interior of AMB_N ;
- b) $(x, y) \in \text{Fr}(AMB_N)$ if $\rho[(x, y), AMB_N] = 0$, where $\text{Fr}(AMB_N)$ means frontier of AMB_N ;
- c) $(x, y) \notin AMB_N$ if $\rho[(x, y), AMB_N] > 0$.

6.2 Property 2

Let $A_0M_0B_0N_0$ and AMB_N be two rectangles whose sides are parallel to the axes of the Cartesian system of coordinates, such that they have no common end points, and $A_0M_0B_0N_0 \subset AMB_N$. We assume they have the same optimal points $O_1 \equiv O_2 \equiv O$ located in the center of symmetry of the two rectangles. Then for any point $(x, y) \in R^2$ one has $\rho[(x, y), A_0M_0B_0N_0] \geq \rho[(x, y), AMB_N]$. See Fig. 5.

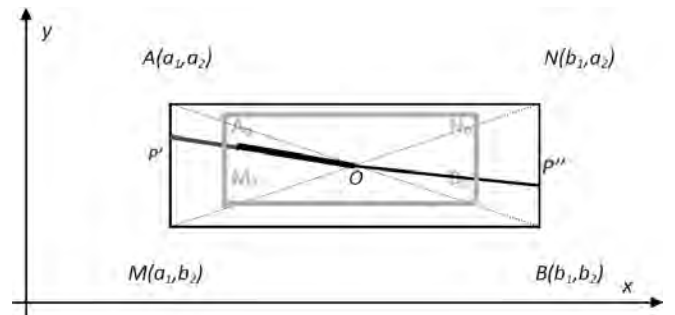

Fig. 5: Two included rectangles with the same optimal points $O_1 \equiv O_2 \equiv O$ located in their common center of symmetry.

7 Dependent 2D-Function

Let $A_0M_0B_0N_0$ and AMB_N be two rectangles whose sides are parallel to the axes of the Cartesian system of coordinates, such that they have no common end points, and $A_0M_0B_0N_0 \subset AMB_N$.

The Dependent 2D-Function formula is:

$$K_{2D(x,y)} = \frac{\rho[(x, y), AMB_N]}{\rho[(x, y), AMB_N] - \rho[(x, y), A_0M_0B_0N_0]}. \tag{20}$$

7.1 Property 3

Again, similarly to the Dependent Function in 1D-space, one has:

- a) If $(x, y) \in \text{Int}(A_0M_0B_0N_0)$, then $K_{2D(x,y)} > 1$;
- b) If $(x, y) \in \text{Fr}(A_0M_0B_0N_0)$, then $K_{2D(x,y)} = 1$;

- c) If $(x, y) \in \text{Int}(AMB N - A_0M_0B_0N_0)$, then $0 < K_{2D(x,y)} < 1$;
- d) If $(x, y) \in \text{Fr}(AMB N)$, then $K_{2D(x,y)} = 0$;
- e) If $(x, y) \notin AMB N$, then $K_{2D(x,y)} < 0$.

8 General Case in 2D-Space

One can replace the rectangles by any finite surfaces, bounded by closed curves in 2D-space, and one can consider any optimal point O (not necessarily the symmetry center). Again, we assume the optimal points are the same for this nest of two surfaces. See Fig. 6.

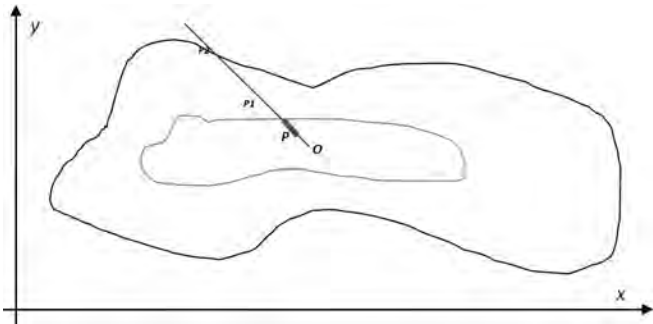

Fig. 6: Two included arbitrary bounded surfaces with the same optimal points situated in their common center of symmetry.

9 Linear Attraction Point Principle

We introduce the Attraction Point Principle, which is the following:

Let S be a given set in the universe of discourse U , and the optimal point $O \subset S$. Then each point $P(x_1, x_2, \dots, x_n)$ from the universe of discourse tends towards, or is attracted by, the optimal point O , because the optimal point O is an ideal of each point. That's why one computes the extension $(n-D)$ -distance between the point P and the set S as $\rho[(x_1, x_2, \dots, x_n), S]$ on the direction determined by the point P and the optimal point O , or on the line PO , i.e.:

- a) $\rho[(x_1, x_2, \dots, x_n), S]$ is the negative distance between P and the set frontier, if P is inside the set S ;
- b) $\rho[(x_1, x_2, \dots, x_n), S] = 0$, if P lies on the frontier of the set S ;
- c) $\rho[(x_1, x_2, \dots, x_n), S]$ is the positive distance between P and the set frontier, if P is outside the set.

It is a kind of convergence/attraction of each point towards the optimal point. There are classes of examples where such attraction point principle works. If this principle is good in all cases, then there is no need to take into consideration the center of symmetry of the set S , since for example if we have a 2D piece which has heterogeneous material density, then its center of weight (barycenter) is different from the center of symmetry. Let's see below such example in the 2D-space: Fig. 7.

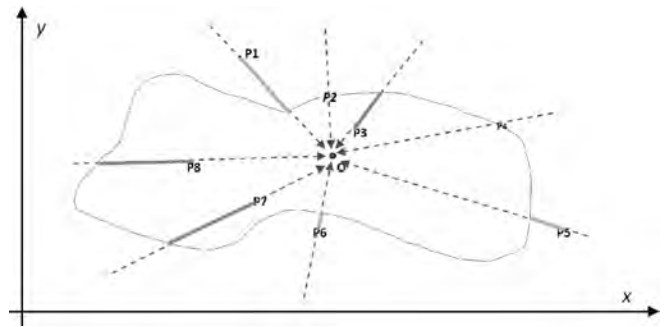

Fig. 7: The optimal point O as an attraction point for all other points P_1, P_2, \dots, P_8 in the universe of discourse R^2 .

10 Remark 1

Another possible way, for computing the distance between the point P and the closest point P' to it on the frontier (the rectangle's four edges) of the rectangle $AMB N$, would be by drawing a perpendicular (or a geodesic) from P onto the closest rectangle's edge, and denoting by P' the intersection between the perpendicular (geodesic) and the rectangle's edge. And similarly if one has an arbitrary set S in the 2Dspace, bounded by a closed curve. One computes

$$d(P, S) = \text{Inf}_{Q \in S} |PQ| \tag{21}$$

as in the classical mathematics.

11 Extension Distance in 3D-Space

We further generalize to 3D-space the Extension Set and the Dependent Function. Assume we have two points (a_1, a_2, a_3) and (b_1, b_2, b_3) in D . Drawing through A and B parallel planes to the planes' axes (XY, XZ, YZ) in the Cartesian system XYZ we get a prism $AM_1M_2M_3BN_1N_2N_3$ (with eight vertices) whose one of the transversal diagonals is just the line segment AB . Let's note by O the midpoint of the transverse diagonal AB , but O is also the center of symmetry of the prism.

Therefore, from the line segment AB in 1D-space, to a rectangle $AMB N$ in 2D-space, and now to a prism $AM_1M_2M_3BN_1N_2N_3$ in 3D-space. Similarly to 1D- and 2D-space, the prism may be closed (i.e. all points lying on its frontier belong to it), open (i.e. no point lying on its frontier belong to it), or partially closed (i.e. some points lying on its frontier belong to it, while other points lying on its frontier do not belong to it).

Then one computes the distance between a point $P(x_0, y_0, z_0)$ and the prism $AM_1M_2M_3BN_1N_2N_3$. One can do that following the same principle as Dr. Cai's:

- compute the distance in 3D (two dimensions) between the point P and the center O of the prism (intersection of prism's transverse diagonals);
- next compute the distance between the point P and the closest point (let's note it by P') to it on the frontier of

the prism $AM_1M_2M_3BN_1N_2N_3$ (the prism's lateral surface); considering P' as the intersection point between the line OP and the frontier of the prism, and taken among the intersection points that point P' which is the closest to P ; this case is entirely consistent with Dr. Cai's approach in the sense that when reducing from 3D-space to 1D-space one gets exactly Dr. Cai's result;

- the Extension 3D-Distance $d(P, AM_1M_2M_3BN_1N_2N_3)$ is $d(P, AM_1M_2M_3BN_1N_2N_3) = |PO| - |P'O| = \pm|PP'|$, where $|PO|$ means the classical distance in 3D-space between the point P and O , and similarly for $|P'O|$ and $|PP'|$. See Fig. 8.

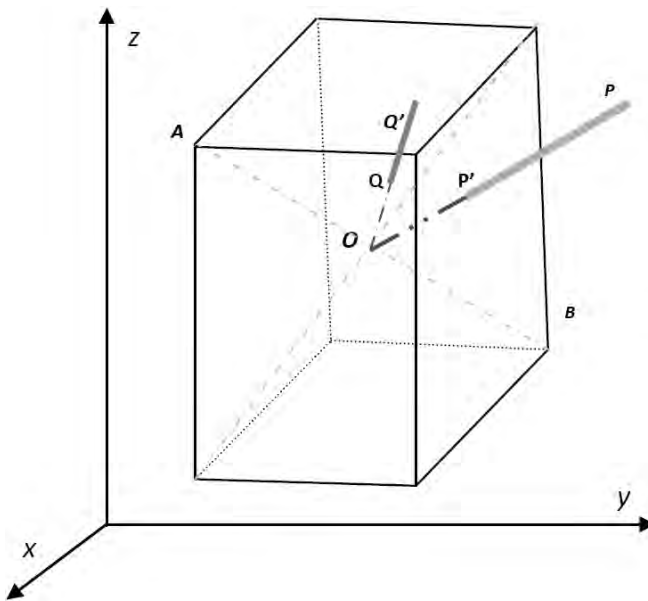

Fig. 8: Extension 3D-Distance between a point and a prism, where O is the optimal point coinciding with the center of symmetry.

12 Property 4

- a) $(x, y, z) \in \text{Int}(AM_1M_2M_3BN_1N_2N_3)$
if $\rho[(x, y, z), AM_1M_2M_3BN_1N_2N_3] < 0$,
where $\text{Int}(AM_1M_2M_3BN_1N_2N_3)$ means interior of $AM_1M_2M_3BN_1N_2N_3$;
- b) $(x, y, z) \in \text{Fr}(AM_1M_2M_3BN_1N_2N_3)$
if $\rho[(x, y, z), AM_1M_2M_3BN_1N_2N_3] = 0$
means frontier of $AM_1M_2M_3BN_1N_2N_3$;
- c) $(x, y, z) \notin AM_1M_2M_3BN_1N_2N_3$
if $\rho[(x, y, z), AM_1M_2M_3BN_1N_2N_3] > 0$.

13 Property 5

Let $A_0M_01M_02M_03B_0N_01N_02N_03$ and $AM_1M_2M_3BN_1N_2N_3$ be two prisms whose sides are parallel to the axes of the Cartesian system of coordinates, such that they have no common end points, and $A_0M_01M_02M_03B_0N_01N_02N_03 \subset AM_1M_2M_3BN_1N_2N_3$.

We assume they have the same optimal points $O_1 \equiv O_2 \equiv O$ located in the center of symmetry of the two prisms.

Then for any point $(x, y, z) \in R^3$ one has

$$\rho[(x, y, z), A_0M_01M_02M_03B_0N_01N_02N_03] \geq \rho[(x, y, z), AM_1M_2M_3BN_1N_2N_3].$$

14 The Dependent 3D-Function

The last step is to devise the Dependent Function in 3D-space similarly to Dr. Cai's definition of the dependent function in 1D-space. Let the prisms $A_0M_01M_02M_03B_0N_01N_02N_03$ and $AM_1M_2M_3BN_1N_2N_3$ be two prisms whose faces are parallel to the axes of the Cartesian system of coordinates XYZ , such that they have no common end points in such a way that $A_0M_01M_02M_03B_0N_01N_02N_03 \subset AM_1M_2M_3BN_1N_2N_3$. We assume they have the same optimal points $O_1 \equiv O_2 \equiv O$ located in the center of symmetry of these two prisms.

The Dependent 3D-Function formula is:

$$K_{3D}(x,y,z) = \left(\rho[(x, y, z), AM_1M_2M_3BN_1N_2N_3] \right) \times \left(\rho[(x, y, z), AM_1M_2M_3BN_1N_2N_3] - \rho[(x, y, z), A_0M_01M_02M_03B_0N_01N_02N_03] \right)^{-1}. \tag{22}$$

15 Property 6

Again, similarly to the Dependent Function in 1D- and 2D-spaces, one has:

- a) If $(x, y, z) \in \text{Int}(A_0M_01M_02M_03B_0N_01N_02N_03)$, then $K_{3D}(x, y, z) > 1$;
- b) If $(x, y, z) \in \text{Fr}(A_0M_01M_02M_03B_0N_01N_02N_03)$, then $K_{3D}(x, y, z) = 1$;
- c) If $(x, y, z) \in \text{Int}(AM_1M_2M_3BN_1N_2N_3 - A_0M_01M_02M_03B_0N_01N_02N_03)$, then $0 < K_{3D}(x, y, z) < 1$;
- d) If $(x, y, z) \in \text{Fr}(AM_1M_2M_3BN_1N_2N_3)$, then $K_{3D}(x, y, z) = 0$;
- e) If $(x, y, z) \notin AM_1M_2M_3BN_1N_2N_3$, then $K_{3D}(x, y, z) < 0$.

16 General Case in 3D-Space

One can replace the prisms by any finite 3D-bodies, bounded by closed surfaces, and one considers any optimal point O (not necessarily the centers of surfaces' symmetry). Again, we assume the optimal points are the same for this nest of two 3D-bodies.

17 Remark 2

Another possible way, for computing the distance between the point P and the closest point P' to it on the frontier (lateral

surface) of the prism $AM_1M_2M_3BN_1N_2N_3$ is by drawing a perpendicular (or a geodesic) from P onto the closest prism's face, and denoting by P' the intersection between the perpendicular (geodesic) and the prism's face.

And similarly if one has an arbitrary finite body B in the 3D-space, bounded by surfaces. One computes as in classical mathematics:

$$d(P, B) = \text{Inf}_{Q \in B} |PB|. \tag{23}$$

18 Linear Attraction Point Principle in 3D-Space

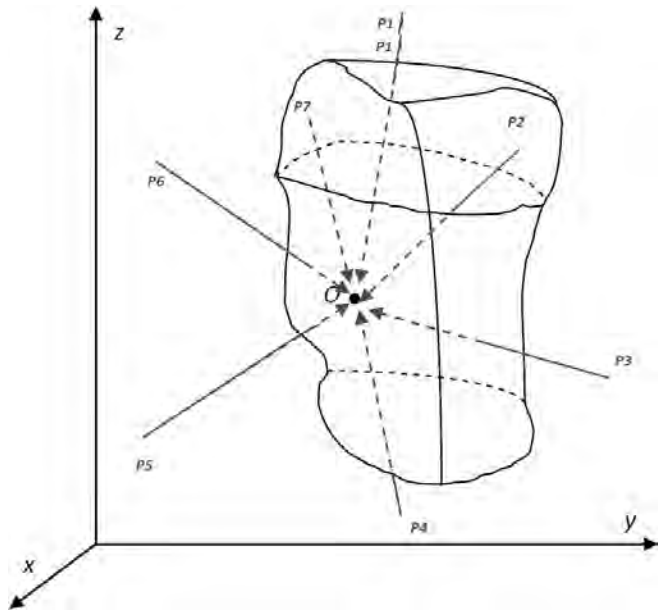

Fig. 9: Linear Attraction Point Principle for any bounded 3D-body.

19 Non-Linear Attraction Point Principle in 3D-Space, and in (n-D)-Space

There might be spaces where the attraction phenomena undergo not linearly by upon some specific non-linear curves. Let's see below such example for points P_i whose trajectories of attraction towards the optimal point follow some non-linear 3D-curves.

20 (n-D)-Space

In general, in a universe of discourse U , let's have an $(n-D)$ -set S and a point P . Then the Extension Linear $(n-D)$ -Distance between point P and set S , is:

$$\rho(P, S) = \begin{cases} -d_c(P, P'), & P \neq 0, P \in |OP'| \\ d(P, P'), & P \neq 0, P' \in |OP| \\ -\max_{P' \in \text{Fr}(S)} d(P, M), & P = 0 \end{cases} \tag{24}$$

where O is the optimal point (or linearly attraction point); $d(P, P')$ means the classical linearly $(n-D)$ -distance between

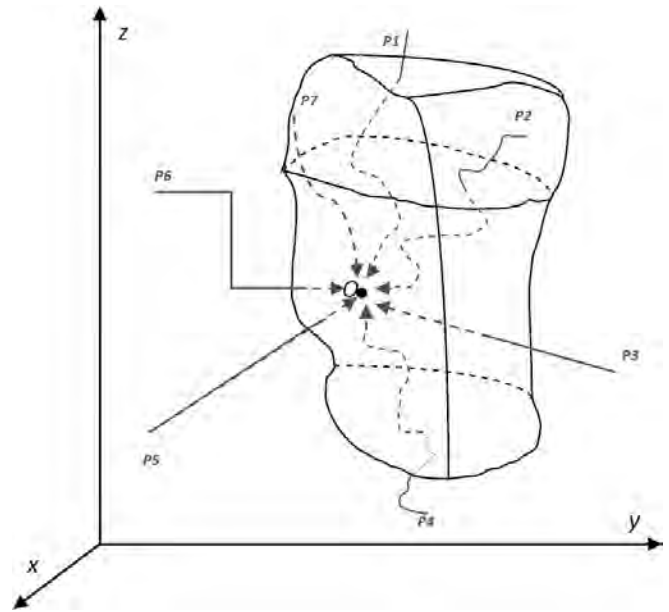

Fig. 10: Non-Linear Attraction Point Principle for any bounded 3D-body.

two points P and P' ; $\text{Fr}(S)$ means the frontier of set S ; and $|OP'|$ means the line segment between the points O and P' (the extremity points O and P' included), therefore $P \in |OP'|$ means that P lies on the line OP' , in between the points O and P' .

For P coinciding with O , one defined the distance between the optimal point O and the set S as the negatively maximum distance (to be in concordance with the 1D-definition).

And the Extension Non-Linear $(n-D)$ -Distance between point P and set S , is:

$$\rho_c(P, S) = \begin{cases} -d_c(P, P'), & P \neq 0, P \in c(OP') \\ d_c(P, P'), & P \neq 0, P' \in c(OP) \\ -\max_{P' \in \text{Fr}(S), M \in c(O)} d(P, M), & P = 0 \end{cases} \tag{25}$$

where means the extension distance as measured along the curve c ; O is the optimal point (or non-linearly attraction point); the points are attracting by the optimal point on trajectories described by an injective curve c ; $d_c(P, P')$ means the non-linearly $(n-D)$ -distance between two points P and P' , or the arc length of the curve c between the points P and P' ; $\text{Fr}(S)$ means the frontier of set S ; and $c(OP')$ means the curve segment between the points O and P' (the extremity points O and P' included), therefore $P \in (OP')$ means that P lies on the curve c in between the points O and P' .

For P coinciding with O , one defined the distance between the optimal point O and the set S as the negatively maximum curvilinear distance (to be in concordance with the 1D-definition).

In general, in a universe of discourse U , let's have a nest of two $(n-D)$ -sets, $S_1 \subset S_2$, with no common end points, and a point P . Then the Extension Linear Dependent $(n-D)$ -Function referring to the point $P(x_1, x_2, \dots, x_n)$ is:

$$K_{nD}(P) = \frac{\rho(P, S_2)}{\rho(P, S_2) - \rho(P, S_1)}, \quad (26)$$

where is the previous extension linear $(n-D)$ -distance between the point P and the $(n-D)$ -set S_2 .

And the Extension Non-Linear Dependent $(n-D)$ -Function referring to point $P(x_1, x_2, \dots, x_n)$ along the curve c is:

$$K_{nD}(P) = \frac{\rho_c(P, S_2)}{\rho_c(P, S_2) - \rho_c(P, S_1)}, \quad (27)$$

where is the previous extension non-linear $(n-D)$ -distance between the point P and the $(n-D)$ -set S_2 along the curve c .

21 Remark 3

Particular cases of curves c could be interesting to studying, for example if c are parabolas, or have elliptic forms, or arcs of circle, etc. Especially considering the geodesics would be for many practical applications. Tremendous number of applications of Extenics could follow in all domains where attraction points would exist; these attraction points could be in physics (for example, the earth center is an attraction point), economics (attraction towards a specific product), sociology (for example attraction towards a specific life style), etc.

22 Conclusion

In this paper we introduced the *Linear and Non-Linear Attraction Point Principle*, which is the following:

Let S be an arbitrary set in the universe of discourse U of any dimension, and the optimal point $O \in S$. Then each point $P(x_1, x_2, \dots, x_n)$, $n \geq 1$, from the universe of discourse (linearly or non-linearly) tends towards, or is attracted by, the optimal point O , because the optimal point O is an ideal of each point.

It is a king of convergence/attraction of each point towards the optimal point. There are classes of examples and applications where such attraction point principle may apply.

If this principle is good in all cases, then there is no need to take into consideration the center of symmetry of the set S , since for example if we have a $2D$ factory piece which has heterogeneous material density, then its center of weight (barycenter) is different from the center of symmetry.

Then we generalized in the track of Cai Wen's idea to extend $1D$ -set to an extension $(n-D)$ -set, and thus defined the *Linear (or Non-Linear) Extension $(n-D)$ -Distance* between a point $P(x_1, x_2, \dots, x_n)$ and the $(n-D)$ -set S as $\rho[(x_1, x_2, \dots, x_n), S]$ on the linear (or non-linear) direction determined by the point P and the optimal point O (the line PO , or respectively the curvilinear PO) in the following way:

- 1) $\rho[(x_1, x_2, \dots, x_n), S]$ is the negative distance between P and the set frontier, if P is inside the set S ;
- 2) $\rho[(x_1, x_2, \dots, x_n), S] = 0$, if P lies on the frontier of the set S ;
- 3) $\rho[(x_1, x_2, \dots, x_n), S]$ is the positive distance between P and the set frontier, if P is outside the set.

We got the following properties:

- 4) It is obvious from the above definition of the extension $(n-D)$ -distance between a point P in the universe of discourse and the extension $(n-D)$ -set S that:

- i) Point $P(x_1, x_2, \dots, x_n) \in \text{Int}(S)$
if $\rho[(x_1, x_2, \dots, x_n), S] < 0$;
- ii) Point $P(x_1, x_2, \dots, x_n) \in \text{Fr}(S)$
if $\rho[(x_1, x_2, \dots, x_n), S] = 0$;
- iii) Point $P(x_1, x_2, \dots, x_n) \notin S$
if $\rho[(x_1, x_2, \dots, x_n), S] > 0$.

- 5) Let S_1 and S_2 be two extension sets, in the universe of discourse U , such that they have no common end points, and $S_1 \subset S_2$. We assume they have the same optimal points $O1 \equiv O2 \equiv O$ located in their center of symmetry. Then for any point $P(x_1, x_2, \dots, x_n) \in U$ one has:

$$\rho[(x_1, x_2, \dots, x_n), S_2] \geq \rho[(x_1, x_2, \dots, x_n), S_1]. \quad (28)$$

Then we proceed to the generalization of the dependent function from $1D$ -space to Linear (or Non-Linear) $(n-D)$ -space Dependent Function, using the previous notations.

The *Linear (or Non-Linear) Dependent $(n-D)$ -Function* of point $P(x_1, x_2, \dots, x_n)$ along the curve c , is:

$$K_{nD}(x_1, x_2, \dots, x_n) = \left(\rho_c[(x_1, x_2, \dots, x_n), S_2] \right) \times \left(\rho_c[(x_1, x_2, \dots, x_n), S_2] - \rho_c[(x_1, x_2, \dots, x_n), S_1] \right)^{-1} \quad (29)$$

(where c may be a curve or even a line) which has the following property:

- 6) If point $P(x_1, x_2, \dots, x_n) \in \text{Int}(S_1)$, then $K_{nD}(x_1, x_2, \dots, x_n) > 1$;
- 7) If point $P(x_1, x_2, \dots, x_n) \in \text{Fr}(S_1)$, then $K_{nD}(x_1, x_2, \dots, x_n) = 1$;
- 8) If point $P(x_1, x_2, \dots, x_n) \in \text{Int}(S_2 - S_1)$, then $K_{nD}(x_1, x_2, \dots, x_n) \in (0, 1)$;
- 9) If point $P(x_1, x_2, \dots, x_n) \in \text{Int}(S_2)$, then $K_{nD}(x_1, x_2, \dots, x_n) = 0$;
- 10) If point $P(x_1, x_2, \dots, x_n) \notin \text{Int}(S_2)$, then $K_{nD}(x_1, x_2, \dots, x_n) < 0$.

References

1. Cai Wen. Extension Set and Non-Compatible Problems. *Journal of Scientific Exploration*, 1983, no. 1, 83–97; Cai Wen. Extension Set and Non-Compatible Problems. In: *Advances in Applied Mathematics and Mechanics in China*. International Academic Publishers, Beijing, 1990, 1–21.
2. Cai Wen. Extension theory and its application. *Chinese Science Bulletin*, 1999, v. 44, no. 7, 673–682. Cai Wen. Extension theory and its application. *Chinese Science Bulletin*, 1999, v. 44, no. 17, 1538–1548.
3. Yang Chunyan and Cai Wen. *Extension Engineering*. Public Library of Science, Beijing, 2007.
4. Wu Wenjun et al. Research on Extension Theory and Its Application. Expert Opinion. 2004, <http://web.gdut.edu.cn/extendics/jianding.htm>
5. Xiangshan Science Conferences Office. Scientific Significance and Future Development of Extenics — No. 271 Academic Discussion of Xiangshan Science Conferences, Brief Report of Xiangshan Science Conferences, Period 260, 2006, 1.

Connections between Extension Logic and Refined Neutrosophic Logic

Florentin Smarandache

Florentin Smarandache (2014). Connections between Extension Logic and Refined Neutrosophic Logic. *Journal of Guangdong University of Technology* 31(4), 5

可拓逻辑与中智逻辑的内在关联初探

佛罗伦汀·司马仁达齐

(新墨西哥大学 数学与科学部, 新墨西哥州 盖洛普市 87301)

摘要: 本文对可拓逻辑与模糊逻辑和中智逻辑等的内在联系进行分析, 探讨矛盾发生时, 可拓逻辑与 3 值中智逻辑、4 值中智逻辑和 n 值中智逻辑的关联。发现可拓逻辑与中智逻辑有内在的相似性。

关键词: 可拓逻辑; 逻辑学; 中智逻辑; 模糊逻辑; 可拓学

中图分类号: B81

文献标志码: A

文章编号: 1007-7162(2014)04-0000-00

Connections between Extension Logic and Refined Neutrosophic Logic

Florentin Smarandache

(Math & Science Division University of New Mexico, Gallup, NM 87301, USA)

Abstract: The aim of this presentation is to connect Extension Logic with new fields of research, i. e. fuzzy logic and neutrosophic logic.

We show herein;

How Extension Logic is connected to the 3-Valued Neutrosophic Logic,

How Extension Logic is connected to the 4-Valued Neutrosophic Logic,

How Extension Logic is connected to the n -Valued Neutrosophic Logic,

when contradictions occurs. As extension transformation one uses the normalization of the neutrosophic logic components.

Key words: Extension logic; Logic; neutrosophic logic; fuzzy logic; Extenics

In this paper we present a short history of logics: from particular cases of 2-symbol or numerical valued logic to the general case of n -symbol or numerical valued logic, and the way they are connected to Prof. Cai Wen's Extension Logic Theory^[1]. We show generalizations of 2-valued Boolean logic to fuzzy logic, also from the Kleene's and Lukasiewicz's 3-symbol valued logics or Belnap's 4-symbol valued logic to the most general n -symbol or numerical valued refined neutrosophic logic. Two classes of neutrosophic norm (n -norm) and neutrosophic conorm (n -conorm) are defined. Examples of applications of neutrosophic logic to physics are listed in the last section.

Similar generalizations can be done for n -Valued Refined Neutrosophic Set, and respectively n -Valued

Refined Neutrosophic Probability in connections with Extension Logic.

The essential difference between extension logic and neutrosophic logic is that the sum of the components in the extension logic is greater than 1. And the relationship between extension logic and refined neutrosophic logic is that both of them can be normalized (by dividing each logical component by the sum of all components), thus using an extension transformation.

1 Two-Valued Logic

a) The Two Symbol-Valued Logic.

It is the Chinese philosophy: Yin and Yang (or Femininity and Masculinity) as contraries:



Fig.1 Yin and Yang
图 1 太极图

It is also the Classical or Boolean Logic, which has two symbol-values: truth T and falsity F.

b) The Two Numerical-Valued Logic.

It is also the Classical or Boolean Logic, which has two numerical-values: truth 1 and falsity 0.

More general it is the Fuzzy Logic, where the truth (T) and the falsity (F) can be any numbers in $[0, 1]$ such that $T + F = 1$.

Even more general, T and F can be subsets of $[0, 1]$.

2 Three-Valued Logic

a) The Three Symbol-Valued Logics:

i) Łukasiewicz's Logic: True, False, and Possible.

ii) Kleene's Logic: True, False, Unknown (or Undefined).

iii) Chinese philosophy extended to: Yin, Yang, and Neuter (or Femininity, Masculinity, and Neutrality) -as in Neutrosophy.

Neutrosophy philosophy was born from neutrality between various philosophies. Connected with Extension Logic^[1], and Paradoxism.

Neutrosophy is a new branch of philosophy that studies the origin, nature, and scope of neutralities, as well as their interactions with different ideational spectra.

This theory considers every notion or idea $\langle A \rangle$ together with its opposite or negation $\langle \text{anti}A \rangle$ and with their spectrum of neutralities $\langle \text{neut}A \rangle$ in between them (i. e. notions or ideas supporting neither $\langle A \rangle$ nor $\langle \text{anti}A \rangle$).

The $\langle \text{neut}A \rangle$ and $\langle \text{anti}A \rangle$ ideas together are

referred to as $\langle \text{non}A \rangle$.

Neutrosophy is a generalization of Hegel's dialectics (the last one is based on $\langle A \rangle$ and $\langle \text{anti}A \rangle$ only).

According to this theory every idea $\langle A \rangle$ tends to be neutralized and balanced by $\langle \text{anti}A \rangle$ and $\langle \text{non}A \rangle$ ideas as a state of equilibrium.

In a classical way $\langle A \rangle$, $\langle \text{neut}A \rangle$, $\langle \text{anti}A \rangle$ are disjoint two by two. But, since in many cases the borders between notions are vague, imprecise, sorites, it is possible that $\langle A \rangle$, $\langle \text{neut}A \rangle$, $\langle \text{anti}A \rangle$ (and $\langle \text{non}A \rangle$ of course) have common parts two by two, or even all three of them as well. Such contradictions involves Extension Logic.

Neutrosophy is the base of all neutrosophics and it is used in engineering applications (especially for software and information fusion), medicine, military, air-space, cybernetics, physics.

b) The Three Numerical-Valued Logic:

i) Kleene's Logic: True (1), False (0), Unknown (or Undefined) (1/2), and uses "min" for \wedge , "max" for \vee , and "1-" for negation.

ii) More general is the Neutrosophic Logic^[7], where the truth (T) and the falsity (F) and the indeterminacy (I) can be any numbers in $[0, 1]$, then $0 \leq T + I + F \leq 3$.

More general: Truth (T), Falsity (F), and Indeterminacy (I) are standard or nonstandard subsets of the nonstandard interval $[-0, 1 +]$.

When $T + F > 1$, we have conflict, hence Extension Logic.

表 1

Tab.1 Belnap's conjunction operator

\cap	F	U	C	T
F	F	F	F	F
U	F	U	F	U
C	F	F	C	C
T	F	U	C	T

3 Four-Valued Logic

a) The Four Symbol-Valued Logic

i) It is Belnap's Logic: True (T), False (F), Unknown (U), and Contradiction (C), where T, F, U, C are symbols, not numbers.

Now we have Extension Logic, thanks to $C = \text{contradiction}$.

Below is the Belnap's conjunction operator table: Restricted to T, F, U , and to T, F, C , the Belnap connectives coincide with the connectives in Kleene's logic.

ii) Let $G = \text{Ignorance}$. We can also propose the following two 4-Symbol Valued Logics:

(T, F, U, G) , and (T, F, C, G) .

iii) Absolute-Relative 2-, 3-, 4-, 5-, or 6-Symbol Valued Logics ^[7].

Let T_A be truth in all possible worlds (according to Leibniz's definition);

T_R be truth in at last one world but not in all worlds;

and similarly let I_A be indeterminacy in all possible worlds;

I_R be indeterminacy in at last one world but not in all worlds;

also let F_A be falsity in all possible worlds;

F_R be falsity in at last one world but not in all worlds;

Then we can form several Absolute-Relative 2-, 3-, 4-, 5-, or 6-Symbol Valued Logics

just taking combinations of the symbols T_A, T_R, I_A, I_R, F_A , and F_R .

As particular cases, very interesting would be to study the Absolute-Relative 4-Symbol Valued Logic (T_A, T_R, F_A, F_R) , as well as the Absolute-Relative 6-Symbol Valued Logic $(T_A, T_R, I_A, I_R, F_A, F_R)$.

b) Four Numerical-Valued Neutrosophic Logic: Indeterminacy I is refined (split) as $U = \text{Unknown}$, and $C = \text{contradiction}$.

T, F, U, C are subsets of $[0, 1]$, instead of symbols;

This logic generalizes Belnap's logic since one gets a degree of truth, a degree of falsity, a degree of unknown, and a degree of contradiction.

Since $C = T \wedge F$, this logic involves the Extension Logic.

4 Five-Valued Logic

a) Five Symbol-Valued Neutrosophic Logic ^[7]:

Indeterminacy I is refined (split) as $U = \text{Un-}$

known, $C = \text{contradiction}$, and $G = \text{ignorance}$; where the symbols represent:

$T = \text{truth}$;

$F = \text{falsity}$;

$U = \text{neither } T \text{ nor } F \text{ (undefined)}$;

$C = T \wedge F$, which involves the Extension Logic;

$G = T \vee F$.

b) If T, F, U, C, G are subsets of $[0, 1]$ then we get: a Five Numerical-Valued Neutrosophic Logic.

5 Seven-Valued Logic

a) Seven Symbol-Valued Neutrosophic Logic ^[7]:

I is refined (split) as U, C, G , but T also is refined as $T_A = \text{absolute truth}$ and $T_R = \text{relative truth}$, and F is refined as $F_A = \text{absolute falsity}$ and $F_R = \text{relative falsity}$. Where:

$U = \text{neither } (T_A \text{ or } T_R) \text{ nor } (F_A \text{ or } F_R) \text{ (i. e. undefined)}$;

$C = (T_A \text{ or } T_R) \wedge (F_A \text{ or } F_R) \text{ (i. e. Contradiction)}$, which involves the Extension Logic;

$G = (T_A \text{ or } T_R) \vee (F_A \text{ or } F_R) \text{ (i. e. Ignorance)}$.

All are symbols.

b) But if $T_A, T_R, F_A, F_R, U, C, G$ are subsets of $[0, 1]$, then we get a Seven Numerical-Valued Neutrosophic Logic.

6 n-Valued Logic

a) The n -Symbol-Valued Refined Neutrosophic Logic ^[7].

In general:

T can be split into many types of truths: T_1, T_2, \dots, T_p , and I into many types of indeterminacies: I_1, I_2, \dots, I_r , and F into many types of falsities: F_1, F_2, \dots, F_s , where all $p, r, s \geq 1$ are integers, and $p + r + s = n$.

All subcomponents T_j, I_k, F_l are symbols for $j \in \{1, 2, \dots, p\}$, $k \in \{1, 2, \dots, r\}$, and $l \in \{1, 2, \dots, s\}$.

If at least one $I_k = T_j \wedge F_l = \text{contradiction}$, we get again the Extension Logic.

b) The n -Numerical-Valued Refined Neutrosophic Logic.

In the same way, but all subcomponents T_j, I_k, F_l are not symbols, but subsets of $[0, 1]$, for all

$j \in \{1, 2, \dots, p\}$, all $k \in \{1, 2, \dots, r\}$, and all l

$\in \{1, 2, \dots, s\}$.

If all sources of information that separately provide neutrosophic values for a specific subcomponent are independent sources, then in the general case we consider that each of the subcomponents T_j, I_k, F_l is independent with respect to the others and it is in the non-standard set $[-0, 1^+]$. Therefore per total we have for crisp neutrosophic value subcomponents T_j, I_k, F_l that:

$$-0 \leq \sum_{j=1}^p T_j + \sum_{k=1}^r I_k + \sum_{l=1}^s F_l \leq n^+ \quad (1)$$

where of course $n = p + r + s$ as above.

If there are some dependent sources (or respectively some dependent subcomponents), we can treat those dependent subcomponents together. For example, if T_2 and I_3 are dependent, we put them together as $-0 \leq T_2 + I_3 \leq 1^+$.

The non-standard unit interval $[-0, 1^+]$, used to make a distinction between absolute and relative truth/indeterminacy/falsehood in philosophical applications, is replaced for simplicity with the standard (classical) unit interval $[0, 1]$ for technical applications.

For at least one $I_k = T_j \wedge F_l = \text{contradiction}$, we get again the Extension Logic.

7 Neutrosophic Cube and Its Extension Logic Part

The most important distinction between IFS and NS is shown in the below Neutrosophic Cube $A'B'C'D'E'F'G'H'$ introduced by J. Dezert in 2002^[13].

Because in technical applications only the classical interval is used as range for the neutrosophic parameters, we call the cube the technical neutrosophic cube and its extension the neutrosophic cube (or absolute neutrosophic cube), used in the fields where we need to differentiate between absolute and relative (as in philosophy) notions. Let's consider a 3D-Cartesian system of coordinates, where t is the truth axis with value range in $[-0, 1^+]$, i is the false axis with value range in $[-0, 1^+]$, and similarly f is the indeterminate axis with value range in $[-0, 1^+]$.

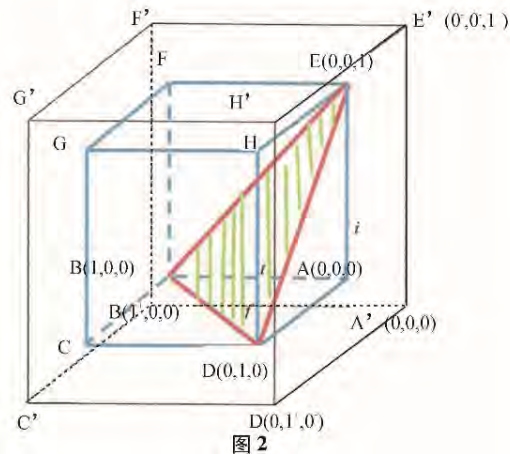

Fig. 2 Neutrosophic Cube

We now divide the technical neutrosophic cube $ABCDEFGH$ into three disjoint regions:

1) The equilateral triangle BDE , whose sides are equal to $\sqrt{2}$ which represents the geometrical locus of the points whose sum of the coordinates is 1.

If a point Q is situated on the sides of the triangle BDE or inside of it, then $tQ + iQ + fQ = 1$ as in Atanassov-intuitionistic fuzzy set (Λ -IFS).

2) The pyramid $EABD$ (situated in the right side of the triangle EBD , including its faces triangle ABD (base), triangle EBA , and triangle EDA (lateral faces), but excluding its face; triangle BDE) is the locus of the points whose sum of coordinates is less than 1 (Incomplete Logic).

3) In the left side of triangle BDE in the cube there is the solid $EFGCDEBD$ (excluding triangle BDE) which is the locus of points whose sum of their coordinates is greater than 1 as in the paraconsistent logic. This is the Extension Logic part.

It is possible to get the sum of coordinates strictly less than 1 (in Incomplete information), or strictly greater than 1 (in contradictory Extension Logic). For example:

We have a source which is capable to find only the degree of membership of an element; but it is unable to find the degree of non-membership;

Another source which is capable to find only the degree of non-membership of an element;

Or a source which only computes the indeterminacy.

Thus, when we put the results together of these sources, it is possible that their sum is not 1, but small-

ler (Incomplete) or greater (Extension Logic).

8 Example of Extension Logic in 3-Valued Neutrosophic Logic

About a proposition P, the first source of information provides the truth-value $T = 0.8$.

Second source of information provides the false-value $F = 0.7$.

Third source of information provides the indeterminacy-value $I = 0.2$.

$$\text{Hence } NL3(P) = (0.8, 0.2, 0.7).$$

Got Extension Logic, since Contradiction: $T + F = 0.8 + 0.7 > 1$.

Can remove Contradiction by normalization:

$$NL(P) = (0.47, 0.12, 0.41); \text{ now } T + F \leq 1.$$

9 Example of Extension Logic in 4-Valued Neutrosophic Logic

About a proposition Q, the first source of information provides the truth-value $T = 0.4$, second source provides the false-value $F = 0.3$, third source provides the undefined-value $U = 0.1$, fourth source provides the contradiction-value $C = 0.2$.

$$\text{Hence } NL4(Q) = (0.4, 0.1, 0.2, 0.3).$$

Got Extension Logic, since Contradiction $C = 0.2 > 0$.

Since $C = T \wedge F$, we can remove it by transferring its value 0.2 to T and F (since T and F were involved in the conflict) proportionally w. r. t. their values 0.4, 0.3:

$$xT/0.4 = yF/0.3 = 0.2/(0.4 + 0.3), \text{ whence } xT = 0.11, yF = 0.09.$$

$$\text{Thus } T = 0.4 + 0.11 = 0.51, F = 0.3 + 0.09 = 0.39, U = 0.1, C = 0.$$

10 Conclusion

Many types of logics have been presented above related with Extension Logic. Examples of Neutrosophic Cube and its Extension Logic part, and Extension Logic in 3-Valued and 4-Valued Neutrosophic Logics are given.

Similar generalizations are done for n -Valued Refined Neutrosophic Set, and respectively n -Valued Refined Neutrosophic Probability in connections with Extension Logic.

参考文献:

- [1] Cai W. Extension set and non-compatible problems [J]. Journal of Scientific Exploration, 1983, (1): 83-97.
- [2] Yang C Y, Cai W. Extension Engineering [M]. Beijing: Science Press, 2007.
- [3] Dubois D. Uncertainty Theories, Degrees of Truth and Epistemic States [EB/OL]. [2014-09-01]. http://www.icaart.org/Documents/Previous_Invited_Speakers/2011/ICAART2011_Dubois.pdf
- [4] Smarandache F. Proceedings of the Introduction to Neutrosophic Physics: Unmatter & Unparticle -International Conference[M]. Columbus: Zip Publ, 2011.
- [5] Rabounski D, Smarandache F, Borisova L. Neutrosophic Methods in General Relativity[M]. Phoenix:Hexis, 2005: 78.
- [6] Rabunskii D, Smarandache F, Borisova L. Neutrosophic Methods in the General Theory of Relativity[M]. Hexis: Phoenix, AZ, 2005:105.
- [7] Smarandache J. Neutrosophy, neutrosophic logic, neutrosophic set, neutrosophic probability and statistics [EB/OL]. [2014-09-01]. <http://fs.gallup.unm.edu/neutrosophy.htm>, 1995.
- [8] Smarandache F. A Unifying Field in Logics: Neutrosophic Field[J]. Multiple-Valued Logic, 2002,8(3): 385-438.
- [9] Riveccio U. Neutrosophic logics: Prospects and problems [J]. Fuzzy Sets and Systems, 2008, 159(14): 1860-1868.
- [10] Smarandache F. An introduction to the Neutrosophic probability applied in quantum statistics[J]. Bulletin of Pure and Applied Sciences, Physics, 13-25, Vol. 22D, No. 1, 2003.
- [11] F. Smarandache, Neutrosophic Set-A Generalization of the Intuitionistic Fuzzy Set[J]. Int J Pure Appl Math, 2005, 24(3): 287-297.
- [12] Smarandache F. A Unifying Field in Logics: Neutrosophic Logic[J]. Multiple Valued Logic, 2002, 8(3):385-438.
- [13] Dezert J. Open questions on neutrosophic inference. Neutrosophy and neutrosophic logic[J]. Mult.-Valued Log. 2002,8(3): 439-472.
- [14] Webster's Online Dictionary, Paraconsistent probability [neutrosophic probability] [EB/OL]. [2014-09-01]. <http://www.websters-online-dictionary.org/definitions/Paraconsistent?cx=partner-pub-0939450753529744%3Av0qd01-tdlq&cof=FORID>.

The Extenics Norm Applied to a Two-Dimensional Robotic Workspaces

Victor Vlădăreanu, Ovidiu-Ilie Șandru, Mihnea Alexandru Moisescu,
Florentin Smarandache, Hongnian Yu

Victor Vlădăreanu, Ovidiu-Ilie Șandru, Mihnea Alexandru Moisescu, Florentin Smarandache, Hongnian Yu (2016). The Extenics Norm Applied to a Two-Dimensional Robotic Workspaces. Proceedings of the Annual Symposium of the Institute of Solid Mechanics and Session of the Commission of Acoustics; *Acta Electrotechnica* 57(1-2), 35-40

The paper presents an application of Extenics Engineering principles to a two-dimensional robotic workspace. This provides the mathematical basis and considerations for obtaining the trajectory tracking reference in robotic applications. A brief history and overview of the relevant theoretical concepts is provided.

Keywords: Extenics, robot workspace, reference generation, Extenics control.

1. INTRODUCTION

Extenics is a science whose stated aim is to deal with unsolvable problems. With applications in artificial intelligence, business, marketing, planning, design, control theory and image processing, to name just a few, it is one of the fastest developing new fields of study in the world today.

To be able to manipulate the outcomes of situations which represent contradictory problems, we need to have in place a representation, as well as a set of tools and an environment model in which to do so. This section will briefly explain the theoretical basis of Extenics and describe the general model of thought in an Extenics problem. The three pillars of Extenics Theory are Basic Element, Extension Set and Extension Logic.

Extenics Theory maps all components of a given problem into elements, which provides the basis for a working model of the problem. These are called Basic Elements and consist of the triplet formed by an object, action or relation, a possibly infinite number of characteristics and their corresponding value relating to the object. In mathematical form, we call:

$$B = \begin{pmatrix} O_m & c_{m_1} & v_{m_1} \\ & \vdots & \vdots \\ & c_{m_n} & v_{m_n} \end{pmatrix} = (O_m, c_m, v_m)$$

a basic element in Extenics Theory. The „*m*” means this particular triplet defines a matter-element (although all basic elements are similar from a construction standpoint) [1,2].

Elements are organized together with the help of Extension Sets. These provide a means of classification for the initial problem, as well as the outcomes. Extension Sets are further processed using any number of transformations to achieve a desired result and new norms are introduced for work on them, such as Extenics Distances. Working with Extension Sets and the different classes of transformations to solve contradictory problems is at the very core of practical Extenics Theory applications.

Extension Set Theory is a new set theory which aims to describe the change of the nature of matters, thus taking both qualitative, as well as quantitative aspects into account. The theoretical definition for an extension set is as follows: supposing *U* to be an universe of discourse, *u* is any one element in *U*, *k* is a mapping of *U* to the real field *I*, *T* (*TU*, *Tk*, *Tu*) is given transformation, we call:

$$E(T) = \{(u, y, y') | u \in U, y = k(u) \in I, T_u u \in T_U U, y' = T_k k(T_u u) \in I\}$$

an extension set on the universe of discourse U , $y = k(u)$ the Dependent Function of $E(T)$, and $y = T_k k(T_u u)$ the extension function of $E(T)$, wherein, T_U , T_k and T_u are transformations of the respective universe of discourse U , Dependent Function k and element u . If $T \neq e$, that is to say the transformation is not identical, four more concepts can be outlined, as follows:

- positive extensible field (or positive qualitative change field) of $E(T)$:

$$E_{\omega_+}(T) = \{(u, y, y') \mid u \in U, y = k(u) \leq 0; T_u u \in T_U U, y' = T_k k(T_u u) > 0\}$$

- negative extensible field (or negative qualitative change field) of $E(T)$:

$$E_{\omega_-}(T) = \{(u, y, y') \mid u \in U, y = k(u) \geq 0; T_u u \in T_U U, y' = T_k k(T_u u) < 0\}$$

- positive stable field (or positive quantitative change field) of $E(T)$:

$$E_+(T) = \{(u, y, y') \mid u \in U, y = k(u) > 0; T_u u \in T_U U, y' = T_k k(T_u u) > 0\}$$

- negative stable field (or negative quantitative change field) of $E(T)$:

$$E_-(T) = \{(u, y, y') \mid u \in U, y = k(u) < 0; T_u u \in T_U U, y' = T_k k(T_u u) < 0\}$$

- extension boundary of $E(T)$:

$$E_0(T) = \{(u, y, y') \mid u \in U, T_u u \in T_U U, y' = T_k k(T_u u) = 0\}$$

This is further illustrated in Figure 1 [1]

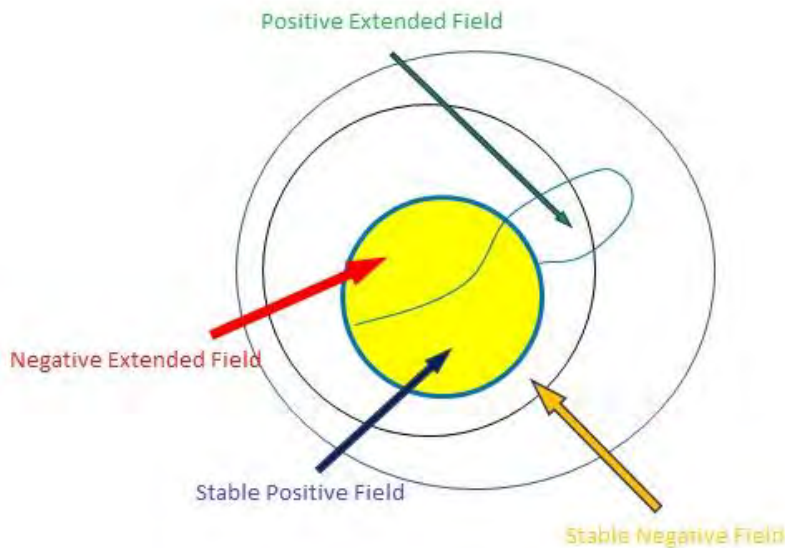

Figure 1. Universe of Discourse in an Extenics Transformation

The Extension Set, then, is defined in relation to a transformation and an existing function mapped onto the universe of discourse. Following the transformation, the Extension Set is divided into the positive and negative fields with regard to the dependent function value. Four subsets are therefore defined: the positive stable, the positive transitive, the negative stable and the negative transitive field. The stable fields are those for which the polarity of the dependent function is unaltered by the transformation, whereas transitive (also named extensible) fields are those affected by the change. This provides a useful classification and investigation tool for contradictory problem models.

. EXTENICS WORKSPACE

Let there be a robotic application determined by a similar workspace to that presented in Figure 2. For the mechatronic mechanism within this workspace there is a two-dimensional point reference – defined exactly on the axes by the double (x,y) – which must be reached by the robot end-effector.

There is assumed an extended controller for actuator control, which implements the concepts of Extenics Theory. For this, it will be necessary to know the dependence function, calculated for the multi-dimensional case, in order to estimate the level of incompatibility, from which follows the intensity of the actuator response. This is detailed in [3-5]. For modelling the robotic workspace, it suffices to say that it is required to compute the dependent function for multi-dimensional cases.

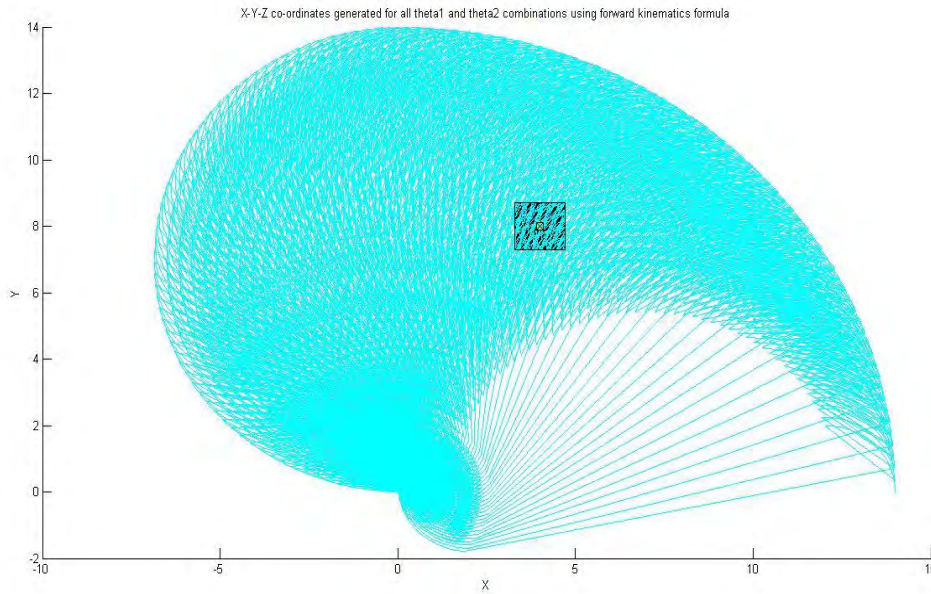

Figure 2. Robotic Workspace

Using the theories developed by Smarandache [6, 7] and Sandru [5, 8] relating to working with the dependence function in n-dimensional spaces, its point value can be obtained for the particular case.

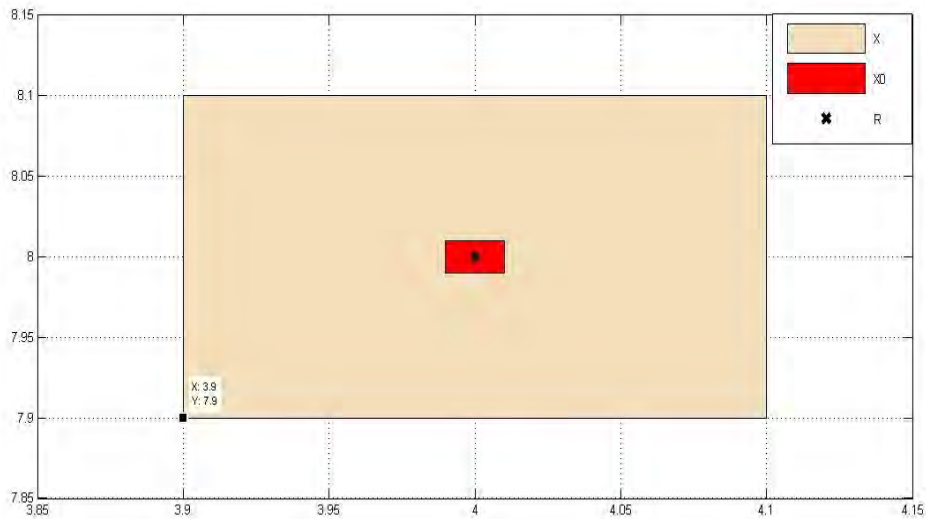

Figure 3. Nested extended interval space relative to reference R

Starting from the given reference point $R(x_r, y_r)$, which is the optimum for the actuator – controlled position, there is an accepted reference interval X_0 and acceptable interval X , the optimum for both being the singular reference R .

In order to find the values of the extended indicators, two regions of the two-dimensional space are considered, as can be seen in Figures 4 and 6. The two zone correspond to the field variations on x and y .

For any point $P(x_p, y_p)$ in the first region (shown in Figure 4) can be calculated [6, 7] (cf. Smarandache) the 2D extended distance to the existing intervals:

$$\begin{aligned} \rho(x, X) &= |P - X| \\ \rho(x, X_0) &= |P - X_0| \end{aligned} \quad (6.1)$$

This will yield the dependent function as:

$$k(P) = \frac{\rho(x, X)}{D(x, X_0, X)} = \frac{\rho(x, X)}{\rho(x, X) - \rho(x, X_0)} = \frac{|P - X|}{|P - X| - |P - X_0|} \quad (6.2)$$

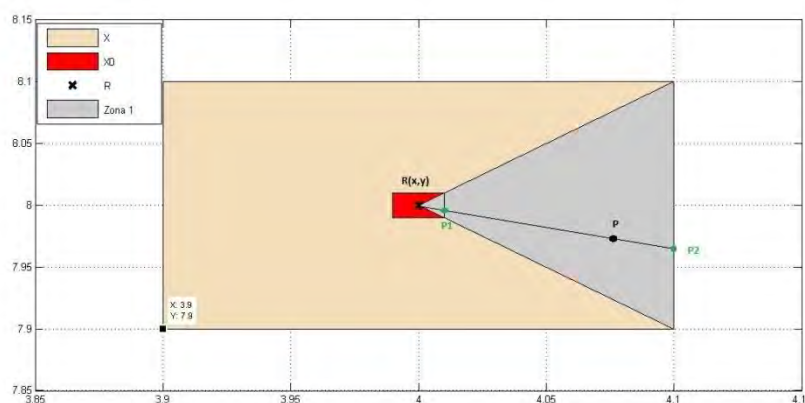

Figure 4. Vertical region of the extended field

In the figure, point P is chosen outside X_0 , but inside X , which will lead to a negative sub-unitary value for the dependence function (the function denominator is negative). Had P belonged to X_0 , $k(Q)$ would have been similarly computed, with the result being positive and, had P been chosen outside X , the dependence function value would have been lower than -1.

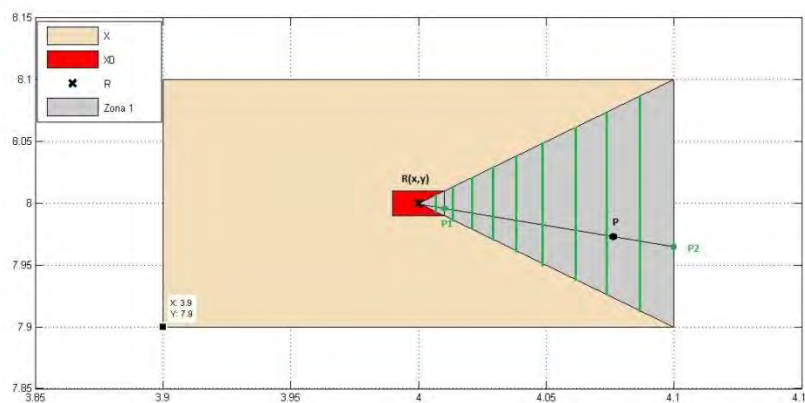

Figure 5. Vertical point classes having the same dependence function value

The dependence function value in point P will thus be the 2D extended distance between the point and the closest frontier of the larger interval, divided by the difference of the 2D extended distance between the

point and the larger interval, and the point and the smaller interval. All of these distances are considered along the line defined by the optimum point $R(x,y)$ and the chosen point $P(x_p,y_p)$.

As explained in [9] (Smarandache, Vlădăreanu, 2012) this will determine the dependent function within the region, as the final expression does not depend on the value of the y-coordinate in the chosen point. This concept is illustrated in Figure 5. For every point $Q(x_Q,y_Q)$ in the second region (see Figure 6), a similar final expression is reached, where:

$$k(Q) = \frac{\rho(x,X)}{D(x,X_0,X)} = \frac{\rho(x,X)}{\rho(x,X) - \rho(x,X_0)} = \frac{|Q_2|}{|Q_1| - |Q_2|} \quad (6.3)$$

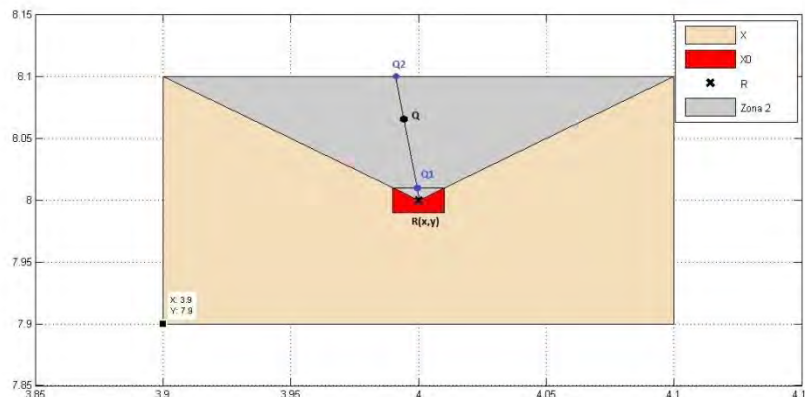

Figure 6. Horizontal region of the extended field

This will determine classes of horizontal points having the same value of the dependent function, as is shown in Figure 7.

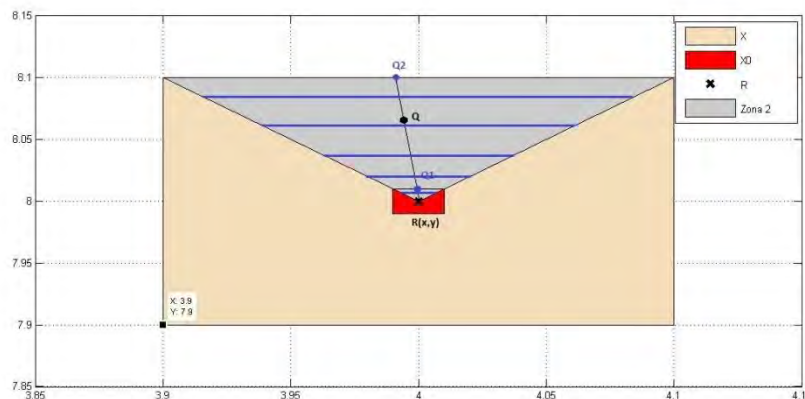

Figure 7. Classes of horizontal points having the same value of the dependent function

Thus, it can be seen that for such a distribution of the extended intervals upon which the dependent function is based, the two-dimensional problem can be separated into two distinct one-dimensional problems. It should be noted that this characteristic is not necessarily present in all applications, for which different distributions of extended intervals may exist. Beyond the scope of this paper, the subject can be further investigated in [6, 10]. These results are the basis for the design, implementation and simulation of Extenuis Control concepts presented in various papers, and in modelling the robotic workspace and the reference and control system for a humanoid walking robot [11].

. CONCLUSIONS

Modelling a robotic workspace using concepts from Extenics Theory contributes to the development of a new type of innovative control for robot actuators. The advantages of extended control are remarkable through the lack of added complexity in design or implementation. The controller architecture is very straightforward, once the function interpreter is established. While the place and limits of the extended sets need to be specified and may involve some fine tuning, their optimization is not vital, and perfectly fine results can be obtained with simple and intuitive values (such as setting the accepted interval to be ± 2 of the reference value).

Extenics control, as discussed in this paper, benefits greatly from being a novelty approach to controller design. While this paper proves a working model can be established with basic parameters, the possibilities for tweaking and optimizing in the hopes of obtaining improved performance are virtually limitless.

Perhaps most importantly, it represents a shift in the paradigm of controller structure. While the controllers themselves have evolved greatly over the years, changes in the way one looks at controllers and controller structures have not been frequent. By way of being an implementation of a more generalized theory, whose aim is precisely to formalize the process of innovation, there is virtually no end to the possibilities for further research. Also, as Extenics Theory continues to grow and mature as a discipline in itself, the theoretical advances made are sure to have a favourable impact upon this field of research.

ACKNOWLEDGEMENT

This work was accomplished through the Partnerships Program in priority fields - PN II, developed with the support of MEN-UEFISCDI, PN-II-PT-PCCA-2013-4, ID2009, VIPRO project no.009/2014, Romanian Academy, and FP7-PEOPLE-2012-IRSES RABOT project no. 318902.

REFERENCES

1. Yang Chunyan, Cai Wen, "Extension Engineering", Science Press, Beijing, 2002.
2. Cai Wen, "Extension Set and Non-Compatible Problems", Advances in Applied Mathematics and Mechanics in China, Peking: International Academic Publishers, 1990, 1-21.
3. Vladareanu V., Sandru O.I., Schiopu P., Sandru A., Vladareanu L., „Extension Hybrid Force-Position Control of Mechatronics Systems”, accepted for publication in Communications in Cybernetics, Systems Science and Engineering, CRC Press, Beijing 2013
4. Vladareanu L, Tont G, Ion I, Vladareanu V, Mitroi D, "Modeling and Hybrid Position-Force Control of Walking Modular Robots", ISI Proceedings, Recent Advances in Applied Mathematics, Harvard University, Cambridge, USA, 2010, pg. 510-518, ISBN 978-960-474-150-2, ISSN 1790-2769.
5. O. I. Şandru, L. Vlădăreanu, P. Şchiopu, V. Vlădăreanu, A. Şandru, "Multidimensional Extenics Theory", U.P.B. Sci. Bull., Series A, Vol. 75, Iss. 1, 2013, ISSN 1223-7027.
6. Florentin Smarandache, Extenics in Higher Dimensions, Institute of Extenics and Innovation Methods, Guangdong University of Technology, ISBN: 9781599732039.
7. F.Smarandache, L.Vlădăreanu, Applications of Neutrosophic Logic to Robotics - An Introduction, The 2011 IEEE International Conference on Granular Computing Kaohsiung, Taiwan, Nov. 8-10, 2011, pp. 607-612, ISBN 978-1-4577-0370-6, IEEE Catalog Number: CFP11GRC-PRT.
8. Şandru O., Vlădăreanu L., Şchiopu P., Vlădăreanu V., Şandru A., New Progress In Extenics Theory, First International Symposium of Extenics, Beijing 2013
9. Smarandache Florentin, Vlădăreanu Victor, Applications of Extenics to 2D-Space and 3D-Space, The 6th Conference on Software, Knowledge, Information Management and Applications, Chengdu, China. Sept. 9-11, 2012 pp.12
10. F. Smarandache, Generalizations of the Distance and Dependent Function in Extenics to 2D, 3D, and n-D, viXra.org, <http://vixra.org/abs/1206.0014> and <http://vixra.org/pdf/1206.0014v1.pdf>, 2012
11. Victor Vlădăreanu, Paul Schiopu, Mingcong Deng, Hongnian Yu, " Intelligent Extended Control of the Walking Robot Motion" Proceedings of the 2014 International Conference on Advanced Mechatronic Systems, Kumamoto, Japan, August 10-12, 2014, pg. 489-495, ISBN 978-1-4799-6380-5, 2014 IEEE, ISI Proceedings.

INSTANTANEOUS PHYSICS

Parameterized Special Theory of Relativity (PSTR)

Florentin Smarandache

Florentin Smarandache (2012). Parameterized Special Theory of Relativity (PSTR). *Progress in Physics* 2, 28-29

We have parameterized Einstein’s thought experiment with atomic clocks, supposing that we knew neither if the space and time are relative or absolute, nor if the speed of light was ultimate speed or not. We have obtained a Parameterized Special Theory of Relativity (PSTR), first introduced in 1982. Our PSTR generalized not only Einstein’s Special Theory of Relativity, but also our Absolute Theory of Relativity, and introduced three more possible Relativities to be studied in the future. After the 2011 CERN’s superluminal neutrino experiments, we recall our ideas and invite researchers to deepen the study of PSTR, ATR, and check the three new mathematically emerged Relativities 4.3, 4.4, and 4.5.

1 Einstein’s thought experiment with the light clocks

There are two identical clocks, one is placed aboard of a rocket, which travels at a constant speed v with respect to the Earth, and the second one is on the Earth. In the rocket, a light pulse is emitted by a source from A to a mirror B that reflects it back to A where it is detected. The rocket’s movement and the light pulse’s movement are orthogonal. There is an observer in the rocket (the astronaut) and an observer on the Earth. The trajectory of light pulse (and implicitly the distance traveled by the light pulse), the elapsed time it needs to travel this distance, and the speed of the light pulse at which is travels are perceived differently by the two observers (depending on the theories used — see below in this paper).

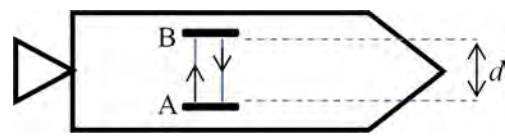

Figure 1

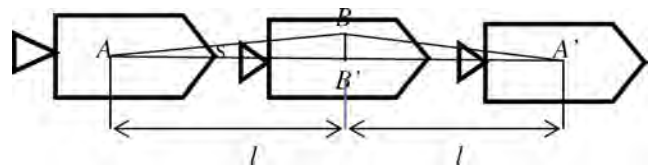

Figure 2

According to the astronaut (see Fig. 1):

$$\Delta t' = \frac{2d}{c}, \tag{1}$$

where $\Delta t'$ time interval, as measured by the astronaut, for the light to follow the path of double distance $2d$, while c is the speed of light.

According to the observer on the Earth (see Fig. 2):

$$\left. \begin{aligned} 2l &= v \Delta t, \quad s = |AB| = |BA'| \\ d &= |BB'|, \quad l = |AB'| = |b'A'| \end{aligned} \right\}, \tag{2}$$

where Δt is the time interval as measured by the observer on the Earth. And using the Pythagoras’ Theorem in the right triangle $\Delta ABB'$, one has

$$2s = 2 \sqrt{d^2 + l^2} = 2 \sqrt{d^2 + \frac{v \Delta t}{2}}^2, \tag{3}$$

but $2s = c \Delta t$, whence

$$c \Delta t = 2 \sqrt{d^2 + \frac{v \Delta t}{2}}^2. \tag{4}$$

Squaring and computing for Δt one gets:

$$\Delta t = \frac{2d}{c} \frac{1}{\sqrt{1 - \frac{v^2}{c^2}}}. \tag{5} \text{ or}$$

Whence Einstein gets the following time dilation:

$$\Delta t = \frac{\Delta t'}{\sqrt{1 - \frac{v^2}{c^2}}}. \tag{6}$$

where $\Delta t > \Delta t'$

2 Parameterized Special Theory of Relativity (PSTR)

In a more general case when we don’t know the speed x of the light as seen by the observer on Earth, nor the relationship between $\Delta t'$ and Δt , we get:

$$x \Delta t = 2 \sqrt{d^2 + \frac{v \Delta t}{2}}^2. \tag{7}$$

But $d = \frac{c \Delta t'}{2}$, therefore:

$$x \Delta t = 2 \sqrt{\left(\frac{c \Delta t'}{2}\right)^2 + \frac{v \Delta t}{2}}^2, \tag{8}$$

$$x \Delta t = \sqrt{c^2(\Delta t')^2 + v^2(\Delta t')^2}. \tag{9}$$

Dividing the whole equality by Δt we obtain:

$$x = \sqrt{v^2 + c^2 \left(\frac{\Delta t'}{\Delta t}\right)^2} \tag{10}$$

which is the *PSTR Equation*.

3 PSTR elapsed time ratio τ (parameter)

We now substitute in a general case

$$\frac{\Delta t'}{\Delta t} = \tau \in (0, +\infty), \tag{11}$$

where τ is the PSTR elapsed time ratio. Therefore we split the Special Theory of Relativity (STR) in the below ways.

4 PSTR extends STR, ATR, and introduces three more Relativities

4.1 If $\tau = \sqrt{1 - \frac{v^2}{c^2}}$ we get the STR (see [1]), since replacing x by c , one has

$$c^2 = v^2 + c^2 \left(\frac{\Delta t'}{\Delta t}\right)^2, \tag{12}$$

$$\frac{c^2}{c^2} - \frac{v^2}{c^2} = \left(\frac{\Delta t'}{\Delta t}\right)^2, \tag{13}$$

or $\frac{\Delta t'}{\Delta t} = \sqrt{1 - \frac{v^2}{c^2}} \in [0, 1]$ as in the STR.

4.2 If $\tau = 1$, we get our *Absolute Theory of Relativity* (see [2]) in the particular case when the two trajectory vectors are perpendicular, i.e.

$$X = \sqrt{v^2 + c^2} = |\vec{v} + \vec{c}|. \tag{14}$$

4.3 If $0 < \tau < \sqrt{1 - \frac{v^2}{c^2}}$, the time dilation is increased with respect to that of the STR, therefore the speed x as seen by the observer on the Earth is decreased (becomes subluminal) while in STR it is c .

4.4 If $\sqrt{1 - \frac{v^2}{c^2}} < \tau < 0$, there is still time dilation, but less than STR's time dilation, yet the speed x as seen by the observer on the Earth becomes superluminal (yet less than in our Absolute Theory of Relativity). About superluminal velocities see [3] and [4].

4.5 If $\tau > 1$, we get an *opposite time dilation* (i.e. $\Delta t' > \Delta t$) with respect to the STR (instead of $\Delta t' < \Delta t$), and the speed x as seen by the observer on earth increases even more than in our ATR.

5 Further research

The reader might be interested in studying these new Relativities mathematically resulted from the above 4.3, 4.4, and 4.5 cases.

References

1. Einstein A. Zur Elektrodynamik bewegter Körper. *Annalen der Physik*, 1905, v. 17, 891–921.
2. Smarandache F. Absolute Theory of Relativity and Parameterized Special Theory of Relativity and Noninertial Multirelativity. Somipress, 1982, 92 p.
3. Smarandache F. There is No Speed Barrier in the Universe. Liceul Pedagogic Rm. Vâlcea, Physics Prof. Elena Albu, 1972.
4. Rabounski D. A blind pilot: who is a super-luminal observer? *Progress in Physics*, 2008, v. 2, 171.

Relations between Distorted and Original Angles in STR

Florentin Smarandache

Florentin Smarandache (2013). Relations between Distorted and Original Angles in STR. *Progress in Physics* 3, 21-24

Using the Oblique-Length Contraction Factor, which is a generalization of Lorentz Con-traction Factor, one shows several trigonometric relations between distorted and original angles of a moving object lengths in the Special Theory of Relativity.

1 Introduction

The lengths at oblique angle to the motion are contracted with the Oblique-Length Contraction Factor $OC(\nu, \theta)$, defined as [1-2]:

$$OC(\nu, \theta) = \sqrt{C(\nu)^2 \cos^2 \theta + \sin^2 \theta} \quad (1)$$

where $C(\nu)$ is just Lorentz Factor:

$$C(\nu) = \sqrt{1 - \frac{\nu^2}{c^2}} \in [0, 1] \text{ for } \nu \in [0, c]. \quad (2)$$

Of course

$$0 \leq OC(\nu, \theta) \leq 1. \quad (3)$$

The Oblique-Length Contraction Factor is a generalization of Lorentz Contractor $C(\nu)$, because: when $\theta = 0$, or the length is moving along the motion direction, then $OC(\nu, 0) = C(\nu)$. Similarly

$$OC(\nu, \pi) = OC(\nu, 2\pi) = C(\nu). \quad (4)$$

Also, if $\theta = \pi/2$, or the length is perpendicular on the motion direction, then $OC(\nu, \pi/2) = 1$, i.e. no contraction occurs. Similarly $OC(\nu, \frac{3\pi}{2}) = 1$.

2 Tangential relations between distorted acute angles vs. original acute angles of a right triangle

Let's consider a right triangle with one of its legs along the motion direction (Fig. 1).

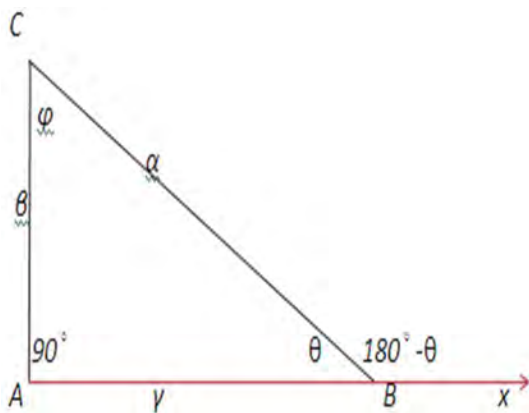

Fig. 1:

$$\tan \theta = \frac{\beta}{\gamma} \quad (5)$$

$$\tan(180^\circ - \theta) = -\tan \theta = -\frac{\beta}{\gamma} \quad (6)$$

After contraction of the side AB (and consequently contraction of the oblique side BC) one gets (Fig. 2):

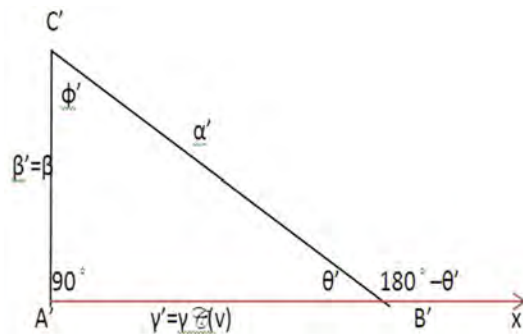

Fig. 2:

$$\tan(180^\circ - \theta') = -\tan \theta' = -\frac{\beta'}{\gamma'} = -\frac{\beta}{\gamma C(\nu)}. \quad (7)$$

Then:

$$\frac{\tan(180^\circ - \theta')}{\tan(180^\circ - \theta)} = \frac{-\frac{\beta}{\gamma C(\nu)}}{-\frac{\beta}{\gamma}} = \frac{1}{C(\nu)}. \quad (8)$$

Therefore

$$\tan(\pi - \theta') = -\frac{\tan(\pi - \theta)}{C(\nu)} \quad (9)$$

and consequently

$$\tan(\theta') = \frac{\tan(\theta)}{C(\nu)} \quad (10)$$

or

$$\tan(B') = \frac{\tan(B)}{C(\nu)} \quad (11)$$

which is the Angle Distortion Equation, where θ is the angle formed by a side travelling along the motion direction and another side which is oblique on the motion direction.

The angle θ is increased (i.e. $\theta' > \theta$).

$$\tan \varphi = \frac{\gamma}{\beta} \quad \text{and} \quad \tan \varphi' = \frac{\gamma'}{\beta'} = \frac{\gamma C(v)}{\beta} \quad (12)$$

whence:

$$\frac{\tan \varphi'}{\tan \varphi} = \frac{\frac{\gamma C(v)}{\beta}}{\frac{\gamma}{\beta}} = C(v). \quad (13)$$

So we get the following Angle Distortion Equation:

$$\tan \varphi' = \tan \varphi \cdot C(v) \quad (14)$$

or

$$\tan C' = \tan C \cdot C(v) \quad (15)$$

where φ is the angle formed by one side which is perpendicular on the motion direction and the other one is oblique to the motion direction.

The angle φ is decreased (i.e. $\varphi' < \varphi$). If the traveling right triangle is oriented the opposite way (Fig. 3)

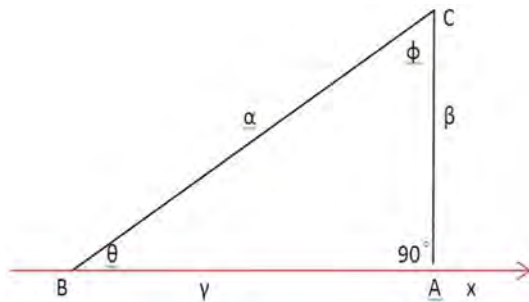

Fig. 3:

$$\tan \theta = \frac{\beta}{\gamma} \quad \text{and} \quad \tan \varphi = \frac{\gamma}{\beta}. \quad (16)$$

Similarly, after contraction of side AB (and consequently contraction of the oblique side BC) one gets (Fig. 4)

$$\tan \theta' = \frac{\beta'}{\gamma'} = \frac{\beta}{\gamma C(v)} \quad (17)$$

and

$$\tan \varphi' = \frac{\gamma'}{\beta'} = \frac{\gamma C(v)}{\beta} \quad (18)$$

$$\frac{\tan \theta'}{\tan \theta} = \frac{\frac{\beta}{\gamma C(v)}}{\frac{\beta}{\gamma}} = \frac{1}{C(v)} \quad (19)$$

or

$$\tan \theta' = \frac{\tan \theta}{C(v)} \quad (20)$$

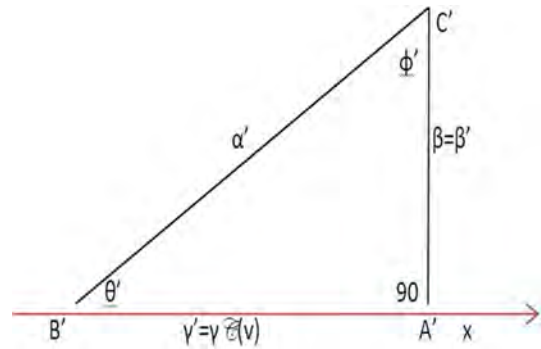

Fig. 4:

and similarly

$$\frac{\tan \varphi'}{\tan \varphi} = \frac{\frac{\gamma C(v)}{\beta}}{\frac{\gamma}{\beta}} = C(v) \quad (21)$$

or

$$\tan \varphi' = \tan \varphi \cdot C(v). \quad (22)$$

Therefore one got the same Angle Distortion Equations for a right triangle traveling with one of its legs along the motion direction.

3 Tangential relations between distorted angles vs. original angles of a general triangle

Let's suppose a general triangle ΔABC is travelling at speed v along the side BC as in Fig. 5.

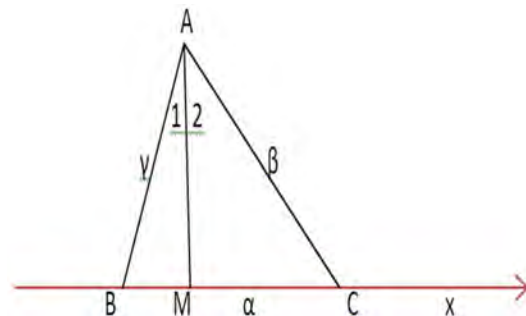

Fig. 5:

The height remains not contracted: $AM \equiv A'M'$. We can split this figure into two traveling right sub-triangles as in Fig. 6.

In the right triangles $\Delta A'M'B'$ and respectively $\Delta A'M'C'$ one has

$$\tan B' = \frac{\tan B}{C(v)} \quad \text{and} \quad \tan C' = \frac{\tan C}{C(v)}. \quad (23)$$

Also

$$\tan A'_1 = \tan A_1 C(v) \quad \text{and} \quad \tan A'_2 = \tan A_2 C(v). \quad (24)$$

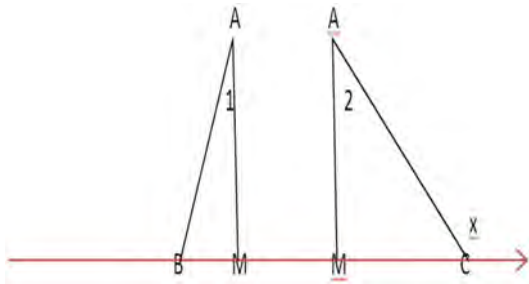

Fig. 6:

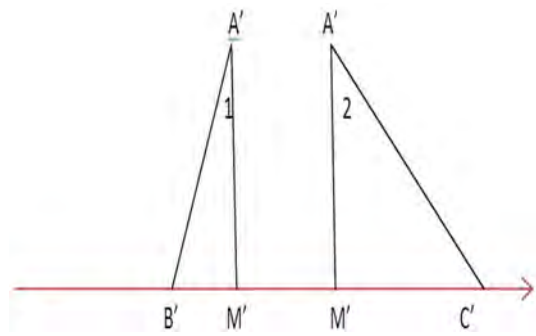

Fig. 8:

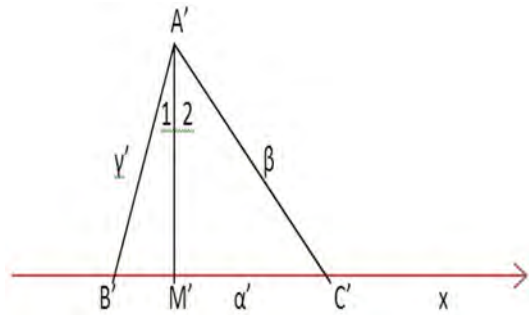

Fig. 7:

But

$$\begin{aligned} \tan A' &= \tan(A'_1 + A'_2) = \frac{\tan A'_1 + \tan A'_2}{1 - \tan A'_1 \tan A'_2} \\ &= \frac{\tan A_1 C(\nu) + \tan A_2 C(\nu)}{1 - \tan A_1 C(\nu) \tan A_2 C(\nu)} \\ &= C(\nu) \cdot \frac{\tan A_1 + \tan A_2}{1 - \tan A_1 \tan A_2 C(\nu)^2} \\ &= C(\nu) \cdot \frac{\tan A_1 + \tan A_2}{1 - \tan A_1 \tan A_2} \cdot (1 - \tan A_1 \tan A_2) \\ &= C(\nu) \cdot \frac{\tan(A_1 + A_2)}{1} \cdot \frac{1 - \tan A_1 \tan A_2}{1 - \tan A_1 \tan A_2 C(\nu)^2}. \end{aligned}$$

$$\tan A' = C(\nu) \cdot \tan(A) \cdot \frac{1 - \tan A_1 \tan A_2}{1 - \tan A_1 \tan A_2 C(\nu)^2}. \tag{25}$$

We got

$$\tan A' = \tan(A) \cdot C(\nu) \cdot \frac{1 - \tan A_1 \tan A_2}{1 - \tan A_1 \tan A_2 C(\nu)^2} \tag{26}$$

Similarly we can split this Fig. 7 into two traveling right sub-triangles as in Fig. 8.

4 Other relations between the distorted angles and the original angles

1. Another relation uses the Law of Sine in the triangles ΔABC and respectively $\Delta A'B'C'$:

$$\frac{\alpha}{\sin A} = \frac{\beta}{\sin B} = \frac{\gamma}{\sin C} \tag{27}$$

$$\frac{\alpha'}{\sin A'} = \frac{\beta'}{\sin B'} = \frac{\gamma'}{\sin C'}. \tag{28}$$

After substituting

$$\alpha' = \alpha C(\nu) \tag{29}$$

$$\beta' = \beta \theta C(\nu, C) \tag{30}$$

$$\gamma' = \gamma \theta C(\nu, B) \tag{31}$$

into the second relation one gets:

$$\frac{\alpha C(\nu)}{\sin A'} = \frac{\beta \theta C(\nu, C)}{\sin B'} = \frac{\gamma \theta C(\nu, B)}{\sin C'}. \tag{32}$$

Then we divide term by term the previous equalities:

$$\frac{\frac{\alpha}{\sin A}}{\frac{\alpha C(\nu)}{\sin A'}} = \frac{\frac{\beta}{\sin B}}{\frac{\beta \theta C(\nu, C)}{\sin B'}} = \frac{\frac{\gamma}{\sin C}}{\frac{\gamma \theta C(\nu, B)}{\sin C'}} \tag{33}$$

whence one has:

$$\begin{aligned} \frac{\sin A'}{\sin A \cdot C(\nu)} &= \frac{\sin B'}{\sin B \cdot \theta C(\nu, C)} \\ &= \frac{\sin C'}{\sin C \cdot \theta C(\nu, B)}. \end{aligned} \tag{34}$$

2. Another way:

$$A' = 180^\circ - (B' + C') \text{ and } A = 180^\circ - (B + C) \tag{35}$$

$$\tan A' = \tan[180^\circ - (B' + C')] = -\tan(B' + C')$$

$$= -\frac{\tan B' + \tan C'}{1 - \tan B' \cdot \tan C'}$$

$$\begin{aligned}
 &= -\frac{\frac{\tan B}{C(v)} + \frac{\tan C}{C(v)}}{1 - \tan B \cdot \tan C / C(v)^2} \\
 &= -\frac{1}{C(v)} \cdot \frac{\tan B + \tan C}{1 - \tan B \cdot \tan C / C(v)^2} \\
 &= -\frac{\tan(B + C)}{C(v)} \cdot \frac{1 - \tan B \tan C}{1 - \tan B \cdot \tan C / C(v)^2} \\
 &= -\frac{-\tan[180^\circ - (B + C)]}{C(v)} \cdot \frac{1 - \tan B \cdot \tan C}{1 - \tan B \cdot \tan C / C(v)^2} \\
 &= \frac{\tan A}{C(v)} \cdot \frac{1 - \tan B \cdot \tan C}{1 - \tan B \cdot \tan C / C(v)^2}.
 \end{aligned}$$

We got

$$\tan A' = \frac{\tan A}{C(v)} \cdot \frac{1 - \tan B \cdot \tan C}{1 - \tan B \cdot \tan C / C(v)^2}. \quad (36)$$

References

1. Smarandache F. New Relativistic Paradoxes and Open Questions. Somipress, Fes, 1983.
2. Smarandache F. Oblique-Length Contraction Factor in the Special Theory of Relativity, *Progress in Physics*, 2013, v. 1, 60–62.
3. Einstein A. On the Electrodynamics of Moving Bodies. *Annalen der Physik*, 1905, v. 17, 891–921.
4. Smarandache F. Absolute Theory of Relativity and Parameterized Special Theory of Relativity and Noninertial Multirelativity. Somipress, Fes, 1982.

Remark on Possible Binary Companion of the Sun: Towards a Symmetric Cosmology model which may be called Quantum Liquid Dirac-Milne (QLDM) model

Victor Christianto, Florentin Smarandache, Yunita Umniyati

Victor Christianto, Florentin Smarandache, Yunita Umniyati (2021). Remark on possible binary companion of the sun: towards a symmetric cosmology model which may be called Quantum Liquid Dirac-Milne (QLDM) model. *Octagon Mathematical Magazine* 29(1), 342-347

1 Abstract

In a recent paper, we review our previous paper where we put forth an argument that from Bohr-Sommerfeld quantization rules we can come up with a model of quantized orbits of planets in our solar system, be it for inner planets and also for Jovian planets. Now, considering a well-known problem of asymmetry between matter-antimatter in cosmology studies[18], we discuss how we can solve this problem by put forth a new conjecture that there are large scale antimatter in the form of negative masses in this Universe, hence avoiding the problem of matter-antimatter asymmetry. Subsequently, we argue that provided that Newton-Schrödinger approach to planetary quantization may be problematic, then perhaps it is time to consider Dirac-Milne cosmology with its extension to quantum liquid, especially in the context of symmetric cosmology.

2 Introduction

In a preceding article, we introduced some new disputes on the theoretical little star thought to be a partner to our Sun, known as the Nemesis, which is proposed to explain a clear example of mass destructions in Earth's history.

Some speculated that such a star could impact the hover of comet shower in the far outer close planetary framework, sending them on a brief training with Earth. While continuous infinite surveys fail to find any verification that such a binary companion star exists, we present in this article some theoretical arguments including our own, proposing that such a small star buddy of the Sun stays a possibility. Also, one great marker for such a bantam buddy of the Sun is Sedna, a planetoid which has been found around 2004 by Mike Brown and his Caltech group. Sedna area and unconventional circle are with the end goal that it should be there [1][6]. Therefore a physical explanation of why Sedna is located there can be a good start to begin to search the existence and location of the supposedly dwarf companion of the Sun. Strikingly, we can comment here that condition above is actually the equivalent with what is gotten by Nottale utilizing his Schrödinger-Newton formula [12]. In this manner here we can check that the outcome is the equivalent, it is possible that one uses Bohr-Sommerfeld's quantization rules of Schrodinger-Newton condition. The relevance of condition above can incorporate that one can anticipate new exoplanets (i.e., extrasolar planets) with noteworthy outcome. Consequently, one can find a neat correspondence between Bohr-Sommerfeld quantization rules and development of quantized vortices in united issue structures, especially in superfluid helium [1]. Here we propose a guess that superfluid vortices quantization runs additionally give a decent depiction to the planetary circles in our Solar System. A thought that given the science structure of Jovian planets are unique in relation to inward planets started around 15 years prior, in this manner it is likely both arrangement of planets have diverse cause. By accepting inward planets circles have distinctive quantum number from Jovian planets, here by utilizing "least square difference" method (with the help of a computer spreadsheet program) so as to look for the most ideal straight line for Jovian planets circles in an alternate quantum number. At that point it came out that such a straight line must be displayed on the off chance that we accept that the Jovian planets were begun from a twin star framework: the Sun and its partner, utilizing the idea of reduced mass, as we often find at solid state physics textbooks. Although based on statistical optimization, it yields new prediction of 3 planetoids in the outer orbits beyond Pluto, from which prediction, Sedna. A figure as shown below shows results of our simple model based on large-scale quantization inspired by Bohr-Sommerfeld's rule obtains a remarkably good prediction compared to observation:

3 Extension to symmetric Dirac-Milne cosmology is possible

In the previously mentioned segments, we set forth a contention for low temperature material science model of nearby planetary group, specifically utilizing Bogoliubov-de Gennes conditions which are typically used for superconductors. While this makes the model somewhat less difficult and understandable, one may

Object	No.	Titius	Nottale	CSV	Observ.	Δ , %
	1		0.4	0.43		
	2		1.7	1.71		
Mercury	3	4	3.9	3.85	3.87	0.52
Venus	4	7	6.8	6.84	7.32	6.50
Earth	5	10	10.7	10.70	10.00	-6.95
Mars	6	16	15.4	15.4	15.24	-1.05
Hungarias	7		21.0	20.96	20.99	0.14
Asteroid	8		27.4	27.38	27.0	1.40
Camilla	9		34.7	34.6	31.5	-10.00
Jupiter	2	52		45.52	52.03	12.51
Saturn	3	100		102.4	95.39	-7.38
Uranus	4	196		182.1	191.9	5.11
Neptune	5			284.5	301	5.48
Pluto	6	388		409.7	395	-3.72
2003EL61	7			557.7	520	-7.24
Sedna	8	722		728.4	760	4.16
2003UB31	9			921.8	970	4.96
Unobserv.	10			1138.1		
Unobserv.	11			1377.1		

Table 1: Comparison of prediction and observed orbit distance of planets in Solar system (in 0.1AU unit) [28].

Figure 1: Comparison between observed and calculated inner and outer planetary orbit distances in the Solar System. Source: V. Christiano, Apeiron, vol. 23, July 2004. url: <http://redshift.vif.com>

ask: what are different confirmations accessible to legitimize the BdG model for the Solar framework. In this respects, permit us to submit three supporting confirmations which appear to compare to the calculated model as we illustrated previously: * Pairing of Pluto-Charon and other TNOs/KBOs seem to be attributed to the BCS/BdG pairing condition; ** pointing to low temperature physics model of Solar System; *** Solar interior has superfluid inner structure (Oliver K. Manuel et al); see for instance [19-20]. Some literatures argue that G1.9 is remnant of supernovae, others argue that G1.9 cannot be supernovae, instead it is more plausible to argue that G1.9 is brown dwarf star. Now, we refer to paper by Boney and also by Heald, who argue that (a) Dirac Feynman's interpretation of Dirac equation symmetry as requiring that antimatter is just an ordinary matter going backward in time, that is not the only possibility. Quote from Heald [13]: "If rest mass energy is not a real scalar quantity but a potential imaginary energy, then the rest mass of antimatter will have negative potential energy. Accordingly, it would follow that the total relativistic energy of a matter or antimatter particle can be described by a complex vector summing the real kinetic and imaginary rest mass energies and Newton's law of gravitation will remain valid for antimatter. Theorems of quantum physics and general relativity have shown that antimatter has negative gravitational mass, and so matter and antimatter bodies will exert mutual gravitational repulsion." Boney also suggests that it is also equally possible to interpret antimatter as having negative mass. He wrote: "Unfortunately, it seems there is no imperative to imagine antimatter moves backwards in time, at least from the Dirac Equation, if you allow negative mass solutions." [14] The notion of negative mass is admittedly quite strange for solar physics or cosmology, but it is well accepted in solid state physics and condensed matter physics. Moreover, Anastopoulos Hu argue that (b) Newton-Schrödinger equation which is quite common in some models for AQT (alternative quantum theory), especially for macroquantum physics, is quite problematic.[15] Provided arguments (a) and (b) above can be accepted, then we suggest to consider symmetry between ordinary matter and antimatter (negative mass) should be considered from the beginning of physical modelling. As such, that is why we consider Bogoliubov-De Gennes instead of Newton-Schrödinger equation. In addition, we may also consider symmetric Dirac-Milne cosmology model, which is essentially a generalized Newtonian cosmology which admits negative gravitational mass. There are growing interests to such a Dirac-Milne model in recent years. [16-17] This appears to help our suggestion of conceivable twofold buddy of the Sun as negative mass star (NMS) as we considered in a prior paper [1]. Similarly as with expected area to discover the bantam friend of the Sun, we can specify quickly here that since 2017, there is an article named as G1.9 which was seen around 60-66 AU (around Pluto/Kuiper Belt); see [21]. In this manner it very well may be a decent begin to see if the G1.9 is surely the bantam friend of the Sun that we're searching for from the beginning. Moreover, further investigations are needed to extend Dirac Milne model towards symmetric Quantum Liquid Dirac Milne (QLDM), as implicated by our superfluid dynamics model.

4 Concluding remarks

In this paper, we present a contention that Bohr-Sommerfeld quantization condition can be connected to Bogoliubov-de Gennes conditions, and hence it will in general be demonstrated that such a Bohr-Sommerfeld's quantization rules can be associated with enormous degree structure quantization, for instance, our close by planetary gathering in Solar framework. At that point we recommend to think about balance between customary issue and antimatter (negative mass) ought to be considered from the earliest starting point of physical demonstrating. Accordingly, that is the reason we consider Bogoliubov-De Gennes rather than Newton-Schrödinger condition. Furthermore, we may likewise consider DiracMilne cosmology model, which is basically a summed up Newtonian cosmology which concedes negative gravitational mass. In addition, further examinations are expected to broaden Dirac Milne model towards symmetric Quantum Liquid Dirac Milne (sQLDM), as involved by our superfluid vortices model.

References

- [1] Victor Christianto. *A Cantorian superfluid vortex and the quantization of planetary motion*. Apeiron, vol. 22, 2004;11(1):112-52. <http://redshift.vif.com>
- [2] Victor Christianto Florentin Smarandache. *On the possibility of binary companion of the Sun*. Prespacetime J, Vol. 11 No. 1, (2020)
- [3] Victor Christianto, Florentin Smarandache, Yunita Umniyati. *Towards Gross-Pitaevskiiian Description of Solar System and Galaxies*. Prespacetime J, Vol. 11 No. 3, (2020)
- [4] Sonin, E.B. *Dynamics of quantized vortices in superfluids*. Cambridge, Cambridge University Press, 2016.
- [5] Huang K. *A superfluid Universe*. Singapore: World Scientific Publishing Co. Pte. Ltd., 2016.
- [6] Victor Christianto, Florentin Smarandache, Yunita Umniyati *A Derivation of Fluidic Maxwell-Proca Equations for Electrodynamics of Superconductors and Its Implication to Chiral Cosmology Model*. Prespacetime J., Vol. 9 No. 7 (2018).
- [7] Florentin Smarandache Victor Christianto *Schrodinger Equation and the Quantization of Celestial Systems* Prog. Phys. Vol. 2, pp. 5-12 (2006).
- [8] Victor Christianto, Diego Rapoport, Florentin Smarandache *Numerical Solution of Time-Dependent Gravitational Schrodinger Equation* Prog. Phys. Vol. 2, pp. 9-11 (2007).

- [9] Victor Christianto Florentin Smarandache *An Exact Navier Stokes equation to Schrodinger equation via Riccati equation* Prog. Phys. Vol. 1 (2008).
- [10] Ildus Nurgaliev *Singularities are averted by vortices* Gravitation and Cosmology Vol. 16(4), 313-316 (2010).
- [11] Victor Christianto *On the origin of macroquantization in astrophysics and celestial motion* Annales de la Fondation Louis de Broglie Vol. 31(1), 2006.
- [12] L. Nottale *Astron. Astrophys.* Vol. 327:867-89 (1997).
- [13] Graeme Heald *Complex Energy of Matter and Antimatter*. ResearchGate.net, 2020.
- [14] Evans T.D. Boney *Negative Mass Solutions to the Dirac Equation Move Forward in Time* ResearchGate.net, 2019.
- [15] C. Anastopoulos B.L. Hu *Problems with the Newton-Schrödinger equations*. New J. Phys. Vol. 16 085007 (2014).
- [16] A. Benoit-Levy G. Chardin *Introducing the Dirac-Milne universe*. Astronomy Astrophysics manuscript no. BLC11. March 2012
- [17] Giovanni Manfredi et al. *Cosmological structure formation with negative mass*. arXiv:1804.03067v3 [gr-qc]
- [18] Brian Albert Robson *The Matter-Antimatter Asymmetry Problem*. Journal of High Energy Physics, Gravitation and Cosmology, 4, 166-178. <https://doi.org/10.4236/jhepgc.2018.41015>
- [19] O. K. Manuel, B. W. Ninham, and S. E. Friberg *J. Fusion Energy*. vol. 21, pp. 193-198 (2002).
- [20] O.K. Manuel *Proc. The Third Int. Conf. on Beyond Standard Model Phys.* pp. 307-316 (2003).
- [21] S. Reynolds, et al. *THE YOUNGEST GALACTIC SUPERNOVA REMNANT: G1.9+0.3*. <https://arxiv.org/abs/0803.1487v2>; see also [21a] Nemesis, brown dwarf star has been discovered. url: <https://www.youtube.com/watch?v=Ev7YhmKv80>

Remark on creation and dis-creation processes related to origination of charge and matter

Robert N. Boyd, Victor Christianto, Florentin Smarandache

Robert N. Boyd, Victor Christianto, Florentin Smarandache (2022). Remark on creation and dis-creation processes related to origination of charge and matter. *Journal of Cosmology, Filaments and Astrobiology* 1(1), 33-41; DOI: 10.54216/JCFA.010105

Abstract

The ubiquitous creation process of the electron-positron pairs is brought out as being due to resonant von Karman vortex streets caused by local aether flows, as related to the Kelvin-Helmholtz vortex model of the electron and positron from fluid dynamics. The origination of electric charge is discussed as being caused by the bending and slowing of infinite velocity vortex lines, where electrons and positrons exhibit continuous charge because vortex lines are captured, always bent away from a perfectly straight line, and constantly circulate internal to these particles. The ubiquitous *dis-creation* (dissociation) of atomic matter due to gamma ray resonance with the given atom, can be controlled, and can produce any manner of force desired, arising from the vicinity of the atomic dissociation site. Both processes, creation and dis-creation, can produce excess electrical energy, so we think these investigations are valuable, in this regard. As these useful matter creation processes are more deeply investigated and new technologies arise from these studies, we will be able to make any amount of any kinds of atoms we like. We will also will be able to make designer atoms which will have physical properties, as desired by us, perfectly suited for the selected application.

Keywords: Creation Process; Dis-creation Process; Origination of charge

Introduction

The origination of charge is a creation process. Infra-atomic reactors (cf. G. Le Bon) are based on *dis-creation processes*. Both these things are happening all the time, everywhere. Matter is both created and destroyed all the time, everywhere. This has already been proved by experiments and instrumented observations. Therefore, now it appears worthy to discuss how these processes may be related to origination of charge and matter. That is the topic of this short communication.

Section 1. KH electron vortex and turbulence theory

Turbulence origination of Kelvin-Helmholtz electron vortex from classical perspective (see also ref. 1)

For a non-viscous fluid, pressure exerts a force of $-\text{grad } p$ per unit volume. (There is also a gravitational aether force, g per unit volume.) The aether fluid obeys Newton's law of motion, so $dv/dt = -\text{grad } p$, as the equation of motion. (This is used to determine fluid pressure when the flow is known.)

A vorticity field is (x,y,z,t) in magnitude and direction, at any point. Lines drawn parallel to ω are called vortex lines, and their density can express the strength of the rotation, just as streamlines define the velocity field, and magnetic field lines define a magnetic field. (Such lines are not real, but greatly aid in visualization).

The line integral of the component of velocity, tangent to a closed curve, is called *circulation*, and clearly measures the amount of rotation in the vortex. Let's take a small circle surrounding an area $A = r^2$ as the path of integration. If the angular velocity is ω , then the circulation will be $2\pi r \times r \omega = 2\pi r^2 \omega$. Thus, the circulation of the fluid, per unit area, is directly proportional to the angular velocity of rotation.

Stokes's Theorem states that the circulation of a vector about any curve C , is the surface integral of the curl (del cross) of the vector over the area enclosed by C . If this is applied to the present case, we find that $\text{curl } v = 2\omega$, so that the rotation of the vortex is half the curl of the velocity. Since the divergence of the curl of a vector is identically zero, $\text{div } \text{curl } v = 0$.

This means that if we consider a tube whose walls are parallel to ω , called a vortex tube, then this tube has the same strength (the product of the area and ω), at any point. This means that the vortex tube cannot end within the fluid, and must either close into a ring, or go to a boundary.

The Kelvin-Helmholtz theorem, states that the substantial derivative of the circulation about any curve C , in a fluid of zero viscosity, vanishes. This applies to any curve C on the walls of a vortex tube, or in any surface parallel to the vorticity, and implies that vortex lines are carried with the fluid, and that the strength at any point remains constant.

If the initial state of a fluid to which the KH theorem applies, has no rotation, that is, $\text{curl } v = 0$ everywhere, the fluid will remain irrotational as it moves. This also means that if rotation exists in the vortex, it will persist for all time.

The stream function in a fluid or gas is analogous to the use of the vector potential of the magnetic fields of electric currents. From this, *the foundational basis of electromagnetism is actually a description of fluidic flows in the aether.*

Consider a vector field

$$A = kA(x,y), \tag{1}$$

where $A(x,y)$ may also vary with the time, but we will consider that later. Suppose that v is derived from A by the rule $v = \text{curl } A$. Writing this out:

$$v = i(A_y) - j(A_x), \tag{2}$$

so that $v_x = A_y$ and $v_y = -A_x$. Now, writing out the continuity equation of

$$\text{div } v = 0, \tag{3}$$

it is automatically satisfied for any function A . To find the relationship between A and the vorticity, we write out the z-component of $\text{curl } v$, to find that

$$\nabla^2 \psi = \nabla_x v_y - \nabla_y v_x - \text{div grad } A. \tag{4}$$

In considering two-dimensional motions, the vorticity of the aether fluid can only be parallel to the z-axis, since the velocity must lie in the x-y-plane and is independent of z. (The vector potential of a magnetic field satisfies the same equation, where the current takes the place of fluidic vorticity.) The above, is *Helmholtz's equation*. The one scalar function A, thus allows us to find two interrelated components of the fluid velocity.

If the aether flow is irrotational, then A will satisfy Laplace's equation, and solve the problem as well as the velocity potential ψ . In fact, A and ψ are conjugate functions. In two dimensions, they are the real and imaginary parts of a complex analytic function. The streamlines $A = \text{constant}$, are orthogonal to the equipotentials $\psi = \text{constant}$, again *pointing to the direct relation between fluidic aether flows and the Maxwell equations*.

Vortex lines have been postulated to study fluid dynamics. A vortex line has a finite strength (vorticity times area), but zero area, similar to the understanding that a dipole has zero length. The resulting vortex lines tend to propagate at infinite velocity, as long as the lines remain absolutely straight. This would be the 5th aether phase state in *Mishin's 5-phase aetherdynamics*.¹ See figure 1 below.²

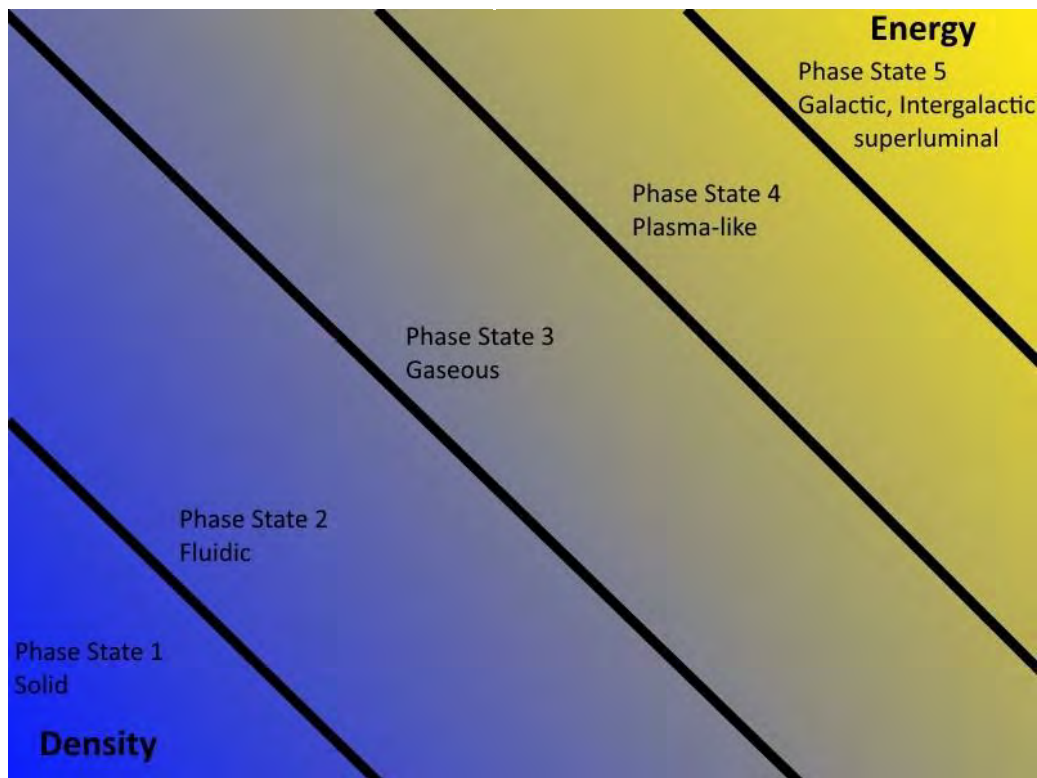

Figure 1: *Mishin's 5-phase aetherdynamics*.

¹ https://www.researchgate.net/figure/Mishins-5-phase-aetherdynamics_fig7_329072312

² In Figure 1, there is reference to phase 5: Intergalactic superluminal. A few additional note: Based on a 1972 manuscript, when he (FS) was a student in Rm. Valcea, he published in 1982 the hypothesis that 'there is no speed barrier in the universe and one can construct any speed', (<http://scienceworld.wolfram.com/physics/SmarandacheHypothesis.html>). This hypothesis was partially validated on September 22, 2011, when researchers at CERN experimentally proved that the muon neutrino particles travel with a speed greater than the speed of light. We will discuss this superluminal hypothesis in the next paper submitted to this journal.

The aether flows around an already existing, but non-motional, electron vortex in a streaming aether fluid flow, sheds vortex pairs which are rotating in opposite directions, alternately from the two sides of the KH vortex, resulting in lines made of vortices, called a “vortex street (also called a *von Kármán street*), behind it. These streets are seen on all scales, from flows in brooks, to clouds in the atmosphere, to the fluidic aether in which KH electron vortices eventually come into existence.

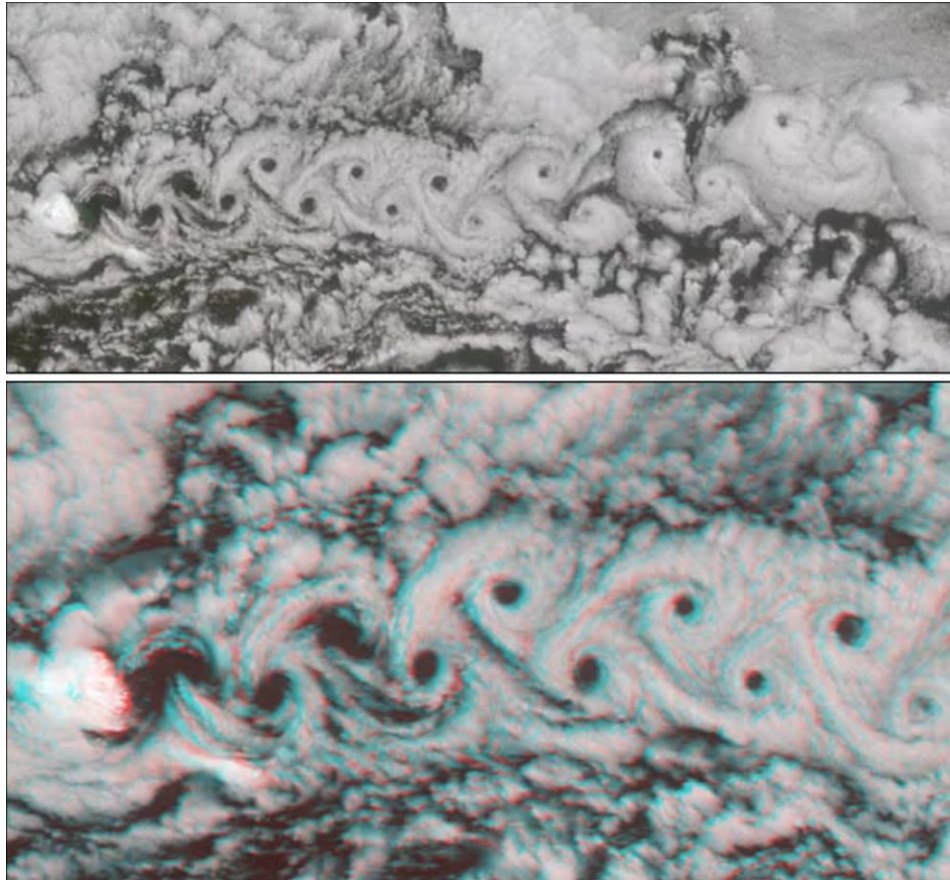

Figure 2: Photographs of von Karman streets in clouds (see also ref. [1])

Alternating transverse forces can act on a cylinder, for example a telephone wire, which can make it vibrate. This is the reason why wires sing in the wind. The wire cylinder is stationary in a stream of moving media. Behind the cylinder is a turbulent wake of slowed air. Two vortex sheets are formed on each side of the wake, and their instability results in the vortex streets (streams of vortices). Vortices are formed in a Kelvin-Helmholtz instability in the same way. Analogous effects occur in aether flows which pass around an existing electron sphere, but in this situation the resulting street of vortices form into rings, which are exactly many newly formed KH vortices.

Vortex shedding produces resonances with the object that impeded the flow. In this case, the vortices are resonant with the existing electron. This means the positron could be viewed as an anti-resonant particle. Resonance at this level will constrain the vortices in the street to form duplicates that are the same as the original forms, in terms of aether mass (constrained aether infinitesimals). This also implies that positrons can be the basis for the

formation of new electrons, in the parallel aether stream. See figure 3.

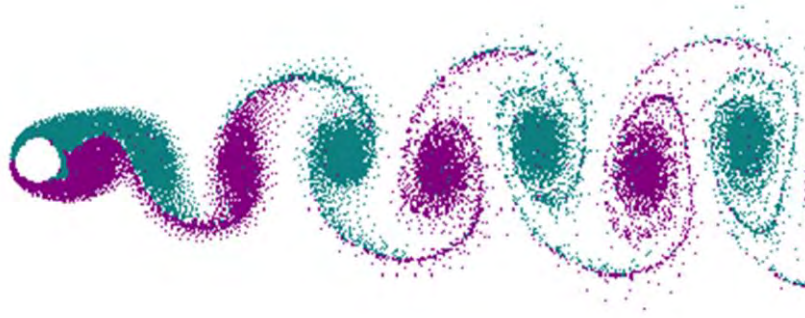

Figure 3: alternating electron-positron, alternating rotation directions (Wikipedia gif)

This raises a number of questions: Does this imply that both positive and negative charges already both exist, internal to the aether which comprises the aether winds? This implies that behaviors of obstructed aether flows are the origination of the **cause** of the distinct charges of electrons and positrons, and of electrons and protons.

The KH vortex model of the electron is simultaneously a sphere, surrounding a nest of concentric smaller vortices, which have a vortex ring at the middle of the concentric aether flows which comprise the particle. (So the ring model is only partially valid).

Section 2: KH electron vortex and origination of charge and matter

Vortex lines have been postulated to study fluid dynamics. A vortex line has a finite strength (vorticity times area), but a zero area, similar to the understanding that a dipole has zero length. Vortex lines tend to propagate at infinite velocity, as long as the lines remain absolutely straight. (This would be the 5th aether phase state in Mishin's 5-phase aether dynamics. See Figure 1.)

Importantly, the instant a vortex line departs from an absolutely straight line of propagation, **charge develops** in all the vortex lines that are bent. According to the direction of the bend, away from a perfectly straight line, a positive or a negative charge develops. In addition, with every bend in the propagation line, the vortex line is slowed to below an infinite velocity. Eventually vortex lines are moving slowly enough to comprise the 5 phase-state aether and can produce new matter through interacting with existing matter by way of “*von Karman streets*”, where there is an “aether wind” in the vicinity of the existing matter.

Parity (handedness) is directly involved in the development of charge. Parity determines the sign of the charge. The internal quantum numbers of electrons are opposite to those of positrons, which is just a restatement of the handedness (parity) of the internal aether circulation directions. The involvement of superluminal SQ infinitesimals in the formation of electrons and positrons, and superluminal internal circulations of the aether constituents of electrons and positrons, eliminates Lorentz invariance from consideration.

Lorentz invariance is only valid for the **single absolute value of c**, which value has been experimentally proven to vary by as much as plus and minus 3000 meters per second, as recorded in the handwritten log-books associated with the hundreds of repetitions of the Michelson-Moreley experiments during the last century; see ref. [7]. In addition, Lorentz invariance has nothing to do with electrons, positrons, and so on, due to the fact that invariance is only valid for exact specific-velocity photons, which are **not identical** to electrons, contrary to the expressions of Heisenberg in his first book on quantum theory.

Vortex lines circulating internal to electrons or positrons are **always** bent away from a straight line, so the vortex lines circulating internal to electrons and positrons are **always creating charge**. This is **the origination of charge** and the reason charge never ceases, as long as the charged particle exists.

In addition, the electron-positron pairs are forming in aether-connected chains, which chains are responsible for the creations of atoms, as well as protons and neutrons, in a manner which depends on how long is the “street” of connected electron-positron pairs, which in turn, become parts of the nucleus of the new atom, in terms of the atomic number of the nucleus of the atom, in an *e-p* pair model of the composition of, and the construction of, the protons and neutrons which comprise the nuclear particles of atoms.

If the parallel aether flows which are forming chains of *e-p* pairs are short-lived, we will only see hydrogen, or perhaps the occasional helium atom being generated. Longer *e-p* chains result in larger atoms. The local density of types of atoms and alignments of atoms, may give an indication of the frequency of aether wind streamlines, in that region. Proper instrumentation of vortex-line (SQ infinitesimals) resultant behaviors can be used to map astronomical space, comprising an infinite range observation capability, due to the fact that vortex lines propagate with infinite velocity.

Section 3: Creation and dis-creation processes

As we wrote above, the origination of charge is a creation process. Infra-atomic reactors (cf G. Le Bon) are based on dis-creation processes. Both these things are happening all the time, everywhere. Matter is both created and destroyed all the time, everywhere. This has already been proved by experiments and instrumented observations. The infinite volume universe has creation and dis-creation events going on everywhere all the time. Creation is ubiquitous and unending. Everything and everybody participates in creation processes.

Thermodynamics is not valid, in general, except that topological thermodynamics has some important merit. The late Prof. R.M. Kiehn made excursions into the topological thermodynamics of Pfaff Dimension 4, which is highly commended.³ Kiehn proved that volumes which topologically occupy Pfaff Dimension 4, can gain or lose energy and/or mass. Thus topological Pfaff Dimension 4 activities can involve both creation and dis-creation of both matter and energy.

The KH electron creation process described above, makes perfect sense from the von Karman “vortex street perspective, which results in electron-positron chains, which can form larger nuclear particles if the chain is long enough, and then entire atoms, if the chain of alternating electrons and protons is long enough.

The physical extent of subatomic particles such as the electron, proton, and neutron, have been measured by experiments. The stability and longevity of subatomic particles are fairly well documented. The life span of subatomic particles is incorrect though, as the proton is calculated, without physical evidence, to live for billions of years. They do not. The universal proton life-span is considerably shorter than that, on average, when universally ubiquitous gamma ray dissociations of atoms are included in considerations of the average life of a proton.

It is conjectured that when an electron captures a photon, the mass and the size of the electron increase for a short time.

This helical form of EM ties into the KH electron, during photon capture events, The captured photon causes an energetic imbalance in the desired and required stability of the electron, which causes the photon to be ejected in a short while.

³ See for instance R.M. Kiehn. *The Universal Effectiveness of Topological Thermodynamics*. April 2014. url: <https://www.amazon.com/Effectiveness-Topological-Thermodynamics-Non-Equilibrium-Irreversible/dp/1304702928>

Perhaps the formation of the electron during a creation incident causes the aether which is involved in the electron, to change its phase-state towards being a solid. This might account somewhat for the physical properties and behaviors of the electron. Does the electron change form in any way, while it is involved with an atom? Atoms are all about aether motion, ultimately.

The fact that some atoms are the same sizes as some gamma rays, can cause a resonance-breakdown, when a gamma ray, exactly the same size as the given atom, passes somewhere close to that atom, causing the entire of the atom to dissociate into the aether from whence it came. *Poof!* Gone. No other particles arise. Now liberated from participating in the particles that used to exist there, large numbers of infinite velocity vortex lines radiate from the dissociation site, starting matter creation processes anew.

If the gamma ray which causes atomic dissociation is not exactly the perfect wavelength for the given atom, the atom will break down in showers of multitudes of subatomic particles, rushing away from the former location of the atom.

Some of these particles cannot be observed during collider experiments, which are as primitive as throwing rocks at other rocks from a large distance, and then studying the small bits of rock and dust, resulting from the collision. (Look! This bit has some red in it! , all excited about the discovery.) *There is a limit to what can be produced by colliders*, based on the angles of intersection during the occasional collisions, and according to what is colliding with what.

There have been very few collider experiments involving atoms, by the way. We wonder why? We think it is because they don't want people to know what happens to **atoms** during collider experiments. Nuclear enrichment by neutron bombardment is the only collider-type event that they will allow the public to hear about.

T. Henry Moray made apparatus which involved a linear accelerator bombarding gold mine refuse, which was slowly passing through the accelerator output, on a conveyor belt. Moray's apparatus made prolific quantities of gold appear in the mine tailings refuse, as gold seed atoms, scattered through the tailings, proliferated into larger and larger numbers of gold atoms which appeared near the "seed atoms", eventually forming into gold crystals, which were directly connected to the originating seed atom. This gold-producing process was quite profitable, even considering the expenses of the equipment.

Infra-atomic interactions (resonant gamma rays and atoms) are interesting. Exact atom-gamma ray resonance will result in the entire of the atom being converted back into aether, and entirely vanishing. By controlling the exact frequency of gamma radiation, relative to a given atom, when the impacting gamma ray has a small frequency deviation, away from exact resonance with the given atom, when the atom-gamma ray interaction occurs, not only are showers of subatomic particles resulting, but specific forces of any selected kind, will arise from the reaction site. Which force arises depends on the exact frequency offset departing from exact gamma ray resonance with the given type of atom.

Heat, light, cold, attractive force, repulsive force, gravity, anti-gravity, magnetism, electric fields, anti-electric fields, propulsive force, indeed, whatever kind of force you would like, will be radiated from the infra-atomic interaction site, directly controlled by the gamma ray frequency offset, relative to the given atomic element. Since this is not exact resonance, some subatomic particle effluvia will result, and must be accounted for, *for safety reasons*, in the local environment surrounding the reactor.

Section 4. Remark on Tesla's magnifying transmitter

Telsa's magnifying transmitter produces streams of aether which radiate from the electrical explosion point at the rate of $1/r$. This apparatus is what is required to produce prolonged streams of aether, with close to parallel emanations of aether, to create matter in the von Karman vortex aether creation model of matter production. The strength and duration and duty cycle of the magnifying transmitter operation determine how many e-p pairs are created in a string, which determines what kinds of atoms will be created. Thus kinds of atoms created can be directly controlled through controlling the operational parameters of the magnifying transmitter.

This is vastly superior to destructive and limited collider techniques, which are only able to make isolated pairs. The magnifying transmitter approach can make strings of selected numbers of e-p pairs, thus producing selected types of atoms.

Tesla's magnifying transmitter technology needs to be re-awoken to make this available. Many additional capabilities are available from Tesla's magnifying transmitter apparatus, such as wireless and safe transmission of electrical power and wireless communications which do not cause any hazards to life-forms.

Section 5. Concluding note: Practical and potential implications of the proposed view

In this article, we discuss shortly on creation and dis-creation processes related to origination of charge and matter by the production of any force you like, especially from Kelvin-Helmholtz electron vortex theory. Both processes, creation and dis-creation, can produce excess electrical energy, so we think such an investigation is worthy to continue.

When the matter creation process is deeply investigated and technologies arise from the studies, we will be able to make any amount of any kinds of atoms we like.

Later, after deeper investigations, we will be able to make *designer atoms* which will have physical properties, as desired by us, perfectly suited for the selected specific application.

For example, Gustave Le Bon made an "*infra-atomic*" reactor, which he designed to produce electricity. Le Bon stated that any kind of atom could be used as fuel. His reactor was so efficient, he stated that after 100 years of continuous operation, at 500 kilowatts, the atomic material he used would be measured to have lost approximately 1 gram of weight, the lost matter having reverted into the aether.[3]

Using the same principles as outlined above, when sufficient control of atom parameters becomes available, we could produce a version of the metal lead with atoms which do not melt until 2000° C temperature is exceeded. (This example was accomplished by *T. Henry Moray*, during the 1950s. Moray sent useful weights of samples of his new form of lead to many Universities, chemical suppliers and chemical manufacturers for them to examine and experiment with. None of them responded. See also Ref. [6])

There will be limits regarding which atomic parameters can be controlled, and to what extent the physical properties of the given atomic element can be changed, which will be specific to that kind of atom.

However, tailored combinations of tailored atoms can manufacture new kinds of materials, and new kinds of custom-tailored alloys, with amazing physical properties.

In the sequence of new technology developments related to *matter-creation processes*, we will eventually be able to make complicated large objects, such as extraordinarily capable automobiles, on an atom-by atom basis.

Soon after that stage is reached, we will be able to mass produce anything we choose, on an atomic basis, at no cost for the materials, and no cost for the automated assembly. The item can be made an integral whole, with no bolts or rivets or welds or adhesives required to assemble the unit on an atom-by-atom basis.

Eventually, making new cars on an atomic basis, will be as easy and convenient as printing a page out of your computer.

Acknowledgement

The authors wish to extend gratitude for discussions with many scholars, including to the late Prof. Robert M. Kiehn (Univ. of Houston, USA). An earlier version of this manuscript has been presented at *Physics Beyond Relativity Conference*, October-November 2019, held at Prague, Czech, host by Prof. Jan Rak. Url: <https://science21.cz/conference/?p=858>

References:

- [1] Victor Christianto, Florentin Smarandache, & Robert N. Boyd. Electron Model Based on Helmholtz's Electron Vortex Theory & Kolmogorov's Theory of Turbulence. *Prespacetime Journal*, Volume 10, Issue 1, January 2019, pp. 139-148. url: www.prespacetime.com
- [2] E. Charpentier, A. Lesne N. Nikolski. *Kolmogorov heritage in mathematics*. Heidelberg: Springer-Verlag Berlin Heidelberg, 2007, p. 25
- [3] <https://www.nuenergy.org/intra-atomic-energy-and-the-forces-derived-therefrom/>
- [4] J. Vranjes. Tripolar vortex in plasma flow. *Planetary and Space Science* 47 (1999) 1531-1535
- [5] M.N. Nishino et al., A case study of Kelvin-Helmholtz vortices on both flanks of the Earth's magnetotail. *Planetary and Space Science* 59 (2011).
- [6] G. Vassilatos. *Lost Science*. Adventures Unlimited Press. One Adventure Place, Kempton, Illinois 60946-0074
- [7] V. Christianto, R.N. Boyd, F. Smarandache. There is no constant in physics: a Neutrosophic Explanation. *International Journal of Neutrosophic Science*, Vol. 1 No. 1 (2021). url: <http://americaspj.com/articleslist/21/27/26>

A New Hypothesis of Spin Supercurrent as Plausible Mechanism of Biological Nonlocal Interaction, Synchronicity, Quantum Communication

Yunita Umniyati, Victor Christianto, Florentin Smarandache

Yunita Umniyati, Victor Christianto, Florentin Smarandache (2022). A New Hypothesis of Spin Supercurrent as Plausible Mechanism of Biological Nonlocal Interaction, Synchronicity, Quantum Communication. In K. S. Essa, k. H. Mahmoud, & Y. H. Chemin (Eds.), *Magnetosphere and Solar Winds - Humans and Communication*. IntechOpen. DOI: 10.5772/intechopen.102743

Abstract

We start with citing a seminal paper by Josephson-Pallikari-Viras, that biological entities can be assumed to be able to communicate nonlocally, i.e., instantaneously. However, they also admit that the underlying mechanism of such an entangled communication is not clear yet from the wave mechanical equations. Similar arguments have been pointed out by several authors, citing that quantum equations themselves have not described anything on a possible mechanism of quantum-type interaction between two biological entities. This chapter intends to fill that research gap by suggesting a new hypothesis of spin supercurrent as a physical mechanism, based on the assumption of macroquantum condensate having nonlocal effects. Moreover, we also draw several potential applications including superconductor quasi-crystalline structure of space and plausible new method of quantum communication. Such an argument is outlined herein partly based on our personal encounter with astrophysical quantization in the past 17 years or so.

Keywords: biological nonlocal interaction, quantum nonlocality, entanglement, spin supercurrent, superfluid dynamics, superconductor quasicrystalline, quantum communication

1. Introduction

In a seminal paper by Prof. Brian Josephson—Pallikari-Viras, they argued that despite quantum nonlocal interaction tends to be undetected by statistical averaging, but by assuming macroquantum system, biological entities can be assumed to be able to communicate nonlocally, i.e. instantaneously. However, they also admit that the underlying *mechanism* of such an entangled communication is not clear yet from the wave mechanical equations [1, 2].

Actually, it is known for a long time that quantum physics allows quantum correlations—common reliance of attributes of wave capacity of supposed entangled quantum substances while there is space partition. This may include a phenomenon called the near-field antenna effect, i.e. the presence close to radio wire (a wavering electric dipole) of superluminally spreading electromagnetic field [3].

Nonetheless, various arguments have been pointed out by several authors, citing that quantum equations themselves have not described anything on the possible mechanism of quantum-type interaction between two biological entities.

In this chapter, we will discuss some existing literature and then we come up with a new hypothesis that spin supercurrent provides the sought-after physical mechanism for biological nonlocal interaction, synchronicity, and plausible new quantum communication method.

2. Literature survey

2.1 Wave mechanics equations

In quantum mechanics, the depiction of action of the field-free magnetic vector potential depends on Schrödinger's equations without presenting any actual inter-action. As the activity of the field-free magnetic vector likely takes place in space where the electromagnetic field is missing, this potential has both non-electric and non-attractive nature. While there are researchers who did try to develop an electric representation of quantum wave mechanics, such as Gabriel Kron, but it did not give new results, as far as our knowledge. Moreover, in our previous book, Shpenkov and Kreidik have shown that Weyl provided cut-off to solutions of the original Schrodinger equation (3D), to achieve a quite good agreement with experimental data at the time. It is clear that in most textbooks on QM, whenever the authors discuss solutions of spherical Schrodinger equations, they rarely compare the results with actual experimental data, because they know, there is no agreement at all between spherical wave mechanics and experiment. It should be clear, that despite fairytale stories have been circulated to invoke certain mystical elements to wave mechanics origin, the fact is, it was a failed attempt since the beginning [4].

2.2 Classical EM theory approach

As Boldyreva wrote, which can be paraphrased as follows: “EM hypothesis portrays field-free magnetic vector potential. In traditional electrodynamics, the magnetic field of acceptance B is resolved by condition $\text{curl} = B \text{ curl } A$, where A will be an attractive vector potential. In protecting of attractive field, $0 = B$, the accompanying may happen: $0 \neq A$. This case is alluded to as the without field vector potential. Magnetic vector potential has its very own actual significance. In 1949, Erenberg furthermore Siday anticipated the capacity of attractive vector potential to impact straightforwardly the attributes of quantum substances despite the fact that there is no electromagnetic field at the area of the elements. In 1959, the chance of such an impact was considered by Aharonov and Bohm. Hence, an extraordinary number of tests have been directed which affirmed the hypothesis” [3].

2.3 Macroquantum condensate hypothesis

Here allow us to mention our chapter in a journal of Foundation Louis de Broglie 2006, suggesting that astrophysical quantization can be explained for instance by assuming macroquantum condensate of astrophysical bodies [5].

Provided such astrophysical macroquantum effects can be accepted, then it seems not so hard to suppose that under certain circumstances biological nonlocality interaction can happen, once we assume similar macroquantum condensates.

2.4 Spin supercurrent in superfluid helium

What we can read in some recent papers by Liudmila Boldyreva, she puts forward an argument of the existence of spin supercurrent to mediate biological quantum-type interactions [3].

Boldyreva wrote among other things, which can be paraphrased as follows:

“This work proposes basically another way to deal with portrayal of the above-thought about peculiarities: specifically, it is shown that it is conceivable to portray these peculiarities as far as such actual interaction as spin supercurrent. The twist supercurrent arises between objects having turn, and its activity will in general make equivalent the individual characteristics of precession of twists of collaborating objects. (Note that Yuri Bunkov, Vladimir Dmitriev and Igor Fomin were granted the Fritz London Memorial Prize in 2008 for the investigations of spin supercurrents in superfluid 3 He-B).”

In this model, quantum correlations between quantum entities may be performed by spin supercurrent emerging between virtual photons (virtual particles pairs) created by those quantum entities.

2.5 Carl Jung’s synchronicity

Limar wrote a review on the possible link between Carl Jung’s concept of synchronicity with quantum non-local effect, known as entanglement. He argues in favor of cellular level or DNA level quantum type interaction, such as meiosis etc. Nonetheless, he also admits that many paper streams on this subject are plagued by the non-existence (as yet) of the physiological or physical mechanism of such non-local interaction [6].

2.6 Research gap

Similar arguments have been pointed out by several authors, citing that quantum equations themselves have not described anything on the possible mechanism of quantum-type interaction or communication between two biological entities. This chapter intends to fill that research gap by suggesting a new hypothesis of spin supercurrent as the physical mechanism, based on the assumption of macroquantum condensate having nonlocal effects. Moreover, we also draw several potential applications including superconductor quasi-crystalline structure of space and plausible new method of quantum communication. Such an argument is outlined herein partly based on our personal encounter with astrophysical quantization in the past 17 years or so.

3. A new hypothesis

If now we put all the above findings from macroquantum condensate (or close to superfluid 3 He) to spin supercurrent, hence, we come up with a new hypothesis, that we will state here for the first time:

3.1 Hypothesis

“There is spin supercurrent to be observed to mediate interaction between biological entities, between consciousness which known as synchronicity (in Jungian term), and also to provide quasi-crystalline structure of space, and in turn, it allows a new model of quantum-type nonlocal communication.”

3.2 Simple physical model

According to Bunkov and Volovik, the superfluid current of twists—turn supercurrent—is another agent of superfluid flows, for example, the superfluid current of mass and molecules in superfluid 4He; superfluid current of electric charge in superconductors [7].

According to Boldyreva, such spin supercurrent mechanism can be helpful to mediate biological nonlocal interaction, can be modeled as follows:

$$J_z = g_1(a_1 - a_2) + g_2(t_1 - t_2), \quad (1)$$

where g_1 and g_2 are coefficients depending on deflection angles and the properties of the medium where spin supercurrent emerges. Turn supercurrent is certainly not an electric or attractive interaction and therefore it is not protected by electromagnetic screens [3].

Moreover, Boldyreva also argues that such a spin supercurrent interaction can find implications in alternative medicine, which can be paraphrased as follows: “...a deterministic portrayal of the association is utilized, which continues as per the laws overseeing the conduct of sub-atomic fluid when the temperature of the last option is near outright zero (the properties of superfluid 3He-B). This methodology concurs with E. Schrödinger’s perspective communicated in his book ‘*What is life?*’, i.e. “The living organic entity is by all accounts a naturally visible framework which to a limited extent of its conduct ways to deal with that absolutely mechanical (as differentiated with thermodynamical) direct to which all frameworks tend, as the temperature moves toward outright zero and the atomic problem is taken out” [8].

4. Sideways and rationale

4.1 Our personal encounter with macroquantum condensate astrophysics

This segment permits us to recount an account of our experience with macroquantum condensate in astrophysics. Everything started by a to some degree “reasonable deduction” (or readers might call it: *einführung*), when one of us (VC) got an old book by Nozieres and Pines [9], on superfluid Bose liquid. He inquired: Let us see what this

book can bring to the domain of astronomy and cosmology. Before long, he tracked down many fascinating discoveries with regards to the writing, from W.H. Zurek to Grigory Volovik and so forth. That is the start of our undertaking for more than 18 years up to this point, coming about a few papers in a series [5, 10–14]. The soonest paper called “Cantorian superfluid vortex hypothesis” was distributed in January 2004, where VC presented a forecast of potential areas of three new circles of planetoids on the external side of Pluto. Then, at that point, after 2 years, VC distributed a paper in AFLB [5], where he laid out what are potential clarifications of macroquantum impacts in astronomy (for example, noticed likewise by Tiffit and furthermore Virginia Trimble and so forth). One of the contentions in that AFLB paper is macroquantum condensate, for example, conceivable quantum impact actuated by BEC or superfluid-type medium [5].

More recently, we (VC, FS, YU) come up with an argument of cosmological entanglement supposing such a macroquantum effect is real.

4.2 Observational evidence

4.2.1 Quantization of planetary orbit distances in the solar system

In this section, we will review the work and results by us, during the past 17 years or so. The basic assumption here is that the Solar System’s planetary orbits are quantized. But how do their orbits behave? Do they follow Titius-Bode’s law? Our answer can be summarized as follows (**Figure 1**):

Navier-Stokes equations --> superfluid quantized vortices --> Bohr’s quantization rule

Figure 1.
From NS turbulence to quantized vortices.

And it seems that the proposed model is slightly better compared to Nottale-Schumacher’s gravitational Schrödinger model and also Titius-Bode’s empirical law [1, 11].

The evidence of quantization of planetary orbit distances seem to suggest to wave mechanics model at a large scale [5, 10–14]. See also Peter Coles [15].

4.2.2 Observational finding on cosmological entanglement

Interestingly there is a recent report from MIT suggesting that ancient quasars support such quantum entanglement at large-scale phenomena. In an article, it is reported about the possibility of cosmological entanglement [16], which can be paraphrased as follows:

“In 2014, ... the William Herschel Telescope and the Telescopio Nazionale Galileo, both located on the equal mountain and separated via about a kilometer. One telescope focused on a particular quasar Meanwhile, researchers at a station located between the two telescopes created pairs of entangled photons and beamed particles from each pair in contrary directions toward every telescope” [17].

Therefore, such a discovery has opened up a new way to look at the Universe: *an entangled Cosmos* [18, 19].

4.2.3 Newtonian action at a distance: Smarandache's

Hypothesis expresses that there is no speed limit of anything, including light and particles [20]. Eric Weisstein likewise composed ramifications of Smarandache's Hypothesis [21], which can be summarized as follows: "...the speed of light c is as of now not a biggest at which estimations can be sent and that abstract speeds of data or mass switch can occur. These confirmations fly notwithstanding every idea and investigation, as they misuse both Einstein's exceptional rule of relativity and causality and don't have any test support. It is genuine that current preliminaries have confirmed the presence of positive sorts of quantifiable superluminal quirks." [21].

While the thought is very basic and in view of known speculation of quantum mechanics, called Einstein-Podolski-Rosen bridge, actually such a superluminal material science appears to be still difficult to acknowledge by the greater part of physicists. Beginning around 2011, there was a clear astounding outcome as declared by the OPERA group. Regardless, hardly any months after the fact, it was disavowed on the ground of mistakes in dealing with the estimation.

Permit us to offer not many remarks on such a clear inability to identify quicker than light speed as follows: Despite those discussions over the OPERA results, we believed that a seriously persuading test has been finished by Alain Aspect and so on; he had the option to show that quantum non-territory association is genuine. In 1980, Alain Aspect played out the first EPR try (Einstein-Podolski-Rosen) which demonstrated the presence of room nonlocality (Aspect 1982). Alain Aspect and his group at Orsay, Paris, led three Bell tests utilizing calcium course, i.e. the first and last utilized the CH74 disparity. The second was the first use of the CHSH imbalance.

The third (and generally well known) was organized with the end goal that the decision between the two settings on each side was made during the flight of the photons (as initially proposed by John Bell). A few experimenters demonstrated a comparative outcome until the distance of more than 90 km.

So, the thought of "spooky action at a distance" is a genuinely actual peculiarity. In addition, activity a way off was at that point referenced in Newton's *Principia Mathematica*. Regardless of obviously Einstein was attempting to make each of Newton's demeanors into nothing, our result suggests that the Maxwell equations in classical electrodynamics have "spooky interaction at a distance" type of interactions (as it has also been proven for Coulomb potential), which might be noticed both at limited scope tests just as in a cosmological scale, as ongoing confirmations show similar effect at a distance in relation to Smarandache's hypothesis.

4.2.4 Evidence of Cooper-pair tunneling in nuclei is likely to indicate superfluid vacuum model instead of gluon

In a recent report published in *Phys. Rev. C*, Potel et al. wrote on a breakthrough on the subject was made through the study of one- and two-neutron transfer reactions with heavy-ion collisions in inverse and direct kinematics, enabled by the use of magnetic and γ -ray spectrometers, which suggest that there can be Cooper-pair tunneling in nuclei [22]. In retrospect, this finding seems to indicate that the superfluid vacuum model can be a better approach than the gluon model as in the Standard Model. See also [23, 24].

Besides, the superfluid nuclear matter hypothesis is known for a quite long time, especially going beyond BCS theory, cf. Walecka, Matsuzaki, Lombardo *etc.* [25, 26].

4.2.5 Initial evidence on the synchronicity between patient and doctor

In a 2008 article, Alex Hankey argues in favor of Macroscopic Quantum Coherence in Patient-Practitioner-Remedy Entanglement. An interesting remark in his article goes, which can be paraphrased as follows: “A different relationship length implies that the quantum cognizance’s initially infinitesimal connection length currently becomes naturally visible. We reason that, for the most part, at every basic pre-carefulness (remembering input dangers for natural administrative frameworks), quantum vacillation fields display plainly visible quantum cognizance” [27].

Although he did not come up yet with a clear physical mechanism of such macro-quantum coherence, one can arrive at a similar hypothesis of spin (supercurrent) interaction like Boldyreva’s, as it is known in biological phenomena. See Likhtenshtein [28].

4.2.6 Initial evidence on galactic synchronicity

Although it is known that “One of the cornerstones of inflationary cosmology is that primordial density fluctuations have a quantum mechanical origin,” as Kanno & Soda wrote, however, most physicists consider that such quantum mechanical effects disappear in CMB data due to decoherence [29].

We have discussed before that cosmological entanglement has been observed, which in turn, it can be attributed to the superfluid turbulent interstellar medium.

Presently, there is a new striking report by Charlotte Olsen et al., proposing that 36 cosmic systems appear to have “facilitated” in a such way that they seem to give synchronized stars arrangement. From Olsen et al. paper, they do not give a potential hypothetical explanation [30].

Notwithstanding, by theorizing such a twist supercurrent system likewise can occur at cosmic scale in view of superfluid interstellar medium, we can concoct a “potential” clarification, that such a lucid star arrangement is because of some sort of “galactic synchronicity.” We know that such a term is not accessible yet in present cosmological vocabularies, however, we can predict that time for that term will come as well, as there is likewise a book, proposing that synchronicity is probably going to show up all around in Cosmos [31].

4.2.7 Other experimental results

Other reports seem to indicate that there are reasons to believe such a quantum effect between consciousness, mind-matter interaction, and also Aharonov-Bohm type interaction in the superfluid vortex [16, 32, 33]. Suter et al. also provide other experiment evidence, as they wrote in the abstract: “The data unambiguously show that Bz clearly deviates from an exponential law and represent the first direct, model independent proof for a nonlocal response in a superconductor” [34].

5. Discussion: four plausible applications in various fields

- a. A new theoretical model of high-temperature superconductivity may lead to extremely efficient energy generation and transmission

- b. A new type of electronic device.
- c. Superconductor quasi-crystalline vacua hypothesis.
- d. The plausible new method of quantum communication.

The explanation for each of the aforementioned plausible applications will be discussed shortly below:

5.1 A new theoretical model of high-temperature superconductivity may lead to extremely efficient energy generation and transmission

It is known that a superconductor permits the flow of current without resistance. The conventional way of thinking about the transition from normal to superconducting is called the Bardeen-Cooper-Schrieffer (BCS) theory. But last year, H. Koizumi, a researcher at Tsukuba University has announced a new theoretical model of high-temperature superconductivity, which may lead to extremely efficient energy generation and transmission. Instead of focusing on the pairing of charged particles, this new theory uses the mathematical tool called the Berry connection. This value computes a twisting of space where electrons travel. In the standard BCS theory, the origin of superconductivity is electron pairing. In this new theory, the supercurrent is identified as the dissipation less flow of the paired electrons [35]. We will discuss later; we may come up with an alternative method of quantum communication based on such Berry connection.

5.2 A new type of electronic device

Hua Chen et al. wrote experimental evidence which can lead to a new type of electronic device based on spin supercurrent, according to their abstract which can be paraphrased as follows: “In slight film ferromagnets with amazing simple plane anisotropy, the part of absolute twist perpendicular to the simple plane is a decent quantum number and the relating turn supercurrent can stream without scattering. In this Letter we clarify how turn supercurrents couple spatially remote turn blending vertical vehicle channels, in any event, when simple plane anisotropy is flawed, and examine the likelihood that this impact can be utilized to manufacture new kinds of electronic device” [36, 37].

5.3 Superconductor quasicrystalline vacua hypothesis

As we discussed in a forthcoming paper [38], we discuss on the possibility that the space consists of discrete cells, to become cells composed of superconductor quasi-crystalline. We put forth a new hypothesis that the discrete cellular structure of space consists of cells of superconductor quasi-crystalline. It is argued that the definition of quasicrystals should not include the requirement that they possess an axis of symmetry that is forbidden in periodic crystals. The term “quasicrystal” should simply be regarded as an abbreviation for “quasiperiodic crystal,” possibly with two provisos.

To sum up, quasicrystals display a non-periodic, yet ordered, arrangement of atoms. They contain a small set of local environments which reappear again and again, albeit not in a periodic fashion. Their structure is not random either, since the diffraction pattern shows sharp Bragg peaks, although their symmetry is noncrystallographic,

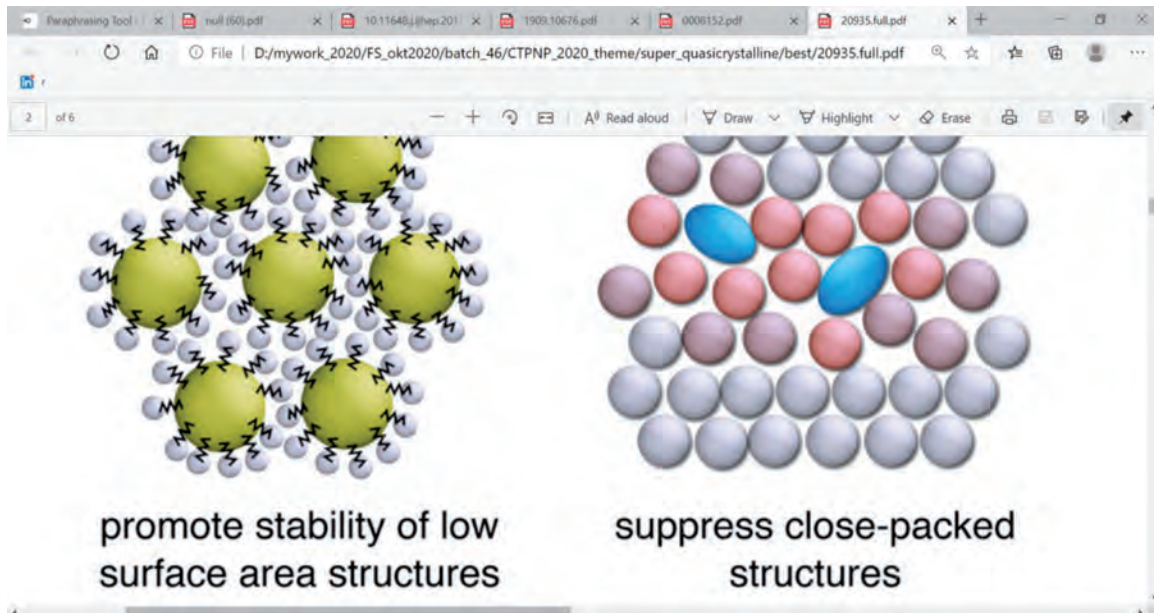

Figure 2.
Plausible assembly of soft-matter quasi-crystal.

with the n -fold symmetries ($n = 5, 8, 10, \dots$) stemming from the fact that these local environments occur with n equiprobable orientations. A recent discovery suggests that quasi-crystalline has a superconductive phase at a very low temperature [39].

It may resemble Finkelstein's hypercrystalline model of vacuum. What if the quasicrystalline model is not in semiconductor solid...but a superconductor quasicrystalline? We may call it: super-crystalline structure of 3D space.

Quasicrystalline solid is also good because it brings in more than three dimensions, which may be very relevant. This would also bring in Finkelstein and Penrose and some of Frank Tony Smith's investigations. The next item to consider is a super-quasicrystalline solid (SQC).

Because of its fractal properties, we can expect that the SQC can extend down to the structure of space, similar to what Finkelstein envisaged [40].

The quasicrystal structure of space may be composed of solid matter or soft matter, of which its general dynamics have been outlined by Fan et al. [41]. Plausible assembly of soft matter quasicrystal is shown in **Figure 2**:

It exhibits close-packed structures. This dense-packed structure of space should be verified with experiment. A few observables:

5.4 Natural quasicrystal in rock:

Steinhardt and Bindi [42] argued a unique hypothesis, proposing that quasicrystals might conceivably be pretty much as hearty and steady as gems, maybe, in any event, framing normally. These contemplations roused a very long term look for a characteristic quasicrystal finishing in the revelation of icosahedrite ($\text{Al}_{63}\text{Cu}_{24}\text{Fe}_{13}$), an icosahedral quasicrystal found in a stone example made fundamentally out of khatyrkite (translucent $(\text{Cu}, \text{Zn})\text{Al}_2$) named as coming from the Koryak Mountains of far eastern Russia. In their paper, they contended that the examination demonstrates the example to be of an extraterrestrial beginning (**Figure 3**).



Figure 3.
Light image of entire MSNF specimen prior to sampling, Khatyrka CV₃ meteorite [42].

Moreover, some papers argue that such a rock may be of manmade origin, as Bindi et al. noted:

“The proof for the presence of the quasicrystal deliberately work in the stone is thusly predominantly solid. Be that as it may, the perception of intermetallic compounds with copper and iron, which requires a profoundly lessening climate, is profoundly bewildering. It raises the likelihood that the example started from slag or another anthropogenic interaction. Nonetheless, the example was found in a far-off locale exceptionally a long way from any modern action.” [43]

While we admit that it would need further studies, as we see it such a hypothetical origin of meteorites and rock from extraterrestrial or manmade origin remains puzzling. It may be more possible to argue in favor that the quasicrystalline that happens in nature was caused by the structure of space itself is composed of SQC.

5.4.1 Natural quasicrystals in the solar system

Luca Bindi and also Matthias Meier et al. seem to suggest that quasicrystals have a cosmic origin [44, 45]. While such a hypothesis is quite reasonable, allow us to add a possibility that such a cosmic origin might yield from hidden structure of space itself. Such a hypothetical origin may be more “workable” than most quantum gravity hypotheses [46].

What is more interesting here is that Sakai has presented superconductor effects of quasicrystals [47].

5.4.2 A plausible new method of quantum communication

Inspired partly by Koizumi’s research at Tsukuba Univ., we may come up with an alternative method of quantum communication based on such Berry

Super-crystalline vacua -> Berry connection -> spin supercurrent -> nonlocal information transmission -> quantum communication system.

Figure 4.
A process flow of quantum communication based on Berry connection.

connection. Prof. M.V. Berry is widely known for his research, but mostly for his theorem called Berry phase and Berry connection, which are often linked to the Aharonov-Bohm effect.

While there are various researchers who have come up with a number of possible quantum information or quantum internet methods, such as Pomorski & Staszewski, who wrote: “The idea of quantum web was.

displayed in this work. The more definite picture requires considering different impacts as decoherence processes that drive the quantum position-base qubit out of its cognizance just as decoherence processes that annihilate the cognizance of qEC (quantum Electromagnetic Cavity) [48].

Nonetheless, just yesterday an idea came to us, inspired by Berry connection and also crystalline structure of space. Actually, Tesla came up first with an idea to propagate telecommunication with the help of the telluric field of Earth, but alas it was canceled because Marconi obtained the patent first before him.

As we mentioned above, Sakai presented evidence of superconductivity of quasi-crystal, therefore provided, we accept the super-quasi-crystalline model of 3D space, we may come up with an idea that can be considered as quantum communication built on the crystalline structure of space itself. The outline of our idea is as follows, as we began to read papers by Prof. Michael V. Berry from UK (**Figure 4**):

If we can prove this can work, at least a conceptual design, then may it can be a quite viable alternative to the 5G cellular network.

Moreover, such an assumption of superconductor crystalline structure of space, it seems to find support from our descriptive model of the Solar System in terms of superconductors. See our recent paper [49, 50].

6. Concluding remarks

In this chapter, we discuss how conventional wave mechanics does not provide a physical mechanism which is supposed to mediate nonlocal biological interaction, as discussed by Josephson-Pallikari Viras and others. Based on the hypothesis and also research findings by Yuri Bunkov, L. Boldyreva et al., we submit wholeheartedly that a new hypothesis of spin supercurrent is the sought-after physical mechanism, based on the assumption of macroquantum condensate having nonlocal effects.

In the last section, we discuss four plausible applications of such a scheme, including: a. A new theoretical model of high-temperature superconductivity may lead to extremely efficient energy generation and transmission; b. A new type of electronic device; c. Superconductor quasi-crystalline vacua hypothesis; d. Plausible new method of quantum communication. Clearly, more research is recommended to verify further what we outlined herein.

References

- [1] Josephson BD, Pallikari-Viras F. Biological utilization of quantum nonlocality. *Foundations of Physics*. 1991;**21**(2):197-207
- [2] Josephson BD. The discovery of tunnelling supercurrents. *Reviews of Modern Physics*. 1973;**46**(2):251
- [3] Boldyreva LB. Spin supercurrent in phenomena of quantum non-locality (quantum correlations, magnetic vector potential) and in near-field antenna effect. *Journal of Modern Physics*. 2019;**10**(2):128-144. DOI: 10.4236/jmp.2019.102010
- [4] Sphenkov G, Kreidik L, Krasnoholovets V, Christianto V, Smarandache F. *Old Problems and New Horizons in World Physics*. New York: Nova Science Publishers; 2020. BISAC: SCI055000
- [5] Christianto V. *Annales de la Fondation Louis de Broglie*. 2006;**31**(1)
- [6] Limar IV. Carl G. Jung's synchronicity and quantum entanglement: schrödinger's cat 'wanders' between chromosomes. *NeuroQuantology*. 2011;**9**(2):313-321. ffhprints-00637383v2f
- [7] Bunkov YE, Volovik GE. Spin Superfluidity and Magnon BEC. 2012. arXiv:1003.4889v3 [cond-mat.other]
- [8] Koizumi H, Ishikawa A. Berry connection from many-body wave functions and superconductivity: Calculations by the particle number conserving Bogoliubov-de Gennes equations. 2021. arXiv:2105.02364v1 [cond-mat.supr-con]
- [9] Nozieres P, Pines D. *Theory of Quantum Liquids: Superfluid Bose Liquids*. 1st ed. Boca Raton: CRC Press; 1994. p. 208. ISBN: 9780201408416
- [10] Christianto V. *Apeiron*. 2004;**11**(1):112-152
- [11] Christianto V, Rapoport DL, Smarandache F. *Progress in Physics*. 2007;**2**:9-11
- [12] Christianto V, Smarandache F. *Progress in Physics*. 2008;**1**
- [13] Christianto V, Smarandache F, Umniyati Y. *Prespacetime Journal*. 2020;**11**(3)
- [14] Smarandache F, Christianto V. *Progress in Physics*. 2006;**2**:5-12
- [15] Coles P. The wave mechanics of large-scale structure. In: *The Early Universe and the Cosmic Microwave Background: Theory and Observations*. Dordrecht: Springer; 2003. pp. 219-236. Arxiv: 0290576 (astro-ph)
- [16] Kreskens C, Perez DL. Evidence of Quantum Consciousness in Evoked Zero-spin Echoes. bioRxiv preprint. DOI: 10.1101/219931
- [17] Umniyati Y, Christianto V, Smarandache F. An explanation of Sedna orbit from condensed matter or superconductor model of the solar system: A new perspective of TNOs. *AIP Conference Proceedings*. 2021;**2331**(030014). DOI: 10.1063/5.0041656
- [18] Friedmann A. Can the cosmos test the quantum entanglement? In: *Astronomy*. 2014. Available from: www.astronomy.com
- [19] Genovese M. Cosmology and entanglement. *Journal of Computational*

and Theoretical Nanoscience. 2009;**2**(3):303-309. Available from: Researchgate.net

[20] Smarandache F. There is no speed barrier in the universe. *Bulletin of Pure & Applied Sciences*. 1998;**17D**(1):61 Available from: <http://fs.unm.edu/NoSpLim.htm>

[21] Weisstein EW. Smarandache hypothesis. *The Encyclopedia of Physics*. Available from: <http://scienceworld.wolfram.com/physics/SmarandacheHypothesis.html>

[22] Potel G, Barranco F, Vigezzi E, Broglia RA. Quantum entanglement in nuclear Cooper-pair tunneling with γ rays. *Physical Review C*. 2021;**103**:L021601

[23] Zhitnitsky A. Superfluid helium II as the QCD vacuum. *Nuclear Physics B*. 2017;**916**:510-549

[24] Zloshcastiev KG. Superfluid vacuum theory and deformed dispersion relations. *International Journal of Modern Physics A: Particles and Fields; Gravitation; Cosmology; Nuclear Physics*. 2020;**35**:2040032. DOI: 10.1142/S0217751X20400321

[25] Matsuzaki M. Dirac sea effects on superfluidity of nuclear matter. *Physical Review C*. 1998;**58**(6):3407. Available from: <https://inspirehep.net/literature/475070>

[26] Lombardo U et al. Superfluid states of nuclear matter beyond the BCS approximation. *International Journal of Modern Physics*. 2005;**14**(04):513-554. DOI: 10.1142/S0218301305003375

[27] Hankey A. Macroscopic quantum coherence in patient-practitioner-remedy entanglement: The quantized fluctuation field perspective. *Evidence-based*

Complementary and Alternative Medicine. 2009;**6**(4):449-451. DOI: 10.1093/ecam/nen032

[28] Likhtenshtein G. *Electron Spin Interactions in Chemistry and Biology*. Switzerland: Springer International Publishing Switzerland; 2016

[29] Kanno S, Soda J. Bell inequality and its application to cosmology. *Galaxies*. 2017;**5**:99. DOI: 10.3390/galaxies5040099

[30] Olsen C et al. Star Formation Histories from SEDs and CMDs Agree: Evidence for Synchronized Star Formation in Local Volume Dwarf Galaxies over the Past 3 Gyr. arXiv:2104.06514v1 [astro-ph.GA]. 2021

[31] Durston S, Baggerman T. *The Universe, Life and Everything*. Amsterdam: Amsterdam University Press B.V; 2017

[32] Tremblay N. Independent re-analysis of alleged mind-matter interaction in double-slit experimental data. *PLoS One*. 2019;**14**(2):e0211511. DOI: 10.1371/journal.pone.0211511

[33] Polkinghorne R et al. Geometric Phases of a Vortex in a Superfluid. 2021. arXiv: 2101.07348

[34] Suter A et al. Direct observation of nonlocal effects in a superconductor. *Physical Review Letters*. 2004;**92**(8):087001

[35] Koizumi H. Superconductivity by berry connection from many-body wave functions: Revisit to Andreev—Saint—James reflection and Josephson effect. *Journal of Superconductivity and Novel Magnetism*. 2021;**34**(8):2017-2029. DOI: 10.1007/s10948-021-05905-y

[36] Boldyreva L. *Alternative & Integrative Medicine*. 2013;**2**:3. DOI: 10.4172/2327-5162.100011

- [37] Chen H et al. Non-Local Transport Mediated by Spin-Supercurrents. 2014. arXiv: 1408.1100
- [38] Christianto V, Smarandache F. Continuum hypothesis revisited: From cantor, to Godel, then to discrete cellular space model. *Asia Matematika Journal*. 2022
- [39] Kamiya K et al. Discovery of superconductivity in quasicrystal. *Nature communications*. 2018;**9**:154, DOI: 10.1038/s41467-017-02667-x. Available from: www.nature.com/naturecommunications
- [40] Finkelstein DR et al. Hypercrystalline vacua. Available from: <https://arxiv.org/abs/quant-ph/9608024>
- [41] Fan T-Y et al. Review on Generalized Dynamics of Soft-Matter Quasicrystals and Its Applications. arXiv: 1909.10676
- [42] Steinhardt PJ, Bindi L. In search of natural quasicrystals. *Reports on Progress in Physics*. 2012;**75**(9):092601. DOI: 10.1088/0034-4885/75/9/092601
- [43] MacPherson GJ et al. Khatyrka, a new CV 3 find from the Koryak Mountains, Eastern Russia. *Meteoritics & Planetary Science*. 2013;**48**(8): 1499-1514
- [44] Bindi L et al. Icosahedrite, Al₆₃Cu₂₄Fe₁₃, the first natural quasicrystal. *American Mineralogist*. 2011;**96**(5-6):928-931
- [45] Matthias MMM et al. Cosmic History and a Candidate Parent Asteroid for the Quasicrystal-Bearing Meteorite Khatyrka. 2018. arXiv: 1803.03513
- [46] Bindi L. *Natural Quasicrystals: The Solar System's Hidden Secrets*. Springer Nature: Switzerland; 2020 ISSN 2524-8596
- [47] Sakai S. Superconductivity in quasicrystals. In: RIKEN Center for Emergent Matter Science. 2021
- [48] Pomorski K, Staszewski RB. Towards quantum internet and non-local communication in position-based qubit. *AIP Conference Proceedings*. 2020;**2241**:020030. DOI: 10.1063/5.0011369
- [49] Cramer JC, Herbert N. An Inquiry into the Possibility of Nonlocal Quantum Communication. 2014. arXiv: 1409.5098v2
- [50] Umniyati Y, Christianto V, Smarandache F. An explanation of Sedna orbit from condensed matter or superconductor model of the solar system: A new perspective of TNOs. In: Paper Accepted at SMIC 2020 Conference, Held at Aug. 2020, Indonesia. *AIP Conference Proceedings*. 2021;**2331**:030014. DOI: 10.1063/5.0041656. Available from: <https://aip.scitation.org/doi/abs/10.1063/5.0041656>

The electric Coulomb field travels with an infinite velocity: Remarks on Naudin's experiment, Montagnier-Gariaev's experiments, and Lienert-Wiechart potential

Robert N. Boyd, Florentin Smarandache

Robert N. Boyd, Florentin Smarandache (2022). The electric Coulomb field travels with an infinite velocity: Remarks on Naudin's experiment, Montagnier-Gariaev's experiments, and Lienert-Wiechart potential. *Journal of Cosmology, Filaments and Astrobiology* 1(2), 8-12; DOI: 10.54216/JCFA.010201

Abstract

The following is summary of discussions via email, concerning remark on infinite velocity of Coulomb Potential, Naudin's experiment, Proca equations and Lienert-Wiechart potential etc. Discussions were around October 2018. Hopefully readeres will find them interesting.

Keywords: Naudin's experiment; Proca equations; infinite velocity of Coulomb Potential.

1. Introduction

The Coulomb field also conveys information at an infinite velocity. This fact has been proved by several different experiments. The infinite velocity Coulomb field is completely overlooked by standard cosmology adherents, who base their cosmological fictions on fraudulent and completely non-physical relativity, a fantasy narrative originally composed by Einstein, *et al.* Due to Coulomb field infinite velocity activities, electric events and interactions can take place between myriads of galaxies inconceivable distances away from one another. The speed of light has nothing to do with any of these vastly distant interactions. The following is summary of discussions via email, concerning remark on infinite velocity of Coulomb Potential, Naudin's experiment, Proca equations and Lienert-Wiechart potential etc. Discussions were around October 2018.

. Remark on Naudin s experiments etc.

One of us (RNB) used to converse with Naudin several times a week. Naudin was doing experiments with lifters which were related to my work with Greenglow regarding the Beifield-Brown Effect. He also made several Rodin coils and photographed their influences on iron powder. I also used to know Marko Rodin when he was living in Hawaii in those days. Amazing stuff happened from my Greenglow connections.

But the experiments he is referring to happened in the 1930s, in France. The name Nipher comes to mind, for some reason. In the book *Lost Science* by Vassilatos, you will find the experiments he is referring to in there, along with many other interesting results. You have to read Vassilatos over and over, because some of the concepts he expresses are so far removed from the standard indoctrinations of the Hollywood sciences, that it takes several exposures for them to register properly, despite a life-time of science propaganda.

One of us (RNB) also knew Jeffimenko, who was a participant in Greenglow. He used to live in West Virginia. He was one of the keys to my making major breakthroughs which resulted in he eliminating E's version of relativity entirely from all consideration, in every regard.

RNB also knew Roshin and Goden, and he participated in designing experiments with Podkletnov, who was also with Greenglow. We had quite the group of bright minds working together, during the best years of Greenglow. At one point we had more than 200 participants, from all over the world. RNB ran across Tajmar's work on Research Gate, but he did not know at the time that Proca's version of gravitation preceded the model produced by Le Sage, if he is not mistaken. He'll have to go and read Tajmar's paper now. It looks like we have quite a talented group of researchers working together on getting these books out.

We think that combining our understandings, along with some modified results from Krasnoholovets, will result in some marvelous breakthroughs.

RNB designed an infinite range superluminal aether-gravity telescope about the year 2002 when he was with *Greenglow*. No one was interested, because the observations which such a system will produce will demolish, not only relativity theory, but every attempt at proving any sort of ecclesiastical beginning of the Infinite Volume Universe. It will also eradicate such Hollywood fantasies as black holes and neutron stars, as well. So it wasn't very popular among the Hollywood science crew. Needless to say, he couldn't get funding for it.

. Remarks on infinite velocity of the propagation of electric charge

Experimental results which are brought out in our previous book, regarding the infinite velocity of the propagation of electric charge, in terms of the Lienert-Weichert potential, allow for yet another approach to designing an infinite range superluminal telescope. There are two more ways to do this, but he won't talk about them right now.

Creation is a Continuous Process, in which everyone and everything, constantly participates. An infinite range telescope would go far towards supporting this thesis, based on observational evidence.

The research team at Greenglow dismissed gravitomagnetism early on. When one brought up the Proca equations, for some reason, he thought one were referring to Fatio, who preceded Le Sage in his version of shadow gravity.

The Proca equations have nothing to do with this.

Anything that links to the Higgs field or the Higgs boson has nothing to do with physical reality. This brings to mind a photograph which was taken of Prof. Higgs standing on one of the railings of the LHC facility, wearing a red rubber Bozo The Clown nose. That photograph coincides perfectly with my view of Higgs fantasies.

Photons are not the origination of gravitation. Here is my model of the photon, without the accompanying deBroglie wave. It is comprised of dual circulations of particles, which particles are made of particles, and so on, down to the infinitely small. The Primer Fields Part 3 - Duration: 56:14. by David LaPoint 69,062 views Add deBroglie waves to each photon, and you arrive at our model, which has been proved by experiments done at Rutgers University, and incidentally validates photon wave optics paradigms dating back to at least Fresnel.

As one of us (RNB) sees things, all the creatures that are smaller than the Kolmogorov Limit ($10e^{-58}$ m) are the cause of gravitation. This view agrees with Fatio, Le Sage, and La Place and has experimental evidence supporting it. The SubQuantum microscope he designed when he was with Greenglow, was constructed in Serbia and has imaged entities as small as $10e^{-95}$ cm. Relevant physical evidence and observations must be taken into consideration in our explorations.

We like the fluidic version of the Proca equations, but these concepts need to be applied to understanding detailed behaviors and properties of the SubQuantum aether.¹ Just as the Maxwell equations are based on the fact of the aether, so too is the fluidic version of the Proca equations. Unfortunately, neither of these sets of equations are describing gravitation, but are discussing E and B systems. Gravitation is what he was working on now. Again. RNB's previous efforts found strong

¹ This was referring to our joint paper with Victor Christianto *et al.* See : V. Christianto, F. Smarandache, Y. Ummiyati. A Derivation of Fluidic Maxwell-Proca Equations for Electrodynamics of Superconductors & Its Implication to Chiral Cosmology Model. *Prespacetime J.*, Vol. 9 No. 7, 2018. url: <https://prespacetime.com/index.php/pst/article/view/1471>

agreement with the LaPlacian version of gravitation. He wants to look very closely at everything Louis Rancourt has expressed, because he has arrived at conclusions similar to my previous studies. And he (LR) has made some marvelous experiments

. Problems with QED

QED has multitudes of problems. Some of the problems are solved when one brings the activities of the SubQuantum infinitesimals into the more difficult situations, such as virtual particles. There are no virtual particles. The events which are claimed to be due to imagined virtual particles are actually resulting from real actions of real SQ infinitesimals.

We will look at Lehnert's RQED theory and see if we have gotten rid of any of the flaws which presently exist in standard QED. If it has any infinitesimal basis, there is hope. QED resulted from the Solvay Conference, which was the origination of vast numbers of frauds in the sciences. He wonders if QED can be repaired at all, because of its origins made of lies and paradoxes. There must be a better way than QED. It's broken.

Please keep it in mind that the aether exhibits 5 different phase-states [cf. Mishin], just as our accustomed physical material experiences do. However, the experiential information which is carried by the SQ infinitesimals exists at all scales (and is additive and cumulative), is partly responsible for the creation of matter, due to the *neg-entropy* (ordering, organizing information) that the infinitesimals add to the constituent subatomic particles as they accrete to eventually form the completely materialized physical form, from out of the SQ aether. Negentropy is one of the factors that causes physical matter to form, *ab initio* (from out of nothing).

Many mythologies refer to the nothing, the pre-physical, no-matter condition of the unfettered SQ aether as the Creative Void. So it is said, Nothing is everything. And everything is [made of] nothing.

The second main factor in the Creation of matter is *Consciousness-Information*. We are immersed in a Consciousness Field. Everything is and has Consciousness. Myriads of different kinds of Consciousness Everything is created by Intelligent Design, and happens by Intelligent Design, not by accident. The individual soul (monad) participates in the manifestation of the physical body from the instant of conception, which body will fully occupy when its construction is complete, based on what the soul and the Divine have mutually decided will be the best manifestation for the individual, in terms of appearances and abilities.

. Remarks on Gariaev and Montagnier's experiments

I am still a member of Peter Gariaev's research staff. Gariaev's experiments have demonstrated that the DNA and the protein factories which construct the cell, can only make what they are told to make, not by the DNA, but by environmental factors to use Gariaev's terminology.

We have experimentally proved the existence of an Ambient Intelligence, by several different experimental approaches. So there is scientific evidence that God, or whatever you want to call Him, is REAL. The Ambient Intelligence is certainly directly involved in making life-forms which are suited to the environmental conditions of the given time and place.

By implications presented by the experimental results of Montagnier, DNA information is present everywhere in the Universe, and manifests physical life-forms suited to the given local time and place, through the auspices of the Ambient Intelligence. Indeed, astrophysics has discovered that much of the so-called interstellar dust is not dust at all, but vast clouds of bacteria and spores, which have appeared between the stars, *ab initio*. They don't want the general public to know about these facts, much to their discredit.

This creation process has been observed to happen literally overnight, according to observations made by Crick, *et al.*, regarding completely new kinds of bacteria which appeared in less than 24 hours in his labs, which were not due to any Darwinistic evolutionary survival of the fittest. The first of the new kinds of bacteria which were micro-graphed and catalogued, were the first bacteria in the history of the world that had constructed, internal to their little bodies, electric motors, complete with stator and rotor, bearings, and an internally contained power supply, all of which was connected to a rotating hair-like appendage. This new species did not gain any mobility advantage in its fluid-based environment, over other species of bacteria which use flagella to get around. So this

was not an adaptation, but an entirely new kind of life-form. *Because of these events, Crick attempted to return his Nobel Prize award to the Nobel Prize Committee, because he knew that what he had been given the award for, was wrong.* So in all good conscience, he tried to give it back, as he considered himself undeserving of it. But the Committee refused it.

New DNA starts self-constructing when there is DNA already existing in the vicinity, according to Montagnier's Nobel Prize winning results. He discovered that DNA had formed in test tubes, previously filled with nothing but pure water, in less than a day, especially when electromagnetic radiation was passing through an area which contained other test tubes which contained samples of DNA, suspended in pure water. The E/M conveyed the DNA information to the pure water in the nearby test tubes, whereupon DNA started forming, ab initio, in the previously empty test tubes, along with all the requisite atoms which are required to construct new DNA molecules, which are not found in pure water. And where does the forming DNA get its instructions on how to make itself out of nothing but water, as seen in the Montagnier experiments?

Summary

To the best of our knowledge, SubQuantum infinitesimals are the root of all of everything else, including Life, matter, all the forces, and Consciousness.

References:

- [1] Gerry Vassilatos. *Lost Science*. Published 1997 by Borderland Sciences Research (first published June 1st 1900). url: <https://www.goodreads.com/book/show/3150416-lost-science>
- [2] V. Christianto, F. Smarandache, & R.N. Boyd (eds.) *New Foundation in the Sciences*. Indonesia: Eunoia Media Publisher, 2020
- [3] V. Christianto, F. Smarandache, Y. Umniyati. A Derivation of Fluidic Maxwell-Proca Equations for Electrodynamics of Superconductors & Its Implication to Chiral Cosmology Model. *Prespacetime J.*, Vol. 9 No. 7, 2018. url: <https://prespacetime.com/index.php/pst/article/view/1471>

Appendix: Letter to Louis Rancourt

October 23, 2018

Dear Louis,

Regarding <http://www.gravityforces.com/?p=1482>

You have independently reached many of the same conclusions I reached during the early 2000s when I was with Project Greenglow, an independent research group, partially sponsored by BAE Aerospace. Here is a partial summation of some of my results during that era:

<http://noosphere.princeton.edu/papers/misc/Subquantum.Plenum.doc>

This version was altered by some person associated with Princeton, in that, an entire section was removed from the text. The section removed was a set of experiments performed in France in the 1930 using an electrified version of the original Cavendish experiment which was used to prove Newton's thesis of gravitation. The French team connected a very thick copper cable to the base of the fixed lead ball, and surrounded the fixed central mass with a grounded Faraday cage. Then they conducted the standard Cavendish experiment and got the expected results. After that they increased

the voltage applied to the fixed central mass in 1000 Volt DC increments, repeating the release of a free-swinging mass which was hung from the ceiling by a very thin thread, while they measured the degree to which the free mass was attracted by the fixed mass, at the given applied voltage on the fixed mass. Eventually, they were able to measure the fact that the free-swinging mass did not exhibit as large an attraction as the standard Cavendish expectation value. The attraction became less and less as they increased the voltage, until they arrived at a voltage where no attractive force could be measured between the free-swinging mass and the electrified central mass. They kept increasing the voltage and measured the fact that the free-swinging mass was being repelled by the fixed mass with the degree of repulsion increasing to the limits of their voltage supply. The paper that was written on these experiments concluded that the electric field and the gravitational field were related, but not directly related. The applied voltage modified the gravitational attraction.

From this, the electric field is a SubQuantum aether flux which is flowing outward from the electrified mass, and counter-acting the SubQuantum aether flux which causes gravitation, until repulsion is exhibited between the two masses. One thing I have not been able to figure out yet: When the experimenters removed the Faraday cage and electrified the fixed mass, no repulsion or alteration of gravitation force was exhibited. Why is that? If you have any ideas on this, I would appreciate it if you could tell me about them.

From reading the materials on your website, I am sure you will appreciate the book *Creation of Matter* by Gustave Le Bon of Belgium, first published in 1906. This book was translated into English during the late 1990s, and is available here in the English version. (If you look around for a few years you might be able to find an original copy written in French, which might be even more to your liking. But, searches for such rare and old books are usually expensive and sometimes fruitless.)

The best English version is here: <https://www.nuenergy.org/the-evolution-of-matter/>

I am working on a document which will be included in a book which will be published about February or March, next year, out of the UK. I am including your arguments as well as I can within the book, as related to my understandings. Or, some of your text could be included in this book. If so, the publisher will want to obtain your permission to publish your materials in book form. I may be sending you a copyright release form in the next week or so. I need to consult with Victor Cristiano on this, as he is the primary editor of this text.

Attached is a preliminary version of the manuscript, which does not include my and your contributions yet. I think you will like the title of the book though :)

https://www.researchgate.net/publication/327537679_Going_Beyond_Tesla_Recent_developments_of_LaPlace_Gravitation_SubQuantum_Plenum_and_Aetherdynamics?_sg=YI3QjzHjnzW41O4wmNLOS49mM7GhjVmR_AptTJEmiafLaJGrSrNhtwHp7v_kTZBLxhKCTSTiCSGVEeFHE5e0erUTjBDsEmkQ9XTI-Y.uozqtwNJ-1uGIH8yWUG9Bvqelef_ODKkO4QzrWqSksFUxC0tB1L3AIISXweBfU4JGXM_fqiX9Ammf7oZCR7jww

I hope to hear from you soon.

Best Wishes,

Neil

Remark on Project Greenglow and Rodin coil

Robert N. Boyd, Florentin Smarandache

Robert N. Boyd, Florentin Smarandache (2022). Remark on Project Greenglow and Rodin coil. *Journal of Cosmology, Filaments and Astrobiology* 1(2), 13-14; DOI: 10.54216/JCFA.010202

Abstract

I and Florentin communicated extensively for the last 4 years or so. And this is one of our email, on my experience with Project Greenglow and using Rodin coil for special stargate device. The following is excerpt of communication with me and Florentin.

Keywords: Project Greenglow; Rodin coil

1. Introduction

When one of us (RNB) was with Project Greenglow, a research team out of the UK, he designed a faster than light (FTL) drive based on arrays of arrays of Rodin coils. He knew Marko Rodin personally at the time, where he was living in Hawaii then.

In addition to making FTL travel possible¹, an array of arrays of Rodin coils produces vast amounts of excess energy. So much so that if not properly controlled, the power produced by such an array becomes a hazard to living beings.

Marko designed his coil to be the basis of a fusion reactor, but due to its mathematical properties and geometries, it can do much more than that. Tony Smith studied Rodin coils for a while. See:

<https://www.valdostamuseum.com/hamsmith/SegalConf2.html>

Anything to do with E's version of relativity is never going to work. That is because E's version of relativity is NOT PHYSICAL, in any way.

¹ RNB's result can be seen as real experimental vindication of Smarandache's hypothesis, even if such an experiment may be difficult to replicate.

Because of that, warp drives, folding space and etc., are never going to work either.

The proper way to go about this is to enter into higher densities, which the entire planet is in the process of doing at this time. We are entering 5th Density Reality. (I have known about the various densities ever since I (RNB) was a teenager.)

The Pleadians and many other ET races already have Higher Density technologies.

The New World has arrived and is unfolding now.

God is here, helping directly, and things are moving along very nicely.

References

[1] Abdul Hameed, Shruti Hire, Rekha Pawar. Designing a Motor using Rodin Coil. *IJESC* Vol. 7 No.

3, url:

https://ijesc.org/upload/0fcd04a87b9859eff16e4ee1c793c9f9.Designing_20a_20Motor_20using_20Rodin_20Coil.pdf

[2] Dirk Gillabel. *Healing With the Rodin Coil*. 2014. url:

<http://nebula.wsimg.com/1b0c203c145923a11af1b5beec2eb03a?AccessKeyId=DFD61B79C154E9D63473&disposition=0&alloworigin=1>

Remark on the Safire Project's findings and infinite velocity beyond speed of light

Robert N. Boyd, Florentin Smarandache

Robert N. Boyd, Florentin Smarandache (2022). Remark on the Safire Project's findings and infinite velocity beyond speed of light. *Journal of Cosmology, Filaments and Astrobiology* 1(2), 15-18; DOI: 10.54216/JCFA.010203

Abstract

I and Florentin communicated extensively for the last 4 years or so. And this is one of our email, on Project Greenglow and infinite velocity of Coulomb potential etc. This communication is excerpt of previous emails between us.

Keywords: Safire Project; infinite velocity; Coulomb potential

1. On Safire Project

The Safire Project, which duplicates the way the Sun work, in a lab, is producing physical evidence of the creation of new atoms in plasmas and in the anode and in Langmuir probes used to monitor the plasma.

We have contacted the Principles of Safire and they have allowed us to use some of their copyrighted materials for my Prague presentation on matter-creation/dis-creation in an infinite volume Intelligent Universe.

Look at Phase 3. <https://www.safireproject.com/science/phase-three.html>

<https://www.safireproject.com/science/ewExternalFiles/SAFIRE-Project-Report.pdf>

We've got slides showing the SEM (Scanning Electron Microscope) results with new atoms showing up clearly, because there are big clumps of them, not just one or two.

Best Wishes,

RNB & FS

2. Other email per 2019, on infinite velocity beyond speed of light

Time has nothing to do with the speed of light. Einstein's absurd blundering attempt to connect everything to the speed of light, including time, leads to countless irrationalities regarding the observable behaviors of the physical universe.

Using the pseudo-manifold (not a real manifold) concocted by Minkowski results in a mathematical construction which has nothing to do with Real Reality, tailor made for a Disney cartoon production such as Fantasia, complete with dancing hippopotami in pink tutus.

The term **ict**, called *imaginary time* was used by Minkowski to link time with the speed of light. This construction has nothing to do with anything physical. There have never been any experimental measurements which have demonstrated that time has anything to do with light or the speed of light.

There have also never been any experiments which demonstrate that the speed of light is always the same, everywhere in the infinite volume universe.

In fact, there have never been any two consecutive measurements of the speed of light which were in perfect agreement.

In dishonest attempts to support E's version of relativity, when speed of light measurements are performed under laboratory conditions, *all the measurements which do not agree with E's version of relativity, are thrown away and removed from the records*. Typically, some disagreeable measurements are left in the data base so as to make the erroneous measurements appear to be due to instrumentation errors. All the other disagreeable measurements are extracted from the data base.

The speed of light is not a constant. It changes according to the variations of the permittivity and permeability of the media (which is primarily the quiescent portion of the aether, with some aether density variations involved from the motional part of the aether).

The Michelson-Morely experiment measured the speed of light at every run of the experiment, to an accuracy of 0.03 meters per second. Personal and detailed studies of the original handwritten physical lab notes and log books from the M-M experiment show instrumentally measured variations in the speed of light were observed at every turn, some as large as plus and minus 3000 meters per second.

The fact that the speed of light is not a constant forces us to revise many of the previously unquestioned ideas about how the physics of our Universe actually operate.

The fact of the variable speed of light demolishes the Lorentz transformation (which was non-physical already), as the Lorentz construction requires an absolute unchanging single value for the propagation velocity of light equal to c and no other value. In turn, this means that all considerations of Lorentz invariance are perfectly wrong and must be removed from all considerations of the behaviors of the actual physical Universe.

Minkowski *spacetime* is fantasy. It is fictional. It is a mathematical abstraction which is removed from physicality. It is a mathematical Mother Goose story, just as is the rest of E's version of relativity.

Minkowski's imaginary *spacetime* removes from consideration the experimentally proven and easily observed facts propounded by Newton regarding time and Absolute Time. So fantasy and lies have been replacing reproducibly observable physical facts, for more than 100 years, leading to a very unreliable physics paradigm.

Absolute Time is non-local and infinite velocity. Einstein wanted to destroy anything that did not agree with making the speed of light the basis of existence, requiring the abolition of all faster than light or infinite velocity events. So the FACT of Absolute Time was replaced with imaginary time from Mother Goose land.

Physically performed instrumented Quantum experiments have proved non-locality is an irrefutable fact. Non-locality means faster than light speed, or infinite velocity.

Newton's "Absolute Time" is exactly correct. And as usual, Newton corrects and vastly surpasses all of Einstein's irrational non-physical absurdities. Some relativists like to say Einstein's results correct Newton. Not at all. *Newton's results correct Einstein.*

Physical experiments and astrophysical observations by N.A. Kozyrev proved that time is a substance which is inherent in the aether in-flow known as gravitation. The time substance is the origination of the helical component of gravitation, and behaves as an in-spiraling vortex of aether which enters into all ponderable matter, just as the gravitational aether flow does.

The local attributes of Kozyrev's time substance can be modified and modulated so that one can slow down, speed up, and even stop, time flows. But reversing the direction of the time flow does not result in time travel .

The non-local attributes of the time flow which are Newton's Absolute Time, cannot be modified, as they are Universal and infinite velocity.

Please to keep in mind, Einstein himself once stated, Relativity theory can never be proved by any manner of physical experiment. Why? Because it is not physical. It is a fabrication of the imagination which has no physical factual reality under any circumstances. It is easier to prove the reality of Mickey Mouse than it is to prove the reality of E's version of relativity.

We made a few abbreviated mentions of these items during one of us (RNB) presentation,² but our primary focus was proving that matter and energy are created and destroyed constantly by plasma processes in stars and interstellar plasmas, all over the infinite volume Universe, over an infinite span of time. There was never a big bang . *Creation/Dis-Creation* is a continuous process which directly involves all stars and galaxies, in the moment. The average life-span of a proton is less than the purported half-life of the radioactive isotopes as according to the standard model of radioactivity, which is wrong. [See: Le Bon]

We mentioned during our presentation that space-time has no physical units associated with it. That is because it cannot be measured. That is because it is imaginary.

. Other email per May 1 , magnetic fields also propagate on infinite velocity

When the electric field at a given point, is evaluated according to *Liénard–Wiechert potential*, the result is identical to the result which obtains when one hypothesizes that the Coulomb field propagates with an infinite velocity. Experiments performed during the past several years have confirmed this hypothesis to be valid: The Coulomb Field does propagate with an infinite velocity.

For example, see:

http://www.pandualism.com/c/coulomb_experiment.html;
http://gsjournal.net/Science-JournalsPapers/Author/1624/Allen_20Robnett;
<https://link.springer.com/article/10.1140/epjc/s10052-015-3355-3>;
http://prola.aps.org/abstract/PR/v39/i4/p616_1.

That magnetic fields may also propagate at an infinite velocity, is implied in some of the more recent results. It has already been expressed by many, such as Newton, LaPlace, Eddington, Mach, Jefimenko, Van Flandern, Podkletnov, and Boyd, that gravitation also propagates with an infinite velocity. We already know that quantum physics experiments have proven quantum “non-locality” (infinite velocity) as an irrefutable fact. A Subquantum infinitesimal particle, with an infinitely small mass, can easily propagate at an infinite velocity, as demonstrated by the several Mobius (bilinear)

² This is referring to Physics Beyond Relativity Conference, held in Prague, Oct. 2019.

transformation solutions to the Maxwell equations found by V. Fock, R.M. Kiehn, R.N. Boyd, and T. Smith.

So it appears that *infinite velocity is the most common velocity in the Universe*, with light speed being an exception to the otherwise consensus infinite velocity dynamics of the Universe, with less than light speed events being more common than light-speed events. Infinite velocity SQ dynamics is the basis which unifies all the sciences.

. **Superluminal Mobius (bilinear transformation solutions to the Maxwell equations**

During the last decade, Boyd and Smith discovered 14 non-linear projective Mobius transformation solutions to the Maxwell equations, in addition to the original Mobius (bi-linear) transformation discovered by *Vladimir Fock*, during 1948.

The Mobius transformation solutions to the Maxwell equations allow that entities of these classes can exhibit propagation velocities from zero, to an infinite velocity (and everything in between). The 15 classes of Mobius propagations are generators of the Conformal Group Spin (2, 4) SU (2, 2), consisting of: 6 rotations and boosts; 4 special conformal transformations; 4 translations; and 1 dilation. (See: <http://www.valdostamuseum.com/hamsmith/SegalConf.html> conformalEMG)

The above is from the chapter in the book *New Horizons*, titled The Inner Workings of Reality :

<https://novapublishers.com/shop/old-problems-and-new-horizons-in-world-physics/>

May be readers will read that chapter eventually, at some convenient time.

<https://www.zmescience.com/research/light-frequencies-travel-infinitely-fast-zero-refraction-index-041324/>

See page 7 of: faculty.philosophy.umd.edu/mfrisch/papers/non-locality_in_ced.pdf

<https://plato.stanford.edu/entries/qm-action-distance/>

Infinite velocity events are a fact, especially in the SubQuantum domains. Recall my expressions regarding the infinite velocity of vortex lines in the paper regarding one of the 5 creation processes of matter, available at <http://vixra.org/pdf/1811.0404v2.pdf>.

We hope that people get over E's version of relativity, erase the non-physical Lorentz transformation, and restore the Aether to its rightful place, before the next century arrives.

References

- [1] J. Hakkila & R. Nemiroff. Time-reversed Gamma-Ray Burst Light-curve Characteristics as Transitions between Subluminal and Superluminal Motion. 2019 *ApJ* 883 70. url: <https://iopscience.iop.org/article/10.3847/1538-4357/ab3bdf>

PARADOXISM

The Paradoxism in Mathematics, Philosophy, and Poetry

Florentin Smarandache

Florentin Smarandache (2022). The Paradoxism in Mathematics, Philosophy, and Poetry. *Bulletin of Pure and Applied Sciences - Section - E - Mathematics & Statistics* 41E(1), 46-48; DOI: 10.5958/2320-3226.2022.00006.6

ABSTRACT

This short article pairs the realms of “Mathematics”, “Philosophy”, and “Poetry”, presenting some corners of intersection of this type of scientocreativity. Poetry have long been following mathematical patterns expressed by stern formal restrictions, as the strong metrical structure of ancient Greekheroic epic, or the consistent meter with standardized rhyme scheme and a “volta” of Italian sonnets. Poetry was always connected to Philosophy, and further on, notable mathematicians, like the inventor of quaternions, William Rowan Hamilton, or Ion Barbu, the creator of the Barbilian spaces, have written appreciated poems. We will focus here on an avant-garde movement in literature, art, philosophy, and science, called Paradoxism, founded in Romania in 1980 by a mathematician, philosopher and poet, and on the laboured writing exercises of the Oulipo group, founded in Paris in 1960 by mathematicians and poets, both of them still in act.

KEYWORDS: Paradoxism, Mathematics, Philosophy, and Poetry

1. PARADOXISM: AVANT-GARDE MOVEMENT IN LITERATURE, ART, PHILOSOPHY, AND SCIENCE

Paradoxism is a neo-avant-garde movement in literature, art, philosophy, science, based on excessive use of antitheses, parables, odds, paradoxes in creations, set up and led by the mathematician Florentin Smarandache, started as an anti-totalitarian protest in 1980s against the closed society of communist Romania.

Paradoxism seeks to explore new possibilities in literature, art, philosophy, and even science through a paradoxist thinking algorithm. Meta fictional leads, playful expressions, or combinatorial processes of composition are employed for the conveyance of the paradoxes. Structural constraints are important, but without losing the interest in the meaning of the message.

.NEUTROSOPHY, AS EXTENSION OF THE PARADOXISM

Later on, the paradoxism as well as the dialectics and the Ancient Chinese philosophy Yin-Yan, consisting of the dynamics of the opposites A and $\text{anti}A$, where A is an item (concept, idea, theorem, theory etc.) and $\text{anti}A$ is its opposite, were extended to Neutrosophy (as a dynamic between the opposites A , $\text{anti}A$, together with the neutralities between them $\text{neut}A$) generated the development in science of Neutrosophic Logic, Neutrosophic Set, Neutrosophic Probability, Neutrosophic Statistics and so on [1]. Neutrosophy is a new branch of philosophy and started in 1998 [2].

. OULIPO LITERARY MOVEMENT

In 1960, Raymond Queneau – a member of *Société Mathématique de France*, most known for the screened novel *Zazie dans le Métro* [3], who had joined the Surrealists but then departed he movement after its support of the USSR – met the chemical engineer and absurdist writer François Le Lionnais, head of the Division of Science Education at UNESCO, and founded in Paris, together with a motley crew of writers, mathematicians, professors, and pataphysicians, a literary movement of rigorous formalism based on Mathematics, called *Ouvroir de littérature potentielle* (Workshop for potential literature), in short *Oulipo* – later enlarged with a series of analogous workshops, including *Oumupo* (for potential music), *Oupeinpo* (for potential painting), or *Oucinépo* (for potential film).

Many inventive scientocreative works had emerged from here, such as the Boolean, Fibonacci, and exponential Queneau’s book *Cent Mille Millions de Poèmes* (One Hundred Thousand Billion Poems), formed by ten sonnets with the same rhyme scheme, each line of poetry being printed on a separate strip of card, as it could be combined with any other lines, generating 10^{14} different poems [4].

The Oulipo group were in a quest for new forms of writing developed from new methods of invention, but considered themselves merely a working group than a creative one, set up to offer practical solutions for writers by inductive research, seeking to formulate problems and eventually to offer solutions that allow any and everybody to construct, letter by letter, word by word, a text [5]

Their creed of literary freedom by automatic writing, originating in Surrealism, was paradoxically grilled by rule-bound formulas of mathematical constraints, as they were convinced that it is not only the virtualities of language that are revealed by constraint but also the virtualities of him who accepts to submit himself to constraint. [6].

For instance, they invented the procedure *N+7*, meaning to choose a classic poem and substitute each noun with the noun found seven nouns away in a specific dictionary. Take for example the first stanza of *The Snow Man*, by Wallace Stevens:

<i>The Snow Man</i>	<i>The Soap Mandible</i>
One must have a mind of winter To regard the frost and the boughs Of the pine-trees crusted with snow.	One must have a miniature of wisdom To regard the fruit and the boulders Of the pinions crusted with soap.

Another math-based structural constraint employed by *Oulipo* is the *snowball* poetry, with successive lines/sections progressively longer, e.g. starting with a line/section of one word long, going further with a second line/section of two words, a third line/section of three words, and so on; or starting with a line/section of one letter, going further with a second line/section of two letter, and so on with the following line/section longer than the preceding one. The interested reader can find a work that compiles Oulipean techniques, processes, procedures, rules, definitions, and personalities [7].

. PARADOXISM AND OULIPO: CONNECTIONS

The main difference between Paradoxism and most neo-avant-gardism movements is its option for significance, while the others tend to instrument form to the detriment of meaning. As expounded above, the Paradoxism started not as a game of mind, but as an outcry over the power of any kind, especially deploying contra-dictions, anti-nomies, anti-thesis, anti-phrases, and in particular paradoxes, through any possible literary, art and even scientific vehicle. There are indeed similarities, intersections and connections though between Paradoxism and neo-avant-gardism movements, out of which we briefly discuss two common features between Paradoxism and Oulipo.

The first one refers to a kindred view on intertextuality as a potentiality for re-elaboration. A contemporary American writer, Harry Mathews (with many of his works employing the Oulipean style), suggested the Mathews’ Algorithm for producing literature by permuting equivalent members in accordance to predetermined rules, in order to reveal the otherness in language [8], based on which Mark Wolff created a web application offering the reader an opportunity to discover duplicities in texts [9]. Even if the approach is different, the goal is the same: opening texts to exploratory quests towards the collective talent, exploring otherness and duplicities in texts. But really close to Paradoxism’s view on intertextuality are Mathews’ 35

Variations on a Theme from Shakespeare , where one can read: To be or not to be: that's the problem , Nothing and something: this was an answer , Choosing between life and death confuses me [10]. Many similar intertextual games are to be found in Paradoxist anthologies [11].

The second one regards practice, as there is an Oulipian method closely related to Paradoxism. It is called *antonymy*, and the experiment consists in replacing every significant word in each text with its antonym or opposite, based on a given thesaurus. Moreover, definite articles can be replaced by indefinite ones, or singular by plural, and vice versa. Proper nouns or words that have no direct antonyms are usually treated as symbols or generic objects. The results might differentiate the two movements, as Paradoxism tends not to accept random meanings or non-meanings, but rather alternative meanings.

. CONCLUSION

To many, literary movements such as the Paradoxism or the Oulipo represent a washed moment in time, outdated experimentalism, a chink of postwar neo-avant-gardism. Still, these type of mixed sciento-creative manifestations do not show signs of lassitude. For its 50th celebration, Oulipo published an anthology of almost 1000 pages [12], while the Paradoxist movement has reached its fifteenth anthology in 2020 [13].

REFERENCES

1. Smarandache F. (2002). A Unifying Field in Logics: Neutrosophic Logic, Multiple Valued Logic / An International Journal, UK &USA, ISSN 1023-6627, 8(3), 385-438. The whole issue of this journal is dedicated to Neutrosophy and Neutrosophic Logic.
- . Smarandache F. (2002). Neutrosophy: A New Branch of Philosophy, Multiple Valued Logic / An International Journal, USA, ISSN 1023-6627, 8(3), 297-384.
- . Queneau, R. (1959). *Zazie dans le Métro*. Paris: Gallimard.
- . Queneau, R. (1961). *Cent mille milliards de poèmes*. Paris: Gallimard.
- . Motte, Warren F. Jr. (1998). *Oulipo: A Primer of Potential Literature*; Normal, IL: Dalkey Archive Press. p. 46.
- . Motte, Warren F. Jr. (1998). *Oulipo: A Primer of Potential Literature*; Normal, IL: Dalkey Archive Press. p. 43.
- . Mathews, Harry; Brothie, Alastair. (1998). *Oulipo Compendium*. London: Atlas Press.
- . Warren F. Jr. (1998). *Oulipo: A Primer of Potential Literature*; Normal, IL: Dalkey Archive Press, pp. 126-139.
- . Mark Wolff is a French and Digital Humanities professor at Hartwick College. About the web applications he created based on Mathew's Algorithm, here: <https://markwolff.name/wp/research/mathewss-algorithm>.
- 1 . Mathews, H. (1999). *Thirty-five variations on a theme from Shakespeare*, Denver, CO: Shiny International Publications..
11. Take for example, *Paradoxisme* by Elena Agiu-Neacșu, in Smarandache, Florentin, ed.: *Fourteenth International Anthology on Paradoxism*, Columbus: Educational Publisher, United States, 2018, pp.71-73.
- 1 . B nabou, M; Fournel, P. (2009). *Anthologie de l'OuLiPo*. Paris: Gallimard.
- 1 . Smarandache F. (2020). *Fifteenth International PhotoVideoAnthology on Paradoxism*. Texts, photos, video. Columbus: Educational Publisher.
- 1 . Akram, M.; Gulzar, H.; Smarandache, F.; Broumi, S. (2018). Application of Neutrosophic Soft Sets to K-Algebras. *Axioms*, 7, 83.
- 1 . Naz, S.; Akram, M.; Smarandache, F. (2018). Certain Notions of Energy in Single-Valued Neutrosophic Graphs. *Axioms*, 7, 50.
- 1 . Ion Barbu, D. (1979). (After Snails), <https://versuri.third.com/ion-barbu/dupa-melci/> (musical album by NicuAlifantis, Dupămelci ,https://www.discogs.com/master/414033-Nicu-Alifantis-Dup_C4_83-Melcihttp://www.progarchives.com/album.asp?id_30124
- 1 . Smarandache F. (2021). *Convorbiri Literare*, 310, page 79.
- 1 . Traian L. (1999). (two poems): "*Multiplication Table*" and "*The first poetry of Smaranda*", from the book Traian Lalescu (Jr.) "*Poezii*" ("Poetries"), Corint Publishing House, Bucharest.
- 1 . Loveday K. and Peter D. (2016). *Barbilian-Barbu A Case Study in Mathematico-poetic Translation*, *Signata*, 7, 337-360.
- . Smarandache F. (2016). *Cititorind. Publicații românești dinainte de Revoluție. Însemnări într-un caiet literar. α-Lecturi instante*, Suceava. <http://fs.unm.edu/CititorindPublicatiiRomanesti.pdf>

Paradoxismul în matematică, filosofie și poezie

Florentin Smarandache

Florentin Smarandache (2022). Paradoxismul în matematică, filosofie și poezie. *Sæculum* 7, 131-135

Abstract: This short article pairs the realms of „Mathematics”, „Philosophy” and „Poetry”, presenting some corners of the intersection of this type of science-creativity. Poetry has always been linked to philosophy, and further notable mathematicians, such as the inventor of the Quaternaries, William Rowan Hamilton, or Ion Barbu, the creator of the Barbilian spaces, wrote acclaimed poems. We will focus here on a cutting-edge movement in literature, art, philosophy, and science called Paradoxism, founded in Romania in the 1980s by a mathematician, philosopher, and poet, and on the laborious writing exercises of the Oulipo group, founded in Paris in 1960, by mathematicians and poets, both still in action.

Keywords: *Paradoxism, Oulipo, Neutrosophy, Neutrosophic Logic.*

Paradoxismul, mișcare de avangardă n literatură, artă, filosofie și știință

Paradoxismul este o mișcare neo-avangardistă în literatură, artă, filosofie, știință, bazată pe utilizarea excesivă de antiteze, parabole, oximoroni, paradoxuri în creații, înființată și condusă de matematicianul Florentin Smarandache, începută ca un protest antitotalitar în anii 1980 împotriva societății închise a României comuniste.

Paradoxismul caută să exploreze noi posibilități în literatură, artă, filosofie și chiar știință printr-un algoritm de gândire paradoxistă. Conducele metafictionale, expresiile jucăușe sau procesele combinatorii de compoziție sunt folosite pentru transmiterea paradoxurilor. Constrângerile structurale sunt importante, dar fără a pierde interesul pentru semnificația mesajului.

Neutrosafia, ca extensie a paradoxismului

Mai târziu, paradoxismul, precum și dialectica dar și filozofia chineza antică Yin-Yan, constând din dinamica opuselor A și $\text{anti}A$, unde

A este un element (concept, idee, teoremă, teorie etc.) și $\text{anti}A$ este opusul

său, au fost extinse la Neutrosofie (ca o dinamică între opuse A , $\text{anti}A$, împreună cu neutralitățile dintre ele $\text{neut}A$) a generat dezvoltarea în știință a Logicii Neutrosofice, Mulțimii Neutrosofice, Probabilității Neutrosofice, Statisticii Neutrosofice etc. [1]. Neutrosofia este o nouă ramură a filosofiei și a început în anul 1998 [2].

Mișcarea literară Oulipo

În 1960, Raymond Queneau – membru al Societății Mathématique de France, cunoscut pentru romanul ecranizat *Zazie dans le Métro* [3], care s-a alăturat suprarealiștilor, dar apoi a părăsit mișcarea după sprijinul său pentru URSS – a întâlnit pe inginerul chimist și scriitorul de literatură absurdă François Le Lionnais, șeful Diviziei de Educație Științifică de la UNESCO, și au fondat la Paris, împreună cu un echipaj pestriț de scriitori, matematicieni, profesori și „patafizicieni”, o mișcare literară de formalism riguros bazată pe matematică, numit „Ouvroir de littérature potentielle” (Atelier pentru literatură potențială), pe scurt: *Oulipo* – extins ulterior cu o serie de ateliere analoage, inclusiv *Oumupo* (pentru muzică potențială), *Oupeinpo* (pentru pictura potențială), sau *Oucinépo* (pentru filmul potențial).

De aici au apărut multe lucrări științo-creative inventive, cum ar fi cartea booleană, fibonacciană și exponențială a lui Queneau *Cent Mille Milliards de Poèmes*, formată din zece sonete cu aceeași schemă de rimă, fiecare linie de poezie fiind tipărită pe o bandă separată de card, care poate fi combinată cu orice alte rânduri, generând 1014 poezii diferite [4].

Grupul *Oulipo* se afla într-o căutare de noi forme de scriere dezvoltate din noi metode de invenție, dar se considerau mai mult un grup de lucru decât unul creativ, creat pentru a oferi soluții practice scriitorilor prin cercetări inductive, căutând „să formuleze probleme și în cele din urmă să ofere soluții care să permită oricui și tuturor să construiască, literă cu literă, cuvânt cu cuvânt, un text” [5].

Crezul lor de libertate literară prin scriere automată, originar din suprarealism, a fost paradoxal preparat de formule de constrângeri matematice legate prin reguli, întrucât erau convingeți că „nu doar virtualitățile limbajului sunt dezvoltate prin constrângere, ci și virtualitățile lui care acceptă să se supună constrângerii” [6].

De exemplu, au inventat procedura $N + 7$, adică să aleagă un poem clasic și să înlocuiască fiecare substantiv cu substantivul aflat la șapte substantive distanță într-un dicționar specific. Luați, de exemplu, prima strofă din *Omul de zăpadă* de Wallace Stevens:

Omul de zăpadă	Mandibula săpunului
Trebuie să ai o minte de iarnă Pentru a privi înghețul și ramurile Dintre pinii crustați de zăpadă.	Trebuie să ai o minimă înțelepciune Să privești fructele și bolovanii Dintre pinioanele crustate cu săpun.

O altă constrângere structurală bazată pe matematică, utilizată de *Oulipo*, este poezia cu bulgări de zăpadă, cu linii / secțiuni succesive progresiv mai lungi, de ex. începând cu o linie / secțiune de un cuvânt lung, mergând mai departe cu o a doua linie / secțiune de două cuvinte, o a treia linie / secțiune de trei cuvinte și așa mai departe; sau începând cu o linie / secțiune dintr-o literă, mergând mai departe cu o a doua linie / secțiune din două litere și așa mai departe cu următoarea linie / secțiune mai lungă decât cea precedentă.

Cititorul interesat poate găsi o lucrare care compilează tehnici, procese, proceduri, reguli, definiții și personalități oulipene [7].

Paradoxism și Oulipo: conexiuni

Principala diferență dintre paradoxism și majoritatea mișcărilor neo-avangardiste este opțiunea sa pentru semnificație, în timp ce celelalte tind să instrumenteze forma în detrimentul sensului. După cum s-a expus mai sus, paradoxismul nu a început ca un joc al minții, ci ca un strigăt asupra puterii de orice fel, în special desfășurând contra-dicțiuni, anti-nomii, anti-teze, anti-fraze și, în special, paradoxuri, prin orice posibil vehicul literar, de artă și chiar științific.

Există într-adevăr similitudini, intersecții și conexiuni totuși între paradoxism și mișcările neo-avangardiste, dintre care discutăm pe scurt două trăsături comune între Paradoxism și Oulipo.

Prima se referă la o viziune înrudită asupra intertextualității ca potențialitate pentru reelaborare. Un scriitor american contemporan, Harry Mathews (în multe dintre lucrările sale folosind stilul Oulipo-ean), a sugerat „Mathews’ Algorithm” pentru producerea literaturii permutând membri echivalenți în conformitate cu reguli prestabilite, pentru a dezvălui „alteritatea în limbă” [8], pe baza căreia Mark Wolff a creat o aplicație web oferind cititorului o oportunitate „de a descoperi duplicități în texte” [9]. Chiar dacă abordarea este diferită, scopul este același: deschiderea textelor către căutări exploratorii, către talentul colectiv, și explorarea alterității și a duplicităților în texte.

Dar foarte aproape de viziunea paradoxismului asupra intertextualității sunt *35 de variații pe o temă de la Shakespeare* ale lui Mathews, unde se poate citi: „A fi sau a nu fi: asta este problema”, „Nimic și ceva: acesta

a fost un răspuns”, „Alegerea între viață și moarte mă încurcă” [10]. Multe jocuri intertextuale similare se găsesc în antologiile paradoxiste [11].

Al doilea privește practica, deoarece există o metodă Oulipo-eană strâns legată de paradoxism. Se numește antonimie, iar experimentul constă în înlocuirea fiecărui cuvânt semnificativ dintr-un anumit text cu antonimul său, pe baza unui tezaur dat. Mai mult, articolele definite pot fi înlocuite cu articole nedeterminate, sau singular cu plural, și invers. Substantivele proprii sau cuvintele care nu au antonime directe sunt de obicei tratate ca simboluri sau obiecte generice. Rezultatele ar putea diferenția cele două mișcări, deoarece Paradoxismul tinde să nu accepte semnificații aleatorii sau ne semnificații, ci mai degrabă semnificații alternative.

Concluzie

Pentru mulți, mișcările literare precum Paradoxismul sau Oulipo reprezintă un moment spălat în timp, experimentalism învechit, o ciudățenie a neo-avangardismului postbelic. Totuși, acest tip de manifestări mixte sciento-creative nu prezintă semne de lăncezeală. Pentru a 50-a sărbătoare, Oulipo a publicat o antologie de aproape 1000 de pagini [12], în timp ce mișcarea paradoxistă a ajuns la a cincisprezecea antologie în 2020 [13].

Referințe

[1] F. Smarandache, „A Unifying Field in Logics: Neutrosophic Logic”, în *Multiple Valued Logic / An International Journal*, Anglia - SUA, ISSN 1023-6627, Vol. 8, No. 3, pp. 385-438, 2002. Întregul număr al acestei reviste este dedicat Neutrosophy și Neutrosophic Logic.

[2] F. Smarandache, „Neutrosophy, A New Branch of Philosophy”, în *Multiple Valued Logic / An International Journal*, Anglia – SUA, ISSN 1023-6627, Vol. 8, nr. 3, pp. 297-384, 2002.

[3] Queneau, Raymond: *Zazie dans le Métro*. Paris: Gallimard, 1959.

[4] Queneau, Raymond: *Cent mille milliards de poèmes*. Paris: Gallimard, 1961.

[5] Motte, Warren F. Jr, ed.: *Oulipo: A Primer of Potential Literature*; Normal, IL: Dalkey Archive Press, 1998, p. 46.

[6] Motte, Warren F. Jr, ed.: *Oulipo: A Primer of Potential Literature*; Normal, IL: Dalkey Archive Press, 1998, p. 43.

[7] Mathews, Harry; Brotchie, Alastair, ed.: *Oulipo Compendium*. Londra: Atlas Press, 1998.

[8] „Mathew’s Algorithm”, în Motte, Warren F. Jr, ed.: *Oulipo: A Primer of Potential Literature*; Normal, IL: Dalkey Archive Press, 1998, pp. 126-139.

[9] Mark Wolff este profesor francez și umanist digital la Colegiul Hartwick. Despre aplicațiile web pe care le-a creat pe baza algoritmului Mathew, aici: <https://markwolff.name/wp/research/mathewss-algorithm>.

[10] Mathews, Harry: *Treizeci și cinci de variante pe o temă din Shakespeare*, Denver, CO: Shiny International Publications, 1999.

[11] Luați, de exemplu, „Paradoxisme” de Elena Agiu-Neacșu, în Smarandache, Florentin, ed.: *A paisprezecea Antologie internațională despre paradoxism*. Columb: Educational Publisher, 2018, pp. 71-73.

[12] B nabou, Marcel; Fournel, Paul, ed. : *Anthologie de l’OuLiPo*. Paris: Gallimard, 2009.

[13] Smarandache, Florentin, ed.: *Fifteen International Photo Video Anthology on Paradoxism*. Texte, fotografii, video. Columbus: Editor educațional, 2020.

VARIA MATHEMATICA

Mathematics for Everything with Combinatorics on Nature - A Report on the Promoter Dr. Linfan Mao of *Mathematical Combinatorics*

Florentin Smarandache

Florentin Smarandache (2016). Mathematics for Everything with Combinatorics on Nature - A Report on the Promoter Dr. Linfan Mao of Mathematical Combinatorics. *International Journal of Mathematical Combinatorics* 1, 130-133

The science's function is realizing the natural world, developing our society in coordination with natural laws and the mathematics provides the quantitative tool and method for solving problems helping with that understanding. Generally, understanding a natural thing by mathematical ways or means to other sciences are respectively establishing mathematical model on typical characters of it with analysis first, and then forecasting its behaviors, and finally, directing human beings for hold on its essence by that model.

As we known, the contradiction between things is generally kept but a mathematical system must be homogenous without contradictions in logic. The great scientist Albert Einstein complained classical mathematics once that "As far as the laws of mathematics refer to reality, they are not certain; and as far as they are certain, they do not refer to reality." Why did it happens? It is in fact result in the consistency on mathematical systems because things are full of contradictions in nature in the eyes of human beings, which implies also that the classical mathematics for things in the nature is local, can not apply for hold on the behavior of things in the world completely. Thus, turning a mathematical system with contradictions to a compatible one and then establish an envelope mathematics matching with the nature is a proper way for understanding the natural reality of human beings. The *mathematical combinatorics* on Smarandache multispaces, proposed by Dr.Linfan Mao in mathematical circles nearly 10 years is just around this notion for establishing such an envelope theory. As a matter of fact, such a notion is praised highly by the Eastern culture, i.e., to hold on the global behavior of natural things on the understanding of individuals, which is nothing else but the essence of combinatorics.

Linfan Mao was born in December 31, 1962, a worker's family of China. After graduated from Wanyuan school, he was beginning to work in the first company of —it China Construction Second Engineering Bureau at the end of December 1981 as a scaffold erector first, then appointed to be technician, technical adviser, director of construction management department, and then finally, the general engineer in construction project, respectively. But he was special preference for mathematics. He obtained an undergraduate diploma in applied mathematics and Bachelor of Science of *Peking University* in 1995, also postgraduate courses, such as those of graph theory, combinatorial mathematics, \dots , etc. through self-study, and then began his career of doctoral study under the supervisor of Prof. Yanpei Liu of *Northern Jiaotong University* in 1999, finished his doctoral dissertation “A census of maps on surface with given underlying graph” and got his doctor's degree in 2002. He began his postdoctoral research on automorphism groups of surfaces with co-advisor Prof. Feng Tian in *Chinese Academy of Mathematics and System Science* from 2003 to 2005. After then, he began to apply combinatorial notion to mathematics and other sciences cooperating with some professors in USA. Now he has formed his own unique notion and method on scientific research. For explaining his combinatorial notion, i.e., *any mathematical science can be reconstructed from or made by combinatorization, and then extension mathematical fields for developing mathematics*, he addressed a report “Combinatorial speculations and the combinatorial conjecture for mathematics” in *The 2nd Conference on Combinatorics and Graph Theory of China* on his postdoctoral report “On automorphism groups of maps, surfaces and Smarandache geometries” in 2006. It is in this report he pointed out that the motivation for developing mathematics in 21th century is combinatorics, i.e., establishing an envelope mathematical theory by combining different branches of classical mathematics into a union one such that the classical branch is its special or local case, or determining the combinatorial structure of classical mathematics and then extending classical mathematics under a given combinatorial structure, characterizing and finding its invariants, which is called the *CC conjecture* today. Although he only reported with 15 minutes limitation in this conference but his report deeply attracted audiences in combinatorics or graph theory because most of them only research on a question or a problem in combinatorics or graph theory, never thought the contribution of combinatorial notion to mathematics and the whole science. After the full text of his report published in journal, Prof. L. Lovasz, the chairman of *International Mathematical Union* (IMU) appraise it “an interesting paper”, and said “I agree that combinatorics, or rather the interface of combinatorics with classical mathematics, is a major theme today and in the near future” in one of his letter to Dr. Linfan Mao. This paper was listed also as a reference for the terminology *combinatorics* in Hungarian on Wikipedia, a free encyclopedia on the internet. After CC conjecture appeared 10 years, Dr. Linfan Mao was invited to make a plenary report “Mathematics after CC conjecture – combinatorial notions and achievements” in the *International Conference on Combinatorics, Graph Theory, Topology and Geometry* in January, 2015, surveying its roles in developing mathematics and mathematical sciences, such as those of its contribution to algebra, topology, Euclidean geometry or differential geometry, non-solvable differential equations or classical mathematical systems with contradictions to mathematics, quantum fields and gravitational field. His report was highly valued by mathematicians coming from USA, France, Germany and China. They surprisingly

found that most results in his report are finished by himself in the past 10 years.

Generally, the understanding on nature by human beings is originated from observation, particularly, characterizing behaviors of natural things by solution of differential equation established on those of observed data. However, the uncertainty of microscopic particles, or different positions of the observer standing on is resulted in different equations. For example, if the observer is in the interior of a natural thing, we usually obtain non-solvable differential equations but each of them is solvable. How can we understand this strange phenomenon? There is an ancient poetry which answer this thing in China, i.e., “Know not the real face of Lushan mountain, Just because you are inside the mountain”. Hence, all contradictions are artificial, not the nature of things, which only come from the boundedness or unilateral knowing on natural things of human beings. Any thing inherits a combinatorial structure in the nature. They are coherence work and development. In fact, there are no contradictions between them in the nature. Thus, extending a contradictory system in classical mathematics to a compatible one and establishing an envelope theory for understanding natural things motivate Dr.Linfan Mao to extend classical mathematical systems such as those of Banach space and Hilbert space on oriented graphs with operators, i.e., action flows with conservation on each vertex, apply them to get solutions of action flows with geometry on systems of algebraic equations, ordinary differential equations or partial differential equations, and construct combinatorial model for microscopic particles with a mathematical interpretation on the uncertainty of things. For letting more peoples know his combinatorial notion on contradictory mathematical systems, he addressed a report “Mathematics with natural reality – action flows” with philosophy on the *National Conference on Emerging Trends in Mathematics and Mathematical Sciences of India* as the chief guest and got highly praised by attendee in December of last year.

After finished his postdoctoral research in 2005, Dr.Linfan Mao always used combinatorial notion to the nature and completed a number of research works. He has found a natural road from combinatorics to topology, topology to geometry, and then from geometry to theoretical physics and other sciences by combinatorics and published 3 graduate textbooks in mathematics and a number of collection of research papers on mathematical combinatorics for the guidance of young teachers and post-graduated students understanding the nature. He is now the president of the *Academy of Mathematical Combinatorics & Applications* (USA), also the editor-in-chief of *International Journal of Mathematical Combinatorics* (ISSN 1937-1055, founded in 2007).

Go your own way. “Now the goal is that the horizon, Leaving the world can be only your back”. Dr.Linfan Mao is also the vice secretary-general of *China Tendering & Bidding Association* at the same time. He is also busy at the research on bidding purchasing policy and economic optimization everyday, but obtains his benefits from the research on mathematics and purchase both. As he wrote in the postscript “My story with multispaces” for the *Proceedings of the First International Conference on Smarandache Multispace & Multistructure* (USA) in 2013, he said: “For multispaces, a typical example is myself. My first profession is the industrial and civil buildings, which enables me worked on architecture technology more than 10 years in a large construction enterprise of China. But my ambition is mathematical research, which impelled me learn mathematics as a doctoral candidate in the *Northern Jiaotong University* and then, a postdoctoral research fellow in the *Chinese Academy of Sciences*. It was a very strange

for search my name on the internet. If you search my name *Linfan Mao* in Google, all items are related with my works on mathematics, including my monographs and papers published in English journals. But if you search my name *Linfan Mao in Chinese* on Baidu, a Chinese search engine in China, items are nearly all of my works on bids because I am simultaneously the vice secretary-general of China Tendering & Bidding Association. Thus, I appear 2 faces in front of the public: In the eyes of foreign peoples I am a mathematician, but in the eyes of Chinese, I am a scholar on theory of bidding and purchasing. So I am a multispace myself.” He also mentioned in this postscript: “There is a section in my monograph *Combinatorial Geometry with Applications to Fields* published in USA with a special discussion on scientific notions appeared in *TAO TEH KING*, a well-known Chinese book, applying topological graphs as the inherited structure of things in the nature, and then hold on behavior of things by combinatorics on space model and gravitational field, gauge field appeared in differential geometry and theoretical physics. This is nothing else but examples of applications of mathematical combinatorics. Hence, it is not good for scientific research if you don’t understand Chinese philosophy because it is a system notion on things for Chinese, which is in fact the Smarandache multispace in an early form. There is an old saying, i.e., philosophy gives people wisdom and mathematics presents us precision. The organic combination of them comes into being the scientific notion for multi-facted nature of natural things on Smarandache multispaces, i.e., mathematical combinatorics. This is a kind of sublimation of scientific research and good for understanding the nature.”

This is my report on Dr.Linfan Mao with his combinatorial notion. We therefore note that Dr.Linfan Mao is working on a way conforming to the natural law of human understanding. As he said himself: “mathematics can not be existed independent of the nature, and only those of mathematics providing human beings with effective methods for understanding the nature should be the search aim of mathematicians!” As a matter of fact, the mathematical combinatorics initiated by him in recent decade is such a kind of mathematics following with researchers, and there are journals and institutes on such mathematics. We believe that mathematicians would provide us more and more effective methods for understanding the nature following his combinatorial notion and prompt the development of human society in harmony with the nature.

The $3n \pm p$ Conjecture: A Generalization of Collatz Conjecture

W.B. Vasantha Kandasamy, Ilanthenral Kandasamy, Florentin Smarandache

W.B. Vasantha Kandasamy, Ilanthenral Kandasamy, Florentin Smarandache (2017). The $3n \pm p$ Conjecture: A Generalization of Collatz Conjecture. *Octagon Mathematical Magazine* 25(1), 26-33; DOI: 10.22147/jusps-A/290207

ABSTRACT. The Collatz conjecture is an open conjecture in mathematics named so after Lothar Collatz who proposed it in 1937. It is also known as $3n + 1$ conjecture, the Ulam conjecture (after Stanislaw Ulam), Kakutani's problem (after Shizuo Kakutani) and so on. Several various generalizations of the Collatz conjecture have been carried. In this paper a new generalization of the Collatz conjecture called as the $3n \pm p$ conjecture; where p is a prime is proposed. It functions on $3n + p$ and $3n - p$, and for any starting number n , its sequence eventually enters a finite cycle and there are finitely many such cycles. The $3n \pm 1$ conjecture, is a special case of the $3n \pm p$ conjecture when p is 1.

1 INTRODUCTION

The Collatz conjecture is a long standing open conjecture in number theory. Paul Erdos had commented about the Collatz conjecture that "*Mathematics may not be ready for such problems*". The Collatz conjecture has been extensively studied by several researchers [1, 2, 3, 4, 5]. A novel theoretical framework was formulated for information discovery using the Collatz conjecture data by Idowu [6]. Generalizing the odd part of the Collatz conjecture was studied by [7]. Several various generalizations of the Collatz conjecture were studied by [8]. Various generalizations are listed and given in number theory website of Keith Matthews [9].

This paper proposes a new conjecture which is a generalization of the Collatz conjecture. This new conjecture is called as the $3n \pm p$ conjecture, where p is a prime. This paper is organized into four sections. First section is introductory in nature. Section two recalls the Collatz conjecture and its various generalizations so that the paper is self contained.

Section three proposes the new $3n \pm p$ conjecture and illustrates it by examples. The conclusions and future study are given in the last section.

2 COLLATZ CONJECTURE AND ITS VARIOUS GENERALIZATIONS

2.2. Collatz Conjecture

The $3n + 1$ conjecture or the Collatz conjecture is summarized as follows:

Take any positive integer n . If n is even divide it by 2 to get $n/2$. If n is odd multiply it by 3 and add 1 to obtain $3n + 1$. Repeat the process (which has been called "Half Or Triple Plus One" or HOTPO) indefinitely. The conjecture states that no matter what number you start with you will always eventually reach 1.

Consider the following operation on an arbitrary positive integer: If the number is even divide it by two, if the number is odd, triple it and add one. This is illustrated by example of taking numbers from 4 to 10 and the related sequence is obtained:

- $n = 4$; related sequence is 4, 2, 1.
- $n = 5$, related sequence is 5, 16, 8, 4, 2, 1.
- $n = 6$, related sequence is 6, 3, 10, 5, 16, 8, 4, 2, 1.
- $n = 7$, related sequence is 7, 22, 11, 34, 17, 52, 26, 13, 40, 20, 10, 5, 16, 8, 4, 2, 1.
- $n = 8$, related sequence is 8, 4, 2, 1.
- $n = 9$, related sequence is 9, 28, 14, 7, 22, 11, 34, 17, 52, 26, 13, 40, 20, 10, 5, 16, 8, 4, 2, 1.
- $n = 10$, related sequence is 10, 5, 16, 8, 4, 2, 1.

In simple modular arithmetic notation the Collatz conjecture can be represented as

$$f(n) = \begin{cases} \frac{n}{2} & \text{if } n \equiv 0 \pmod{2} \\ \frac{3n+1}{2} & \text{if } n \equiv 1 \pmod{2} \end{cases} \quad (1)$$

Note: Only powers of two converge to one quickly.

2.2. Various generalization of the Collatz Conjecture

Several researchers have studied and generalized the Collatz conjecture. Some generalize by taking different values for 2 as 3, 5, etc [9]. Keith Matthew [9] has studied for $3n + 371$ and so on. Some natural generalizations of the Collatz Problem was done by Carnielli [8]. Lu Pei has given a generalization of $3x - 1$ mapping in [9]. The generalization of the $3n - 1$ mapping due to Lu Pei is given verbatim from [9].

Consider the mapping $T_d : Z \leftarrow Z$. Let $d \geq 2$. Then

$$T_d(n) = \begin{cases} \frac{n}{d} & \text{if } n \equiv 0 \pmod{d} \\ \frac{(d+1)n-i}{2} & \text{if } n \equiv i \pmod{d} \end{cases} \quad (2)$$

where $-d/2 \leq i \leq d/2; i \neq 0$.

In case, $d = 2$ it gives the $3n - 1$ mapping:

$$T_2(n) = \begin{cases} \frac{n}{2} & \text{if } n \equiv 0 \pmod{2} \\ \frac{3n-1}{2} & \text{if } n \equiv 1 \pmod{2} \end{cases} \quad (3)$$

This is a special case of a version of a mapping studied by Herbert Moller [10] and is also an example of a relatively prime mapping, in the language of Matthews and Watts, where $m_0 = 1$ and $m_i = d+1$ for $1 \leq i \leq d$ and where we have the inequality

$$m_0 m_1 \dots m_d = (d + 1)^{d-1} < d^d$$

So it seems certain that the sequence of iterates

$$n, T_d(n), T_d^2(n), \dots$$

always eventually enters a cycle and that there are only finitely many such cycles.

Clearly $T_d(n) = n$ for $-d/2 < n \leq d/2$. For $d = 3, 6$ and 10 , there appears to be no other cycles. By replacing 2 by d , it given the $3x - 1$ conjecture will eventually enter a cycle. It is showed that the $3n + 1$ collatz conjecture when n is negative has finite cycles which terminates in -1 or -5 or -17 [9].

Thus if for every non zero $n \in Z$ the $3n + 1$ Collatz conjecture converges to $\{-17, -5, -1, 1\}$ and the $3n - 1$ collatz conjecture converges to $\{-1, 1, 5, 17\}$.

The $3n - 1$ conjecture is a special case of the Lu Pei's generalization of the Collatz conjecture. The $3n - 1$ conjecture is described here for clarity.

2.3. The $3n - 1$ Conjecture

The $3n - 1$ conjecture which is akin to the Collatz conjecture is proposed in this section. The $3n - 1$ conjecture is as follows:

Take any arbitrary positive integer n . If n is even divide it by two and get $n/2$ if n is odd multiply it by 3 and subtract 1 and obtain $3n - 1$, repeat this process indefinitely. We call this process as "Half Or Triple Minus One" or HOTO. The conjecture states that immaterial of which number you begin with, you will eventually reach 1 or 5 or 17.

2.3.1. Statement of the Problem/Conjecture

On any arbitrary positive integer, consider the operation

- If the number is even, divide it by two
- Else triple it and subtract one

continue this process recursively. The $3n - 1$ conjecture is that this process which will eventually reach either 1 or 5 or 17, regardless of which positive integer is selected at the beginning.

The smallest i such that $a_i = 1$ or 5 or 17 is called as the total stopping time of n . The $3n - 1$ conjecture asserts that every n has a well defined total stopping time i . If for some n (any positive integer) such i (total stopping time) doesn't exist, then n has an infinite total stopping time then the conjecture is false. It can happen only because there is some starting number which gives a sequence that does not contain 1, 5 or 17. Such a sequence may have a repeating cycle that does not contain 1, 5 or 17 or it might increase without bounds. Till now such a sequence or number has not been found.

In simple modular arithmetic notation the $3n - 1$ conjecture can be represented as

$$f(n) = \begin{cases} \frac{n}{2} & \text{if } n \equiv 0 \pmod{2} \\ \frac{3n-1}{2} & \text{if } n \equiv 1 \pmod{2} \end{cases} \tag{4}$$

A sequence is formed by performing this operation repeatedly, it starts with any arbitrary positive integer and takes the result each step as the input for the next.

$$a_i = \begin{cases} n & \text{if } i = 0 \\ f(a_{i-1}) & \text{if } i \neq 0 \end{cases} \tag{5}$$

$a_i = f^i(n)$ that is a_i is the value of f applied to n recursively i times; n is the starting number and i at the end of the sequence is called the total stopping time.

Examples

The conjecture states that the sequence will reach 1, 5 or 17. The following repeated sequences / cycles happen for 1, 5 or 17.

1. $n = 1$; the repeated sequence is 4, 2, 1.
2. $n = 5$; the repeated sequence is 14, 7, 20, 10, 5.
3. $n = 17$; the repeated sequence is 50, 25, 74, 37, 110, 55, 164, 82, 41, 122, 61, 182, 91, 272, 136, 68, 34, 17.

We will illustrate this conjecture by some examples using the $3n - 1$ formula and taking numbers from 4 to 10. It is tabulated in Table 1

Table 1: Illustration of the $3n - 1$ conjecture

n	Sequence	i	Ends in
4	4, 2, 1	3	1
5	5, 14, 7, 20, 10, 5	1	5
6	6, 3, 8, 4, 2, 1	6	1
7	7, 20, 10, 5	4	5
8	8, 4, 2, 1	4	1
9	9, 26, 13, 38, 19, 56, 28, 14, 7, 20, 10, 5	12	5
10	10, 5	2	5

Similar to $3n + 1$ conjecture in $3n - 1$ conjecture also the powers of 2, converge quickly. Figure 2.3.2 gives the scatter plot that takes the starting number n from 1 to 1000 along the x-axis and the total stopping number i along the y-axis. Depending on which number the sequence ends, the colour is given. If the sequence ends in 1, then blue colour is given, if it ends in 5 then red colour is given and if it ends in 17 green colour is given.

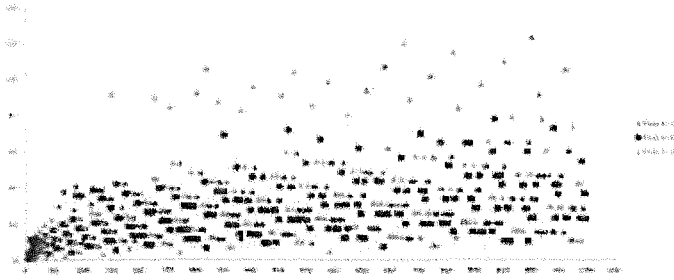

Figure 1. The scatter plot of first 1000 numbers and their stopping times

The $3n - 1$ conjecture creates a sequence that ends in 3 different numbers with the sequence having a repeated sequence of

1. for any negative n the sequence ends in -1 .
2. $n = 1$; the repeated sequence is 4, 2, 1.
3. $n = 5$; the repeated sequence is 14, 7, 20, 10, 5.
4. $n = 17$; the repeated sequence is 50, 25, 74, 37, 110, 55, 164, 82, 41, 122, 61, 182, 91, 272, 136, 68, 34, 17.

The $3n - 1$ conjecture and $3n + 1$ conjecture are mirror functions. The $3n \pm p$ conjecture is defined in the next section.

3 THE $3n \pm p$ CONJECTURE

The $3n + p$ and $3n - p$ conjecture (or simply the $3 \pm p$ conjecture) is given in the following:

$$T(n) = \begin{cases} \frac{n}{2} & \text{if } n \equiv 0(\text{mod } 2) \\ \frac{3n \pm p}{2} & \text{if } n \equiv 1(\text{mod } 2) \end{cases} \quad (6)$$

In simple modular arithmetic notation the $3n + p$ conjecture can be represented as

$$f(n) = \begin{cases} \frac{n}{2} & \text{if } n \equiv 0(\text{mod } 2) \\ \frac{3n + p}{2} & \text{if } n \equiv 1(\text{mod } 2) \end{cases} \quad (7)$$

and the $3n - p$ conjecture can be represented as

$$f(n) = \begin{cases} \frac{n}{2} & \text{if } n \equiv 0(\text{mod } 2) \\ \frac{3n-p}{2} & \text{if } n \equiv 1(\text{mod } 2) \end{cases} \tag{8}$$

It is clearly seen when $p = 1$, we see the sequence converges to $\{-17, -5, -1, 0, 1\}$ and when $p = -1$, the sequence converges to $\{-1, 0, 1, 5, 17\}$. When p is 1, it is Collatz conjecture and when p is -1 it is $3n - 1$ conjecture. We show for $3n + 5$ the sequence converges to $\{-85, -25, -5, -1, 0, 1, 5, 19, 23, 187, 407\}$ for any n in Z . For $3n - 5$ we get $\{-407, -187, -23, -19, -5, -1, 0, 1, 5, 25, 85\}$. $3n + 5$ and $3n - 5$ act like mirror functions.

In Table2 some $3n \pm p$ conjecture and their minimum cycle elements are listed.

Table 2: Illustration of the $3n \pm p$ conjecture

Sequence	Ends in
$3n + 3$	$\{-51, -5, -3, 0, 1, 3\}$
$3n - 3$	$\{-3, -1, 0, 3, 5, 51\}$
$3n + 5$	$\{-85, -25, -5, -1, 0, 1, 5, 19, 23, 187, 407\}$
$3n - 5$	$\{-407, -187, -23, -19, -5, -1, 0, 1, 5, 25, 85\}$
$3n + 7$	$\{-119, -35, -7, -1, 0, 1, 5, 7\}$
$3n - 7$	$\{-7, -5, -1, 0, 1, 7, 35, 119\}$
$3n + 11$	$\{-187, -55, -19, -11, -3, -1, 0, 1, 11, 13\}$
$3n - 11$	$\{-13, -11, -1, 0, 1, 3, 11, 19, 55, 187\}$
$3n + 13$	$\{-221, -65, -13, -1, 0, 1, 13, 131, 211, 227, 251, 259, 283, 287, 319\}$
$3n - 13$	$\{-319, -287, -283, -259, -251, -227, -211, -131, -13, -1, 0, 1, 13, 65, 221\}$

It is conjectured that for every prime p the $3n \pm p$ sequence will result in a finite cycle and there are finite number of such cycles.

4 RESULTS AND FURTHER STUDY

The proposed $3n \pm p$ conjecture is a new generalization of the $3n + 1$ conjecture or the Collatz conjecture. Given any starting number n , the conjecture states that the sequence will result in a finite cycle and there are finite number of such cycles. Cycles related to the $3n \pm p$, resulting hailstone numbers and parity sequence are left open for study.

REFERENCES

- [1] Lagarias, J.C., *The $3x+1$ problem and its generalizations*, The American Mathematical Monthly 92(1), 1985, pp. 3-23.
- [2] Van Bendegem, J.P., *The collatz conjecture. A case study in mathematical problem solving*, Logic and Logical Philosophy 14 (1), 2005, pp. 7-23.
- [3] Andrei, Ş, Masalagiu, C., *About the collatz conjecture*, Acta Informatica 35, (2), 1998, pp. 167-179.
- [4] Garner, L.E., *On the collatz $3n+1$ algorithm*, Proceedings of the American Mathematical Society 82 (1), 1981, pp. 19-22.
- [5] LaTourette, K., et al., *Explorations of the collatz conjecture*, Moravian College Senior Honors Thesis.
- [6] Idowu, M.A., *A novel theoretical framework formulated for information discovery from number system and collatz conjecture data*, Procedia Computer Science 61, 2015, pp. 105-111
- [7] Zavislak, W., *Some natural generalizations of the collatz problem*
- [8] Carnielli, W., *Some natural generalizations of the collatz problem.*
- [9] Matthew, K., *Bcmath programs for some generalized $3x+1$ mapping sequences*, 2016.

How many points are there in a Line Segment? A New Answer from a Discrete Cellular Space Viewpoint

Victor Christianto, Florentin Smarandache

Victor Christianto, Florentin Smarandache (2018). How many points are there in a Line Segment? A New Answer from a Discrete Cellular Space Viewpoint. *Octagon Mathematical Magazine* 26(2), 604-615

ABSTRACT. While it is known that Euclids five axioms include a proposition that a line consists at least of two points, modern geometry consistently avoids any discussion on the precise definition of points, lines, etc. It is our aim to clarify one of notorious question in Euclidean geometry from discrete cellular space (DCS) viewpoint: How many points are there in a line segment? In retrospect, it may offer an alternative for quantum gravity, i.e., by exploring discrete gravitational theories. To elucidate our propositions, in the last section we will discuss some implications of the discrete cellular space model in several areas of interest: (a) cell biology, (b) cellular computing, (c) Maxwell equations, (d) low energy fusion, and (e) cosmology modelling.

I consider it quite possible that physics cannot be based on the field concept, i.e., on continuous structures. In that case nothing remains of my entire castle in the air gravitation theory included, -and of- the rest of modern physics. A. Einstein

INTRODUCTION

So many students of all ages have asked this question: how many points are there in a line segment? A good math teacher would answer politely: in the circumference of a circle there are an infinite number of points [1]. Similarly, one can also ask: how many lines are there in a rectangle? The answer again is known: there are infinite number of lines in given rectangle. But a careful student would ask again: then what is the definition of a point and a line? The teacher would answer again: a point is a circle with a zero diameter, and a line is composed of infinite points.

If our beloved student persisted, he/she would continue to ask: but teacher, if a circle has a zero diameter, then an infinite number of zeroes will not make a finite line, right? At this time, there is fair chance that the teacher would feel upset and say: shut up and calculate! That is what usually happens in most primary and high school mathematics classrooms, and the situation is not getting better in the undergraduate classroom. Only in graduate math class are the students allowed to ask deeper questions concerning the foundations of mathematics, etc. A more serious debate among mathematicians over this notorious continuum problem has been recorded in reference [11].

Here, we will offer a simpler solution of the above posed question from a discrete cellular space (DCS) viewpoint, with wide implications, including more clarity in the distinction between quantization and discretization.

2 SOLUTION: SPACE CONSISTS OF CIRCLES WITH FINITE DIAMETERS (DISCRETE-CELLULAR MODEL)

The obvious paradox that we set in the introduction section can be simplified as follows:

$$0+0+0+\dots \text{ad infinitum} = 0$$

Therefore, the basic postulate that a line segment consists of circles with zero diameter is contradictory by itself. Our proposed solution is to assume that space consists of circles with small but finite diameter (z), therefore if a line segment consists of circles like that, we have:

$$z+z+z+\dots \text{ad infinitum} = \text{finite line}$$

One implication of this proposition is that we should consider the geometry of space not as continuum, but as a discrete cellular space. We must also remember that the discretization of space is much more fundamental than quantization. Moreover, we can consider the following:

a. It can be shown that similar indeterminacy problems plague the very definition of differential calculus, as no one knows that actual size of dx . See H.J.M. Bos [2]:

2.15. I turn now to a difficulty which necessarily arises in any attempt to set up an infinitesimal calculus which takes the differential as fundamental concept, namely the indeterminacy of differentials.

The first differential dx of the variable x is infinitely small with respect to x , and it has the same dimension as x . These are the only conditions it has to satisfy, and they do not determine a unique dx , for if dx satisfies the conditions then clearly so do $2dx$ and $\frac{1}{2}dx$ and in general all adx for finite numbers a . That is, all quantities that have the same dimension and the same order of infinity as dx might serve as dx .

Moreover, there are elements not from this class which satisfy the conditions for dx ; for instance dx^2/a and \sqrt{adx} , for finite positive a of the same dimension as x . dx^2/a is infinitely small with respect to dx and \sqrt{adx} is infinitely large with respect to dx , so that there is even not a privileged class of infinite smallness from which dx has to be chosen; there is no first class of infinite smallness adjacent to 'finiteness'.

Thus first-order differentials involve a fundamental indeterminacy.

- b. Boyer has shown that Planck blackbody radiation can be derived from a discrete charge assumption (without partition as assumed by Planck). See [3].
- c. Lee Smolin has described three approaches to quantum gravity in his book [4]. Considering our proposition above however, it seems that the notion of quantum gravity may be not necessary. Instead, we should consider discrete gravity theories.
- d. Gary W. Gibbons and George F.R. Ellis have investigated a discrete Newtonian cosmology. That is a good start [5].
- e. Gerard t Hooft has proposed a discrete deterministic interpretation of QM [6]. However, it seems the use of both discrete and quantum language are superfluous. We need to let go of quantum terminology that has its own excess baggage.
- f. At the astronomical scale, Conrad Ranzan has proposed a cellular universe, which is essentially a Newtonian steady-state model with a discrete cellular space model [7]. In our view, such an approach needs to be explored and investigated further. See also our recent paper where we suggest an ultradiscrete KdV as a model of cosmology [8]. See also the Lindquist-Wheeler model [9][10]. We discuss this approach in the last example of the last section of this paper.
- g. It may be possible for certain conditions to consider a partial continuum and partially discrete space. In other words, we may have a hybrid space. We have yet to investigate it, however.

3 A FEW PHILOSOPHICAL CONSIDERATIONS

According to Miguel Lorente, in order to better understand these models, it would be useful to consider three levels of human knowledge in the comprehension of the physical world [12]:

Level 1: Physical magnitudes such as distances, intervals, force, mass and charge that are given by our sensation and perceptions.

Level 2: Mathematical structures that are the result of metrical properties given by measurements and numerical relations among them.

Level 3: Fundamental concepts representing the ontological properties of the physical world given by our intelligence in an attempt to know reality. This level of knowledge is not accepted by some philosophical positions like logical positivism, conventionalism and neokantism.

There must be some connections among the three levels. In QM, the theoretical models of microphysics in level 2 are related to observable magnitudes in level 1 by correspondence laws. If we accept level 3, it should be connected to level 2 and to level 1 (through level 2). In fact, the rules governing the constructions of theoretical models in level 2 must be grounded in some fundamental (ontological) properties of the physical world. It is also worth noting that there are different interpretations of the concepts of space and time. They are usually divided in three classes, as follows [12]:

(a) Dualistic theories: space is a container in which particles and waves are moving. Time is also a separate entity with respect to the motion that takes place. Therefore space and time are absolute and can be thought of in the absence of particles (Newton).

(b) Monistic theories: spacetime is identified with some properties of matter and cannot be conceivable without the existence of the latter. The field of forces and their sources are nothing more than geometrical deformations of spacetime (Einstein, Kaluza-Klein, Wheeler).

(c) Relational theories: spacetime consists of the set of relations among some fundamental objects, namely: monads (Leibniz), units (Penrose), processes (Weisaecker, Finkelstein), preparticles (Bunge, Garca Sucre) and objects (Hilbert).

In the present paper, following our argument in the previous section, we assert that space consists of discrete cells with finite dimensions, which is the

most realistic model to the best of our knowledge. Next, we will discuss some implications of our assertion in different areas of interest.

4 PROOF OF CONCEPT: A FEW IMPLICATIONS OF DISCRETE CELLULAR SPACE

To elucidate our propositions, we will discuss some implications of the discrete cellular space model in several areas of interest: (a) cell biology, (b) cellular computing, (c) Maxwell equations, (d) low energy fusion, and (e) cosmology modelling.

(a) **Cell biology.** The mathematical modeling of cell populations can be, broadly speaking, split into two categories: continuum and discrete models. Discrete models treat cells as individual entities and hence provide a natural framework within which to make use of an increasing amount of experimental data available at the cellular and subcellular scales. There are now many different types of discrete cell-level models used to describe cell populations, e.g., cellular automata, cellular Potts models, cell-vertex, and off-lattice cell-based model [19].

(b) While continuum models have their own advantages, they also have certain limitations [20]:

Continuum models of the cell aim at capturing its passive dynamics. In addition to the limitations mentioned above, current models do not yet typically account for active biology: deformations and stresses experienced as a direct consequence of biochemical responses of the cell to mechanical load cannot be predicted by current continuum models. However, by contrasting the predicted purely mechanical cell response to experimental observations, one could isolate phenomena involving active biology, such as cell contraction or migration, from the passive mechanical response of the cell. Alternatively, continuum models might be envisioned that account for active processes through time-dependent properties or residual strains that are linked to biological processes.

Another limitation of continuum models stems from lack of description of cytoskeletal bers. As such, they are not applicable for micromanipulations of the cell with a probe of the same size or smaller than the cytoskeletal mesh (0.11.0 m). This includes most AFM experiments. In addition, the continuum models exclude small Brownian motions due to thermal uctuations of the cytoskeleton, which would correspond to uctuations of the network nodes in a continuum model and have been shown to play a key role

in cell motility (Mogilner and Oster, 1996). Finally, continuum models have so far employed a limited number of time constants to characterize the cells behavior. However, cells have recently been shown to exhibit behaviors with power-law rheology, implying a continuous spectrum of time scales (Fabry et al., 2001; Desprat et al., 2004). In the meantime, models involving a finite number of time constants consistent with the time scale of the experimental technique can be used, recognizing their limitations [20].

(c) **Cellular computer.** Around 18 years ago, Sipper described a number of interesting features of the cellular computer. He began his article by noting that von Neumanns architecture - which is based upon the principle of one complex processor that sequentially performs a single complex task at a given moment - has dominated computing technology for the past 50 years. Recently, however, researchers have begun exploring alternative computational systems based on entirely different principles. Although emerging from disparate domains, the work behind these systems shares a common computational philosophy, which can be called cellular computing [21]. Cellular computers are supposed to have three principles in common. Combining these three principles results in the following definition: cellular computing = simplicity + vast parallelism + locality. Because the three principles are highly interrelated, attaining vast parallelism, for example, is facilitated by the cells simplicity and local connectivity. Changing any single term in the equation results in a different computational paradigm. So, for example, foregoing the simplicity property results in the distributed computing paradigm.

Cellular computing has been placed further along the parallelism axis to emphasize the vastness aspect [21]. What specific application areas invite a cellular computing approach?

Research has raised several possibilities: (1) Image processing. Applying cellular computers to perform image-processing tasks arises as a natural consequence of their architecture. For example, in a two-dimensional grid, a cell (or group of cells) can correspond to an image pixel, with the machines dynamics designed to perform a desired image-processing task. Research has shown that cellular image processors can attain a high level of performance and exhibit fast operation times for several problems. (2) Fast solutions to NP-complete problems. Even if only a few such problems can be dealt with, doing so may still prove highly worthwhile. NP-completeness implies that a large number of hard problems can be efficiently solved, given an efficient solution to any one of them. The list of NP-complete problems includes

hundreds of cases from several domains, such as graph theory, network design, logic, program optimization, and scheduling, to mention but a few.

(3) Generating long sequences of high-quality random numbers. This capability is of prime import in domains such as computational physics and computational chemistry. Cellular computers may prove a good solution to this problem. (4) Nanoscale calculating machines. Cellular computing's ability to perform arithmetic operations raises the possibility of implementing rapid calculating machines on an incredibly small scale. These devices could exceed current models' speed and memory capacity by many orders of magnitude. (5) Novel implementation platforms. Such platforms include reconfigurable digital and analog processors, molecular devices, and nanomachines. [21].

(d) Maxwells equations. While X.S. Wang [23] was able to derive the above mentioned Maxwells equations in vacuum based on a continuum mechanics model of vacuum and a singularity model of electric charges, Krasnoholovets managed to show in the meantime and quite remarkably that the very definition of charge can be modelled from the viewpoint of tessellated space [22]. He argued that Maxwells equations are the manifestation of hidden dynamics of surface fractals. He also concludes that James Clerk Maxwell was right when he utilized imaginary cogwheels constructing the equations of motion of an electromagnetic field [22, p. 128].

(e) Low energy fusion. Since the early years of condensed matter nuclear science (aka. LENR/cold fusion), Robert W. Bussard from the Energy/Matter Conversion Corporation has argued in favor of internal nuclear fusion in a metal lattice to explain the low energy reaction as reported by Pons and Fleischmann [24]. Subsequently, there are a number of researchers who have explored the implications of lattice vibration and lattice structure models from solid state physics in order to explain the CMNS process [25][26][27]. Such approaches seem to be quite promising and they are worthy to continue further. For a recent discussion on discrete and continuum modelling, see [28].

(f) Cosmology modelling. Many physicists and philosophers alike have debated a long-standing puzzle: whether space is continuous or discrete. It has been known for long time that most of the existing cosmology models rely on a pseudo-Riemannian metric as the cornerstone of the Einsteinian universe. However, the metric itself is based on continuum theory. It is

known that such models have led us to too many (monster) problems, including dark matter and dark energy etc. Now, what if the universe is discrete? Then perhaps we can solve these problems naturally.

Philosophically speaking, the notion of discrete space can be regarded as a basic question in the definition of differential calculus and limit. If it is supposed that space is continuous, then we can use standard differential calculus, but if we assume it is finite and discrete, we should use a difference equation or finite difference theories. This problem is particularly acute when we want to compute our mathematical models in computers, because all computers are based on discrete mathematics. Then we can ask: is it possible that discrete mathematics can inspire cosmology theorizing too? Despite the fact that the majority of cosmologists rely on a standard model called Lambda-CDM theory, here we will explore redshift theory based on a few lattice-cellular models, including Lindquist-Wheeler theory and beyond it. We will also touch briefly on some peculiar models such as Voronoi tessellation and Conrad Ranzans cellular model of the universe.

a). Lindquist-Wheelers theory. In this model, matter content is assumed to be discrete, identical spherically symmetric islands uniformly distributed in a regular lattice. This attempt was first introduced in 1957 by Lindquist and Wheeler (LW) in a seminal paper. While LW suggested that their global dynamics are similar to those of the Friedmann universe for closed dust dominated universe, Shalaby has shown that the LW-model can be extended to yield a redshift equation, as follows [9]:

$$1 + z = 1 + \langle y \rangle \ln \left(\frac{a_r}{a_e} \right) = 1 + \langle (y) \rangle \ln(1 + z_{FRW}) \simeq (1 + z_{FRW})^{\langle y \rangle} \quad (1)$$

It can be shown that the value of $\langle y \rangle$ approximates geometrically to be 2/3, however, numerically its value was estimated to be 7/10 [9]. Liu also analyzed the LW model and he concludes that LW redshifts can differ from their FLRW counterparts by as much as 30%, even though they increase linearly with FLRW redshifts and they exhibit a non-zero integrated Sachs-Wolfe effect, something that would not be possible in matter-dominated FLRW universes without a cosmological constant [10].

b. Voronoi Tessellation model. Rien van de Weygaert describes a novel model based on Voronoi tessellation. The spatial cosmic matter distribution on scales of a few up to more than a hundred Megaparsecs displays a salient and pervasive foam-like pattern [14]. Voronoi tessellations are a versatile and

flexible mathematical model for such web-like spatial patterns. Cellular patterns may be the source of an intrinsic geometrically biased clustering. However, so far we have not found a redshift equation from this model [13].

c. Non-expanding cellular universe. Conrad Ranzan suggests a DSSU cellular cosmology (dynamics steady state universe), which he claims to be problem-free. The cosmic redshift is shown to be a velocity-differential effect caused by a flow differential of the space medium. He obtains the cosmic redshift equation in its basic form [7]:

$$z = (1 + z_{GC})^N - 1 \quad (2)$$

There are other cellular cosmology models of course and some of them have been reviewed by Marmet, but this paper is not intended to be an exhaustive list of redshift models. See for example: Marmet [18].

CONCLUSION

An old question and paradox in Euclidean geometry may be resolved consistently once we accept and assume discrete cellular space instead of a continuum model, which is full of indeterminacies. Many implications and further developments can be expected both in the particle physics realm and also in cosmology theorizing. More observations and experiments are recommended to verify whether space is discrete, continuous, or hybrid.

In retrospect, it may offer an alternative for quantum gravity, i.e. by exploring discrete gravitational theories. To elucidate our propositions, we discussed some implications of the discrete cellular space model in several areas of interest: (a) cell biology, (b) cellular computing, (c) Maxwell equations, (d) low energy fusion, and (e) cosmology modelling.

Acknowledgements. The first author (VC) would like to thank the participants of the 3rd Conference on Theoretical Physics and Nonlinear Phenomena, held in Bandung at 1st August 2017, whose discussions have inspired this paper. Special thanks go to Prof. (Em.) Thee Houw Liong from the Bandung Institute of Technology (ITB) for encouraging advice, and also to an anonymous reviewer for suggesting improvement of this paper. We also gratefully appreciate Dr. Volodymyr Krasnoholovets for sending his new book describing the tessellation model of space and its physical implications.[22]

REFERENCES

- [1] <https://math.stackexchange.com/questions/1799125/how-many-points-in-a-line-segment>
- [2] H.J.M. Bos. Differentials, Higher Order Differentials, and the Derivative in the Leibnizian calculus. Arch. Hist. Exact. Sci. vol. 14, p. 24
- [3] Timothy H. Boyer. Connecting blackbody radiation, relativity, and discrete charge in classical electrodynamics. arXiv: physics/0605003 (2006)
- [4] Lee Smolin. Three roads to quantum gravity. Basic Books, 2001.
- [5] Gary Gibbons and George Ellis . Discrete Newtonian Cosmology. Classical and Quantum Gravity vol. 31, no. 2, (2013), see also arXiv: 1308.1852 (2013). url: <http://iopscience.iop.org/article/10.1088/0264-9381/31/2/025003/meta>
- [6] Gerard t Hooft. A Deterministic Interpretation of Quantum Mechanics. url: www.rug.nl/research/vsi/events/groenewold/thooft.pdf
- [7] Conrad Ranzan. Large scale structure of the Dynamic Steady State Universe. American Journal of Astronomy and Astrophysics 2016, 4(6): 65-77. <http://www.sciencepublishinggroup.com>. See also www.cellularuniverse.org
- [8] Victor Christianto & Florentin Smarandache & Yunita Umniyati. An outline of Cellular Automaton Universe via Cosmological KdV equation. Published at Prespacetime Journal, and this paper was also presented at CTPNP 3rd, 1st Aug 2017, held in Bandung, Indonesia.
- [9] Mohamad Shalaby. Dynamics and Light Propagation in a Universe with Discrete-Matter Content. arXiv: 1205.68773 [gr-qc]
- [10] Rex G. Liu. The Lindquist-Wheeler formulation of lattice universes. arXiv: 1501.05169 [gr-qc]
- [11] <https://www.ias.edu/ideas/2011/kennedy-continuum-hypothesis>
- [12] Miguel Lorente. A realistic interpretation of lattice gauge theories. arXiv: hep-lat/0312044v1 (2003)
- [13] Rien van de Weygaert. Voronoi Tessellations and the Cosmic Web: spatial patterns and clustering across the Universe. Proc. of the 4th International Symposium on Voronoi Diagrams in Science and Engineering, p.230-239, July 09-11, 2007 [doi:10.1109/ISVD.2007.48]. url: <http://www.astro.rug.nl/weygaert/tim1publication/vorwey.isvd07.pdf>
- [14] A.A. Kirillov & D. Turaev. Foam-like structure of the Universe. Phys. Lett. B 656 (2007) 1-9.
- [15] Conrad Ranzan. Cosmic redshift in the non-expanding cellular universe: velocity-differential theory of cosmic redshift. American Journal of Astronomy and Astrophysics 2014, 2(5): 47-60

- [16] Large scale structure of the Dynamic Steady State Universe. American Journal of Astronomy and Astrophysics 2016, 4(6): 65-77.
<http://www.sciencepublishinggroup.com>
- [17] Chris Hand. Simple cellular automata on a spreadsheet. CHEER, vol. 17, 2005. url: <http://economicsnetwork.ac.uk/cheer/ch17/hand.htm>
- [18] Louis Marmet. On the Interpretation of Red-Shifts: A Quantitative Comparison of Red-Shift Mechanisms II. <http://www.marmet.org>
- [19] Philip J. Murray et al. From a discrete to a continuum model of cell dynamics in one dimension. Phys. Rev. E80 (2009).
- [20] Mohammad R. K. Mofrad, Helene Karcher, and Roger D. Kamm. Continuum elastic or viscoelastic models of the cell. Chapter 4 in Cytoskeletal Mechanics: Models and Measurements in Cell Mechanics. <https://books.google.co.id/books?isbn=1139458108>
- [21] M. Sipper, The Emergence of Cellular Computing, IEEE Computer, vol. 32, no. 7, pp. 18-26, July 1999. url: <https://www.cs.bgu.ac.il/sipper/publications/cellcomp.pdf>
- [22] Volodymyr Krasnoholovets. Structure of Space and the Submicroscopic Deterministic Concept of Physics. USA: Apple Academic Press & CRC, 2017. P. 118-145
- [23] Xiao-Song Wang. Derivation of the Maxwells Equations Based on a Continuum Mechanical Model of Vacuum and a Singularity Model of Electric Charges. arXiv: physics/0609027 (2006)
- [24] Robert W. Bussard. Virtual state internal nuclear fusion in metal lattice. Fusion Technology, Volume 16, September 1989.
- [25] Steven E. Jones, E.P. Palmer, J.B. Czirr, D.L. Decker, G.L. Jensen, J.M. Thorne, S.F. Taylor, and J. Rafelski; Observations of Cold Nuclear Fusion in Condensed Matter, Nature 338: 737, 740, April 1989
- [26] Martin Fleischmann and Stanley Pons; Electrochemically Induced Nuclear Fusion of Deuterium, Journal Electroanalytical Chemistry, 261, 301, 1989.
- [26] V.B. Belyaev et al. Nuclear fusion induced by X-rays in a crystal. arXiv: 1603.01723 (2016)
- [27] Yoshiaki Arata & Yue-Chang Zhang. Formation of condensed metallic deuterium lattice and nuclear fusion. Proc. Japan Acad., 78, Ser. B (2002), 57-60.
- [28] V. A. Kuzkin, A. M. Krivtsov, E. A. Podolskaya & M. L. Kachanov (2016): Lattice with vacancies: elastic fields and effective properties in frameworks of discrete and continuum models, Philosophical Magazine.

Some Results on Various Cancellative CA-Groupoids and Variant CA-Groupoids

Zhirou Ma, Xiaohong Zhang, Florentin Smarandache

Zhirou Ma, Xiaohong Zhang, Florentin Smarandache (2020). Some Results on Various Cancellative CA-Groupoids and Variant CA-Groupoids. *Symmetry* 12, 315; DOI: 10.3390/sym12020315

Abstract: Cyclic associativity can be regarded as a kind of variation symmetry, and cyclic associative groupoid (CA-groupoid) is a generalization of commutative semigroup. In this paper, the various cancellation properties of CA-groupoids, including cancellation, quasi-cancellation and power cancellation, are studied. The relationships among cancellative CA-groupoids, quasi-cancellative CA-groupoids and power cancellative CA-groupoids are found out. Moreover, the concept of variant CA-groupoid is proposed firstly, some examples are presented. It is shown that the structure of variant CA-groupoid is very interesting, and the construction methods and decomposition theorem of variant CA-groupoids are established.

Keywords: cyclic associative groupoid (CA-groupoid); cancellative; variant CA-groupoids; decomposition theorem; construction methods

1. Introduction

An algebraic structure is called a groupoid, if it is well-defined regarding an operation on it. A groupoid satisfying the “cyclic associative law” (that is, $x(yz) = y(zx)$) is called a cyclic associative groupoid, or simply CA-groupoid [1,2].

In fact, as early as 1946, when Byrne [3] studied axiomatization of Boolean algebra, he mentioned the following operation law: $(xy)z = (yz)x$. Obviously, its dual form is as follows: $z(yx) = x(zy)$, this is the cyclic associative law mentioned above. In 1954, Sholander [4] mentioned Byrne’s paper [3], and used the term of “cyclic associative law” to express the operation law: $(ab)c = (bc)a$. This is the first literature we know to use the term “cyclic associative law”. At the same time, Hosszu also used the term of “cyclic associative law” in the study of functional equation (see [5] and the introduction and explanation by Maksa [6]). Later, Kleinfeld [7] and Behn [8,9] studied the rings satisfying the cyclic associative law, and Iqbal et al. [10] studied the AG-groupoids satisfying the cyclic associative law. It is on the basis of these researches that we start to systematically study the groupoids satisfying the cyclic binding law (CA-groupoids) in [1,2], in order to provide a common basis for the research of related algebraic systems.

As a continuation of [1,2], this paper focuses on various cancellation properties of CA-groupoids and a special class of CA-groupoids. In many algebraic systems (such as semigroups, commutative semigroups and AG-groupoids), the cancellation, quasi-cancellation and power cancellation properties have important research value (see [11–26]). In 1957, Takayuki Tamura studied commutative non-potent Archimedean semigroups with cancellative law (see [11]), cancellability is applied to semigroups. Since then, various cancellative laws have been put forward and applied to various algebraic systems, and a series of valuable conclusions have been drawn. The rise of these properties makes an irreplaceable contribution to the development of algebra.

Semigroup with the identity is named monoid, the research of monoid is gradually deepening (see [24,27]). In addition, AG-group is an AG-groupoid with the left identity and inverses (see [28–32]). Through these papers, we know that the identity is a powerful tool for solving algebraic problems. Therefore, we naturally consider CA-groupoids with unit element. However, our study finds that CA-groupoids with unit element degenerate into commutative monoids, and a CA-groupoid with quasi right unit element (i.e., there exists e , if $x \neq e$, then $xe = x$; and $ee \neq e$) maybe not a semigroup. Moreover, this kind of CA-groupoids (with quasi right unit element) not only has very interesting properties, but also promotes the study of algebraic structures such as rings and semirings (some examples are presented in Section 5). Therefore, this paper studies it in depth, and we call them variant CA-groupoids.

At last, the content of this paper as follows: in Section 2, we introduce some basic concepts and cancellative properties on semigroup and AG-groupoid; in Section 3, we give the definitions of cancellative CA-groupoids, left cancellative CA-groupoids, right cancellative CA-groupoids and weak cancellative CA-groupoids, and discuss the relationships about them; in Section 4, we give the definitions of several quasi-cancellative CA-groupoids and power cancellative CA-groupoids, and analyze the relationships about several types cancellative CA-groupoids; in Section 5, we propose the new notion of variant CA-groupoid and some interesting examples, moreover, we prove the structure theorem and construction method of variant CA-groupoids.

2. Preliminaries

This paper mainly studies some special types of CA-groupoids. In this section some notions and results on semigroups and CA-groupoids are given. A groupoid $(S, *)$ is a non-empty set S together with a binary operation $*$. Traditionally, the $*$ operator is omitted without confusion, and $(S, *)$ is abbreviated to S . For a groupoid S , an element $a \in S$ is called to be left cancellative (respectively right cancellative) if for all $x, y \in S$, $ax = ay$ implies $x = y$ ($xa = ya$ implies $x = y$); an element is called to be cancellative if it is both left and right cancellative. A groupoid S satisfying the associative law is called a semigroup. A monoid S is a semigroup with an identity element.

Definition 1. [1] Let S be a groupoid. If for all $a, b, c \in S$, $a(bc) = c(ab)$, then S is called a cyclic associative groupoid (or shortly CA-groupoid).

Proposition 1. [1] If S is a CA-groupoid, then, for any $a, b, c, d, x, y \in S$:

- (1) $(ab)(cd) = (da)(cb)$;
- (2) $(ab)((cd)(xy)) = (da)((cb)(xy))$.

Proposition 2. [1] Every commutative semigroup is a CA-groupoid. Assume that (S, \cdot) is a CA-groupoid, if S is commutative, then S is a commutative semigroup.

Proposition 3. [1] Let S be a CA-groupoid. (1) If S have a left identity element, that is, there exists $e \in S$ such that $ea = a$ for all $a \in S$, then S is a commutative semigroup (thus, S is a commutative monoid). (2) If $e \in S$ is a left identity element in S , then e is an identity element in S . (3) If $e \in S$ is a right identity element in S , that is, $ae = a$ for all $a \in S$, then e is an identity element in S . (4) If S have a right identity element, then S is a commutative semigroup (thus, S is a commutative monoid).

Proposition 4. [1] Let S be a CA-groupoid. If for all $a \in S$, $a^2 = a$, then S is commutative (thus, S is a commutative semigroup).

Proposition 5. [1] Let S_1, S_2 be two CA-groupoids. Then the direct product $S_1 \times S_2$ is a CA-groupoid.

Definition 2. [2] An element a of a CA-groupoid S is called locally associative if satisfied:

$$a(aa) = (aa)a.$$

S is called a locally associative CA-groupoid, if all elements in S are locally associative.

Definition 3. [2] Let S be a groupoid. If for all $a, b, c \in S$:

$$a(bc) = (ab)c, a(bc) = c(ab),$$

then S is called a cyclic associative semigroup (shortly, CA-semigroup).

Definition 4. [18] Let S be a semigroup. S is called a separative semigroup, if for any $x, y \in S$:

(i) $x^2 = xy$ and $y^2 = yx$ imply $x = y$;

(ii) $x^2 = yx$ and $y^2 = xy$ imply $x = y$.

A semigroup S is called quasi-separative if for all $a, b \in S, x^2 = xy = y^2$ imply $x = y$.

3. Cancellation Properties of CA-Groupoids

Definition 5. Assume that S is a CA-groupoid. If every element of S is left cancellative (right cancellative, cancellative), then S is called a left cancellative (right cancellative, cancellative) CA-groupoid.

Example 1. Let $S = \{\bar{0}, \bar{1}, \bar{2}, \bar{3}, \bar{4}\}$. For all $x, y \in S$, the operation $*$ on S is defined as $x*y = \overline{x + y} = x + y \pmod{5}$, see Table 1. Then, $(S, *)$ is a cancellative CA-groupoid.

Table 1. The operation $*$ on S .

$*$	$\bar{0}$	$\bar{1}$	$\bar{2}$	$\bar{3}$	$\bar{4}$
$\bar{0}$	$\bar{0}$	$\bar{1}$	$\bar{2}$	$\bar{3}$	$\bar{4}$
$\bar{1}$	$\bar{1}$	$\bar{2}$	$\bar{3}$	$\bar{4}$	$\bar{0}$
$\bar{2}$	$\bar{2}$	$\bar{3}$	$\bar{4}$	$\bar{0}$	$\bar{1}$
$\bar{3}$	$\bar{3}$	$\bar{4}$	$\bar{0}$	$\bar{1}$	$\bar{2}$
$\bar{4}$	$\bar{4}$	$\bar{0}$	$\bar{1}$	$\bar{2}$	$\bar{3}$

Definition 6. Assume that S is a CA-groupoid. Let $x \in S$, if for any $y, z \in S, xy = xz$ and $yx = zx$ imply $y = z$, then x is called to be weak cancellative. If all elements in S are weak cancellative, then S is called a weak cancellative CA-groupoid.

● Obviously, for a CA-groupoid S and any $x \in S$, if x is a left (or right) cancellative, then x is weak cancellative.

Example 2. Let $S = \{1, 2, 3, 4\}$. The operation $*$ on S is defined as Table 2. Then, $(S, *)$ is a weak cancellative CA-groupoid.

Table 2. The operation $*$ on S .

$*$	1	2	3	4
1	4	3	2	1
2	3	1	4	2
3	2	4	1	3
4	1	2	3	4

Theorem 1. *Let S be a CA-groupoid. Then, for any element $a, b \in S$:*

- (1) *if a is left cancellative, then a is right cancellative, thus a is cancellative;*
- (2) *if a and b are left cancellative, then ab is right cancellative;*
- (3) *if a is right cancellative and b is left cancellative, then ab is right cancellative;*
- (4) *if ab is right cancellative, then $ab = ba$;*
- (5) *if ab is cancellative, then b is cancellative;*
- (6) *if ab is cancellative, then a and b are cancellative;*
- (7) *if a and ab are right cancellative, and b is left cancellative, then a is cancellative;*
- (8) *if a and ab are right cancellative, and b is left cancellative, then ab is cancellative.*

Proof. Suppose that $(S, *)$ is a CA-groupoid and $a, b \in S$.

- (1) Assume that a is a left cancellative element. If $(\forall x, y \in S) x^*a = y^*a$, then (by cyclic association):

$$a^*(a^*x) = x^*(a^*a) = a^*(x^*a) = a^*(y^*a) = a^*(a^*y).$$

From this, applying left cancellation property of a , $a^*x = a^*y$. From this, applying left cancellation property of a one time, we get that $x = y$. Therefore, a is a right cancellative element in S , so a is a cancellative element in S .

- (2) Suppose that a and b are left cancellative. If $(\forall x, y \in S) x^*ab = y^*ab$, then:

$$a^*(b^*x) = x^*(a^*b) = x^*(ab) = y^*(ab) = y^*(a^*b) = b^*(y^*a) = a^*(b^*y).$$

Since a is left cancellative, so $b^*x = b^*y$. Moreover, from this and b is left cancellative, we get that $x = y$. Therefore, ab is a right cancellative.

- (3) Assume that a is right cancellative and b is left cancellative. If $(\forall x, y \in S) x^*ab = y^*ab$, then:

$$b^*(x^*a) = a^*(b^*x) = x^*(a^*b) = x^*(ab) = y^*(ab) = y^*(a^*b) = b^*(y^*a).$$

Since b is left cancellative, so $x^*a = y^*a$. Moreover, from this and a is right cancellative, we get that $x = y$. Therefore, ab is a right cancellative.

- (4) Suppose that ab is right cancellative. Since:

$$ab^*ab = b^*(ab^*a) = a^*(b^*ab) = a^*(b^*ba) = ba^*ab$$

Since ab is right cancellative, we get that $ab = ba$.

- (5) Assume that ab is cancellative. If $b^*x = b^*y, x, y \in S$, then:

$$x^*ab = b^*(x^*a) = a^*(b^*x) = a^*(b^*y) = y^*ab$$

Since ab is cancellative, so $x = y$. This means that b is left cancellative. Applying (1), we get that b is cancellative.

(6) Assume that ab is cancellative. Using (5), we know that b is cancellative. Moreover, since ab is cancellative, so ab is right cancellative, applying (4) we get that $ba = ab$. Thus, ba is cancellative, using (5) again, a is cancellative.

(7) Suppose that a and ab are right cancellative, and b is left cancellative. If $a^*x = a^*y, x, y \in S$, then (applying Proposition 1 (1)):

$$b^*(xa^*ab) = b^*(bx^*aa) = b^*(ab^*ax) = b^*(ab^*ay) = b^*(ya^*ab).$$

Since b is left cancellative, so $xa^*ab = ya^*ab$. Using the condition that ab is right cancellative, it follows that $xa = ya$. Since a is right cancellative, thus, $x = y$. Hence, a is left cancellative. Therefore, a is cancellative

(8) Suppose that a and ab are right cancellative, and b is left cancellative. If $ab^*x = ab^*y, x, y \in S$, then:

$$b^*(xa^*ab) = ab^*(b^*xa) = ab^*(a^*bx) = ab^*(x^*ab) = ab^*(ab^*x) = ab^*(ab^*y) =$$

$$ab^*(y^*ab) = ab^*(a^*by) = ab^*(b^*ya) = b^*(ya^*ab).$$

Since b is left cancellative, so $xa^*ab = ya^*ab$. Using the condition that ab is right cancellative, it follows that $xa = ya$. Since a is right cancellative, thus, $x = y$. This means that ab is left cancellative. From this and ab is right cancellative, we know that ab is cancellative. \square

Applying Theorem 1 we can get the following corollaries.

Corollary 1. *Let S be a CA-groupoid. Then the following asserts are equivalent:*

- (1) S is a left cancellative CA-groupoid;
- (2) S is a right cancellative CA-groupoid;
- (3) S is a cancellative and commutative semigroup;
- (4) S is a cancellative CA-groupoid.

Proof. (1) \Rightarrow (2): It follows Theorem 1 (1).

(2) \Rightarrow (3): For any $a, b \in S$, then $ab \in S$. Since S is right cancellative, then ab is right cancellative. Applying Theorem 1 (4), $ab = ba$. This means that S is commutative. By Proposition 2, we know that S is a commutative semigroup. Moreover, since S is right cancellative, so S is left cancellative. Thus, S is a cancellative and commutative semigroup.

(3) \Rightarrow (4): Obviously.

(4) \Rightarrow (1): It follows from Definition 5. \square

Corollary 2. *Let S be a CA-groupoid. If there exists a cancellative element in S , then the set $H = \{a \in S: a \text{ is cancellative}\}$ is a sub CA-groupoid of S .*

Proof. By the condition that there exists a cancellative element in S , we know that H is not empty.

For any $a, b \in H$, then a and b are left and right cancellative. Applying Theorem 1 (2), we know that ab is right cancellative. By Theorem 1 (8), ab is cancellative. Thus $ab \in H$. It follows that H is a sub CA-groupoid of S . \square

Corollary 3. *Let S be a CA-groupoid. If there exists a non-cancellative element in S , then the set $K = \{a \in S: a \text{ is non-cancellative}\}$ is a sub CA-groupoid of S .*

Proof. Obviously, K is non-empty. For any $a, b \in K$, then a and b are non-cancellative. By Theorem 1 (5), we know that ab is non-cancellative. Thus $ab \in K$. It follows that K is a sub CA-groupoid of S . \square

The following example shows that a weak cancellative element maybe not a left (or right) cancellative element.

Example 3. *Let $S = \{1, 2, 3, 4, 5\}$, and the operation $*$ on S is defined as Table 3, then S is a CA-groupoid. It is easy to verify that 3 is weak cancellative, but 3 is not left (right) cancellative.*

Table 3. The operation * on S.

*	1	2	3	4	5
1	1	1	1	1	1
2	1	1	2	1	2
3	1	1	4	2	2
4	1	1	2	1	2
5	1	1	1	1	1

● **open Problem 1** (to prove or give a counterexample): Is any weak cancellative CA-groupoid necessarily cancellative?

Theorem 2. Let S be a CA-groupoid and $a, b, c \in S$. Define on S the relation \sim as:

$$a \sim b \Leftrightarrow a \text{ and } b \text{ are both cancellative or non - cancellative.}$$

Then \sim is an equivalence relation.

Proof. Suppose that a is a cancellative element (or non-cancellative element) of CA-groupoid S. Then $a \sim a$. This means that \sim is reflexive.

Suppose $a \sim b$. If a and b are cancellative, then $b \sim a$; if a and b are non-cancellative, then $b \sim a$. Thus \sim is symmetric.

Next, suppose that $a \sim b$ and $b \sim c$. If a and b are cancellative, from $b \sim c$ we know that c is cancellative, thus a and c are cancellative, i.e., $a \sim c$; if a and b are non-cancellative, from $b \sim c$ we know that c is non-cancellative, thus a and c are non-cancellative, i.e., $a \sim c$. Thus \sim is transitive.

Therefore, \sim is an equivalence relation. \square

Example 4. Let $S = \{1, 2, 3, 4\}$ and the operation * on S is defined as Table 4, then S is a CA-groupoid. Obviously, 1 and 2 are cancellative, 3 and 4 are non-cancellative. $H = \{1, 2\}$ is a sub CA-groupoid of S.

Table 4. The operation * on S.

*	1	2	3	4
1	1	2	4	3
2	2	1	3	4
3	3	4	4	3
4	4	3	3	4

Theorem 3. Let S_1, S_2 are CA-groupoids, then the direct product $S_1 \times S_2$ of S_1 and S_2 is a CA-groupoid. If $a \in S_1, b \in S_2, a$ and b are cancellative, then $(a, b) \in S_1 \times S_2$ is cancellative.

Proof. Suppose that S_1 and S_2 are CA-groupoids. By Proposition 5, $S_1 \times S_2$ is a CA-groupoid. Let $a \in S_1, b \in S_2, a$ and b be cancellative. For any $(x_1, x_2), (y_1, y_2) \in S_1 \times S_2$, if $(a, b) * (x_1, x_2) = (a, b) * (y_1, y_2)$, then:

$$(ax_1, bx_2) = (ay_1, by_2)$$

$$ax_1 = ay_1, bx_2 = by_2$$

$$x_1 = y_1, x_2 = y_2. \text{ (since } a \text{ and } b \text{ are cancellative)}$$

$$(x_1, x_2) = (y_1, y_2).$$

hence, (a, b) is cancellative. \square

4. Separability and Quasi-Cancellability of CA-Groupoids

Definition 7. Let S be a CA-groupoid. (1) S is called to be left (right) separative, for all $x, y \in S$, if $x^2 = xy$ and $y^2 = yx$ ($x^2 = yx$ and $y^2 = xy$) imply $x = y$. (2) S is called to be separative, if it is both left and right separative. (3) S is called to be quasi-separative, if for all $x, y \in S$, $x^2 = xy = y^2$ implies $x = y$.

Example 5. Let $S = \{1, 2, 3, 4\}$. The operation $*$ on S is defined as Table 5. Then $(S, *)$ is a separative CA-groupoid.

Table 5. The operation $*$ on S .

$*$	1	2	3	4
1	4	2	1	1
2	2	2	2	2
3	1	2	3	4
4	1	2	4	4

Example 6. Let $S = \{1, 2, 3, 4\}$. The operation $*$ on S is defined as Table 6. Then $(S, *)$ is a quasi-separative CA-groupoid.

Table 6. The operation $*$ on S .

$*$	1	2	3	4
1	4	3	2	1
2	3	2	3	2
3	2	3	2	3
4	1	2	3	4

Theorem 4. Let S be a CA-groupoid. Then the following asserts are equivalent:

- (1) S is separative;
- (2) S is left separative;
- (3) S is right separative;
- (4) S is quasi-separative.

Proof. Obviously, (1) \Rightarrow (2), by Definition 7.

(2) \Rightarrow (3): Suppose that S is leftseparative. For any $x, y \in S$, if $x^2 = yx$ and $y^2 = xy$, then (by Proposition 1 (1)):

$$(xy)^2 = (xy)(xy) = (xy)y^2 = (xy)(yx) = (yx)(yx) = x^2(yy) = (xx)(yy) = (yx)(yx) = (xy)(yx);$$

$$(yx)^2 = (yx)(yx) = (xy)(yx) = (xx)(yy) = x^2y^2 = (yx)(xy).$$

Since S is left separative, by Definition 7 we have $xy = yx$. From this, using $x^2 = yx$ and $y^2 = xy$, we get that $x^2 = xy$ and $y^2 = yx$. Applying the condition that S is left separative, by Definition 7 again, we have $x = y$. This means that S is right separative.

(3) \Rightarrow (4): Suppose that S is right separative. For any $x, y \in S$, if $x^2 = xy = y^2$, then (by Proposition 1 (1)):

$$(xy)^2 = (xy)(xy) = x^2(xy) = (xx)(xy) = (yx)(xx) = (yx)x^2 = (yx)(xy);$$

$$(yx)^2 = (yx)(yx) = (xy)(yx).$$

Since S is right separative, by Definition 7 we have $xy = yx$. From this, using $x^2 = xy = y^2$, we get that $x^2 = yx$ and $y^2 = xy$. Applying the condition that S is right separative, by Definition 7 again, we have $x = y$. This means that S is quasi-separative.

(4) \Rightarrow (1) Suppose that S is quasi-separative. For any $x, y \in S$, then (by Proposition 1 (1)):

$$(xy)^2 = (xy)(xy) = (yx)(xy) = (yy)(xx) = y^2x^2;$$

$$(yx)^2 = (yx)(yx) = (xy)(yx) = (xx)(yy) = x^2y^2.$$

Moreover,

$$[(yx)(xy)]^2 = [(yx)(xy)] [(yx)(xy)] = [(yx)(xy)] [(yy)(xx)] = [(yx)(xy)] (y^2x^2) = [(yx)(xy)] (xy)^2 =$$

$$[(yx)(xy)] [(xy)(xy)] = [(xy)(yx)] [(xy)(xy)] = [(xx)(yy)] [(xy)(xy)] = (x^2y^2) [(xy)(xy)] =$$

$$(yx)^2 [(xy)(xy)] = [(yx)(yx)] [(xy)(xy)] = [(xy)(yx)] [(xy)(yx)] = [(xy)(yx)]^2.$$

If $x^2 = xy$ and $y^2 = yx$, then

$$(y^4)^2 = (y^2y^2)^2 = [(yx)(yx)]^2 = [(xy)(yx)]^2 = [(yx)(xy)]^2 = (y^2x^2)^2 = (y^2x^2)(y^2x^2) = (x^2y^2)(y^2x^2) = (x^2x^2)(y^2y^2) = x^4y^4;$$

$$(x^4)^2 = (x^2x^2)^2 = [(xy)(xy)]^2 = [(yx)(xy)]^2 = [(yy)(xx)]^2 = (y^2x^2)^2 = (y^2x^2)(y^2x^2) = (x^2y^2)(y^2x^2) = (x^2x^2)(y^2y^2) = x^4y^4.$$

From this, applying the condition that S is quasi-separative, we get that $x^4 = y^4$. Thus,

$$(xy)^2 = (x^2)^2 = x^4 = y^4 = (y^2)^2 = (yx)^2 = (yx)(yx) = (xy)(yx).$$

That is, $(xy)^2 = (xy)(yx) = (yx)^2$. Since S is quasi-separative, by Definition 7 we have $xy = yx$. From this, using $x^2 = xy$ and $y^2 = yx$, we have $x^2 = xy = y^2$. Applying the condition that S is quasi-separative, by Definition 7 again, we have $x = y$. This means that S is left separative. \square

Similarly, we can prove that S is right separative. Therefore, S is separative by Definition 7.

Proposition 6. *Let S be a CA-groupoid. If S is cancellative, then S is separative.*

Proof. Assume that S is cancellative. For any $x, y \in S$, if $x^2 = xy = y^2$, then $xx = xy$ and $xy = yy$. Using cancellability of S , we have $x = y$. This means that S is separative.

Similarly, we can prove that S is separative when S is left (or right) cancellative. \square

The following example shows that a separative CA-groupoid maybe not a left (or right) cancellative CA-groupoid.

Example 7. *Let $S = \{1, 2, 3, 4\}$. The operation $*$ on S is defined as Table 7. Then $(S, *)$ is a separative CA-groupoid, but S isn't cancellative, since $1*1 = 2*1, 1 \neq 2$.*

Table 7. The operation $*$ on S .

$*$	1	2	3	4
1	1	2	3	1
2	1	4	3	2
3	3	3	3	3
4	1	2	3	4

Definition 8. *Let S be a CA-groupoid. S is called a CA-band, if for all $a \in S, aa = a$; S is called CA-3-band, if for all $a \in S, a*aa = aa*a = a$.*

Definition 9. Let S be a CA-groupoid. S is called to be left(right) quasi-cancellative, for all $x, y \in S$, if $x = xy$ and $y^2 = yx$ ($x = yx$ and $y^2 = xy$) imply $x = y$. S is called quasi-cancellative, if it is both left and right quasi-cancellative.

Example 8. Let $S = \{1,2,3,4\}$. The operation $*$ on S is defined as Table 8. Then $(S, *)$ is a quasi-cancellative CA-groupoid.

Table 8. The operation $*$ on S .

$*$	1	2	3	4
1	1	1	1	1
2	1	2	1	1
3	1	1	3	4
4	1	1	4	3

Theorem 5. Let S be a CA-groupoid. If S is left quasi-cancellative, then S is right quasi-cancellative.

Proof. Suppose that S is left quasi-cancellative. For any $x, y \in S$, if $x = yx$ and $y^2 = xy$, then (by Proposition 1 (1)):

$$x^2 = (yx)(yx) = (xy)(yx) = (xx)(yy) = x^2y^2;$$

$$(y^2)^2 = y^2y^2 = (xy)(xy) = (yx)(xy) = (yy)(xx) = y^2x^2.$$

From this, applying the condition that S is left quasi-cancellative, we get that $x^2 = y^2$. Thus:

$$xy = y^2 = x^2 = (yx)(yx) = (xy)(yx);$$

$$(yx)^2 = (yx)(yx) = x(yx) = x(xy) = (yx)(xy).$$

From this, applying the condition that S is left quasi-cancellative and Definition 9 again, we get that $xy = yx$. Hence, using the condition that $x = yx$ and $y^2 = xy$, we have $x = xy$ and $y^2 = yx$, applying the definition of left quasi-cancellative, we get that $x = y$. Therefore, S is right quasi-cancellative. \square

Open Problem 2 (to prove or give a counterexample): Is any right quasi-cancellative CA-groupoid necessarily left quasi-cancellative?

Theorem 6. The following asserts are true:

- (1) Every CA-band is quasi-cancellative.
- (2) Every CA-3-band is quasi-cancellative.
- (3) Every quasi-separative CA-groupoid is quasi-cancellative;
- (4) Every separative (or left-, right-separative) CA-groupoid is quasi-cancellative.

Proof. (1) Let S be a CA-band. For any $x, y \in S$, if $x = xy$ and $y^2 = yx$, then (by Definition 8) $x = x^2$, $y = y^2$. It follows that:

$$x = x^2 = (xy)(xy) = (yx)(xy) = y^2(xy) = y(xy) = yx = y^2 = y.$$

This means that S is left quasi-cancellative. Applying Theorem 5, we know that S is right quasi-cancellative. Hence, S is quasi-cancellative.

(2) Let S be a CA-3-band. For any $x, y \in S$, if $x = xy$ and $y^2 = yx$, then (by Definition 8) $x = xx^2 = x^2x, y = yy^2 = y^2y$. Furthermore:

$$y^2 = yx = y(xy) = y(yx) = yy^2 = y,$$

$$x = xy = x(yy^2) = y^2(xy) = y^2x = yx = y^2 = y.$$

Thus, S is left quasi-cancellative. Applying Theorem 5, we get that S is right quasi-cancellative. Hence, S is quasi-cancellative.

(3) Let S be a quasi-separative CA-groupoid. For any $x, y \in S$, if $x = xy$ and $y^2 = yx$, then:

$$x^2 = xx = x(xy) = y(xx) = x(yx) = xy^2 = x(yy) = y(xy) = yx = y^2$$

That is, $y^2 = yx = x^2$. By Definition 7 we have $x = y$. This means that S is left quasi-cancellative. Applying Theorem 5, we get that S is right quasi-cancellative. Hence, S is quasi-cancellative.

(4) It follows from (3) and Theorem 4. \square

Example 9. Let $S = \{1,2,3,4,5\}$. The operation $*$ on S is defined as Table 9. Then $(S, *)$ is a quasi-cancellative CA-groupoid, S isn't separative, because $2*2 = 2*4 = 3, 4*4 = 4*2 = 3$, but $2 \neq 4$.

Table 9. The operation $*$ on S .

$*$	1	2	3	4	5
1	3	3	5	3	3
2	3	3	5	3	3
3	4	4	3	5	5
4	3	3	5	3	3
5	3	3	5	3	3

Definition 10. Let $(S, *)$ be a CA-groupoid. S is called to be power-cancellative, if for all $x, y \in S, x^2 = y^2$ implies $x = y$.

Example 10. Let $S = \{1,2,3,4,5\}$. The operation $*$ on S is defined as Table 10. Then $(S, *)$ is a power-cancellative CA-groupoid, S isn't cancellative, because $1*2 = 1*3$, but $2 \neq 3$.

Table 10. The operation $*$ on S .

$*$	1	2	3	4	5
1	1	1	1	4	5
2	1	2	1	4	5
3	1	1	3	4	5
4	4	4	4	5	1
5	5	5	5	1	4

Example 11. Let $S = \{1,2,3,4\}$. The operation $*$ on S is defined as Table 11. Then $(S, *)$ is a cancellative CA-groupoid, S isn't power-cancellative, because $1^2 = 2^2 = 1$, but $1 \neq 2$.

Table 11. The operation * on S.

*	1	2	3	4
1	1	2	3	4
2	2	1	4	3
3	3	4	2	1
4	4	3	1	2

Theorem 7. Let S be a CA-groupoid. If S is power-cancellative, then:

- (1) S is commutative, and S is a commutative semigroup.
- (2) S is separative.

Proof. (1) Suppose that S is power-cancellative. For any $x, y \in S$, since (by Proposition 1 (1)):

$$(xy)^2 = (xy)(xy) = (yx)(xy) = (yy)(xx) = y^2x^2;$$

$$(yx)^2 = (yx)(yx) = (xy)(yx) = (xx)(yy) = x^2y^2.$$

Moreover,

$$[(yx)(xy)]^2 = [(yx)(xy)] [(yx)(xy)] = [(yx)(xy)] [(yy)(xx)] = [(yx)(xy)] (y^2x^2) = [(yx)(xy)] (xy)^2 =$$

$$[(yx)(xy)] [(xy)(xy)] = [(xy)(yx)] [(xy)(xy)] = [(xx)(yy)] [(xy)(xy)] = (x^2y^2) [(xy)(xy)] =$$

$$(yx)^2 [(xy)(xy)] = [(yx)(yx)] [(xy)(xy)] = [(xy)(yx)] [(xy)(yx)] = [(xy)(yx)]^2$$

Applying the condition that S is power-cancellative, we get that $(yx)(xy) = (xy)(yx)$. Thus:

$$(xy)^2 = y^2x^2 = (yx)(xy) = (xy)(yx) = x^2y^2 = (yx)^2.$$

By Definition 10, we have $xy = yx$. This means that S is commutative, and S is a commutative semigroup (by Proposition 2).

(2) Assume that S is power-cancellative. For any $x, y \in S$, if $x^2 = xy = y^2$, then (by Definition 10), $x = y$. This means that S is quasi-separative. Applying Theorem 4, we know that S is separative. □

5. Variant CA-Groupoids

In this section, we focus on a special class of CA-groupoids, which are called variant CA-groupoids. The reasons why we want to discuss this kind of CA-groupoids are that: (1) it is closely related to the generalized unit element (i.e., quasi right unit element), and it is the closest to the commutative semigroup (see Example 12 and Example 13 below); (2) this kind of CA-groupoids has many interesting properties, and it can be constructed from any commutative semigroup, please refer to the following Theorem 9; (3) the research on this kind of CA-groupoids is of great significance to study some special rings and semirings. See literature [7–9] and Example 14 and Example 15 below.

Definition 11. Let $(S, *)$ be a CA-groupoid. S is called a variant CA-groupoid, if there exists $e \in S$, such that for all $x \in S - \{e\}$, $xe = x$ and $e^2 \neq e$. Where, e is called a quasi-right unit element of S.

Example 12. Let $S = \{1, 2, 3, 4, 5\}$, The operation * on S is defined as Table 12, then $(S, *)$ is a variant CA-groupoid and 1 is a quasi-right unit element in S. Obviously, S isn't commutative.

Table 12. The operation * on S.

*	1	2	3	4	5
1	3	3	3	4	4
2	2	3	3	4	4
3	3	3	3	4	4
4	4	4	4	4	4
5	5	4	4	4	4

Looking at the above example carefully, we find that: (1) the element 1 as a quasi-right unit element of S, does not appear in the operation table; (2) in the operation table, the first row is the same as the third row; (3) if we change the first row of the operation table to {1, 2, 3, 4, 5}, we will get a commutative semigroup (S, +) (as shown in Table 13). These are all interesting phenomena. Later, we will analyze the characteristics of variant CA-groupoids.

Table 13. A Commutative semigroup (S, +) corresponding to (S, *).

+	1	2	3	4	5
1	1	2	3	4	5
2	2	3	3	4	4
3	3	3	3	4	4
4	4	4	4	4	4
5	5	4	4	4	4

Example 13. Let $S = \{1, 2, 3, 4, 5\}$, The operation * on S is defined as Table 14, then (S, *) is a variant CA-groupoid and 5 is a quasi-right unit element in S. Obviously, S is commutative.

Table 14. The operation * on S.

*	1	2	3	4	5
1	1	1	1	1	1
2	1	4	2	3	2
3	1	2	3	4	3
4	1	3	4	2	4
5	1	2	3	4	3

If we change the last row of the operation table to {1, 2, 3, 4, 5}, we will get a commutative semigroup (S, +) (as shown in Table 15).

Table 15. A Commutative semigroup (S, +) corresponding to (S, *).

+	1	2	3	4	5
1	1	1	1	1	1
2	1	4	2	3	2
3	1	2	3	4	3
4	1	3	4	2	4
5	1	2	3	4	5

Example 14. Let:

$$S = \left\{ \begin{pmatrix} a & 0 \\ 0 & 0 \end{pmatrix} : a \text{ is a integral number} \right\} \cup \left\{ \begin{pmatrix} 1 & 0 \\ 0 & 1 \end{pmatrix}, \begin{pmatrix} 1 & 0 \\ 0 & -1 \end{pmatrix} \right\}.$$

Define the operation $*$ on S is the common matrix multiplication, then $(S, *)$ is a variant CA-groupoid and $\begin{pmatrix} 1 & 0 \\ 0 & -1 \end{pmatrix}$ is a quasi-right unit element in S . Moreover, we define the addition operation $+$ on S as following:

for any $x, y \in S$, denote $S_1 = \left\{ \begin{pmatrix} a & 0 \\ 0 & 0 \end{pmatrix} : a \text{ is a integral number} \right\}$, $S_2 = \left\{ \begin{pmatrix} 1 & 0 \\ 0 & 1 \end{pmatrix}, \begin{pmatrix} 1 & 0 \\ 0 & -1 \end{pmatrix} \right\}$,

- (1) if $x, y \in S_1$, $x + y$ is common matrix addition;
- (2) if $x \in S_1$ and $y \in S_2$, $x + y = \begin{pmatrix} a+1 & 0 \\ 0 & 0 \end{pmatrix}$, where $y = \begin{pmatrix} a & 0 \\ 0 & 0 \end{pmatrix}$;
- (3) if $x \in S_2$ and $y \in S_1$, $x + y = y + x$ (see (2));
- (4) if $x = y \in S_2$, $x + y = \begin{pmatrix} 0 & 0 \\ 0 & 0 \end{pmatrix}$;
- (5) if $x, y \in S_2$ and $x \neq y$, $x + y = \begin{pmatrix} 2 & 0 \\ 0 & 0 \end{pmatrix}$.

Then $(S, +)$ is a commutative group, and $(S; +, *)$ is a ring, that is, $(x + y)*z = x*z + y*z$ and $z*(x + y) = z*x + z*y$, for any $x, y, z \in S$.

Example 15. Let $S = \{1, 2, 3, 4, 5, 6\}$, The operation $*$ on S is defined as Table 16, then $(S, *)$ is a variant CA-groupoid and 1 is a quasi-right unit element in S . Obviously, S is not commutative.

Table 16. The operation $*$ on S .

*	1	2	3	4	5	6
1	3	3	3	4	4	6
2	2	3	3	4	4	6
3	3	3	3	4	4	6
4	4	4	4	4	4	6
5	5	4	4	4	4	6
6	6	6	6	6	6	6

Moreover, we define the addition operation $+$ on S as Table 17 or Table 18, then $(S, +)$ is a commutative semigroup with unite 6. We can verify that $(x + y)*z = x*z + y*z$ for any x, y, z in S , so $(S; +, *)$ is a semiring (for the theory of semirings, please see the monograph [33–35]).

Table 17. A Commutative monoid $(S, +)$.

+	1	2	3	4	5	6
1	1	1	1	1	1	1
2	1	2	3	3	3	2
3	1	3	3	3	3	3
4	1	3	3	4	5	4
5	1	4	3	5	5	5
6	1	2	3	4	5	6

Table 18. Another Commutative monoid (S, +).

+	1	2	3	4	5	6
1	1	2	1	4	5	1
2	2	2	2	4	5	2
3	1	2	3	4	5	3
4	4	4	4	4	5	4
5	5	5	5	5	4	5
6	1	2	3	4	5	6

Theorem 8. Let S be a variant CA-groupoid:

- (1) If e is a quasi-right unit element of S and ee = a, a ∈ S, then ex = ax for all x ∈ S.
- (2) The quasi-right unite element is unique in S.

Proof. (1) Let e be a quasi-right unit element of S and ee = a, a ∈ S. By Definition 11, we know that a ≠ e. For any x ∈ S, if x = e, then ex = ee = a = ae = ax; if x ≠ e, then (by Definition 11):

$$\begin{aligned}
 ex &= e^*xe = e^*ex = x^*ee = xa = xe^*ae = e^*(xe^*a) = a^*(e^*xe) = a^*(e^*ex) = a^*(x^*ee) = a^*xa = a^*ax \\
 &= x^*aa = x^*(a^*ee) = x^*(e^*ae) = ae^*xe = ax.
 \end{aligned}$$

hence, ex = ax for all x ∈ S.

(2) Suppose that s and t are quasi-right unit elements of S, s ≠ t. From Definition 11 we know that ss ≠ s and tt ≠ t. Since:

$$s = st = st^*ts = s^*(st^*t) = t^*(s^*st) = t^*(t^*ss) = t^*(s^*ts) = t^*st = ts = t.$$

This means that the quasi-right unit element is unique in S. □

Obviously, let S = {a} and (S, *) is a CA-groupoid, then S isn't a variant CA-groupoid. Let S = {a, b} and (S, *) is a variant CA-groupoid, denote the quasi-right unit element e = a (or b), then for any x, y ∈ S, we have xy = b (or a).

Through the study of the variant CA-groupoid, we give the following construction method, that is to say, on the basis of a commutative semigroup, a variant CA-groupoid is formed by adding an element which does not intersect with it, and a variant CA-groupoid can also be decomposed to obtain a commutative semigroup and an independent element.

Theorem 9. The following asserts are true:

- (1) Let S be a variant CA-groupoid and e is the quasi-right unite element on S, then S₁ = S - {e} is a commutative semigroup.
- (2) Let S be a commutative monoid with unit element e and a is an element such that {a} ∩ S = ∅, then S₂ = S ∪ {a} is a variant CA-groupoid if define xa = x, ax = ex, aa = e, for all x ∈ S.

Proof. (1) Suppose that S is a variant CA-groupoid and e is the quasi-right unit element of S, if ∃x, y ∈ S₁ = S - {e} such that xy = e, then for all a ∈ S - {e}, a^*xy = ae = a, so we have:

$$ee = e^*xy = y^*ex = x^*ye = xy = e.$$

This conclusion contradicts Definition 11. Hence, for all $x, y \in S - \{e\}$, $xy \neq e$, in other words, $S - \{e\}$ is closed, that is, $S - \{e\}$ is a sub CA-groupoid of S . Moreover, for all $x, y \in S_1 = S - \{e\}$, applying Theorem 8 (1), $ex = (ee)x$, and:

$$xy = x^*ye = e^*xy = y^*ex = y^*(ee^*x) = x^*(y^*ee) = x^*(e^*ye) = ye^*xe = yx$$

hence $S - \{e\}$ is commutative, then $S - \{e\}$ is a commutative semigroup (by Proposition 2).

(2) On the other hand, suppose that S is commutative monoid with unit element e . Let a be an element such that $\{a\} \cap S = \emptyset$, denote $S_2 = S \cup \{a\}$. Define a new binary operation \bullet on S_2 :

for any $x, y \in S_2$, if $x, y \in S$, then $x \bullet y = x^*y$; if $x \in S$, then $x \bullet a = x, a \bullet x = e \bullet x, a \bullet a = e$.

Obviously, (S_2, \bullet) is a groupoid. For all $x, y, z \in S$, by the definition of operation \bullet we have:

$$\begin{aligned} x \bullet yz &= x^*yz = z^*xy = z \bullet xy, \\ a \bullet aa &= a \bullet aa, \\ x \bullet aa &= xe = ex = ax = a \bullet xa, \\ a \bullet xa &= ax = bx = xe = x \bullet ee = e \bullet ex = a \bullet ax, \\ a \bullet ax &= e \bullet ex = e \bullet xe = xe \bullet e = x \bullet ee = xe = x \bullet aa, \\ y \bullet ax &= ax \bullet y = ex \bullet y = xy = x \bullet ya, \\ x \bullet ya &= xy = e \bullet xy = a \bullet xy, \\ a \bullet xy &= (a \bullet xa) \bullet ya = ya \bullet (a \bullet xa) = y \bullet ax. \end{aligned}$$

thus, (S_2, \bullet) is a variant CA-groupoid with the quasi-right unit element a . \square

Applying Definition 11 and Definition 9 we can easy to verify that the following proposition is true.

Proposition 7. (1) If S is a variant CA-groupoid, then S isn't cancellative. (2) If S is a cancellative CA-groupoid, then S isn't a variant CA-groupoid.

From Theorem 9, Proposition 7, Examples 12-15, we have Figure 1.

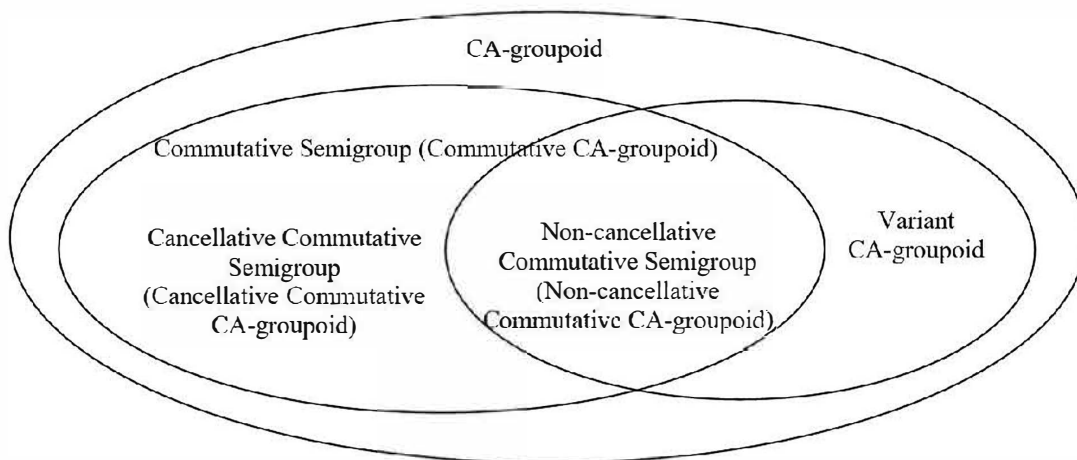

Figure 1. The relationships among some CA-groupoids.

Theorem 10. Let S be a variant CA-groupoid and e be a quasi-right unit element of S . Denote $a = ee, b = aa$. Then the following asserts are true:

- (1) If $b = a$, then $\{e, a\}$ is a variant sub CA-groupoid of S ;
- (2) If $b \neq a$, then $\{e, a, b\}$ is a variant sub CA-groupoid of S .

Proof. (1) Suppose $b = a$. For the set $\{e, a\}$, since (by Theorem 8):

$$ee = a, aa = b = a, ae = a, ea = ee^*a = aa = a.$$

It follows that $\{e, a\}$ is closed on the operation $*$. Thus, $\{e, a\}$ is a variant sub CA-groupoid with quasi-right unit element e .

(2) Assume $b \neq a$. By Theorem 9 (1), for all $x, y \in S - \{e\}, xy = yx$. For the set $\{e, a, b\}$, since (by Theorem 8):

$$ee = a, aa = b, ae = a, ea = ee^*a = aa = b;$$

$$eb = e^*aa = a^*ea = a^*ae = aa = b, be = b;$$

$$ba = ab = ee^*aa = a^*(ee^*a) = a^*(a^*ee) = a^*(e^*ae) = ae^*ae = aa = b.$$

Thus, $\{e, a, b\}$ is closed about $*$, so $\{e, a, b\}$ is a variant sub CA-groupoid of S . \square

Theorem 11. Let $(S_1, *_1)$ and $(S_2, *_2)$ be two variant CA-groupoids, e_1 and e_2 are quasi-right unit elements of $(S_1, *_1)$ and $(S_2, *_2), S_1 \cap S_2 = \{e\} (e = e_1 = e_2)$. Denote $S = S_1 \cup S_2$, and define the operation $*$ on S as follows:

- (i) if $a, b \in S_1$, then $a*b = a*_1b$;
- (ii) if $a, b \in S_2$, then $a*b = a*_2b$;
- (iii) if $a \in S_1 - \{e\}, b \in S_2 - \{e\}$, then $a*b = b$;
- (iv) if $a \in S_2 - \{e\}, b \in S_1 - \{e\}$, then $a*b = a$.

Then $(S, *)$ is a variant CA-groupoid with the quasi-right unite e .

Proof. It is only necessary to prove that the cyclic associative law hold in $(S, *)$, that is, $a^*(b^*c) = c^*(a^*b)$ for all $a, b, c \in S$. We will discuss the following situations separately:

- (1) If $a, b, c \in S_1$, or $a, b, c \in S_2$, then $a^*(b^*c) = c^*(a^*b)$;
- (2) If $a \in S_1 - \{e\}, b \in S_2 - \{e\}$ and $c \in S_2 - \{e\}$, then $a^*(b^*c) = b^*c = c^*b = c^*(a^*b)$;
- (3) If $a \in S_2 - \{e\}, b \in S_1 - \{e\}$ and $c \in S_2 - \{e\}$, then $a^*(b^*c) = a^*c = c^*a = c^*(a^*b)$;
- (4) If $a \in S_2 - \{e\}, b \in S_2 - \{e\}$ and $c \in S_1 - \{e\}$, then $a^*(b^*c) = a^*b = c^*(a^*b)$;
- (5) If $a \in S_1 - \{e\}, b \in S_1 - \{e\}$ and $c \in S_2 - \{e\}$, then $a^*(b^*c) = a^*c = c = c^*(a^*b)$;
- (6) If $a \in S_1 - \{e\}, b \in S_2 - \{e\}$ and $c \in S_1 - \{e\}$, then $a^*(b^*c) = a^*b = c^*(a^*b)$;
- (7) If $a \in S_2 - \{e\}, b \in S_1 - \{e\}$ and $c \in S_1 - \{e\}$, then $a^*(b^*c) = a = a^*b = c^*(a^*b)$.

Then $(S, *)$ is a variant CA-groupoid and e is the quasi-right unit element. \square

Example 16. Let $S_1 = \{1, 2, 3, 4\}$ and $S_2 = \{1, 5, 6, 7\}$. Define operations $*_1$ and $*_2$ on S_1, S_2 as following Tables 19 and 21. Then $S = S_1 \cup S_2 = \{1, 2, 3, 4, 5, 6\}$, and $(S, *)$ is a variant CA-groupoid with the operation $*$ in Table 20.

Table 19. The operation $*_1$ on S_1 .

$*_1$	1	2	3	4
1	2	2	4	4
2	2	2	4	4
3	3	4	4	4
4	4	4	4	4

Table 20. The operation * on S.

*	1	2	3	4	5	6	7
1	2	2	4	4	5	6	7
2	2	2	4	4	5	6	7
3	3	4	4	4	5	6	7
4	4	4	4	4	5	6	7
5	5	5	5	5	5	7	7
6	6	6	6	6	7	5	5
7	7	7	7	7	7	5	5

Table 21. The operation *₂ on S₂.

* ₂	1	5	6	7
1	5	5	7	7
5	5	5	7	7
6	6	7	5	5
7	7	7	5	5

Similar to Theorem 11, we can get another constructor method as following proposition (the proof is omitted).

Proposition 8. Let $(S_1, *_1)$ and $(S_2, *_2)$ be two variant CA-groupoids, e_1 and e_2 are variant unit elements of $(S_1, *_1)$ and $(S_2, *_2)$, $S_1 \cap S_2 = \emptyset$ and S_2 is commutative. Denote $S = S_1 \cup S_2$, and define the operation * in S as follows:

- (1) if $a, b \in S_1$, then $a*b = a*_1b$;
- (2) if $a, b \in S_2$, then $a*b = a*_2b$;
- (3) if $a \in S_1, b \in S_2$, then $a*b = b$;
- (4) if $a \in S_2, b \in S_1$, then $a*b = a$.

Then $(S, *)$ is a variant CA-groupoid with the quasi-right unite e_1 .

Example 17. Let $S_1 = \{1, 2, 3, 4\}$ and $S_2 = \{5, 6, 7, 8\}$. Define operations $*_1$ and $*_2$ on S_1, S_2 as following Tables 22 and 24. Then $S = S_1 \cup S_2 = \{1, 2, 3, 4, 5, 6, 7, 8\}$, and $(S, *)$ is a variant CA-groupoid with the operation * in Table 23.

Table 22. The operation *₁ on S₁.

* ₁	1	2	3	4
1	3	2	2	4
2	2	2	2	4
3	3	2	2	4
4	4	4	4	4

Table 23. The operation * on S.

*	1	2	3	4	5	6	7	8
1	3	2	2	4	5	6	7	8
2	2	2	2	4	5	6	7	8
3	3	2	2	4	5	6	7	8
4	4	4	4	2	5	6	7	8
5	5	5	5	5	8	6	7	8
6	6	6	6	6	6	6	6	6
7	7	7	7	7	7	6	6	7
8	8	8	8	8	8	6	7	8

Table 24. The operation *₂ on S₂.

* ₂	5	6	7	8
5	8	6	7	8
6	6	6	6	6
7	7	6	6	7
8	8	6	7	8

Theorem 12. Let S₁ be a variant CA-groupoid with order n (n ≥ 2 and n is an even number) and the quasi-right unit element e₁ ∈ S₁, let S₂ be a variant CA-groupoid with order 2 and the quasi-right unit element e₂ ∈ S₂. If S = S₁ ∪ S₂ and S₁ ∩ S₂ = ∅, then S is a variant CA-groupoid, when it such that any of the following conditions:

- (1) for the variant CA-groupoid S, the quasi-right unit element e = e₁, and e₂*e₁ = e₂, and for all x ∈ S, x*(e₂*e₂) = (e₂*e₂)*x = e₂*e₂, x*e₂ = e₂*e₂, e₂*x = e₂*e₂ (x ≠ e₁);
- (2) for the variant CA-groupoid S, the quasi-right unit element e = e₁ and for all x ∈ S, x*(e₂*e₂) = (e₂*e₂)*x = e₂*e₂, x*e₂ = e₂*x = e₂.

Proof. (1) Suppose that S is constructed according to the method described in (1), then for all x, y, z ∈ S₁, x*yz = z*xy = y*zx, and:

$$\begin{aligned}
 x*y e_2 &= x * e_2 e_2 = e_2 e_2, e_2 * x y = e_2 e_2 \quad (x y \neq e_1) \\
 y * e_2 x &= \begin{cases} y * e_2 e_1 = y e_2 = e_2 e_2 & x = e_1 \\ y * e_2 e_2 = e_2 e_2 & x \neq e_1 \end{cases}
 \end{aligned}$$

That is, x*y e₂ = e₂*xy = y*e₂x. Denote e₂ e₂ = b, then:

$$x*y b = x b = b, b * x y = b, y * b x = y b = b. \text{ That is, } x*y b = b * x y = y * b x.$$

$$\begin{aligned}
 x * e_2 e_2 &= x b = b, e_2 * x e_2 = e_2 * e_2 e_2 = b, \\
 e_2 * e_2 x &= \begin{cases} e_2 * e_2 e_1 = e_2 e_2 = b & x = e_1 \\ e_2 * e_2 e_2 = b & x \neq e_1 \end{cases}
 \end{aligned}$$

Thus, x*e₂e₂ = e₂*xe₂ = e₂*e₂x. And:

$$\begin{aligned}
 x * b e_2 &= x * e_2 b = x b = b, b * x e_2 = b * e_2 e_2 = b = e_2 b = e_2 * b x, e_2 * x b = e_2 b = b, \\
 b * e_2 x &= \begin{cases} b * e_2 e_1 = b e_2 = b & x = e_1 \\ b * e_2 e_2 = b & x \neq e_1 \end{cases}
 \end{aligned}$$

It follows that x*b e₂ = e₂*xb = b*e₂x, and x*e₂b = b*x e₂ = e₂*bx. Obviously, x*bb = b*x b = b*bx. Hence, S is a variant CA-groupoid.

(2) Suppose that S is constructed according to the method described in (2), then for all $x, y, z \in S_1$, $x^*yz = z^*xy = y^*zx$, and:

$$x^*ye_2 = xe_2 = e_2, e_2^*xy = e_2, y^*e_2x = ye_2 = e_2.$$

Then $x^*ye_2 = e_2^*xy = y^*e_2x$. Assume $e_2e_2 = b$, then:

$$x^*yb = xb = b, b^*xy = b, y^*bx = yb = b.$$

That is, $x^*yb = b^*xy = y^*bx$. And:

$$x^*e_2e_2 = xb = b, e_2^*xe_2 = e_2^*e_2x = e_2e_2 = b.$$

Thus, $x^*e_2e_2 = e_2^*xe_2 = e_2^*e_2x$. Moreover:

$$x^*be_2 = x^*e_2b = xb = b, b^*xe_2 = be_2 = b = e_2b = e_2^*bx, e_2^*xb = e_2b = b = be_2 = b^*e_2x.$$

It follows that $x^*be_2 = e_2^*xb = b^*e_2x$, and $x^*e_2b = b^*xe_2 = e_2^*bx$. Obviously, $x^*bb = b^*xb = b^*bx$. Hence, S is a variant CA-groupoid. \square

6. Conclusions

In the paper, we mainly study various cancellabilities of CA-groupoids and the structural properties of a special kind of CA-groupoids (variant CA-groupoids). Firstly, we investigate some cancellabilities of CA-groupoids, including left (right) cancellation, weak cancellation, left (right) quasi-cancellation and left (right) separation, and analyze the relationships among them. Secondly, from the view of quasi-right unit element, we introduce the new notion of variant CA-groupoid, illustrate the close connections among variant CA-groupoid with commutative semigroup, ring and semiring by some examples; discuss deeply the characteristics of variant CA-groupoid, and establish its structure theorem and construction methods. This paper obtains many conclusions, some important results as follows:

- (1) Every left cancellative element in CA-groupoid is right cancellative (see Theorem 1);
- (2) For a CA-groupoid, it is left cancellative if and only if it is right cancellative (see Theorem 1 and Corollary 1);
- (3) For a CA-groupoid, it is left separative if and only if it is right separative, and if and only if it is quasi-separative (see Theorem 4 and Corollary 1);
- (4) Every left quasi-cancellative CA-groupoid is right quasi-cancellative (see Theorem 5); every power cancellative CA-groupoid is separative (see Theorem 7);
- (5) For a variant CA-groupoid, its quasi-right unit element is unique;
- (6) A variant CA-groupoid can be decomposed into the quasi-right unit element and a commutative CA-groupoid; starting from any commutative semigroup, one can construct a variant CA-groupoid (see Theorem 9);
- (7) There are many ways to construct a new variant CA-groupoid from the existing variant CA-groupoids (see Theorems 11 and 12).

As a direction of future research, we will discuss the structural characteristics of CA-rings, CA-semirings and related algebraic systems (see [36–39]).

Funding: This research was funded by National Natural Science Foundation of China (Grant No. 61976130).

References

1. Zhang, X.H.; Ma, Z.R.; Yuan, W.T. Cyclic associative groupoids (CA-groupoids) and cyclic associative neutrosophic extended triplet groupoids (CA-NET-groupoids). *Neutrosophic Sets Syst.* **2019**, *29*, 19–29.
2. Yuan, W.T.; Zhang, X.H. Regular CA-groupoids and cyclic associative neutrosophic extended triplet groupoids (CA-NET-groupoids) with green relations. *Mathematics* **2020**, *8*, 204. [[CrossRef](#)]
3. Byrne, L. Two brief formulations of Boolean algebra. *Bull. Am. Math. Soc.* **1946**, *52*, 269–272. [[CrossRef](#)]
4. Sholander, M. Medians, lattices, and trees. *Proc. Am. Math. Soc.* **1954**, *5*, 808–812. [[CrossRef](#)]
5. Hosszu, M. Some functional equations related with the associative law. *Publ. Math. Debrecen.* **1954**, *3*, 205–214.
6. Maksa, G. CM solutions of some functional equations of associative type. *Ann. Univ. Sci. Bp. Sect. Comput.* **2004**, *24*, 125–132.
7. Kleinfeld, M. Rings with $x(yz)=y(zx)$. *Commut. Algebra* **1995**, *23*, 5085–5093. [[CrossRef](#)]
8. Behn, A.; Correa, I.; Hentzel, I.R. Semiprimality and nilpotency of nonassociative rings satisfying $x(yz) = y(zx)$. *Commun. Algebra* **2008**, *36*, 132–141. [[CrossRef](#)]
9. Behn, A.; Correa, I.; Hentzel, I.R. On flexible algebras satisfying $x(yz) = y(zx)$. *Algebra Colloq.* **2010**, *17*, 881–886. [[CrossRef](#)]
10. Iqbal, M.; Ahmad, I.; Shah, M.; Ali, M.I. On cyclic associative Abel-Grassman groupoids. *Br. J. Math. Comput. Sci.* **2016**, *12*, 1–16. [[CrossRef](#)]
11. Tamura, T. Commutative nonpotent archimedean semigroup with cancellation law I. *J. Gakugei Tokushima Univ.* **1957**, *8*, 5–11.
12. Burmistrovich, I.E. Commutative bands of cancellative semigroups. *Sib. Mat. Zh.* **1965**, *6*, 284–299.
13. Grillet, P.A. Cancellative commutative semigroups. *Semigroup Forum.* **1970**, *1*, 249–253. [[CrossRef](#)]
14. Neumann, B.H. Some remarks on cancellative semigroups. *Math. Z.* **1970**, *117*, 97–111. [[CrossRef](#)]
15. Goodearl, K.R. Power-cancellation of groups and modules. *Pac. J. Math.* **1976**, *64*, 387–411. [[CrossRef](#)]
16. Cherubini, A.; Varisco, A. Power cancellative semigroups. *Semigroup Forum.* **1979**, *18*, 381–384.
17. Lezzi, D. The Para-cancellation law in commutative semigroups. *Acta Math. Acad. Sci. Hung. Tomus.* **1980**, *36*, 65–69.
18. Krasilnikova, Y.I.; Novikov, B.V. On quasi-separative semigroups. *Semigroup Forum* **2005**, *70*, 347–355. [[CrossRef](#)]
19. Cegarra, A.M.; Petrich, M. The rank of a commutative cancellative semigroup. *Acta Math. Hungar.* **2005**, *107*, 71–75.
20. Cegarra, A.M.; Petrich, M. Commutative cancellative semigroups of low rank. *Results Math.* **2009**, *54*, 41–52. [[CrossRef](#)]
21. Shah, M.; Ali, A. Some structure properties of AG-groups. *Int. Math. Forum.* **2011**, *6*, 1661–1667.
22. Ali, A.; Shah, M.; Ahmad, I. On quasi-cancellativity of AG-groupoids. *Int. J. Contemp. Math. Sci.* **2012**, *7*, 2065–2070.
23. Shah, M.; Shah, T.; Ali, A. On the cancellativity of AG-groupoids. *Int. Math. Forum.* **2011**, *6*, 2187–2194.
24. Petrich, M. Malcev products of weakly cancellative monoids and varieties of bands. *Semigroup Forum.* **2015**, *90*, 339–373. [[CrossRef](#)]
25. Zhang, X.H.; Smarandache, F.; Liang, X.L. Neutrosophic duplet semigroup and cancellable neutrosophic triplet groups. *Symmetry* **2017**, *9*, 275. [[CrossRef](#)]
26. Zhang, X.H.; Ma, Y.C.; Yu, P. On two conjectures of Abel Grassmann's groupoids. *Symmetry* **2019**, *11*, 816. [[CrossRef](#)]
27. Steinberg, B. *Representation Theory of Finite Monoids*; Springer: Berlin/Heidelberg, Germany, 2016.
28. Protic, P. Some remarks on Abel-Grassmann's groups. *Quasigroups Relat. Syst.* **2012**, *20*, 267–274.
29. Shah, M. A Theoretical and Computational Investigation of AG-groups. Ph.D Thesis, Quaidi-Azam University Islamabad, Islamabad, Pakistan, 2012.
30. Stanovsky, D. Linear representation of Abel-Grassmann groups. *Carpathian J. Math.* **2017**, *33*, 257–263.
31. Zhang, X.H.; Wu, X.Y. Involution Abel-Grassmann's groups and filter theory of Abel-Grassmann's groups. *Symmetry* **2019**, *11*, 553. [[CrossRef](#)]
32. Zhang, X.H.; Wu, X.Y.; Mao, X.Y. On neutrosophic extended triplet groups (loops) and Abel-Grassmann's groupoids (AG-groupoids). *J. Intell. Fuzzy Syst.* **2019**, *37*, 5743–5753. [[CrossRef](#)]

33. Golan, J.S. *Semirings and Their Applications*; Springer: Dordrecht, The Netherlands, 1999.
34. Gondran, M.; Minoux, M. Dioïds and semirings: Links to fuzzy sets and other applications. *Fuzzy Sets Syst.* **2007**, *158*, 1273–1294. [[CrossRef](#)]
35. Zumbragel, J. Classification of finite congruence-simple semirings with zero. *J. Algebra Appl.* **2008**, *7*, 363–377. [[CrossRef](#)]
36. Zhang, X.H.; Borzooei, R.A.; Jun, Y.B. Q-filters of quantum B-algebras and basic implication algebras. *Symmetry* **2018**, *10*, 573. [[CrossRef](#)]
37. Zhang, X.H.; Hu, Q.Q.; Smarandache, F.; An, X.G. On neutrosophic triplet groups: Basic properties, NT-subgroups, and some notes. *Symmetry* **2018**, *10*, 289. [[CrossRef](#)]
38. Wu, X.Y.; Zhang, X.H. The decomposition theorems of AG-neutrosophic extended triplet loops and strong AG-(1, 1)-loops. *Mathematics* **2019**, *7*, 268. [[CrossRef](#)]
39. Zhang, X.H.; Wang, X.J.; Smarandache, F.; Jaiyeola, T.G.; Lian, T.Y. Singular neutrosophic extended triplet groups and generalized groups. *Cogn. Syst. Res.* **2019**, *57*, 32–40. [[CrossRef](#)]

Two Properties of The Special Octagon

Ion Pătrașcu, Mario Dalcín, Florentin Smarandache

Ion Pătrașcu, Mario Dalcín, Florentin Smarandache (2021). Two Properties of The Special Octagon. *Gazeta Matematică B*(CXXVI), 377-383

This article is based on the article "From Newton's Theorem to a Theorem of Inscriptible Octagon" in [2, pp. 96-99]. On this occasion we announce that Theorem 3 regarding the circumscribable octagon stated there is false.

In this article we will introduce the notions of *special octagon* and *quasi-center of a special octagon* and we will state and prove two properties related to these notions.

Definition 1. We call a *special octagon* a circumscribed octagon whose property as the four lines determined by the points of contact with the circle of the opposite sides are concurrent. The point of competition of these lines we will call the *quasi-center of the special octagon*.

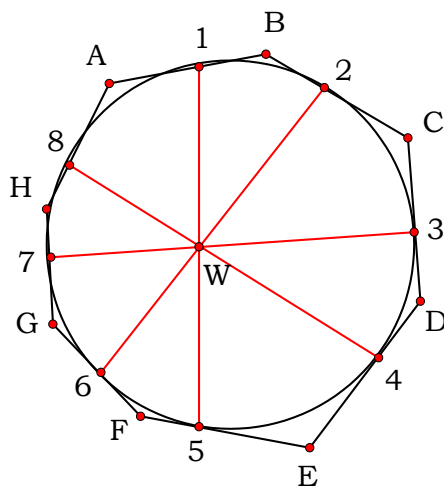

Figure 1

In Figure 1, the octagon ABCDEFGH is special. I marked with 1, 2, 3, 4, 5, 6, 7, 8 the points of tangency with the circle of the sides AB, BC, CD, DE, EF, FG, GH, HA. Lines 15, 26, 37 and 48 are concurrent in the note point W - quasi-center of the special octagon.

Property 1. In a special octagon, the diagonals determined by the opposite vertices of the octagon are concurrent in its quasi-center.

To demonstrate this property we will use two lemmas.

Lemma 1. (Theorem I. Newton). *In a circumscribed convex quadrilateral, the diagonals and lines determined by the points of tangent to the circle of the opposite sides are four competing lines.*

Demonstration. Let A_1, B_1, C_1, D_1 be the tangent points of the sides with the circle (see figure 2). On the extensions of the sides AB, BC, CD, DA of the circumscribed quadrilateral $ABCD$ we construct respectively the points $M, N; P, Q; R, S; U, V$ such that: $A_1M \parallel A_1N \parallel B_1P \parallel B_1Q \parallel C_1R \parallel C_1S \parallel D_1U \parallel D_1V$.

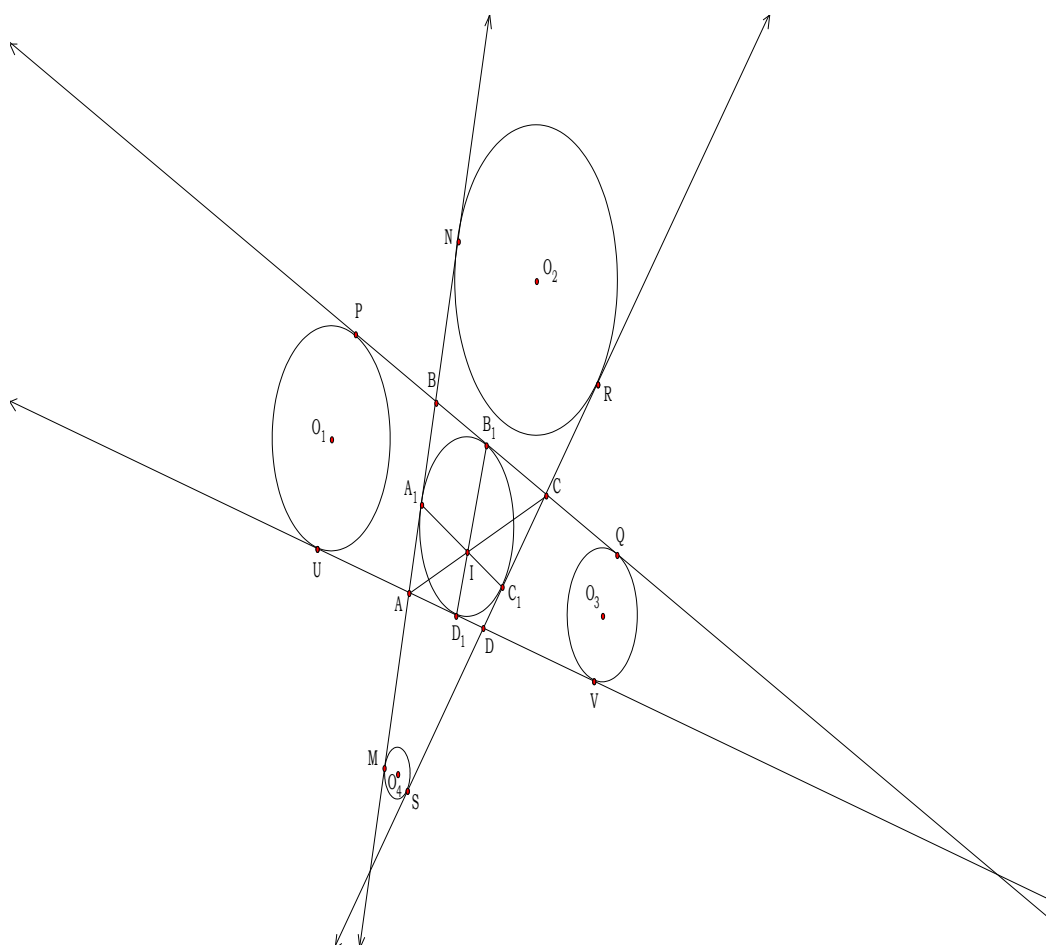

Figure 2

We denote by O_1, O_2, O_3, O_4 the centers of the tangent circles respectively in P and U of the lines BC and AD , in N and R of the lines AB and CD , in Q and V of the lines BC and AD and in M and S of the lines AB and CD .

From: $A_1M = A_1N = C_1R = C_1S$ it follows that A_1C_1 is the radical axis for the circles (O_2) and (O_4) . (1)

The relations $B_1P = B_1Q = D_1U = D_1V$ lead to the conclusion that

B_1D_1 is the radical axis of the circles (O_3) and (O_1) . (2)

Noting $\{I\} = A_1C_1 = B_1D_1$ from relations (1) and (2) we deduce that:

I has equal powers over circles (O_1) , (O_2) , (O_3) and (O_4) . (3)

Since $BA_1 = BB_1$ (tangents taken from point B to the circle) and $B_1P = A_1N$ we obtain that $BP = BN$. (4)

Also from $D_1U = C_1R$ and $DD_1 = DC_1$ it results that $DU = DR$. (5)

Relationships (4) and (5) show that BD is the radical axis of the circles (O_1) , (O_2) . (6)

From relations (3) and (6) we retain that $I \in (BD)$ (7). Analogously it is shown that $I \in (AC)$ and consequently $\{I\} = A_1C_1 = B_1D_1 = AC = BD$. (8)

Lemma . *In a circumscribed concave quadrilateral the diagonals and lines determined by the points of tangent to the circle of the opposite sides are four competing lines.*

The demonstration of this lemma being very similar to that of lemma 1, we do not reproduce it here. The reader can make this demonstration using possibly figure 3. We mention that a circumscribable concave quadrilateral has two adjacent sides tangent to the circle and the extensions of the other two sides are tangent to the circle.

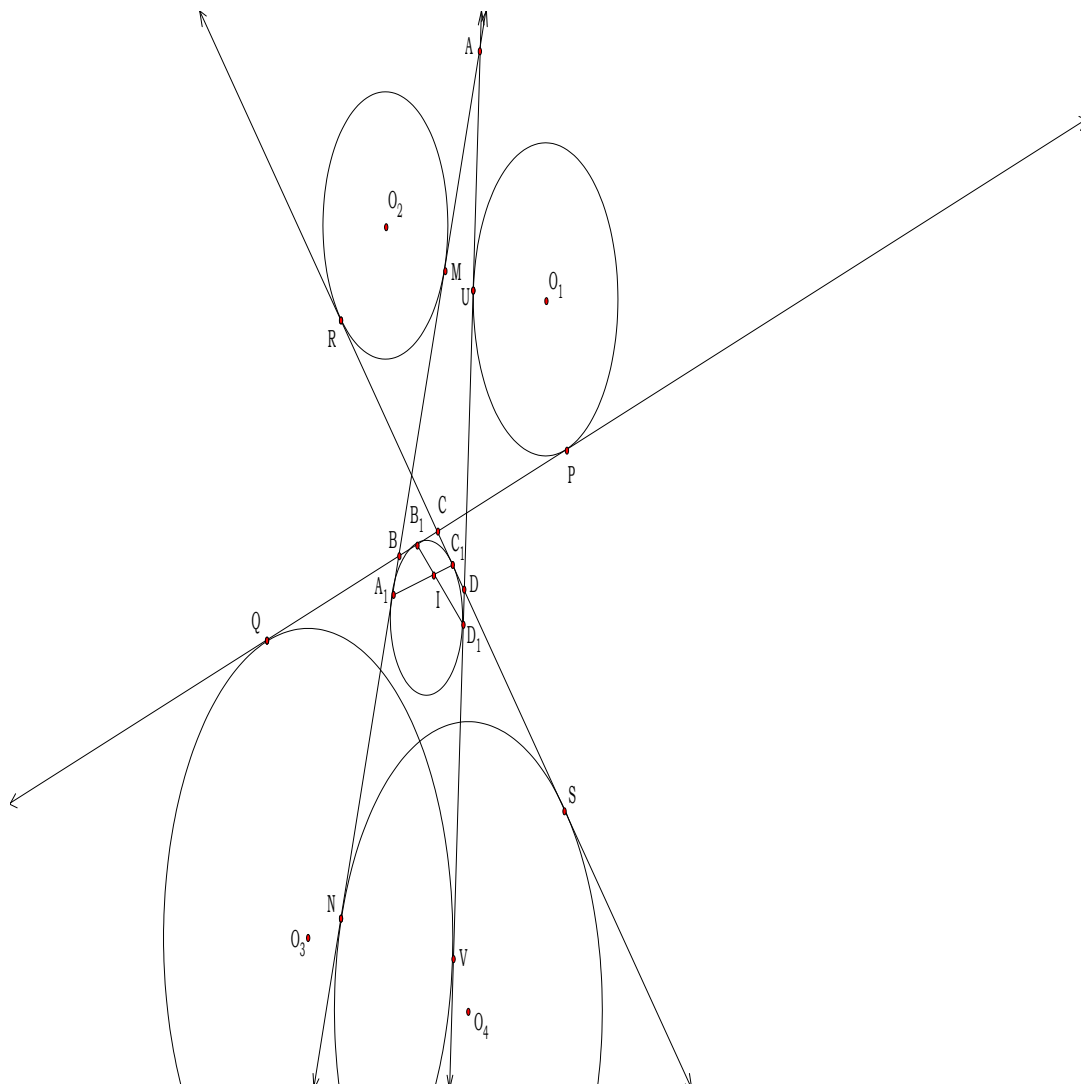

Figure 3

Proof of Ownership 1.

Note $\{X\} = BA \cap FG$ and $\{Y\} = BC \cap FE$ (see figure 4). In the circumscribed convex quadrilateral $BXFY$ applying Lemma 1 we have as: $15 \quad 26 \quad BF \cap XY = \{W\}$. Remember that $W \in BF$. (9)

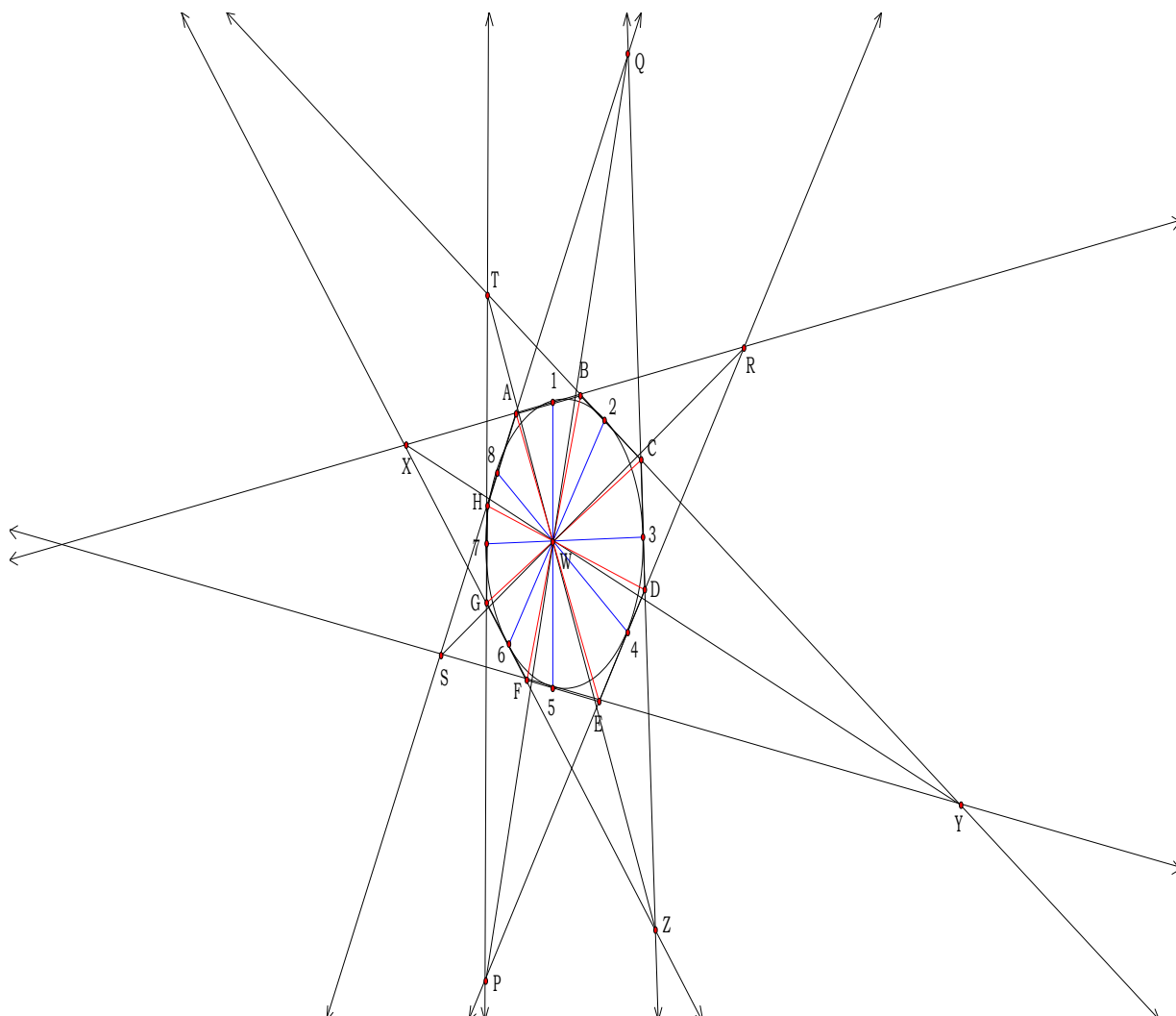

Figure 4

We denote $\{Z\} = CD \cap FG$ and $\{T\} = CB \cap GH$, we apply the lemma in the circumscribed convex quadrilateral CZGT we obtain that; $26 \cdot 37 = CG \cdot ZT = \{W\}$. We note here that $W \in CG$. (10)

Note $\{R\} = AB \cap ED$ and $\{S\} = AH \cap EF$. In the circumscribed convex quadrilateral ARES applying Lemma 1 we obtain that: $15 \cdot 48 = AE \cdot RS = \{W\}$, consequently $W \in AE$. (11)

Note $\{P\} = DE \cap HG$ and $\{Q\} = CD \cap AH$. The circumscribed concave quadrilateral QDPH and Lemma 2 lead to $37 \cdot 48 = DH \cdot QP = \{W\}$. We note from here that $W \in AE$. (12)

Relationships (9), (10), (11) and (12) show that the diagonals BF, CG, AE and DH of the special octagon ABCDEFGH are concurrent in its quasi-center W.

Property . *The opposite sides of a special octagon and the opposite sides of the octagon determined by the tangent points of the sides of the given special octagon with the circle intersect two by two in 8 collinear points.*

Demonstration. Let ABCDEFGH be the special octagon given and die 12345678 the octagon formed by the points of tangent to the circle of the sides AB, BC, CD, DE, EF, FG, GH, HA (see figure 5).

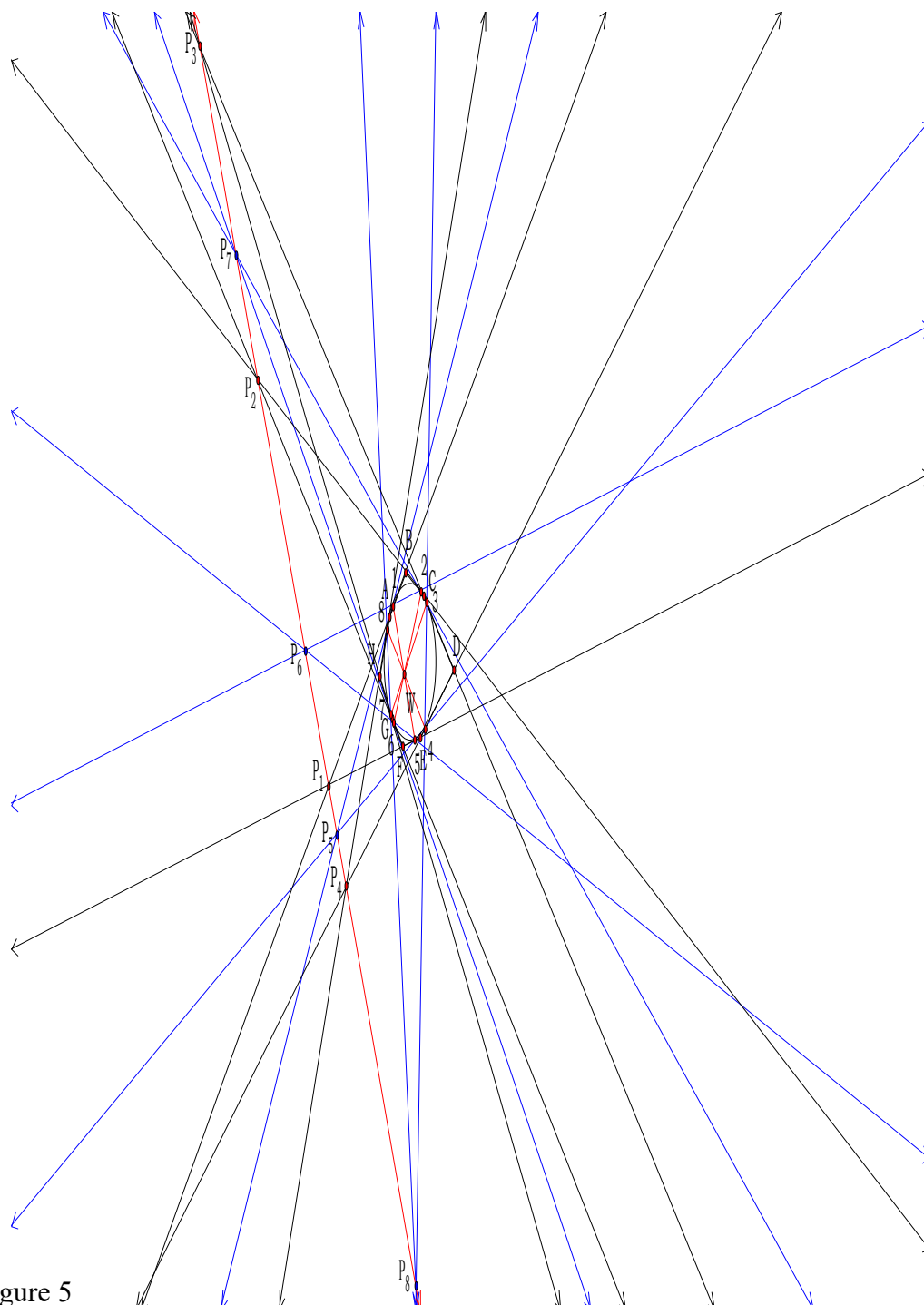

Figure 5

Transforming by duality in relation to the circle inscribed in the special octagon the configuration from figure 1 we have that the lines AB, BC, CD, DE, EF, FG, GH, HA correspond to their poles, that is the points 1, 2, 3, 4, 5, 6, 7, 8. The pole of the line 15 will be the intersection of the opposite sides AB and EF of the special octagon, we will denote this point with P_1 .

The pole of line 26 will be the point P_2 - the intersection of the opposite sides BC and FG of the special octagon. The pole of line 37 will be the point P_3 - the intersection of the opposite sides CD and GH of the special octagon. The pole of line 48 is the point P_4 -the intersection of the opposite sides DE and HA of the special octagon.

Since the lines 15, 26, 37 and 48 are concurrent in the point W -quasi-center of the octagon- then the poles of these lines, ie the points P_1, P_2, P_3, P_4 will be collinear points belonging to the polar of W in relation to the circle. The polar of point A is line 18, the polar of point E is line 45, it results that the pole of the diagonal AE will be the intersection of lines 18 and 45, opposite sides in octagon 12345678, ie a point that we denote P_5 , because AE passes through W we obtain that P_5 it will be on the polar of W in relation to the circle, so it will be collinear with the points P_1, P_2, P_3, P_4 .

Analogously point P_6 , the pole of the diagonal BF of the octagon will belong to the polar of W, P_7 the pole of the diagonal CG of the octagon will be a point on the polar of W and finally point P_8 the pole of the diagonal DH will belong to the polar of W. In conclusion the points $P_1, P_2, P_3, P_4, P_5, P_6, P_7, P_8$ are collinear points located on the polar quasi-center W in relation to the circle.

Bibliography

- [1] Coxeter, H. S. M.; Greitzer, S. L. *Geometry revisited*. Toronto-NewYork, 1957 (translation in Russian, 1978).
- [2] Patrascu, I.; Smarandache, F. *Variance on topics of plane geometry*. Educational Publishing, Columbus, Ohio, USA, 2013 .

Erratum to the paper “Fifty Years of Kurepa’s $!n$ Hypothesis” by Žarko Mijajlović

Florentin Smarandache

Florentin Smarandache (2021). Erratum to the paper “Fifty Years of Kurepa’s $!n$ Hypothesis” by Žarko Mijajlović. *Bulletin of Pure and Applied Sciences - Section - E - Mathematics & Statistics* 40E(2), 164-166; DOI: 10.5958/2320-3226.2021.00018.7

Abstract In this short note we prove that the Kurepa (K) function is different from the Smarandache-Kurepa (SK) function, therefore, these functions are not the same, as Mijajlović has unfoundedly accused the prestigious Encyclopedia of Mathematics and this author. This note is an answer to Mijajlović’s paper (Žarko Mijajlović, Fifty years of Kurepa’s $!n$ hypothesis, *Bulletin T. CLIV de l’Académie serbe des sciences et des arts – 2021 Classe des Sciences mathématiques et naturelles Sciences mathématiques*, No. 46, 169–181 (2021). http://elib.mi.sanu.ac.rs/pages/browse_issue.php?db=bltn&rbr=21, <http://elib.mi.sanu.ac.rs/files/journals/bltn/46/bltnn46p169-181.pdf>).

Key words Kurepa (K) function, Smarandache-Kurepa (SK) function, Encyclopedia of Mathematics.

1 Introduction

In the paper [1, p. 172], Mijajlović asserts that: “We have to mention also that there are inappropriate names assigned related to Kurepa’s left factorial function. The most remarkable example is that $!n$ is also called Smarandache-Kurepa function at the rather reputed Wolfram MathWorld portal [5].”

Although the author cited the prestigious Encyclopedia of Mathematics and the link to the SK function [5], he either overlooked its entry (although it has only five lines), or he did not understand it. Therefore, he jumped to attacks and an unfounded accusation.

2 Proposition

We propose here that the K and SK functions are different from each other and we prove this below.

Definition 2.1. The Kurepa K left factorial function [2] is defined as a sum of increasing factorials:

$$K_n = !n = \sum_{i=0}^{n-1} i! = 0! + 1! + \cdots + (n-1)!,$$

for $n \geq 1$.

Let us compute some values of the Kurepa function K_n .

$$\begin{aligned} K_1 &= 0! = 1, \\ K_2 &= 0! + 1! = 2, \\ K_3 &= 0! + 1! + 2! = 4, \\ K_4 &= K_3 + 3! = 4 + 6 = 10, \\ K_5 &= K_4 + 4! = 10 + 24 = 34, \\ K_6 &= K_5 + 5! = 34 + 120 = 154, \end{aligned}$$

and so on.

Definition 2.2. In the Encyclopedia of Mathematics, the Smarandache-Kurepa (SK) function [5] is defined as follows: “Given the left factorial function:

$$\sum(n) = \sum_{k=1}^n k!.$$

$SK(p)$ for p prime is the smallest integer n such that $p | \{1 + \sum(n-1)\}$, i.e., p divides $1 + \sum(n-1)$. The first few known values of $SK(p)$ are 2, 4, 6, 6, 5, 7, 7, 12, 22, 16, 55, 54, 42, 24, ... for $p = 2, 5, 7, 11, 17, 19, 23, 31, 37, 41, 61, 71, 73, 89, \dots$

The function $SK(p)$ does not exist for $p = 3, 13, 29, 43, 47, 53, 67, 79, 83, \dots$ ”

Definition 2.3. Let us also present the Smarandache (S) function [3, 4], used in the construction of the SK function, which is defined as below: $S(n)$ is the smallest integer n such that $n | S(n)!$, i.e., n divides $S(n)!$.

3 Comparison of the K and SK functions

From the above three definitions, we clearly see that the SK function is a combination of the S function (“the smallest integer n such that p divides ...”), and the K function (“the expression that has to be divisible by p is the Kurepa left factorial) - where its name the SK function comes from.

However, the two functions, K and SK are analytically different as it can be seen easily.

Neither their values are the same:

The first values of the K_n computed above are: 1, 2, 4, 10, 34, 154, ...

While, the first few known values of $SK(p)$ are 2, 4, 6, 6, 5, 7, 7, 12, 22, 16, 55, 54, 42, 24, ... for $p = 2, 5, 7, 11, 17, 19, 23, 31, 37, 41, 61, 71, 73, 89, \dots$ (see, Weisstein [5]).

Thus, the values of K and SK functions are also different.

The SK function was introduced by M.R. Mudge [6, 7] in 1996, an English mathematician, not by Ashbacher as asserted by Mijajlović [1].

Mijajlović does not say anything about the *Wagstaff's left factorial* [6-8], which looks more intuitive than Kurepa's, and is defined as:

$$B_n =!(n+1) - 1 = 1! + 2! + 3! + \dots + n!.$$

When this author found out about the above said paper of Mijalović, he sent e-mails [9, 10] to Mijajlović and to the Editor of this Journal [1] - Gradimir V. Milovanović, inviting the author Mijajlović to update his paper [1], since it has a wrong section, or else to publish this author's response in this reference, but they both declined this author's request.

References

- [1] Mijajlović, Žarko (2021). Fifty years of Kurepa's $!n$ hypothesis, *Bulletin T.CLIV de l'Académie serbe des sciences et des arts – 2021 Classe des Sciences mathématiques et naturelles Sciences mathématiques*, No. 46, 169–181. http://elib.mi.sanu.ac.rs/pages/browse_issue.php?db=bltn&rbr=21, <http://elib.mi.sanu.ac.rs/files/journals/bltn/46/bltnn46p169-181.pdf>

- [2] Kurepa, Dj. (1964). Factorials of cardinal numbers and trees, *Glasnik Mat. Fiz. Astr.*, 19(1-2), 7–21.
- [3] Smarandache, F. (1980). A function in number theory, *Analele Univ. Timisoara, Ser. St. Math.*, 43, 79–88.
- [4] Sondow, J. and Weisstein, Eric W. . Smarandache Function. From MathWorld–A Wolfram Web Resource. <https://mathworld.wolfram.com/SmarandacheFunction.html> (Accessed on 09/02/2021).
- [5] Weisstein, E. . Smarandache-Kurepa Function, From MathWorld A Wolfram Web Resource. <https://mathworld.wolfram.com/Smarandache-KurepaFunction.html> (Accessed on 09/02/2021).
- [6] Mudge, M.R. (1996). Introducing the Smarandache-Kurepa and Smarandache-Wagstaff Functions, Abstracts of papers presented to the Amer. Math. Soc. 17, 583.
- [7] Mudge, M.R. (1996). Introducing the Smarandache-Kurepa and Smarandache-Wagstaff functions, *Sm. Not. J.*, 7(1-2-3), 47–50. <http://fs.unm.edu/SN/SKurepa.pdf> (Accessed on 09/02/2021).
- [8] Weisstein, Eric W. . Smarandache-Wagstaff Function. From MathWorld–A Wolfram Web Resource. <https://mathworld.wolfram.com/Smarandache-WagstaffFunction.html> (Accessed on 09/02/2021).
- [9] Smarandache, F. E-mail to Žrko Mijajlović dated 30 August, 2021.
- [10] Smarandache, F. E-mail to Gradimir V. Milovanović dated 03 September, 2021.

MISCELLANEA

The Fifth Function of University: “Neutrosophic E-function” of Communication- Collaboration-Integration of University in the Information Age

Florentin Smarandache, Ștefan Vlăduțescu

Florentin Smarandache, Ștefan Vlăduțescu (2013). The Fifth Function of University: “Neutrosophic E-function” of Communication-Collaboration-Integration of University in the Information Age. *Archive.org*, 18. DOI: 10.5281/zenodo.30217

The study is based on the following hypothesis with practical foundation:

- Premise 1 - if two members of university on two continents meet on the Internet and initiate interdisciplinary scientific communication;
- Premise 2 - subsequently, if within the curricular interests they develop an academic scientific collaboration;
- Premise 3 - if the so-called collaboration integrates the interests of other members of the university;
- Premise 4 - finally, if the university allows, accepts, validates and promotes such an approach;
- Conclusion: then it means the university as a system (the global academic system) has, and it is, exerting a potential function to provide communication, collaboration and integration of research and of academic scientific experience.

We call this last function of the university “neutrosophic e-function” because it mixes heterogeneous and uncertain notions. It is specialized, according to the functions of “teaching-learning, researching, the public interest and entrepreneurial interest,” as the fifth function. As the other four have structured and shaped university paradigms, this one configures one as well. E-function makes visible a functional structure in a scientific scan: the communicative-collaborative-integrative paradigm.

Beyond the practical and inferential logic arguments, the research bases the hypothesis on historical and systemic-operational arguments. The foundation consists of the fundamental contributions of some academics (Y. Takahara, C. Brătianu, M. Păun, R. Carraz, Y. Harayama, I. Jianu, A. Marga, M. Castells, H. Etzkowitz, A. Ghicov, T. Callo, and S. Naidu), and our contribution is apprehending the strong tendency of the university system to exercise an e-function and to move toward a global university e-system.

Keywords: *university, system, e-function, communication, collaboration, integration.*

I. The concept of university. Axis 1

In relation to the requirements of accuracy, the side resonances turn the idea of university into an elusive and vague concept. This does not come from the specialists' lack of concern for the radiography of such a major social agent. University is, from all existing institutions, the organization with the oldest, most solid and most thorough history. As a place of knowledge, it is also a medium of self-understanding. From this perspective, it is paradoxical that in the house of knowledge is not found a thorough and robust self-understanding. It seems that the university does not have a clear and lucid self-awareness. Epistemologically, the university is the fountain, the criteria and the archive of knowledge. Any knowledge, it appears, implies a lack of knowledge. And maybe, once the status of knowledge is accepted, ignorance can be considered as the foundation of knowledge. Therefore, an explanation of the elusiveness of the concept of universality comes from the uncertainty about the content of the ignorance. In a way, the meaning of university is the unknown. The awareness of the unknown and the awareness of the need for developing knowledge forms the energetic poles that feed the university system.

Another line of explanation is to understand current university as moving quickly in relation to the subject of knowledge and to the actors of knowledge. University is the most agile, insidious and versatile of all the institutions of knowledge.

Thirdly, the fact that it knows itself better and better, while rapidly changing, makes visible knowledge variable itself. Variability is the subject of entropy and thus of negentropy and information. Therefore, the accuracy of self-knowledge induces an effect of vagueness that reinforces the impression of elusiveness.

Practically and conceptually, the university is all right. The first axis of understanding the university is this conceptual elusive understanding.

II. University as an organization. Axis 2

On a second axis of preliminary understanding-explaining, the university is specialized, as shown by Professor Constantin Brătianu as "a very complex organization" (2005, pp. 43-55). Generically, the organization is founded as a social group dedicated to a specific task. Subsequently, Norman Goodman shows it has a "formal structure that tries to accomplish the task" (1998, p. 71). In

accomplishing the defining task, it exploits some of the statutes and potential roles of its members. Related, it generates status and roles arising from the title of member and of organizational actor.

The genesis of organization is not conceptual, but social. Through it, society solves social problems. Essentially, traditionally, university solves two categories of problems: knowledge and education. The first category includes the production and transfer of knowledge. The other includes ethical, political, medical, economic-entrepreneurial education etc.

Organizations are defined not by the tasks they propose, by the objectives they set or by the mottos they are acting under, but by the problems they solve. They are not ends but means. Organization is a social tool for solving problems. The word organization comes from the French vocable “organisation” and etymologically comes from the Greek “organon” which means “instrument.” Basically, the organization carries out activities that lead to solving social problems. The first feature of the organization is to be an association of people interacting in the idea of preparing a group engaged in cultural, social, educational, and administrative activities. Underlying features are linked to it. Members related to a set of values, are subjected to rules and accomplish shared tasks when performing roles and statutes.

Organizations may be firms, companies, associations, governmental or non-governmental entities, foundations, etc. The most important organizations have legal grounds. When the activities of an organization and the social relations established by it acquire state importance, they are regulated by law. The organizations that acquire state importance or have national or supranational interest are legally recognized as institutions.

University is a fundamental scientific and educational institution of a state. Organizations have a social profile not because of the accomplishment of “specific objectives,” as S.P. Robbins, D. A. DeCenzo and M. Coulter deem (2010), but due to the problems they solve. In our opinion, the role of the organization as an intelligent operator is to perform activities that solve problems.

III. University as a system. Axis 3

3.1. A third axis of comprehension is to address the university as a system. As shown by Yasuhito Takahara, “An organizational system is a complex of interconnected human and nonliving machines” (2004, p. 3).

As a system, the organization has inputs and outputs. The inputs would be of two kinds: “The first type is a resource input such as personnel, material, money, energy, and information. The second is external managerial information related to customer demands, consumer behaviors, marketing conditions, economic

situations, etc.“ (Takahara Y., 2004, p. 4). The organizational mechanism “transforms the resource inputs into products or services and transmits them to environments as an output” (Takahara Y., 2004, p. 4). The Japanese specialist understands the organization as being “formed for a purpose” (Takahara Y., 2004, p. 3) and as performing activities in this regard. About the transformation of input resources into output products or services is stated: “The transformation, which usually requires support of a specific technology, is the primary activity of an organization” (Takahara Y., 2004, p. 4). The professors Constantin Brătianu, Simona Vasilache and Ionela Jianu conceive the organization similarly. They emphasize that any organization is made up of “resources,” “processes” and “products” (Brătianu C., S. Vasilache, Jianu I., 2006). In a later article, Constantin Brătianu highlights: “In any organization all activities can be grouped together in two basic processes: the production process and the management process” (2007, p. 376). The production process (technological process) leads to achieving tangible final results of the organization that can be “objects or services” (as Y. Takahara asserted in 2004). The organizational system develops management activities as well: “management activity is to control the primary activity of transformation so that the organizational goal is realized” (Takahara Y., 2004, p. 4). The management process is connected with the production process and together they made up a systemic unit. It is focused on ensuring the production performing “effectively and efficiently”: the fulfillment of tasks correctly and obtaining products with a minimum allocation of resources and execution of those activities that lead to achieving goals. In the same context, Professor Constantin Brătianu explains: “The process of management can be performed through its main functions: planning, organizing, leading and controlling” (2007, p. 376).

3.2. Topologically, the organization as a system is defined by several modules. The above mentioned specialists identify the input, the output and the processes (Constantin Brătianu) or the transformation (Yasuhito Takahara). Collaterally, in order to designate activities performed between the input module and the output module we will use the concept of throughput. David Besanko, David Dranove, Mark Stanley and Scott Schaefer use the term “throughput” to conceptualize a phenomenon that conditions the successful businesses. Throughput is “the movement of inputs and outputs through the production process” (2010, p. 100).

So by throughput it is understood the module of activities which ensures the conversion of input (resources) to output (products and/or services).

3.3. Besides the topological coordinate the system has two more coordinates: the structural and the functional.

The entirety, the “multitude of elements” of a system with the connections, the “relations between them” “form the system structure” (Dima I.C. Cucui I.,

Petrescu M., Stegăroiu I., Năbârjoiu N., 2007, p. 11). The structure is emerging as a configuration of the moment. The system has potential for structural changes. It remains valid even when structural changes occur. In this coordinate, the system seems to be capable of allowing the evolution of elements and relationships, of components. At one point, the system has a structure, a state and a set of possibilities for transformation and development. The structure is the specific internal way of organizing the system elements. It is a configuration currently stable and qualitatively determined of the connections between elements.

3.4. The functional coordinate of the system is inextricably linked to the structural coordinate. Between the system structure and the functions performed by the system, a strong connection exists. The structure determines the function and the functioning modifies the structure. As the functioning is the prerogative of managers, it is at the same time, subjected to the power of the management strategies. As Peter F. Drucker shows, “structure follows strategy” (2010, p. 94). The functional connections, on the other hand, determine in time the variations in input and output. The state system is a functional problem. It appears as a constant of the connection’s parameters within certain time. State is the measure of the system characteristics of the moment. The functional coordinate consists of the processes by which the system performs its functions. The transition from one functional state to another is the transformation.

The components of an organization are employees, managers, leaders, clients, beneficiaries etc. This is the structural capital of the organization. Systemic social connections appear as relations. In its relational capital, a system may include relationships of cooperation, collaboration, exchange, determination, influence, and communication. They may be hierarchical, vertical, horizontal, etc. Relations are those that ensure the system stability and allow its operation and adaptation to internal and external environments (natural, social, financial, economic, strategic, etc.). Relationships vary in time and give the dynamic character of the system. Effective systems seek to maintain stability. In general, however, systems have a strong inertia. As S.P. Robbins argues, “Organizations, by their very nature, are conservative” (2008, p. 187).

Structural-functional internal stability can be maintained in two ways. Adapting to the environment, systems tend to preserve internal steady states and perform its functions. First of all, W. R. Ashby states, the actions of the system “as varied as they are have one goal, to maintain constant conditions in the internal environment” (1958, p. 121). The more structurally elements are more independent of each other the more each one develops a greater capability to adapt. A better flexibility of the elements, namely a lower interdependence, is a premise for higher functional stability of the system. The second manner that the system preserves its stability in is feedback. Yasuhito Takahara speaks of two types of stability:

“behavior stability and structural stability” (2004, p. 4). “Behavior stability” is achieved through “feedback mechanism” and “structural stability” (or “the practice of keeping characteristic parameters of an organization constant”) is achieved ”by higher level management activities” (2004, p. 4).

In the article “Interactions among components of the university system,” Mihaela Păun (from Louisiana Tech University) and Miltiade Stanciu (from ASE Bucharest) start from the assumption of the university as system and institution. Zetetic stake is finding a revealing answer to the question: “Which is the most important component/resource in a university?” (2008, p. 94). Research is moving toward the components/resources of the university. The perspective is, implicitly, topological, structural and functional. The referred components are students, teachers and infrastructure. Resources are put into the equation to conclude about an intangible resultant. The unknown is defined: the human components (students, teachers) and the infrastructure are crucial in the university performance and competitiveness. They are equally important. From other perspective, we mention that there are “teaching oriented” universities and “researching oriented” universities. It is also recalled the existence of components of “teaching” and “researching” in most universities (Păun M., Stanciu M., 2008, p. 98).

Students and teachers appear to be defining systemic academic components (M. Trow, 1975). Professor Constantin Brătianu considers that “professors and students represent the most important resources” (2009, p.67). In higher education, teachers and students are defined as actors who have specific functions. Social actors exercising functions become system factors. Functional actors, ontological factors of the university, are the students and teachers (including teachers who have managerial responsibilities). They are engaged in an academic contract of didactic communication. The rights and obligations of the academic actors bear the mark of university functions. In turn, academic institution exists through its factors and through didactic teaching and research actions carried out in the university.

IV. The four institutionalized functions of the university

4.1. The first functions: “Teaching-learning” and “Researching.”

Generations of universities, the Humboldtian university paradigm:

Today, university is at the end of an evolution and in a transformation process that takes into account the forecasting, the foresight and the normative future. The functioning of the system means conducting specific activities. This happens within some processes. As Yasuhito Takahara (2004), Constantin Brătianu, S. Vasilache and Ionela Jianu (2006) argue, any organization runs two

types of processes: processes of production (or technology) and management processes. The set of academic technological processes is subsumed to some functions undertaken by the university institutions. On the other hand, an effective university management process will be in line with technological processes, first of all and defining, regarding the functions of the university system. This university management process is supported by a structure with a clear profile, which Yuko Harayama and Ren Carraz would call “the university management structure” (2008, p. 93).

In 2003, Parliament of Australia retained that the “core functions of university” are “teaching, learning, and research” (2003, p. 21440). The one who diachronically has implemented this academic and functional model was Wilhelm von Humboldt, founder of the University of Berlin. “His university model,” professor Gerd Hohendorf (Hohendorf G., 1993, pp. 617-618) argues, “is characterized by the unity of teaching and research. It was to be a special feature of the higher science establishments that they treated science as a problem which is never completely solved and therefore engaged in constant research.”

Professor Constantin Brătianu and professor Yuko Harayama agree with the idea that Wilhelm von Humboldt introduced a “new university paradigm” (incidentally in Greek “paradigm” meant “modeled”). In addition, the Romanian specialist found that the two functions were also complementary. “The new university paradigm... is founded on the unity and the complementarity of the functions of teaching and research” (Brătianu C., 2009, p. 63).

The core of the functional Humboldtian model is that scientific issues are never “completely solved” and that, therefore, the university must remain “engaged in constant research.” Understanding the Humboldtian model as a third generation of universities, Yuko Harayama emphasizes that within it the situation of the academic subjects is a situation of constant discovery. This means that “the teaching and learning process” occurs through “research activities” (Harayama Y., 1997, p. 13). In other words, the discoveries occur in university; possibly even in the teaching process. To reach this stage, the university has gone through, Yuko Harayama asserts, two models.

The first of university system emerges in the eleventh century and the twelfth century. Its elements are the teachers and students. The function of the system is one of knowledge transfer (knowledge is validated and scientific information is consecrated and preserved). The teachers do not create, do not innovate, do not discover. They take knowledge and new knowledge elements and they teach them. The new elements of knowledge are generated outside academia. The function of this university is one of “teaching.”

A second generation of universities, according to Professor Yuko Harayama, keeps the non-investigative character and guides the teaching act only toward the

elites of the religious and political spectrum. We would say that this model is focused on “teaching” too, its characteristic being the limitation induced by the religious or political pressures.

The third model, introduced by Wilhelm von Humboldt, is bi-functional: “teaching and research.”

Today the university model is based on the Humboldtian model. The technological university process is essentially a “teaching-learning process.” Over time this process has always been the focus of academic management in order to increase its efficiency and effectiveness. On the other hand, he was doubled at a time by the research process. The opinion of Professor Constantin Brătianu is similar: “The fundamental competences of a generic university are: teaching, learning and research. All of these are knowledge dynamic processes”(2009, p. 69). These two key functions have been multiplied in the policies developed in universities. Thus the universities are no longer limited today to the two functions. As Howard Newby argues “Today's universities are expected to engage in lifelong learning (not just teaching), research, knowledge transfer, social inclusion (via widening participation or access for non-traditional students), local and regional economic development, citizenship training and much more”(2008, pp. 57-58).

4.2. The third function: utility and social engagement

During the early twentieth century, the external environment required that universities have a stronger orientation toward utility. University transfer generates a system of high education that should acquire a more remarkable social, economic, financial and moral utility. He who brings in this practical necessity is John Henry Cardinal Newman. In his “The Idea of University,” he considers theology as a “branch of knowledge” (1999, p. 19) and militates for “useful knowledge” and for “usefulness” (1999, pp. 102-109). Through the knowledge provided, the university must exercise a function of utility and social involvement, locally, regionally or nationally. The transferred knowledge is required to acquire utility and practical involvement.

4.3. Entrepreneurial function. Entrepreneurial Paradigm

The functional development of the university has as its main purpose the performance and the competitiveness. Modern and post-modern universities are financed either by public funds or private funds and sometimes have a double funding. Private universities were the first who raised the question of self-financing. Related, the research function included an economic efficiency criterion. Therefore, having at least this double causality, the commercial, and economic

entrepreneurial function has enforced in the set of functions. This remodeled the principal functions too, the ones of “teaching, learning and researching.” High education institutions have also assumed the entrepreneurial task function. In 1983, in the article “Entrepreneurial Scientists and Entrepreneurial Universities in American Academic Science,” Henry Etzkowitz launched the concept of “entrepreneurial university.” He argued that Thorstein Veblen had admitted at the beginning of the twentieth-century the possibility “that American universities would increasingly take on commercial characteristics.” Then, Henry Etzkowitz noted that “universities... are considering the possibilities of new sources of funds to come from patenting the discoveries made by holding academic appointments from the sale of knowledge gained by research done under the contract with commercial firms, and from entry into partnerships with private business enterprises” (1983, p. 198). A university exerting such an entrepreneurial function is an entrepreneurial university. In 2000, Henry Etzkowitz and his colleagues would find that “entrepreneurial university is a global phenomenon” and understand that it was “the triple helix model of academic-industry-government relations.” They speak, in this case, of the “entrepreneurial paradigm” (H. Etzkowitz, A. Webster, C. Gebhardt, Cantisano, Terra BR, 2000, p. 313). The concept of “entrepreneurial university” was considered lucrative and was developed so that, in 2007, David Woollard, Oswald Jones and Michael Zhang realized that this feature (generally accepted as a function) is, along with “teaching and researching the third mission” (2007, p. 1), meaning “commercialization of science .”

However, the concept also keeps a dose of lack of understanding and a dose of misunderstanding (Stanciu. Șt., 2008, pp. 130-134). However, in Romania the concern for an entrepreneurial university is already solid. Since 1998, professor Panaite Nica has taken scientifically into account the entrepreneurial function. Subsequently, Professor Valentin Mureșan (2002) brought in convergence opinions of university entrepreneurial specialists from France, England and Romania. For now, the concept of “Entrepreneurial University is still fuzzy and culturally dependent” (Brătianu C., Stanciu Șt., 2010, p. 133).

V. Collaborative-Communications Paradigm, the fifth function: function of communication, collaboration-integration

The functions of the university system are related to the mending demands required by the internal environment and by the needs to adapt to the external environment. These functions are initially mission assumed by the management structure. Once proven, the practical validity and the mission effectiveness, for a longer period and in several universities, it becomes a function of the global

university system.

Functions are ways of permanent structural changing-transforming of the university system in relation to the internal requirements and external needs. As specified by Andrei Marga, university functions in society and fulfills “functions which develop along with the changes around them” (2009, p. 152). Following the same line of ideas, Andrei Marga takes into account “the multiple functions of university” (2004, p. 13). In exercising these functions, the university is presented “as a powerful scientific research center for acquiring and applying knowledge,” and “as a source of technological innovation, as an intellectual authority in critically examining situations; as a space for commitment to civil rights, social justice and reforms” (Marga A., 2004, p. 13).

Functions are, in general, “institutionalized” by the laws that give the university the character of institution. Thus, for example, social utility missions or entrepreneurial plans that were undertaken by some universities 25 years ago are now a function of the university system in general. Moreover, supranational authorities currently allow future university functions.

“The Bologna Declaration” (1999) mentions many of the functions of the university, teaching, research and a predicted communication-dissemination function. “The University functions in the societies having differing organization being the consequence of different geographical and historical conditions, and represents an institute that critically interprets and disseminates culture by the way of research and teaching.”

Nowadays, the environment university develops is one it has contributed to. This environment is not one in which the university decides. It must adapt to it.

The globalization of economic, financial, social phenomena is, on the one hand, the result of knowledge development, of creativity and innovation, and on the other, of their putting into practice. The world is in the Information Age. There has been a digital revolution that has succeeded everywhere. Interaction, networking, connectivity that is always the engine of society acquires new values in the new context. Social relations are digitally imprinted. Some of them even develop completely or partially, as mediated by computers. Many social relations have a virtual component.

The Information Age began after 1970 with the first personal computers, expanded after 1990 with the introduction of the Internet and strengthened after 2000 with the generalization of the Internet, with its use widely and globally.

In his trilogy, *Information Age* (1996, 1997, 1998, second edition 2000, 2001, 2004), Manuel Castells states: “Toward the end of second millenium of the christian era several events of historical significance transformed the social landscape of human life. A technological revolution, centered around information technologies, began to reshape, at accelerated pace, the material basis of society.

People increasingly organize their meaning not around what they do but on the basis of what they are. Meanwhile, on the other hand, global networks of instrumental exchanges selectively switch on and off individuals, groups, regions and even countries. “Our societies are increasingly structured around a bipolar opposition between the Net and the Self” (Castells M., 1996, p. 1 p. 2 and p. 3). Taking ideas expressed in the late 1980s, Manuel Castells formulates and sets in trilogy the concept of the “Information Age.” “Prologue: the Net and the Self” opens the first volume “The Rise of the Network Society.” Here with the idea of the Information Age, two more ideas are displayed, that of the “network society” and that of the opposition between “Net” and “Self.” Later, in his book, *Communication Power* (2009), Manuel Castells will talk about the Information Age as the “digital age” or “network age.” The Information Age is the era of information society, information economy, information policy, etc. It is not a change of vision, but a transformation of substance, a historic turning point transformation. There is the digitization, globalization and putting in interaction to the components of the global social system.

Illustrating for the practical impact of digitization is the banks case. The globalization and interdependence brought by digitization went beyond any boundaries. They induced significant changes, major changes, namely functional changes. Banks, like all other operators, actors, and factors of the social, economic, and political systems, found themselves confronted with their own limits: some uncontrollable limits. In this respect, Lloyd Darlington points out: “For the first time in 300 years, the very nature of banking has changed. We still handle money, but information, not money, is now the lifeblood of our industry. From what was essentially a transaction-based business, where customers come to you (or didn’t), banking has to make the leap into what is essentially a sale-and-marketing culture” (1998, p. 115).

The Information era has induced significant changes in the internal environment and external environment of the university system. It has generated changes in the way the system should respond to the challenges and opportunities generated by the digital revolution, the technological revolution. The university system must adapt to external processes. To the external environmental changes, the university management must respond adaptively. The technological revolution has brought not only the transformation of the external environment, but it has also brought new tools for the university system to adapt. The challenge is primarily one of the university system functioning as a management coordinate and, secondly, in its “production” coordinate. The vision, missions and academic values are going through changes. In their content, strategic management includes adaptive tasks to respond to exogenous factors induced by digitization: extended or sometimes generalized computing and Internet communication, as well as rapid

globalization of knowledge, discoveries, innovations, etc.

University is becoming more and more a place for creative knowledge. In visions, missions and values, functional commitments begin to transpire. In other words, on their own some universities assume new functions. In time, through their inter-university resonance, similar commitments in visions, mission and values go national. They are institutionalized and become functions of any university system.

For example, in his strategic document, Oxford Brooks University mentions the traditional, modern and postmodern functions and it involves performing activities we think will become functions specific to the Information Age. In “Our strategy for 2020,” Oxford Brooks University stated: “Oxford Brooks University occupies a strong position in UK higher education. We have a sound and growing international reputation for the quality of our teaching, learning and research and we are a vital part of and contributor to the local and national economy and society.”

Remain fundamental nuclear functions of the university: “teaching, learning and researching.”

Public interest and entrepreneurial functions were institutionalized: “we are a vital part of and contributor to the local and national economy and society.” The strategy states: “We also need to ensure that our organizational structures support staff and students in their activities, that they facilitate the integration of research and teaching and promote inter-disciplinarity and diversity. We are international in our orientation: in our curriculum, our staff, our student body and our increasingly interdependent world partnership in an increasingly interdependent world. We aspire to be a university which makes a commitment to an educational culture where mentorship is valued and teaching is integrated with both research and cutting-edge practice from the professions.”

In the space it exists, the university must place itself as the main generator and supplier of knowledge. The relevant context of the current university system is structured mainly by the action of three factors. These factors-buoys of the context are:

a) Computing, technology, rapid innovation (prefigured by and currently under development by Gordon Moore's law: “the computing power of microchips doubles every 18 months”);

b) Accelerated extension of the information-communication systems, (categories of users increase, diversify and amplify their importance: according to Robert Metcalfe's postulate: “a network's value grows proportionally with the numbers of users” and according to George Gilder's law “the total bandwidth of communication systems triple every 12 months”);

c) Development and accreditation of a collaborative and disseminating academic environment (the transition from unilateral projects to international and

multilateral projects, the application of the principle of “shared knowledge,” the liberalization of flows of knowledge and the setting of new dissemination channels).

The fundamental phenomena taking place in the internal environment are a permissive-adaptive and intelligent replication of those from the external environment: tech-digitization, globalization and interdependence. They have a direct impact on the activities carried out in the university and indirectly (mediated by management) on the functions of the university system.

According to the strategy Oxford - 2020, management assures (“ensure”) in connection with the involvement in reforming the functions of “teaching” and “research”: “facilitate the integration of research and reaching” and “commitment to”... “teaching integrated with both research and cutting-edge practice.”

Related, we mention a commitment to “promote inter-disciplinarity and diversity.” A direction with a functional touch is the decision that the university should be “international in our orientation: in our curriculum, our staff, our student body and our partnership.” If at first already accredited four functions are mentioned, this latter functional commitment is specific to the Information Age world: “an increasingly interdependent world.”

Manuel Castells considers “globalisation and digitization” as “the two most profound social and economic trends of our age” (2009, p. 70). The main feature of globalization is reflected in the fulminant emergence of networks. A “Global Network Society” emerges. “Network society is to the Information Age,” Castells states, “what the industrial society was to the Industrial Age” (2009, p. 12). In the “Global Network Society” image, universities are characterized as academic institutions with a recognizable profile. They “are at the cutting edge of research and teaching on the global network society.” Keeping in mind two of the functions of the university “teaching” and “research,” we may notice the acceptance of a commitment project: “project of situation the university within the technological and intellectual conditions of the Information Age” (Castells M., 2009, p. 3). Manuel Castells is not concerned with how the university should develop in the Information Age.

Our thesis is that in the context of the “Digital Age,” the university system must assume new functions adaptively. These functions are not surprising occurrences. They have been preliminarily mentioned in the university strategies, either incidentally as vision, mission and values or as precise missions. In the context of separation of functions the university system had to institutionalize, we mention Professor Andrei Marga’s point of view. He has argued that the twenty-first century university is forced to face many challenges, listing ten: “the implementation of the Bologna Declaration (1999), globalization, the sustainability and the identity of a university, the autonomy, the quality assurance, the

Phenomenon of “brain drain,” the issue of multiculturalism of leadership, the climate of change, the overcoming of relativism, and the recuperation of the vision based on knowledge “(Marga A., 2008).

Smart organizations are characterized, among other things, by flexibility, learning and a high potential for change. As the most important pole of knowledge and as a decisive development pole, the university is among the most intelligent organizations. Therefore, we anticipate that university systems will even take on new functions according to the Digital Age opportunities. They will not expect that from opportunities, the challenges should become necessities. The new paradigm of a pure specificity for the Information Age will be a collaborative-communicational paradigm.

We predict that the current university system will connect into a single network under a title like “Universities Global Network.” It is already mentioned, as Professor Adrian Ghicov does, about the “matching network” for an “efficient learning” (2008, p. 29) and about the “idea of integration and completeness” (Callo T., 2005, p. 49). Following the same line of ideas, Bogdan Danciu, Margaret Dinca and Valeria Savu consider communication and collaboration as concepts of adaptation in the “academic field” (2010, p. 87).

University collaborative platforms will be open in areas and disciplines. Yuko Harayama and Ren Carraz count on “scientific collaboration,” a feature found in the Japanese university system; see Harayama Y., R. Carraz, 2008.) Thus, “teaching” and “researching” could be carried out in the network. In this respect, Ilie Bădescu, Radu Baltasiu and Cristian Bădescu talk about “research networks” (2011, p. 248). IT infrastructure will enable the exchange of lectures held by teachers, live, interactively, in the videoconferencing system. Teachers specialize in certain subjects or who have important contributions on specific topics will be able to teach, using computer highways, the students from other universities in different regions or even other continents. As Ana Maria Marhan argues, cognitive players have not only become users of information technology, but they have mentally adjusted with the computer tools for learning, research, knowledge: a lucrative relationship between man and computer has been established (2007, pp. 12-14). Moreover, the teaching-learning in the network will capitalize improving the effect of “social facilitation” discovered by Robert B. Zajonc; “the mere presence of others” improves performance (1965, p. 274). The presence of students and teachers from other universities in videoconferencing will enhance the performance of teaching-learning knowledge and information. Students, as stated by Gheorghe Iosif, Ștefan Trăușan-Matu, Ana-Maria Marhan, Ion Juvină și Gheorghe Marius (2001), will be involved in designing cooperatively, with teachers, educational objectives; the training-educational process will be accomplished in relation to the “learning needs” and the “learning tasks,” using

computer technology, especially the Internet.

The integration of university research will start by regional, national projects and will expand globally. Collaborative platforms will allow the dissemination and unification of knowledge in areas and disciplines. In this manner, a knowledge base will arise for each discipline to avoid knowledge, research, parallel investigation or discovery in some places of old discoveries made in other units of knowledge. On the platforms, virtual research teams may rise which can synthesize all relevant knowledge on a specific subject and to continue research on behalf of the entire community of specialists. Researchers from different universities will work on joint projects in virtual teams in collaboration platforms. Interdependence of the world will be so fully visible regarding the interdependence of research and learning too. Research will be better and more equitable and professional and student performance indicators will gain a unique and relevant basis for reporting and evaluation. At this moment it has already achieved the digitization of some of the activities induced by the use and occurrence in university of the traditional university-canonical function. Decisive steps were taken to implement computer strategies concerning the “learning-teaching” function. Well-known Australian specialist, Som Naidu, notes that today student should learn in a new context, one “of e-learning; open, distant, and flexible learning environments” (2003, p. 362). Naidu says that “In the midst of all this interest in the proliferation of e-learning, there is a great deal of variability in the quality of e-learning and teaching.” (2003, p. 354). On this basis and related, the professor at the University of Melbourne develops a guide of principles and procedures. The study requires the idea of digitization by “e-learning and teaching” and other processes undertaken by the university system (S. Naidu, 2003).

We value and fight for strengthening and developing the communicative-collaborative-integrative functions of the global university system. If the Digital Age brings, however, globalization and interdependence, we should not expect that they be imposed, but we should welcome them. It is good to settle all opportunities from challenges. It would be a beneficial and wonderful feed-forward response. In fact, some steps toward this emerging fifth function have already been taken.

Finally, it is arguable that it is about a global e-university in a global e-system and that e-communication and collaboration function applies not only to universities, but to all institutions, and even to individuals entering the electronic global communication system.

Bibliography

1. Ashby W. R., *L'Homeostasia în Enciclopedie des sciences modernes*, t. VIII, Geneva, 1958.
2. Bădescu Ilie, Baltasiu Radu, Bădescu Cristian, *Sociologia și economia problemelor sociale*, București, Editura Mica Valahie, 2011.
3. Besanko D., Dranove D., Stanley M., Schaefer S., *Economics of Strategy*, 5th edition, John Wiley and Sons, 2010.
4. Brătianu C., *Reengineering the Romanian universities*, Journal of University Development and Academic Management, vol. 2, nr. 3-4, 2005, pp. 43-55.
5. Brătianu C., *The Learning Paradox of University*, Journal of Applied Quantitative methods, 2007, pp. 375-386.
6. Brătianu C., *The Intellectual Capital of Universities*, Annals of Faculty of Economics, vol. 1, Issue 1, 2009, pp. 63-70.
7. Brătianu C., Stanciu Șt., *An Overview of Present Research Related to Entrepreneurial University*, Management & Marketing, vol. 5, No. 2, 2010, pp. 117-134.
8. Brătianu C., Vasilache S., Jianu I., *Business Management*, Bucharest, Editura ASE, 2006.
9. Callo Tatiana, *O secvență experimentală a resortului de integralitate*, Didactica Pro, nr. 5-6(33-34), 2005, pp. 49-52, ISSN 1810-6455.
10. Castells M., *Communication Power*, Oxford University Press, 2009.
11. Castells M., *The Rise of Network Society*, Oxford, Blackwell, 1996.
12. Darlington L., *Banking Without Boundaries: the banking industry is transforming itself for the Digital Age*” în Tapscott D., Lowy A., Ticoll D., (eds.), *Blueprint for the Digital Economy. Creating Wealth in the Era of e-Business*, New York, McGraw Hill, 1998.
13. Dima I. C., Cucui I., Petrescu M., Stegăroiu I., Năbârjoiu N., *Econometrie managerială*, București, Editura Universității Naționale de Apărare „Carol I,” 2007.
14. Dincă M., Danciu B., Savu V., *Concepte definiții pentru adaptare*, în Dincă M. (coord.), *Câmpul universitar. O cultură a provocărilor*, București, Editura Universitară, 2010.
15. Drucker P. F., *Toward the next Economics*, Boston, Harvard Business School Publishing Corporation, 2010.
16. Etzkowitz H., *Entrepreneurial Scientists and Entrepreneurial Universities in American Academic Science*, Minerva, vol. 21, No. 2-3, 1983, pp. 198-233.

17. Etzkowitz H., Webster A., Gebhardt C., Cantisano, Terra B.R., *The future of university and the university of future: evolution of ivory tower to entrepreneurial paradigm*, Research Policy, 29, 2000, pp. 313-330.
18. Gheorghe Iosif, Ștefan Trăușan-Matu, Ana-Maria Marhan, Ion Juvină, Gheorghe Marius, *Proiectarea cooperativă a unui sistem inteligent de instruire pe web*, Revista de Psihologie a Academiei Române, Tomul 47, Nr. 1-2, 2001.
19. Ghicov Adrian, *Corelarea în rețea ca premisă a învățării performante*, Didactica Pro, nr. 6 (52), 2008, pp. 29-31, ISSN 1810-6455.
20. Goodman N., *Introducere în sociologie*, București, Editura Lider, 1998.
21. Harayama Y., Carraz R., *Japanese University Reform seen through Bureaucratic Reform and Changes in Patterns of Scientific Collaboration* în Weber L. E., Duderstadt J.J. (eds.), *The globalization of higher education*, London, Economica, 2008.
22. Hohendorf G., *Wilhelm von Humboldt*, Prospects: the quarterly review of comparative education, (Paris, UNESCO: International Bureau of Education), vol. XXIII, no. 3-4, 1993, pp. 613-623.
23. Marga A., *The University of the 21-st century. Challenges*, Journal of University Development and Academic Management, Year V, no. 9-10, 2008.
24. Marga A., *Values of University*, în Sodlak J., Hüfner K., Pricopie R., Grunberg L., *UNESCO Forum on Higher Education in the Europe Region*, București, Comunicare.ro, 2009.
25. Marhan A. M., *Psihologia utilizării noilor tehnologii*, Iași, Editura Institutul European, 2007.
26. Mureșan V., *Manifest pentru o universitate antreprenorială*, București, Editura Punct, 2002.
27. Naidu S., *Design Instruction for e-Learning Environments*, in Moore M. G., Anderson B. G. (eds.), *Handbook of Distance Education*, London, Lawrence Earlbaum Associates Publishers, 2003.
28. Naidu S., *E-Learning: a Guidebook of Principles, Procedures and Practices*, New Delhi, Commonwealth Educational Media Center for Asia (CEMCA), and the Commonwealth of Learning, 2003.
29. Newby H., *The Challenge of European Universities in the Emerging Global Marketplace* în Weber L. E., Duderstadt J.J., (eds.), *The globalization of higher education*, London, Economica, 2008.
30. Newman J.H.C., *The Idea of a University*, Washington, Regnery Publishing Inc., 1999.
31. Nica P., *Implicații manageriale ale trecerii la finanțarea globală a universităților*, Iași, Editura Multiprint, 1998.

32. Păun M., Stanciu M., *Interactions among components of a university system*, Management & Marketing, vol. 3, No. 4, 2008, pp. 93-104.
33. Robbins S. P., *The truth about managing people*, 2nd edition, New Jersey, FT Press Upper Sadle River, 2008.
34. Robbins S. P., DeCenzo D. A., Coulter M., *Fundamentals of Management: Essential Concepts and Applications*, 7th edition, London, Prentice Hall, 2010.
35. Robbins S. P., Judge T., *Essentials of organizational behavior*, 10th edition, London, Prentice Hall, 2010.
36. Smarandache, F., *A Unifying Field i Logics, Neutrosophic Logic. Neutrosophy, Neutrosophic Set, Neutrosophic Probability and Statistics*, A Res. Press, rehoboth, 1998.
37. Stanciu Șt., *The entrepreneurial culture in Romanian universities, a misunderstood concept*, Review of Management and Economical Engineering, vol. 7, no. 7, 2008, pp. 130-134.
38. Takahara Y., *A Formal Model of Organization* in Takahashi S., Kijima K., Sato R. (eds.), *Applied General Systems Research on Organizations*, Tokyo-Berlin, Springer-Verlag, 2004.
39. Trow M., *Teachers and students*, New York, McGraw-Hill, 1975.
40. Woollard D., Zhang M., Jones O., *Creating Entrepreneurial University: Insights from a new university business school*, Institute for Small Business & Entrepreneurship, 2007.
41. Zajonc R. B., *Social facilitation*, Science, New series, vol. 149, No. 3861, Jul. 16, 1965, pp. 269-274.

Teoria Neutrosifică a Evoluției: Grade de Evoluție / Indeterminare / Involuție

Florentin Smarandache

Florentin Smarandache (2017). Teoria Neutrosifică a Evoluției: Grade de Evoluție / Indeterminare / Involuție. *Destine Literare* 89-92, 246-248

În decembrie 2016 - ianuarie 2017, am întreprins o croazieră culturală și științifică în Arhipelagul Galapagos, Ecuador, în Oceanul Pacific, unde am vizitat șapte insule și insulițe: Mosquera, Isabela, Fernandina, Santiago, Sombrero Chino, Santa Cruz și Rabida, într-o croazieră cu vaporul Golondrina. Am discutat extensiv cu simpaticul nostru ghid, seor Milton Ulloa, despre habitatele naturale și transformările lor. După ce am observat multe animale și plante care au evoluat diferit de strămoșii lor veniți de pe continent, am consultat, reîntors la Universitatea New Mexico (UNM), unde activez, o variată literatură științifică despre viața animalelor și plantelor, despre reproducerea acestora și despre multiplele teorii ale evoluției. Am folosit bazele de date științifice on-line la care Biblioteca UNM (<http://library.unm.edu>) este abonată, ca: MathSciNet, Web of Science, EBSCO, Thomson Gale (Cengage), ProQuest, DOAJ, IEEE/IET Electronic Library, IEEE Xplore Digital Library etc., făcând numeroase căutări pe cuvinte-cheie legate de originile vieții, evoluție, idei controversate despre evoluție, adaptare și inadaptare, curiozități, mutații, genetică, embriologie ș.a.m.d. Concluzia mea generală a fost că fiecare teorie a evoluției posedă un grad de adevăr, un grad de indeterminare și un grad de neadevăr (ca în logica neutrosifică) - depinzând de tipurile de specii, mediu înconjurător, intervale de timp, sau alți parametri. Și toate aceste grade sunt diferite de la specie la specie, de la mediu înconjurător la mediu înconjurător, de la interval de timp la interval de timp, de la parametru la parametru. Prin mediu înconjurător se înțelege: geografie, climat, prăzi și prădători, i.e. întregul ecosistem. Animalele și plantele (și chiar ființele umane) nu doar evoluează, dar și involuează. Unele trăsături se

accentuează, altele se depreciază. Este de asemenea de observat că adaptarea poate ține diferențiat de evoluția fizică sau funcțională a unei părți a corpului, în timp ce alte părți ale corpului pot involua, iar celelalte pot rămâne neschimbate. Să reamintim câteva noțiuni din biologia clasică.

Taxonomia este disciplina științifică a clasificării viețuitoarelor de pe Pământ (în *specii, genuri și familii*).

O **specie** este un grup de organisme viețuind într-o arie specifică, având multe trăsături comune și fiind capabile de a se reproduce între ele. În unele cazuri, distincția dintre subgrupuri ale diferitelor specii este neclară, ca în Paradoxurile Sorites din cadrul neutrosofiei: frontiera dintre A (unde A poate fi o specie, un gen, sau o familie) și $\text{non}A$ (care înseamnă ceea ce nu este A) este vagă, incompletă, ambiguă. Similar pentru distincția dintre o specie și o subspecie.

Conform dicționarului online, **involuție** înseamnă:

Degradare, regresie sau contracție în dimensiuni; sau revenirea la o formă anterioară [Collins Dictionary of Medicine, Robert M. Youngson, 2005];

Revenirea unui organ mărit la dimensiune normală; sau răsucire interioară a marginilor unei părți; declinul mental asociat cu avansarea în vârstă (psihiatric) [Medical Dictionary for the Health Professions and Nursing, Farlex, 2012];

Având margini laminate (pentru organele plantelor) [Collins Dictionary of Biology, 3rd edition, W.G. Hale, V.A. Saunders, J.P. Margham, 2005];

O schimbare retrogradă a corpului sau a unui organ [Dorland's Medical Dictionary for Health Consumers, Saunders, an imprint of Elsevier, Inc., 2007];

Un declin progresiv sau degenerarea funcționării fiziologice normale [The American Heritage, Houghton Mifflin Company, 2007].

În timpul procesului de adaptare a unei viețuitoare B la un nou mediu înconjurător ,

B evoluează parțial;

B involuează parțial;

sau B rămâne parțial neschimbat (neutru, sau indeterminat – i.e. nu e sigur dacă este evoluție sau involuție).

Orice acțiune are o reacțiune. Putem observa, datorită adaptării: evoluția, involuția, și neutralitatea (indeterminarea), oricare dintre aceste trei componente neutrosifice într-un anumit grad.

Gradele de evoluție / determinare / involuție se referă atât la **structura** lui B (părțile corpului), cât și **funcționalitatea** lui B (funcționalități ale fiecărei părți, sau inter-funcționalități ale părților, sau funcționalități ale lui B ca întreg).

Adaptarea la un nou mediu înconjurător înseamnă dezadaptarea de mediul înconjurător anterior. Evoluție într-o direcție înseamnă involuție într-o altă direcție. Când o viețuitoare pierde într-o direcție, trebuie să câștige într-o altă direcție, în scopul de a supraviețui (pentru echilibru).

O specie, în ceea ce privește un mediu înconjurător, poate fi:

în echilibru, în dezechilibru, sau în indeterminare;

stabil, instabil, sau indeterminat;

optimal, suboptimal, sau indeterminat.

Se naște astfel o **Teorie Neutrosifică a Evoluției, Involuției și Indeterminării** (oscilație sau fluctuație între Evoluție și Involuție).

Dacă speciile sunt într-un stadiu de determinare (neclar, vag, ambiguu) față de mediul lor înconjurător, tind să se îndrepte spre o extremă: fie spre echilibru / stabilitate / optimalitate, sau spre dezechilibru / instabilitate / suboptimalitate față de mediul lor înconjurător; speciile sau se degradează, fie treptat, fie brusc, prin mutație, și pier, sau se ridică treptat sau brusc, prin mutație, către echilibru / stabilitate / optimalitate.

Punctul de atracție în acest sistem neutrosific dinamic este, desigur, stadiul de echilibru / stabilitate / optimalitate. Dar nici când atinge acest stadiu, specia nu este fixată și poate ajunge, datorită unor

noi condiții sau unor accidente, la stadiul de dezechilibru / instabilitate / suboptimalitate, iar din acest stadiu pornind din nou lupta speciei pentru a atinge punctul de atracție.

C teva Exemple Neutrosifice de Evoluție, Involuție și Indeterminare (Neutralitate)

1. Exemplul cormoranului

Să luăm exemplul cormoranilor nezburători (*Nannopterum harrisi*) din Insulele Galapagos, cu aripile și coada atrofiate (deci **involuție**) din cauza lipsei necesității de zbor (căci ei nu au prădători la sol) și pentru nevoia lor permanentă de a-și scufunda capul în apă, după pește, caracatițe, anghile etc. Sternul lor aviar a dispărut (**involuție**), din moment ce nu le mai erau necesari mușchi de sprijin pentru aripi. Dar gâtul lor a devenit mai lung, picioarele lor mai puternice, cu labe reticulare (**evoluție**), pentru ușurarea prinderii peștilor sub apă. Cu toate acestea, cormoranii nezburători au păstrat mai multe dintre obiceiurile strămoșilor lor (funcționalitate în ansamblu): fac cuiburi, clocesc ouăle etc. (deci **neutralitate**).

2. Exemplul cosmonautului

Astronauții aflați în spațiu pentru o perioadă lungă de timp se acomodează la gravitație redusă sau nulă (**evoluție**), dar își pierd densitatea oaselor (**involuție**). Cu toate acestea, alte părți ale corpului nu se schimbă, sau nu au fost descoperite modificări până în prezent (**neutralitate determinare**).

3. Exemplul de evoluție și involuție al balenelor

Balenele au **evoluat**, în ceea ce privește dinții lor, de la dinți butuci, la dinți ascuțiți. Apoi, balenele au **involuat** de la dinți ascuțiți, la dinți conici neascuțiți.

4. Exemplul pinguinului

Pinguinul din Galapagos (*Spheniscus mendiculus*) s-a diferențiat de pinguinul Humboldt, reducându-și dimensiunea la 35 cm înălțime (adaptare prin **involuție**) pentru a fi în măsură să rămână răcoros în soarele ecuatorial.

5. Exemplul fregatelor

Fregatele din Gal pagos sunt păsări care și-au pierdut abilitatea de a-și obține hrana prin scufundare, dat fiind că penele lor nu sunt impermeabile (**involu ie**), dar au devenit experte în zborul rapid și manevrabil prin furtul de hrană de la alte păsări, adică în hrănirea cleptoparazitică (**evolu ie**).

6. Exemplul Cintezelor lui Darwin

Cele 13 specii din Gal pagos de Cinteze ale lui Darwin manifestă variate grade de evoluție ale ciocului, având forme și dimensiuni diferite pentru fiecare specie, în scopul de a înghiți diferite tipuri de alimente (deci **evolu ie**):

pentru spargerea semințelor tari, un cioc gros (cinteza de sol);

pentru insecte, flori și cactuși, un cioc lung și subțire (alte specii de cintează).

În afară de ciocurile lor, tipurile de cinteze sunt asemănătoare, dovadă că provin dintr-un strămoș comun (deci **neutralitate**).

Să ne imaginăm un experiment. Să presupunem că cintezele de sol cu cioc subțire s-ar muta înapoi într-un mediu înconjurător cu semințe moi, unde nu e nevoie un cioc gros. Atunci, ciocul gros devenind o povară ar trebui să se atrofieze și, în timp, pentru că cintezelor le-ar fi greu să-și folosească ciocul gros greoi, cintezele cu cioc subțire să predomină.

7. Exemplul El Niño

Profesorul de ecologie, etologie și evoluție Martin Wikelski, de la Universitatea Illinois at Urbana – Champaign, a publicat în jurnalul *Nature* un raport curios, privind date pe care le-a colectat împreună cu echipa sa despre iguanele marine începând cu anul 1987. În timpul tsunami-ului El Niño din 1997 – 1998, algele marine au murit, cauzând lipsa hranei iguanelor marinei. Din acest motiv, iguanele marine dintr-o insulă din Gal pagos și-au redus înălțimea cu o pătrime și și-au înjumătățit greutatea (adaptare prin **involu ie**). După ce hrana a fost din nou îndestulătoare, iguanele marine au revenit la lungimea și greutatea originală (re-adaptare prin **evolu ie**).

[J. Smith, J. Brown, *The Incredible Shrinking Iguanas*, Ecuador & The Gal pagos Islands, Moon Handbook, Avalon Travel, p. 325.]

ntrebări deschise despre evolu ie

- 1) Cum să măsurăm evoluția?
- 2) Cum să calculăm gradul de asemănare cu strămoșii, gradul de neasemănare cu strămoșii, și gradul de indeterminare al asemănării - neasemănării cu strămoșii?
- 3) Întrebare experimentală. Să presupunem că populația parțială a unei specii S_1 se mută dintr-un mediu înconjurător 1 către un mediu înconjurător nou 2 ; după un timp, o nouă specie S_2 se naște prin adaptarea la 2 ; apoi, o populație parțială S_2 se mută înapoi din 2 în 1 ; va evolua S_2 înapoi la caracteristicile anterioare (de fapt, va involua) la S_1 ?
- 4) Sunt toate speciile existente astăzi necesare naturii, ori sunt accidente ale naturii?

Summary of the Special Issue “Neutrosophic Information Theory and Applications” at “Information” Journal

Florentin Smarandache, Jun Ye

Florentin Smarandache, Jun Ye (2018). Summary of the Special Issue “Neutrosophic Information Theory and Applications” at “Information” Journal. *Information*, 9, 49; DOI: 10.3390/info9030049

Abstract: Over a period of seven months (August 2017–February 2018), the Special Issue dedicated to “Neutrosophic Information Theory and Applications” by the “Information” journal (ISSN 2078-2489), located in Basel, Switzerland, was a success. The Guest Editors, Prof. Dr. Florentin Smarandache from the University of New Mexico (USA) and Prof. Dr. Jun Ye from the Shaoxing University (China), were happy to select—helped by a team of neutrosophic reviewers from around the world, and by the “Information” journal editors themselves—and publish twelve important neutrosophic papers, authored by 27 authors and coauthors. There were a variety of neutrosophic topics studied and used by the authors and coauthors in Multi-Criteria (or Multi-Attribute and/or Group) Decision-Making, including Cross Entropy-Based MAGDM, Neutrosophic Hesitant Fuzzy Prioritized Aggregation Operators, Biparametric Distance Measures, Pattern Recognition and Medical Diagnosis, Intuitionistic Neutrosophic Graph, NC-TODIM-Based MAGDM, Neutrosophic Cubic Set, VIKOR Method, Neutrosophic Multiple Attribute Group Decision-Making, Competition Graphs, Intuitionistic Neutrosophic Environment, Neutrosophic Commutative N -Ideals, Neutrosophic N -Structures Applied to BCK/BCI-Algebras, Neutrosophic Similarity Score, Weighted Histogram, Robust Mean-Shift Tracking, and Linguistic Neutrosophic Cubic Numbers.

Neutrosophic logic, symbolic logic, set, probability, statistics, etc., are, respectively, generalizations of fuzzy and intuitionistic fuzzy logic and set, classical and imprecise probability, classical statistics, and so on. Neutrosophic logic, symbol logic, and set are gaining significant attention in solving many real-life problems that involve uncertainty, impreciseness, vagueness, incompleteness, inconsistency, and indeterminacy. A number of new neutrosophic theories have been proposed and have been applied in computational intelligence, multiple-attribute decision making, image processing, medical diagnosis, fault diagnosis, optimization design, etc. This *Special Issue* gathers original research papers that report on the state of the art, as well as on recent advancements in neutrosophic information theory in soft computing, artificial intelligence, big and small data mining, decision-making problems, pattern recognition, information processing, image processing, and many other practical achievements.

In the first chapter (*NS-Cross Entropy-Based MAGDM under Single-Valued Neutrosophic Set Environment*), the authors Surapati Pramanik, Shyamal Dalapati, Shariful Alam, Florentin Smarandache, Tapan Kumar Roy propose a new cross entropy measure under a single-valued neutrosophic set (SVNS) environment, namely NS-cross entropy, and prove its basic properties. Additionally, they define the weighted NS-cross entropy measure, investigate its basic properties, and develop a novel multi-attribute group decision-making (MAGDM) strategy that is free from the drawbacks of asymmetrical behavior and undefined phenomena. It is capable of dealing with an unknown weight of attributes and an unknown weight of decision-makers. Finally, a numerical example of multi-attribute

group decision-making problem of investment potential is solved to show the feasibility, validity and efficiency of the proposed decision-making strategy.

Single-valued neutrosophic hesitant fuzzy set (SVNHFS) is a combination of a single-valued neutrosophic set and a hesitant fuzzy set, and its aggregation tools play an important role in the multiple criteria decision-making (MCDM) process. The second paper (*Generalized Single-Valued Neutrosophic Hesitant Fuzzy Prioritized Aggregation Operators and Their Applications to Multiple Criteria Decision-Making*) investigates MCDM problems in which the criteria under SVNHF environment are in different priority levels. First, the generalized single-valued neutrosophic hesitant fuzzy prioritized weighted average operator and generalized single-valued neutrosophic hesitant fuzzy prioritized weighted geometric operator are developed based on the prioritized average operator. Second, some desirable properties and special cases of the proposed operators are discussed in detail. Third, an approach combining the proposed operators and the score function of single-valued neutrosophic hesitant fuzzy element is constructed to solve MCDM problems. Finally, the authors Rui Wang, Yanlai Li provide the example of investment selection to illustrate the validity and rationality of the proposed method.

Single-valued neutrosophic sets (SVNSs) handling the uncertainties characterized by truth, indeterminacy, and falsity membership degrees are a more flexible way of capturing uncertainty. In the third paper (*Some New Biparametric Distance Measures on Single-Valued Neutrosophic Sets with Applications to Pattern Recognition and Medical Diagnosis*), the authors Harish, Garg and Nancy propose some new types of distance measures, overcoming the shortcomings of the existing measures, for SVNSs with two parameters along with their proofs. The various desirable relations between the proposed measures are also derived. A comparison between the proposed and existing measures is performed in terms of counter-intuitive cases for showing its validity. The proposed measures are illustrated with case studies of pattern recognition, as well as medical diagnoses, along with the effect of the different parameters on the ordering of the objects.

A graph structure is a generalization of simple graphs. Graph structures are very useful tools for the study of different domains of computational intelligence and computer science. In the fourth research paper, *Certain Concepts in Intuitionistic Neutrosophic Graph Structures*, the authors Muhammad Akram and Muzzamal Sitara introduce certain notions of intuitionistic neutrosophic graph structures, illustrating these notions with several examples. They investigate some related properties of intuitionistic neutrosophic graph structures, and also present an application of intuitionistic neutrosophic graph structures.

A neutrosophic cubic set is the hybridization of the concept of a neutrosophic set and an interval neutrosophic set. A neutrosophic cubic set has the capacity to express the hybrid information of both the interval neutrosophic set and the single valued neutrosophic set simultaneously. Since the neutrosophic cubic sets have only recently been defined, not much research on the operations and applications of neutrosophic cubic sets is currently available in the literature. In the fifth paper, *NC-TODIM-Based MAGDM under a Neutrosophic Cubic Set Environment*, the authors Surapati Pramanik, Shyamal Dalapati, Shariful Alam and Tapan Kumar Roy propose score and accuracy functions for neutrosophic cubic sets and prove their basic properties. They also develop a strategy for ranking of neutrosophic cubic numbers based on the score and accuracy functions. The authors firstly develop a TODIM (Tomada de decisao interativa e multicritério) in the neutrosophic cubic set (NC) environment, which is called the NC-TODIM. They establish a new NC-TODIM strategy for solving multi-attribute group decision-making (MAGDM) problems in neutrosophic cubic set environments. They illustrate the proposed NC-TODIM strategy for solving a multi-attribute group decision-making problem to show the applicability and effectiveness of the developed strategy. They also conduct sensitivity analysis to show the impact of the ranking order of the alternatives on the different values of the attenuation factor of losses for multi-attribute group decision-making strategies.

In the sixth paper, *VIKOR Method for Interval Neutrosophic Multiple Attribute Group Decision-Making*, the authors Yu-Han Huang, Gui-Wu Wei and Cun Wei extend the VIKOR method to multiple-attribute

group decision-making (MAGDM) with interval neutrosophic numbers (INNs). Firstly, the basic concepts of INNs are briefly presented. The method first aggregates all individual decision-makers' assessment information based on an interval neutrosophic weighted averaging (INWA) operator, and then employs the extended classical VIKOR method to solve MAGDM problems with INNs. The validity and stability of this method are verified by example analysis and sensitivity analysis, and its superiority is illustrated by a comparison with the existing methods.

The concept of intuitionistic neutrosophic sets provides an additional possibility for representing imprecise, uncertain, inconsistent and incomplete information that exists in real situations. The seventh research article (*Certain Competition Graphs Based on Intuitionistic Neutrosophic Environment*) presents the notion of intuitionistic neutrosophic competition graphs. Then, the authors Muhammad Akram and Maryam Nasir discuss p-competition intuitionistic neutrosophic graphs and m-step intuitionistic neutrosophic competition graphs. Further, applications of intuitionistic neutrosophic competition graphs in ecosystem and career competition are described.

The notion of a neutrosophic commutative N-ideal in BCK-algebras is introduced in the eighth paper (*Neutrosophic Commutative N-Ideals in BCK-Algebras*), and several properties are investigated. Relations between a neutrosophic N-ideal and a neutrosophic commutative N-ideal are discussed by the authors Seok-Zun Song, Florentin Smarandache, and Young Bae Jun. Characterizations of a neutrosophic commutative N-ideal are considered.

Neutrosophic N-Structures Applied to BCK/BCI-Algebras is the title of the ninth paper. The notions of a neutrosophic N-subalgebra and a (closed) neutrosophic N-ideal in a BCK/BCI-algebra are introduced by authors Young Bae Jun, Florentin Smarandache and Hashem Bordbar, and several related properties are investigated. Characterizations of a neutrosophic N-subalgebra and a neutrosophic N-ideal are considered, and relations between a neutrosophic N-subalgebra and a neutrosophic N-ideal are stated. The conditions for a neutrosophic N-ideal being a closed neutrosophic N-ideal are provided.

Recently, TODIM has been used to solve multiple attribute decision making (MADM) problems. Single-valued neutrosophic sets (SVNSs) are useful tools for depicting the uncertainty of the MADM. In the tenth paper, *TODIM Method for Single-Valued Neutrosophic Multiple Attribute Decision Making*, Dong-Sheng Xu, Cun Wei and Gui-Wu Wei extend the TODIM method to the MADM with the single-valued neutrosophic numbers (SVNNs). Firstly, the definition, comparison, and distance of SVNNs are briefly presented, and the steps of the classical TODIM method for MADM problems are introduced. Then, an extended classical TODIM method is proposed for dealing with MADM problems with SVNNs, its significant characteristic being that it can fully consider the decision makers' bounded rationality, which is a real factor in decision-making. Furthermore, the authors extend the proposed model to interval neutrosophic sets (INSs). Finally, a numerical example is proposed.

Visual object tracking is a critical task in computer vision. Challenging things always exist when an object needs to be tracked. For instance, background clutter is one of the most challenging problems. The mean-shift tracker is quite popular because of its efficiency and performance under a range of conditions. However, the challenge of background clutter also disturbs its performance. In the eleventh article, *Neutrosophic Similarity Score Based Weighted Histogram for Robust Mean-Shift Tracking*, the authors Keli Hu, En Fan, Jun Ye, Changxing Fan, Shigen Shen and Yuzhang Gu propose a novel weighted histogram based on neutrosophic similarity score to help the mean-shift tracker discriminate the target from the background. The authors utilize the single-valued neutrosophic set (SVNS), which is a subclass of NS, to improve the mean-shift tracker. First, two kinds of criteria are considered—object feature similarity and background feature similarity—and each bin of the weight histogram is represented in the SVNS domain via three membership functions: T(Truth), I(indeterminacy), and F(Falsity). Second, the neutrosophic similarity score function is introduced to fuse those two criteria and to build the final weighted histogram. Finally, a novel neutrosophic weighted mean-shift tracker is proposed. The proposed tracker is compared with several mean-shift-based trackers on a dataset of 61 public sequences. The results reveal that this method outperforms other trackers, especially when confronting background clutter.

To describe both certain linguistic neutrosophic information and uncertain linguistic neutrosophic information simultaneously in the real world, Jun Ye proposes in the twelfth paper (*Linguistic Neutrosophic Cubic Numbers and Their Multiple Attribute Decision-Making Method*) the concept of a linguistic neutrosophic cubic number (LNCN), including an internal LNCN and external LNCN. In LNCN, its uncertain linguistic neutrosophic number consists of the truth, indeterminacy, and falsity uncertain linguistic variables, and its linguistic neutrosophic number consists of the truth, indeterminacy, and falsity linguistic variables to express their hybrid information. Then, the author presents the operational laws of LNCNs and the score, accuracy, and certain functions of LNCN for comparing/ranking LNCNs. Next, the author proposes a LNCN weighted arithmetic averaging (LNCNWAA) operator and a LNCN weighted geometric averaging (LNCNWGA) operator to aggregate linguistic neutrosophic cubic information and discuss their properties. Further, a multiple attribute decision-making method based on the LNCNWAA or LNCNWGA operator is developed under a linguistic neutrosophic cubic environment. Finally, an illustrative example is provided to indicate the application of the developed method.

How to celebrate 24 new year's eves in a single year! *

Florentin Smarandache

Florentin Smarandache (2020). How to celebrate 24 new year's eves in a single year. *Bulletin of Pure and Applied Sciences - Section - E - Mathematics & Statistics* 39E(1), 98-101

Abstract In this paper we explain how a person can celebrate 24 New Year Eves in a single year.

Key words International Date Line, New Year Eve, Geographical Poles, Eastern Hemisphere, Western Hemisphere, Absolute (Mathematical) Time.

1 Introduction

New Year's Eve 2018 reaches us on Jeju Island, South Korea, in the East China Sea, while we had spent New Year's Eve 2017 in Galapagos Islands, in the Pacific.

We can celebrate 24 new year's eves in a single year, moving to the West – for example in an orbital spacecraft - (in the reverse sense of the Earth's rotation around its axis) at a faster angular speed than Earth's rotation, jumping from one time-zone to another, and starting from the *International Date Line*. (In this paper we are referring to the solar day, hence to the angular speed of Earth's rotation on its axis with respect to the Sun.)

But a person being on the Geographical (Terrestrial) North Pole or on the Geographical (Terrestrial) South Pole celebrates the new year eve for 24 hours continuously!!

2 Astronomical data

The *solar day* (time that our planet rotates around its axis, considering the Sun as referential system) is 24 hours, but the *sidereal day* (time that our planet rotates around its axis, but considering the fixed stars as referential system) is 23 hours, 56 minutes, and 4.09 seconds [1, 2].

The rotation from West to East is *counter-clockwise*, as seen from the North Pole Star (*Polaris*).

The Earth's *rotation duration* had and will still be changing over astronomical time (in the last period it was decelerating – making the day to increase from 21 to 24 hours), due to the Moon's gravitational field interacting with the Earth's gravitational field.

Similarly, the Earth's *rotation axis* changes with respect to the planet's crust [*polar motion*], as well as with respect to the fixed stars [*precession* and *nutation*].

Therefore, we may compute two angular velocities:

- (a) With respect to the Sun - as referential system (i.e. when a day = 24 hours = 86,400 seconds), the angular velocity of Earth's rotation on its axis, is: 2π radians/86,400 seconds $\simeq 7.272 \times 10^{-5}$ rad/s.
- (b) And with respect to the fixed stars - as referential system (i.e. when a day = 23 hours, 56 minutes, and 4.09 seconds = 86,164.09 seconds), the angular velocity of Earth's rotation on its axis, is: 2π radians/86,164.09 seconds $\simeq 7.292 \times 10^{-5}$ rad/s.

While the *angular velocities* (with respect to the Sun, or with respect to the fixed stars) are the same for all points on the Earth, the *linear movement* of a point on the equatorial nearly circular orbit {1,669.8 km/h (with respect to the Sun), or 1,674.4 km/h (with respect to the fixed stars)} is bigger in comparison to the linear movement of a point on a different latitude.

3 International date line

The International Date Line (Fig. 1, Fig. 2) starts from the North Pole, passing through the Arctic Ocean, the Bering Strait and the Bering Sea, then through the Pacific, roughly on the 180° meridian, bypassing / leaving Aleutian Islands of Alaska to the east, and zigzagging among a few islands of the Pacific – therefore, less populated areas, cutting Antarctica, and reaching the South Pole.

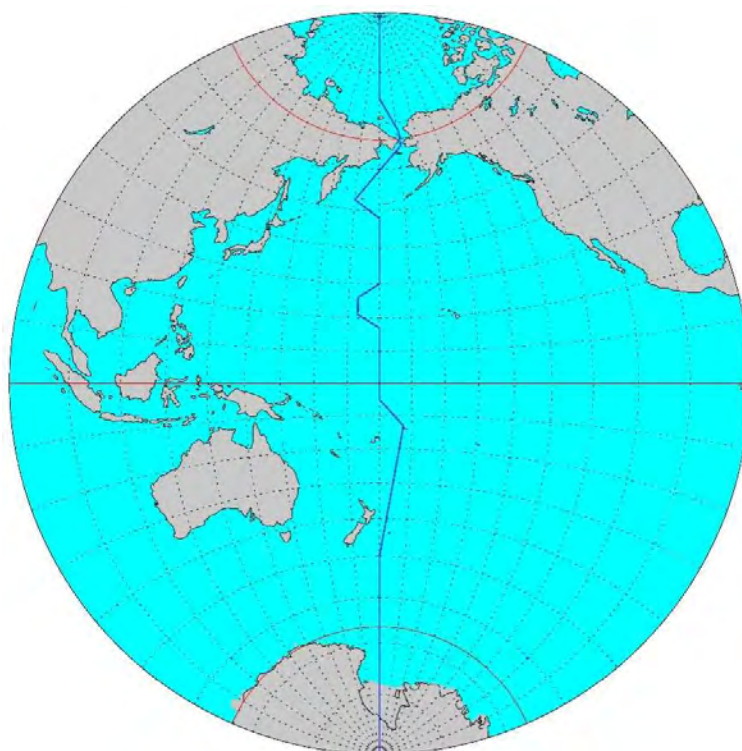

Fig. 1: The International Date Line.

This demarcation line is the first to pass in the new year (roughly 180° meridian), followed by the meridians: 165° East, 150° E, 135° E, 120° E; 105° E, 90° E, 75° E, 60° E, 45° E, 30° E, 15° E, 0°, 15° West, 30° W, 45° W, 60° W, 75° W, 90° W, 105° W, 120° W; 135° W, 150° W, 165° W. Consequently, every New Year is celebrated 24 times. The first to celebrate are the inhabitants of the Pacific Islands: Apia, Nuku'alofa, Funafuti, Suva, and of the remote east of Siberia (Provideniya), and of the Wrangel Island of Siberia. And the last to celebrate it: the inhabitants of the most western

Aleutian islands, plus those in the Pacific islands: Midway, Pago Pago, Alofi, Johnson Atoll, Avalua, Cook Islands.



Fig. 2: The International Date Line.

There are 24 New Year's Eve annually, due to the planetary convention that each time-zone is $2\pi/24 = \pi/12 = 15^\circ$, or, $\frac{360^\circ}{15^\circ} = 24$ time-zones.

In general, if a time-zone has d° , $d > 0$, then there are $\frac{360}{d}$ time-zones, considering d a rational divisor of 360: for example, $d = 10$, $\frac{2}{7}$, $\frac{15}{13}$, etc.

In fact, there is an infinitude of New Year's Eves, because for every meridian between $[0^\circ, 180^\circ \text{ East}]$ and $[0^\circ, 180^\circ \text{ West}]$ respectively, there is a New Year's Eve, namely: $\lim_{d \rightarrow 0^+} \frac{360}{d} = \infty$.

Within 24 hours, from the first to the last, the whole world thus, celebrates the New Year's Eve .

Yet, a person being on the Geographical (Terrestrial) North Pole or on the Geographical (Terrestrial) South Pole celebrates the New Year Ever for 24 hours continuously ([3]), it being well known that the Earth's geographical poles are different from its magnetic poles!

4 Calculating the difference of time-zones

How do we know the difference in time-zones between two cities using Airplanes Timetable (knowing: aircraft's departure time, aircraft's arrival time, and aircraft's flight duration ([4])?)

There are two Earth's hemispheres – the Eastern and the Western. The continents Europe, Asia, Africa and Australia are in the Eastern Hemisphere of the Earth, while in the Western Hemisphere lie the Americas (Northern, Central, and Southern). If the cities are in the same hemisphere (Eastern or Western), the eastern city will be ahead with the time-zone because the Earth rotates around its axis from the West to the East.

Example 4.1. Suppose our plane leaves Chicago at 20:20 and arrives in Albuquerque at 22:25 after 3h 5min of flight. Chicago is east of Albuquerque, so ahead with the time-zone. $20 : 20 + 3 : 05 = 23 : 25$. If it had the same time-zone, then the airplane should have reached Albuquerque at 23:25, not at 22:25. The difference of one hour $23 : 25 - 22 : 25 = 1 : 00$ is precisely the time-zone difference, so Albuquerque is one hour past Chicago.

Example 4.2. The problem is complicated when cities are in different hemispheres. For example, Tokyo is in the Eastern hemisphere and Chicago lies in the Western hemisphere. Suppose our American Airlines plane leaves Tokyo on Monday, January 8th, 2018, at 18:15, and lands in Chicago still on Monday, January 8th, 2018, but at 15:10, after 11h 55min flight hours! How is that possible? So, at about 3 hours back in time!

Instead of considering the *relative time* (the time-zone), we can consider the *absolute (mathematical) time* that is the same all over the globe.

$$18 : 15 + 11 : 55 = 30 : 10.$$

Being in different hemispheres, the Western hemisphere city (Chicago) is behind the Eastern hemisphere city (Tokyo). Since $30 : 10 > 24 : 00$, it does not exist, and we subtract one days (24h). Therefore, $30 : 10 - 24 : 00 = 6 : 10$, in other words, if these two cities had the same time-zone then one would have arrived at 6:10 the following day (January 9th, 2018). and then: $15 : 10 - 6 : 10 = 9 : 00$, that is, the city of Chicago is 9 hours behind Tokyo.

5 Conclusion

In this paper we explain how it is possible for a person to celebrate 24 New Year' Eves within a single year, and that somebody staying on the North or South Pole celebrates the New Year Eve for 24 hours continuously!

References

- [1] (1961). World Book Encyclopedia Vol 5, Field Enterprises Educational Corporation, Illinois, 13.
- [2] Serway, Raymond A., Beichner, Robert J. and Jewett, John W. (2000). Physics for Scientists and Engineers with Modern Physics: Fifth Edition, Saunders College Publishing, Orlando, FL, 317 Q10.
- [3] Smarandache, Florentin (2018). *Ocolul Pmntului cu Avionul*, Editura Agora, Sibiu.
- [4] Smarandache, Florentin (2018). *Pe Drumuri Neutrosofice Pakistaneze*, Editura Agora, Sibiu.

Within the Lack of Chest COVID-19 X-ray Dataset: A Novel Detection Model Based on GAN and Deep Transfer Learning

Mohamed Loey, Florentin Smarandache Nour Eldeen M. Khalifa

Mohamed Loey, Florentin Smarandache, Nour Eldeen M. Khalifa (2020). Within the Lack of Chest COVID-19 X-ray Dataset: A Novel Detection Model Based on GAN and Deep Transfer Learning. *Symmetry* 12, 651; DOI: 10.3390/sym12040651

Abstract: The coronavirus (COVID-19) pandemic is putting healthcare systems across the world under unprecedented and increasing pressure according to the World Health Organization (WHO). With the advances in computer algorithms and especially Artificial Intelligence, the detection of this type of virus in the early stages will help in fast recovery and help in releasing the pressure off healthcare systems. In this paper, a GAN with deep transfer learning for coronavirus detection in chest X-ray images is presented. The lack of datasets for COVID-19 especially in chest X-rays images is the main motivation of this scientific study. The main idea is to collect all the possible images for COVID-19 that exists until the writing of this research and use the GAN network to generate more images to help in the detection of this virus from the available X-rays images with the highest accuracy possible. The dataset used in this research was collected from different sources and it is available for researchers to download and use it. The number of images in the collected dataset is 307 images for four different types of classes. The classes are the COVID-19, normal, pneumonia bacterial, and pneumonia virus. Three deep transfer models are selected in this research for investigation. The models are the Alexnet, Googlenet, and Restnet18. Those models are selected for investigation through this research as it contains a small number of layers on their architectures, this will result in reducing the complexity, the consumed memory and the execution time for the proposed model. Three case scenarios are tested through the paper, the first scenario includes four classes from the dataset, while the second scenario includes 3 classes and the third scenario includes two classes. All the scenarios include the COVID-19 class as it is the main target of this research to be detected. In the first scenario, the Googlenet is selected to be the main deep transfer model as it achieves 80.6% in testing accuracy. In the second scenario, the Alexnet is selected to be the main deep transfer model as it achieves 85.2% in testing accuracy, while in the third scenario which includes two classes (COVID-19, and normal), Googlenet is selected to be the main deep transfer model as it achieves 100% in testing accuracy and 99.9% in the validation accuracy. All the performance measurement strengthens the obtained results through the research.

Keywords: 2019 novel coronavirus; deep transfer learning; machine learning; COVID-19; SARS-CoV-2; convolutional neural network; GAN

1. Introduction

In 2019, Wuhan is a commercial center of Hubei province in China that faced a flare-up of a novel 2019 coronavirus that killed more than hundreds and infected over thousands of individuals within the initial days of the novel coronavirus pestilence. The Chinese researchers named the novel virus as the 2019 novel coronavirus (2019-nCov) or the Wuhan virus [1]. The International Committee of Viruses titled the virus of 2019 as the Severe Acute Respiratory Syndrome CoronaVirus-2 (SARS-CoV-2) and the malady as Coronavirus disease 2019 (COVID-19) [2-4]. The subgroups of the coronaviruses family are alpha-CoV (α), beta-CoV (β), gamma-CoV (δ), and delta-CoV (γ) coronavirus. SARS-CoV-2 was announced to be an organ of the beta-CoV (β) group of coronaviruses. In 2003, the Kwangtung people were infected with a 2013 virus lead to the Severe Acute Respiratory Syndrome (SARS-CoV). SARS-CoV was assured as a family of the beta-CoV (β) subgroup and was title as SARS-CoV [5]. Historically, SRAS-CoV, across 26 countries in the world, infected more than 8000 individuals with a death rate of 9%. Moreover, SARS-CoV-2 infected more than 750,000 individuals with a death rate of 4%, across 150 states, untill the date of this lettering. It demonstrates that the broadcast rate of SARS-CoV-2 is higher than SRAS-CoV. The transmission ability is enhanced because of authentic recombination of S protein in the RBD region [6].

Beta-coronaviruses have caused malady to people that have had wild animals generally either in bats or rats [7,8]. SARS-CoV-1 and MERS-CoV (camel flu) were transmitted to people from some wild cats and Arabian camels respectively as shown in Figure 1. The sale and buy of unknown animals may be the provenance of coronavirus infection. The invention of the various progeny of pangolin coronavirus and their propinquity to SARS-CoV-2 suggests that pangolins should be a thinker as possible hosts of novel 2019 coronaviruses. Wild animals must be taken away from wild animal markets to stop animal coronavirus transmission [9]. Coronavirus transmission has been assured by World Health Organization (WHO) and by The Centers for Diseases of the US, with evidence of human-to-human conveyance from five different cases outside China, namely in Italy [10], US [11], Nepal [12], Germany [13], and Vietnam [14]. On 31 March 2020, SARS-CoV-2 confirmed more than 750,000 cases, 150,000 recovered cases, and 35,000 death cases. Table 1 show some statistics about SARS-CoV-2 [15].

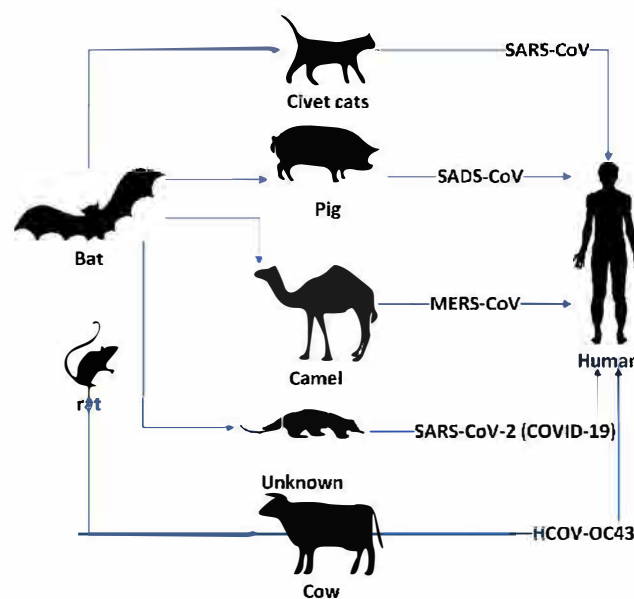

Figure 1. Coronavirus transmission from animals to humans.

Table 1. SARS-CoV-2 statistics in some countries.

Location	Confirmed	Recovered	Deaths
United States	164,345	5,945	3,171
Italy	101,739	14,620	11,591
Spain	94,417	19,259	8,269
China	81,518	76,052	3305
Germany	67,051	7635	682
Iran	44,606	14,656	2898
France	43,973	7202	3018
United Kingdom	22,141	135	1408

1.1. Deep Learning

Nowadays, Deep Learning (DL) is a subfield of machine learning concerned with techniques inspired by neurons of the brain [16]. Today, DL is quickly becoming a crucial technology in image/video classification and detection. DL depends on algorithms for reasoning process simulation and data mining, or for developing abstractions [17]. Hidden deep layers on DL maps input data to labels to analyze hidden patterns in complicated data [18]. Besides their use in medical X-ray recognition, DL architectures are also used in other areas in the application of image processing and computer vision in medical. DL improves such a medical system to realize higher outcomes, widen illness scope, and implementing applicable real-time medical image [19,20] disease detection systems. Table 2 shows a series of major contributions in the field of the neural network to deep learning [21].

Table 2. Major contributions in the history of the neural network to deep learning [21,22].

Milestone/Contribution	Year
McCulloch-Pitts Neuron	1943
Perceptron	1958
Backpropagation	1974
Neocognitron	1980
Boltzmann Machine	1985
Restricted Boltzmann Machine	1986
Recurrent Neural Networks	1986
Autoencoders	1987
LeNet	1990
LSTM	1997
Deep Belief Networks	2006
Deep Boltzmann Machine	2009

1.2. Generative Adversarial Network

Generative Adversarial Network (GAN) is a class of deep learning models invented by Ian Goodfellow in 2014 [23]. GAN models have two main networks, called the generative network and discriminative network. The first neural network is the generator network, responsible for generating new fake data instances that look like training data. The discriminator tries to distinguish between real data and fake (artificially generated) data generated by the generator network as shown in Figure 2. The mission GANs models that generator network is to try fooling the discriminator network and the discriminator network tries to fight from being fooled [24–27].

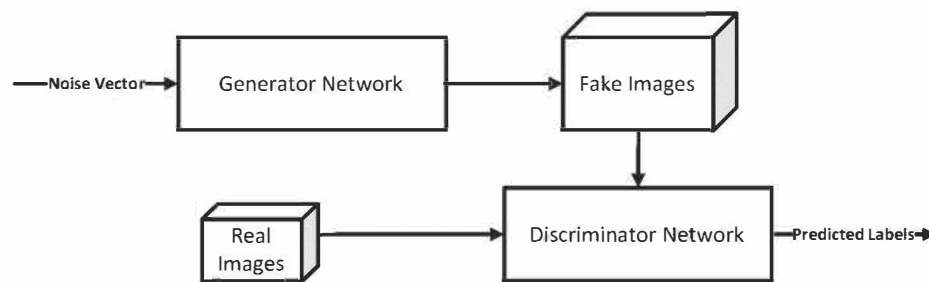

Figure 2. Generative Adversarial Network model.

1.3. Convolution Neural Networks

Convolutional Neural Networks (ConvNets or CNNs) are a category of deep learning techniques used primarily to recognize and classify the image. Convolutional Neural Networks have accomplished extraordinary success for medical image/video classification and detection. In 2012, Ciregan et al. and Krizhevsky and et al. [28,29] showed how CNNs based on Graphics Processing Unit (GPU) can enhance many vision benchmark records such as MNIST [30], Chinese characters [31], Arabic digits recognition [32], Arabic handwritten characters recognition [33], NORB (jittered, cluttered) [34], traffic signs [35], and large-scale ImageNet [36] benchmarks. In the following years, various advances in ConvNets further increased the accuracy rate on the image detection/classification competition tasks. ConvNets pre-trained models introduced significant improvements in succeeding in the annual challenges of ImageNet Large Scale Visual Recognition Competition (ILSVRC). Deep Transfer Learning (DTL) is a deep learning (DL) model that focuses on storing weights gained while solving one image classification and applying it to a related problem. Many DTL models were introduced like VGGNet [37], GoogleNet [38], ResNet [39], Xception [40], Inception-V3 [41] and DenseNet [42].

The novelty of this paper is conducted as follows: i) the introduced ConvNet models have end-to-end structure without classical feature extraction and selection methods. ii) We show that GAN is an effective technique to generate X-ray images. iii) Chest X-ray images are one of the best tools for the classification of SARS-CoV-2. iv) The deep transfer learning models have been shown to yield very high outcomes in the small dataset COVID-19. The rest of the paper is organized as follows. Section 2 explores related work and determines the scope of this works. Section 3 discusses the dataset used in our paper. Section 4 presents the proposed models, while Section 5 illustrates the achieved outcomes and its discussion. Finally, Section 6 provides conclusions and directions for further research.

2. Related Works

This part conducts a survey on the recent scientific researches for applying machine learning and deep learning in the field of medical pneumonia and coronavirus X-ray classification. Classical image classification stages can be divided into three main stages: image preprocessing, feature extraction, and feature classification. Stephen et al. [43] proposed a new study of classifying and detect the presence of pneumonia from a collection of chest X-ray image samples based on a ConvNet model trained from scratch based on dataset [44]. The outcomes obtained were training loss = 12.88%, training accuracy = 95.31%, validation loss = 18.35%, and validation accuracy = 93.73%.

In [45], the Authors introduced an early diagnosis system from Pneumonia chest X-ray images based on Xception and VGG16. In this study, a database containing approximately 5800 frontal chest X-ray images introduced by Kermany et al [44] 1600 normal case, 4200 up-normal pneumonia case in the Kermany X-ray database. The trial outcomes showed that VGG-16 network better than X-ception network with a classification rate of 87%. Forasmuch X-ception network better than VGG-16 network by sensitivity 85%, precision 86% and recall 94%. X-ception network is more felicitous for classifying X-ray images than VGG-16 network. Varshni et al. [46] proposed pre-trained ConvNet models (VGG-16, Xception, Res50, Dense-121, and Dense-169) as feature-extractors followed by different classifiers

(SVM, Random Forest, k-nearest neighbors, Naïve Bayes) for the detection of normal and abnormal pneumonia X-rays images. The prosaists used ChestX-ray14 introduced by Wang et al. [47].

Chouhan et al. [48] introduced an ensemble deep model that combines outputs from all transfer deep models for the classification of pneumonia using the connotation of deep learning. The Guangzhou Medical Center [44] database introduced a total of approximately 5200 X-ray images, divided to 1300 X-ray normal, 3900 X-rays abnormal. The proposed model reached a miss-classification error of 3.6% with a sensitivity of 99.6% on test data from the database. Ref. [49] proposed a Compressed Sensing (CS) with a deep transfer learning model for automatic classification of pneumonia on X-ray images to assist the medical physicians. The dataset used for this work contained approximately 5850 X-ray data of two categories (abnormal /normal) obtained from Kaggle. Comprehensive simulation outcomes have shown that the proposed approach detects the classification of pneumonia (abnormal /normal) with 2.66% miss-classification.

In this research, we introduced a transfer of deep learning models to classify COVID-19 X-ray images. To input adopting X-ray images of the chest to the convolutional neural network, we embedded the medical X-ray images using GAN to generate X-ray images. After that, a classifier is used to ensemble the outputs of the classification outcomes. The proposed transfer model was evaluated on the proposed dataset.

3. Dataset

The COVID-19 dataset [50] utilized in this research [51] was created by Dr. Joseph Cohen, a postdoctoral fellow at the University of Montreal. The Pneumonia [44] dataset Chest X-ray Images was used to build the proposed dataset. The dataset [52] is organized into two folders (train, test) and contains sub-folders for each image category (COVID-19/normal/pneumonia bacterial/ pneumonia virus). There are 306 X-ray images (JPEG) and four categories (COVID-19/normal/pneumonia bacterial/ pneumonia virus). The number of images for each class is presented in Table 3. Figure 3 illustrates samples of images used for this research. Figure 4 also illustrates that there is a lot of variation of image sizes and features that may reflect on the accuracy of the proposed model which will be presented in the next section.

Table 3. Number of images for each class in the COVID-19 dataset.

Dataset/Class	Covid	Normal	Pneumonia_bac	Pneumonia_vir	Total
Train	60	70	70	70	270
Test	9	9	9	9	36
Total	69	79	79	79	306

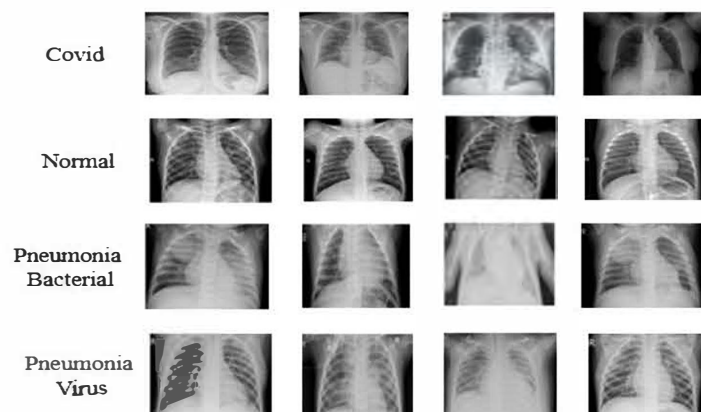

Figure 3. Samples of the used images in this research.

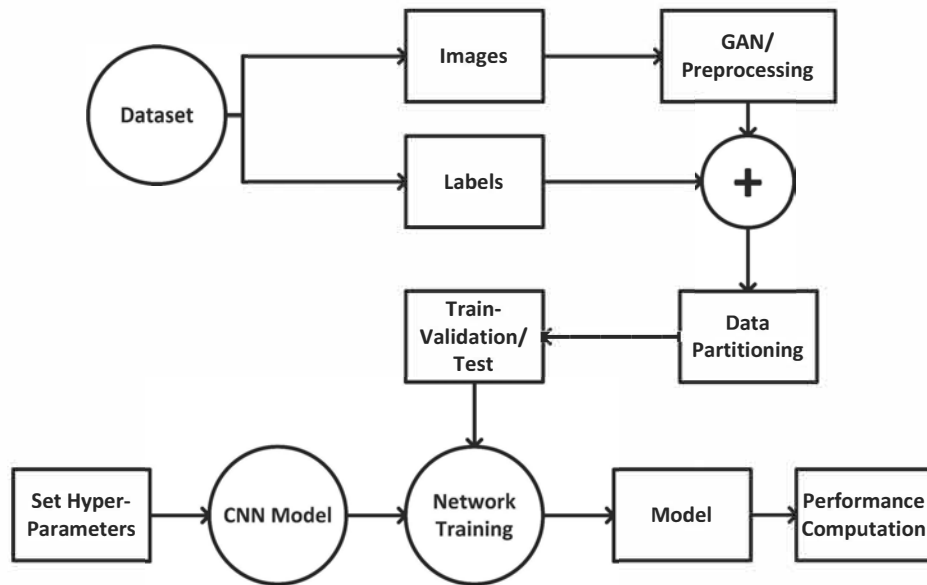

Figure 4. The proposed GAN/deep transfer learning mode.

4. The Proposed Model

The proposed model includes two main deep learning components, the first component is GAN and the second component is the deep transfer model. Figure 4 illustrates the proposed GAN/Deep transfer learning model. Mainly, the GAN used for the preprocessing phase while the deep transfer model used in the training, validation and testing phase.

Algorithm 1 introduces the proposed transfer model in detail. Let $D = \{\text{Alexnet, Googlenet, Resnet18}\}$ be the set of transfer models. Each deep transfer model is fine-tuned with the COVID-19 X-ray Images dataset (X, Y) ; where X the set of N input data, each of size, $512 \text{ lengths} \times 512 \text{ widths}$, and Y have the identical class, $Y = \{y/y \in \{\text{COVID-19; normal; pneumonia bacterial; pneumonia virus}\}\}$. The dataset divided to train and test, training set $(X_{\text{train}}; Y_{\text{train}})$ for 90% percent for the training and then validation while 10% percent for the testing. The 90% percent was divided into 80% for training and 20% for the validation. The selection of 80% for the training and 20% in the validation proved it is efficient in many types of research such as [53–57]. The training data then divided into mini-batches, each of size $n = 64$, such that $(X_q; Y_q) \in (X_{\text{train}}; Y_{\text{train}}); q = 1, 2, \dots, \frac{N}{n}$ and iteratively optimizes the DCNN model $d \in D$ to reduce the functional loss as illustrated in Equation (1).

$$C(w, X_i) = \frac{1}{n} \sum_{x \in X_i, y \in Y_i} c(d(x, w), y), \tag{1}$$

where $d(x, w)$ is the ConvNet model that true label y for input x given w is a weight and $c(\cdot)$ is the multi-class entropy loss function.

This research relied on the deep transfer learning CNN architectures to transfer the learning weights to reduce the training time, mathematical calculations and the consumption of the available hardware resources. There are several types of research in [53,58,59] tried to build their architecture, but those architecture are problem-specific and cannot fit the data presented in this paper. The used deep transfer learning CNN models investigated in this research are Alexnet [29], Resnet18 [39], Googlenet [60], The mentioned CNN models had a few numbers of layers if it is compared to large CNN models such as Xception [40], Densenet [42], and Inceptionresnet [61] which consist of 71, 201 and 164 layers accordingly. The choice of these models will reflect on reducing the training time and the complexity of the calculations.

Algorithm 1 Introduced algorithm.

```

1:  Input data: COVID-19 Chest X-ray Images  $(X, Y)$ ; where  $Y = \{y/y \in \{\text{COVID-19; normal; pneumonia bacterial; pneumonia virus}\}$ 
2:  Output data: The transfer model that detected the COVID-19 Chest X-ray image  $x \in X$ 
3:  Pre-processing steps:
4:  modify the X-ray input to dimension 512 height  $\times$  512 width
5:  Generate X-ray images using GAN
6:  Mean normalize each X-ray data input
7:  download and reuse transfer models  $D = \{\text{Alexnet, Googlenet, Resnet18}\}$ 
8:  Replace the last layer of each transfer model by  $(4 \times 1)$  layer dimension.
9:  foreach  $\forall d \in D$  do
10:  $\mu = 0.01$ 
11: for epochs = 1 to 20 do
12: foreach mini-batch  $(X_i; Y_i) \in (X_{\text{train}}; Y_{\text{train}})$  do
      Modify the coefficients of the transfer  $d(\cdot)$ 
      if the error rate is increased for five epochs then
           $\mu = \mu \times 0.01$ 
      end
    end
13: end
14: end
15: foreach  $\forall x \in X_{\text{test}}$  do
16: the outcome of all transfer architectures,  $d \in D$ 
17: end

```

4.1. Generative Adversarial Network

GANs consist of two different types of networks. Those networks are trained simultaneously. The first network is trained on image generation while the other is used for discrimination. GANs are considered a special type of deep learning models. The first network is the generator, while the second network is the discriminator. The generator network in this research consists of five transposed convolutional layers, four ReLU layers, four batch normalization layers, and Tanh Layer at the end of the model, while the discriminator network consists of five convolutional layers, four leaky ReLU, and three batch normalization layers. All the convolutional and transposed convolutional layers used the same window size of 4×4 pixel with 64 filters for each layer. Figure 5 presents the structure and the sequence of layers of the GAN network proposed in this research.

The GAN network helped in overcoming the overfitting problem caused by the limited number of images in the dataset. Moreover, it increased the dataset images to be 30 times larger than the original dataset. The dataset number of images reached 8100 images after using the GAN network for 4 classes. This will help in achieving a remarkable testing accuracy and performance matrices. The achieved results will be deliberated in detail in the experimental outcomes section. Figure 6 presents samples of the output of the GAN network for the COVID-19 class.

Generator Network	Input	Discriminator Network	Input
	Transposed Convolution 1		Convolution 1
	Batch Normalization 1		Leaky ReLU 1
	ReLU 1		Convolution 2
	Transposed Convolution 2		Batch Normalization 2
	Batch Normalization 3		Leaky ReLU 2
	ReLU 2		Convolution 3
	Transposed Convolution 3		Batch Normalization 3
	Batch Normalization 3		Leaky ReLU 3
	ReLU 3		Convolution 4
	Transposed Convolution 4		Batch Normalization 4
	Batch Normalization 4		Leaky ReLU 4
	ReLU 4		Convolution 5
	Transposed Convolution 5		
	Tanh		

Figure 5. The structure and the sequence of layers for the proposed GAN network.

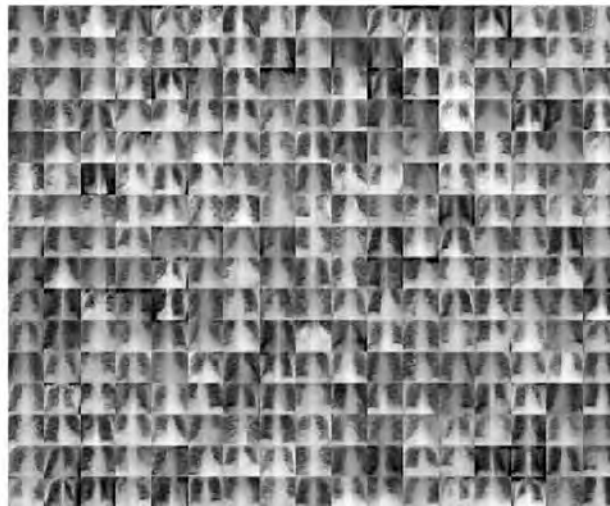

Figure 6. Samples of images generated using the proposed GAN structure.

4.2. Deep Transfer Learning

Convolutional Neural Networks (ConvNet) is the most successful type of model for image classification and detection. A single ConvNet model contains many different layers of neural networks that work on labeling edges and simple/complex features on neural network layers and more complex deep features in deeper network layers. An image is convolved with filters (kernels) and then max pooling is applied, this process may go on for some layers and at last recognizable features are obtained. Take the size of $W^{l-1} \times H^{l-1} \times C^{l-1}$ (where $W \times H$ is width \times height) feature map and a filterbank in layer $l - 1$ for example within C^l kernels at the size of $f^l \times C^{l-1}$, augmenting the other two coefficients stride s^l and padding p^l , the outcome feature box in layer l is $W^l \times H^l \times C^l$ as shown in Equation (2):

$$(W^l, H^l) = \left\lfloor \frac{(W^{l-1} \times H^{l-1}) + 2p^l - f^l}{s^l} + 1 \right\rfloor, \tag{2}$$

where $\lfloor \cdot \rfloor$ indicate to floor math. Kernels must be equal to that of the input map. as in Equation (3):

$$x_j^l = \sigma \left(\sum_{i \in V_j} x_j^{l-1} \times f_{ij}^l + b_j^l \right), \tag{3}$$

where i and j are indexes of input/output network maps at a range of $W^l \times H^l$ and $W^{l-1} \times H^{l-1}$ respectively. V_j here indicates the receptive field of kernel and b_j^l is the bias term. In equation (3), $\sigma(\cdot)$ is a non-linearity function applied to get non-linearity in deep transfer learning. In our transfer method, we used ReLU in equation (4) as the non-linearity function for rapid training process:

$$\sigma(x_{input}) = \max(0, x_{input}). \tag{4}$$

Our cost function in Equation (5):

$$L(s, t) = L_{cls}(s_{c^*}) + \lambda[p^* > 0]L_{reg}(g, g^*), \tag{5}$$

where s_{c^*} is output label c^* while g and g^* denote $[g_x, g_y, g_w, g_h]$ of bounding boxes. $\lambda[p^* > 0]$ consider the boxes of non-background (if $p^* = 0$ is background). This cost function have detection loss L_{cls} and regression loss L_{reg} , in Equations (6)–(8):

$$L_{cls}(s_{c^*}) = -\log(s_{c^*}) \tag{6}$$

and

$$L_{reg}(g, g^*) = \sum_{i \in \{x, y, w, h\}} R_{L1}(g_i - g_i^*) \tag{7}$$

where:

$$R_{L1}(x) = \begin{cases} 0.5x^2, & \text{if } |x| < 0 \\ |x| - 0.5, & \text{otherwise} \end{cases} \tag{8}$$

In terms of optimizer technique, the momentum Stochastic Gradient Descent (SGD) [62] with momentum 0.9 is chosen as our optimizer technique, which updates weights parameters. This optimizer technique updates the weights of the gradient at the previous iteration and fine-tuning of the gradient. To bypass deep learning network overfitting problems, we utilize this problem by using the dropout technique [63] and the early-stopping technique [64] to select the best training steps. As to the learning rate policy, the step size technique is performed in SGD. We introduced the learning rate (μ) to 0.01 and the number of iterations to be 2000. The mini-batch size is set to 64 and early-stopping to be five epochs if the accuracy did not improve.

5. Experimental Results

The introduced model was coded using a software package (MATLAB). The development was CPU specific. All outcomes were conducted on a computer server equipped by an Intel Xeon processor (2 GHz), 96 GB of RAM. The proposed model has been tested under three different scenarios, the first scenario is to test the proposed model for 4 classes, the second scenario for three classes and the third one for two classes. All the test experiment scenarios included the COVID-19 class. Every scenario consists of the validation phase and the testing phase. In the validation phase, 20% of total generated images will be used while in the testing phase consists of around 10% from the original dataset will be used.

The main difference between the validation phase and testing phase accuracy is in the validation phase, the data used to validate the generalization ability of the model or for the early stopping, during the training process. In the testing phase, the data used for other purposes other than training and validating. The data used in training, validation, and testing never overlap with each other to build a concrete result about the proposed model.

Before listing the major results of this research, Table 4 presents the validation and the testing accuracy for four classes before using GAN as an image augmenter. The presented results in Table 4 show that the validation and testing accuracy is quite low and not acceptable as a model for the detection of coronavirus.

Table 4. Validation and testing accuracy for 4 classes according to 3 deep transfer learning models without using GAN.

Model/Validation-Testing Accuracy	ALexnet	Googlenet	Resnet18
Validation Accuracy	73.1%	76.9%	67.3%
Testing Accuracy	52.0%	52.8%	50.0%

5.1. Verification and Testing Accuracy Measurement

Testing accuracy is one of the estimations which demonstrates the precision and the accuracy of any proposed models. The confusion matrix also is one of the accurate measurements which give more insight into the achieved validation and testing accuracy. First, the four classes scenario will be investigated with the three types of deep transfer learning which include Alexnet, Googlenet, and Resnet18. Figures 7–9 illustrates the confusion matrices for the validation and testing phases for four classes in the dataset.

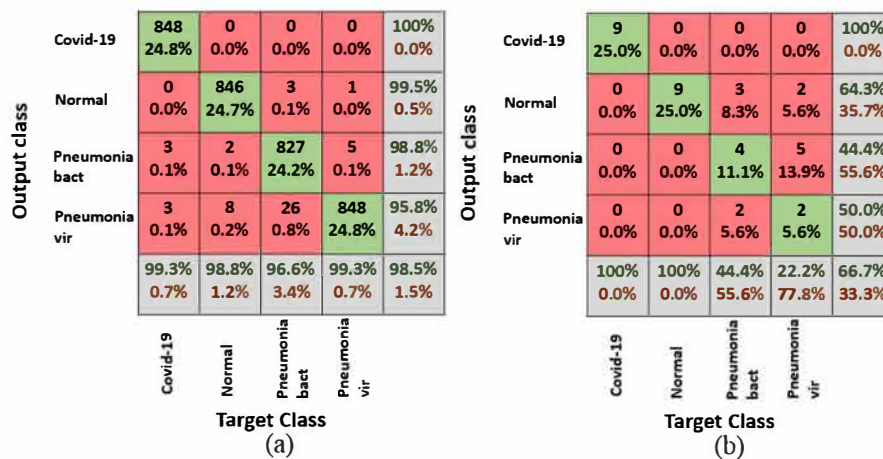

Figure 7. Confusion matrices of Alexnet for 4 classes (a) validation accuracy, and (b) testing accuracy.

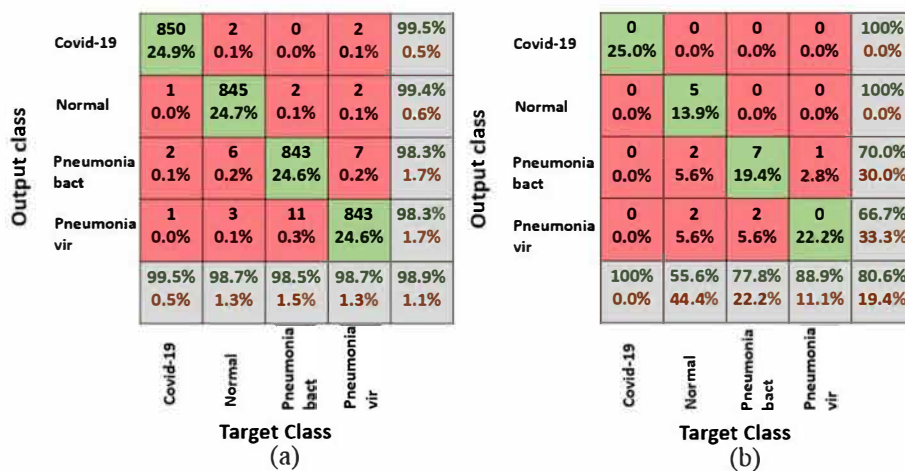

Figure 8. Confusion matrices of Googlenet for 4 classes (a) validation accuracy, and (b) testing accuracy.

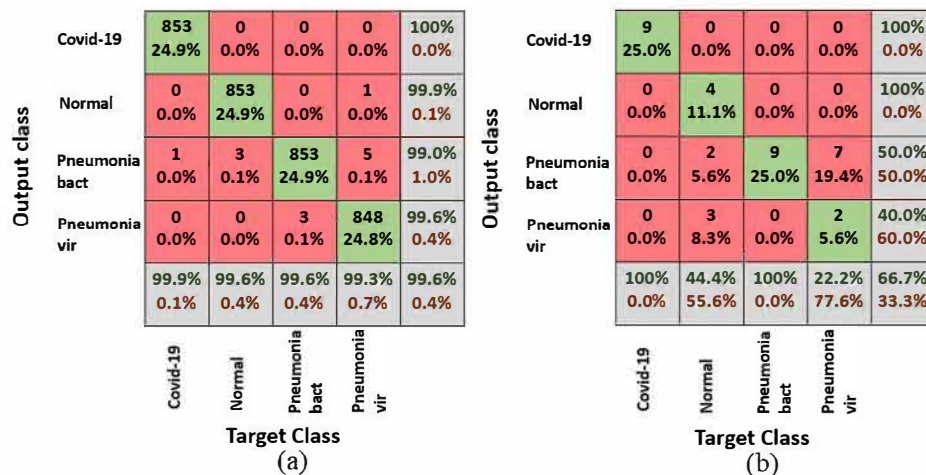

Figure 9. Confusion matrices of Resnet18 for 4 classes (a) validation accuracy, and (b) testing accuracy.

Table 5 summarizes the validation and the testing accuracy for the different deep transfer models for four classes. The table illustrates according to validation accuracy, the Resnet18 achieved the highest accuracy with 99.6%, this is due to the large number of parameters in the Resnet18 architecture which contains 11.7 million parameters which are not larger than Alexnet but the Alexnet only include 8 layers while the Resnet18 includes 18 layers. According to testing accuracy, the Googlenet achieved the highest accuracy with 80.6%, this is due to a large number of layers if it is compared to other models as it contains about 22 layers.

Table 5. Validation and testing accuracy for 4 classes according to 3 deep transfer learning models.

Model/Validation-Testing Accuracy	ALexnet	Googlenet	Resnet18
Validation Accuracy	98.5%	98.9%	99.6%
Testing Accuracy	66.7%	80.6%	66.7%

The second scenario to be tested in this research when the dataset only contains three classes. Figures 10–12 illustrate the confusion matrices for the validation and testing phases for three classes in the dataset including the Covid class.

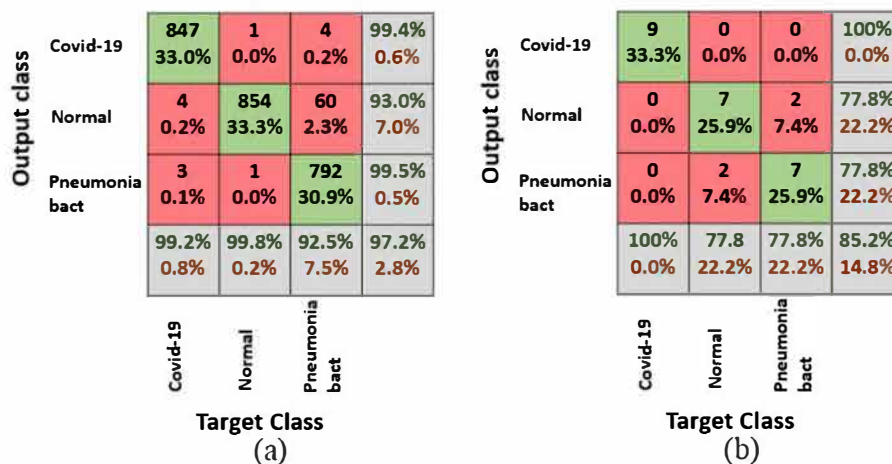

Figure 10. Confusion matrices of Alexnet for 3 classes (a) validation accuracy, and (b) testing accuracy.

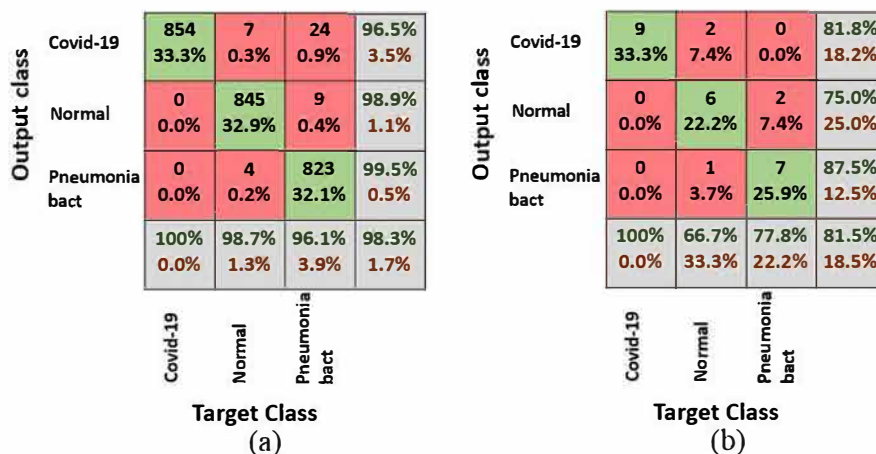

Figure 11. Confusion matrices of GoogLeNet for 3 classes (a) validation accuracy, and (b) testing accuracy.

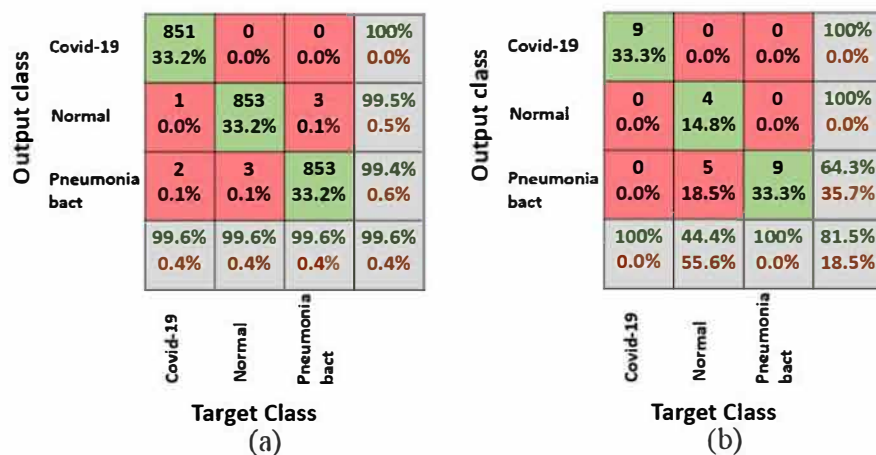

Figure 12. Confusion matrices of Resnet18 for 3 classes (a) validation accuracy, and (b) testing accuracy.

Table 6 summarizes the validation and the testing accuracy for the different deep transfer models for 3 classes. The table illustrates according to validation accuracy, the Resnet18 achieved the highest accuracy with 99.6%. According to testing accuracy, the Alexnet achieved the highest accuracy with 85.2%, this is maybe due to the large number of parameters in the Alexnet architecture which include 61 million parameters and also due to the elimination of the fourth class which include the pneumonia virus which has similar features if it is compared to COVID-19 which is also considered a type of pneumonia virus. The elimination of the pneumonia virus helps in achieving better testing accuracy for the all deep transfer model than when it is trained over four classes as mentioned before as COVID-19 is a special type of pneumonia virus.

Table 6. Validation and testing accuracy for 3 classes according to 3 deep transfer learning models.

Model/Validation-Testing Accuracy	ALexnet	GoogLeNet	Resnet18
Validation Accuracy	97.2%	98.3%	99.6%
Testing Accuracy	85.2%	81.5%	81.5%

The third scenario to be tested when the dataset only includes two classes, the covid class, and the normal class. Figure 13 illustrates the confusion matrix for the three different transfer models for validation accuracy, While the confusion matrix for testing accuracy is presented in Figure 14 which is the same for all the deep transfer models selected in this research.

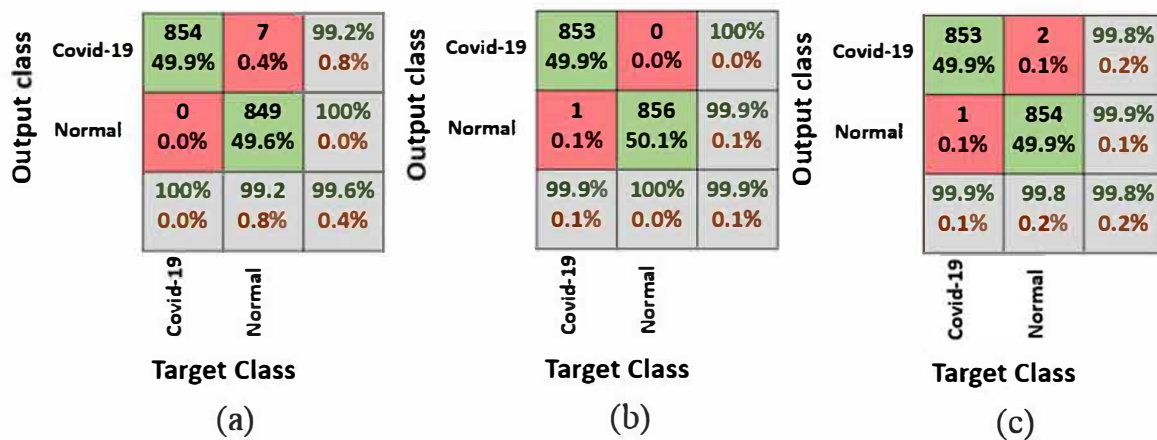

Figure 13. Confusion matrices the verification accuracy for (a) Alexnet, (b) Googlenet, and (c) Resnet.

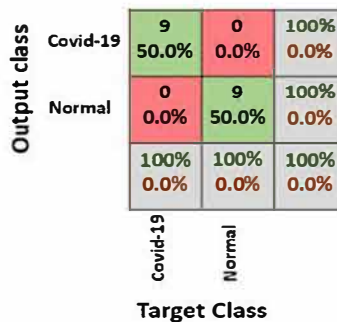

Figure 14. Confusion matrix for testing accuracy for Alexnet, Googlenet, and Resnet18.

Table 7 summarizes the validation and the testing accuracy for the different deep transfer models for two classes. The table illustrates according to validation accuracy, the Googlenet achieved the highest accuracy with 99.9%. According to testing accuracy, all the pre-trained model Alexnet, Goolgenet, and Resnet18 achieved the highest accuracy with 100%, This due to the elimination of the third and the fourth class which includes pneumonia bacterial and pneumonia virus which has similar features if it is compared to COVID-19. This leads to a noteworthy enhancement in the testing accuracy which reflects on whatever the deep transfer model will be used the testing accuracy will reach 100%. The choice of the best model here will be according to validation accuracy which achieved 99.9%. So the Googlenet will be the selected deep transfer model in the third scenario.

Table 7. Validation and testing accuracy for 2 classes according to 3 deep transfer learning models.

Model/Validation-Testing Accuracy	ALexnet	Googlenet	Resnet18
Validation Accuracy	99.6%	99.9%	99.8%
Testing Accuracy	100%	100%	100%

To conclude this part, every scenario has it is own deep transfer model. In the first scenario, Googlenet was selected, while the second scenario, Alexnet was selected, and finally, in the third scenario, Googlenet was selected as a deep transfer model. To draw a full conclusion for the selected deep transfer learning that fit the dataset and all scenarios, testing accuracy for every class is required for the different deep transfer model. Table 7 presents the testing accuracy for every class for the different three scenarios. Table 8 does not help much to determine the deep transfer model that fits all scenarios but for the distinction of COVID-19 class among the other classes, Alexnet and Resent18 will be the selected as deep transfer model as they achieved 100% testing accuracy for COVID-19 class whatever the number of classes is 2,3 or 4.

Table 8. Testing accuracy for every class for the different 3 scenarios.

# of Classes	Class Name	Alexnet	Googlenet	Resnet18
4 classes	Covid	100%	100%	100%
	Normal	64.3%	100%	100%
	Pneumonia _bac	44.4%	70%	50%
	Pneumonia _vir	50%	66.7%	40%
3 classes	Covid	100%	81.8%	100%
	Normal	77.7%	75.0%	100%
	Pneumonia _bac	77.8%	87.5%	64.3%
2 classes	Covid	100%	100%	100%
	Normal	100%	100%	100%

5.2. Performance Evaluation and Discussion

To estimate the performance of the proposed model, extra performance matrices are required to be explored through this study. The most widespread performance measures in the field of deep learning are Precision, Sensitivity (recall), F1 Score [65] and they are presented from Equation (9) to Equation (11).

$$\text{Precision} = \frac{\text{TrueP}}{(\text{TrueP} + \text{FalseP})} \tag{9}$$

$$\text{Sensitivity} = \frac{\text{TrueP}}{(\text{TrueP} + \text{FalseN})} \tag{10}$$

$$\text{F1Score} = 2 * \frac{\text{Precision} * \text{Sensitivity}}{(\text{Precision} + \text{Sensitivity})} \tag{11}$$

where TrueP is the count of true positive samples, TrueN is the count of true negative samples, FalseP is the count of false positive samples, and FalseN is the count of false negative samples from a confusion matrix.

Table 9 presents the performance metrics for different scenarios and deep transfer models for the testing accuracy. The table illustrates that in the first scenario which contains four classes, Googlenet achieved the highest percentage for precision, sensitivity and F1 score metrics which strengthen the research decision for choosing Googlenet as a deep transfer model. The table also illustrates that in the second scenario which contains three classes, Alexnet achieved the highest percentage for precision and recall score metrics while Resnet achieved the highest score in F1 with 88.10% but overall the Alexnet had the highest testing accuracy which also strengthens the research decision for choosing Alexnet as deep transfer model.

Table 9 also illustrates that in the third scenario, which contains two classes, all deep transfer learning models achieved similar the highest percentage for precision, recall and F1 score metrics which strengthen the research decision for choosing Googlenet as it achieved the highest validation accuracy with 99.9% as illustrated in Table 6.

Table 9. Performance measurements for different scenarios.

# of Classes	Class Name	Alexnet	Googlenet	Resnet18
4 classes	Precision	64.68%	84.17%	72.50%
	Recall	66.67%	80.56%	66.67%
	F1 Score	65.66%	82.32%	69.46%
	Testing Accuracy	66.67%	80.56%	69.46%
3 classes	Precision	85.19%	81.44%	88.10%
	Recall	85.19%	81.48%	81.48%
	F1 Score	85.19%	81.46%	84.66%
	Testing Accuracy	85.19%	81.48%	81.48%
2 classes	Precision	100%	100%	100%
	Recall	100%	100%	100%
	F1 Score	100%	100%	100%
	Testing Accuracy	100%	100%	100%

6. Conclusions and Future Works

The 2019 novel Coronaviruses (COVID-19) are a family of viruses that leads to illnesses ranging from the common cold to more severe diseases and may lead to death according to World Health Organization (WHO), with the advances in computer algorithms and especially artificial intelligence, the detection of this type of virus in early stages will help in fast recovery. In this paper, a GAN with deep transfer learning for COVID-19 detection in limited chest X-ray images is presented. The lack of benchmark datasets for COVID-19 especially in chest X-rays images was the main motivation of this research. The main idea is to collect all the possible images for COVID-19 and use the GAN network to generate more images to help in the detection of the virus from the available X-ray’s images. The dataset in this research was collected from different sources. The number of images of the collected dataset was 307 images for four types of classes. The classes are the covid, normal, pneumonia bacterial, and pneumonia virus.

Three deep transfer models were selected in this research for investigation. Those models are selected for investigation through this research as it contains a small number of layers on their architectures, this will result in reducing the complexity and the consumed memory and time for the proposed model. A three-case scenario was tested through the paper, the first scenario which included the four classes from the dataset, while the second scenario included three classes and the third scenario included two classes. All the scenarios included the COVID-19 class as it was the main target of this research to be detected. In the first scenario, the Googlenet was selected to be the main deep transfer model as it achieved 80.6% in testing accuracy. In the second scenario, the Alexnet was selected to be the main deep transfer model as it achieved 85.2% in testing accuracy while in the third scenario which included two classes(COVID-19, and normal), Googlenet was selected to be the main deep transfer model as it achieved 100% in testing accuracy and 99.9% in the validation accuracy. One open door for future works is to apply the deep models with a larger dataset benchmark.

References

1. Singhal, T. A Review of Coronavirus Disease-2019 (COVID-19). *Indian J. Pediatrics* **2020**, *87*, 281–286. [CrossRef]
2. Lai, C.-C.; Shih, T.-P.; Ko, W.-C.; Tang, H.-J.; Hsueh, P.-R. Severe acute respiratory syndrome coronavirus 2 (SARS-CoV-2) and coronavirus disease-2019 (COVID-19): The epidemic and the challenges. *Int. J. Antimicrob. Agents* **2020**, *55*, 105924. [CrossRef]
3. Li, J.; Li, J.J.; Xie, X.; Cai, X.; Huang, J.; Tian, X.; Zhu, H. Game consumption and the 2019 novel coronavirus. *Lancet Infect. Dis.* **2020**, *20*, 275–276. [CrossRef]
4. Sharfstein, J.M.; Becker, S.J.; Mello, M.M. Diagnostic Testing for the Novel Coronavirus. *JAMA* **2020**. [CrossRef] [PubMed]
5. Chang, L.; Yan, Y.; Wang, L. Coronavirus Disease 2019: Coronaviruses and Blood Safety. *Transfus. Med. Rev.* **2020**. [CrossRef]
6. Shereen, M.A.; Khan, S.; Kazmi, A.; Bashir, N.; Siddique, R. COVID-19 infection: Origin, transmission, and characteristics of human coronaviruses. *J. Adv. Res.* **2020**, *24*, 91–98. [CrossRef] [PubMed]
7. Rabi, F.A.; Al Zoubi, M.S.; Kasasbeh, G.A.; Salameh, D.M.; Al-Nasser, A.D. SARS-CoV-2 and Coronavirus Disease 2019: What We Know So Far. *Pathogens* **2020**, *9*, 231. [CrossRef]
8. York, A. Novel coronavirus takes flight from bats? *Nat. Rev. Microbiol.* **2020**, *18*, 191. [CrossRef]
9. Lam, T.T.-Y.; Shum, M.H.-H.; Zhu, H.-C.; Tong, Y.-G.; Ni, X.-B.; Liao, Y.-S.; Wei, W.; Cheung, W.Y.-M.; Li, W.-J.; Li, L.-F.; et al. Identifying SARS-CoV-2 related coronaviruses in Malayan pangolins. *Nature* **2020**, 1–6. [CrossRef] [PubMed]
10. Giovanetti, M.; Benvenuto, D.; Angeletti, S.; Ciccozzi, M. The first two cases of 2019-nCoV in Italy: Where they come from? *J. Med. Virol.* **2020**, *92*, 518–521. [CrossRef]
11. Holshue, M.L.; DeBolt, C.; Lindquist, S.; Lofy, K.H.; Wiesman, J.; Bruce, H.; Spitters, C.; Ericson, K.; Wilkerson, S.; Tural, A.; et al. First Case of 2019 Novel Coronavirus in the United States. *N. Engl. J. Med.* **2020**, *382*, 929–936. [CrossRef] [PubMed]
12. Bastola, A.; Sah, R.; Rodriguez-Morales, A.J.; Lal, B.K.; Jha, R.; Ojha, H.C.; Shrestha, B.; Chu, D.K.W.; Poon, L.L.M.; Costello, A.; et al. The first 2019 novel coronavirus case in Nepal. *Lancet Infect. Dis.* **2020**, *20*, 279–280. [CrossRef]
13. Rothe, C.; Schunk, M.; Sothmann, P.; Bretzel, G.; Froeschl, G.; Wallrauch, C.; Zimmer, T.; Thiel, V.; Janke, C.; Guggemos, W.; et al. Transmission of 2019-nCoV Infection from an Asymptomatic Contact in Germany. *N. Engl. J. Med.* **2020**, *382*, 970–971. [CrossRef] [PubMed]
14. Phan, L.T.; Nguyen, T.V.; Luong, Q.C.; Nguyen, T.V.; Nguyen, H.T.; Le, H.Q.; Nguyen, T.T.; Cao, T.M.; Pham, Q.D. Importation and Human-to-Human Transmission of a Novel Coronavirus in Vietnam. *N. Engl. J. Med.* **2020**, *382*, 872–874. [CrossRef] [PubMed]
15. Coronavirus (COVID-19) Map. Available online: <https://www.google.com/COVID-19-map/> (accessed on 31 March 2020).
16. Rong, D.; Xie, L.; Ying, Y. Computer vision detection of foreign objects in walnuts using deep learning. *Comput. Electron. Agric.* **2019**, *162*, 1001–1010. [CrossRef]
17. Eraslan, G.; Avsec, Ž.; Gagneur, J.; Theis, F.J. Deep learning: new computational modelling techniques for genomics. *Nat. Rev. Genet.* **2019**, *20*, 389–403. [CrossRef]
18. Riordon, J.; Sovilj, D.; Samner, S.; Sinton, D.; Young, E.W.K. Deep Learning with Microfluidics for Biotechnology. *Trends Biotechnol.* **2019**, *37*, 310–324. [CrossRef]
19. Lundervold, A.S.; Lundervold, A. An overview of deep learning in medical imaging focusing on MRI. *Z. für Med. Phys.* **2019**, *29*, 102–127. [CrossRef]
20. Maier, A.; Syben, C.; Lasser, T.; Riess, C. A gentle introduction to deep learning in medical image processing. *Z. für Med. Phys.* **2019**, *29*, 86–101. [CrossRef]
21. Shrestha, A.; Mahmood, A. Review of Deep Learning Algorithms and Architectures. *IEEE Access* **2019**, *7*, 53040–53065. [CrossRef]
22. Pouyanfar, S.; Sadiq, S.; Yan, Y.; Tian, H.; Tao, Y.; Reyes, M.P.; Shyu, M.-L.; Chen, S.-C.; Iyengar, S.S. A Survey on Deep Learning: Algorithms, Techniques, and Applications. *ACM Comput. Surv.* **2018**, *51*, 1–36. [CrossRef]

23. Goodfellow, I.J.; Pouget-Abadie, J.; Mirza, M.; Xu, B.; Warde-Farley, D.; Ozair, S.; Courville, A.; Bengio, Y. Generative Adversarial Nets. In Proceedings of the 27th International Conference on Neural Information Processing Systems—Volume 2, Montreal, QC, Canada, 8–13 December 2014; MIT Press: Cambridge, MA, USA, 2014; pp. 2672–2680.
24. Cao, Y.; Jia, L.; Chen, Y.; Lin, N.; Yang, C.; Zhang, B.; Liu, Z.; Li, X.; Dai, H. Recent Advances of Generative Adversarial Networks in Computer Vision. *IEEE Access* **2019**, *7*, 14985–15006. [[CrossRef](#)]
25. Gonog, L.; Zhou, Y. A Review: Generative Adversarial Networks. In Proceedings of the 2019 14th IEEE Conference on Industrial Electronics and Applications (ICIEA), Xi'an, China, 19–21 June 2019; pp. 505–510.
26. Lee, M.; Seok, J. Controllable Generative Adversarial Network. *IEEE Access* **2019**, *7*, 28158–28169. [[CrossRef](#)]
27. Caramihale, T.; Popescu, D.; Ichim, L. Emotion Classification Using a Tensorflow Generative Adversarial Network Implementation. *Symmetry* **2018**, *10*, 414. [[CrossRef](#)]
28. Ciregan, D.; Meier, U.; Schmidhuber, J. Multi-column deep neural networks for image classification. In Proceedings of the 2012 IEEE Conference on Computer Vision and Pattern Recognition, Providence, RI, USA, 16–21 June 2012; pp. 3642–3649.
29. Krizhevsky, A.; Sutskever, I.; Hinton, G.E. Imagenet classification with deep convolutional neural networks. *Adv. Neural Inf. Process. Syst.* **2012**, 1097–1105. [[CrossRef](#)]
30. Lecun, Y.; Bottou, L.; Bengio, Y.; Haffner, P. Gradient-based learning applied to document recognition. *Proc. IEEE* **1998**, *86*, 2278–2324. [[CrossRef](#)]
31. Yin, F.; Wang, Q.; Zhang, X.; Liu, C. ICDAR 2013 Chinese Handwriting Recognition Competition. In Proceedings of the 2013 12th International Conference on Document Analysis and Recognition, Washington, DC, USA, 25–28 August 2013; pp. 1464–1470.
32. El-Sawy, A.; EL-Bakry, H.; Loey, M. CNN for Handwritten Arabic Digits Recognition Based on LeNet-5 BT. In Proceedings of the International Conference on Advanced Intelligent Systems and Informatics 2016, Cairo, Egypt, 24–26 October 2016; Hassanien, A.E., Shaalan, K., Gaber, T., Azar, A.T., Tolba, M.F., Eds.; Springer International Publishing: Cham, Switzerland, 2017; pp. 566–575.
33. El-Sawy, A.; Loey, M.; EL-Bakry, H. Arabic Handwritten Characters Recognition Using Convolutional Neural Network. *WSEAS Trans. Comput. Res.* **2017**, *5*, 11–19.
34. LeCun, Y.; Huang, F.J.; Bottou, L. Learning methods for generic object recognition with invariance to pose and lighting. In Proceedings of the 2004 IEEE Computer Society Conference on Computer Vision and Pattern Recognition, CVPR 2004, Washington, DC, USA, 27 June–2 July 2004; Volume 2, p. II-104.
35. Stallkamp, J.; Schlipsing, M.; Salmen, J.; Igel, C. The German Traffic Sign Recognition Benchmark: A multi-class classification competition. In Proceedings of the The 2011 International Joint Conference on Neural Networks, San Jose, CA, USA, 31 July–5 August 2011; pp. 1453–1460.
36. Deng, J.; Dong, W.; Socher, R.; Li, L.; Kai, L.; Li, F.-F. ImageNet: A large-scale hierarchical image database. In Proceedings of the 2009 IEEE Conference on Computer Vision and Pattern Recognition, Miami, FL, USA, 20–25 June 2009; pp. 248–255.
37. Liu, S.; Deng, W. Very deep convolutional neural network based image classification using small training sample size. In Proceedings of the 2015 3rd IAPR Asian Conference on Pattern Recognition (ACPR), Kuala Lumpur, Malaysia, 3–6 November 2015; pp. 730–734.
38. Szegedy, C.; Wei, L.; Yangqing, J.; Sermanet, P.; Reed, S.; Anguelov, D.; Erhan, D.; Vanhoucke, V.; Rabinovich, A. Going deeper with convolutions. In Proceedings of the 2015 IEEE Conference on Computer Vision and Pattern Recognition (CVPR), Boston, MA, USA, 7–12 June 2015; pp. 1–9.
39. He, K.; Zhang, X.; Ren, S.; Sun, J. Deep Residual Learning for Image Recognition. In Proceedings of the 2016 IEEE Conference on Computer Vision and Pattern Recognition (CVPR), Cairo, Egypt, 24–26 October 2016; pp. 770–778.
40. Chollet, F. Xception: Deep Learning with Depthwise Separable Convolutions. In Proceedings of the 2017 IEEE Conference on Computer Vision and Pattern Recognition (CVPR), Honolulu, HI, USA, 21–26 July 2017; pp. 1800–1807.
41. Szegedy, C.; Vanhoucke, V.; Ioffe, S.; Shlens, J.; Wojna, Z. Rethinking the inception architecture for computer vision. In Proceedings of the IEEE Conference on Computer Vision and Pattern Recognition, Las Vegas, NV, USA, 26 June 1–1 July 2016; pp. 2818–2826.

42. Huang, G.; Liu, Z.; Van Der Maaten, L.; Weinberger, K.Q. Densely Connected Convolutional Networks. In Proceedings of the 2017 IEEE Conference on Computer Vision and Pattern Recognition (CVPR), Honolulu, HI, USA, 21–26 July 2017; pp. 2261–2269.
43. Stephen, O.; Sain, M.; Maduh, U.J.; Jeong, D.-U. An Efficient Deep Learning Approach to Pneumonia Classification in Healthcare. *J. Healthc. Eng.* **2019**, *2019*, 4180949. [[CrossRef](#)] [[PubMed](#)]
44. Kermany, D.S.; Goldbaum, M.; Cai, W.; Valentim, C.C.S.; Liang, H.; Baxter, S.L.; McKeown, A.; Yang, G.; Wu, X.; Yan, F.; et al. Identifying Medical Diagnoses and Treatable Diseases by Image-Based Deep Learning. *Cell* **2018**, *172*, 1122–1131. [[CrossRef](#)]
45. Ayan, E.; Ünver, H.M. Diagnosis of Pneumonia from Chest X-ray Images Using Deep Learning. In Proceedings of the 2019 Scientific Meeting on Electrical-Electronics & Biomedical Engineering and Computer Science (EBBT), Istanbul, Turkey, 24–26 April 2019; pp. 1–5.
46. Varshni, D.; Thakral, K.; Agarwal, L.; Nijhawan, R.; Mittal, A. Pneumonia Detection Using CNN based Feature Extraction. In Proceedings of the 2019 IEEE International Conference on Electrical, Computer and Communication Technologies (ICECCT), Coimbatore, India, 20–22 February 2019; pp. 1–7.
47. Wang, X.; Peng, Y.; Lu, L.; Lu, Z.; Bagheri, M.; Summers, R.M. ChestX-ray8: Hospital-Scale Chest X-ray Database and Benchmarks on Weakly-Supervised Classification and Localization of Common Thorax Diseases. In Proceedings of the 2017 IEEE Conference on Computer Vision and Pattern Recognition (CVPR), Honolulu, HI, USA, 21–26 July 2017; pp. 3462–3471.
48. Chouhan, V.; Singh, S.K.; Khamparia, A.; Gupta, D.; Tiwari, P.; Moreira, C.; Damaševičius, R.; de Albuquerque, V.H.C. A Novel Transfer Learning Based Approach for Pneumonia Detection in Chest X-ray Images. *Appl. Sci.* **2020**, *10*, 559. [[CrossRef](#)]
49. Islam, S.R.; Maity, S.P.; Ray, A.K.; Mandal, M. Automatic Detection of Pneumonia on Compressed Sensing Images using Deep Learning. In Proceedings of the 2019 IEEE Canadian Conference of Electrical and Computer Engineering (CCECE), Edmonton, AB, Canada, 5–8 May 2019; pp. 1–4.
50. Cohen, J.P.; Morrison, P.; Dao, L. COVID-19 Image Data Collection. *arXiv* **2020**, arXiv:2003.11597.
51. Cohen, J.P.; Morrison, P.; Dao, L. COVID-19 Image Data Collection. Available online: <https://github.com/ieee8023/covid-chestxray-dataset> (accessed on 31 March 2020).
52. Dataset. Available online: <https://drive.google.com/uc?id=1coM7x3378f-Ou2l6Pg2wldaOI7Dntu1a> (accessed on 31 March 2020).
53. Khalifa, N.; Taha, M.; Hassanien, A.; Mohamed, H. Deep Iris: Deep Learning for Gender Classification Through Iris Patterns. *Acta Inform. Medica* **2019**, *27*, 96. [[CrossRef](#)]
54. Khalifa, N.E.M.; Taha, M.H.N.; Hassanien, A.E.; Hemedan, A.A. Deep bacteria: robust deep learning data augmentation design for limited bacterial colony dataset. *Int. J. Reason.-Based Intell. Syst.* **2019**, *11*, 256–264. [[CrossRef](#)]
55. Lemley, J.; Bazrafkan, S.; Corcoran, P. Smart Augmentation Learning an Optimal Data Augmentation Strategy. *IEEE Access* **2017**, *5*, 5858–5869. [[CrossRef](#)]
56. Khalifa, N.E.M.; Taha, M.H.N.; Ezzat Ali, D.; Slowik, A.; Hassanien, A.E. Artificial Intelligence Technique for Gene Expression by Tumor RNA-Seq Data: A Novel Optimized Deep Learning Approach. *IEEE Access* **2020**, *8*, 22874–22883. [[CrossRef](#)]
57. Khalifa, N.; Loey, M.; Taha, M.; Mohamed, H. Deep Transfer Learning Models for Medical Diabetic Retinopathy Detection. *Acta Inform. Medica* **2019**, *27*, 327. [[CrossRef](#)] [[PubMed](#)]
58. Khalifa, N.E.; Hamed Taha, M.; Hassanien, A.E.; Selim, I. Deep galaxy V2: Robust deep convolutional neural networks for galaxy morphology classifications. In Proceedings of the 2018 International Conference on Computing Sciences and Engineering, ICCSE 2018—Proceedings, Kuwait City, Kuwait, 11–13 March 2018; pp. 1–6.
59. Khalifa, N.E.M.; Taha, M.H.N.; Hassanien, A.E. Aquarium Family Fish Species Identification System Using Deep Neural Networks. In *International Conference on Advanced Intelligent Systems and Informatics*; Springer: Cham, Switzerland, 2018; pp. 347–356.
60. Aswathy, P.; Siddhartha; Mishra, D. Deep GoogLeNet Features for Visual Object Tracking. In Proceedings of the 2018 IEEE 13th International Conference on Industrial and Information Systems (ICIIS), Rupnagar, India, 1–2 December 2018; pp. 60–66.

61. Szegedy, C.; Ioffe, S.; Vanhoucke, V.; Alemi, A.A. Inception-v4, inception-ResNet and the impact of residual connections on learning. In Proceedings of the 31st AAAI Conference on Artificial Intelligence, AAAI 2017, San Francisco, CA, USA, 4-9 February 2017.
62. Bottou, L. Stochastic Gradient Descent Tricks. In *Neural Networks: Tricks of the Trade: Second Edition*; Montavon, G., Orr, G.B., Müller, K.-R., Eds.; Springer: Berlin/Heidelberg, Germany, 2012; pp. 421-436. ISBN 978-3-642-35289-8.
63. Srivastava, N.; Hinton, G.; Krizhevsky, A.; Sutskever, I.; Salakhutdinov, R. Dropout: A Simple Way to Prevent Neural Networks from Overfitting. *J. Mach. Learn. Res.* **2014**, *15*, 1929-1958.
64. Caruana, R.; Lawrence, S.; Giles, L. Overfitting in Neural Nets: Backpropagation, Conjugate Gradient, and Early Stopping. In Proceedings of the 13th International Conference on Neural Information Processing Systems; MIT Press: Cambridge, MA, USA, 2000; pp. 381-387.
65. Goutte, C.; Gaussier, E. A Probabilistic Interpretation of Precision, Recall and F-Score, with Implication for Evaluation. In *European Conference on Information Retrieval*; Springer: Berlin/Heidelberg, Germany, 2010.

Remark on Artificial Intelligence, humanoid and Terminator scenario: A Neutrosophic way to futurology

Victor Christianto, Florentin Smarandache

Victor Christianto, Florentin Smarandache (2020). Remark on Artificial Intelligence, humanoid and Terminator scenario: A Neutrosophic way to futurology. *International Journal of Neutrosophic Science* 1(1), 8-13; DOI :10.5281/zenodo.3633438

Abstract

This article is an update of our previous article in this SGJ journal, titled: On G del's Incompleteness Theorem, Artificial Intelligence & Human Mind [7]. We provide some commentary on the latest developments around AI, humanoid robotics, and future scenario. Basically, we argue that a more thoughtful approach to the future is techno-realism.

Keywords: Neutrosophic Logic, Neutrosophic Futurology, artificial intelligence

1. Introduction

Indeed among the futurists, there are people who are so optimistic about the future of mankind with its various technologies, such as Peter Diamandis with his *Abundance*. But there are also skeptics, predicting dystopia, like George Orwell's 1984 etc. [4]

At my best, our response is: we must develop a view of technology that is not very optimistic but also not pessimistic, perhaps the right term is: Techno-realism. [3]

We mean this: with a lot of research on robotics, humanoid etc., then emerged developments in the direction of transhumanism and human-perfection. [6]

There is already a fortune-telling that AI will be established with psychological and spiritual science, so as to bring up the AI/robotic consciousness. [7]

But lest we become forgetting our past, and building the tower of Babylon.

For example, last year the world's robotics experts were made yammer because there was a tactical-robot report developed in one of the labs on campus in South Korea. It means this tactical robot is a robot designed to kill. Then Elon Musk and more than 2000 AI researchers raised petitions to the UN to stop all research on the tactical robotic. [2]

Roughly it's a true story that we can recall, although it is not our intention here to give foretelling that the world would be heading for the Terminator movie scenario.... but there's a chance we're heading there.

A Neutrosophic perspective

As an alternative to the above term of “techno-realism”, our problem of predicting future technology that is not very optimistic but also not pessimistic, is indeed a Neutrosophic problem.

First, let us discuss a commonly asked question: what is Neutrosophic Logic? Here, we offer a short answer.

Vern Poythress argues that sometimes we need a modification of the basic philosophy of mathematics, in order to re-define and redeem mathematics [8]. In this context, allow us to argue in favor of Neutrosophic logic as a starting point, in lieu of the Aristotelian logic that creates so many problems in real world.

In Neutrosophy, we can connect an idea with its opposite and with its neutral and get common parts, i.e. $A \wedge \text{non-}A$ nonempty set. This constitutes the common part of the uncommon things! It is true/real paradox. From neutrosophy, it all began: neutrosophic logic, neutrosophic set, neutrosophic probability, neutrosophic statistics, neutrosophic measures, neutrosophic physics, and neutrosophic algebraic structures [9].

It is true in a restricted case, i.e. Hegelian dialectics considers only the dynamics of opposites (A and $\text{anti-}A$), but in our everyday life, not only the opposites interact, but the neutrals $\text{neut-}A$ between them too. For example, if you fight with a man (so you both are the opposites to each other), but neutral people around both of you (especially the police) interfere to reconcile both of you. Neutrosophy considers the dynamics of opposites and their neutrals.

So, neutrosophy means that: A , $\text{anti-}A$ (the opposite of A), and $\text{neut-}A$ (the neutrals between A and $\text{anti-}A$) interact among themselves. A neutrosophic set is characterized by a truth-membership function (T), an indeterminacy-membership function (I), and a falsity-membership function (F), where T, I, F are subsets of the unit interval [0, 1].

As particular cases we have a single-valued neutrosophic set {when T, I, F are crisp numbers in [0, 1]}, and an interval-valued neutrosophic set {when T, I, F are intervals included in [0, 1]}.

From a different perspective, we can also say that neutrosophic logic is (or Smarandache logic) a generalization of fuzzy logic based on Neutrosophy (<http://fs.unm.edu/NeutLog.txt>). A proposition is t true, i indeterminate, and f false, where t, i, and f are real values from the ranges T, I, F, with no restriction on T, I, F, or the sum $n = t + i + f$. Neutrosophic logic thus generalizes:

- Intuitionistic logic, which supports incomplete theories (for $0 \leq n \leq 100$ and $i = 0, 0 \leq t, i, f \leq 100$);

- Fuzzy logic (for $n = 100$ and $i = 0$, and $0 \leq t, i, f \leq 100$);
- Boolean logic (for $n = 100$ and $i = 0$, with t, f either 0 or 100);
- Multi-valued logic (for $0 \leq t, i, f \leq 100$);
- Paraconsistent logic (for $n = 100$ and $i = 0$, with both $t, f \leq 100$);
- Dialetheism, which says that some contradictions are true (for $t = f = 100$ and $i = 0$; some paradoxes can be denoted this way).

Compared with all other logics, neutrosophic logic introduces a percentage of indeterminacy due to unexpected parameters hidden in some propositions. It also allows each component t, i, f to boil over 100 or freeze under 0. For example, in some tautologies $t = 100$, called "overtrue." Neutrosophic Set is a powerful structure in expressing indeterminate, vague, incomplete and inconsistent information.

Therefore, from Neutrosophic Logic perspective, "our problem of predicting future technology that is not very optimistic but also not pessimistic" can be rephrased as follows:

(Opposite 1) pessimism – pess-optimism -- optimism (Opposite 2)

While the term pess-optimism may be originated in engineering (perhaps in geotechnical engineering), but it has become one term in urban dictionary, see:

"A philosophy that encourages forward-thinking optimism with an educated acceptance of a basic level of pessimism. Optimism's fault is its naiveté, while pessimism's fault is its blind jadedness. We live on Earth and are human. There is, was and will be good and bad." [10].

That would mean a more balanced view of the future (futuresology), something between too optimistic view and too pessimistic view. It is our hope that Neutrosophic perspective may shed more light on this wise term of pess-optimism, although for us "techno-realism" term may bring more clarity with respect to technology foretelling.

Alternatively, we can also consider a few new terms, such as:

- a. Less-optimism: somewhat less than optimism, although it is not pessimism.
- b. Merging optimism and realism: opti-realism. It can be somewhat better term compared to pess-optimism, because realism brings a more pragmatic view into the conventional dialogue between pessimism and optimism.

Then maybe we can call this new approach: Neutrosophic Futuresology.

What about AI fever?

In line with it, a Canadian mathematics professor wrote the following message a few days ago:

I am appalled by the way how computer science damaged humanity. It has
 Been even worse than nuclear bombs. It destroyed the soul of humanity and

I have less than 0 interest in doing anything in this evil field.

Now something more destructive than data mining is coming up. Yes AI,

Probabilistic AI. It says we don't know why but somehow it works. So we

Started to have air plane malfunction because of the AI program failure.

Of course you can agree or not with the expression of that mathematics professor, but reportedly the employees of Google also demanded strict rules for AI to be freed from weaponry purposes, or called “weaponized AI “[1].

Meanwhile, it is known that the development of science and technology has a positive and negative facet as well as the Robotics & AI. Although positive contributions are obvious, but the side effects are spiritual and mental aspects; and it needs to be prepared so that people can still take the positives, for example the planner of robotic Intelligence must have a code of ethics: Intelligence robotics should not harm or kill humans, rob banks etc. For other ethical issues of AI, see for example [5].

Are there practical examples of the realism attitude in technology?

If you got free time, read the periodicals around the industry in Japan. There are at least 2 interesting phrases that are worth a study: Ikigai and Monozukuri.

The ikigai may be a bit often we hear, meaning: The reason we wake up early, consisting of a balance between passion, work, profession etc.

Then what is Monozukuri? According to a source:

Monozukuri is a Japanese word derived from the word mono means product or item and Zukuri means the creation, creation or production process. However, this concept has far broader implications than its literal meaning, where there is a creative spirit in delivering superior products as well as the ability to continuously improve the process...

What is the implementation? Let's look at 2 simple examples:

A. Sushi: Though simple at a glance, sushi is carefully designed so that the size is a one-stop meal. No more and no less. That is the advantage of many innovations that are typical of Japanese, because they think carefully from the usefulness, size, artistic value of the product. And so on.

B. Shinkansen: The uniqueness of this train is not only about speed, but also on time (punctual). Even reportedly, the time lag between train sets is less than 5 minutes. And everything is designed by Japanese railway engineers even before there is a personal computer or AI. Then how did they design such an intricate system? Answer: They use dynamic control theory (Dynamic control Theory).

Concluding remarks

Of course this is just a brief comment on a complicated topic that needs to be carefully examined and cautiously thought of.

Let the authors close this article by quoting the sentence of a wise man in the past centuries:

Lo, this only have I found, that God hath made man upright; but they have sought out many inventions.”

Wishing you all a happy a new year 2020. Hopefully next year there will be not a robot to greet you. Yes it is indeed a great paradox in the 21st century: Robots are increasingly proficient at imitating humans, but many humans live like robots. - personal quote.

Acknowledgement

One of these authors (VC) is really grateful to Prof. Iwan Pranoto and Prof Liek Wilardjo for starting this discussion, and to Prof. The Houw Liong who has been willing to read and give valuable advice.

References:

[1] Google employees demand AI rules to prevent weaponised AI. Url:

<https://techsparx.com/blog/2018/06/google-employees.html>

[2] Nina Werkhauer. Should killer robots be banned? URL: <https://m.dw.com/en/should-killer-robots-be-banned/a-45237864>

[3] Technorealism: the information glut. URL: <https://cs.stanford.edu/people/eroberts/cs201/projects/1999-00/technorealism/glut.html>

[4] George Orwell, 1984, a classic dystopian novel. URL : <https://www.sparknotes.com/lit/1984/>

[5] ethical issues in robotics/AI. URL: <https://www.weforum.org/agenda/2016/10/top-10-ethical-issues-in-artificial-intelligence/>

[6] www.wired.com, URL: <https://www.wired.com/story/the-responsibility-of-immortality/>

[7] V. Christianto. On G del's Incompleteness Theorem, Artificial Intelligence & Human Mind. SGJ. URL: <https://scigod.com/index.php/sgj/article/view/286>

[8] Poythress, V., Redeeming Mathematics: A God-centered approach. Crossway: Wheaton, IL, USA, 2015.

[9] Smarandache, F. Neutrosophy/Neutrosophic probability, set, and logic. American Research Press: Santa Fe, NM, USA, 1998.

[10] "pessoptimism," url: <https://www.urbandictionary.com/define.php?term=pessoptimism>

Pledoarie pentru excelență în cultură: despre Mircea Eugen Șelariu

Florentin Smarandache

Florentin Smarandache (2021). Pledoarie pentru excelență în cultură: despre Mircea Eugen Șelariu. *Bogdania* 87-88, 29-30

ȘELARIU (Nume), E. (inițiala tatălui) **MIRCEA-EUGEN** (prenumele), (n. 27 febr. 1938, Călan, jud. Hunedoara), ing. în domeniul Tehnologiei Construcțiilor de Mașini (TCM) și cercetător științific.

Date despre familie: tatăl: Emil (n. 1907, Hațeg, jud. Hunedoara -d. 1992, Călan, jud. Hunedoara), expert contabil-planificator; *mama:* Maria (n. 1909, Vața, jud. Hunedoara – d. 1980, Călan) diriginta oficiului PTTR din Călan; *soția:* Dorina-Rodica Voștinariu profesoară de Istorie-Geografie la Colegiul Național Bănățean din Timișoara; *copii:* Șerban-Mircea, inginer TCM, specializarea Mecatronică, inginer la Elba Timișoara.

Studii: a absolvit Școala Elementara din Călan (1936-1940), oraș în care a făcut primele șapte clase (1944 -1951); a urmat Liceul de Băieți din Alba-Iulia (1951-1954) și cursurile Facultății de Construcții a Institutului Politehnic din Timișoara (1954-1955). În perioada 1955-1958 a lucrat ca tehnolog principal 1 la Uzina „Victoria” din Calan la Atelierul Mecanic și la cea mai mare turnatorie de fontă și de neferoase din România. (1958-1963) și-a continuat studiile la Institutul Politehnic „Traian Vuia” din Timișoara, cu o bursă de întreținere, unde a fost reținut asistent la Facultatea de Mecanică, Catedra de TCM. S-a înscris la doctorat la Prof. Dr. Ing. Gh. Savii cu tema „Influența dispozitivelor asupra dinamicii sistemelor tehnologice elastice”. Și-a susținut cele patru examenele și toate referatele tezei de doctorat cu note maxime (10). După decesul conducătorului de doctorat a fost preluat de Prof. Dr. Doc.ing. Aurel Nanu. În prima fază, primele cca. 100 de pagini ale tezei au fost dactilografiate pe o singură parte a paginii, așa cum se proceda atunci. Ordinul de scriere pe ambele părți, justificat de economia de hârtie, a necesitat reluarea scrierii tezei pe ambele părți. Ajunsă la peste 250 de pagini, scrise pe ambele părți, a venit un nou ordin care stipula că numărul maxim de pagini admis este de 120. În aceste condiții s-a propus ca partea originală de supermatematică, care stă la baza studierii și soluționării vibrațiilor neliniare, să facă obiectul unui volum, iar partea de aplicare un al doilea volum. Soluția n-a fost acceptată. Ca urmare teza n-a putut fi admisă și susținută. În 1969 a urmat cursurile de limbă germană la Goethe Institut din Iserlohn și în 1969-1970 a efectuat o specializare cu o bursă DAAD la Universitatea din Stuttgart, la Catedra și Institutul de Mașini-Unelte.

Carierea profesională și didactică: 1955-1958 -a lucrat ca tehnolog normator principal 1 la Uzina „Victoria” din Călan; 1963 -1969 –asistent universitar la Universitatea „Politehnica” din Timișoara. Din 1969 și până la pensionare (2000) a activat ca șef de lucrări la Universitatea „Politehnica” din Timișoara. După pensionare a mai lucrat un an cu cumul 100 la Universitatea „POLITEHNICA” din Timișoara și trei ani cu plata cu ora pentru predarea cursului de Mecatronică la secția de Educație Continuă.

După pensionare a lucrat cu un sfert de normă la Serviciul de Proiectare al Întreprinderii Electrotimiș din Timișoara, tot cu un sfert de normă la firma privată TCP-System din Timișoara în calitate de proiectant -consultant și cu o jumătate de norma la Institutul Național de Cercetare-Dezvoltare pentru Electrochimie și Materie Condensată din Timișoara, ca cercetător principal, până în anul 2008. După 1989, a fost numit consilier la Întreprinderea de Autoturisme din Timișoara și la majoritatea Institutelor de Cercetare proiectare din oraș ul Timișoara

Activitatea de cercetare: A proiectat pentru URSS robotul industrial ROMAPET (1980), 10 mașini unelte agregate cu deservire automată și automatul de asamblare a microîntrerupătoarelor K2 pentru aviație prin contracte cu URSS (1981). A conceput și proiectat o întreprindere de fabricare a micromașinilor electrice japoneze în Timișoara cu folosirea deșeurilor de tole de la Electromotor Timișoara (1989), pentru care a fost onorat cu premiul unu al Județului Timiș în domeniul cercetării. A conceput și proiectat mașini de găurit plăci carde și de presare a acelor în plăci carde, pentru Ambalajul Metalic din Timișoara, lucrări de asemenea premiate pe județul Timiș. A conceput și proiectat automatul de asamblare a tuturor diblurilor fabricate de Întreprinderea 6 Martie din Timișoara. A conceput și proiectat dispozitivul de asamblare automată a capacelor de siguranță fabricate de Elba Timișoara (1972). A condus cu Prof. Nicolae Gheorghiu proiectarea în colectiv a robotului „REMT-1”, fabricat la Electromotor Timișoara, distins cu Premiul „Traian Vuia” al Academiei României. A condus proiectarea III și realizarea primului robot didactic (1971) și a primului robot industrial românesc „Voinicel-1” care și-a pierdut brațul la deservirea unei prese cu fricțiune la Ambalajul Metalic din Timișoara (1973).

Contribuții: inventator, publicist, universitar; personalitate de excepție cu realizări notabile cu caracter interdisciplinar în domeniile TCM, Mecanică și (Super)Matematică. A înființat prima Specializare de Mecatronică (1988), primul robot didactic (1971) și primul robot industrial din România (1972), la Catedra de TCM de la Facultatea de Mecanică din Timișoara.

Distincții: 1983 – Premiul Academiei Române (1983) pentru robotul industrial REMT-1; 2013 – „Diploma AGIR” pentru lucrarea „Supermatematica. Fundamente” Vol.I și Vol.II, Ed. Politehnica, Timișoara, 2012; 2009 -„CERTIFICAT DE APRECIERE” acordat de Universitatea din New Mexico pentru contribuțiile aduse la dezvoltarea matematicii; 2010 – Asociația Internațională Exclusivistă a Paradoxiștilor l-a declarat membru de onoare pentru obiectele paradoxale introduse în Matematică precum sfero-cub, cono-piramida, cilindro-prisma ș.m.a.; 2015 -A fost ales membru de onoare al Asociației Internaționale de Științe Neutrosofice.

Recunoaștere pe plan intern și internațional: (1989) -A fost invitatul Universității din Budapesta unde a ținut conferința „FUNC II CIRCULARE EXCENTRICE ȘI APLICA IILE LOR TEHNICE”. 1979 a fost solicitat să rămână la Universitatea din Stuttgart cu o bursa Humboldt sau ca asistent (1970), iar în anul 1972 decanul Tuffentssammer s-a deplasat la Timișoara și a încheiat o Înțelegere pentru colaborarea cu Universitate din Stuttgart și cu IPA Stuttgart, ne aprobată de București. În 1985 a fost solicitat să proiecteze pentru URSS, iar în 2003 să cerceteze pentru USA. Este membru al Asociației Profesionale a Inginerilor din Germania (VDI), din România (AGIR), membru fondator al Asociației Române de Robotică (ARR); vicepreședintele Sindicatului Universității Politehnica din Timișoara. Președintele Secție de Arte Marțiale a IPTVT, (1967) vicecampionă națională la Judo (1971).

Activitate publicistică: a publicat 11 cărți (2 tratate), peste 80 articole științifice în limba română, germană și engleză, a susținut alte 6 lucrări științifice nepublicate, a condus și colaborat la 35 de contracte de cercetare, deține 6 brevete de invenții și 2 de inovații, a susținut 20 conferințe (una la Budapesta).

Lucrări de referință: *Manualul Inginerului Mecanic Vol III:TCM, Cap. 18 „Proiectarea Dispozitivelor”* (1971); 25 din tratatul de „Proiectarea Dispozitivelor” EDP, Buc.; *Proiectarea dispozitivelor Capete Multiaxe* (1974); *Îndrumător de laborator pentru Proiectarea Dispozitivelor; Supermatematica.Fundamente Vol I și Vol.II* ediția 1-a, a 2-a și a 3-a. Vol III este sub tipar la Editura de Vest din Timișoara; „*Matematica Atomică*” Ed. de Vest, Timișoara 2017;

Alte date:-sport de performanță-(1953-1954) Campion absolut de gimnastica al Județului Hunedoara, al zonei Brașov și a zonei Timișoara; Profesor de gimnastică și totodată absolvent al Școlii Serale Sportive cu secția Gimnastică din Alba Iulia; Vicecampion național de ștafetă 4 X 100 m plat cu ștafeta orașului Timișoara; Căpitan de echipă al primei reprezentative de fotbal tineret a orașului Timișoara (1955); Fotbalist la Unirea –Alba Iulia (1954), la „Victoria Călan (1955-1963) și la UM Timișoara; Căpitan de echipă a echipei cadrelor didactice de la Facultatea de Mecanică.

Referințe bibliografice: Specializarea de **TEHNOLOGIA CONSTRUC IILOR DE MAȘINI** la 60 de ani, Ed. Politehnica, Timișoara, 2018.

Five examples on using spreadsheet to solve engineering and mathematical problems

Victor Christianto, Florentin Smarandache

Victor Christianto, Florentin Smarandache (2021). Five examples on using spreadsheet to solve engineering and mathematical problems. *Octagon Mathematical Magazine* 29(1), 362-371

1 Abstract

Computer spreadsheet has been commonly used in the past few decades into very practical mathematical and problem solving tool. Here we discuss 5 examples on using spreadsheet to solve engineering and mathematical problems. We recall our story in using Lotus 123 and Excel spreadsheet software since early 90s until recently. In last example we discuss more specifically on using excel spreadsheet to optimize the use of wind energy turbine in combination with solar photovoltaic. It is known in literature there are many discussions on linear programming for various cases; however there is only few discussion to take into account the uncertainties involved in the power production of PV/Wind system. In this paper, we consider integer linear programming by considering bi-level values as suggested by Pramanik and Pratim Dey. The purpose of this study is to show that it is possible to consider uncertainties in energy production in the linear programming model.

2 Introduction

Computer spreadsheet has been commonly used in the past few decades; its use grew from just a special interest into ubiquitous mathematical and problem solving tool. Here we discuss 5 examples on using spreadsheet to solve engineering and mathematical problems. We recall our story in using Lotus and Excel spreadsheet software since early 90s until recently. Hopefully what we share here will be found as useful lessons for young engineers.

3 Examples of using spreadsheet for solving engineering and mathematics problems

4 To find inverse of large scale matrix

Recalling one of us (VC) early years as an engineering student, during 90s he learnt how to use Lotus 123 spreadsheet in order to find the inverse of large scale matrix. At a point he solved a 100x100 matrix in order to solve problem in matrix analysis of structures. At the time, using Lotus and IBM-compatible PC it would need no less than a few hours.

5 To calculate land filling volume

Around 1995-1996, as one of us (VC) worked in a consulting team, he often calculated landfilling volume requirement using Excel Spreadsheet. At the time, the available PC was IBM-compatible with Office 95.

6 To find optimized line of outer planets in the Solar System

Later on, around 2000-2002 he (VC) began to experimenting with PC in order to solve the problem of ordering in inner and outer planets orbits in the Solar System. At the time, he began to improve the Titius-Bode rule with quantized orbit ala Bohr's quantization rules. He succeeded to find the straight line solution of outer planets orbits by optimizing least square differences between straight line and the actual orbit data. He presented his results in a series of papers at Apeiron, 2003-2004 (<http://redshift.vif.com>) The result has also been presented in a paper at Progress in Physics 2006, with Prof. Florentin Smarandache. Our result is quite simple, as shown in table below.

7 Solving Fermat's last theorem in graphical way

More recently, he tried to find a simpler proof of Fermat's last theorem using Excel Spreadsheet. After some days figuring out the problem, finally he found out how to solve it graphically. Although an exact proof can be given using differential calculus, we choose to use a more intuitive graphical method. Fermat's Last Theorem is one of the most difficult mathematical problems since more than 200 years ago. It can be rephrased more simply as follows: "The Pythagoras Theorem only works for and only for $n=2$, and does not work for other values of n , where the theorem can be written as : $a^n + b^n = c^n$." While more than hundred solutions of FLT have been proposed by eminent mathematicians, including the famous lecture by Andrew Wiles [1][2], but still many people want a simpler but intuitive argument for proving the validity of FLT. This paper is

Object	No.	Titius	Nottale	CSV	Observ.	Δ , %
	1		0.4	0.43		
	2		1.7	1.71		
Mercury	3	4	3.9	3.85	3.87	0.52
Venus	4	7	6.8	6.84	7.32	6.50
Earth	5	10	10.7	10.70	10.00	-6.95
Mars	6	16	15.4	15.4	15.24	-1.05
Hungarias	7		21.0	20.96	20.99	0.14
Asteroid	8		27.4	27.38	27.0	1.40
Camilla	9		34.7	34.6	31.5	-10.00
Jupiter	2	52		45.52	52.03	12.51
Saturn	3	100		102.4	95.39	-7.38
Uranus	4	196		182.1	191.9	5.11
Neptune	5			284.5	301	5.48
Pluto	6	388		409.7	395	-3.72
2003EL61	7			557.7	520	-7.24
Sedna	8	722		728.4	760	4.16
2003UB31	9			921.8	970	4.96
Unobserv.	10			1138.1		
Unobserv.	11			1377.1		

Table 1: Comparison of prediction and observed orbit distance of planets in Solar system (in 0.1AU unit) [28].

Figure 1: Evidence of quantized orbits of inner and outer planetary orbit distances in the Solar System. Source: V. Christianto, Apeiron, vol. 23, July 2004. url: <http://redshift.vif.com>

aiming to offer such an intuitive solution using graphical method. *Outline of argument: First we can write down the FLT as follows: $\hat{x}+b^x = c^x \dots(1)$ Or it can be rewritten as follows: $a_b^{x^x}/(c^x) = 1 \dots(2)$ The condition given by FLT is that equation (2) strictly equals 1, but let say we want to check if this condition holds for any value of x, then (2) can be written as follows: $a_b^{x^x}/(c^x) = y \dots(3)$ Now, we have a nonlinear equation in x and y. This equation can be solved at least by two methods, namely: a. Differential calculus method, by solving $dy/dx=0$, b. Graphical method. **Numerical result: In this paper we will use a simpler and intuitive graphical method, starting with an assumption that $a=3$, $b=4$, $c=5$, and x ranging from -10 to +10. For other values of a,b,c the readers are invited to verify themselves. Using MS Excel, we got the following result for equation (3):

And the graphical plot is as follows:

It should be clear that as x has values below 0, then y increases exponentially, but as x has values greater than 0 then y decreases approaching zero. The only value where $y=1$, is where $x=2$. This is a graphical method to solve FLT intuitively with equation (3). Concluding, it is possible to find a proof of validity of Fermat Last Theorem in an intuitive way using a graphical method. Although an exact proof can be given using differential calculus, we choose to use a more intuitive graphical method. It is our hope that such a graphical solution can be useful as teaching tool for high school mathematics teachers. For professors in mathematics, we are aware that this graphical method for solving FLT may sound too naïve, but considering the Occam's razor principle, then the simpler solution may be closer to the truth.

8 Analysis of PV/Wind systems by integer linear programming with Neutrosophic numbers by taking into account intermittency of energy production

Hybrid renewable energetic systems are systems that integrate more than one renewable energy sources. As they are time, environment and site dependant, one expects that their judicious and complementary combination may overcome some limitations which are inherent to every individual system used alone. Hybrid systems may also reduce the need for energy storage which is very costly and space consuming.[1] In real cases, sometimes it is of need to consider integrating renewable energy sources in order to build up economical hybrid energetic systems in the case where each type of energy are only available as specific units. For instance, we may need to combine photovoltaic panels and wind turbines with specific capacities to meet an energetic demand in a specific site with a lowest cost. Therefore, determining the optimal energy to be installed leads of determining the number of units from each source. This problem is formulated as an integer linear programming where the objective function to

x	y
-10	174.6949
-9	106.6796
-8	65.4979
-7	40.4908
-6	25.2482
-5	15.9118
-4	10.1575
-3	6.5828
-2	4.3403
-1	2.9167
0	2.0000
1	1.4000
2	1.0000

3 0.7280

4 0.5392

5 0.4054

6 0.3088

7 0.2377

8 0.1846

9 0.1443

10 0.1134

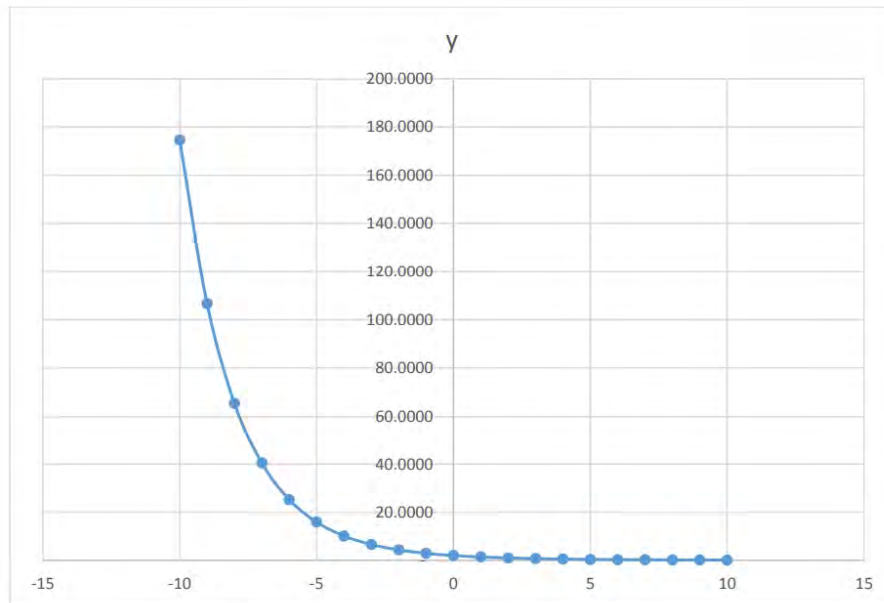

Figure 4: Graphical plot of solution of equation 3.

be minimized is the initial capital investment and where the decision variables are the numbers of units which should be pure integer numbers. While this problem has been discussed in Zaatry and Allab [1], there is only few discussion in the literature on how to take into account the uncertainties involved in the power production of PV/Wind system. As it is known, PV and Wind energy production involves a certain level of intermittency, which makes the power production rather uncertain. In a recent paper, we discussed possible use of quadruple Neutrosophic Numbers in order to expand the definition of statistical standard deviation in uncertainty modeling of various engineering systems and elsewhere [8]. It is known, that intermittency, intermittence, irregularity, unregularity, uncertainty are part of Indeterminacy, which is in between: interruption and non-interruption. Therefore we can express an expanded model statistical standard deviation to include the notion of intermittency, as follows:

$$=x'+\sigma.k = x' + \sigma(T + I + F),$$

Where T,I,F each represents truth value, indeterminacy, and falsehood. That is one of possible interpretations of quadruple Neutrosophic Numbers in the sense of expanded standard deviation, see for instance [8-10]. In this paper, we consider integer linear programming by considering bi-level values as suggested by Pramanik and Pratim Dey [3]. The purpose of this study is to show that it is possible to consider uncertainties in energy production in the linear programming model. So the results will be expressed in upper bound and lower bound limits. *Basics of Linear Programming* Linear programming deals with

problems such as maximising profits, minimising costs or ensuring you make the best use of available resources. From an applications perspective, mathematical (and therefore, linear) programming is an optimisation tool, which allows the rationalisation of many managerial and/or technological decisions. An important factor for the applicability of the mathematical programming methodology in various contexts, is the computational difficulty of the analytical models. With the advent of modern computing technology, effective and efficient algorithmic procedures can provide a systematic and fast solution to these models. A Linear Programming problem is a special case of a Mathematical Programming problem. From an analytical perspective, a mathematical program tries to identify an extreme (i.e., minimum or maximum) point of a function, which furthermore satisfies a set of constraints. Linear programming is the specialisation of mathematical programming to the case where both, function f , called the objective function, and the problem constraints are linear. Mathematical (and therefore, linear) programming is an optimisation tool, which allows the rationalisation of many managerial and/or technological decisions required by contemporary applications. An important factor for the applicability of the mathematical programming methodology in various contexts, is the computational tractability of the resulting analytical models. * Discussion on the problem in question * In this paper, we consider the same scenario of estimates of annual power production by PV and wind systems as discussed by Zaatri and Allab [1]. The two equations of constraints in integer linear programming can be expressed as follows [1]:

This problem can be solved using MS Excel (goal seek/solver), and the result is shown in the following Figure 3.

The result is : it is found that optimal number of PV cells is 6, and 31 wind systems. And the total cost is found to be USD3880. It is known, that intermittency, intermittence, irregularity, unregularity, uncertainty are part of Indeterminacy, which is in between: interruption and non-interruption. Therefore we can express an expanded model statistical standard deviation to include the notion of intermittency, as follows:

$$=x'+\sigma.k = x' + \sigma(T + I + F),$$

Where T,I,F each represents truth value, indeterminacy, and falsehood. That is one of possible interpretations of quadruple Neutrosophic Numbers in the sense of expanded standard deviation, see for instance [8-10]. Now, by simplifying procedures in Pramanik Pratim Dey [3], we can include uncertainty parameters due to intermittency/indeterminacy of energy production by PV/wind systems, so we will include an extension: a. Upper bound limit:

$$66 + 1.64 * 5).N1 + (84 + 1.64 * 7).N2 \geq 3000$$

Which comes from setting $X = x' + \sigma.k$ Where $wetake for simplicity : \sigma = 1.64, k = 5 for PV systems, and k = 7 for wind systems.$

The result is : it is found that optimal value is 6 PV sets, and 27 wind systems. The total cost is found to be: USD3455.74. a. Lower bound limit: $66 - 1.64 * 5).N1 + (84 - 1.64 * 7).N2 \geq 3000$ the result is as shown in Figure 5.

The result is : it is found that optimal value is 6 PV sets, and 37 wind systems. The total cost is found to be: USD4438.58. Therefore we conclude,

N1, N2 = integers
Constraint 1
min=130 x N1 + 100 x N2
Constraint 2
66.N1 + 84.N2 >= 3000

Figure 5: Equations to be solved.

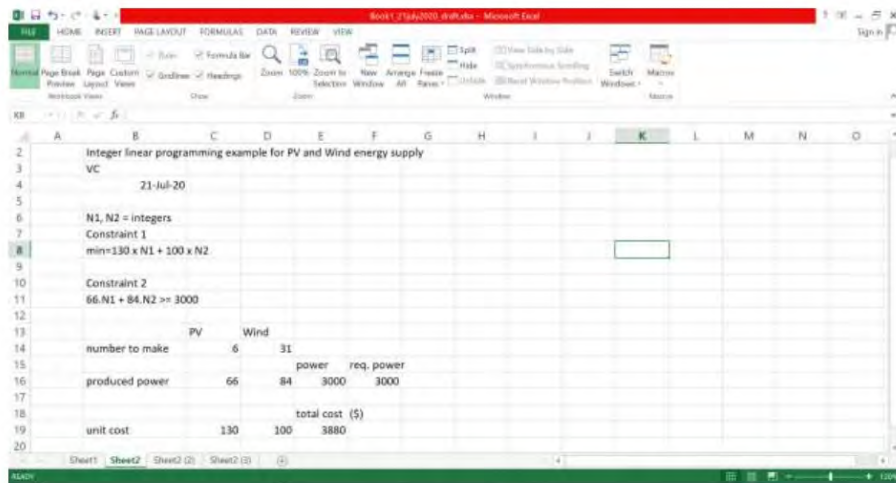

Figure 6: Result of goal seek (MS Excel) for integer linear programming.

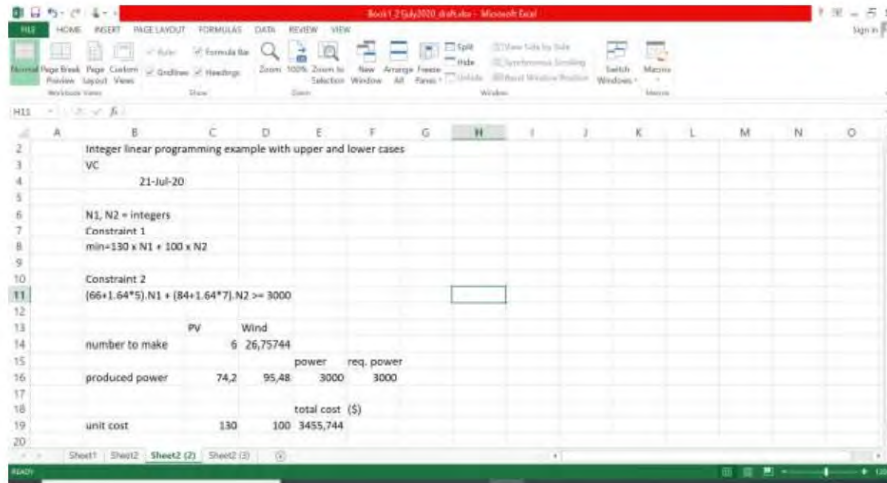

Figure 7: Result of goal seek (MS Excel) for integer linear programming.

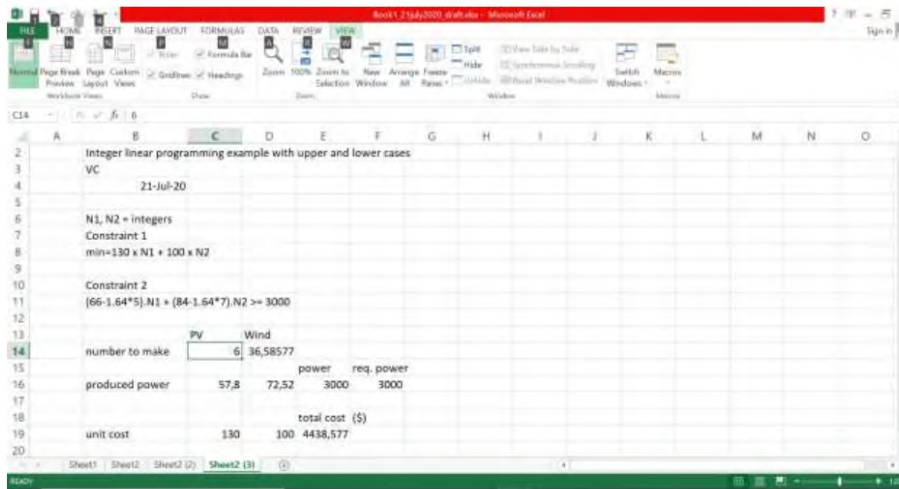

Figure 8: Result of goal seek (MS Excel) for integer linear programming.

by taking into account uncertainties due to intermittency of power production of PV/Wind systems, we come up with slightly different optimal values. For other papers discussing MCDM/linear programming in renewable energy considerations, see [2, 4-7].

9 Concluding remark

In this example, we discuss some examples on how we can use computer spreadsheet to solve engineering and mathematical problems. In the last example, by simplifying procedures in Pramanik Pratim Dey [3], we can include uncertainty parameters due to intermittency of energy production by PV/wind systems, we will include an extension: $66 + 1.64 * 5).N1 + (84 + 1.64 * 7).N2 \geq 3000$ which comes from setting $x = x' + \sigma.k$ Where we take for simplicity: $\sigma = 1.64$, $k = 5$ or PV systems, and $k=7$ for wind systems. Actual values of k should be determined by observations. Similarly, we can consider the lower bound limit by setting: $66 - 1.64 * 5).N1 + (84 - 1.64 * 7).N2 \geq 3000$ which comes from setting $x = x' - \sigma.k$ Therefore we conclude, by taking into account uncertainties due to intermittency of power production of PV/Wind systems, we come up with a slightly different optimal values. Provided we set the PV systems to be 6, we obtain upper bound number of Wind energy system to be 27, and the lower bound number is 37. This is where the subject of Neutrosophic Logic can be considered. Further investigation is recommended.

References

- [1] A. Zaatri K. Allab. *Analysis of PV/Wind systems by integer linear programming*. Revue des Energies Renouvelables Vol. 15 N°1 (2012) 111 – 120
- [2] Roghayeh Ghasempour et al. *Multi-Criteria Decision Making (MCDM) Approach for Selecting Solar Plants Site and Technology: A Review*. . Int. Journal of Renewable Energy Development 8 (1) 2019 : 15-25
- [3] S. Pramanik P. Pratim Dey. *Bi-level Linear Programming Problem with Neutrosophic Numbers*. Neutrosophic Sets and Systems, Vol. 21, 2018, University of New Mexico 110
- [4] Satyajit Das, et al. *Electrical Energy Conservation Model using Linear Programming*. International Journal on Emerging Technologies (Special Issue NCETST-2017) 8(1): 250-259(2017)
- [5] Rodrigo Martins et al. *Optimization of Photovoltaic Power Self-Consumption using Linear Programming*. Conference Proc., 978-1-5090-2320-2/16 c 2016 IEEE
- [6] O A Ivanin and L B Director. *The solution of the optimization problem of small energy complexes using linear programming methods*. J. Phys.: Conf. Ser. 774 012046

- [7] Swati Dixit. *Optimization of Household Energy using Linear Programming*. Master thesis, Department of Electrical Engineering National Institute Of Technology Rourkela, June 2014.
- [8] Victor Christianto, Florentin Smarandache, M. Aslam. *How we can extend the standard deviation notion with neutrosophic interval and quadruple neutrosophic numbers*. IJNS Volume 2 , Issue 2, PP: 72-76 , 2020. url: <http://americasp.com/articleinfo/21/show/302>
- [9] Tuhin Bera , Nirmal Kumar Mahapatra. *An Approach to Solve the Linear Programming Problem Using Single Valued Trapezoidal Neutrosophic Number*. IJNS vol. 3, no. 2 (2020). Url: <http://americasp.com/articleinfo/21/show/322>
- [10] Sapan Kumar Das, S.A. Edalatpanah *A new ranking function of triangular neutrosophic number and its application in integer programming*. IJNS Volume 4 , Issue 2, PP: 82-92 , 2020. Url: <http://americasp.com/articleinfo/21/show/346>

On mythical Dewaruci, Manunggaling kawula-Gusti and other nontrivial Javanese logic

Victor Christianto, Florentin Smarandache, Sori Tjandrah Simbolon

Victor Christianto, Florentin Smarandache, Sori Tjandrah Simbolon (2022). On mythical Dewaruci, Manunggaling kawula-Gusti and other nontrivial Javanese logic. *New Perspective in Theology and Religious Studies* 3(1), 14-22

Abstract

Discourses on logic have been for a long time predominated by Aristotelian logic, especially that is the case in the West. Although since early 20th century there are new development towards many-valued logic, for instance by Lukasiewicz etc, and also fuzzy logic theory by Lotfi Zadeh; and also in recent years there is development by one of us (FS) on Neutrosophic Logic, Plithogenic Logic etc. But still the general public usually are only accustomed to Aristotelian way. More recently, there are growing interests to consider African, Asian and also Native American logic. Nonetheless there is very rare discussion on Javanese logic, except perhaps a report by P. Stange. This article will consider some variations of logic which may show non-triviality of Javanese logic. Hopefully more readers are interested to consider this theme further.

Introduction

Although there are many developments in logic as a field in mathematics, but still the general public usually are only accustomed to Aristotelian way.[1][2]

More recently, there are growing interests to consider African, Asian and also Native American logic.[3] Nonetheless there is very rare discussion on Javanese logic, except perhaps a report by Paul Stange.[4]

This article belongs to study of interpretation of culture, see Geertz [11]. In a similar tone, we agree with Kosuke Koyama on how Christian theologians shall give respect to local cultures, as he wrote:

“Apakah di sana tidak ada kebutuhan untuk penyesuaian atau sedikitnya untuk mengubah ekspresi-ekspresi dengan cara yang fundamental? Seharusnya di sana ada katekismus Toraja-berg sebagai ganti dari katekismus Heidelberg...”[15, p. 46]

In such a spirit of *hermeneutics of respect*¹ towards local cultures, for instance by appreciating Serat Dewaruci, etc., it does not mean to argue for syncretism, but instead for cross-fertilization between Christianity and indigenous cultures especially in Asia, where Christianity were belong in the ancient time (see Acts chapter 16, how St Paul team was moved from going to Asia toward Europe, by the so-called Macedonian calling.) In other words, it is not so exaggerating to say that time has come to receive Christianity to return home to where she belongs. If that can be achieved, we believe that it is a first step to the realization of Eckhart Tolle, *A new Earth*, where he argues that it is not in the future after 1000 year kingdom reigns (cf. *The book of Revelation* chapter 21:1), but a state of consciousness:

“So the new heaven, the awakened consciousness, is not a future state to be achieved. A new heaven and a new earth are arising within you at this moment, and if they are not arising at this moment, they are no more than a thought in your head and

¹ See V. Christianto. *Hermeneutika tanpa Hermes*. Jakarta: Penerbit Bina Warga, forthcoming.

therefore not arising at all. What did Jesus tell his disciples? "*Heaven is right here in the midst of you.*"[16]

This article will consider some variations of logic which may show non-triviality of Javanese logic. Hopefully more readers are interested to consider this theme further.

Paul Stange on "ngelmu" in Javanese thinking

History of ancient civilizations reveals that Pythagoras who found a great theorem in geometry, actually led his own sect which emphasized rationality to the utmost.

But there were also other ancient communities which also try to train their disciples to live in purity, such as Essene sect near Qumran, or John the Baptist's community, and also early Christian churches.

One interesting character of Jesus's way to teach His disciples is that He apparently did not use the "formal teaching" like ancient Greek philosophers, but more informal and experiential style of teaching and discipleship.[6]

In one or another way, Javanese ancient concept of *learning* is not exactly for pursuit of knowledge as we know in the Pythagorean sense. But more like discipleship in ancient East, as we can learn in Jesus's method of discipleship.

Stange wrote on the meaning of *ngelmu* and *rasa* in Javanese spiritual practice:[4]

"In the Javanese traditional context, and among those now still experiencing a continuity with it, "knowledge" in its significant form is "*ngelmu*." Though in Indonesia "ilmu" now closely approximates Western senses of "knowledge," the Javanese term clearly refers to gnosis, to a mystical or spiritual form of knowledge which is not just intellectual but also intuitive. Another way of clarifying what is meant by "ngelmu" is that, in the end, it is the whole body, and all organs within it, rather than just the mind that "knows." This sense of knowledge underlies Javanese mystical theory not only of consciousness, but also of its relationship, which is essentially reflexive, to social and political power. "Rasa," my focus in this paper, is among other things the cognitive faculty which, as Javanese mystics understand it, we use to "know" the intuitive aspects of reality.

"The Javanese high road to insight in reality is the trained and sensitive *rasa* (*intuitive inner feeling*). In mysticism, the essence of reality is grasped by the *rasa* and revealed in the quiet *batin* (heart)... It is only by training the *rasa* that man can bridge the distance to "God."*

As part of *rasa* in Javanese logic, we can also consider why aesthetical elements such as harmony etc are essential in Javanese gamelan. An example is this writer's favorite Javanese gamelan song by Ki Narto Sabdo (a then-famous Javanese *dalang*; *dalang* means storyteller of Javanese *wayang*). The following is lyric of the *Prau Layar*:

Prau Layar²

by Ki Narto Sabdo

Yo konco ning nggisik gembiro
 Alerap lerap banyune segoro
 Angliyak numpak prau layar
 Ing dino minggu keh pariwisatao
 Alon praune wis nengah
 Byak byuk byak banyu binelah
 Ora jemu jemu karo mesem ngguyu
 Ngilangake roso lungkrah lesu
 Adik njawil mas, jebul wis sore
 Witing klopo katon ngawe awe
 Prayogane becik balik wae
 Dene sesuk esuk
 Tumandang nyambut gawe

English version:

Sailboat

by: Ki Narto Sabdo

² Source: <http://liricampursarinan.blogspot.com/2014/01/lirik-lagu-campursari-prau-layar.html>. Note: Referring back to this writer's days in Surakarta, each Tuesday evening, he and four other friends at work, went to central town at Surakarta, where we practice gamelan music. *Prau layar* was one of his favorite song by *Ki Narto Sabdo*.

Yo behind the rubbing of joy
the morning water
On weekdays a lot of tourism
Slowly the boat had calmed down
Don't get tired of smiling and laughing
Eliminate the feeling of lethargy
My younger brother smiled, apparently it was evening
It's a good idea to go back
As for tomorrow morning
We will continue working

Moreover, in the past few years, these writers have published three papers discussing the role of intuition in "real" epistemology; in fact we can say that several major discoveries have displayed intuition as guiding role, before the left-brain thinking come into play to verify and develop them further. We called that method as "intuilytics." In our scheme, intuilytics can be thought as Neutrosophic Logic contribution in the philosophy of discovery, which is a bit different from Popperian or Kuhnian scheme. (See our recent paper submitted to this journal, IJNS).

Mythical Dewaruci story: meaning of Manunggaling Kawula Gusti

As an example, a common practice for Javanese spiritual students is to teach the story of mythical Dewaruci.

As the story goes (based on Indian legend, Mahabharata, but it has been modified by Javanese teachers): One day, Bimasena was sent to seek the living water (Tirta Perwitasari) deep into the sea. After he fought and won over the sea dragon, he went into the bottom of the sea, where he met with Dewaruci, who actually is his "microcosmic consciousness" version of Bimasena himself. After giving lecture to Bimasena, Dewaruci invites Bimasena to come into Dewaruci, to be One with the Divine. But later on, Bimasena felt he did not want to go outside from the innerside of Dewaruci. But Dewaruci told him, that there are still things that Bimasena should accomplish in his life, therefore Bimasena should go down again in real world. Then Bimasena stepped out from inner side of Dewaruci. Thereafter, Dewaruci came into Bimasena and be in unity with him. "

That is the summary of the story of how Bimasena became one with Dewaruci, that is God within himself.

While at first glance, we can say that the mythical basis of this Javanese teaching may not have parallelism with Christianity or other formal religious tradition, nonetheless there are indeed some elements that can find homage to Christian's concept of unio mystica, for instance: tirta

perwitasari (or sometimes called "Tirta Amrita") can be compared to the dialog on living water between Jesus and the Samaritan woman (John chapter 4). And also Jesus often claimed that "I and Father are One." That indicates perfect unio mystica, which is known in other mytical tradition as "enlightenment" (Buddhist), or makrifat (Moslem).

Nonetheless, in the context of study of logic, how can we understand that process of unification between human as creature and God, the Creator? Certainly. Aristotelian logic which differentiates [A] and [B] without any possible merging cannot offer much help.

How to consider Unio mystica from non-Diophantine perspective

As far as we can consider, there are 2 possible explanations to consider the aforementioned spiritual union, i.e. Rupert Sheldrake's morphic resonance, and also non-Diophantine arithmetics.

Sheldrake introduced morphic resonance to represent memories which can include both the element as well as the larger entities. In other word, that concept of morphic resonance can also be thought of as a solution to Russell's paradox, i.e. the largest set that comprises all other subsets, is also a set (at least that is what we can understand on meaning of morphic resonance.)

Now we will explain the second argument, as follows.

In other papers, we argued that it seems like insurmountable task if we want to reach God in His richness, with simple binary logic (Aristotelian way), because the binary logic cannot capture the complex nature of human mind. [10][11][12].

Therefore we argue that the eastern philosophical systems, such as Manunggaling Kawula Gusti in classic Javanese belief, suggest neither nor logic, which is often called "*ngono yo ngono ning ojo ngono.*" (you can do that, but don't do like that.) That neitherness or bothness position can be considered paradoxical in terms of classical Aristotelian logic but not in sentential logic.

In other words, we can hypothesize that any system of logic which can convey neitherness or bothness situations can be considered better in order to explain the Divinity Realm.

After discussing such a logical proposition, let us consider again Iain McGilchrist.[9] As a psychiatrist, his argument on left and right function of human brain can be captured in essence as follows: the left hemisphere which usually processes in detailed manner any problem (logically) should not predominate the right brain, which capture holistic and spiritual process.

In the words of Blaise Pascal:

"The heart has its own logic, which reason cannot understand."

In that sense, both heart as spiritual brain function should not be governed by the left brain function. In other words, in spirituality realm especially in worshipping God, we should not let the emissary (Logical thinking process) to lead the master (holistic/spiritual thinking process). It should be the other way around.

This problem of choosing between Logic or going beyond Logic, or from rationality to go beyond rational thinking can be traced back even to classical history of mathematics. It is known that Pythagoreans pupils worshiped rationality and Logic in mathematics, up to the point when they were shocked when one of their disciples found an irrational number, those Pythagoreans left that disciple to drowning in the sea.

So we know that what McGilchrist described is a real issue, and not just a joke.

Similarly, several inventions in mathematics were not easily accepted at first, such as transcendental numbers, complex numbers, transfinite set, Cantor sets, or non-Diophantine arithmetics.

Let us give some examples of non-Diophantine arithmetics. From primary school, all of us learn that $1+1=2$, $2+2=4$ and so on. But if we put a cat into a room (1), then we put a tiger into the same room, then we learn that in that case, $1+1=1$. That is a good example of non-Diophantine arithmetics.

And also the arithmetics of giving follows non-standard Logic. For instance, basic arithmetics says that if you have 2 in your pocket then you give 1 to the poor, then you got $2-1=1$. But God do not sleep, so He Will bless you more, therefore from experience we learn that $2-1=2$ or may be $2-1=3$. That is another case of non-Diophantine arithmetics.

Another example is from management studies, we learn that good team work needs synergy, where $1+1=3$. That is the value of synergy is much more just addition of the members.

Finally, we can also point out that Trinitarian Logic cannot be reconciled with Aristotelian Logic or Diophantine arithmetic, as we learn that Trinity means that $1+1+1=1$.

That is also a case of non-Diophantine Logic in Theology. That non-standard Logic in understanding Trinity can be compared with the notion of uncountable noun in English grammar.

It is known that countable nouns mean $1+1=2$ and so on, like addition of two apples, two oranges, two potatoes etc.

But that arithmetic operation does not follow for uncountable nouns, for example we cannot call $\text{water} + \text{water} = 2 \text{ water}$. Because water is uncountable noun.

But we shall call it "a glass of water" or "a cup of coffee."

That is another metaphor for better understanding of Trinity from non-Diophantine arithmetics.

If we follow that reasoning, we can understand Unio mystica (Manunggaling Kawula Gusti in Javanese belief) in terms of similar non-Diophantine arithmetics, that is: adding one person to the Trinity Will still be One:

$$(1+1+1)+1=1$$

That is what mystical person refers to uniting with God.

And even Church Fathers refer to Church members are unity with God. Let say a church members having 1000 persons as members, we can write:

$$(1+1+1)+1000=1$$

They are still United in One through Christ. That is why St. Paul refer to this case as unity "in Christ." In our opinion, such an interpretation could be the best way to understand Jesus's prayer in John chapter 17, see especially John 17:22.

Concluding remark

In this short review article, we discuss several notions in Javanese tradition, like *ngelmu*, *rasa*, and *Manunggaling Kawula Gusti*, which hardly can be explained from Aristotelian perspective.

As with integrating intuition and logical faculty of human thinking process, from Neutrosophic Logic viewpoint, we come up with a new term: "intuilytics." (see a recent paper we submit to this journal).

And for describing *unio mystica*, there are two possible ways to explain: Sheldrake's morphic resonance and also non-Diophantine arithmetics.

This paper is an early discussion on this non-trivial Javanese logic.

In such a spirit of hermeneutics of respect towards local cultures, for instance by appreciating *Serat Dewaruci*, etc., it does not mean to argue for syncretism, but instead for cross-fertilization between Christianity and indigenous cultures especially in Asia, where Christianity were belong in the ancient time (see Acts chapter 16, how St Paul team was moved from

going to Asia toward Europe, by the so-called Macedonian calling.) In other words, it is not so exaggerating to say that time has come to receive Christianity to return home to where she belongs. If that can be achieved, we believe that it is a first step to the realization of Eckhart Tolle, *A new Earth*, where he argues that it is not in the future after 1000 year kingdom reigns (cf. *The book of Revelation* chapter 21:1), but a state of consciousness.

References:

- [1] Mark Zegarelli. *Logic for Dummies*. Indianapolis: Wiley Publ. Inc., 2007.
- [2] Florentin Smarandache. *A UNIFYING FIELD IN LOGICS: NEUTROSOPHIC LOGIC, NEUTROSOPHY, NEUTROSOPHIC SET, NEUTROSOPHIC PROBABILITY AND STATISTICS*. 4th ed. Url: <https://arxiv.org/ftp/math/papers/0101/0101228.pdf>
- [3] Elizabeth Hoppe & Ronald Weed (eds.) FROM ANCIENT GREEK TO ASIAN PHILOSOPHY. *Athens Institute for Education and Research*, 2007. url: <http://www.atiner.gr/docs/2006PhilosophyBook.pdf>
- [4] Paul Stange. The Logic of rasa in Java. *Indonesia* No. 38 (Oct., 1984), pp. 113-134 (22 pages). Published by: Cornell University Press. Url: <https://www.jstor.org/stable/3350848>
- [5] Susan Pratt Walton. Aesthetic and Spiritual Correlations in Javanese Gamelan Music. *Global Theories of the Arts and Aesthetics*. Url: <https://deepblue.lib.umich.edu/bitstream/handle/2027.42/75272/j.1540-594X.2007.00235.x.pdf;sequence=1>
- [6] Allan G. Harkness. De-schooling the Theological Seminary: An Appropriate Paradigm for Effective Ministerial Formation. *Teaching Theology and Religion*, ISSN 1368-4868, 2001, vol. 4 no. 3, pp 141-154

- [7] Andi Harsono. *Tafsir ajaran Serat Wulangreh*. Yogyakarta: Pura Pustaka, 2010.
- [8] Purwadi. *Babad Tanah Jawa*. Yogyakarta: Panji Pustaka.
- [9] Iain McGilchrist. *The master and his emissary*. London: Yale University Press, 2015.
- [10] Paul G. Hiebert. *The flaw of excluded middle*. *Missiology*, 1980. Sage Publ.
- [11] V. Christianto. Neutropsychology and beyond. A chapter contribution in V. Krasnoholovets, V. Christianto, F. Smarandache (eds.) *Old problems and new Horizons in World Physics*. New York: Nova Science Publ., 2019.
- [12] V. Christianto & Florentin Smarandache. *The World within Us. Indonesia*. Eunoia Publ., 2020.
- [13] Clifford Geertz. *The interpretation of cultures*. New York: Basic Books, 1973.
- [14] Hamid Nasuhi. *Serat Dewaruci*. Jakarta: Penerbit Ushul Press, 2009.
- [15] Kosuke Koyama. *Tidak ada Gagang pada Salib*. Jakarta, Gunung Mulia, 1996, p. 46
- [16] Eckhart Tolle. *A new Earth*. Penguin; Reprint edition (January 30, 2008). url: <https://eckhartolle.com/>
- [17] V. Christianto. *Hermeneutika tanpa Hermes*. Jakarta: Penerbit Bina Warga, forthcoming

Beyond Post-Empiricism Doctrine: A New Philosophy of Discovery

Victor Christianto, Florentin Smarandache, Yunita Umniyati

Victor Christianto, Florentin Smarandache, Yunita Umniyati (2022). Beyond Post-Empiricism Doctrine: A New Philosophy of Discovery. Scientific GOD Journal 13(2), 106-123

Abstract

Despite majority of theoretical physicists begin to accept the *post-empiricism doctrine*, still few physicists and mathematicians alike do not agree with such a “doctrine,” partly because it is against Popper’s criterion of falsifiability for any theory in physics and other sciences. And partly because criteria like beauty or elegance seem rather subjective for a *new theory* to be accepted as “physics”. Some physicists have written books on this topics [10-11]. In this article, we will not repeat those arguments; instead we only argue in favor of *principle of parsimony* that Nature seems to prefer least action, or least energy either in modeling complexity, assumptions and free parameters involved; thus, it is likely that minimizing computational entropy is required before getting any meaningful results. Therefore, we arrive at conclusion that one shall find a balance among some criteria, of which we may call this point “*Ockham optimality point*.”

Keywords: Principle of parsimony, Popperian epistemology, post-empiricism doctrine, Ockham optimality point, theoretical physics, mathematical physics.

I consider it quite possible that physics cannot be based on the field concept, i.e., on continuous structures. In that case nothing remains of my entire castle in the air gravitation theory included, and of the rest of modern physics. - Albert Einstein

1. Introduction

The present status of theoretical physics seems to face a dark cloud in the sky, because the highly acclaimed theories such as loop quantum gravity, superstring, M-theories and also supersymmetry theories cannot be verified by experiments, at least not within the present limit of measurement devices. Therefore, some theoreticians like Dawid began to argue in favor of *releasing the verifiability criterion* for any theory to be accepted as working physics theories [12]. That kind of post-empiricism doctrine, as it is called, is supposed to supersede the conventional Popperian epistemology, which include falsifiability for any theory before it can be accepted.

*Correspondence: Victor Christianto, Ekklesia Advanced School of Theology (EAST), Jakarta, Indonesia.
Email: victorchristianto@gmail.com

However, some prominent cosmologists and theoreticians disagree with that doctrine. Attempts to exempt speculative theories of the Universe from experimental verification *undermine science*, argue George Ellis and Joe Silk [7][8]. They also wrote:

Faced with difficulties in applying fundamental theories to the observed Universe, some researchers called for a change in how theoretical physics is done. They began to argue explicitly that if a theory is sufficiently elegant and explanatory, it need not be tested experimentally, breaking with centuries of philosophical tradition of defining scientific knowledge as empirical. We disagree.

But, despite some physicists have emphasized on the virtue of empirical test and conceptual simplicity, such criteria appear not so clear to be applied at research practice on daily basis. Therefore, there is a need to apply such criteria on simplicity or *principle of parsimony* in a more operational way.

2. Intuition and Neutrosophic way of doing science

In a recent article, we argue on the role of intuition in doing science [2][3], apart of the so-called Dirac's dictum that to *find new physics, we shall find new mathematics*. In our proposed "Neutrosophic way", it is intuition (or in German, *einfihlung*) that should be given more emphasis. Any effort to depict or map life or reality as an abstract substance needs to use real life or concrete experience to arrive at such an understanding. To choose actual experiences and to connect it with the abstract domain, one needs intuition.

As this work emphasizes [3]:

More "right brain" activity, based on direct experiences, leads to direct experiences of the Divine. Your "inner vision" (the "mind's eye") can help readers in this, and in many other ways. The inner vision is also the seat of many of the *intuitive* faculties, which are experiencable facts, not imaginings. That means the information obtained by the intuitive faculty is verifiable and reproducibly observable.

In order to do that, the Balanced Brain is the most efficacious way to function, as well as the most efficient, and the most comfortable.

To obtain the Balanced Brain, the person usually needs to spend a great deal of their spare time being receptive, being the "receiver", being accepting and exploring, and not using the analytical intellect, but instead, spending time in the Now and in the Senses and Sensitivities. This is best enjoyed in Natural settings.

Therefore, to reply to the question concerning rectifying the problem of overemphasizing *rationality in mathematics*, McGilchrist's concept and Conceptual Linguistics theory can shed light [2, 4].

From Neutrosophic Logic viewpoint, this article recommends that a combination:

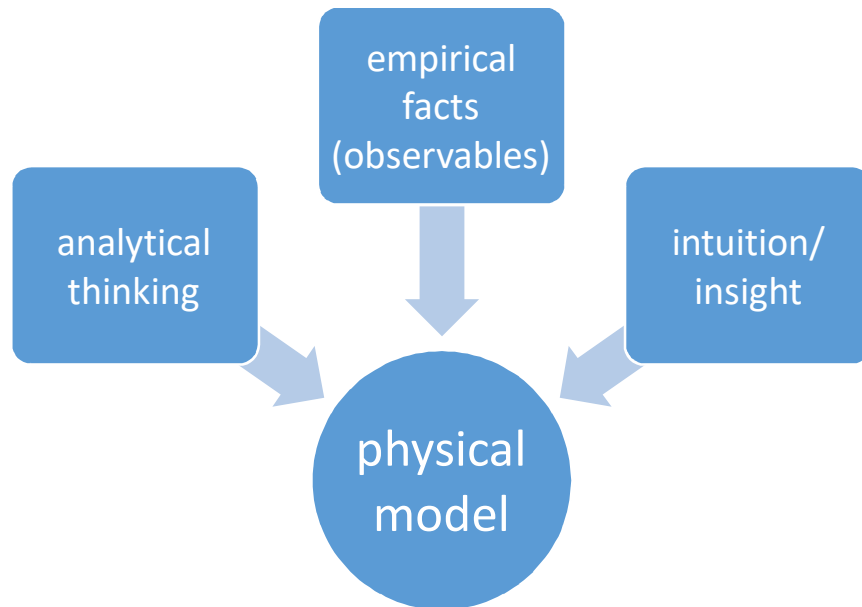

Diagram 1. The role of intuition, analytical thinking, and empirical facts

In the above diagram, we emphasize both the intuitive aspect of the right hemisphere and the analytical or logical thinking processes of the human's left brain, that they will be more adequate in creating a holistic approach. The article proposes a term: “**intuilytics**” to capture the essence of the *Balanced Brain* [3].

With regards to scientific discovery processes, the proposed scheme as outlined above hint toward a slightly different approach compared to Popperian method or Kuhnian concept of paradigm change. Therefore, in addition to the role of intuition and analytics/rational thinking, we need empirical facts as the basis of model building. To emphasize those triplet, see Diagram 1 above.

To illustrate the aforementioned point, and regarding our personal experience, the first author shares a little about his dream long time ago of being an inventor. In the past, he was educated at one of the engineering faculties at a state campus in East Java, Indonesia. But about halfway through his engineering study, he found passion in more humanities books: such as, E.F. Schumacher etc. And also how to think more creatively. When he read textbooks such as

foundation engineering, such as *la terre armee* (earth reinforcement), what comes to mind is not just how to calculate and so on. But it was more about the process of making the discovery: How did Henri Vidal find *la terre armee*?¹ - then how did people find the prestressing method? Or how Dr. Sedijatmo found the chicken-raft foundation? (cf. It is one of Indonesia's engineering invention)².

Only recently, around two years ago, after discussions with several senior physicists, notably RNB, there was a suggestion that the discovery process generally begins through intuition, or to be precise the right brain thinking process. Although there is also an analytical process, it is usually an analytical process will not yield any significant new findings. From there then began to develop the term: *intuilytics*. For physicists, some readers are more familiar with the German phrase: *enfuhlung*.

Then he found the work of a psychiatrist: Iain McGilchrist which actually reinforces this belief, meaning that the centuries-old tendency to put pressure on the left brain function is not good and *tends to destruct the entire Western civilization* [4]; and if humanity wants to grow its consciousness, it must prioritize right brain functions first, including the functions of holistic, spiritual, and intuitive thinking.³ New analytic function is only to verify what the right-brain process registers. That's why he doesn't agree with the idea of transhumanism, ala *Homo Deus*, as suggested by Yuval Noval Harari, a historian from Hebrew University. It is more likely, the future of humanity is heading toward *homo spiritus*, in Sir David R. Hawkins' term [24]. He does not see a good future if we continue the process of integrating humans and data, then as a whole we will be tapped and consumed by big data and supercomputers. And this is precisely what the IoB/Rand Report's plan seems to be designed for (IoB: internet of bodies). Praise God, our article on the relationship of integrative thinking/McGilchrist and reinterpreting Pancasila, our nation's philosophy of life, has been published recently in the NPTRS Journal [25].

Some readers may ask at this point, the Diagram 1 above looks too simplifying for a method, doesn't it? Yes, it is true, but let us consider that even for well-known mathematicians such as G. Polya, something more than mathematics methods; something deeper like curiosity etc. are

¹ Url: <https://www.terre-armee.com/about/>

² Origin of discovery: "The chicken claw foundation was discovered by Professor Sedijatmo in 1961. At that time, Sedijatmo accidentally saw a palm tree trunk swaying in the wind. The palm tree remained firmly standing even though the soil structure was unstable. From here, Sedijatmo created a "stringy" foundation of concrete pipes that support large buildings, known as the chicken claw foundation. This chicken claw foundation adopts the shape of the palm tree adaptation ..." source: <https://brainly.co.id/tugas/26826541>

³ *Postscript note*: Interestingly, John Perkins, a best-seller author of popular economics books, also argues in favor of Life Economy, in contrast to common practice of Death Economy. Life Economy can be argued as more appreciative to human and Nature's life, much more than short term utility maximisation. The difference here is that in Perkins's thought, Death Economy began around 1970-1980s, while according to Dr. Iain McGilchrist, it went back to at least 16 centuries back to early Church Fathers. Nonetheless, in his book, Perkins argue a set of practical ways to do more towards realization of Life Economy. See: John Perkins, *Touching the Jaguar*. Oakland: Berrett-Koehler Publishers, Inc., 2020.

needed to solve a real-world problem. As he wrote in his book: “*How to solve it,*” as follows: “Behind the desire to solve this or that problem that confers no material advantage, there may be a deeper curiosity, a desire to understand the ways and means, the motives and procedures, of solution.” Other mathematicians like Jacques Hadamard also wrote on psychology of invention in the mathematical field⁴.

So what would such a discussion bring to us? May be if we rely and follow through our heart and our guts, we may someday will come up with a set of original approaches to mechanics or gravitation theory, see for example: *Neo-Newtonian Mechanics* by a senior mathematician fellow, Dennis P. Allen, Jr., *et al.* [22-23].

3. On Principle of Parsimony & Ockham Optimality

As we argued in a recent paper [5-6], this deep problem in philosophy of science can be viewed as another case that calls for implementation of Neutrosophic Logic: i.e. whenever there are two opposite sides, there is always a choice to find a neutral side, in order to reconcile those two opposite sides. We can also think of them starting from the *principle of contradiction*, proposed by Kolmogorov [9]. To summarize, he argues that there is fundamental problem in developing complex arguments, they always lead to contradiction. This was proven later by G del. See [6].

What can we conclude from Kolmogorov’s principle of contradiction? It is quite simple, *i.e.*, developing a complicated theory from a number of postulates will very likely lead to messy contradictions, which are often called “paradoxes,” just like the twin paradox in general relativity, or cat paradox in quantum wave function. To put this problem succinctly, we can paraphrase Arthur C. Clarke’s famous saying: “Any sufficiently advanced technology is indistinguishable from magic,” (Arthur C. Clarke, *Profiles of The Future*, 1961⁵) to become “*Any sufficiently complicated theory will result in a number of contradictions and paradoxes.*”[6]

Such a logical analysis derived from Kolmogorov’s principle of contradiction eventually remind us of the following:[6]

- (a) To keep humble mind before Nature (God's creation), and perhaps we should not rely too much on our logic system and mathematical prowess;
- (b) In developing a theory one should keep complications and abstractions to a minimum; &

⁴ Special thanks to Dennis P. Allen, Jr., for reference to G. Polya, J. Hadamard and also his on-going works on Neo-Newtonian Mechanics and Gutschian Mechanics.

⁵ Clarke's third law. url: <http://www.quotationspage.com/quote/776.html>

(c) To build theory in the nearest correspondence to the facts; it is the best if each parameter can be mapped to a measurable quantity.

We hope the above three criteria can be a useful set of practical guidelines for building mathematical models in theoretical physics, cosmology etc.

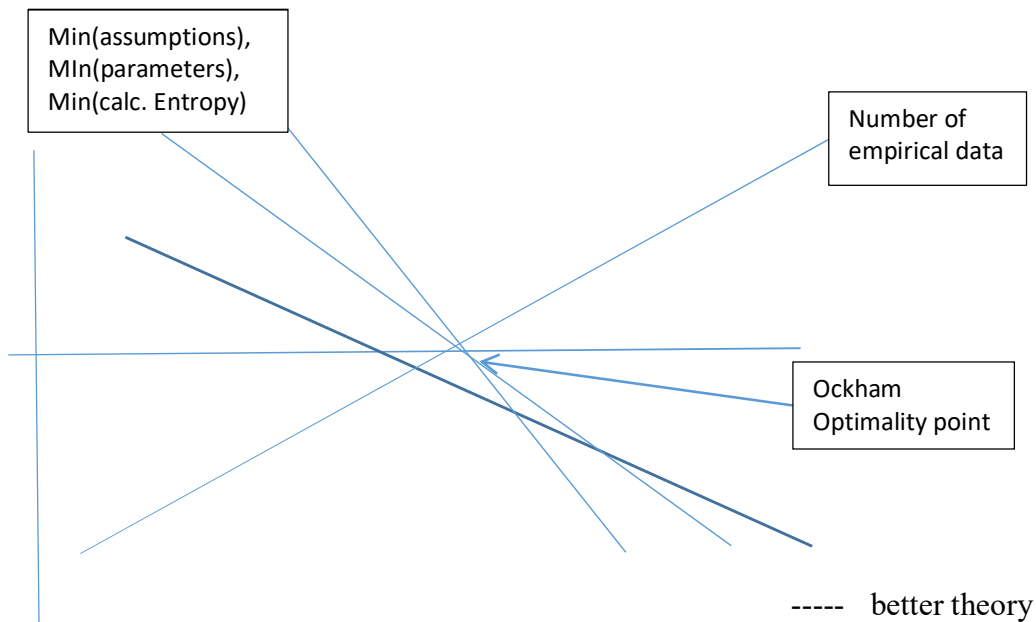

Diagram 2. How to find Ockham optimality point

To emphasize the aforementioned argument, from Neutrosophic Logic perspective, the old tensions between mathematicians (opposite 1) and experimenters (opposite 2), can be reconciled if we can consider a third approach. Those the available approaches would be somewhere in the following spectrum:

Mathematics (opposite 1) – evidence-based mathematics – experiments (opposite 2)

Therefore, the middle way that we submit as a plausible resolution to the present stagnation of modern physics, is to come up with “*evidence-based mathematics.*” At this point, some readers may ask: But how can we apply such a principle of parsimony into practice?

To put the above three criteria into more practical guidelines, allow us to distinguish such a Principle of Parsimony (or in more popular term: Ockham razor) into several possible approaches:

1. To minimize assumptions involved (conceptual simplicity)
2. To minimize number of parameters (model simplicity)
3. To minimize calculation procedures (calculational simplicity)
4. To minimize computational/algorithm entropy (computational simplicity)
5. To maximize coverage of empirical facts to be explained (“*evidence based physics*”). To make these criteria a bit more comprehensible, we can draw a diagram as follows:

Three examples

We have presented a more operational definition of *Principle of Parsimony*, allow us to give a few examples as illustrations, that sometimes: even the standard spacetime notion may be excluded to arrive at a good explanation of a set of observed phenomena.

Example 1 [14]

There are various models of electron which have been suggested, for instance see Chekh *et al.* But we seek a more realistic electron model which is able to describe to experiments conducted by Winston Bostick *et al.* [17]. In our attempt to explain such experiments of electron creation in plasma, allow us to come up with a new model of electron, based on Helmholtz’s electron vortex theory. In turn, we will discuss a plausible model of electron capture event inside Earth (matter creation), which can serve a basis to explain Le Sage/Laplace’s push gravity. We discussed its implications along with receding planets effect from central Sun in a paper.⁶

The Helmholtz vortex model of the electron as illustrated in the photo of a Helmholtz vortex (Fig. 1), is a toroid made of nested concentric toroidal flows of smaller particles, perhaps the inertons of Krasnoholovets, or aggregate particles made from Bhutatmas. (The Bhutatma infinitesimal particle of Vedic lore is the ultimate building block of everything, being the smallest unit of matter, and at the same time, the smallest unit of Consciousness.)

⁶ Postscript note: see Christiano, Boyd, Smarandache, 5th Conference of Plasma Physics, held in Stockholm, 2018.

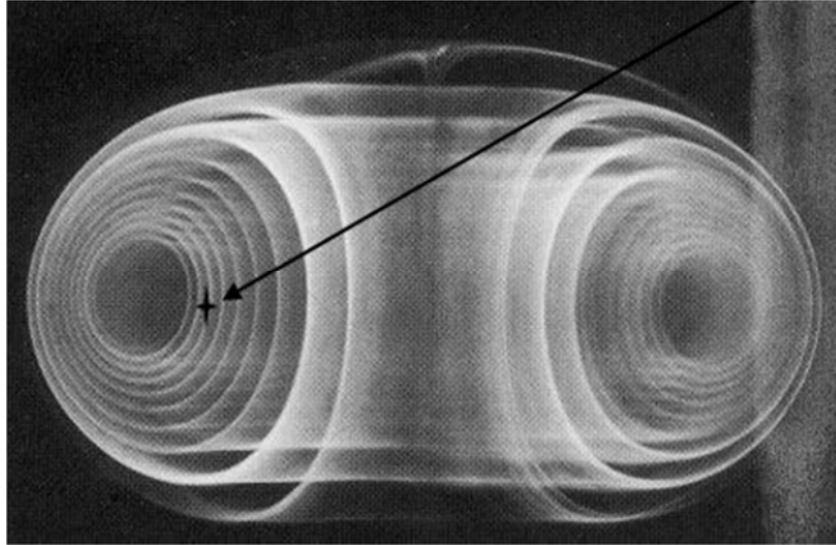

Figure 1. Helmholtz vortex model of electron (as verified by Bostick *et al.* [17])

Example 2 [15]

The golden ratio effectively enables multiple oscillators within a complex system to co-exist without blowing up the system. But it also leaves the oscillators within the system free to interact globally (by resonance), as observed in the coherence potentials that turn up frequently when the brain is processing information. Obviously, this can be tied in to the creation of subatomic particles such as electrons and positrons. At a certain scale of smallness, the media in the local volume becomes isotropic, while larger volumes exhibit occupation by ever-larger turbulence formations and exhibit extremes of anisotropy in the media.

The Kolmogorov Limit is $10e^{-58}$ m, which is the smallest vortex that can exist in the aether media. Entities smaller than this, down to the SubQuantum infinitesimals (Bhutatmas) (vortex lines) are the primary cause of gravitation (cf. R.N. Boyd). Shadow gravity is valid in the situation of gravitational interaction between two discrete masses that divert the ambient gravitational flux-density away from each other. This happens due to absorption (rare), scattering (more common), and refraction (most of the time) of gravitational infinitesimals.

Gravitational flux density is a variable depending on stellar, interstellar, and intergalactic events. A simplified model of vorticity fields in large scale structures of the Universe is depicted below:

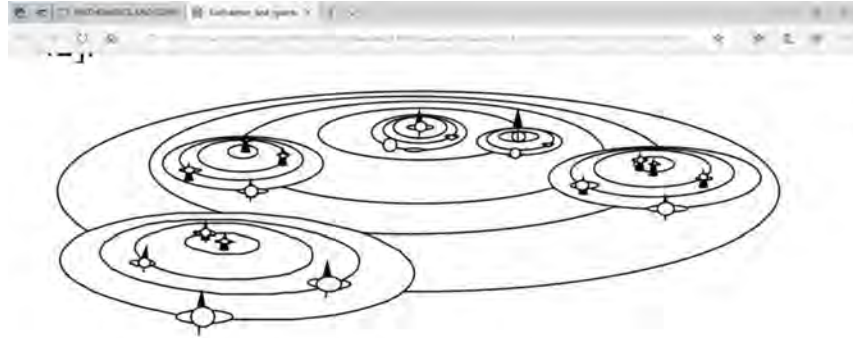

Fig.2 Description of internal (iso-spin) versus external vorticity fields in cosmology [41].

Figure 2. Vorticity fields in cosmology (after Siavash Sohrab [18])

The above diagram seems to be able to capture the turbulence phenomena from Planckian scale to cosmos. What is more interesting here, is that it can be shown that there is correspondence between Golden section and in coupled oscillators and KAM Theorem, but also between Golden section and Burgers equation.

Now one of questions is: how to write down Navier-Stokes equations on Cantor Sets? Now we can extend further the Navier-Stokes equations to Cantor Sets, by keeping in mind their possible applications in cosmology. By defining some operators as follows:

In Cantor coordinates :

$$\nabla^\alpha \cdot u = \text{div}^\alpha u = \frac{\partial^\alpha u_1}{\partial x_1^\alpha} + \frac{\partial^\alpha u_2}{\partial x_2^\alpha} + \frac{\partial^\alpha u_3}{\partial x_3^\alpha}, \tag{1}$$

$$\nabla^\alpha \times u = \text{curl}^\alpha u = \left(\frac{\partial^\alpha u_3}{\partial x_2^\alpha} - \frac{\partial^\alpha u_2}{\partial x_3^\alpha} \right) e_1^\alpha + \left(\frac{\partial^\alpha u_1}{\partial x_3^\alpha} - \frac{\partial^\alpha u_3}{\partial x_1^\alpha} \right) e_2^\alpha + \left(\frac{\partial^\alpha u_2}{\partial x_1^\alpha} - \frac{\partial^\alpha u_1}{\partial x_2^\alpha} \right) e_3^\alpha \tag{2}$$

2. In Cantor-type cylindrical coordinates:

$$\nabla^\alpha \cdot r = \frac{\partial^\alpha r_R}{\partial R^\alpha} + \frac{1}{R^\alpha} \frac{\partial^\alpha r_\theta}{\partial \theta^\alpha} + \frac{r_R}{R^\alpha} + \frac{\partial^\alpha r_z}{\partial z^\alpha}, \tag{3}$$

$$\nabla^\alpha \times r = \left(\frac{1}{R^\alpha} \frac{\partial^\alpha r_\theta}{\partial \theta^\alpha} - \frac{\partial^\alpha r_\theta}{\partial z^\alpha} \right) e_R^\alpha + \left(\frac{\partial^\alpha r_R}{\partial z^\alpha} - \frac{\partial^\alpha r_z}{\partial R^\alpha} \right) e_\theta^\alpha + \left(\frac{\partial^\alpha r_\theta}{\partial R^\alpha} + \frac{r_R}{R^\alpha} - \frac{1}{R^\alpha} \frac{\partial^\alpha r_R}{\partial \theta^\alpha} \right) e_z^\alpha$$

Then Yang, Baleanu and Machado are able to obtain a general form of the Navier-Stokes equations on Cantor Sets as follows :

$$\rho \frac{D^\alpha v}{Dt^\alpha} = -\nabla^\alpha \cdot (pI) + \nabla^\alpha \left[2\mu(\nabla^\alpha \cdot v + v \cdot \nabla^\alpha) - \frac{2}{3}\mu(\nabla^\alpha \cdot v)I \right] + \rho b \quad (4)$$

The next task is how to find observational cosmology and astrophysical implications.

Example 3:

Many physicists and philosophers alike have debated a long standing puzzle: whether the space is continuous or discrete. It has been known for long time that most of the existing cosmology models rely on pseudo-Riemannian metric as the cornerstone of Einsteinian universe. But the metric itself is based on continuum model. It is known that such models have led us to too many (monster) problems, including dark matter and dark energy etc. Now what if the universe is discrete? Then perhaps we can solve these problems naturally.

Philosophically speaking, the notion of discrete space can be regarded as basic question in definition of differential calculus and limit. If it is supposed that space is continuous then we can use standard differential calculus, but if we assume it is finite and discrete, then we should use difference equation or finite difference theories. This problem is particularly acute when we want to compute our mathematical models in computers, because all computers are based on discrete mathematics. Then we can ask: is it possible that the discrete mathematics can inspire cosmology theorizing too?

Despite majority of cosmologists rely on such a Standard Model which is called Lambda CDM theory, we will explore here the redshift theory based on a few of lattice-cellular models, including Lindquist-Wheeler theory and beyond it.

We will discuss here some peculiar models such as Voronoi tessellattice and also Conrad Ranzan’s cellular model. It is our hope that the new proposed method can be verified with observation data.:

a. Lindquist-Wheeler’s theory:

In this model, the matter content is assumed to be discrete; identical spherically symmetric islands uniformly distributed in a regular lattice. This attempt was first introduced in 1957 by Lindquist and Wheeler (LW) in a seminal paper. While LW suggested that their global dynamics is similar to Friedmann universe for closed dust dominated universe, Shalaby has shown that LW-model can be extended to yield a redshift equation, as follows [16-16a]:

$$1 + z = 1 + \langle \gamma \rangle \ln \left(\frac{a_r}{a_e} \right) = 1 + \langle \gamma \rangle \ln(1 + z_{FRW}) \cong (1 + z_{FRW})^{\langle \gamma \rangle} \quad (5)$$

It can be shown, that the value of $\langle \gamma \rangle$ approximates geometrically to be $2/3$, however, numerically its value was estimated to be $7/10$. Liu also analyzed LW model, and he concludes that the LW redshifts can differ from their FLRW counterparts by as much as 30%, even though they increase linearly with FLRW redshifts, and they exhibit a non-zero integrated Sachs-Wolfe effect, something which would not be possible in matter-dominated FLRW universes without cosmological constant [16a].

b. Voronoi Tessellation model:

Rien van de Weygaert describes a novel model based on Voronoi tessellation. The spatial cosmic matter distribution on scales of a few up to more than a hundred Megaparsec displays a salient and pervasive foamlke pattern. Voronoi tessellations are a versatile and flexible mathematical model for such weblike spatial patterns. Cellular patterns may be the source of an intrinsic geometrically biased clustering. However, so far we do not find a redshift equation from this model [26].

c. Nonexpanding cellular universe:

Conrad Ranzan suggests a DSSU cellular cosmology (dynamics steady state universe), which he claims to be problem-free. The cosmic redshift is shown to be a velocity-differential effect caused by a flow differential of the space medium. He obtains the cosmic redshift equation in its basic form[27]:

$$z = (1 + z_{GC})^N - 1 \quad (6)$$

There are of course other cellular cosmology models, some of them have been reviewed by Marmet, but this paper is not intended for such an exhaustive list of redshift models.⁷

4. On Self-Organized Criticality as a Model of the Scientific Development

In the aforementioned sections, we argue in favour of more balanced-brain approach to scientific discovery process, which we submit with a new term “intuilytics”. In this section, allow us to put forth an alternative perspective other than “revolutionary” model of scientific development (cf. Thomas Kuhn.) If we are willing to learn from history, “*revolution*” word often leads to fascism. And in that case, there is wise phrase to warn us: “You can build a throne out of bayonets, but you can't sit on them long.”⁸

⁷ *Postscript note:* Elsewhere, in a paper at Prespacetime Journal, we discussed Zeldovich's approach which is often called as “cosmic web” theory, which seems to capable to discrete cellular large-scale pattern of the Universe. Interestingly, several researchers argue in favor to linking the cosmic web theory with galactic grids, and even some authors argue that advanced interstellar travelling methods can be devised through those galactic grids; also known as *cosmic filaments*.

⁸ <http://marvin.cs.uidaho.edu/About/quotes.html>

In our proposed perspective, in its simplest form and according to a conventional belief held by most science communities, sciences can advance by at least four ways: (a) Incremental approach by virtue of scientific methods; (b) Paradigm shift; (c) Christensen's disruptive change; (d) Self-organized criticality, but they are rarely employed for describing scientific progress.

Paradigm shift has been advocated by a notorious science historian, Thomas Kuhn. According to his proponents, one of the most interesting features of Thomas Kuhn's work in "*The Structure of Scientific Revolutions*" is its naturalism. But naturalism is just another philosophical strand which may or may not agree with empirical data itself. Despite its widespread acceptance, the fact is that such a term of paradigm shift is not often tested empirically. There are other ways to describe innovation changes, namely, alternative (c) and (d) above.

Therefore, we will review a recent work which uses citation analysis of journal-journal for the past recent years. This analysis reveals that scientific progress seems to follow self-organized criticality.

A review of 4 methods of human knowledge progress

There are some papers in literature which indicate those 4 methods, as we will review briefly as follows:

- a. Incremental approach: by virtue of scientific methods, science advances by small steps. Until the 1950s, the hegemony of logical empiricism reached to its highest level- by the representatives of the logistic approach such as R. B. Braithwaite, Rudolf Carnap, Herbert Feigl, Carl G. Hempel, and Hans Reichenbach. Prior to Kuhn's SSR, historians and philosophers of science considered the scientific enterprise to be a rational endeavor in which progress and knowledge are achieved through the steady, daily, rigorous accumulation of experimental data accredited facts and new discoveries [30][31].
- b. Paradigm shift:
Thomas Kuhn's Structure of Scientific Revolutions (SSR) is accepted to be one of the main books in the twentieth century. The book considered an entire industry of editorial, translation, and interpretation. The development of another scholarly discipline - the social science of science-appeared around a common worldview following Kuhn's accentuation on the significance of networks of researchers. After the book was distributed analysts started to look at logical teaches much as sociologists concentrated on friendly/social gatherings, and in which science was viewed not as the most regarded, unapproachable result of the Enlightenment yet as simply one more subculture. However, as Kuhn guaranteed *the way of thinking and humanism of science can't be drilled freely of one another*. However, Kuhn saw the networks (not people) as the essential

specialists of science and he imagined that networks should be described by the particular mental qualities to which they are committed.

After the 1960s and 70s, following Kuhn's historiography, and savants, for example, Paul Feyerabend, Imre Lakatos, Larry Laudan and Michael Polanyi have enormously added to the making of an enemy of positivistic way of thinking of science as another custom. History of science after Kuhn has every now and again taken an all the more intentionally externalist line, in looking external science for the reasons for the substance of science [30][31].

c. Disruptive change:

In his article in *Harvard Business Review*, Clayton Christensen, differentiates between: Sustaining innovations and disruptive innovations.[33] This seems to follow Schumpeterian view of creative destruction. But this paper will not focus on disruptive innovation. See also his more recent article in HBR 2015.

d. Self-Organized Criticality:

Self-organized criticality is a rich phenomenon as it combines self-organization and criticality to describe complexity. This concept was first introduced by P. Bak and the collaborators in the seminal paper in 1987, and also in his book [32]. This notion is meant to be a property of dynamical systems to organize its microscopic behavior to be spatial (and/or temporal) scale independent. That resembles of the critical behavior of the critical point of phase transitions.

Now, allow us to discuss shortly a comparison between citation analysis of journal-journal as a way of knowledge creation process, and our computational simulation approach of creation process of the Universe, based on Ermakov nonlinear equation, as follows:

Results of citation analysis

Bolijka Tadic *et al.* have reported self-organized criticality pattern in online social behavior especially in knowledge creation process [30]. But the first convincing citation analysis to prove this pattern has been made by Loet Leydesdorff, Caroline S. Wagner, and Lutz Bornman [20]. As we know, journals play a crucial and institutionalized role in the validation of knowledge claims and in the incorporation of new knowledge into the archive of science. Given their role in the codification of knowledge, journals can be considered as an organizing layer of the scientific literature. Not incidentally, the *Science Citation Index* (SCI) and its derivatives (the *Social Sciences Citation Index* (SSCI) and the *Arts & Humanities Citation Index* (AHCI)) were defined in terms of specific journal selections (Garfield, 1972; 1979b), as is Scopus, the main competitor of the SCI since 2004 [29][30].

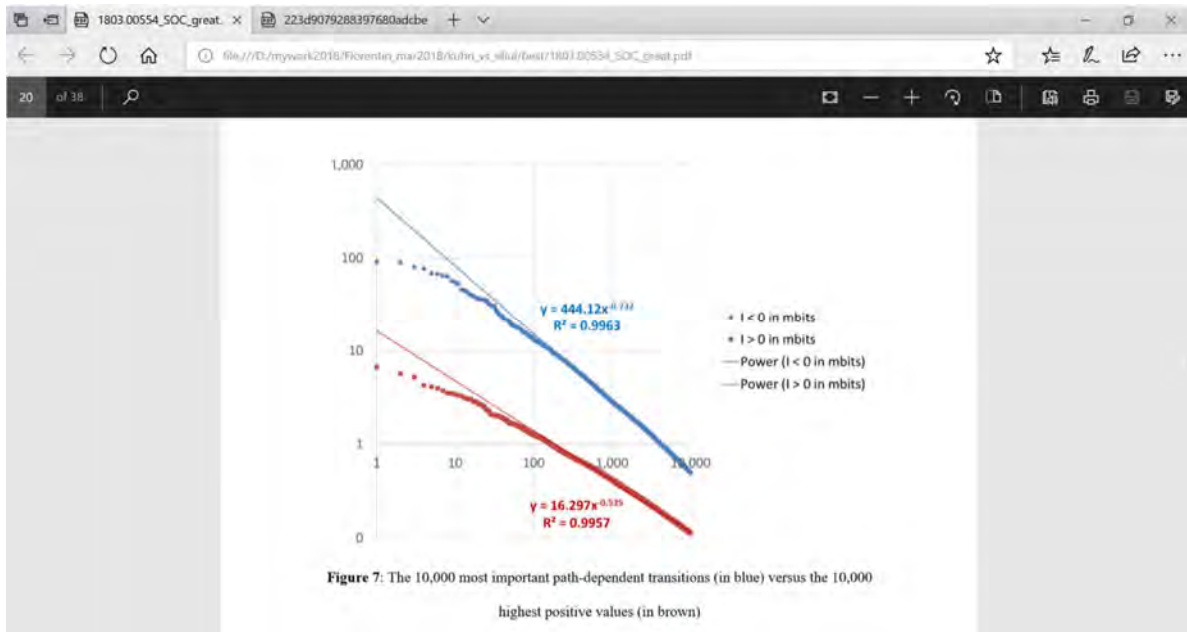

Diagram 3: Source: Leydesdorff *et al.* [29]

Comparison with our model of abrupt origin of the Universe

Now we will compare this citation analysis result with our proposed model of the origin of the Universe. It has been known for long time that most of the existing cosmology models have singularity problem. Cosmological singularity has been a consequence of excessive symmetry of flow, such as “Hubble’s law”. More realistic one is suggested, based on Newtonian cosmology model but here we include the vortical-rotational effect of the whole Universe.

In other paper, we obtained an Ermakov-type equation following Nurgaliev [35]. Then we solve it numerically using Mathematica 11. An interesting result from that simple computational simulation is shown in the following diagram [36][37]:

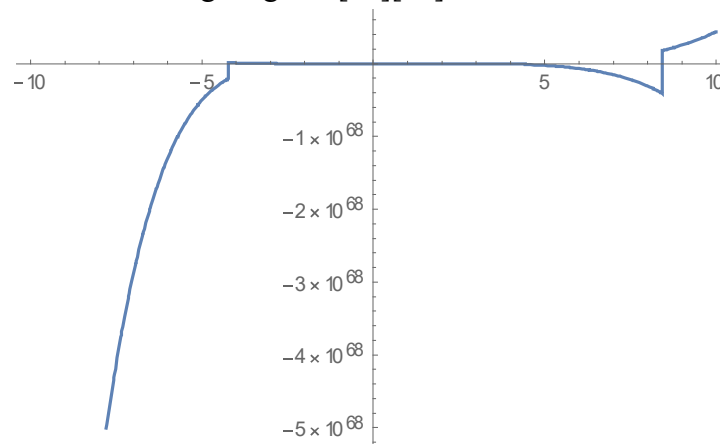

Diagram 4. Plot of Ermakov-type solution for A 1, B -10 (after [36-37])

From the above computational simulation, we conclude that the evolution of the Universe depends on the constants involved, especially on the rotational-vortex structure of the Universe. This needs to be investigated in more detailed for sure. One conclusion that we may derive especially from Diagram 4, is that our computational simulation suggests that it is possible to consider that the Universe has existed for long time in prolonged stagnation period, then suddenly it burst out from *empty and formless* (Gen. 1:2), to take its current shape with observed “accelerated expansion.” Comparing our model of abrupt origin of the Universe with the above citation analysis, it seems both reveal similarities. But whether such an abrupt creation/origin of the Universe also indicates Per Bak’s model feature, remains open for further study.

5. Conclusions

Despite majority of theoretical physicists begin to accept the *post-empiricism doctrine*, still few physicists and mathematicians alike don’t agree with such a doctrine, partly because it is against Popper’s criterion of *falsifiability* for any theory in physics and other sciences as well. And partly because criteria like beauty or elegance seem rather subjective for a theory to be accepted as ‘physics’.

In this article we have discussed several more operational criteria to apply the Principle of Parsimony into day to day model building processes. We also discuss *Ockham optimality* and also a number of examples. Further, despite its enormous popularity in the past 5-6 decades, paradigm shift view of scientific progress has not been tested quite often. Therefore, in this paper we review a recent work which uses citation analysis of journal-journal for the past recent years. This analysis reveals that scientific progress seems to follow *Self-Organized Criticality pattern*. Comparing our model of abrupt origin of the Universe with the above citation analysis, it seems both reveal similarities. But whether such abrupt origin of the Universe also indicates SOC feature, remains open for further study.

It can be expected that the above discussions will shed some lights on such an old problem especially in the context of modelling scientific progress based on empirical data (evidence based). This is reserved for further investigations.

Postscript

In a recent draft paper with S. Ershkov, S. Alhowaity & E.I. Abouelmagd,⁹ we argue that there is analytical solution of Ermakov-Pinney equation, which is usually considered difficult to solve analytically. By mentioning previous works by Tsekov (Physica Scripta, etc.), and also Lidsey on BEC cosmology, even if we don’t have a complete arguments yet at hand, we are convinced that if there is a

⁹ Sergey Ershkov, Victor Christianto, Sawsan Alhowaity, & Elbaz I. Abouelmagd. *Revisiting solving procedure for Ermakov–Pinney equation with applications in the field of cosmology*. In preparation, to be submitted to a physics journal, May 2022.

(nonlinear dynamics) equation which can describe both microcosm realm (QM) as well as macrocosm dynamics (cosmology), that is Ermakov-Pinney equations. More interestingly, EP equations can be transformed into Riccati equations. Maybe, just maybe, this is a little step toward finding a *low-temperature physics approach of everything* (LTPE), as we already know from discussion above that superstring/M theory and its multiverse implications is hopeless (cf. P. Woit, also S. Hossenfelder, [10-11]). Nonetheless, we admit that there is still long road to go on this approach of low temperature cosmology.

References

- [1] George Ellis & Joe Silk. Defend the integrity of physics. *Nature* vol. 516, 18 December 2014.
- [2] V. Christianto , F. Smarandache. Victor Christianto and Florentin Smarandache. “Exploring the Historical Debates on Irrational Numbers Using Neutrosophic Logic as a Balance between Intuition and Rational”. *EC Neurology* 13.6 (2021).
- [3] V. Christianto, R.N. Boyd, F. Smarandache. How to balance the intuitive and analytical function of the human brain. *E.C. Neurology* 11.7 (2019): 495-499.
- [4] Iain McGilchrist. *The Master and his emissary: The divided brain and the making of the Western World*. Yale University Press, 2009.
- [5] V. Christianto & F. Smarandache. “Lost in Math”: The perils of postempirical science and their resolution. *Prespacetime J.* 2020
- [6] V Christianto & F Smarandache. A Review of Seven Applications of Neutrosophic Logic: In Cultural Psychology, Economics Theorizing, Conflict Resolution, Philosophy of Science, etc. *J*, March 2019. www.mdpi.com
- [7] George Ellis. The Multiverse, ultimate causation, and God. Talk at Emmanuel College, 6th Nov. 2007. url: [https://www.faraday.st-edmunds.cam.ac.uk/resources/George 20Ellis 20Lecture/Ellis-Faraday.pdf](https://www.faraday.st-edmunds.cam.ac.uk/resources/George%20Ellis%20Lecture/Ellis-Faraday.pdf)
- [8] Jim Baggott. Post-empirical science is oxymoron. *Aeon*. url: <https://aeon.co/essays/post-empirical-science-is-an-oxymoron-and-it-is-dangerous>
- [9] Charpentier, E.; Nikolski, A.L.N. *Kolmogorov heritage in mathematics*. Springer: Berlin/Heidelberg, Germany, 2007, p. 25
- [10] Peter Woit. *Not even wrong*. London: Jonathan Cape, 2006.
- [11] Sabine Hossenfelder. *Lost in Math: How beauty leads physics astray*. Basic Books, 2018. url: <https://www.amazon.com/Lost-Math-Beauty-Physics-Astray/dp/0465094252>

- [12] Richard Dawid. *String theory and the scientific method*. Cambridge: Cambridge University Press, 2013.
- [13] R. Dadashti, R. Dawid, K. Thebault. *Why trust a theory? Epistemology of fundamental physics*. Cambridge: Cambridge University Press, 2019.
- [14] V. Christianto, F. Smarandache & R.N. Boyd. Towards Helmholtz's electron vortex from Kolmogorov's theory of turbulence and a new model of origination of charge and matter. *Prespacetime J.*, 2019.
- [15] V. Christianto, F. Smarandache, Y. Umniyati. Towards Gross-Pitaevskiiian description of Solar System and Galaxies and more evidence of chiral superfluid vortices. *Prespacetime J.*, 2020.
- [16] Mohamad Shalaby. Dynamics and Light Propagation in a Universe with Discrete-Matter Content. arXiv: 1205.68773 [gr-qc]; also [16a] Rex G. Liu. The Lindquist-Wheeler formulation of lattice universes. arXiv: 1501.05169 [gr-qc]
- [17] Winston H. Bostick. What Laboratory-Produced Plasma Structures Can Contribute to the Understanding of Cosmic Structures Both Large and Small. *IEEE TRANSACTIONS ON PLASMA SCIENCE*, VOL. PS-14, NO. 6, DECEMBER 1986; [17a] W.H. Bostick. The Morphology of the Electron. *International Journal of Fusion Energy*, Vol. 3, no. 1, 1985
- [18] Siavash H. Sohrab. *Turbulence and quantum mechanics from cosmos to Planck Scale*. url: <http://www.mech.northwestern.edu/web/people/faculty/sohrab.php>
- [19] Alfredo G. Cocco. PTolemy - Towards Cosmological Relic Neutrino detection. *Neutrino Oscillation Workshop 4* - 11 September, 2016 - Otranto (Lecce, Italy)
- [20] G. Polya. *How to solve it: A new aspect of mathematical method*. Second edition. Princeton: Princeton University Press, 1957, pp. vii.
- [21] Jacques Hadamard. *An essay on the psychology of invention in the mathematical field*. New York: Dover Publications, Inc., 1945.
- [22] Dennis P. Allen, Jr. & J. Dunning-Davies. *Neo-Newtonian Mechanics*. 14th edition. Available at ResearchGate (2019). ISBN:1491024895
- [23] Dennis P. Allen, Jr. *Foundations of Gutschian Mechanics*. Part I: Basics. Available at ResearchGate.
- [24] David R. Hawkins. *Homo Spiritus: Devotional Nonduality: Enlightenment*. USA: Veritas Publishing, Nov. 22nd, 2012. url: <https://www.goodreads.com/book/show/36327593-homo-spiritus>
- [25] Victor Christianto, Robby Igusti Chandra, Florentin Smarandache. A re-introduction of Pancasila from Neutrosophic Logic perspective: In search of the root cause of deep problems of modern societies. *Jurnal NPTRS, STT Cipanas*, Vol 2, No 2 (2021).
- [26] Rien van de Weygaert. Voronoi Tessellations and the Cosmic Web: spatial patterns and clustering across the Universe. *Proceedings of the Fourth International Symposium on Voronoi Diagrams in Science and Engineering (ISVD 2007)*, ed. C. Gold, IEEE Computer Society, July 2007.
- [27] Conrad Ranzan. Cosmic redshift in the nonexpanding cellular universe: velocity-differential theory of cosmic redshift. *American Journal of Astronomy and Astrophysics* 2014, 2(5): 47-60
- [28] _____. Large scale structure of the Dynamic Steady State Universe. *American Journal of Astronomy and Astrophysics* 2016, 4(6): 65-77.
- [29] Loet Leydesdorff, Caroline S. Wagner, and Lutz Bornman. Discontinuities in Citation Relations among Journals: Self-organized Criticality as a Model of Scientific Revolutions and Change. arXiv: 1803.00554 (2018)

- [30] Bosiljka Tadic, Marija Mitrovic Dankulov, and Roderick Melnik. The mechanisms of self-organised criticality in social processes of knowledge creation. arXiv: 1705.0982 (2017)
- [31] Turkan Firinci Orman. “Paradigm” as a Central Concept in Thomas Kuhn’s Thought. *International Journal of Humanities and Social Science*, vol. 6, no. 10 (2016)
- [32] Per Bak. *How Nature Works*. New York: Springer, 1996.
- [33] Clayton M. Christensen & Michael Overdorf. Meeting the Challenge of Disruptive Change. *HBR On Point*, March-April 2000. www.hbr.org; [31a] Clayton M. Christensen *et al.* <https://hbr.org/2015/12/what-is-disruptive-innovation>
- [34] Vladyslav A. Golyk. Self-organized criticality. Url: <https://pdfs.semanticscholar.org/7084/223d9079288397680adcbe129c2ad323b45e.pdf>
- [35] Ildus S. Nurgaliev. E pur si muove! arXiv: 1210.4091. See also [35a] Ildus S. Nurgaliev. Singularities are averted by vortices. *13th Gravitational Conference – International Conference on Gravitation, Cosmology and Astrophysics*. June 23-28, 2008. People’s Friendship University of Russia (PFUR), Moscow, Russia. Published by PFUR, ISBN 978-5-209-03274-8, pp. 117–118; [34b] Also in *Gravitation and Cosmology* vol. 16 no. 4 (2010) pp. 313-315.
- [36] Victor Christianto & Florentin Smarandache & Yunita Umniyati. Solving Numerically Ermakov-type Equation for Newtonian Cosmology Model with Vortex. *Prespacetime Journal*, Oct. 2017. www.prespacetime.com
- [37] Victor Christianto & Florentin Smarandache. How Neutrosophic Logic may Resolve Dispute on the Origin of the Universe through re-reading Gen. 1:1-2. *Asia Matematika J.* vol. 2, no. 2 (2019).

This thirteenth volume of Collected Papers is an eclectic tome of 88 papers in various fields of sciences, such as astronomy, biology, calculus, economics, education and administration, game theory, geometry, graph theory, information fusion, decision making, instantaneous physics, quantum physics, neutrosophic logic and set, non-Euclidean geometry, number theory, paradoxes, philosophy of science, scientific research methods, statistics, and others, structured in 17 chapters (Neutrosophic Theory and Applications; Neutrosophic Algebra; Fuzzy Soft Sets; Neutrosophic Sets; Hypersoft Sets; Neutrosophic Semigroups; Neutrosophic Graphs; Superhypergraphs; Plithogeny; Information Fusion; Statistics; Decision Making; Extenics; Instantaneous Physics; Paradoxism; Mathematica; Miscellanea), comprising 965 pages, published between 2005-2022 in different scientific journals, by the author alone or in collaboration with the following 110 co-authors (alphabetically ordered) from 26 countries: Abdullah Gamal, Sania Afzal, Firoz Ahmad, Muhammad Akram, Sheriful Alam, Ali Hamza, Ali H. M. Al-Obaidi, Madeleine Al-Tahan, Assia Bakali, Atiqe Ur Rahman, Sukanto Bhattacharya, Bilal Hadjadji, Robert N. Boyd, Willem K.M. Brauers, Umit Cali, Youcef Chibani, Victor Christianto, Chunxin Bo, Shyamal Dalapati, Mario Dalcín, Arup Kumar Das, Elham Davneshvar, Bijan Davvaz, Irfan Deli, Muhammet Deveci, Mamouni Dhar, R. Dhavaseelan, Balasubramanian Elavarasan, Sara Farooq, Haipeng Wang, Ugur Halden, Le Hoang Son, Hongnian Yu, Qays Hatem Imran, Mayas Ismail, Saeid Jafari, Jun Ye, Ilanthenral Kandasamy, W.B. Vasantha Kandasamy, Darjan Karabašević, Abdullah Kargin, Vasilios N. Katsikis, Nour Eldeen M. Khalifa, Madad Khan, M. Khoshnevisan, Tapan Kumar Roy, Pinaki Majumdar, Sreepurna Malakar, Masoud Ghods, Minghao Hu, Mingming Chen, Mohamed Abdel-Basset, Mohamed Talea, Mohammad Hamidi, Mohamed Loey, Mihnea Alexandru Moiescu, Muhammad Ihsan, Muhammad Saeed, Muhammad Shabir, Mumtaz Ali, Muzzamal Sitara, Nassim Abbas, Munazza Naz, Giorgio Nardo, Mani Parimala, Ion Pătrașcu, Gabrijela Popović, K. Porselvi, Surapati Pramanik, D. Preethi, Qiang Guo, Riad K. Al-Hamido, Zahra Rostami, Said Broumi, Saima Anis, Muzafer Saračević, Ganeshsree Selvachandran, Selvaraj Ganesan, Shammya Shananda Saha, Marayanagaraj Shanmugapriya, Songtao Shao, Sori Tjandrah Simbolon, Florentin Smarandache, Predrag S. Stanimirović, Dragiša Stanujkić, Raman Sundareswaran, Mehmet Şahin, Ovidiu-Ilie Şandru, Abdulkadir Şengür, Mohamed Talea, Ferhat Taş, Selçuk Topal, Alptekin Ulutaş, Ramalingam Udhayakumar, Yunita Umniyati, J. Vimala, Luige Vlădăreanu, Ştefan Vlăduţescu, Yaman Akbulut, Yanhui Guo, Yong Deng, You He, Young Bae Jun, Wangtao Yuan, Rong Xia, Xiaohong Zhang, Edmundas Kazimieras Zavadskas, Zayen Azzouz Omar, Xiaohong Zhang, Zhirou Ma.

Keywords: Neutrosophy; Neutrosophic Logic; Neutrosophic Sets; Neutrosophic Topology; Neutrosophic Hypergraphs; Intuitionistic Fuzzy Parameters; Conventional Optimization Methods; Multiobjective Transportation Problem; Decision Making; Extenics; Classical Algebra; NeutroAlgebra; AntiAlgebra; NeutroOperation; AntiOperation; NeutroAxiom; AntiAxiom; Intuitionistic Fuzzy Soft Expert Set; Inclusion Relation; Neutrosophic Rough Set; Multi-Attribute Group Decision-Making; Multigranulation Neutrosophic Rough Set; Soft Set; Soft Expert Set; Hypersoft Set; Hypersoft Expert Set; Plithogeny; Plithogenic Set; Plithogenic Logic; Plithogenic Probability; Plithogenic Statistics; Safire Project; Infinite Velocity; Coulomb Potential; Kurepa function; Smarandache-Kurepa function; 2019 Novel Coronavirus; Deep Transfer Learning; Machine Learning; COVID-19; SARS-CoV-2; Convolutional Neural Network; Principle of Parsimony; Popperian Epistemology; Post-Empiricism Doctrine; Ockham Optimality Point; Belief Function; Dezert-Smarandache Theory; Neutrosophic Probability; Importance Discounting Factors.

ISBN 978-1-59973-745-4

