



US00D692294S

(12) **United States Design Patent**  
**Koeniger et al.**

(10) **Patent No.:** **US D692,294 S**

(45) **Date of Patent:** **\*\* Oct. 29, 2013**

(54) **RISER CLAMP**

(75) Inventors: **Tobias Koeniger**, Bregenz (AT); **Marc Nutzmann**, Lindau (DE); **Graham Keevy**, Aalen (DE)

(73) Assignee: **Hilti Aktiengesellschaft**, Schaan (LI)

(\*\*) **Term:** **14 Years**

(21) Appl. No.: **29/404,958**

(22) Filed: **Oct. 27, 2011**

(51) **LOC (9) Cl.** ..... **08-08**

(52) **U.S. Cl.**  
USPC ..... **D8/396**

(58) **Field of Classification Search**  
USPC ..... D8/394–396, 356, 383; 24/16 PB,  
24/17 AP, 30.5 P, 30.5 S, 300–302, 339,  
24/DIG. 16; 248/58, 60, 74.3  
See application file for complete search history.

(56) **References Cited**

**U.S. PATENT DOCUMENTS**

847,620	A	*	3/1907	Thompson	.....	24/284
1,205,926	A	*	11/1916	Palmer et al.	.....	24/275
2,764,438	A	*	9/1956	Haviland	.....	403/234
3,305,199	A	*	2/1967	Bayes et al.	.....	248/74.1
3,485,515	A	*	12/1969	Frishof	.....	285/5
3,694,012	A	*	9/1972	Gelfand	.....	403/306
3,788,677	A	*	1/1974	Stade et al.	.....	285/367
3,964,773	A	*	6/1976	Stade et al.	.....	285/367
4,059,872	A	*	11/1977	Delesandri	.....	24/284
4,373,235	A	*	2/1983	Korgaonkar	.....	24/285
4,454,644	A	*	6/1984	Okazaki et al.	.....	29/440
D283,675	S	*	5/1986	Fogel et al.	.....	D8/396
D298,802	S	*	12/1988	Tekirian	.....	D8/396
5,018,768	A	*	5/1991	Palatchy	.....	285/24
5,596,790	A	*	1/1997	Moller	.....	24/20 EE
D386,397	S	*	11/1997	Adriaenssens	.....	D8/396
6,038,744	A	*	3/2000	Zielinski	.....	24/20 R
6,438,801	B1	*	8/2002	Yamada	.....	24/20 R
6,464,268	B1	*	10/2002	Hough et al.	.....	285/367

D482,956	S	*	12/2003	Pyron	.....	D8/382
D488,714	S	*	4/2004	Schengrund et al.	.....	D8/382
D518,791	S	*	4/2006	Kiely	.....	D13/153
7,540,071	B2	*	6/2009	Sampson	.....	24/284
D596,578	S	*	7/2009	Kiely et al.	.....	D13/149

(Continued)

*Primary Examiner* — John Windmuller

(74) *Attorney, Agent, or Firm* — Crowell & Moring LLP

(57) **CLAIM**

The ornamental design for a riser clamp, as shown and described.

**DESCRIPTION**

FIG. 1 is a top, right, front perspective view of a first embodiment of a riser clamp according to our design;  
 FIG. 2 is a top, left, rear perspective view thereof;  
 FIG. 3 is a bottom, left, front perspective view thereof;  
 FIG. 4 is a bottom, right, rear perspective view thereof;  
 FIG. 5 is a front view thereof;  
 FIG. 6 is a rear view thereof;  
 FIG. 7 is a right side view thereof;  
 FIG. 8 is a left side view thereof;  
 FIG. 9 is a top view thereof; and  
 FIG. 10 is a bottom view thereof.  
 FIG. 11 is a top, right, front perspective view of a second embodiment of the riser clamp according to our design;  
 FIG. 12 is a top, left, rear perspective view thereof;  
 FIG. 13 is a bottom, left, front perspective view thereof;  
 FIG. 14 is a bottom, right, rear perspective view thereof;  
 FIG. 15 is a front view thereof;  
 FIG. 16 is a rear view thereof;  
 FIG. 17 is a right side view thereof;  
 FIG. 18 is a left side view thereof;  
 FIG. 19 is a top view thereof; and  
 FIG. 20 is a bottom view thereof.  
 The broken lines are for illustrative purposes only and form no part of the claimed design.

**1 Claim, 20 Drawing Sheets**

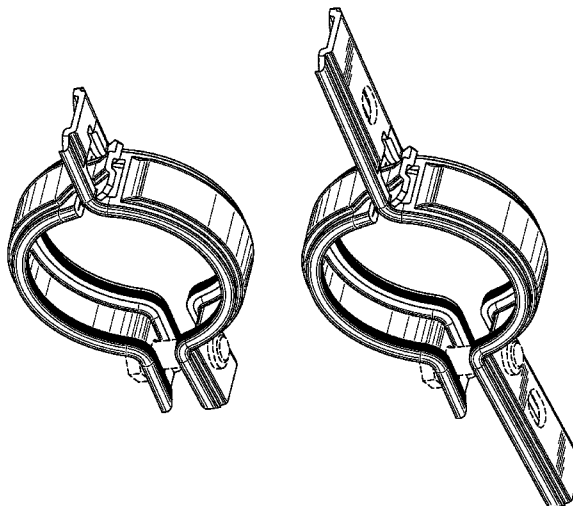

# US D692,294 S

Page 2

---

(56)

## References Cited

### U.S. PATENT DOCUMENTS

8,171,603 B2 *	5/2012	Nakamura .....	24/20 R
8,246,709 B2 *	8/2012	Franken .....	55/503
8,336,834 B2 *	12/2012	Matsumoto et al. ....	248/74.1
D629,496 S *	12/2010	Madara et al. ....	D23/262
8,033,579 B2 *	10/2011	Takeda et al. ....	285/367

\* cited by examiner

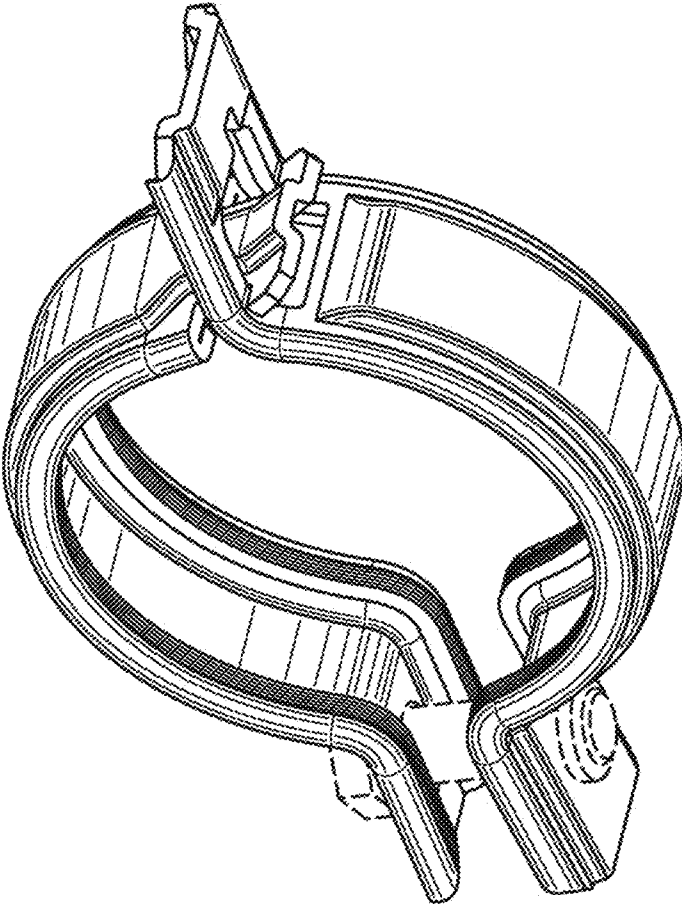

FIG. 1

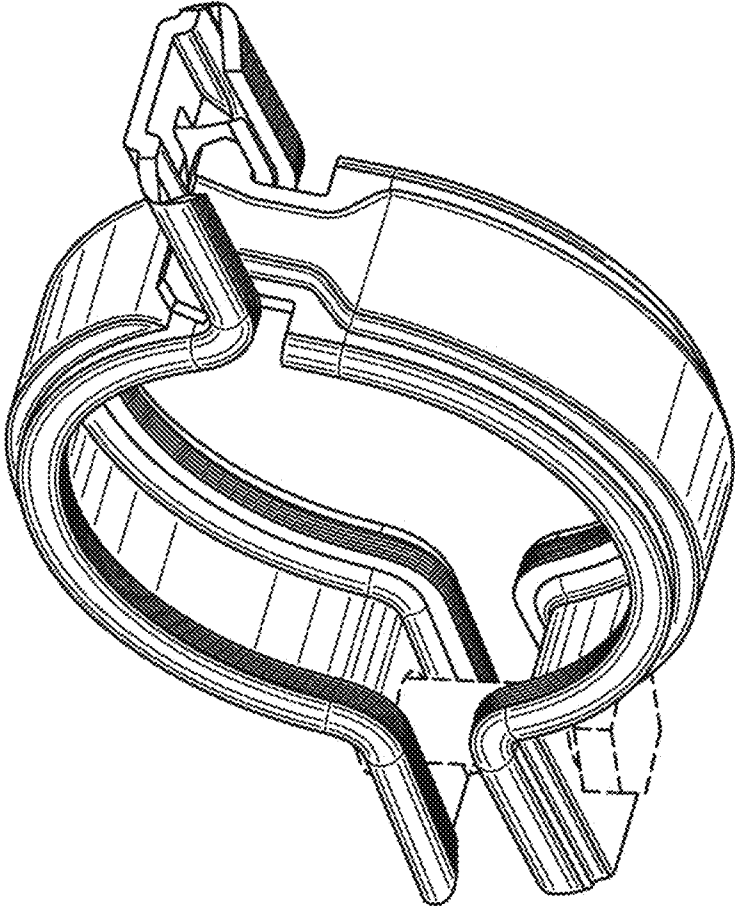

FIG. 2

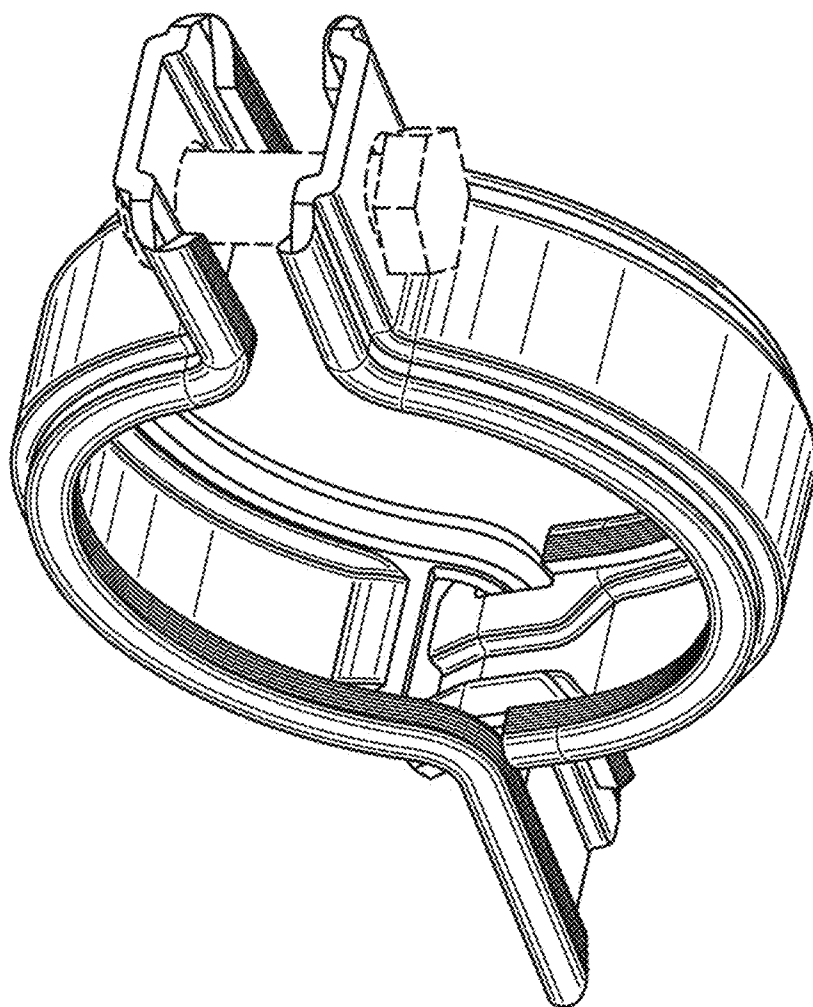

FIG. 3

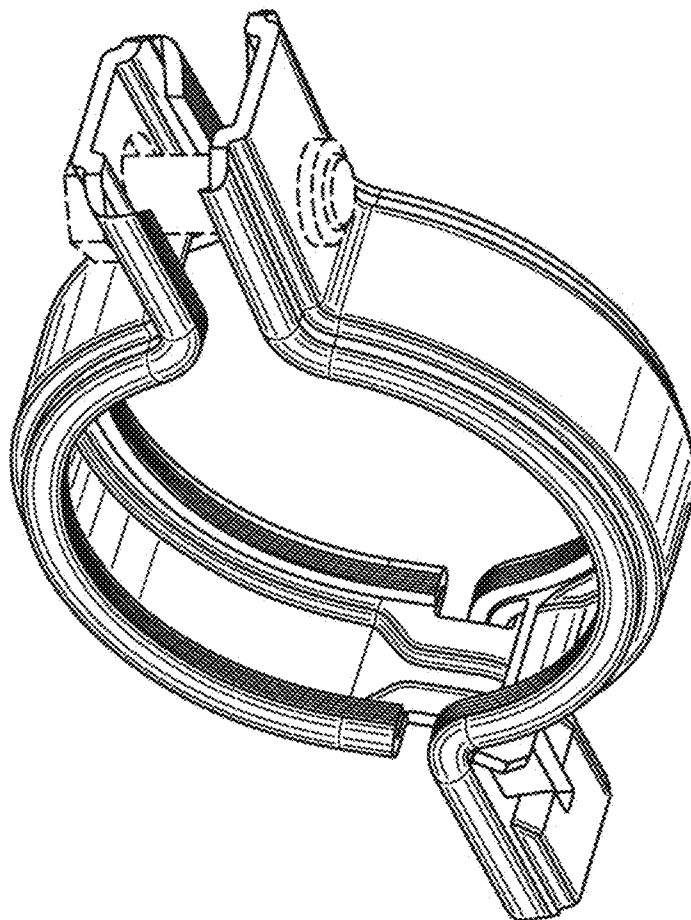

FIG. 4

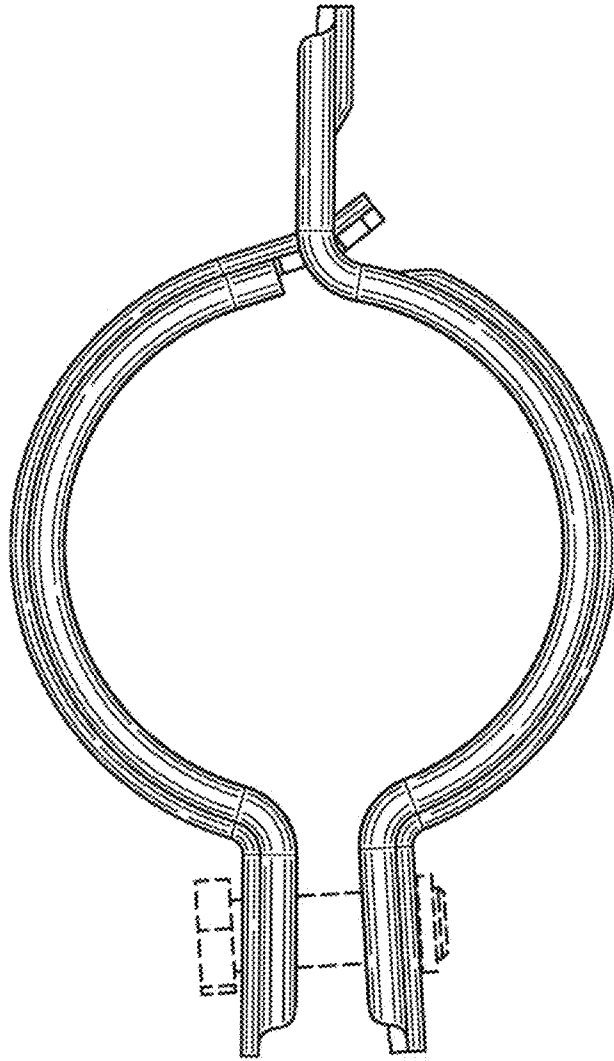

FIG. 5

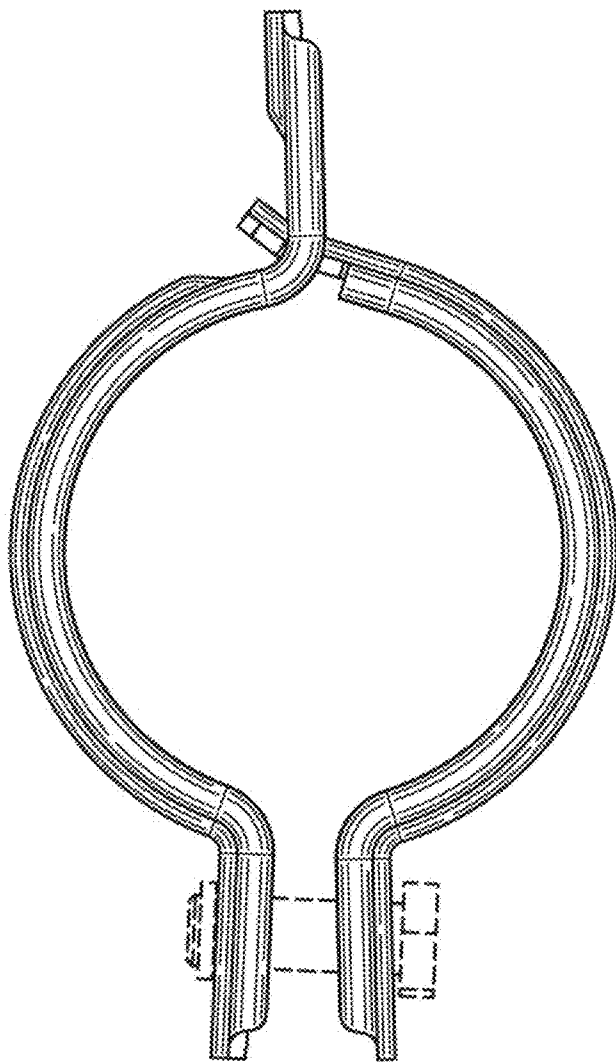

FIG. 6



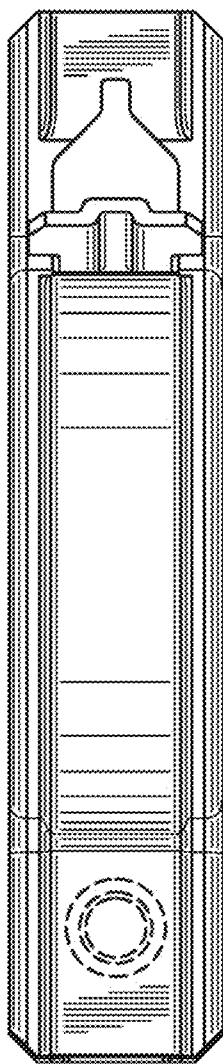

FIG. 7

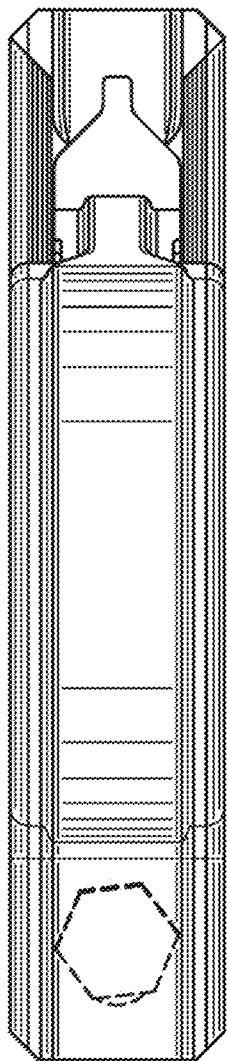

FIG. 8

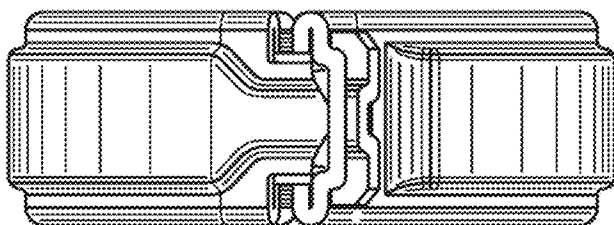

FIG. 9

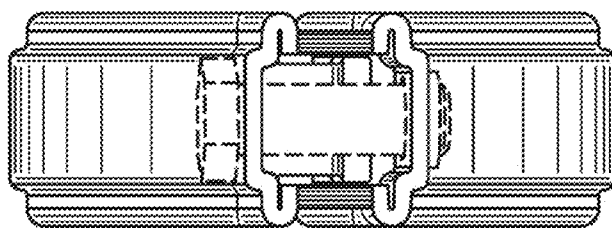

FIG. 10

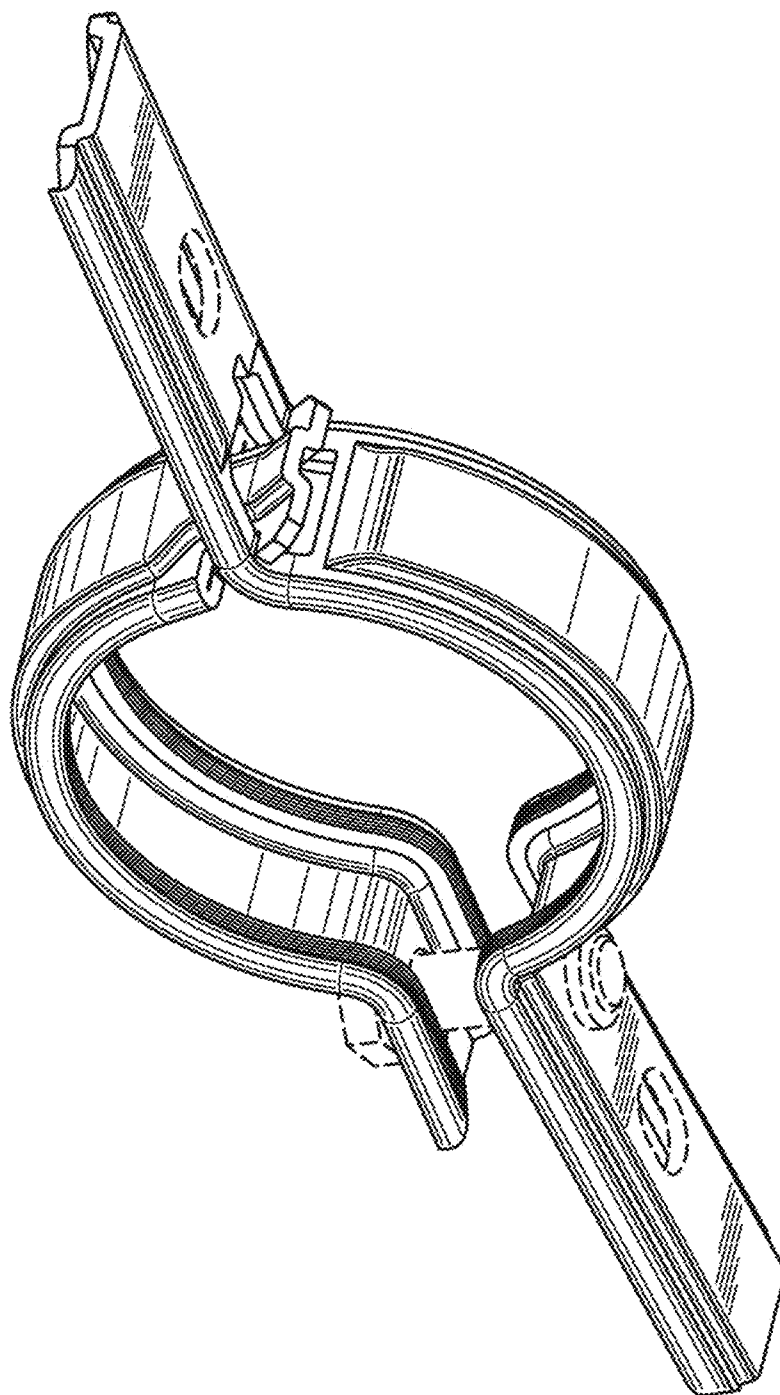

FIG. 11

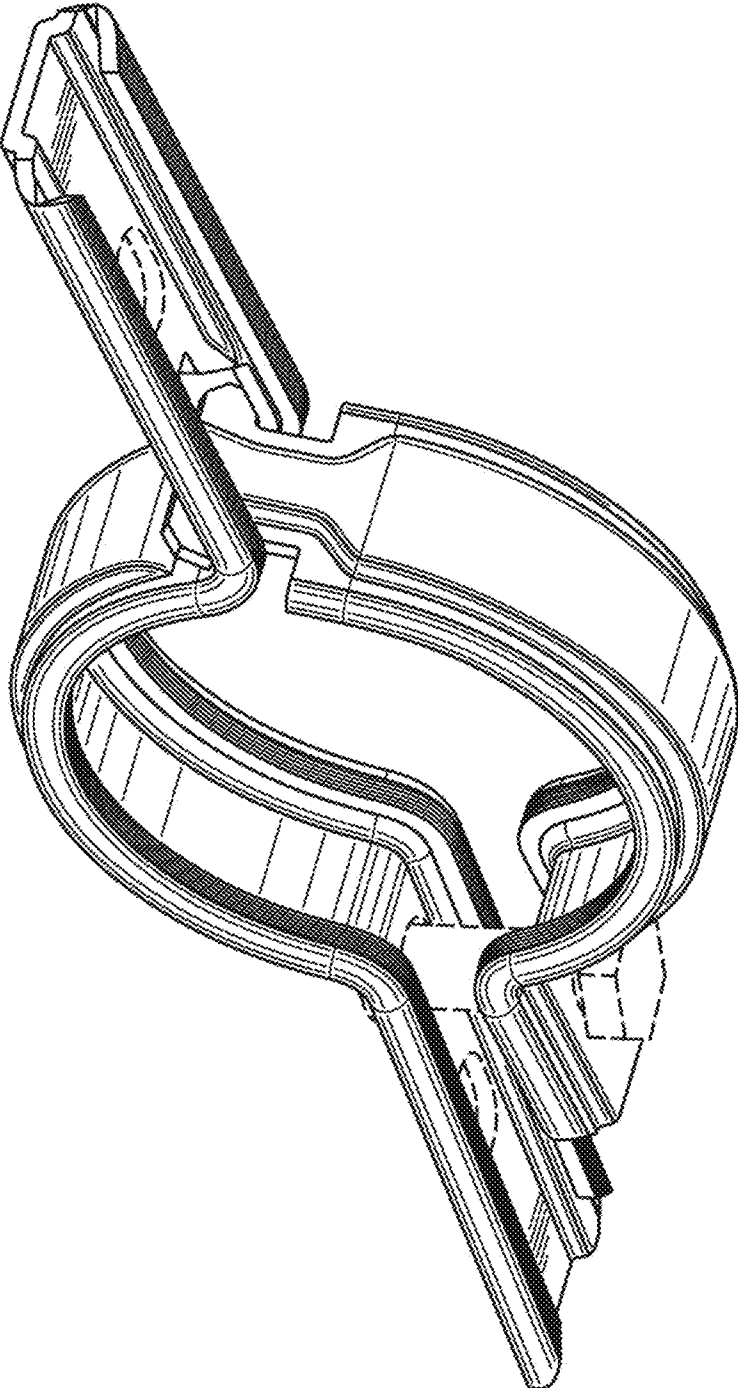

FIG. 12

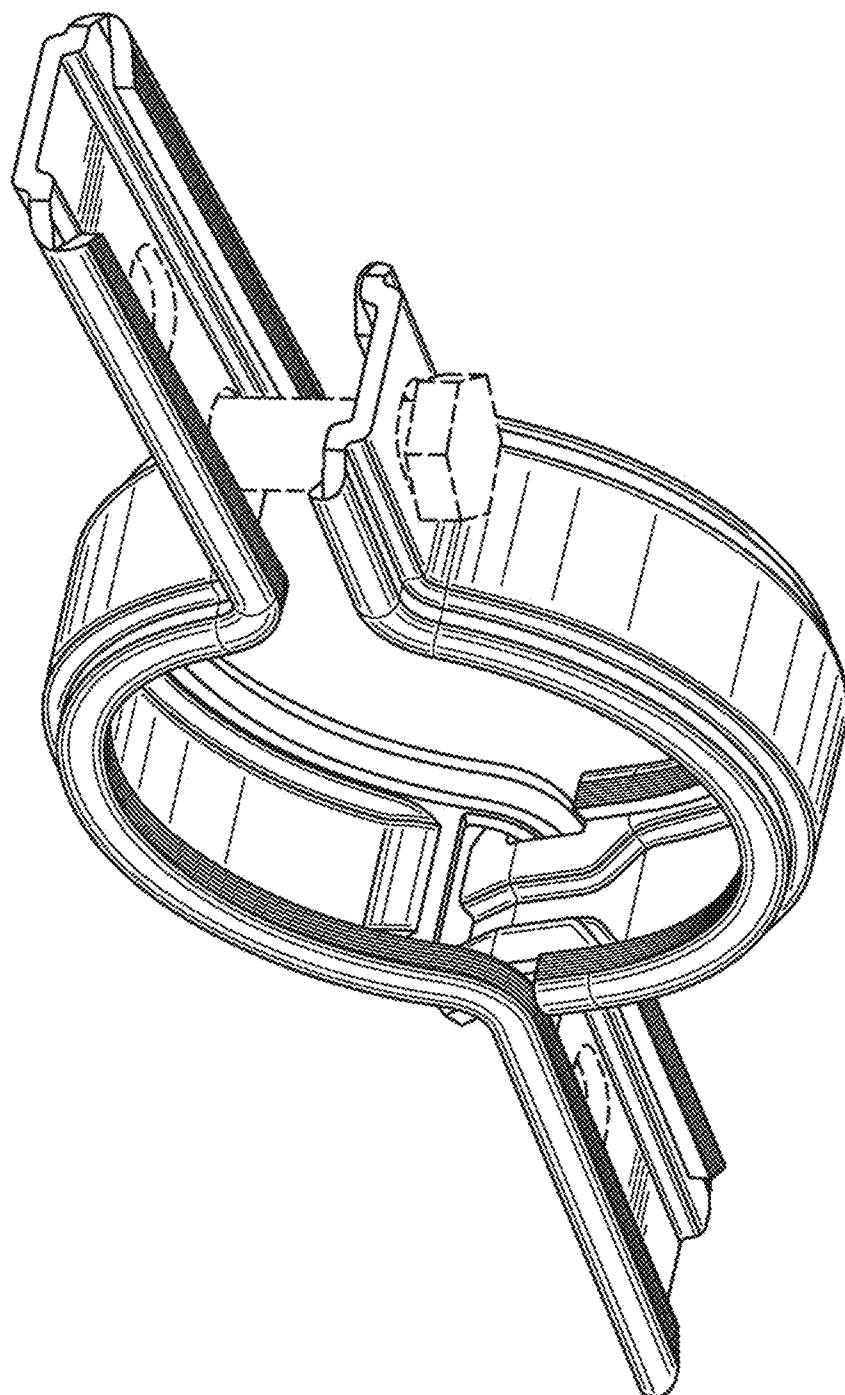

FIG. 13

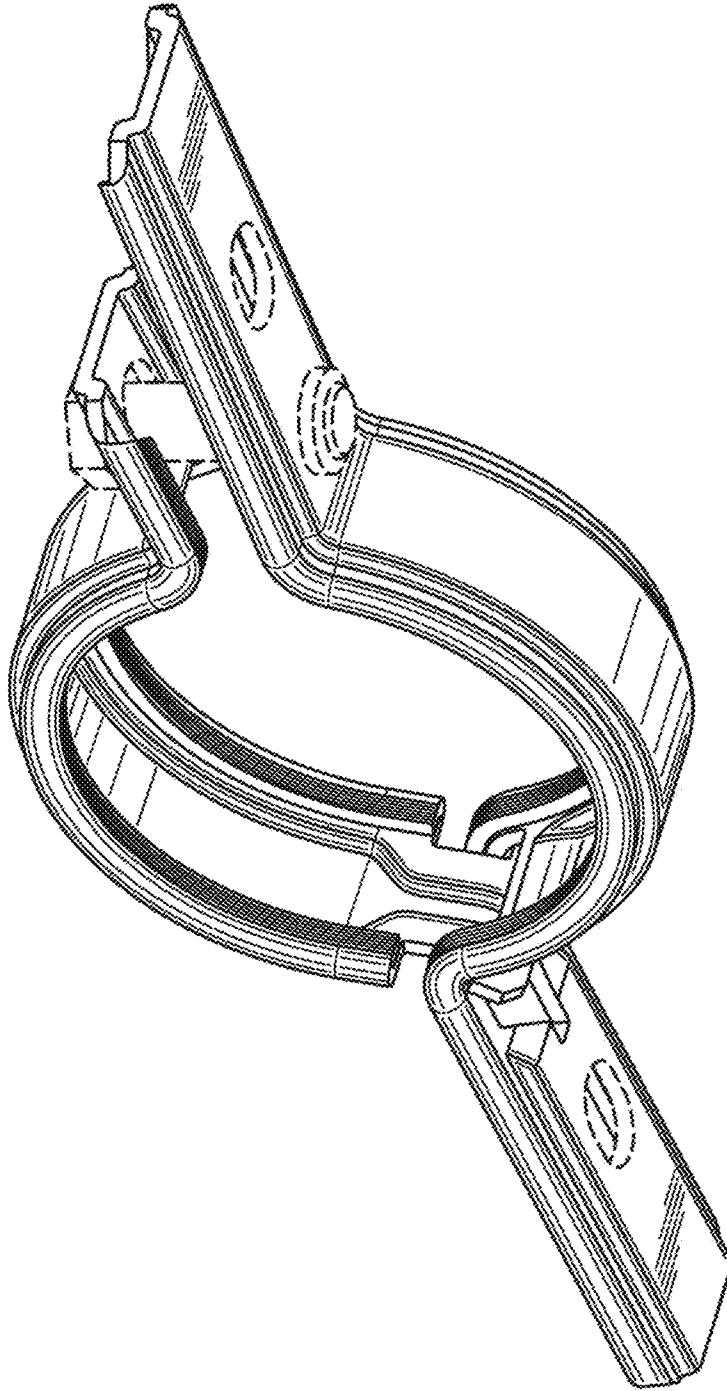

FIG. 14



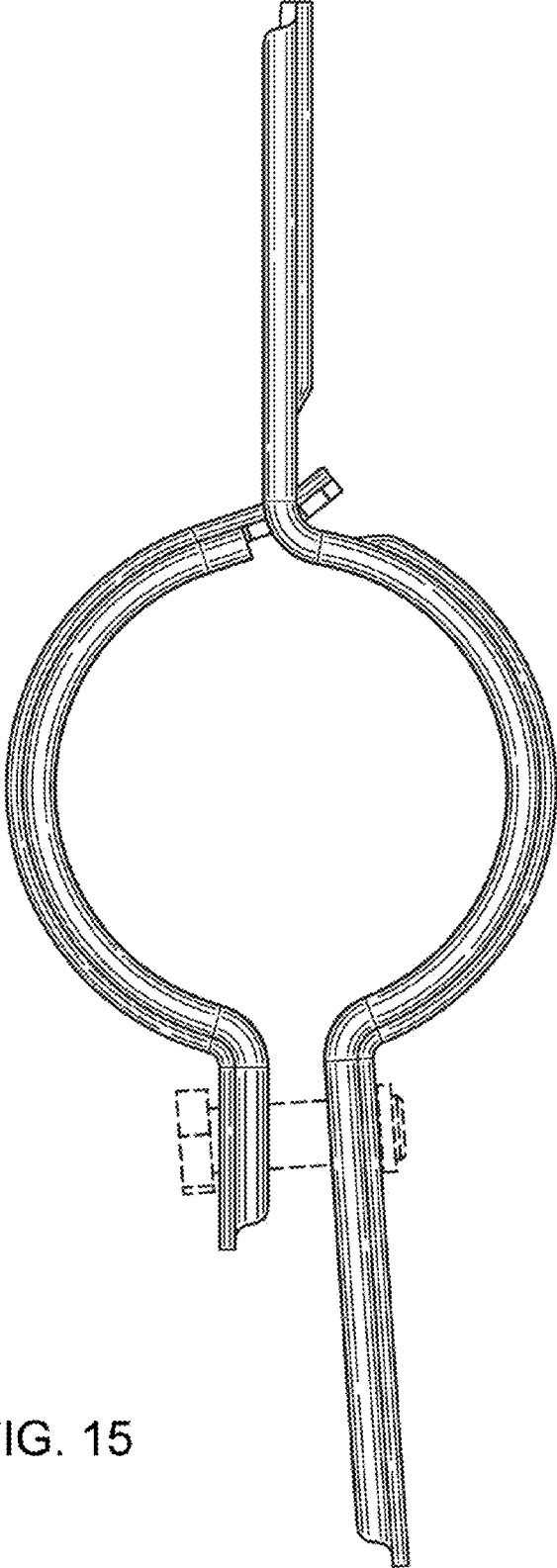

FIG. 15

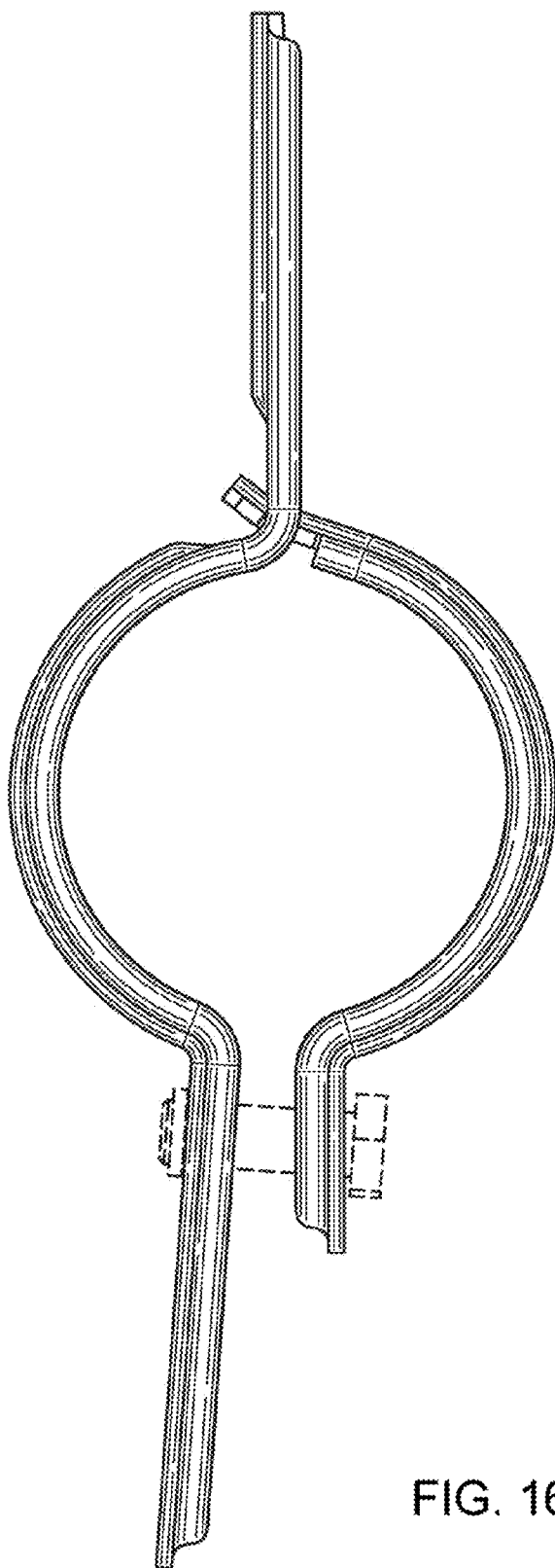

FIG. 16

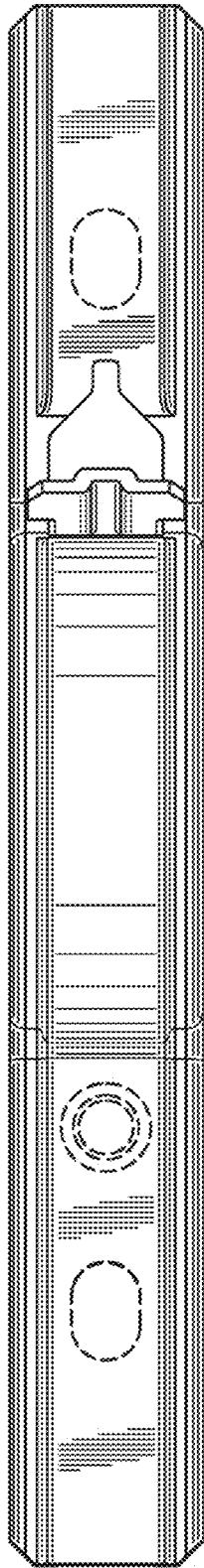

FIG. 17

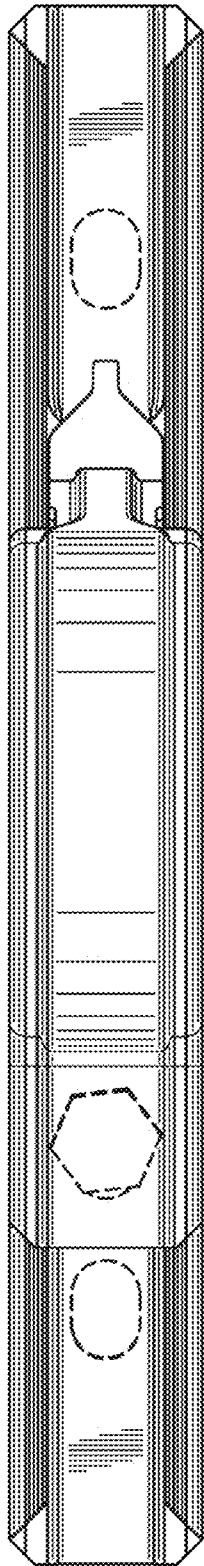

FIG. 18

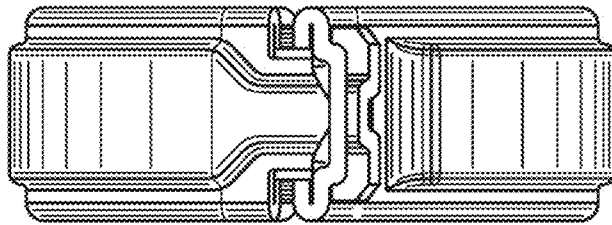

FIG. 19

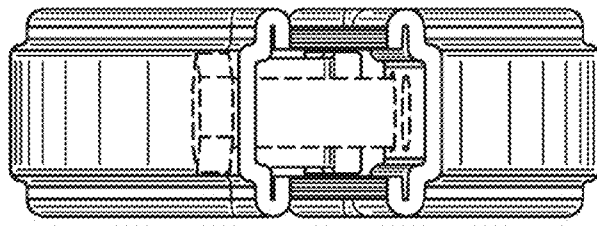

FIG. 20