

[54] **STEMWARE RACK**

[76] **Inventor: Robert R. Funk, 232 No. Rios Ave., Solana Beach, Calif. 92075**

[**] **Term: 14 Years**

[21] **Appl. No.: 118,421**

[22] **Filed: Nov. 9, 1987**

[52] **U.S. Cl. D6/513**

[58] **Field of Search D6/512-513, D6/515; 211/71, 86, 94.5, 113, 162**

[56] **References Cited**

U.S. PATENT DOCUMENTS

- | | | | |
|------------|---------|------------------|----------|
| D. 269,926 | 8/1983 | White | D6/514 |
| D. 275,433 | 9/1984 | Boland, II | D6/514 |
| D. 286,121 | 10/1986 | Wolff | D6/553 |
| D. 290,314 | 6/1987 | Liebau | D6/553 X |

OTHER PUBLICATIONS

V.D. Acrylics Catalogue (1983) p. 23—Hanging Glass Rack.

Primary Examiner—Wallace R. Burke

Assistant Examiner—Brian N. Vinson

Attorney, Agent, or Firm—Stanley A. Becker

[57] **CLAIM**

The ornamental design for a stemware rack, as shown.

DESCRIPTION

FIG. 1 is a top, front and left side perspective view of a stemware rack showing my new design;

FIG. 2 is an enlarged front elevational view thereof;

FIG. 3 is an enlarged top plan view thereof;

FIG. 4 is an enlarged right side elevational view thereof;

FIG. 5 is an enlarged bottom plan view thereof; and

FIG. 6 is an enlarged rear elevational view thereof.

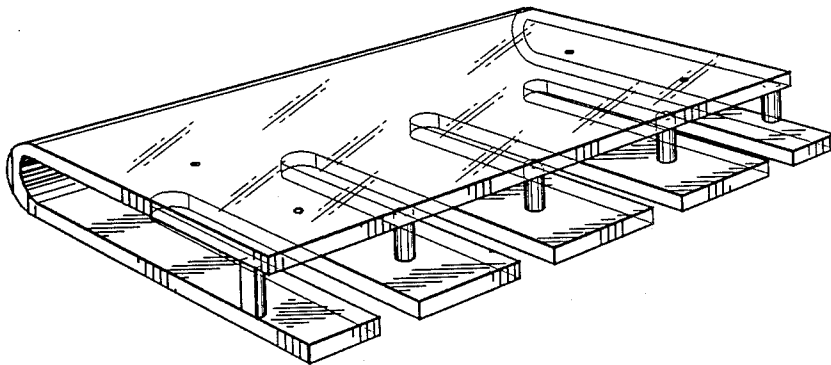

FIG. 1

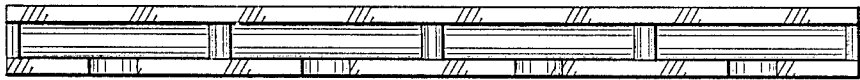
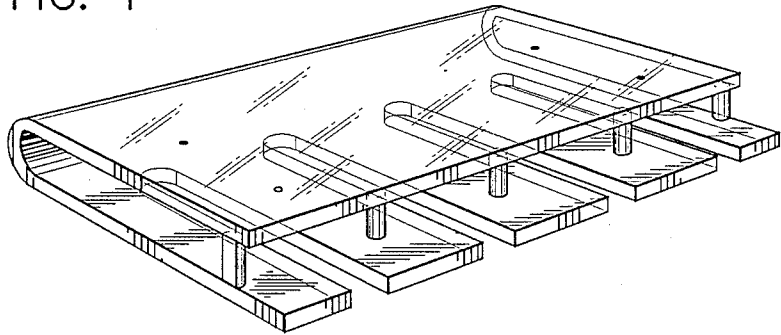

FIG. 2

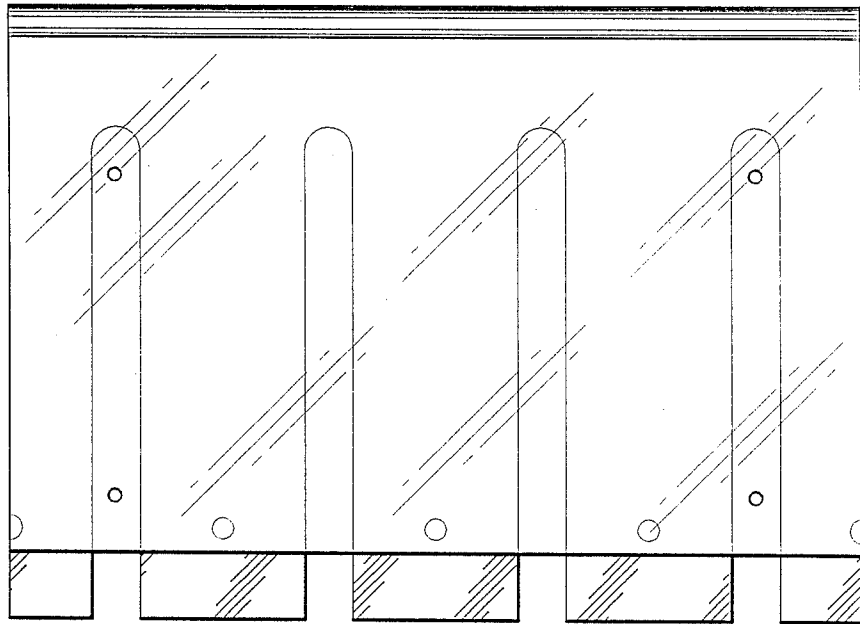

FIG. 3

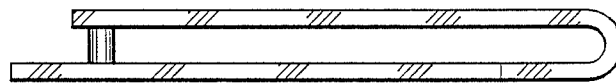

FIG. 4

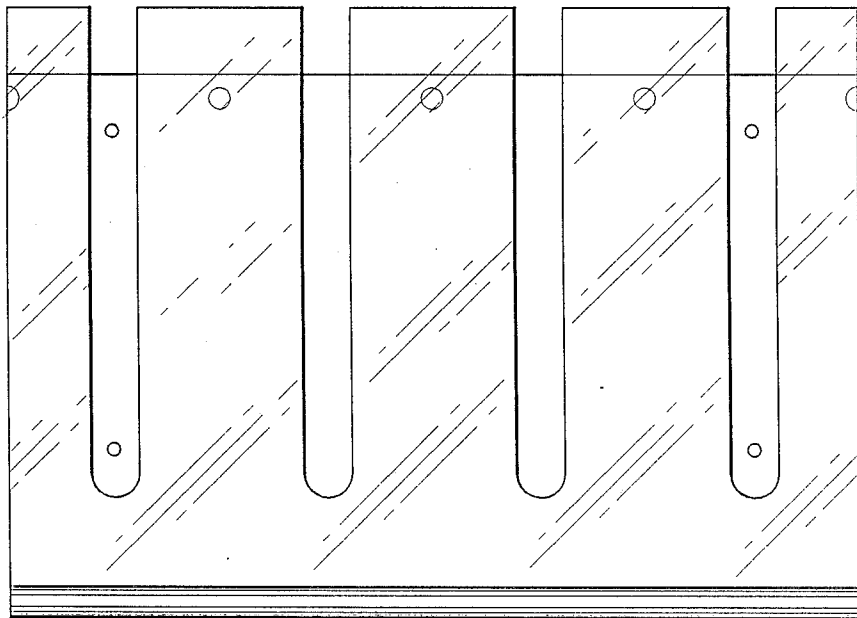

FIG. 5

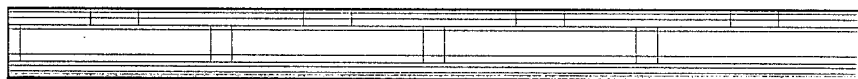

FIG. 6