



(12) **United States Design Patent**
Lin

(10) **Patent No.:** **US D1,005,763 S**
(45) **Date of Patent:** **** Nov. 28, 2023**

(54) **BED CONNECTOR**

FOREIGN PATENT DOCUMENTS

(71) Applicant: **Xiamen Chongteng Trading Co., Ltd.**,
Xiamen (CN)

KR 301194502.0000 * 12/2022

(72) Inventor: **Yiqin Lin**, Shenzhen (CN)

OTHER PUBLICATIONS

(**) Term: **15 Years**

Meicoco Frame, posted at amazon.ca, posting date Dec. 12, 2019, retrieved Mar. 17, 2023, online, URL: https://www.amazon.ca/MEICOCO-Frame-Post-Double-Bracket/dp/B0826CHL6W/ref=sr_1_53?crd=2EFYYVTLB2F0H&keywords=support%2Bbracket%2Bconnector%2Bplatform%2Bbed%2Bframe&qid=1678735697&s (Year: 2019).*

(21) Appl. No.: **29/863,359**

(22) Filed: **Dec. 19, 2022**

(Continued)

(51) **LOC (14) Cl.** **08-08**

(52) **U.S. Cl.**

USPC **D8/382**; D6/718

(58) **Field of Classification Search**

USPC D6/317, 382-395, 718; D8/349, 354, D8/355, 380, 382, 373, 374-379; D26/72, 74, 76, 78-83, 85, 86, 88, 90, D26/93, 111, 113, 118, 119, 120, 121, D26/122, 138, 139, 140, 141, 142, 152
CPC A47C 19/00; A47C 19/02; A47C 19/04; A47C 19/12; A47C 19/021; A47C 19/025; A47C 19/027; A47C 17/86; F16B 12/32; F16B 12/54; A47B 96/14; A47B 87/02

See application file for complete search history.

Primary Examiner — Mary Shannon Malley
Assistant Examiner — Michelle Marquart Christeon
(74) *Attorney, Agent, or Firm* — Xiaofang Zhong

(57) **CLAIM**

The ornamental design for a bed connector, as shown and described.

DESCRIPTION

FIG. 1 is a front, right and top perspective view of a bed connector showing my new design; FIG. 2 is a rear, left and bottom perspective view thereof; FIG. 3 is a front elevational view thereof; FIG. 4 is a rear elevational view thereof; FIG. 5 is a left view thereof; FIG. 6 is a right view thereof; FIG. 7 is a top view thereof; FIG. 8 is a bottom view thereof; and, FIG. 9 is a perspective view thereof, shown in an environment of use; and, FIG. 10 is another perspective view thereof, with the bed connector shown in a detached position, in its environment of use. The broken lines in FIGS. 9 and 10 illustrating a bed frame, depict environmental subject matter that forms no part of the claimed design. The remaining broken lines depict portions of the bed connector and form no part of the claimed design.

(56) **References Cited**

U.S. PATENT DOCUMENTS

5,203,039 A * 4/1993 Fredman A47C 19/04 248/188.4
D341,836 S * 11/1993 O'Connor D14/251
D478,318 S 8/2003 Burwell et al.
D495,244 S * 8/2004 Ward D8/382
D518,365 S 4/2006 Wamsley
D552,209 S 10/2007 Lin
D563,776 S * 3/2008 Dagg D8/382
D628,158 S 11/2010 Skidmore et al.
D643,925 S 8/2011 Vaidya et al.
D756,207 S 5/2016 Tamilvel et al.
D816,468 S * 5/2018 Quintile D8/374

(Continued)

1 Claim, 10 Drawing Sheets

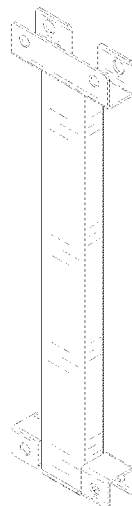

(56)

References Cited

U.S. PATENT DOCUMENTS

D885,078	S *	5/2020	Liang	D6/392
D886,364	S	6/2020	Greenberg et al.	
D889,250	S *	7/2020	Bullock	D8/353
D904,784	S	12/2020	Suzuki et al.	
D914,483	S *	3/2021	Lee	D8/349
D972,925	S *	12/2022	He	D8/382
2001/0044961	A1 *	11/2001	Epstein	A47C 19/025
				5/201
2018/0125255	A1 *	5/2018	Jin	A47C 19/024
2020/0359803	A1 *	11/2020	Choi	F16B 12/54
2020/0375367	A1 *	12/2020	Qiu	A47C 19/005

OTHER PUBLICATIONS

Increway Bracket Suporter, posted at amazon.ca, posting date Apr. 15, 2021, retrieved Mar. 17, 2023, online, URL:https://www.amazon.ca/INCREWAY-Brackets-Supporters-Headboards-Footboards/dp/B092MGLMBK/ref=sr_1_37?crid=2EFYVTLB2F0H&keywords=support+bracket+connector+platform+bed+frame& (Year: 2021).*

KB-Designs Bracket, posted at amazon.com, posting date Nov. 18, 2021, retrieved Mar. 17, 2023, online, URL:<https://www.amazon.com/KB-Designs-Footboard-Extension-Brackets-Twin/dp/B09L9K2ZF5> (Year: 2021).*

* cited by examiner

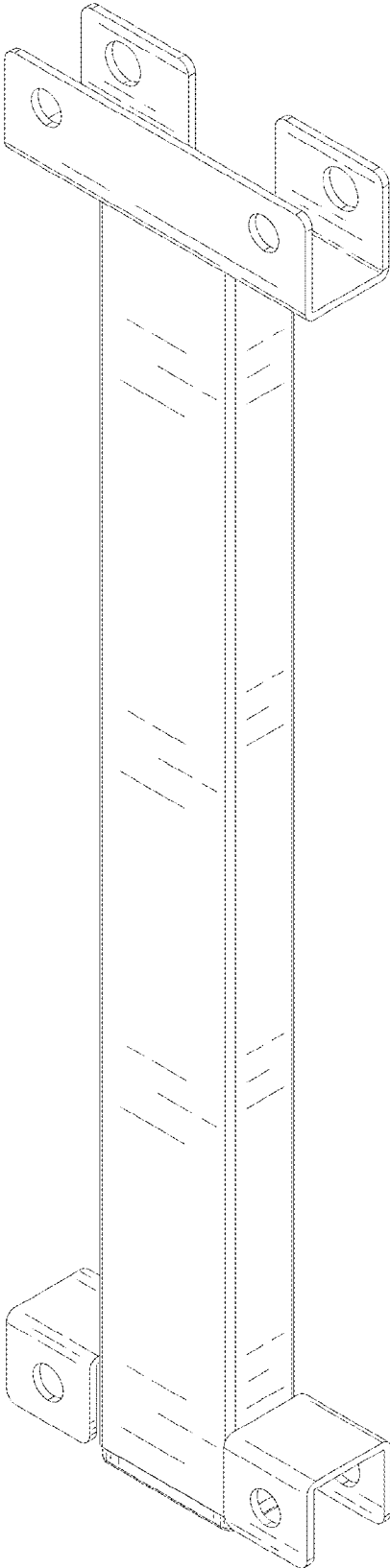

FIG. 1

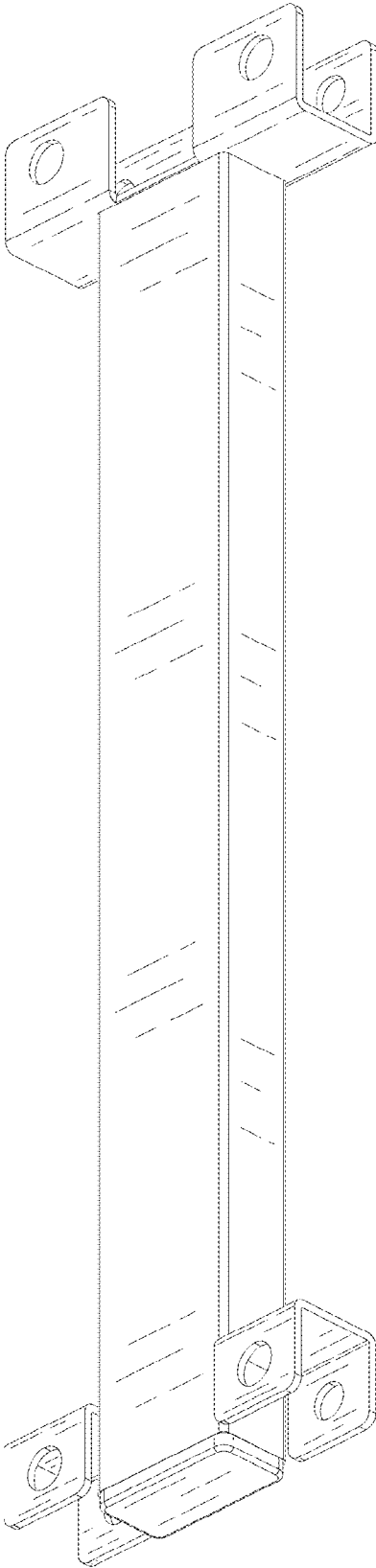

FIG. 2

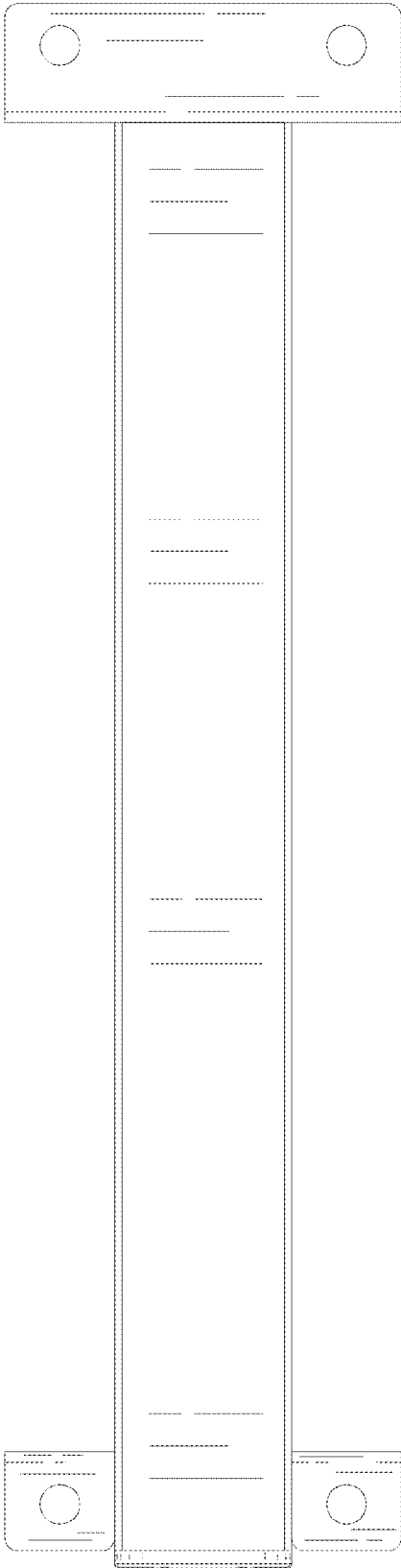

FIG. 3

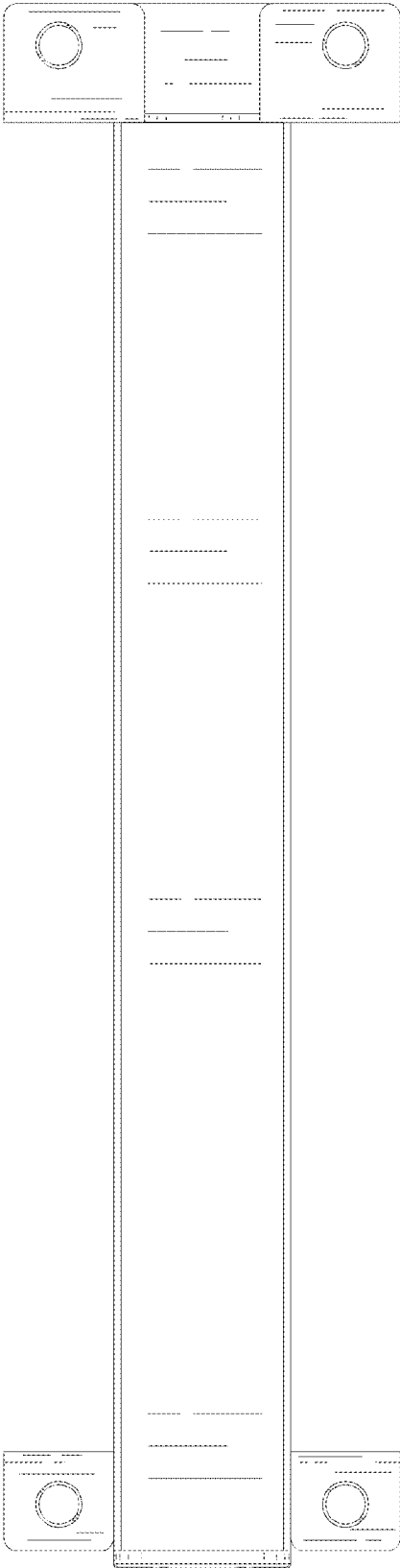

FIG. 4

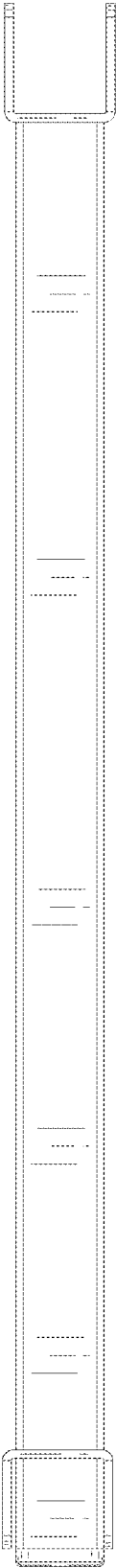

FIG. 5

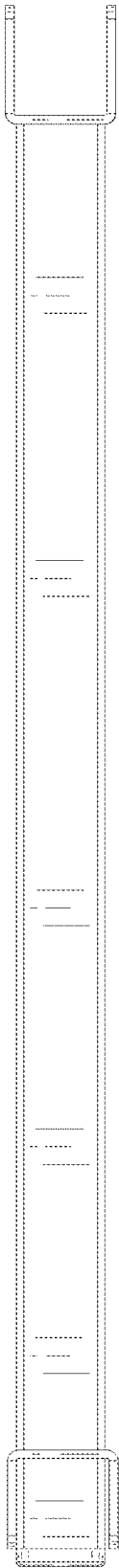

FIG. 6

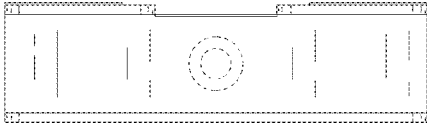

FIG. 7

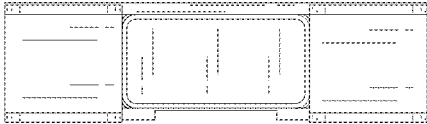

FIG. 8

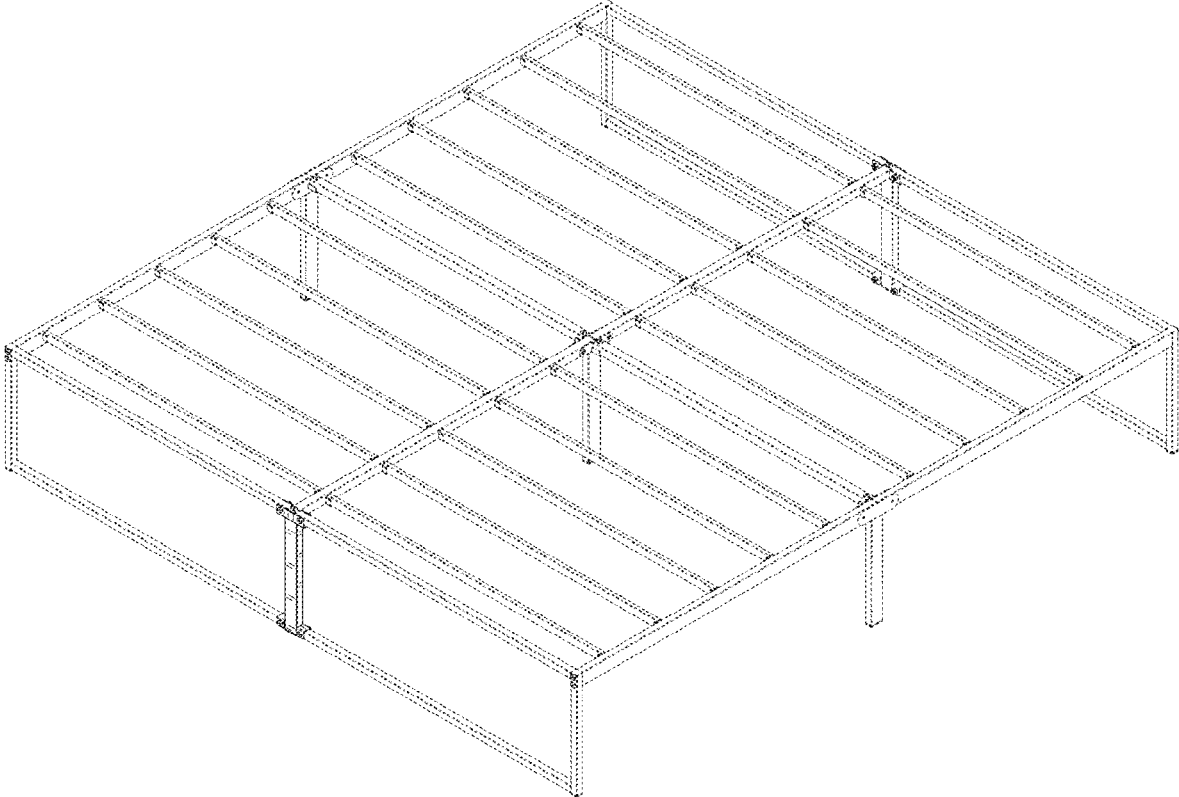

FIG. 9

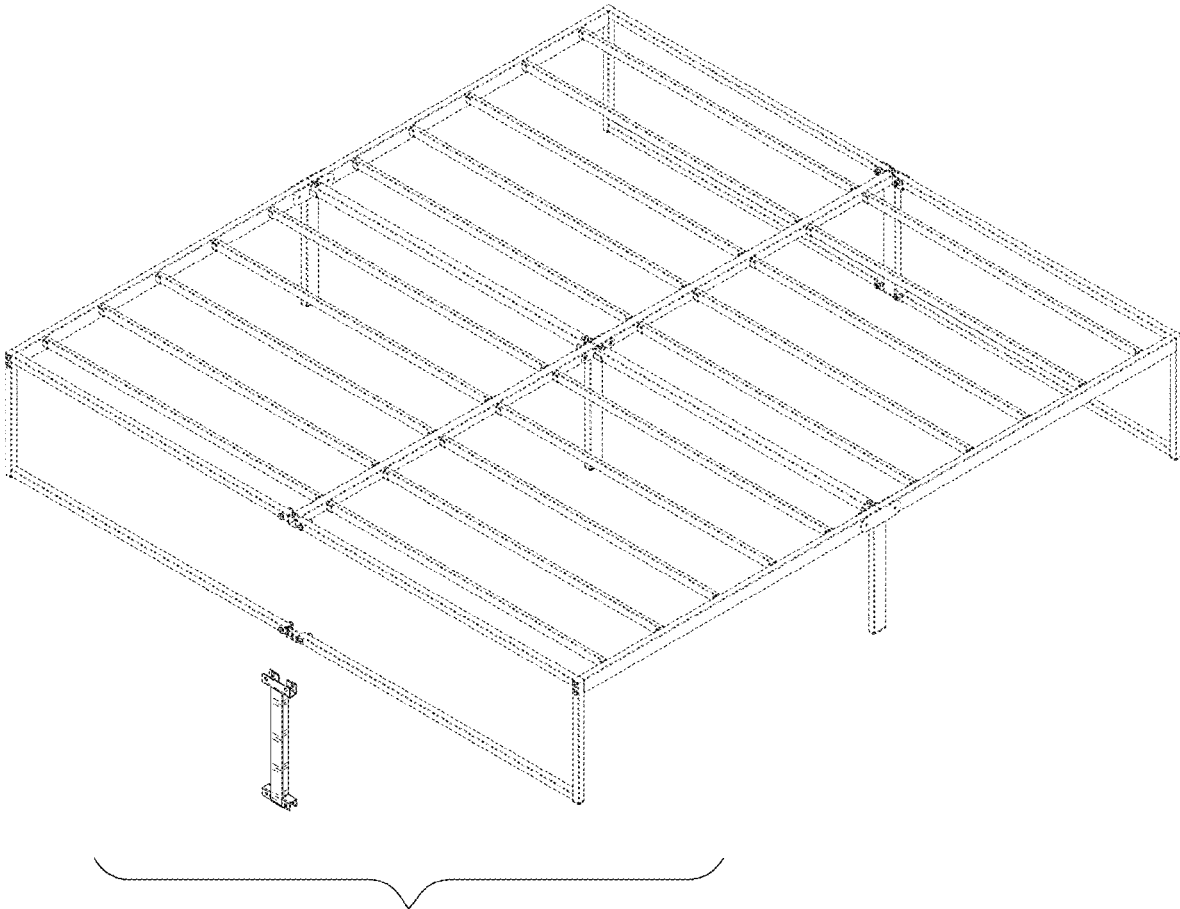

FIG. 10