



US00D902888S

(12) **United States Design Patent**
White

(10) **Patent No.:** **US D902,888 S**

(45) **Date of Patent:** **** Nov. 24, 2020**

(54) **HEADPHONE EARPIECE COVER**
(71) Applicant: **Benjamin White**, Rahway, NJ (US)
(72) Inventor: **Benjamin White**, Rahway, NJ (US)
(**) Term: **15 Years**
(21) Appl. No.: **29/738,342**

2,727,245 A * 12/1955 Suggs A61F 11/06
2/174
3,148,249 A * 9/1964 King H04R 1/12
379/452
3,169,171 A * 2/1965 Wachs H04R 1/12
379/452
3,192,326 A * 6/1965 Chapman H04M 1/05
379/447

(Continued)

(22) Filed: **Jun. 17, 2020**
(51) **LOC (12) Cl.** **14-01**
(52) **U.S. Cl.**
USPC **D14/205**
(58) **Field of Classification Search**
USPC D14/205, 249, 250; 181/129, 130;
D24/174; 128/866, 868; 381/370, 372,
381/376, 378, 379; 2/195.5, 209, 423,
2/174; 455/90.3, 575.1, 569.1; D11/228,
D11/222; D3/18, 28
CPC H04R 1/1066; H04R 1/1016; H04R 5/033;
H04R 5/0335; H04R 1/02; A61F 11/00
See application file for complete search history.

FOREIGN PATENT DOCUMENTS

EM 001056337-0001 * 12/2008
Primary Examiner — Paula Allen Greene

(57) **CLAIM**

The ornamental design for headphone earpiece cover, as shown and described.

DESCRIPTION

FIG. 1 is an isometric view of the headphone earpiece cover without a headphone, showing my new design; FIG. 2 is a side view thereof without the headphone; FIG. 3 is a front view thereof without the headphone; FIG. 4 is a back view thereof without the headphone; FIG. 5 is an isometric view of the headphone earpiece cover about to attach on the headphone; FIG. 6 is a isometric view of the headphone earpiece cover attached on the headphone; FIG. 7 is an isometric view of the headphone earpiece cover about to attach on the headphone; FIG. 8 is an isometric view of the headphone earpiece cover attached on the headphone; FIG. 9 is a side view of the headphone earpiece cover about to attach on the headphone; and, FIG. 10 is a side view of the headphone earpiece cover attached on the headphone. The broken lines in all figure views are directed to environment that illustrates portions of the headphone earpiece cover that forms no part of the claimed design.

(56) **References Cited**

U.S. PATENT DOCUMENTS

1,878,397 A * 9/1932 Hekler A45D 44/12
2/174
D142,133 S * 8/1945 Woodruff D14/249
2,403,418 A * 7/1946 Volkmann H04R 1/1008
181/129
2,447,470 A * 8/1948 Valentine H04R 1/1008
381/372
2,468,267 A * 4/1949 Mondl H04R 1/1008
381/376
2,468,721 A * 4/1949 Volkmann H04R 1/1008
181/129
2,561,857 A * 7/1951 Goldman A61F 11/06
2/172
D171,161 S * 12/1953 Larabell D14/249
2,669,610 A * 2/1954 Dent H04R 1/12
379/452

1 Claim, 10 Drawing Sheets

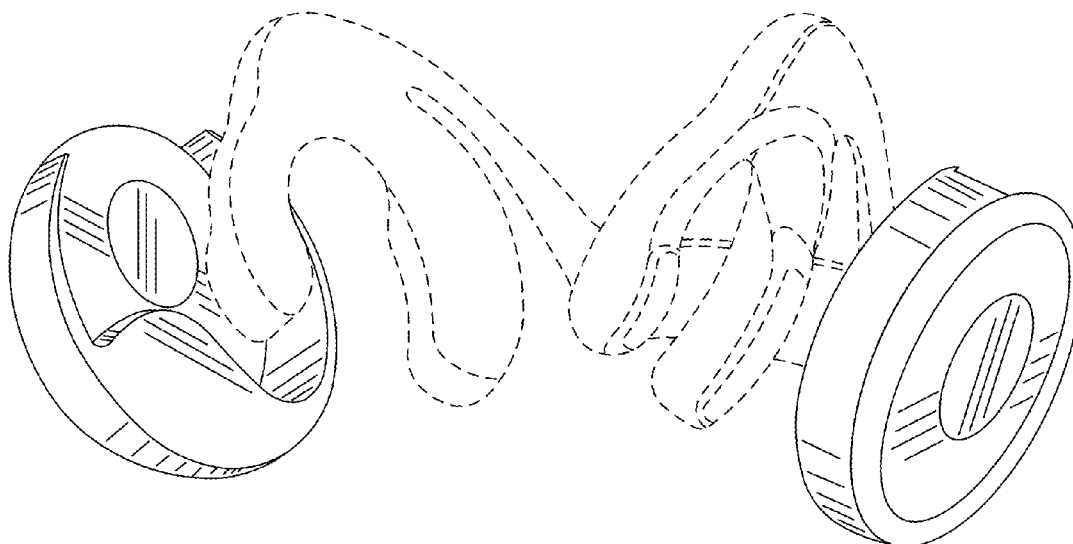

(56)

References Cited

U.S. PATENT DOCUMENTS

3,238,313 A * 3/1966 Kalogris H04R 1/12
 379/452
 4,385,209 A * 5/1983 Greason H04R 19/016
 307/400
 4,570,038 A * 2/1986 Tinelli H04R 1/12
 379/452
 4,669,129 A * 6/1987 Chance H04R 1/1008
 181/129
 D291,306 S * 8/1987 Espinosa 379/439
 4,791,684 A * 12/1988 Schwartz A61F 11/06
 2/209
 D307,275 S * 4/1990 Pollard 379/452
 5,018,599 A * 5/1991 Dohi H04R 1/1008
 181/129
 5,161,285 A * 11/1992 Jerjian A44B 1/14
 24/113 MP
 5,621,951 A * 4/1997 Gould A44B 1/14
 24/113 MP
 D402,412 S * 12/1998 Thorpe D28/82
 6,314,185 B1 * 11/2001 Lashley H04M 1/17
 379/439
 6,392,196 B1 * 5/2002 Lin A61F 11/14
 2/209

D464,630 S * 10/2002 Woodworth D13/171
 D469,411 S * 1/2003 Decosse D13/171
 D475,322 S * 6/2003 Ouellette D11/222
 D481,709 S * 11/2003 Solderits D14/223
 D512,417 S * 12/2005 Hirakawa D14/223
 D519,985 S * 5/2006 Wikel D14/205
 D568,290 S * 5/2008 Wikel D14/205
 D582,890 S * 12/2008 Koza D14/205
 D610,137 S * 2/2010 Horsham D14/250
 D657,776 S * 4/2012 Lee D14/205
 D671,914 S * 12/2012 Lee D14/205
 D677,243 S * 3/2013 Kitayama D14/205
 D696,643 S * 12/2013 Lee D14/205
 D697,047 S * 1/2014 Yoshida D14/205
 D702,209 S 4/2014 Lee
 D746,517 S 12/2015 Hayashi
 D754,631 S 4/2016 Charles
 D776,081 S 1/2017 Willman
 D795,835 S * 8/2017 Nagamine D14/205
 D809,478 S * 2/2018 Arimoto D14/205
 D846,526 S 4/2019 Spencer
 D860,972 S * 9/2019 Minarsch D14/223
 D884,670 S * 5/2020 White D14/205
 D893,449 S * 8/2020 Tsubone D14/205
 D897,986 * 10/2020 White D14/205

* cited by examiner

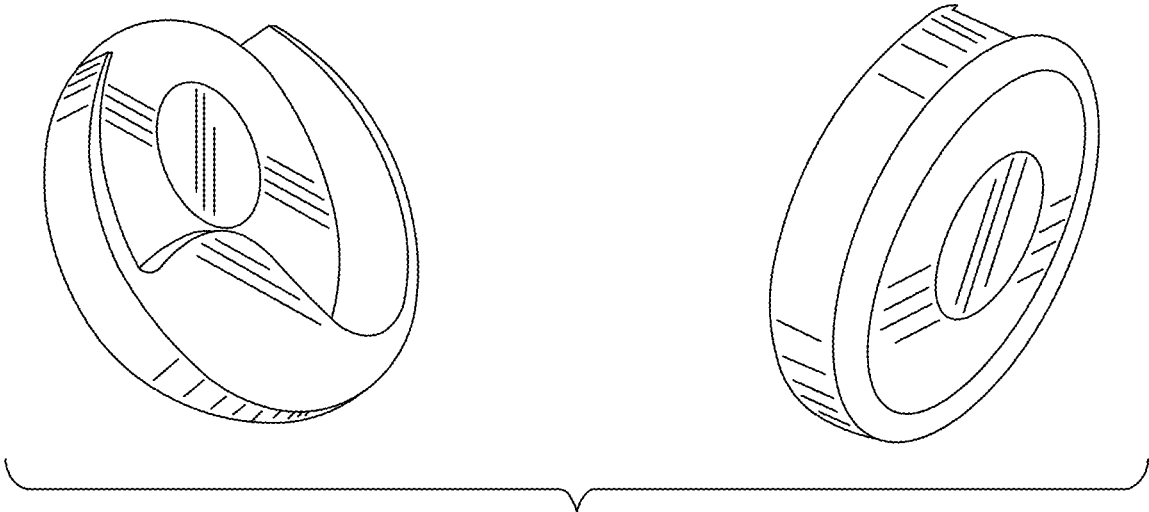

FIG. 1



FIG. 2

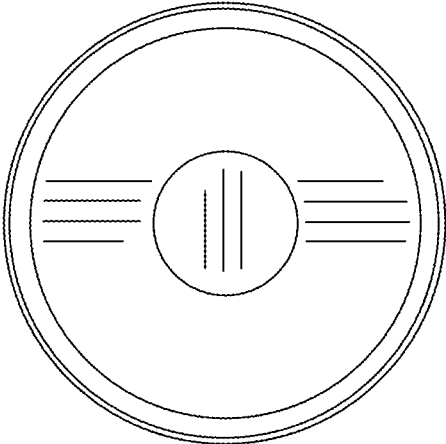

FIG. 3

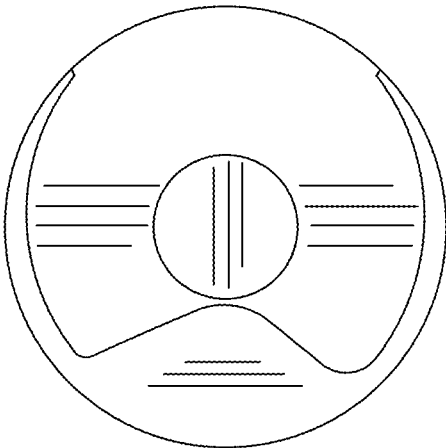

FIG. 4

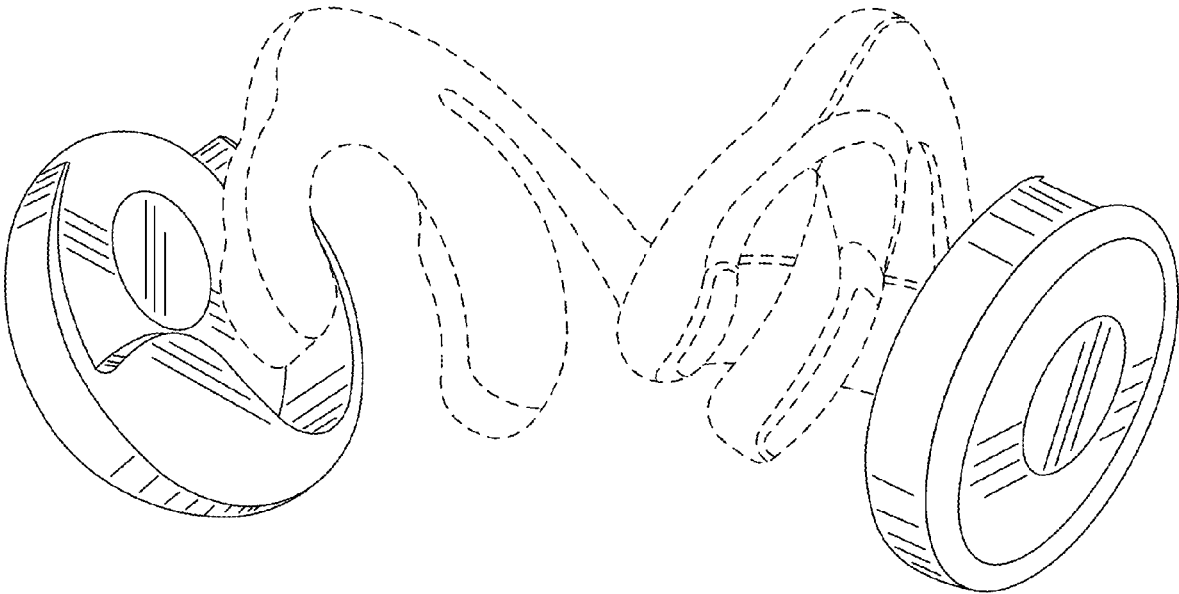

FIG. 5

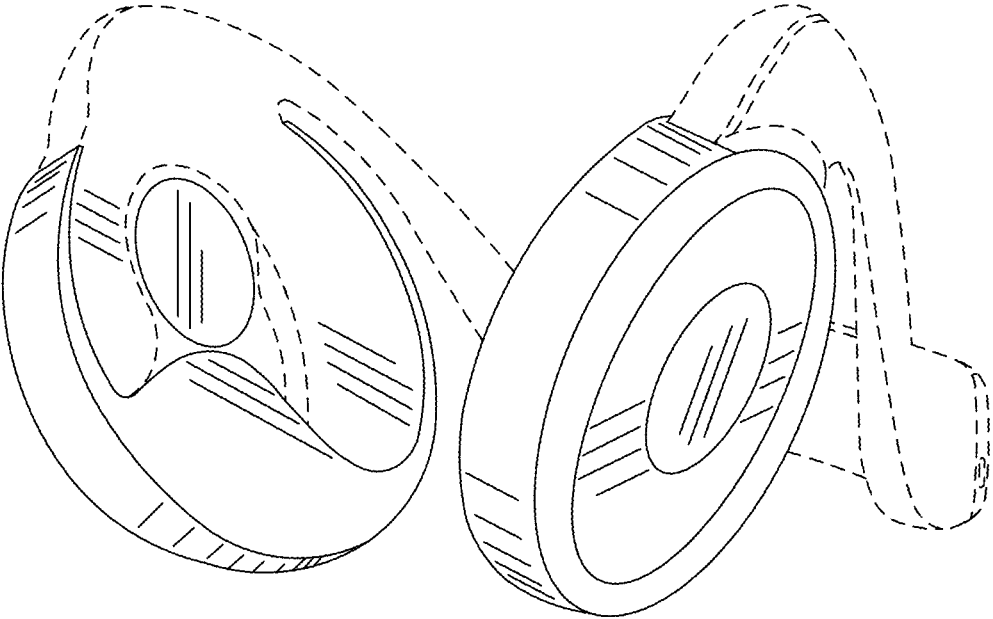

FIG. 6

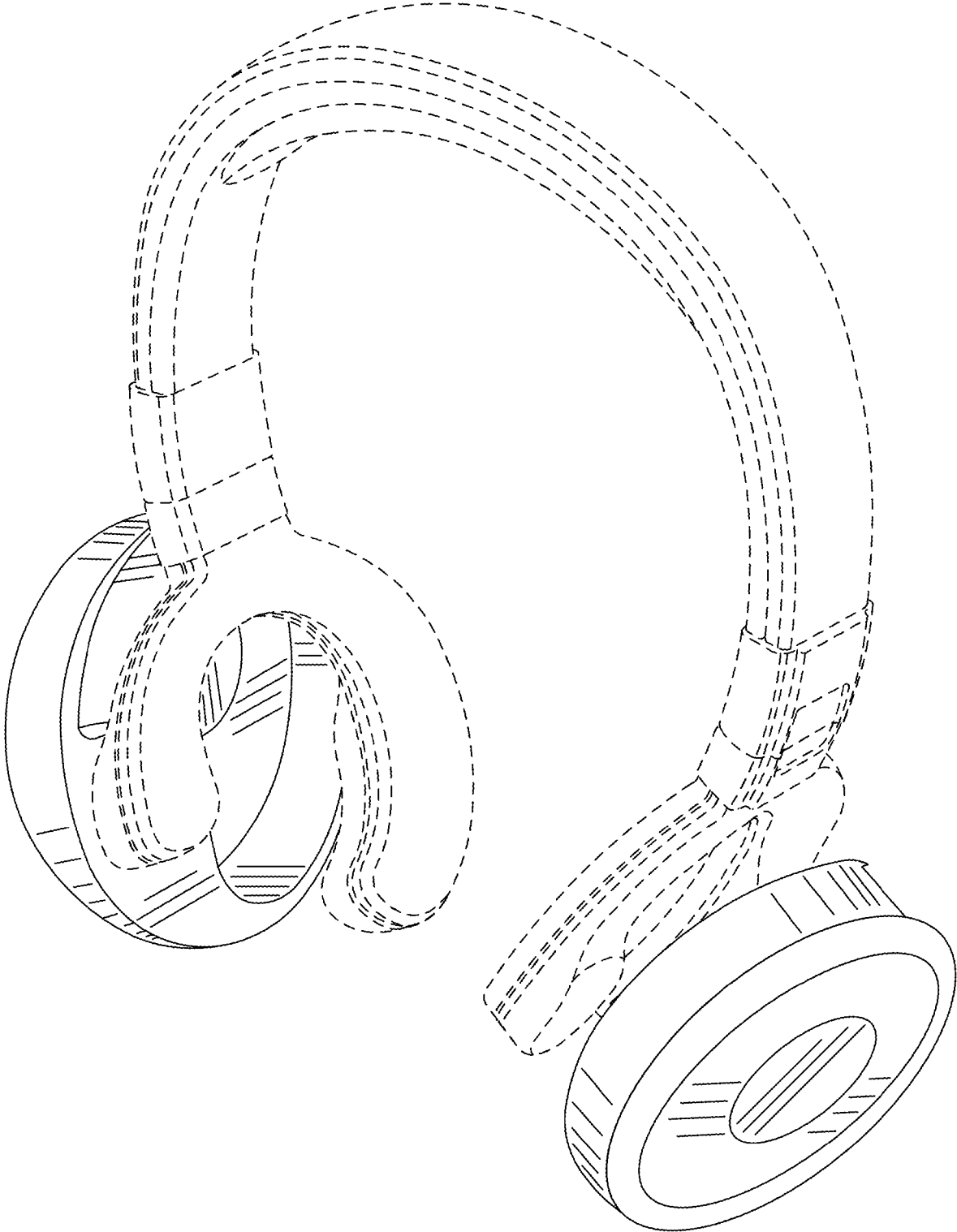

FIG. 7

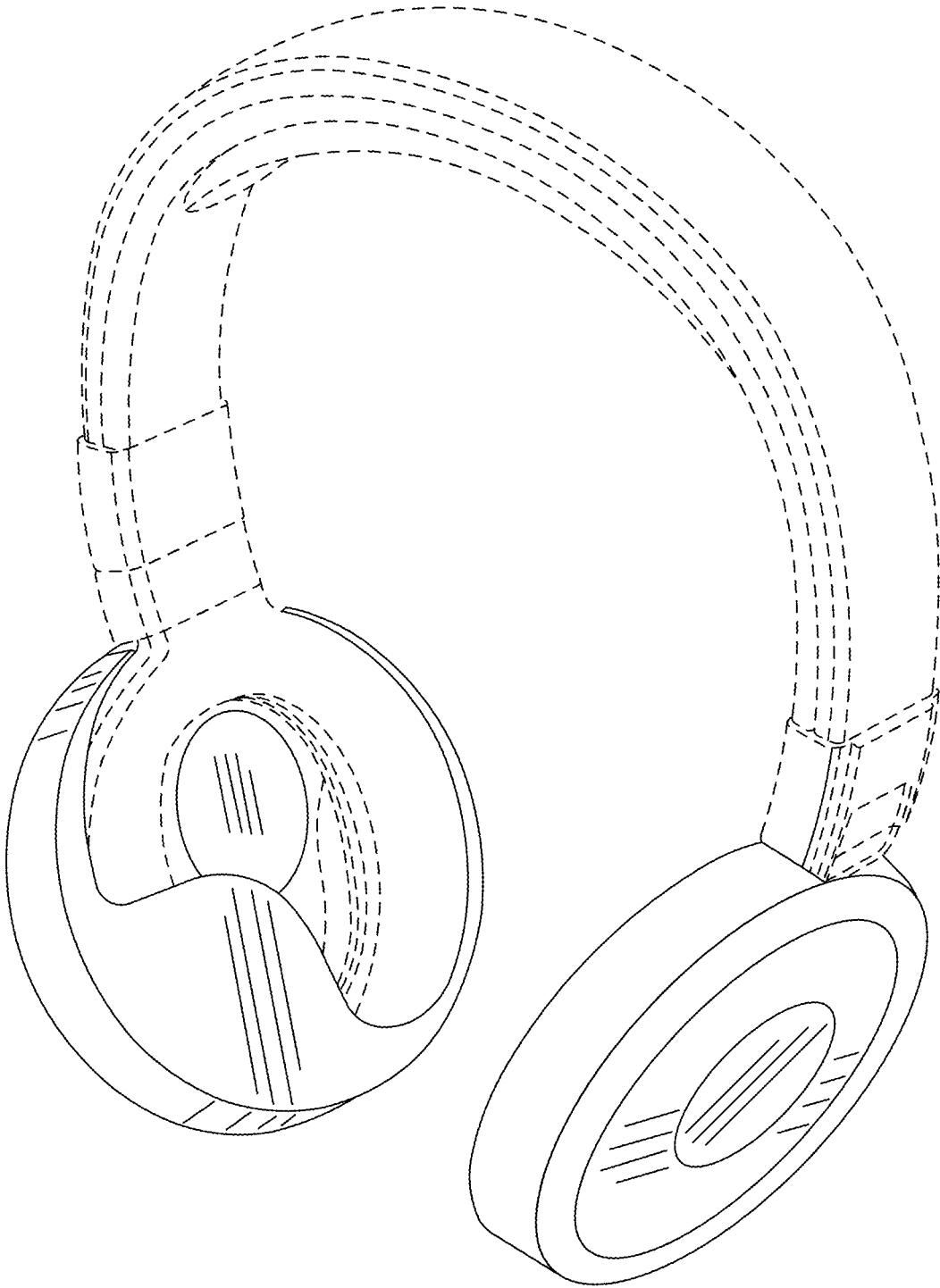

FIG.8

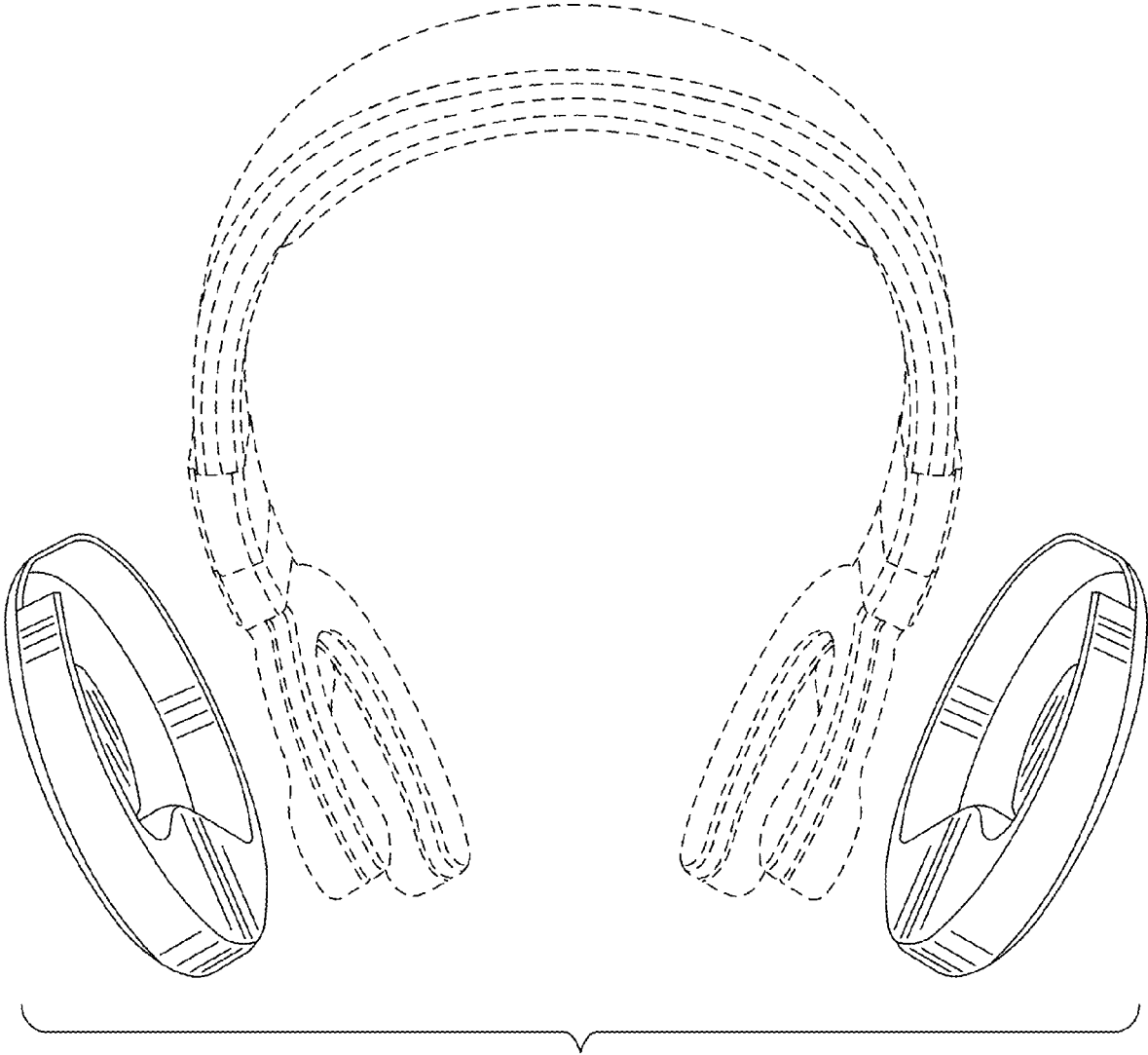

FIG.9

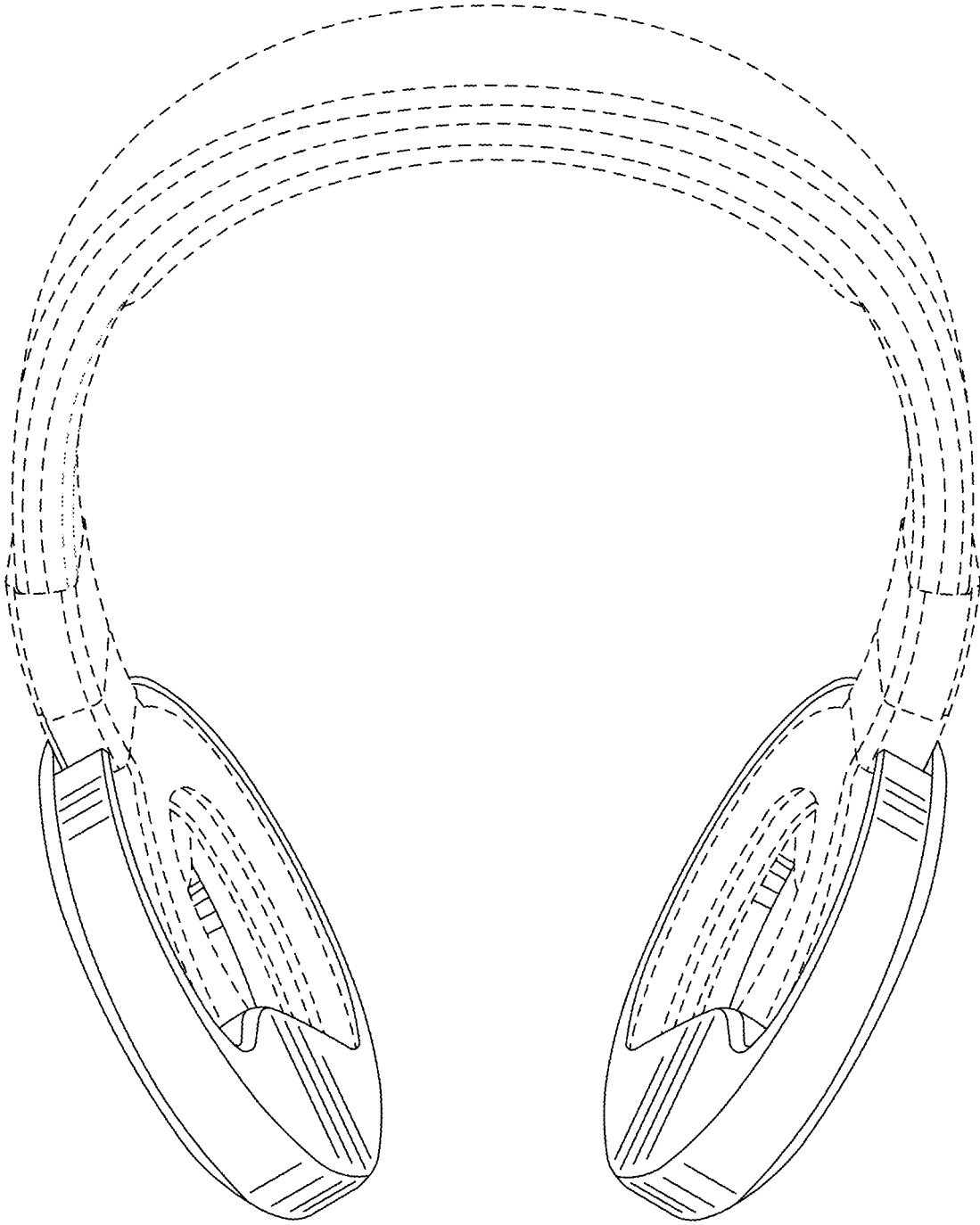

FIG. 10