



US00D461524S

(12) **United States Design Patent**  
**Lobermeier**

(10) **Patent No.:** **US D461,524 S**

(45) **Date of Patent:** **\*\* Aug. 13, 2002**

(54) **HAND SHOWER**

(75) **Inventor:** **Hans Lobermeier, Menden (DE)**

(73) **Assignee:** **Friedrich Grohe AG & Co. KG, Hemer (DE)**

(\*\*) **Term:** **14 Years**

(21) **Appl. No.:** **29/147,788**

(22) **Filed:** **Sep. 5, 2001**

(30) **Foreign Application Priority Data**

Mar. 28, 2001 (DE) ..... 401 03 064

(51) **LOC (7) Cl.** ..... **23-01**

(52) **U.S. Cl.** ..... **D23/223**

(58) **Field of Search** ..... D23/213, 223,  
D23/226; 239/394, 525; 4/615

(56) **References Cited**

**U.S. PATENT DOCUMENTS**

D361,623 S \* 8/1995 Huen ..... D23/223  
D424,162 S \* 5/2000 Haug et al. .... D23/223

D424,164 S \* 5/2000 Haug et al. .... D23/223

D428,110 S \* 7/2000 Haug et al. .... D23/223

D432,625 S \* 10/2000 Chan ..... D23/223

D440,630 S \* 4/2001 Gottwald ..... D23/223

\* cited by examiner

*Primary Examiner*—Robin V. Taylor

(74) *Attorney, Agent, or Firm*—Herbert Dubno

(57) **CLAIM**

The ornamental design for a hand shower, as shown and described.

**DESCRIPTION**

FIG. 1 is a bottom, front, left-side perspective view of a hand shower showing my new design;

FIG. 2 is a front elevational view thereof;

FIG. 3 is a right side elevational view thereof, the left side elevational view being mirror symmetrical thereto;

FIG. 4 is a rear elevational view thereof;

FIG. 5 is a bottom plan view thereof; and,

FIG. 6 is a top plan view thereof.

**1 Claim, 6 Drawing Sheets**

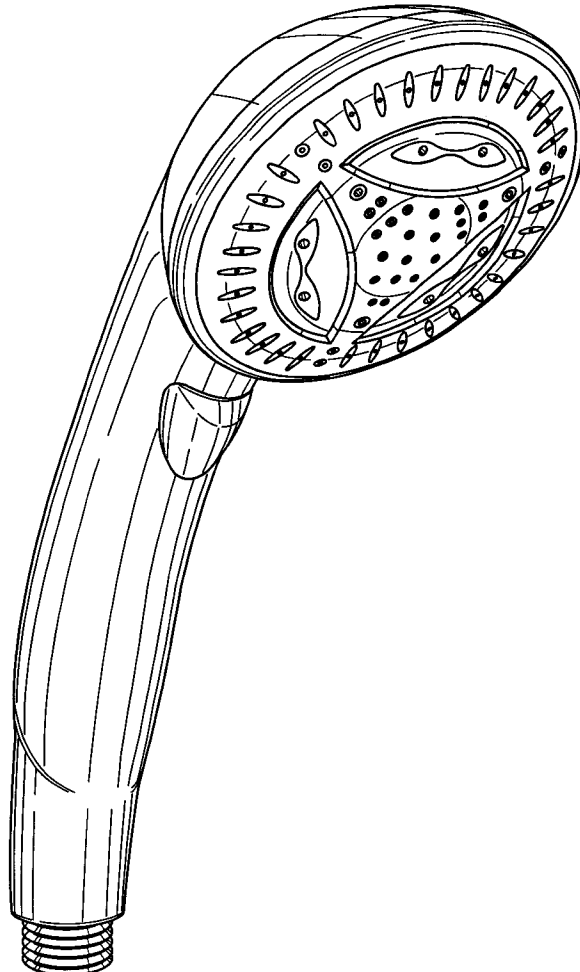

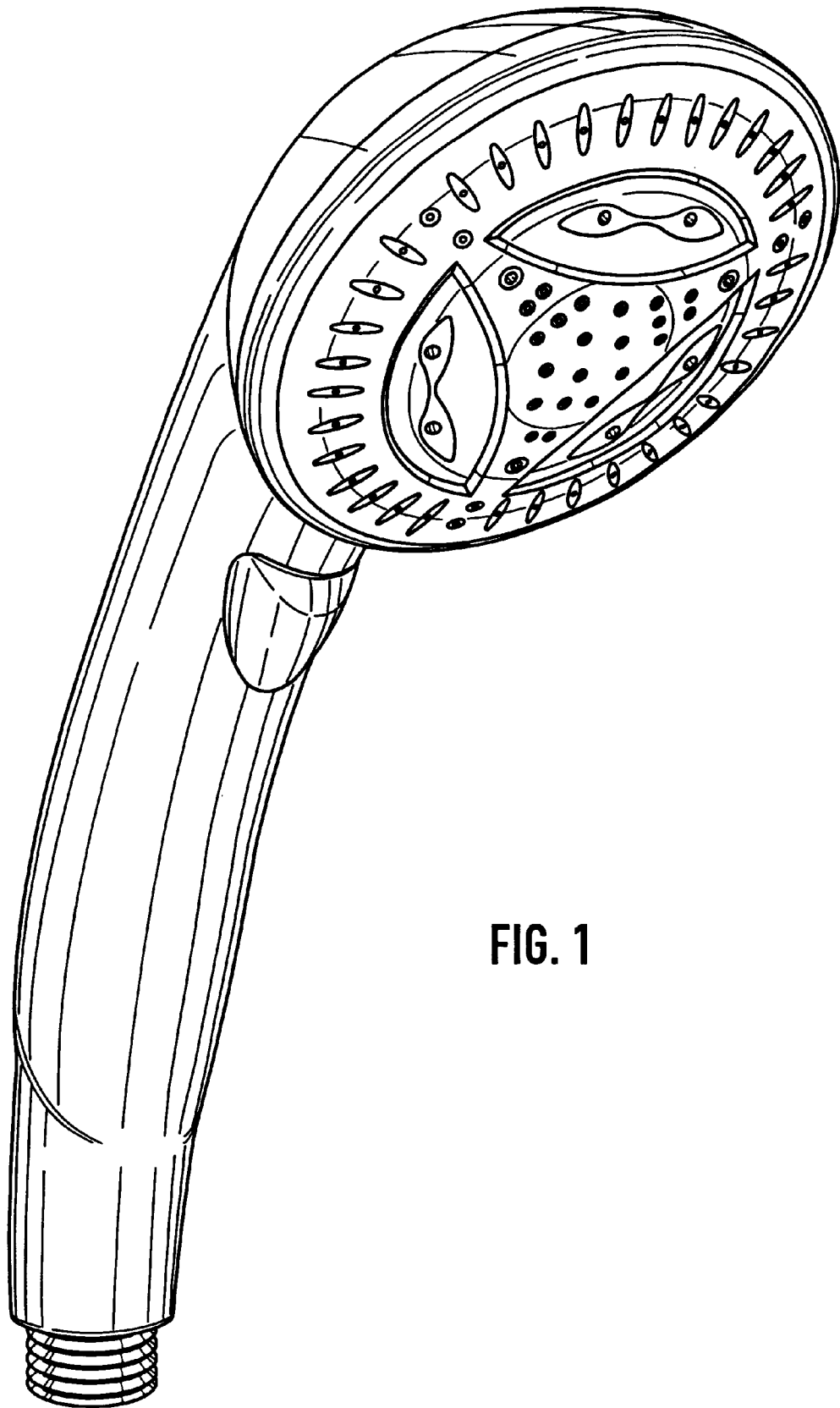

FIG. 1

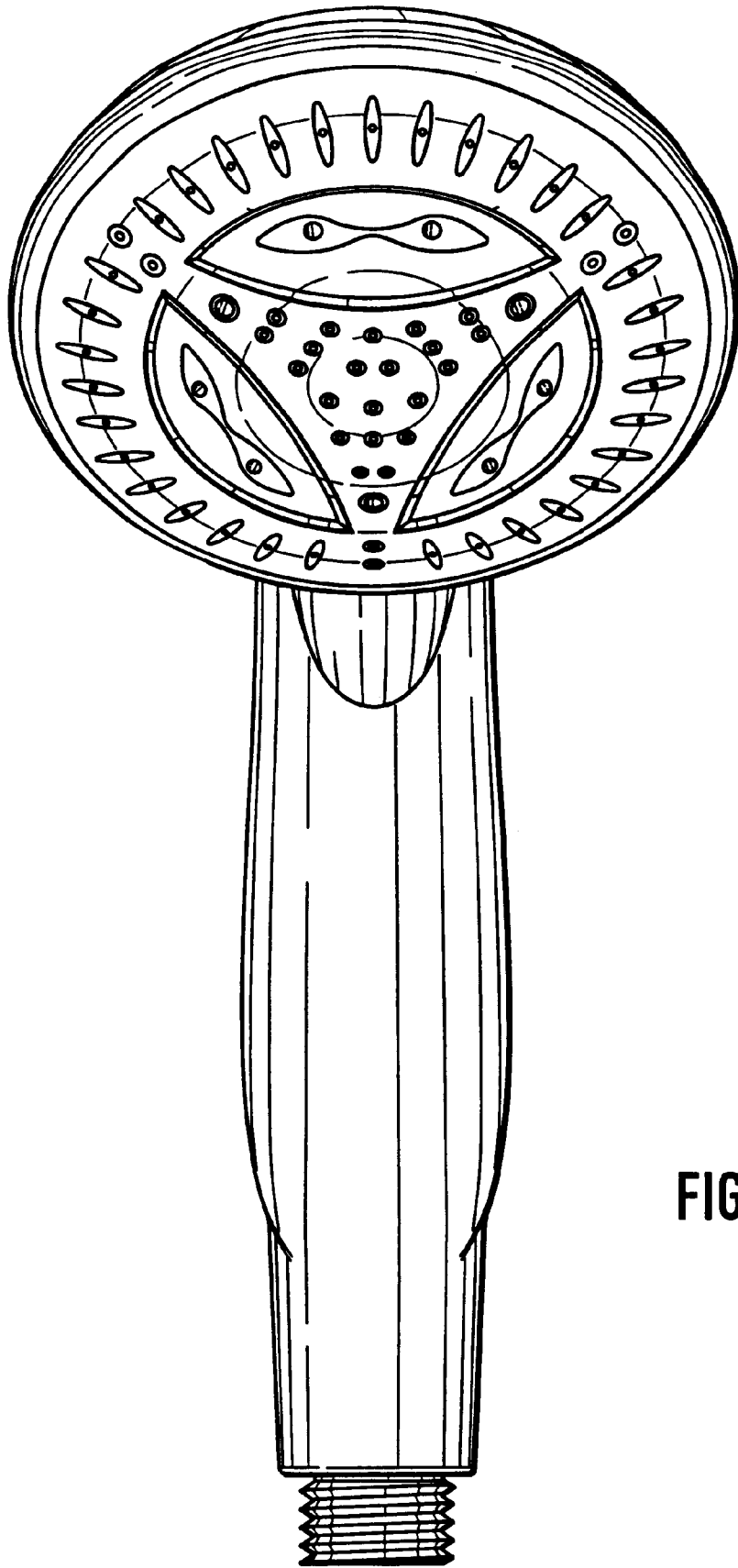

FIG. 2

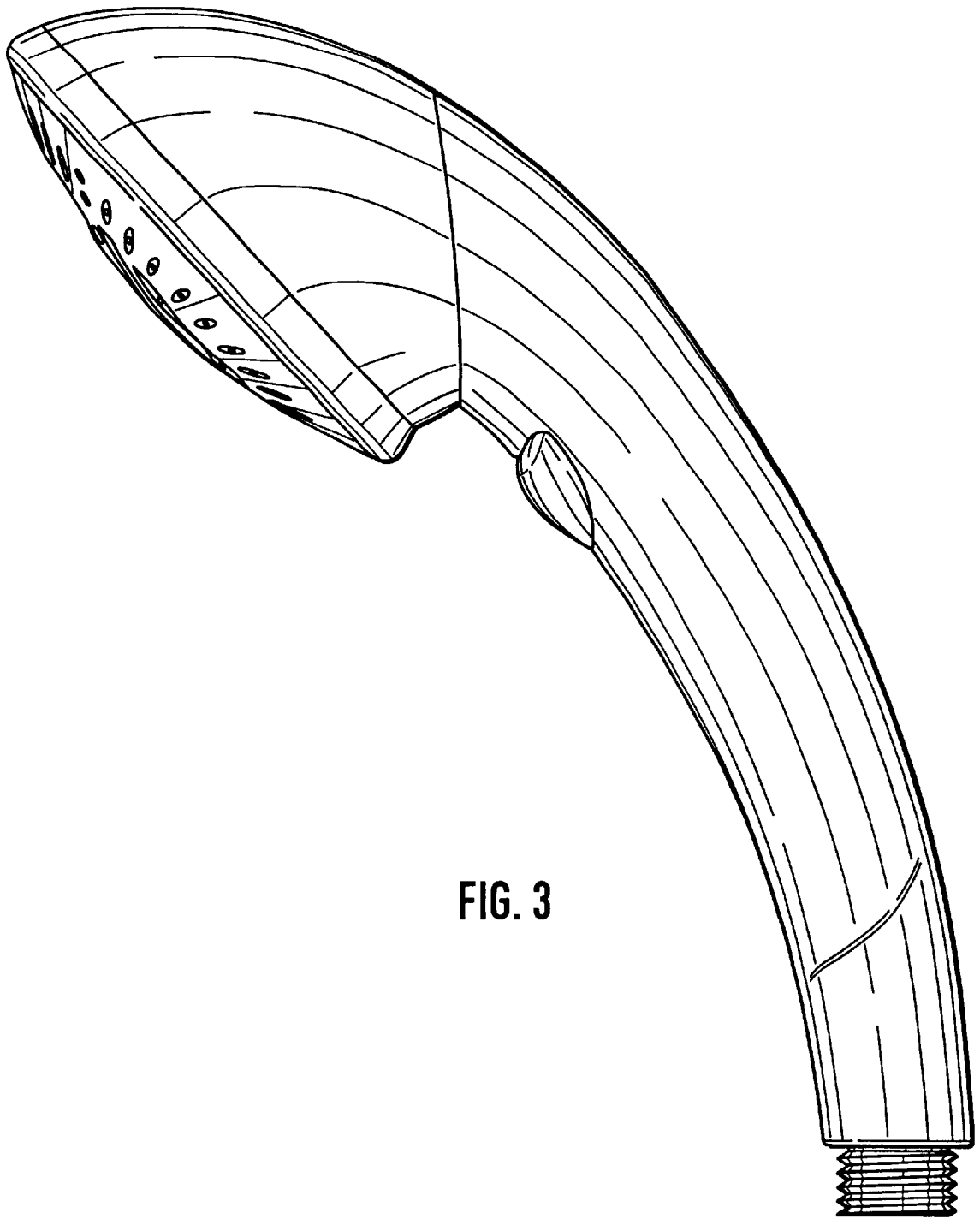

FIG. 3

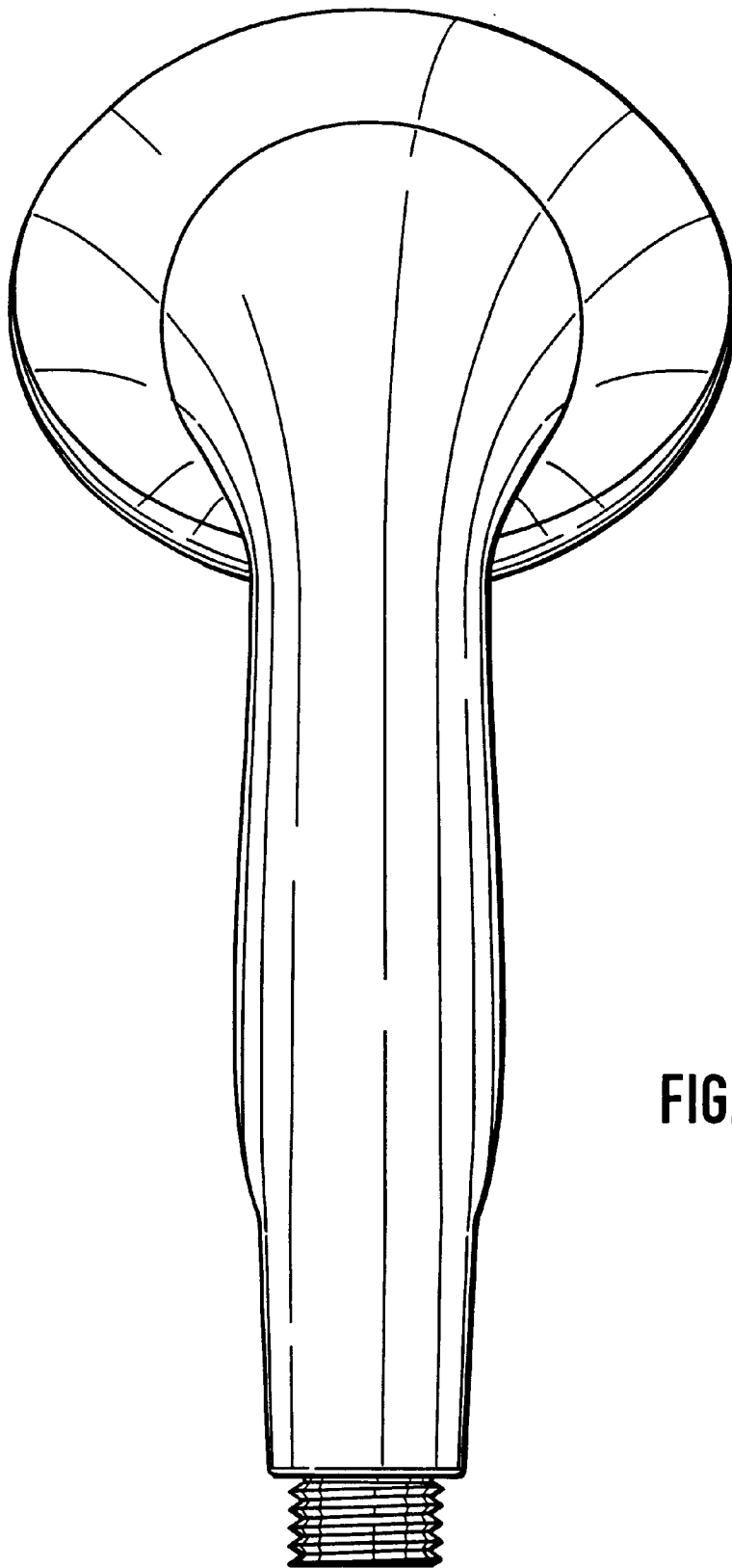

FIG. 4

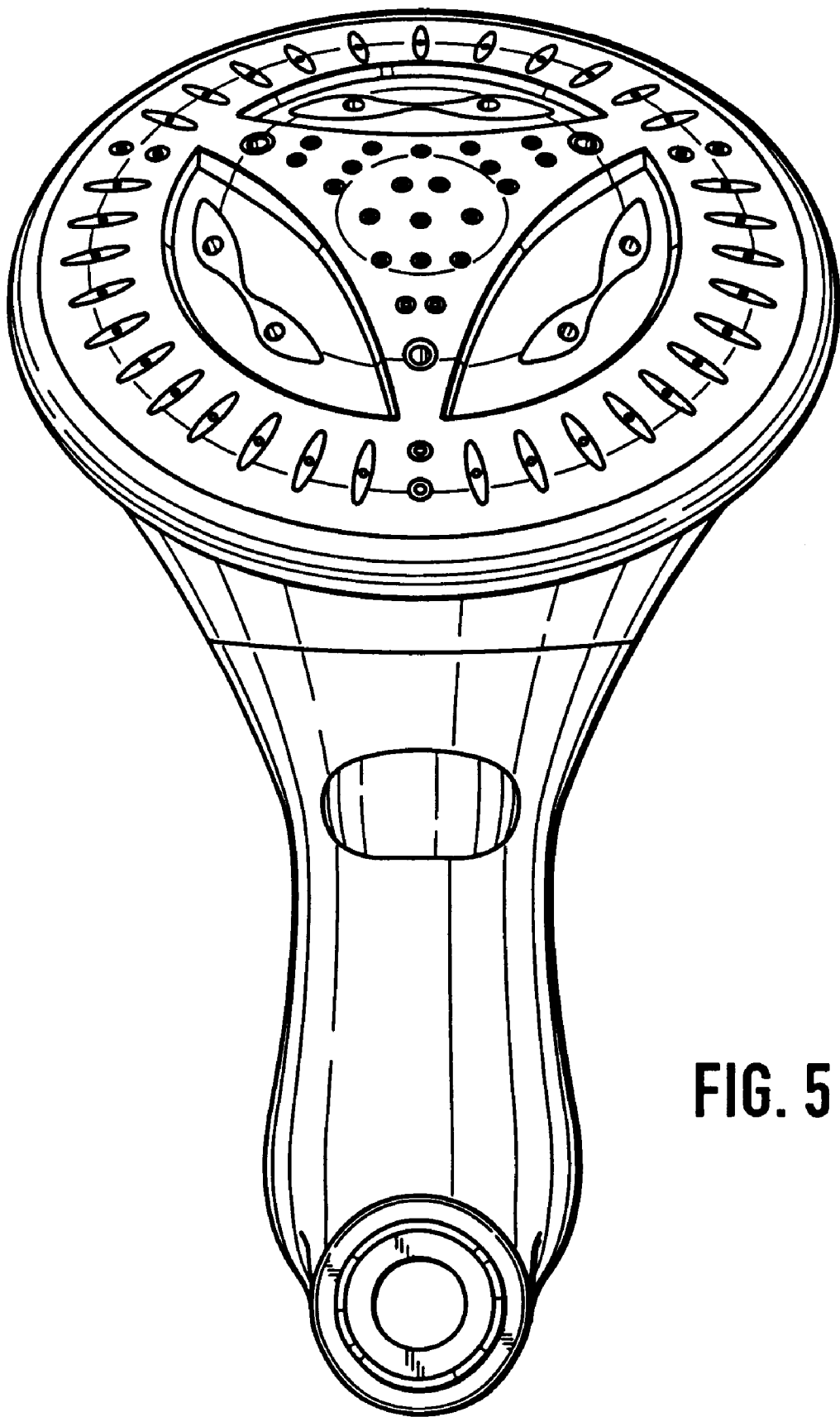
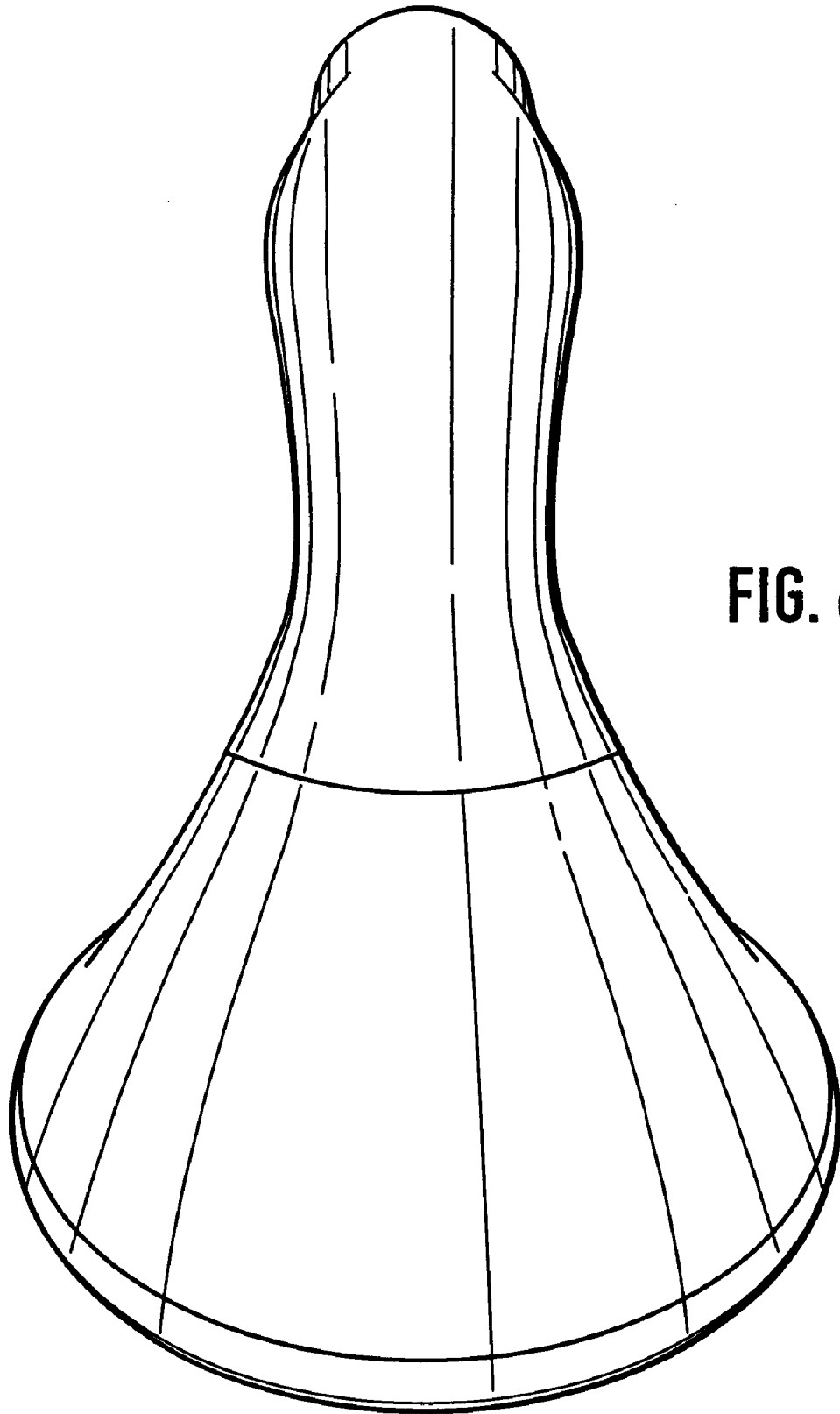

FIG. 5



**FIG. 6**