



US00D990879S

(12) **United States Design Patent**
Wang

(10) **Patent No.:** **US D990,879 S**

(45) **Date of Patent:** **** Jul. 4, 2023**

(54) **LUGGAGE**

(71) Applicant: **GUANGZHOU LUGGEX TECHNOLOGY CO. LTD,**
Guangzhou (CN)

(72) Inventor: **Kaihong Wang,** Guangzhou (CN)

(**) Term: **15 Years**

(21) Appl. No.: **29/884,225**

(22) Filed: **Feb. 8, 2023**

(51) **LOC (14) Cl.** **03-01**

(52) **U.S. Cl.**
USPC **D3/279**

(58) **Field of Classification Search**
USPC D3/201, 273, 276, 279, 281, 289
CPC A45C 5/00; A45C 5/03; A45C 2005/032;
A45C 2005/037; A45C 5/14; A45C
2005/142

See application file for complete search history.

(56) **References Cited**

U.S. PATENT DOCUMENTS

D563,101 S *	3/2008	Kuchler	D3/279
D602,252 S *	10/2009	Ehret	D3/289
D633,716 S *	3/2011	Turella-Yuan	D3/279
D644,435 S *	9/2011	Weng	D3/279
D659,395 S *	5/2012	Sijmons	D3/279
D665,998 S *	8/2012	Sijmons	D3/279
D710,608 S *	8/2014	Yoneno	D3/321
D711,104 S *	8/2014	Lai	D3/279
D711,646 S *	8/2014	Ke	D3/289
D711,647 S *	8/2014	Chen	D3/279
D711,649 S *	8/2014	Chen	D3/279
D712,658 S *	9/2014	Lai	D3/279
D714,056 S *	9/2014	Weng	D3/279
D720,928 S *	1/2015	Roncato	D3/279
D722,771 S *	2/2015	Wu	D3/289
D724,323 S *	3/2015	Wang	D3/321
D725,907 S *	4/2015	Yu	D3/279

D732,823 S *	6/2015	Baron	D3/276
D733,428 S *	7/2015	Sijmons	D3/294
D740,557 S *	10/2015	Liao	D3/294
D740,558 S *	10/2015	Liao	D3/294
D755,518 S *	5/2016	Sijmons	D3/289
D771,382 S *	11/2016	Maeda	D3/279
D783,282 S *	4/2017	Sijmons	D3/279
D789,691 S *	6/2017	Burns	D3/318
D790,855 S *	7/2017	Ji	D3/279
D791,477 S *	7/2017	Liu	D3/279
D796,198 S *	9/2017	Sanz	D3/289

(Continued)

OTHER PUBLICATIONS

Luggex, Carry On Luggage with Front Pocket—Hard Shell Suitcase 22x14x9 Airline Approved—Type-C USB Port for Worry-Free Travel (Grey Suitcase), Applicant started the first sale of this product Nov. 9, 2022. Date on Feb. 8, 2023. The link of the sale: <https://www.amazon.com/dp/B0BG5Q9SVP>.

Primary Examiner — Steven J Cxyz

(74) *Attorney, Agent, or Firm* — Xiaofang Zhong

(57)

CLAIM

The ornamental design for a luggage, as shown and described.

DESCRIPTION

FIG. 1 is a front, left and top perspective view of a luggage showing my new design;
FIG. 2 is a rear, right and bottom perspective view thereof;
FIG. 3 is a front elevational view thereof;
FIG. 4 is a rear elevational view thereof;
FIG. 5 is a right view thereof;
FIG. 6 is a left view thereof;
FIG. 7 is a top plan view thereof;
FIG. 8 is a bottom plan view thereof; and,
FIG. 9 is an enlarged view of a portion labeled as 9 on FIG. 1.

1 Claim, 9 Drawing Sheets

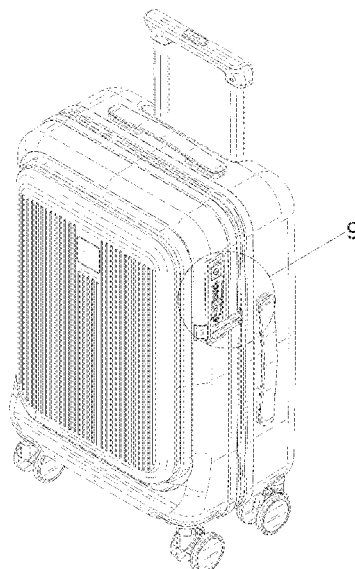

(56)

References Cited

U.S. PATENT DOCUMENTS

D796,199	S *	9/2017	Law	D3/279	D922,768	S *	6/2021	Chen	D3/279
D796,838	S *	9/2017	Sijmons	D3/279	D925,911	S *	7/2021	Sun	D3/279
D801,047	S *	10/2017	Bhatnagar	D3/279	D942,754	S *	2/2022	Walsh	D3/279
D805,772	S *	12/2017	Oshima	D3/279	D944,522	S *	3/2022	Chen	D3/279
D807,034	S *	1/2018	Chen	D3/273	D944,523	S *	3/2022	Ji	D3/901
D810,434	S *	2/2018	Xu	D3/279	D946,891	S *	3/2022	Huang	D3/279
D816,335	S *	5/2018	Chen	D3/273	D947,537	S *	4/2022	Wu	A45C 5/14
D821,098	S *	6/2018	Sheikh	D3/318					D3/321
D824,169	S *	7/2018	Guo	D3/279	D953,032	S *	5/2022	Sanz	A45C 5/03
D830,693	S *	10/2018	Maeda	D3/289					D3/321
D836,909	S *	1/2019	Karl	D3/279	D957,125	S *	7/2022	Chan	A45C 5/03
D843,114	S *	3/2019	Sanz						D3/279
D843,726	S *	3/2019	Sanz	D3/318	D957,126	S *	7/2022	Blot	D3/279
D849,403	S *	5/2019	Tong	D3/279	D963,344	S *	9/2022	Nichols et al.	D3/279
D852,505	S *	7/2019	Chen	D3/279	D965,975	S *	10/2022	Rubio	A45C 5/03
D854,327	S *	7/2019	Sanz	D3/321					D3/273
D862,880	S *	10/2019	Evangelista	D3/279	D968,084	S *	11/2022	Bruendl	A45C 5/03
D871,073	S *	12/2019	Schaepers	D3/318					D3/289
D873,001	S *	1/2020	Alvarez	D3/274	D968,085	S *	11/2022	Bruendl	A45C 5/02
D874,139	S *	2/2020	Rubio	D3/279					D3/289
D876,091	S *	2/2020	Baron	D3/279	D968,086	S *	11/2022	Santoriello	A45C 15/00
D881,569	S *	4/2020	Rubio	D3/279					D3/289
D882,948	S *	5/2020	Xu	D3/279	D974,756	S *	1/2023	Yang	D3/289
D885,761	S *	6/2020	Wu	D3/279	D975,442	S *	1/2023	Huang	D3/289
D889,835	S *	7/2020	Roosen	D3/318	D976,584	S *	1/2023	Blais	D3/279
D899,083	S *	10/2020	Rubio	D3/279	2016/0113366	A1 *	4/2016	Sijmons	A45C 5/03
D899,084	S *	10/2020	Rubio	D3/289					190/124
D905,431	S *	12/2020	Moon	D3/279	2017/0079398	A1 *	3/2017	Reh	A45C 15/00
D907,920	S *	1/2021	Li	D3/279	2017/0318926	A1 *	11/2017	Sijmons	A45C 5/02
D909,062	S *	2/2021	Qian	D3/279	2018/0035775	A1 *	2/2018	Haimoff	A45C 5/03
D915,068	S *	4/2021	Rubio	D3/285	2018/0220763	A1 *	8/2018	Morszeck	A45C 5/03
D915,767	S *	4/2021	Moon	D3/279	2019/0080632	A1 *	3/2019	Yu	A45C 5/03
D918,581	S *	5/2021	Chen	D3/279	2020/0069018	A1 *	3/2020	Chiang	A45C 5/03
D918,582	S *	5/2021	Chen	D3/279	2020/0352292	A1 *	11/2020	Naparstek	A45C 5/03
D920,669	S *	6/2021	Tu	D3/279	2020/0352299	A1 *	11/2020	Rubio	A45C 5/03
D922,067	S *	6/2021	Huang	A45C 5/00	2022/0061481	A1 *	3/2022	Phillips	A45C 5/14
				D23/269	2022/0151351	A1 *	5/2022	Lai	A45C 13/262
					2022/0234385	A1 *	7/2022	Hou	A45C 13/10
					2022/0248820	A1 *	8/2022	Dauchin	A45C 5/14

* cited by examiner

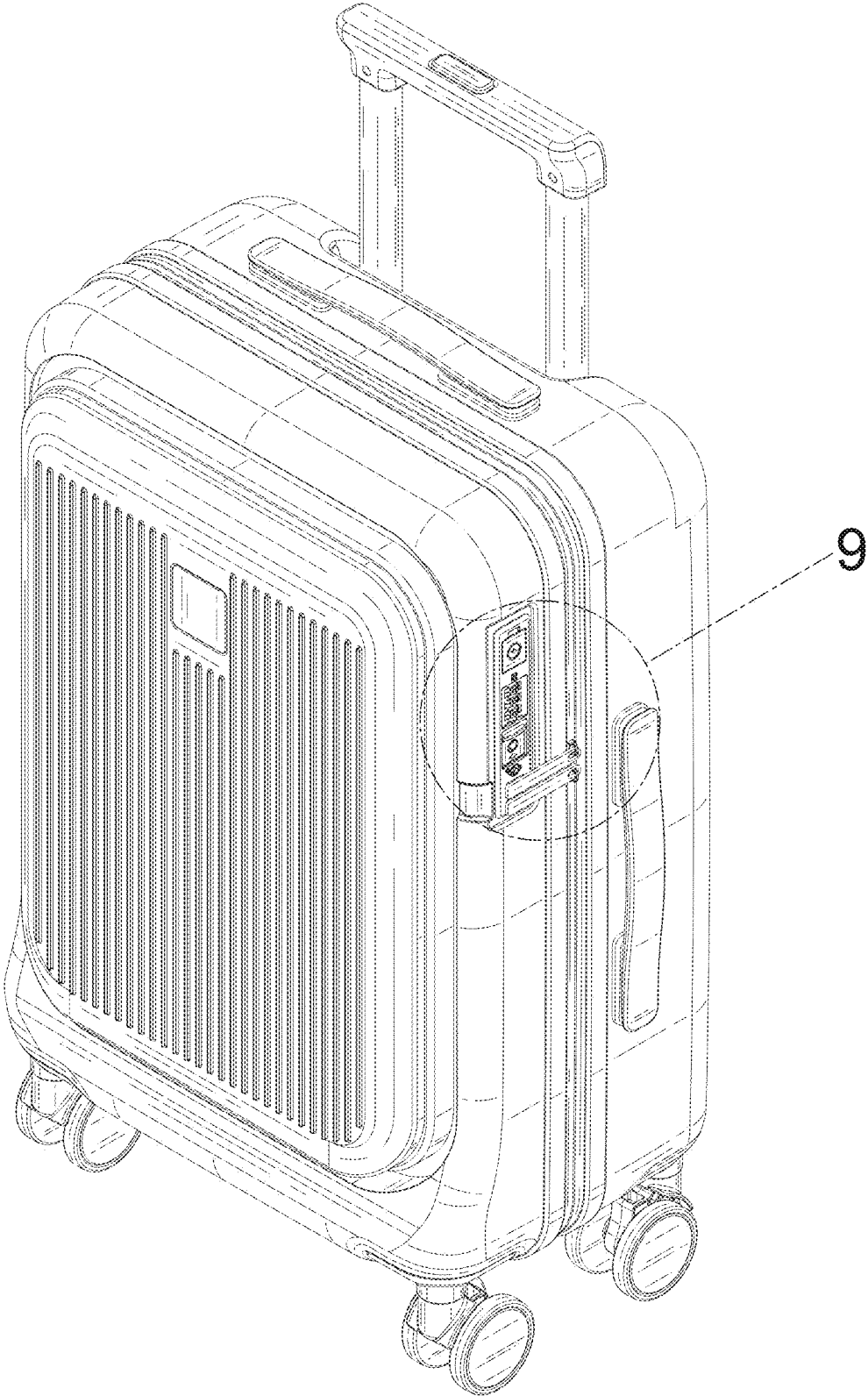

FIG. 1

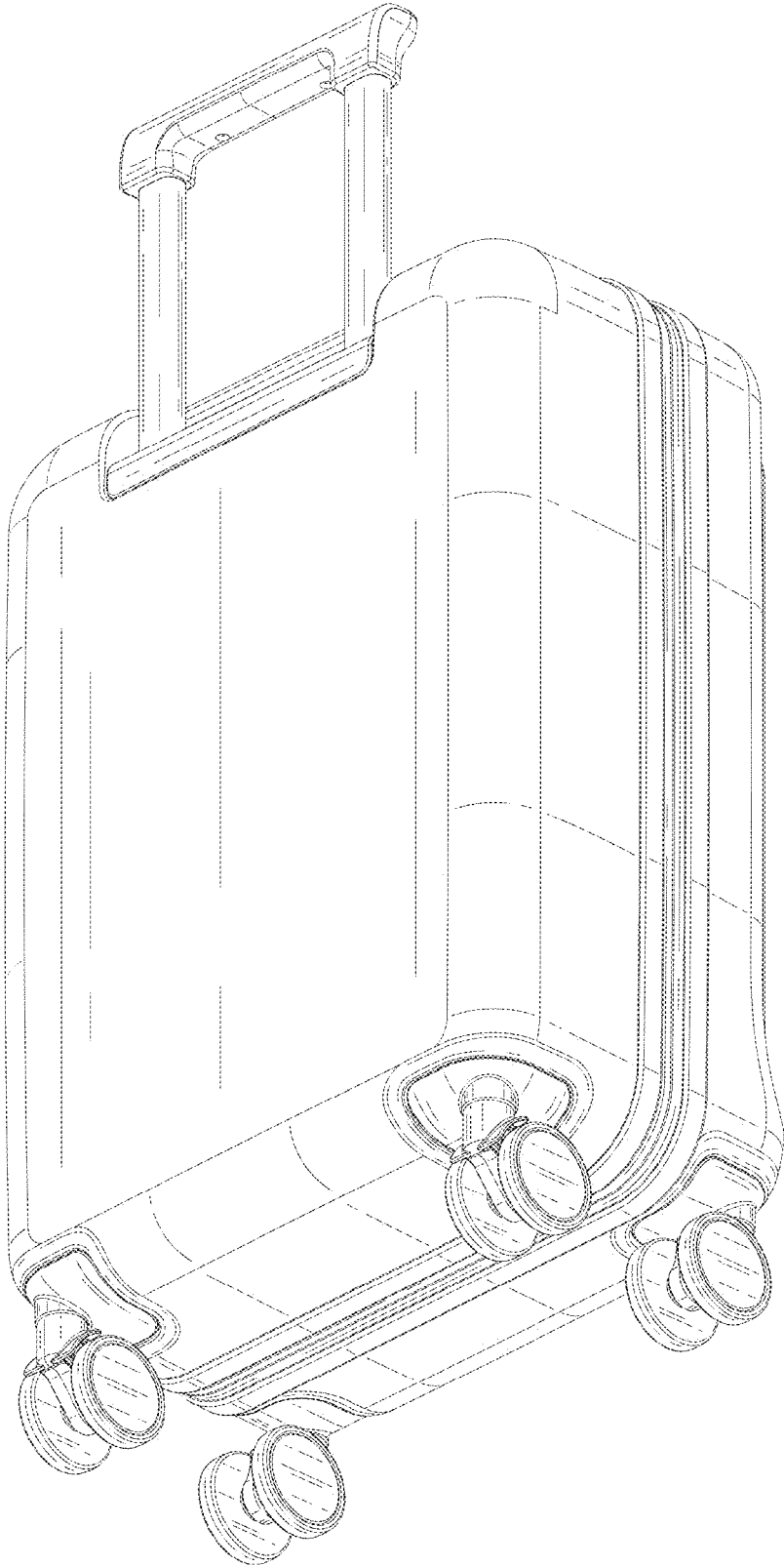

FIG. 2

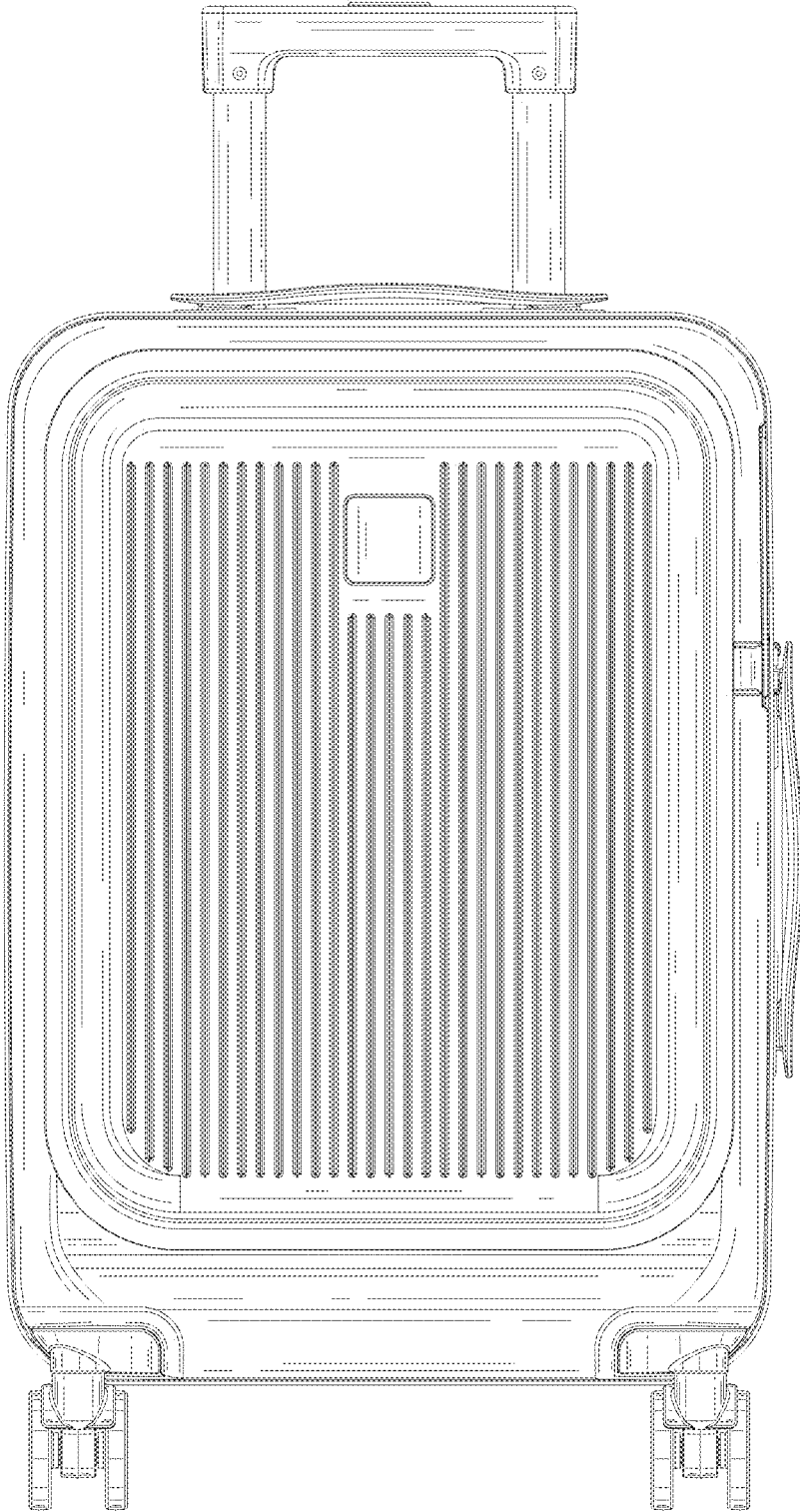

FIG. 3

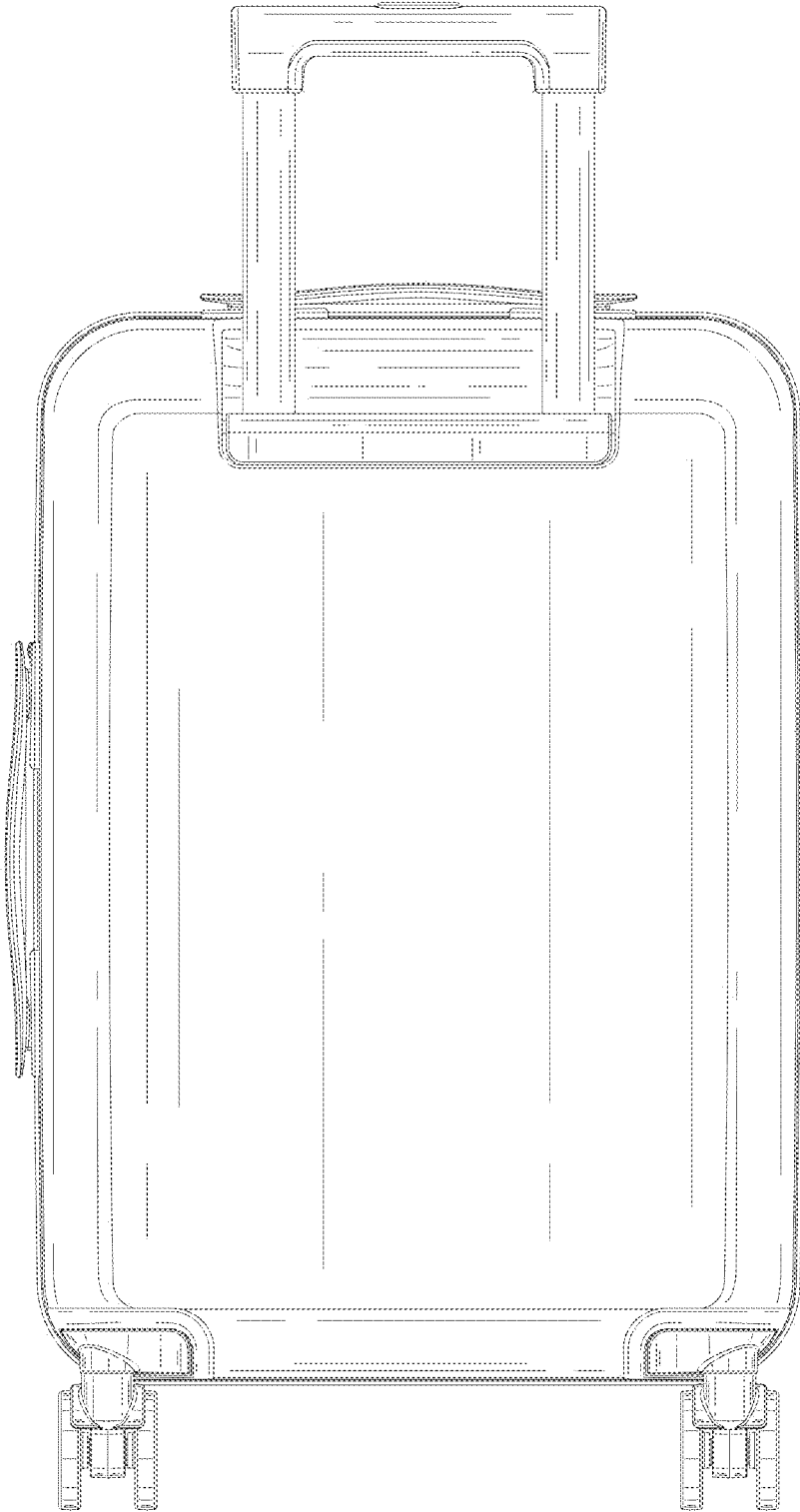

FIG. 4

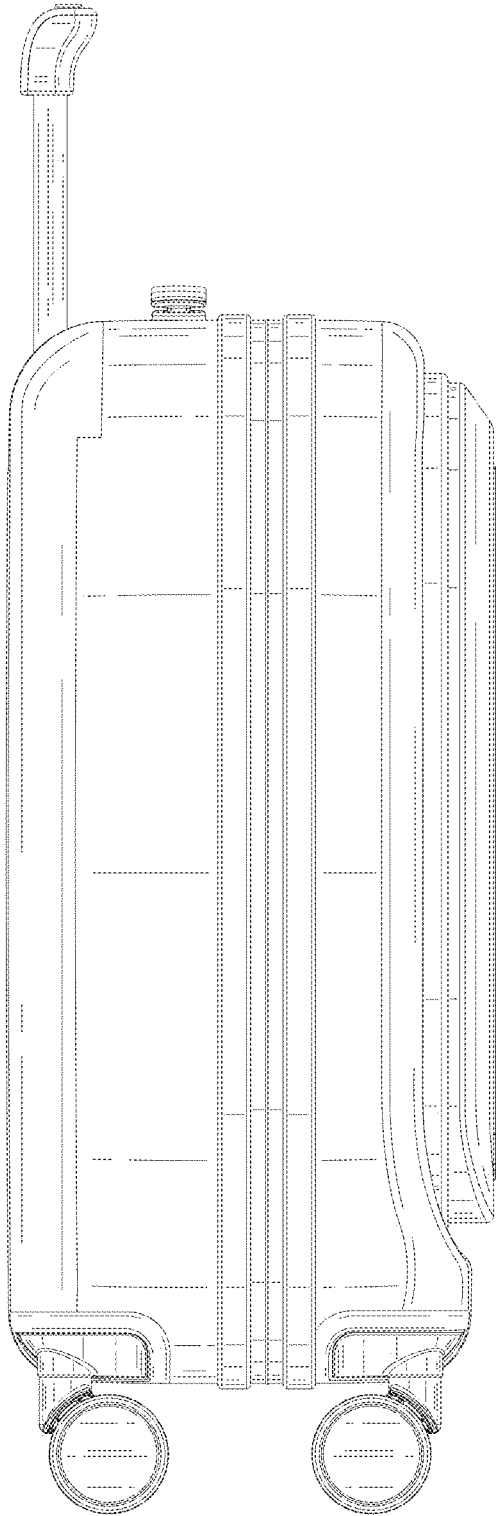

FIG. 5

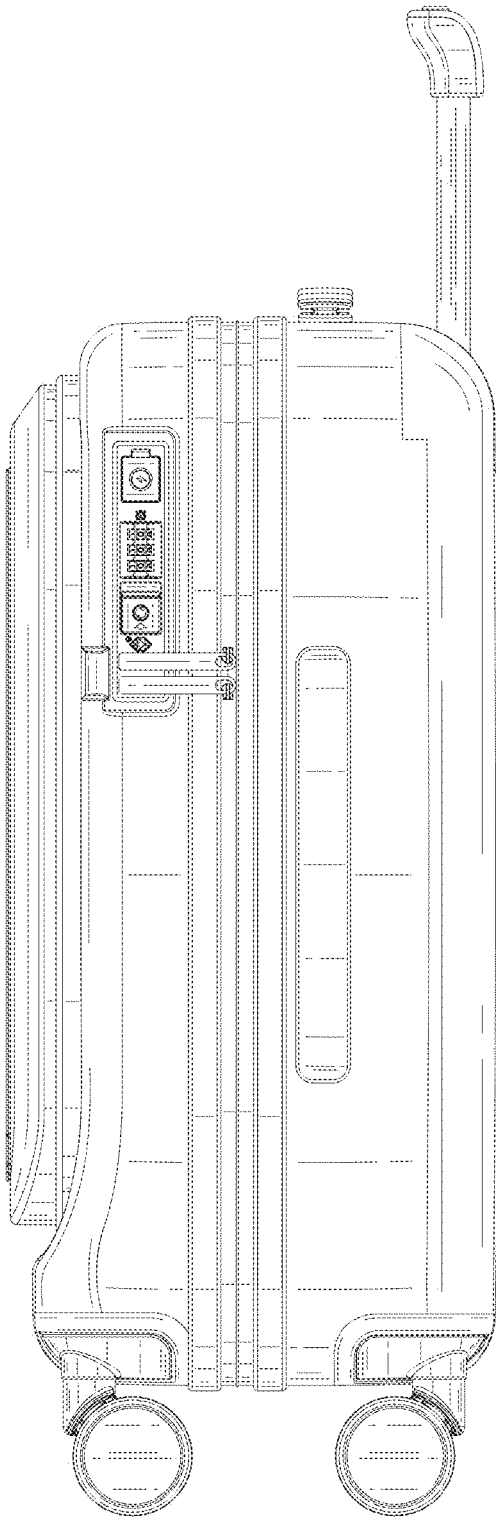

FIG. 6

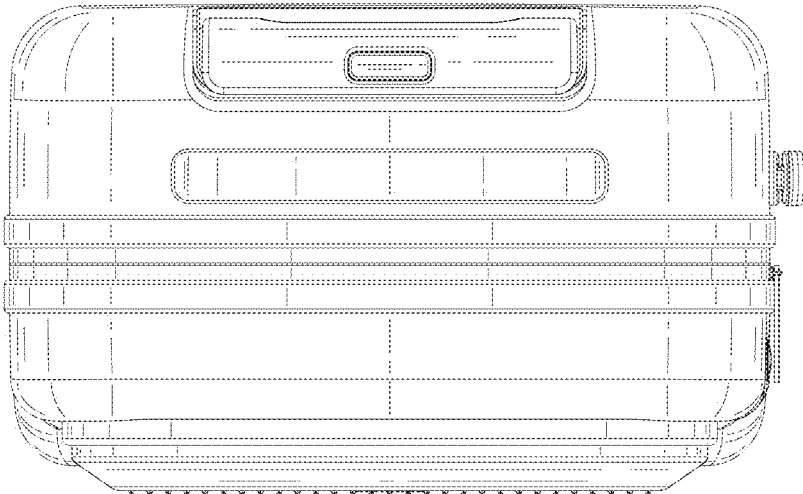

FIG. 7

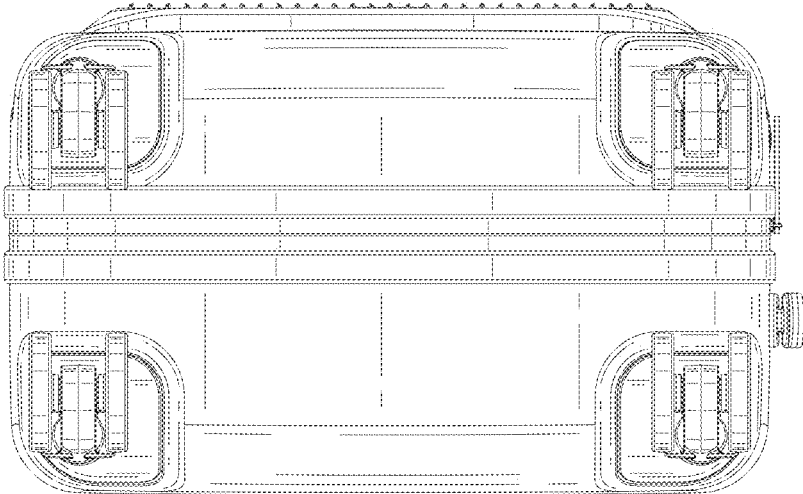

FIG. 8

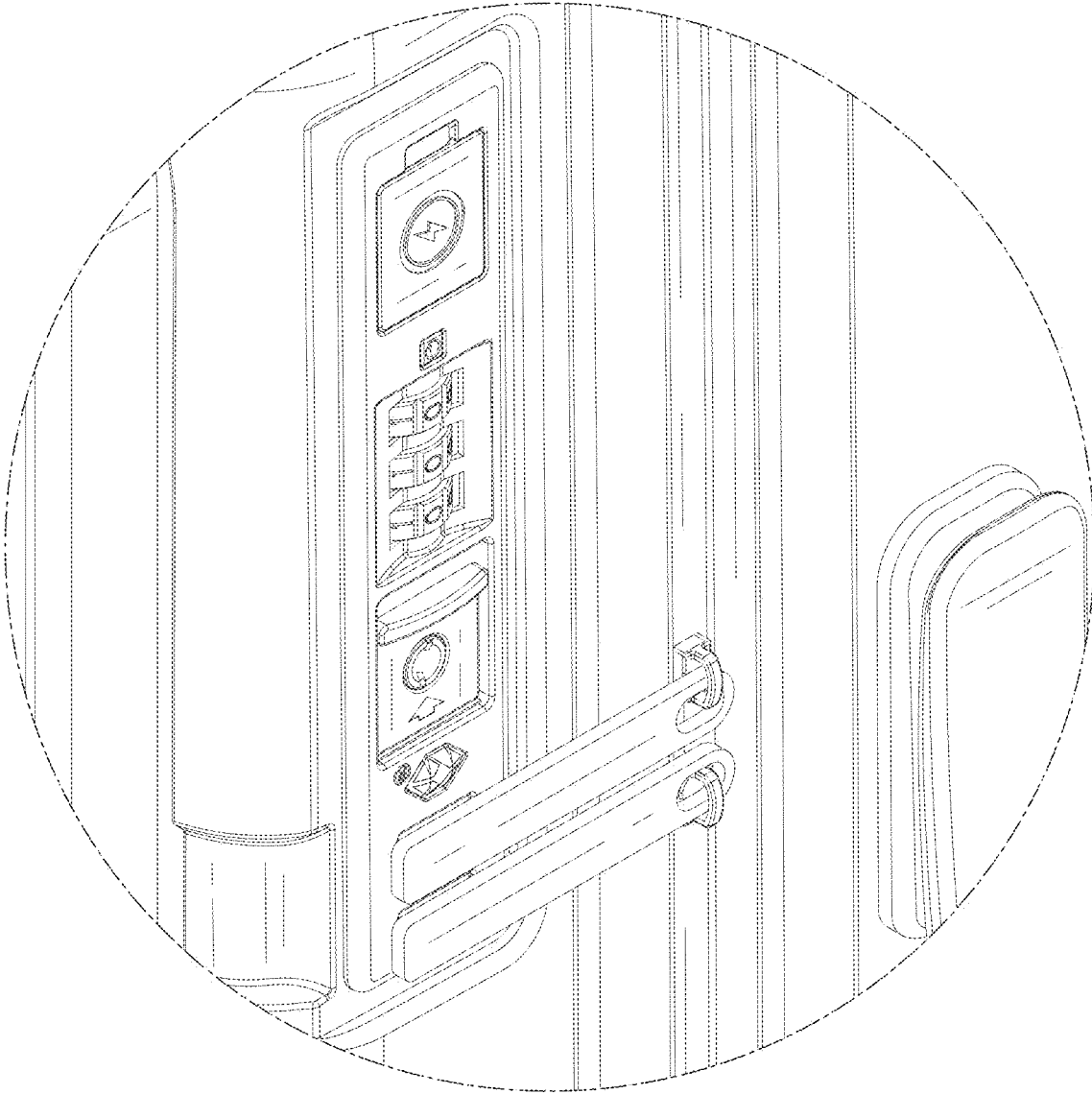

FIG. 9