



US00D727775S

(12) **United States Design Patent**
Yatsugi-Kang

(10) **Patent No.:** **US D727,775 S**

(45) **Date of Patent:** **** Apr. 28, 2015**

(54) **EARRING**

(71) Applicant: **Harry Winston SA**, Plan-les-Ouates (CH)

(72) Inventor: **Rie Yatsugi-Kang**, Cresskill, NJ (US)

(73) Assignee: **Harry Winston SA**, Plan-les-Ouates (CH)

(**) Term: **14 Years**

(21) Appl. No.: **29/504,875**

(22) Filed: **Oct. 10, 2014**

(30) **Foreign Application Priority Data**

Apr. 10, 2014 (WO) DM/083 390

(51) **LOC (10) Cl.** **11-01**

(52) **U.S. Cl.**
USPC **D11/45**

(58) **Field of Classification Search**

USPC D11/1, 2, 40-48, 79, 80, 81, 86, 87, 88,
D11/91, 92, 96, 84, 63, 67, 66, 69; 63/12,
63/13, 1.11, 1.16, 26, 27, 28, 29.1, 29.2,
63/35, 40

See application file for complete search history.

(56) **References Cited**

U.S. PATENT DOCUMENTS

D126,797 S * 4/1941 Philippe D11/69
D135,782 S * 6/1943 Levy D11/40
D152,094 S * 12/1948 Katz D11/69
D175,614 S * 9/1955 Katz D11/69

D176,782 S * 1/1956 Katz D11/69
D177,135 S * 3/1956 Katz D11/40
D178,391 S * 7/1956 Katz D11/44
5,363,675 A * 11/1994 Carter 63/14.1
D558,093 S * 12/2007 Karachi-Langane D12/84
D570,725 S * 6/2008 Karachi-Langane D11/84

OTHER PUBLICATIONS

[Online] <http://www.harrywinston.com/store/jewels/secrets-collection/products/secret-cluster-by-harry-winston-diamond-earrings>. Retrieved Dec. 7, 2014.*

* cited by examiner

Primary Examiner — Garth Rademaker

Assistant Examiner — Melanie Pellegrini

(74) *Attorney, Agent, or Firm* — Donald J. Ranft; Kristen A. Mogavero; Colleen IP

(57) **CLAIM**

The ornamental design for an earring, as shown.

DESCRIPTION

FIG. 1 is a front right perspective view of an earring showing my new design;

FIG. 2 is a front view thereof;

FIG. 3 is a rear view thereof;

FIG. 4 is a left side view thereof;

FIG. 5 is a right side view thereof;

FIG. 6 is a top view thereof;

FIG. 7 is a bottom view thereof; and,

FIG. 8 is a rear right perspective view thereof.

1 Claim, 6 Drawing Sheets

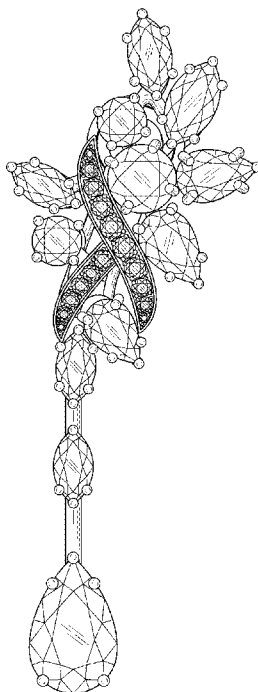

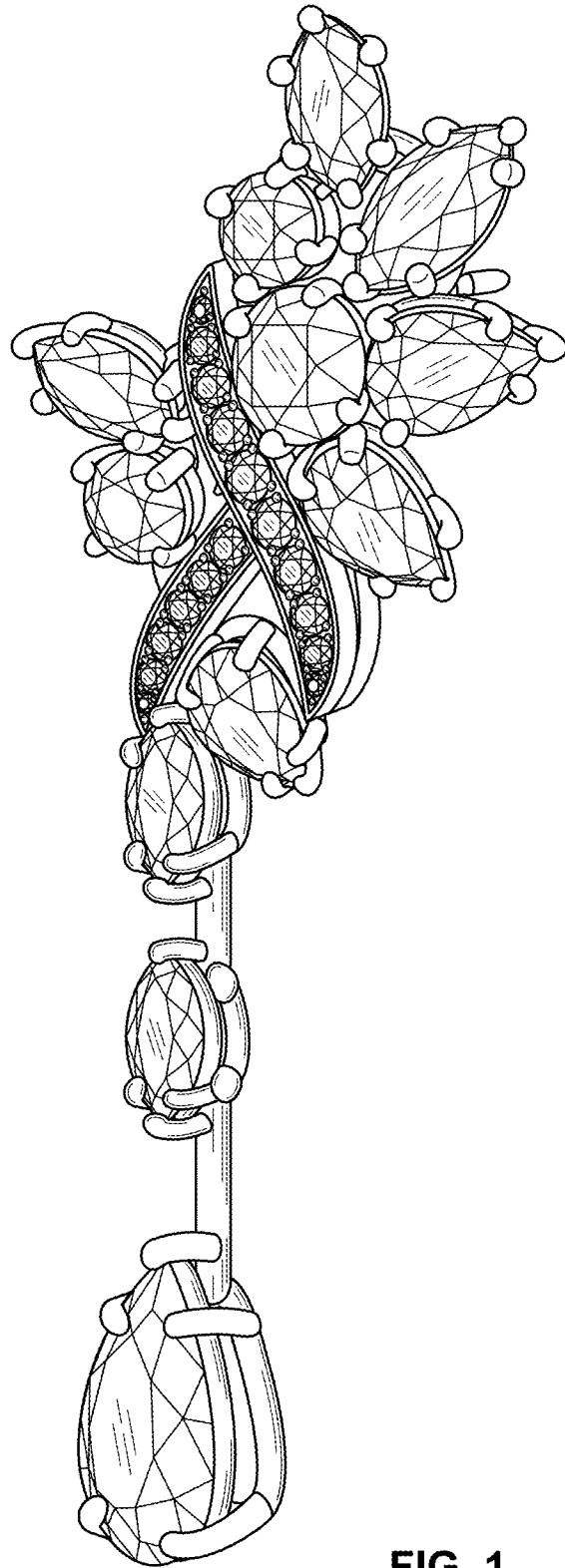

FIG. 1

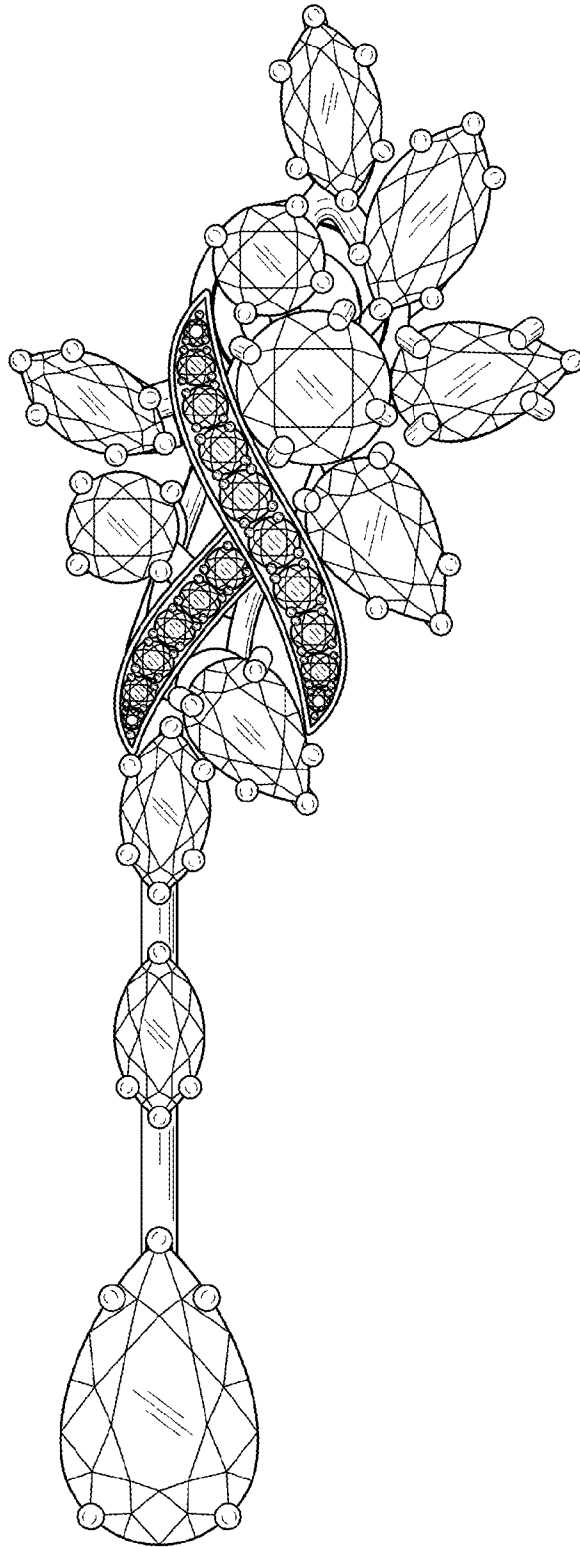

FIG. 2

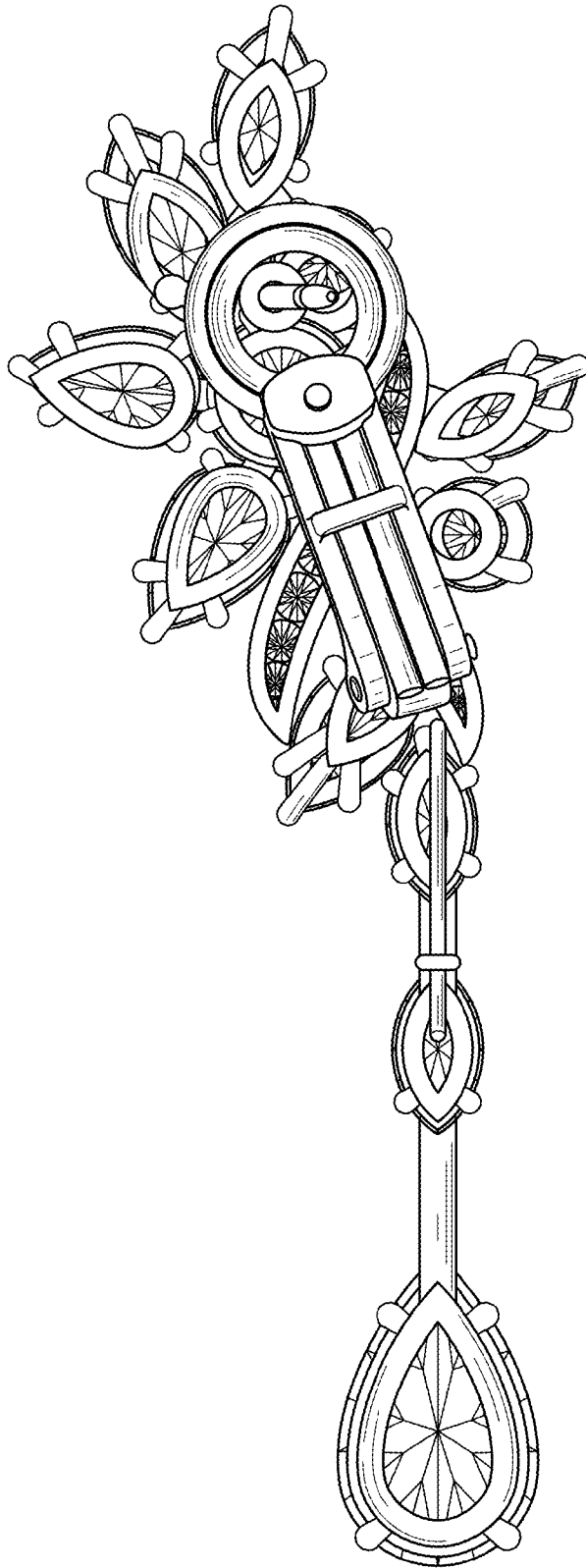

FIG. 3

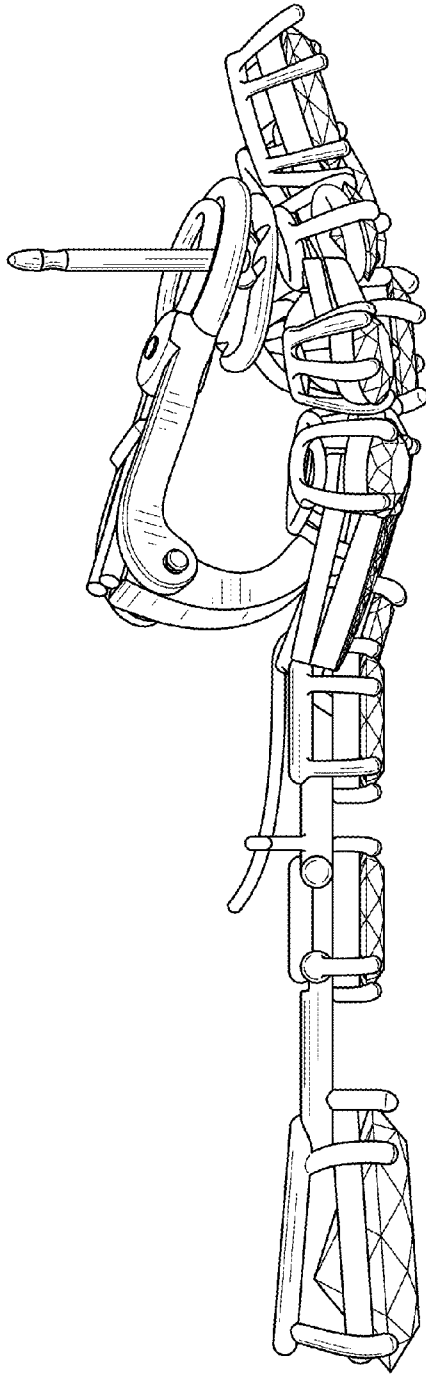

FIG. 4

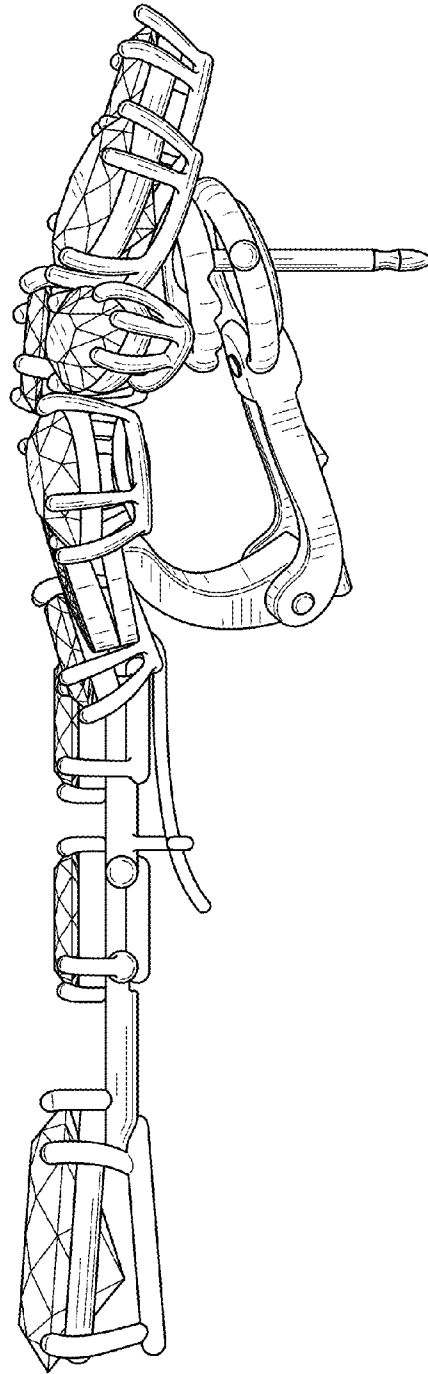

FIG. 5

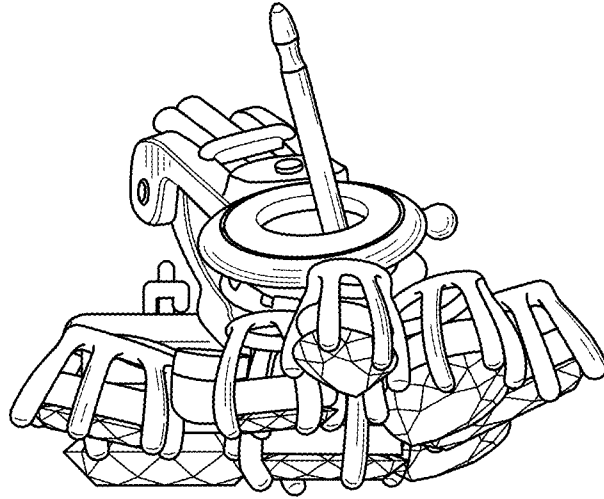

FIG. 6

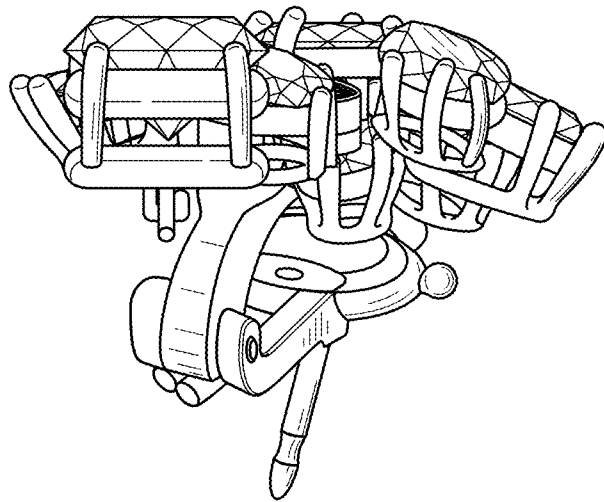

FIG. 7

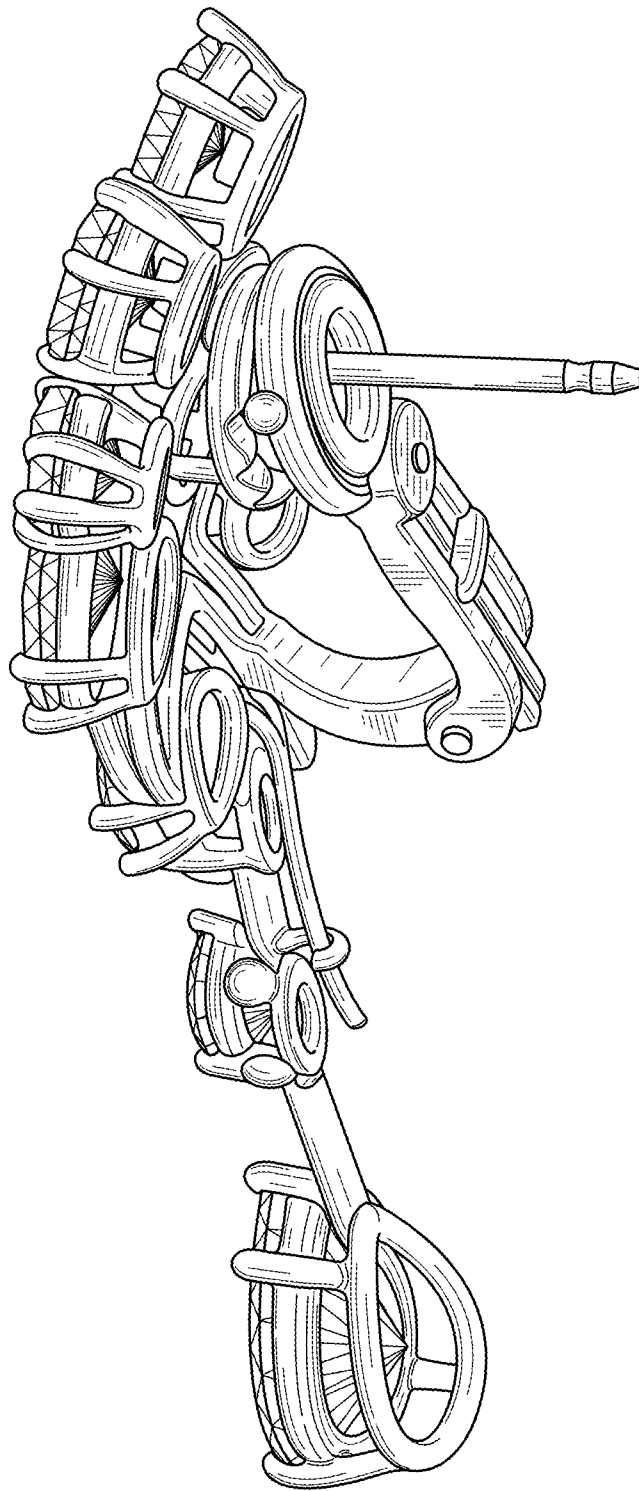

FIG. 8