



US00D770327S

(12) **United States Design Patent**  
**Chan**

(10) **Patent No.:** **US D770,327 S**

(45) **Date of Patent:** **\*\* Nov. 1, 2016**

(54) **BUCKLE**  
(71) Applicant: **Duraflex Hong Kong Limited**, Hong Kong (HK)  
(72) Inventor: **Yick Fai Chan**, Hong Kong (HK)  
(73) Assignee: **DURAFLEX HONG KONG LIMITED**, Hong Kong (HK)

6,796,007 B1 \* 9/2004 Anscher ..... A44B 11/2549  
24/312  
D536,642 S \* 2/2007 Pontaoe ..... D11/216  
7,174,609 B2 \* 2/2007 Park ..... A44B 11/266  
24/614  
7,346,965 B2 \* 3/2008 Hsiao ..... A44B 11/2519  
24/625  
D625,226 S \* 10/2010 Pontaoe ..... D11/216  
D711,773 S \* 8/2014 Kolasa ..... D11/215  
D724,995 S \* 3/2015 Paik ..... D11/216

(\*\*) Term: **15 Years**

\* cited by examiner

(21) Appl. No.: **29/568,364**

*Primary Examiner* — Ralf Seifert

(22) Filed: **Jun. 17, 2016**

(30) **Foreign Application Priority Data**

Dec. 18, 2015 (CN) ..... 2015 3 0541648

(51) **LOC (10) Cl.** ..... **02-07**

(52) **U.S. Cl.**  
USPC ..... **D11/216**

(58) **Field of Classification Search**  
USPC ..... D11/1-2, 200-201, 206-210, 214-218;  
24/163 R, 169-171, 173, 177-179, 191,  
24/194-195, 197, 200, 614-616, 625, 198,  
24/578.11, 578.1, 163 K, 114  
CPC ..... A44B 11/26; A44B 11/25; A44B 11/06;  
A44B 11/2519  
See application file for complete search history.

(56) **References Cited**

U.S. PATENT DOCUMENTS

6,622,355 B2 \* 9/2003 Buscart ..... A44B 11/006  
24/271  
D496,302 S \* 9/2004 Kaneko ..... D11/216

(57) **CLAIM**

The ornamental design for a buckle, as shown and described.

**DESCRIPTION**

FIG. 1 is a front elevational view of a buckle showing my new design;  
FIG. 2 is a rear elevational view thereof;  
FIG. 3 is a left side view thereof;  
FIG. 4 is a right side view thereof;  
FIG. 5 is a bottom plan view thereof;  
FIG. 6 is a top plan view thereof;  
FIG. 7 is a first perspective view thereof;  
FIG. 8 is a second perspective view thereof;  
FIG. 9 is a third perspective view thereof; and,  
FIG. 10 is a fourth perspective view thereof.  
The broken lines are for illustrative purposes only and form no part of the claimed design.

**1 Claim, 10 Drawing Sheets**

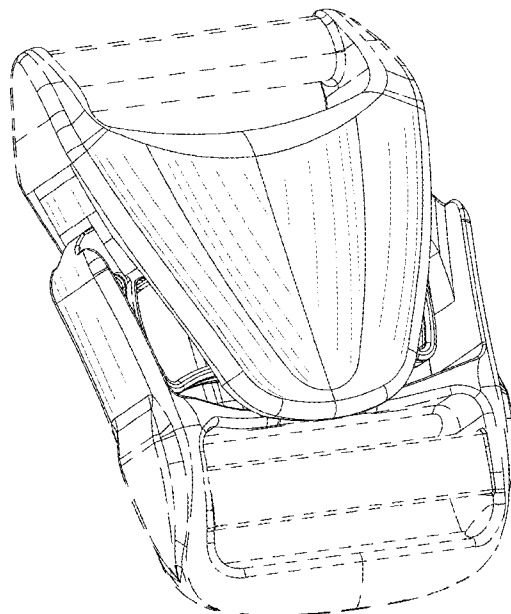

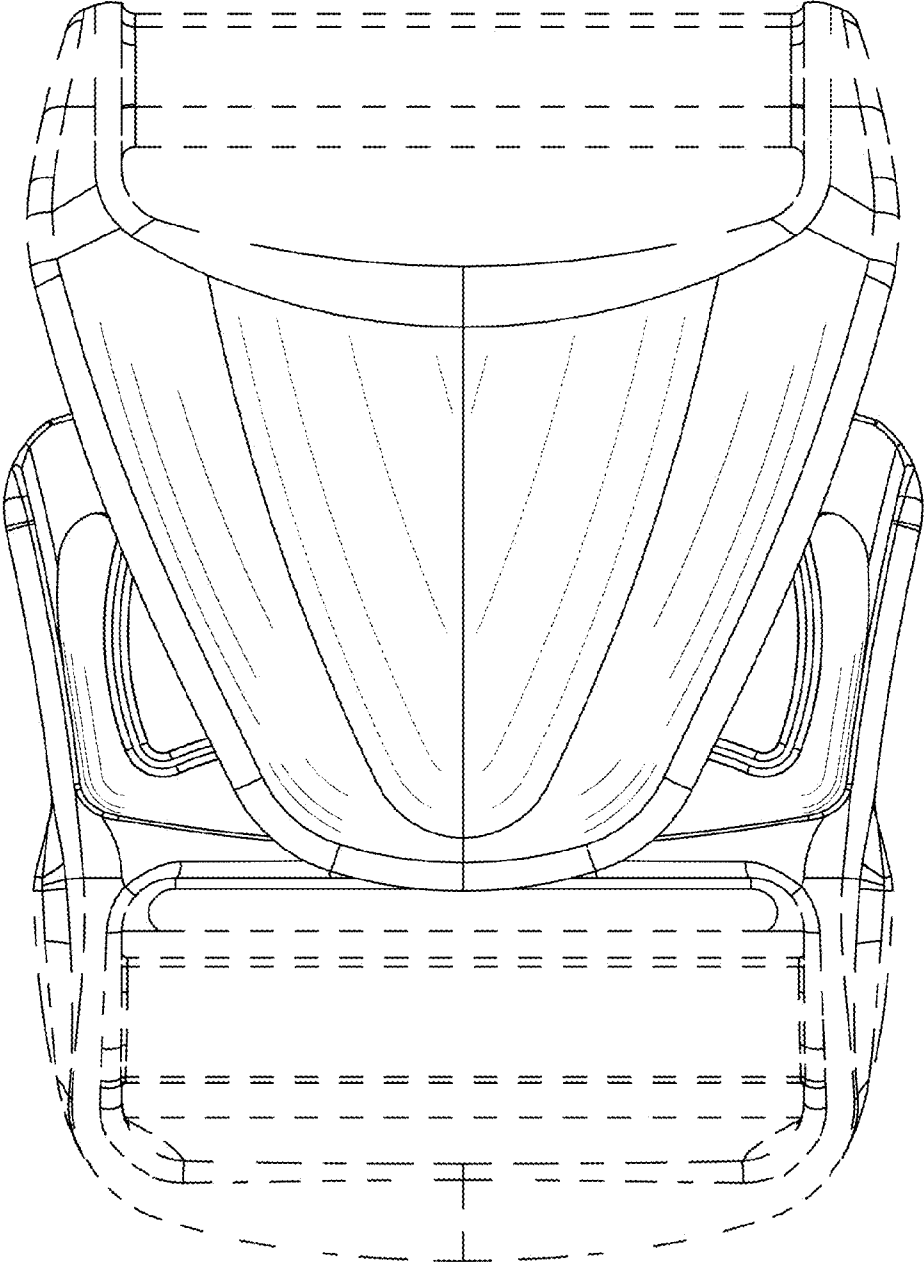

Fig. 1

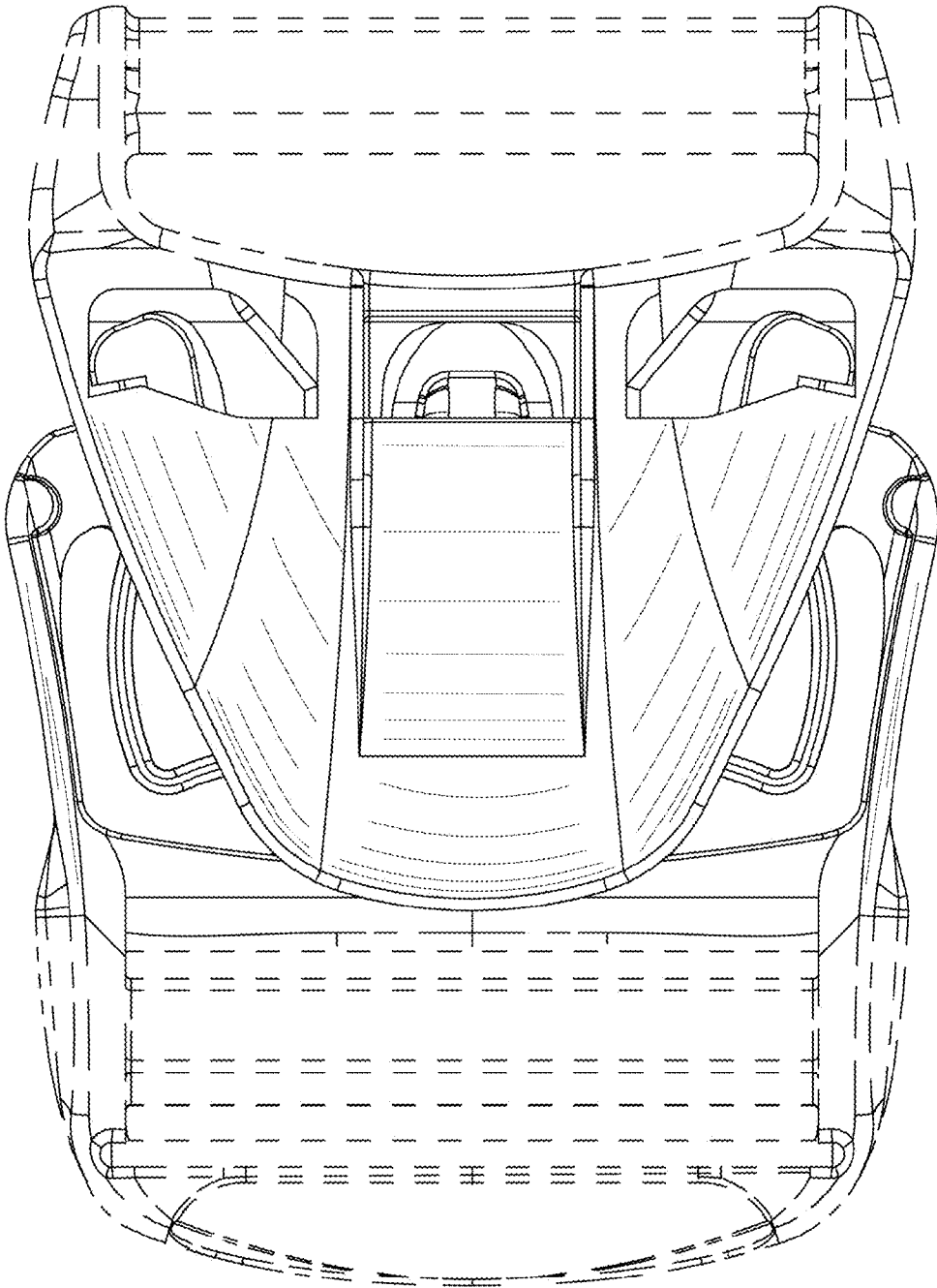

Fig. 2

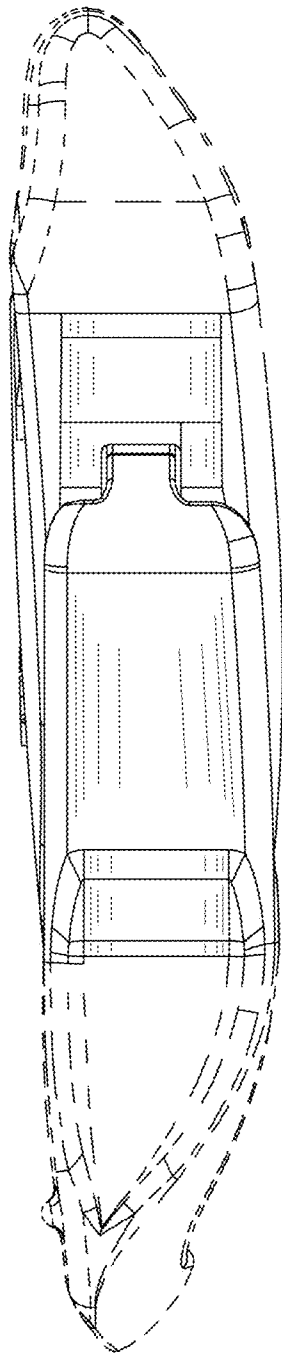

Fig. 3

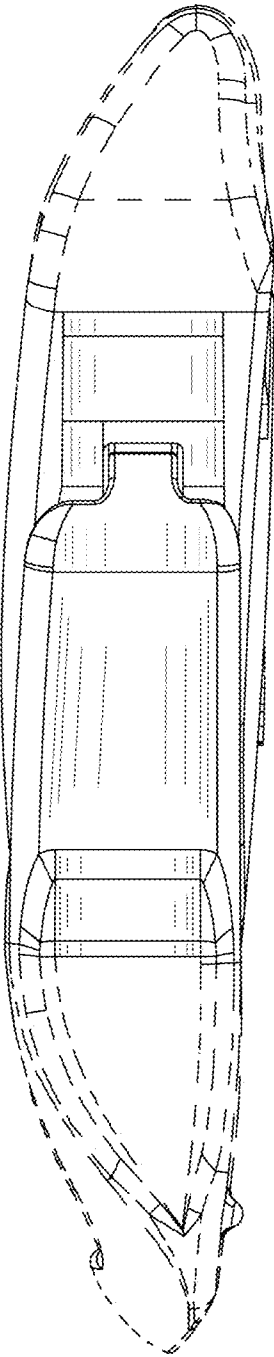

Fig. 4

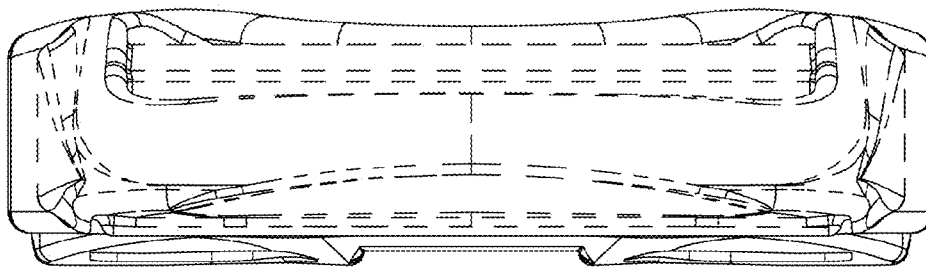

Fig. 5

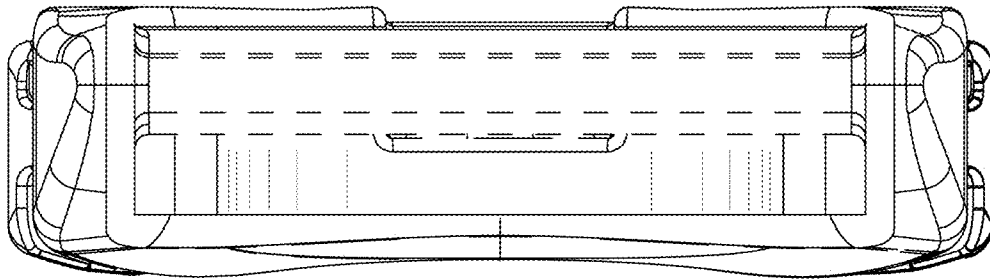

Fig. 6



Fig. 7



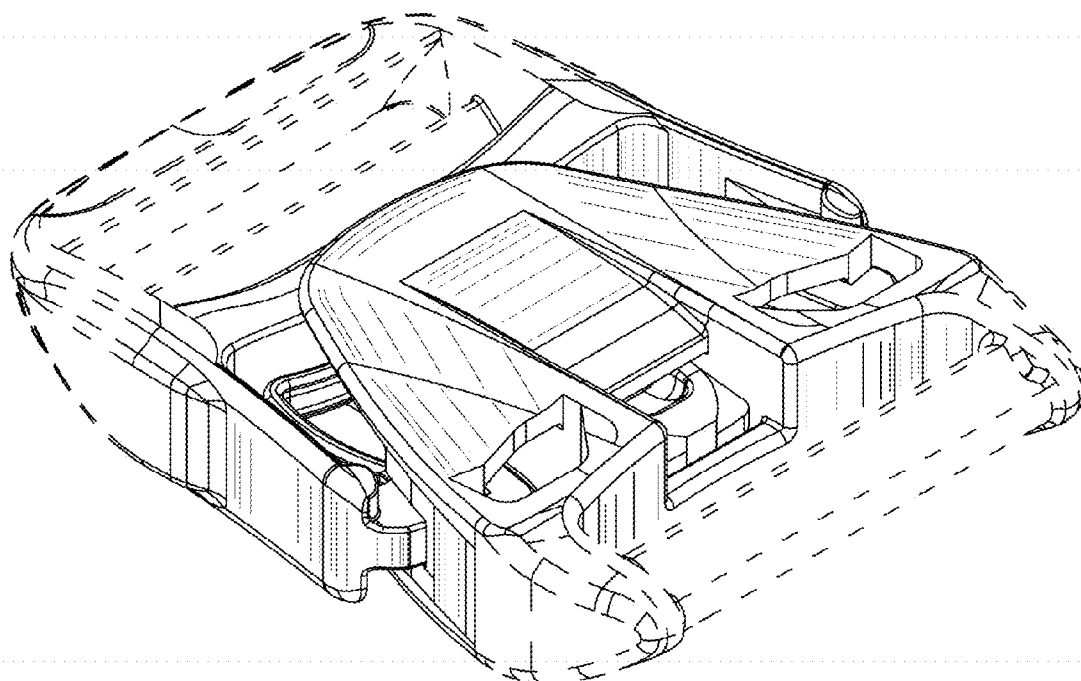

Fig. 8

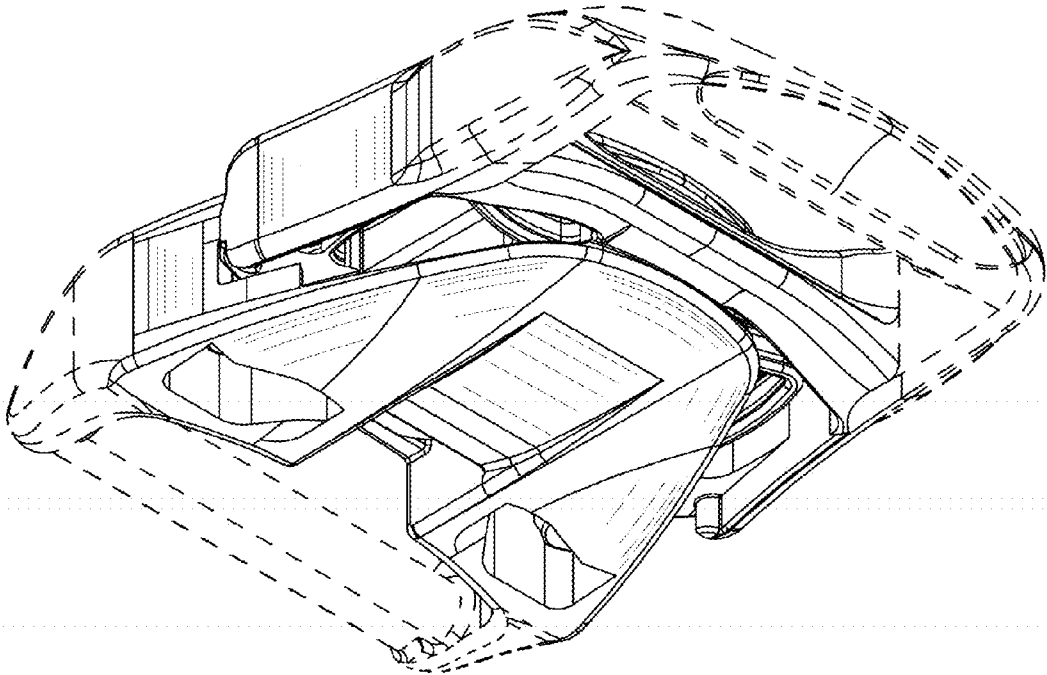

Fig. 9

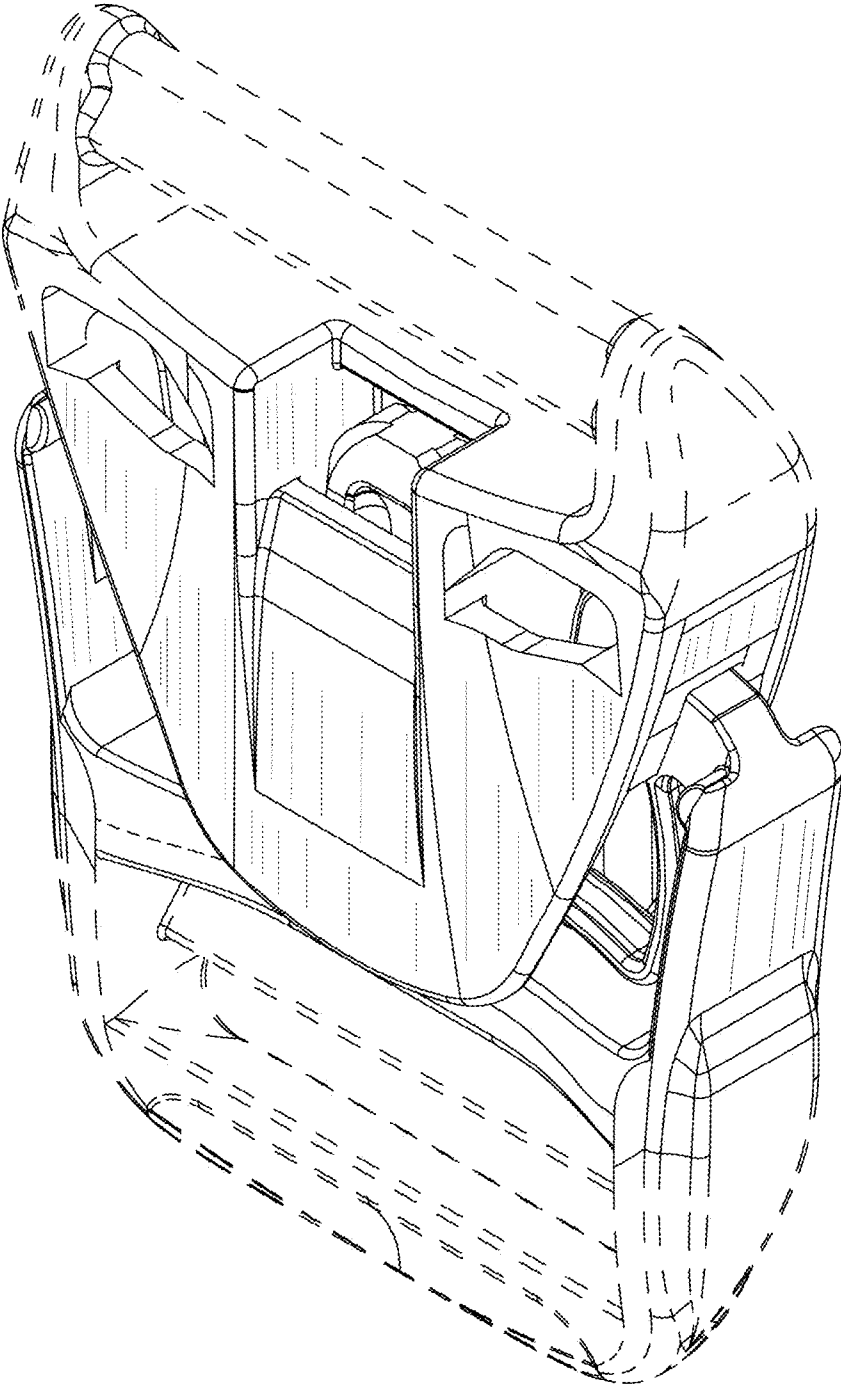

Fig. 10