



US00D526999S

(12) **United States Design Patent**
Tago

(10) **Patent No.:** **US D526,999 S**

(45) **Date of Patent:** **** Aug. 22, 2006**

(54) **PORTION OF AN ELECTRONIC COMPUTER**

(75) Inventor: **Manabu Tago**, Yokohama (JP)

(73) Assignee: **Kabushiki Kaisha Toshiba** (JP)

(**) Term: **14 Years**

(21) Appl. No.: **29/238,337**

(22) Filed: **Sep. 15, 2005**

(30) **Foreign Application Priority Data**

Jul. 13, 2005 (JP) 2005-020452

(51) **LOC (8) Cl.** **14-02**

(52) **U.S. Cl.** **D14/327**

(58) **Field of Classification Search** D14/315-328;
D18/1, 2, 7, 11; 235/145 A, 145 R; 341/22,
341/23; 345/104, 156, 168, 169, 173; 361/680-686;
400/486, 489

See application file for complete search history.

(56) **References Cited**

U.S. PATENT DOCUMENTS

D330,016 S	*	10/1992	Mizusugi et al.	D14/327
D375,294 S		11/1996	Iino	
D388,401 S		12/1997	Tanaka	
D391,237 S		2/1998	Iino	
D393,250 S		4/1998	Kondo	
D395,289 S		6/1998	Iino	
D395,868 S		7/1998	Iino	
D395,869 S		7/1998	Suzuki	
D398,908 S		9/1998	Iino	
D401,572 S		11/1998	Tanaka	

(Continued)

FOREIGN PATENT DOCUMENTS

JP	1066080	4/2000
JP	D1066088	4/2000
JP	D1066382	4/2000
JP	D1069271	5/2000
JP	D1089183	10/2000
JP	1128299	12/2001
JP	D1128299	12/2001

JP	D1128642	12/2001
JP	D1129529	12/2001
JP	1145541	7/2002
JP	D1145577	7/2002

Primary Examiner—Freda S. Nunn

(74) *Attorney, Agent, or Firm*—Banner & Witcoff, Ltd.

(57) **CLAIM**

The ornamental design for a portion of an electronic computer, as shown and described.

DESCRIPTION

FIG. 1 is a reduced top, front and right side perspective view of an electronic computer showing my new design, FIG. 2 is a front elevational view thereof, FIG. 3 is a rear elevational view thereof, FIG. 4 is a left side elevational view thereof, FIG. 5 is a right side elevational view thereof, FIG. 6 is a top plan view thereof, FIG. 7 is a bottom plan view thereof, FIG. 8 is a front elevational view thereof showing the article in a closed position, FIG. 9 is a right side elevational view thereof showing the article in the closed position, FIG. 10 is a top plan view thereof showing the article in the closed position, FIG. 11 is a top plan view thereof showing the article in the closed position with the display being turned 180 degrees, FIG. 12 is a front elevational view thereof showing the article in the closed position with the display being turned 180 degrees, FIG. 13 is a reduced perspective view thereof showing the article with the display being turned to a midway position, FIG. 14 is a perspective view thereof showing the article in the closed position with the display being turned 180 degrees, FIG. 15 is a perspective view thereof showing the article in the closed position; and, FIG. 16 is a front elevational view thereof showing the article in the condition where a power source is on. The broken lines are shown in the views for illustrative purposes only and form no part of the claimed design.

1 Claim, 8 Drawing Sheets

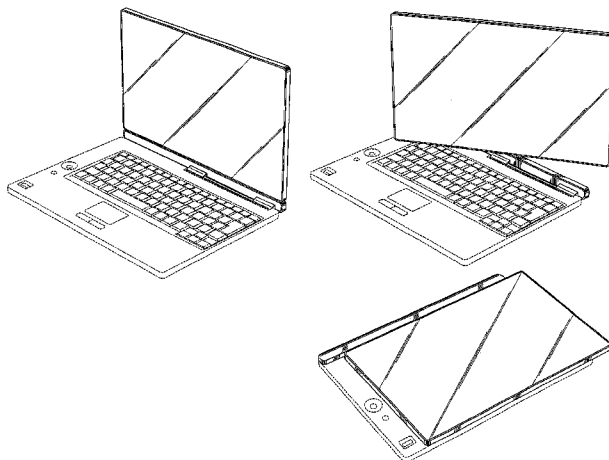

US D526,999 S

Page 2

U.S. PATENT DOCUMENTS

D402,277 S	12/1998	Iino		D481,386 S	10/2003	Kondo	
D411,519 S	6/1999	Tanaka		D485,836 S	1/2004	Tanaka	
D411,832 S	7/1999	Iino		D488,808 S	4/2004	Kamegi	
D415,475 S	10/1999	Sugano		D488,809 S	4/2004	Kamegi	
6,067,224 A	* 5/2000	Nobuchi	361/683	D493,785 S	* 8/2004	Andre et al.	D14/318
D426,817 S	6/2000	Sugano et al.		D494,162 S	8/2004	Kondo	
D442,950 S	5/2001	Sugano et al.		D494,580 S	8/2004	Kondo	
D452,238 S	12/2001	Sugano et al.		D494,581 S	8/2004	Araki	
D453,508 S	2/2002	Shibata		D495,691 S	9/2004	Takada et al.	
D453,756 S	2/2002	Kamegi		D499,726 S	12/2004	Kurokawa	
D464,344 S	* 10/2002	Jobs et al.	D14/318	D499,727 S	12/2004	Kondo	
D476,326 S	* 6/2003	Tanimura	D14/318	D501,006 S	1/2005	Yugaya	
D479,841 S	9/2003	Tago et al.		D502,177 S	2/2005	Takada et al.	

* cited by examiner

FIG. 1

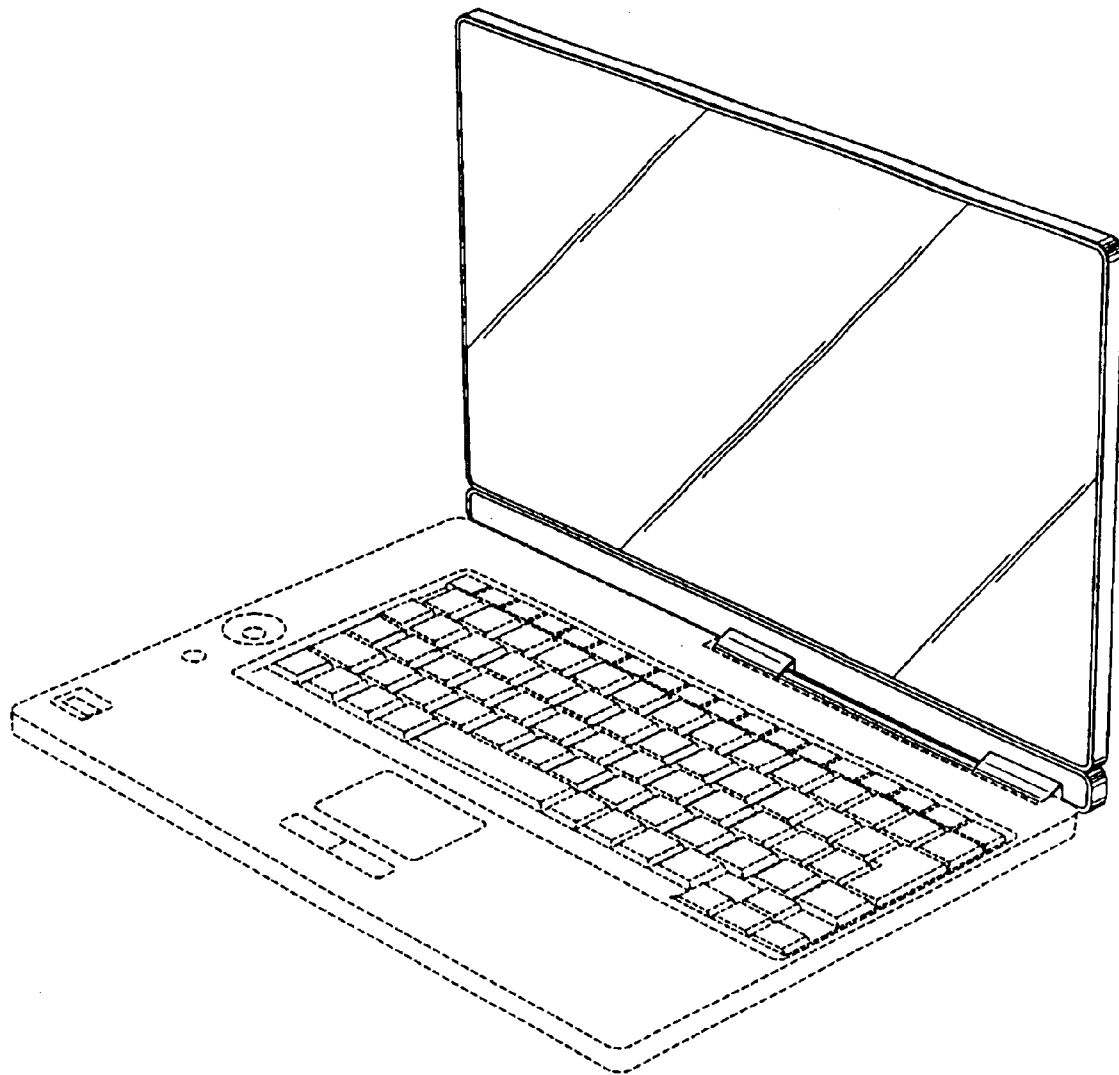

FIG. 2

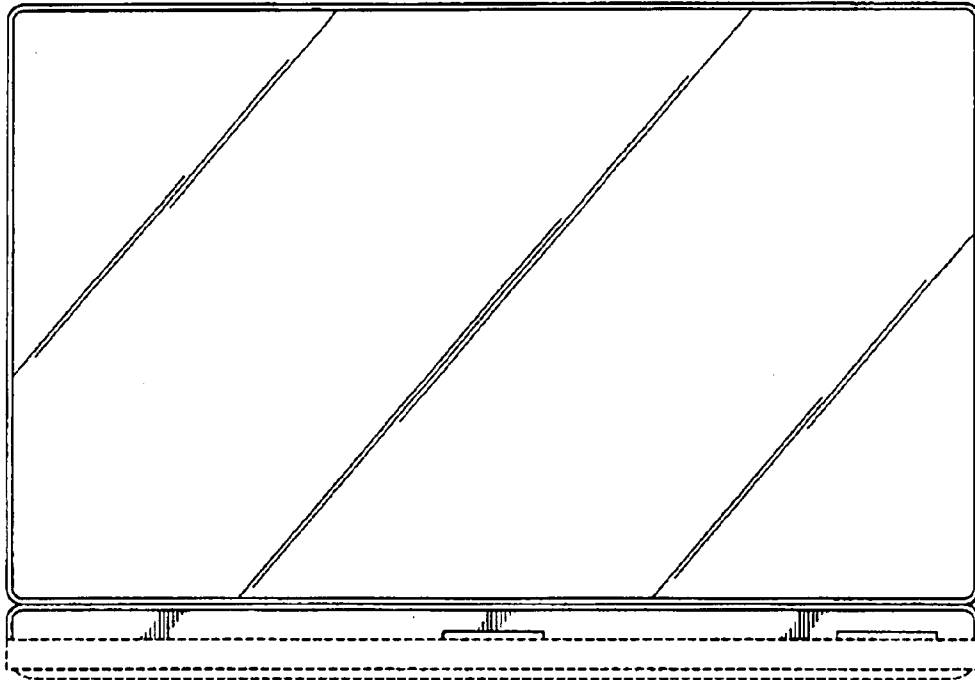

FIG. 3

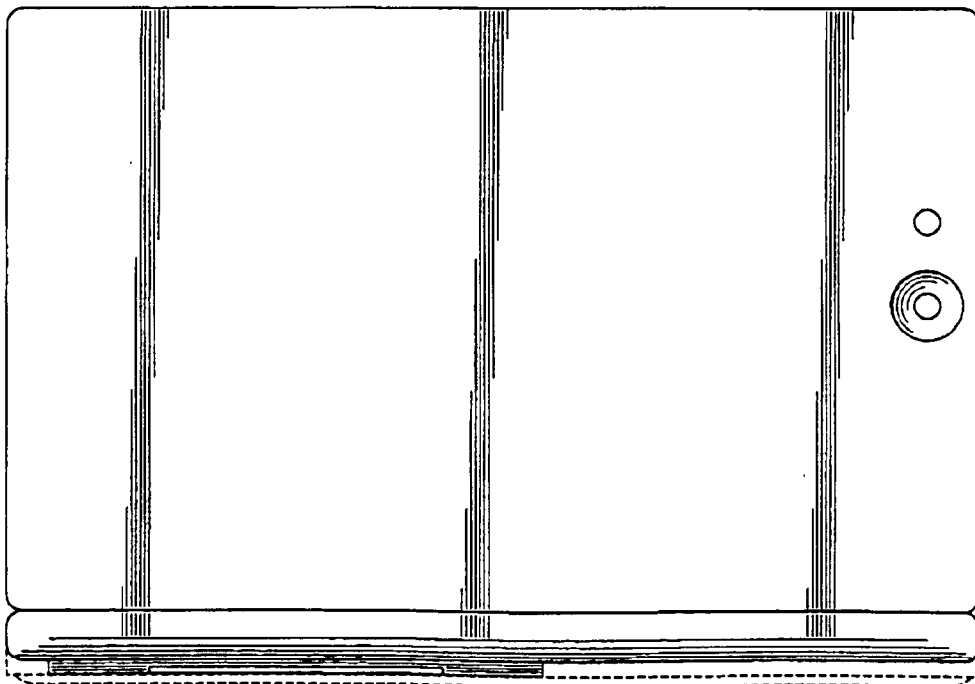

FIG. 4

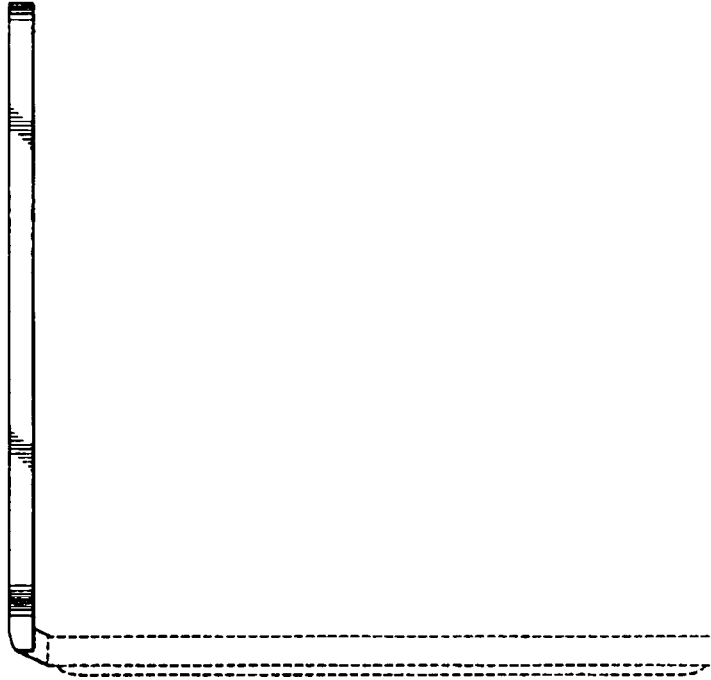

FIG. 5

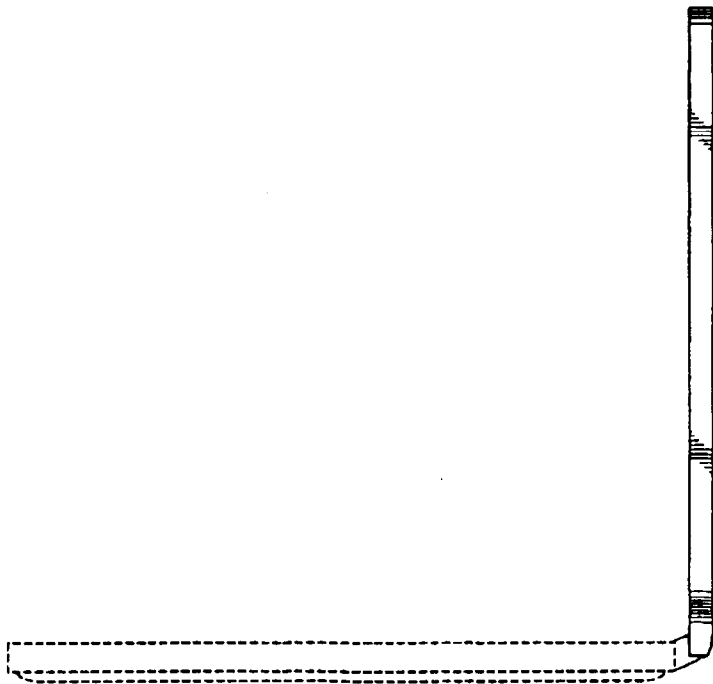

FIG. 6

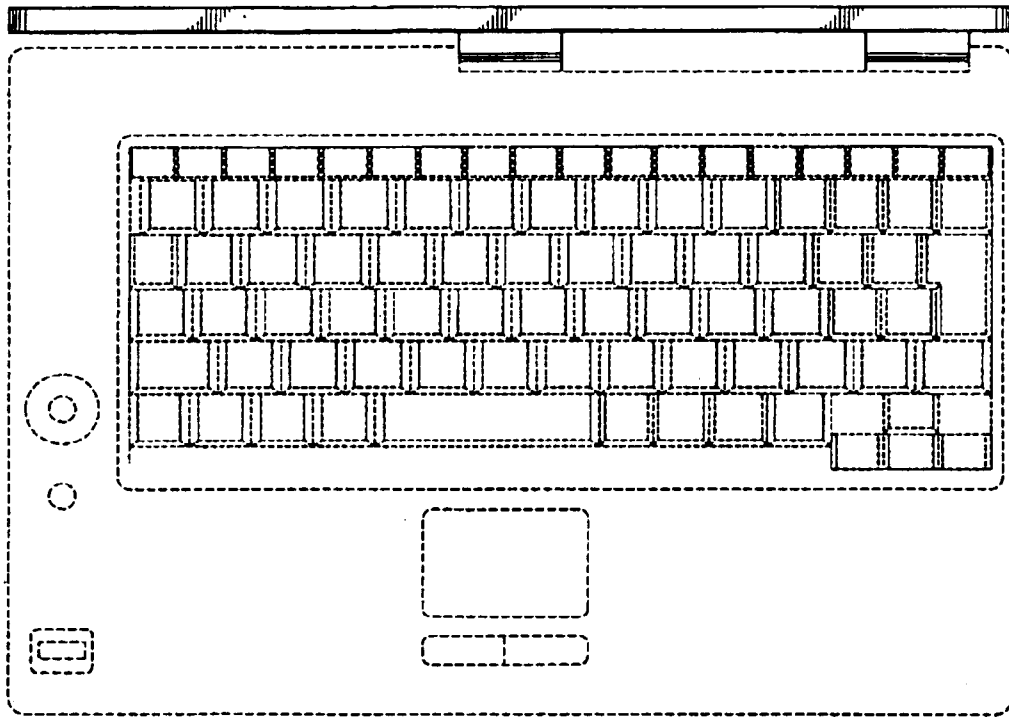

FIG. 7



FIG. 8

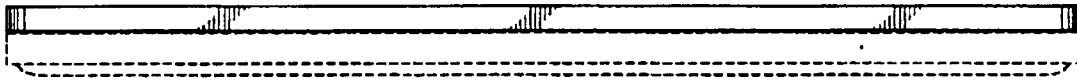

FIG. 9

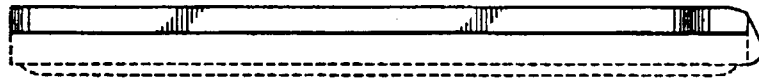

FIG. 10

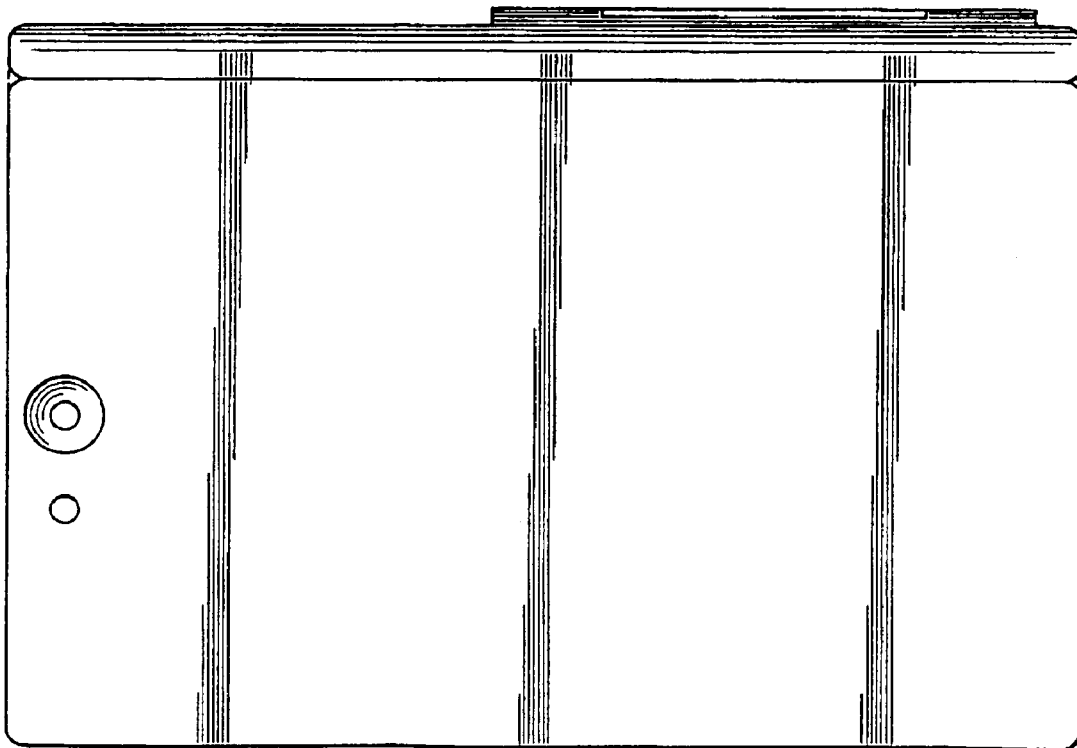

FIG. 11

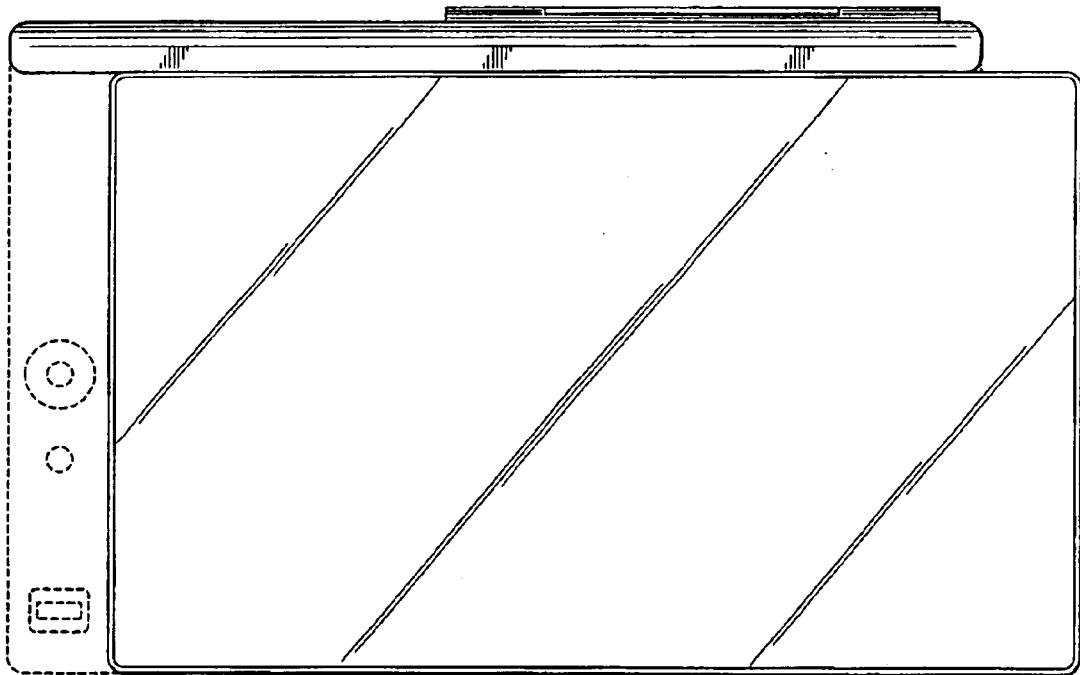

FIG. 12

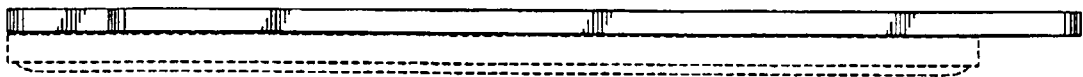

FIG. 13

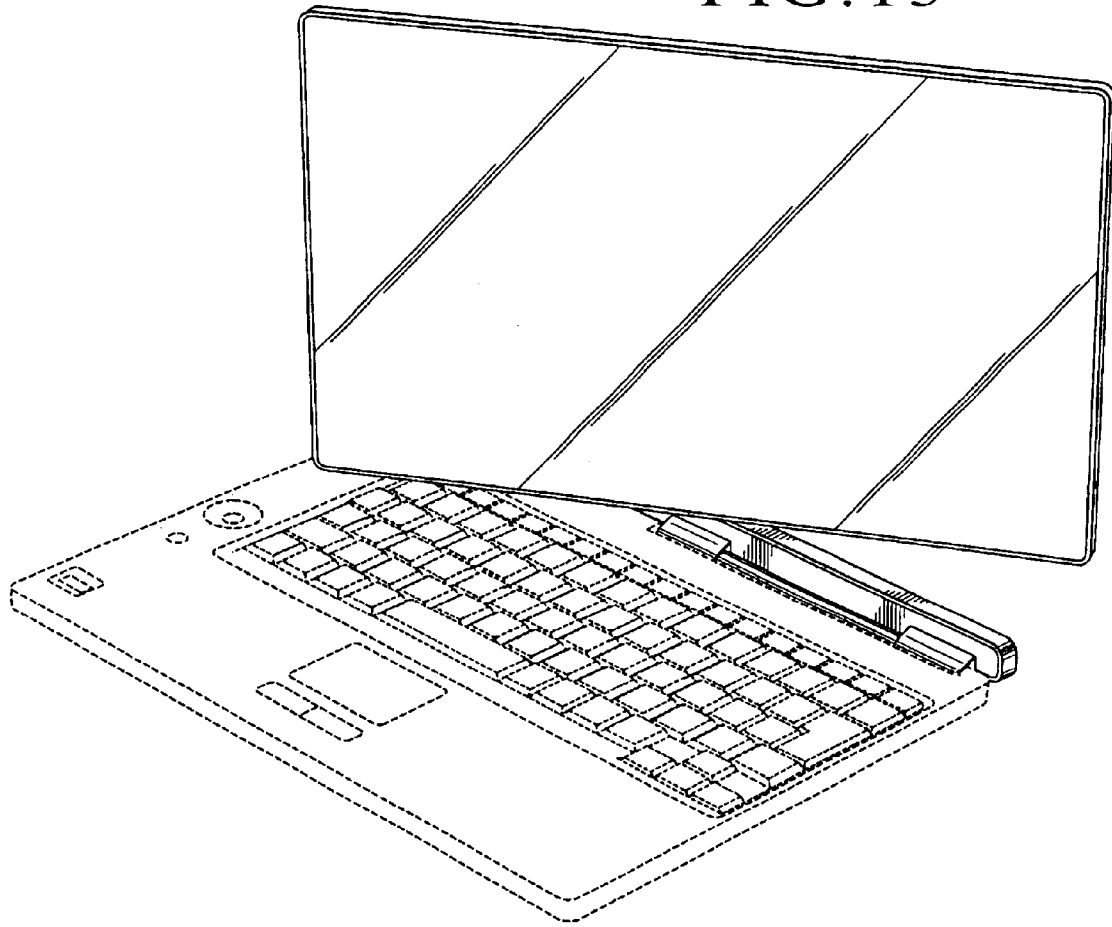

FIG. 14

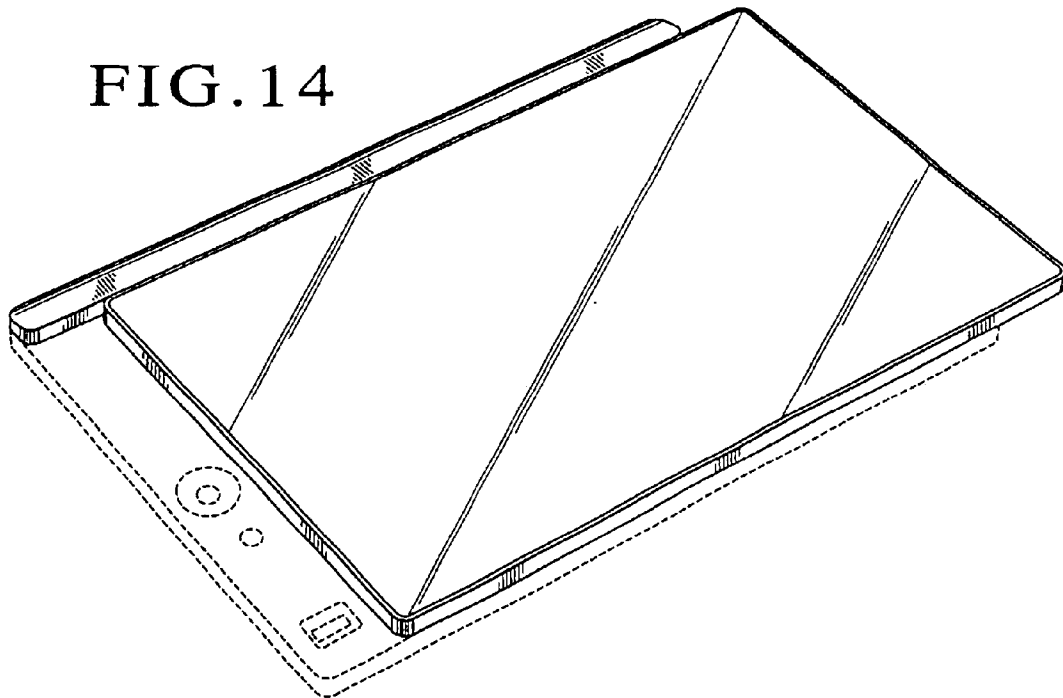

FIG. 15

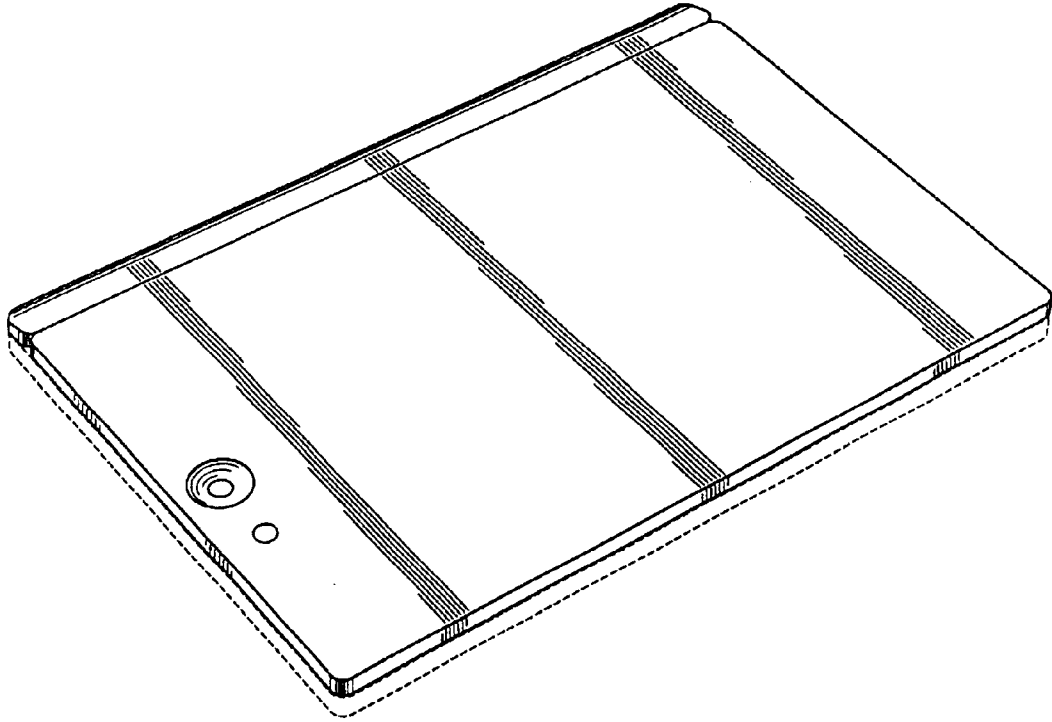

FIG. 16

