



US00D742515S

(12) **United States Design Patent**
Fregoso et al.

(10) **Patent No.:** **US D742,515 S**

(45) **Date of Patent:** **** Nov. 3, 2015**

- (54) **MODIFIED IRRIGATION TIP**
- (71) Applicant: **American Eagle Instruments, Inc.**,
Missoula, MT (US)
- (72) Inventors: **Gilbert Fregoso**, Missoula, MT (US);
Yuval Charles Avniel, Missoula, MT (US)
- (73) Assignee: **American Eagle Instruments, Inc.**,
Missoula, MT (US)
- (**) Term: **14 Years**
- (21) Appl. No.: **29/483,582**
- (22) Filed: **Feb. 28, 2014**
- (51) **LOC (10) Cl.** **24-02**
- (52) **U.S. Cl.**
USPC **D24/152**
- (58) **Field of Classification Search**
USPC D24/152, 155-156, 176, 127, 133, 147,
D24/146; D8/86; D15/132, 138-139;
433/172-174, 3, 50, 53, 82, 114, 141,
433/165-166; 606/80, 96, 98; 408/209, 225
See application file for complete search history.

5,076,788 A *	12/1991	Niznick	433/173
5,195,892 A *	3/1993	Gersberg	433/174
5,261,818 A *	11/1993	Shaw	433/165
5,556,280 A *	9/1996	Pelak	433/172
D532,109 S *	11/2006	Carroll	D24/152
8,113,833 B2 *	2/2012	Courvoisier	433/165

* cited by examiner

Primary Examiner — Wan Laymon

(74) *Attorney, Agent, or Firm* — Heslin Rothenberg Farley & Mesiti, P.C.

(57) **CLAIM**

The ornamental design for a modified irrigation tip, as shown and described.

DESCRIPTION

FIG. 1 is a front perspective view of the modified irrigation tip comprising the new design;
 FIG. 2 is a right elevational view of the design of FIG. 1, where the left elevational view, is a mirror image;
 FIG. 3 is a top view of the design of FIG. 1;
 FIG. 4 is a bottom view of the design of FIG. 1;
 FIG. 5 is a front elevational view of the design of FIG. 1;
 FIG. 6 is a back elevational view of the design of FIG. 1; and,
 FIG. 7 is another perspective view of the modified irrigation tip design of FIG. 1.

The broken away symbols in the drawings indicate that any portion of the article beyond what is shown forms no part of the claimed design.

(56) **References Cited**

U.S. PATENT DOCUMENTS

3,322,124 A *	5/1967	Ireland	433/141
5,037,300 A *	8/1991	Weissman	433/166

1 Claim, 3 Drawing Sheets

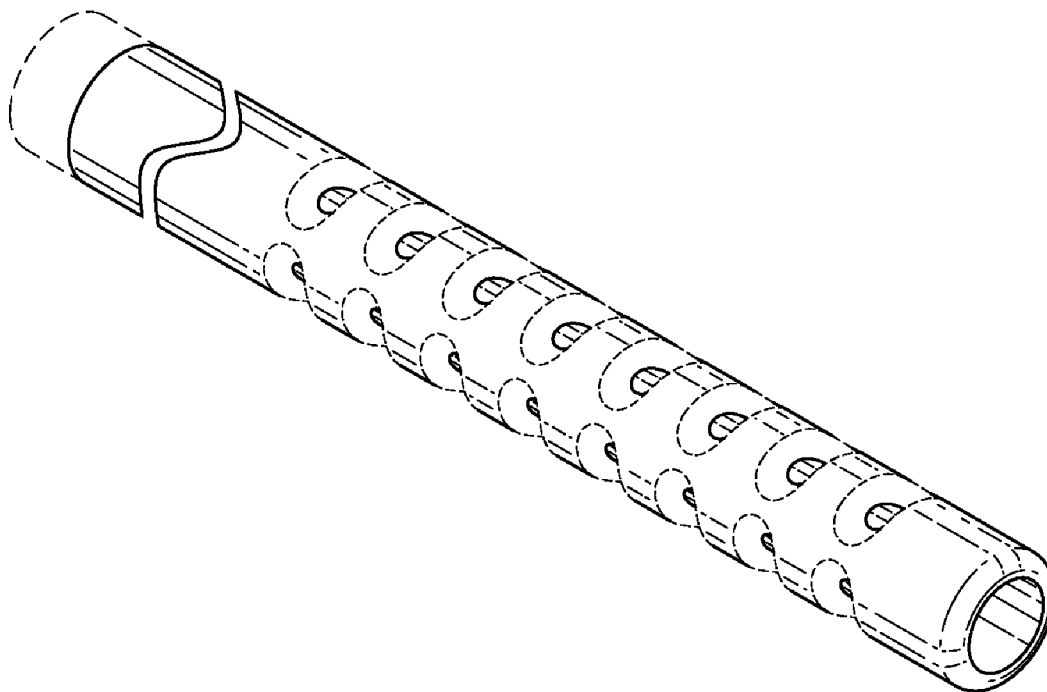

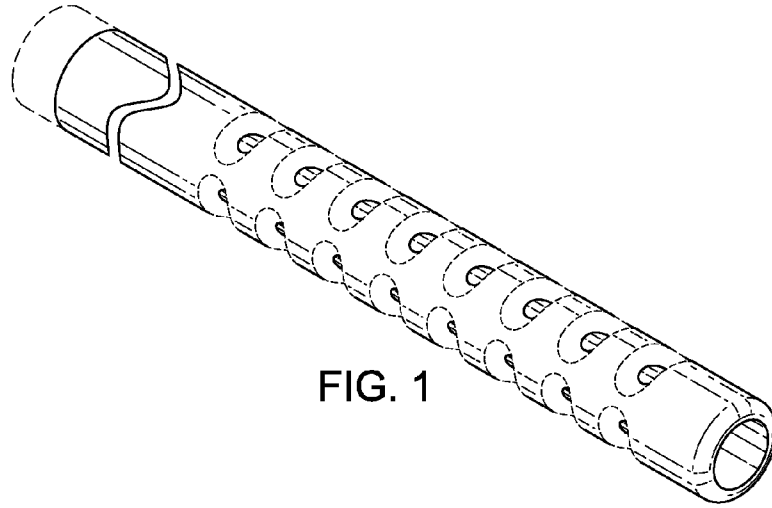

FIG. 1



FIG. 2

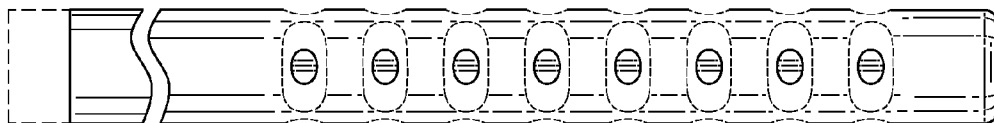

FIG. 3

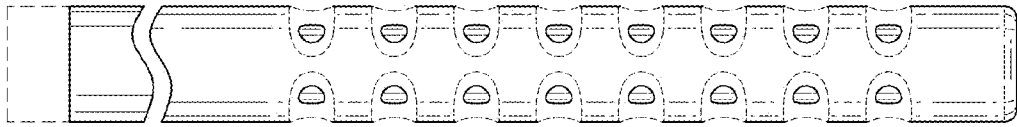

FIG. 4

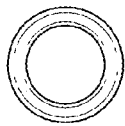

FIG. 5

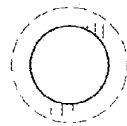

FIG. 6

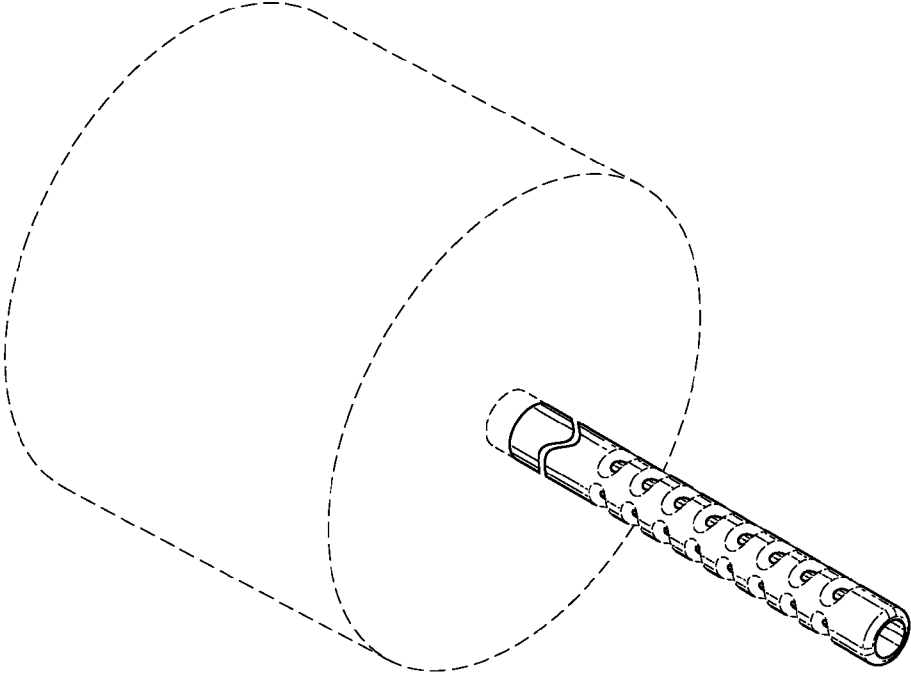

FIG. 7