



US00D815082S

(12) **United States Design Patent**  
**Kim**

(10) **Patent No.:** **US D815,082 S**

(45) **Date of Patent:** **\*\* \*Apr. 10, 2018**

(54) **CASE FOR ELECTRONIC DEVICES**

FOREIGN PATENT DOCUMENTS

(71) Applicant: **Dae-Young Kim**, Seoul (KR)

KR 10-2012-0094878 8/2012

(72) Inventor: **Dae-Young Kim**, Seoul (KR)

OTHER PUBLICATIONS

(73) Assignee: **SPIGEN KOREA CO., LTD.**,  
Geumcheon-Gu, Seoul (KR)

Spigen Ultra Hybrid S iPhone 7 Case, posted at amazon.com, earliest date reviewed Aug. 30, 2016, [online], acquired on Aug. 1, 2017. Available from Internet, <URL: [https://www.amazon.com/Spigen-Cushion-Technology-Magnetic-Kickstand/dp/B01J9DVBWE/ref=cm\\_cr\\_arp\\_d\\_product\\_top?ie=UTF8](https://www.amazon.com/Spigen-Cushion-Technology-Magnetic-Kickstand/dp/B01J9DVBWE/ref=cm_cr_arp_d_product_top?ie=UTF8)>.\*

(\* ) Notice: This patent is subject to a terminal disclaimer.

(\*\*) Term: **15 Years**

(Continued)

(21) Appl. No.: **29/576,727**

*Primary Examiner* — Cathron Brooks

(22) Filed: **Sep. 6, 2016**

*Assistant Examiner* — Aula Soroush

(51) **LOC (11) Cl.** ..... **14-01**

(74) *Attorney, Agent, or Firm* — Heedong Chae; Lucem, PC

(52) **U.S. Cl.**

USPC ..... **D14/250**

(58) **Field of Classification Search**

USPC ..... D14/238.1, 440, 203.3–203.7, 217, 240,  
D14/447, 248, 251–253, 250; D13/103,  
D13/107–108, 119; D3/201, 218, 247,  
D3/269, 273, 301, 303

(57) **CLAIM**

The ornamental design for a case for electronic devices, as shown and described.

CPC ..... H04B 1/3888; H04M 1/0283; H04M  
1/0202; A45C 1/06; A45C 2011/002;  
A45C 11/00; A45C 13/02; A45F  
2005/026; A45F 2200/0525; A45F  
2200/0516

**DESCRIPTION**

See application file for complete search history.

FIG. 1 is a front perspective view of a case for electronic devices, having a support leg wherein the support leg is in a closed position, showing my new design; FIG. 2 is a rear perspective view thereof; FIG. 3 is a front elevational view thereof; FIG. 4 is a rear elevational view thereof; FIG. 5 is a left side elevational view thereof; FIG. 6 is a right side elevational view thereof; FIG. 7 is a top plan view thereof; FIG. 8 is a bottom plan view thereof; and, FIG. 9 is a rear perspective view of the case with the support leg in an open position. The broken lines in the drawings illustrate portions of the case for electronic devices and form no part of the claimed design.

(56) **References Cited**

U.S. PATENT DOCUMENTS

7,301,759	B2	11/2007	Hslung	
D559,230	S	1/2008	Griffin	
D583,572	S	12/2008	Zhai	
D590,386	S	4/2009	Leith	
D619,361	S *	7/2010	Andre	..... D3/269
D663,263	S	7/2012	Gupta	
D663,294	S	7/2012	Buxton	
8,243,428	B2	8/2012	Fu	
D670,281	S	11/2012	Corpuz et al.	
D671,930	S	12/2012	Akana et al.	
D676,837	S	2/2013	Rothbaum et al.	
D679,271	S *	4/2013	Liu	..... D13/103

(Continued)

**1 Claim, 9 Drawing Sheets**

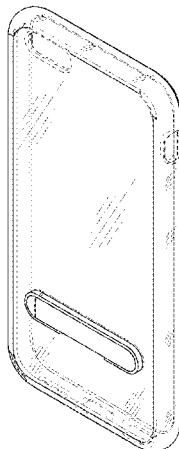

(56) **References Cited**

U.S. PATENT DOCUMENTS

D690,305 S	9/2013	Wen	
D706,254 S *	6/2014	Chang .....	D14/217
D712,892 S	9/2014	Hong et al.	
D714,276 S	9/2014	Hu et al.	
D718,291 S	11/2014	Hong	
D721,360 S	1/2015	Laffon de Mazieres et al.	
D732,543 S	6/2015	Westrup et al.	
D746,275 S	12/2015	Mohammad	
D757,702 S	5/2016	Kanazawa	
D757,703 S	5/2016	Kanazawa	
D761,774 S	7/2016	Liang	
D763,841 S *	8/2016	Kim .....	D14/250
D765,634 S	9/2016	McCray et al.	
D772,210 S	11/2016	Igarashi	
D772,854 S	11/2016	Igarashi	
D775,619 S	1/2017	Tien	
D776,104 S *	1/2017	Tien .....	D14/250
D777,715 S	1/2017	Sawaya	
D780,167 S *	2/2017	Tien .....	D14/250
D781,839 S	3/2017	Kim et al.	
D788,090 S *	5/2017	Kim .....	D14/250
2011/0164358 A1	7/2011	Duan	
2013/0077211 A1	3/2013	Wang	
2016/0101902 A1*	4/2016	Kim .....	F16M 11/00 206/45.23

OTHER PUBLICATIONS

Droid X Car Dock,<http://phandroid.com/2010/06/23/droidxcardockaccessoriesrevealed/>, Downloaded Oct. 19, 2016, 4 Pages.

Body Glove Snap-On Case for the HTC Thunderbolt Review,<http://www.androidcentral.com/bodyglovesnapcasehtcthunderboltreview>, Downloaded Oct. 19, 2016, 10 Pages.

Case for HTC Thunderbolt with Extended Battery: Review of Seidio Active Extended Case,<http://webpierat.com/2011/06/16/casecthunderboltextendedbattery/>, Downloaded Oct. 19, 2016, 5 Pages.

EVO3D Case with Kickstand,<http://forums.androidcentral.com/htcevo3d/71171evo3dcasekickstand.html>, Downloaded Oct. 19, 2016, 8 Pages.

HTC Desire HD Hard Case with Kickstand,<http://www.mobilefun.co.ukhtcdesirehdhardcasewithkickstandhck550p27766.htm>, Downloaded Oct. 19, 2016, 3 Pages.

HTC EVO 3D Seidio Surface with Kickstand Case Review,<http://htcpedia.comHTCEvo3DcasereviewSeidioSURFACEwithKickstand/reviews/htcevo3daccessories.html>, Downloaded Oct. 19, 2016, 11 Pages.

HTC EVO 4G Case Review: HTC Hard Shell Case,<http://www.androidcentral.com/htcevo4gcasereviewhtchardshellcase>, Downloaded Oct. 19, 2016, 13 Pages.

HTC EVO 4G Case Review: Otterbox Defender,<http://www.androidcentral.com/htcevo4gcasereviewotterboxdefender>, Downloaded Oct. 19, 2016, 16 Pages.

HTC EVO 4G Case Review: Trident cyclops Series,<http://www.androidcentral.com/htcevo4gcasereviewtridentcycloppsseries>, Downloaded Oct. 19, 2016, 5 Pages.

HTC HD2 Extended Battery,<http://www.itechnews.net/2010/01/28/htchd2extendedbattery/>, Downloaded May 3, 2016, 2 Pages.

iPod Touch 4 Case With Kickstand,<http://www.avenueapple.com/ipodtouch4casewithkickstand/>, Downloaded Oct. 19, 2016, 6 Pages.

iPod Touch 4G Case With Chrome Kickstand,<http://www.avenueapple.com/ipodtouch4gcasewithchromekickstand/>, Downloaded Oct. 19, 2016, 5 Pages.

LG CCH-120 Kick Stand Hard Case—LG Optimus 2X,<http://www.mobilefun.co.uk/gcch120kickstandhardcaselgoptimus2xp27952.htm>, Downloaded Oct. 19, 2016, 3 Pages.

Mugen Power5400MAH Extended XL Battery Back Door Samsung Galaxy Note White ATT4,<http://www.ebay.com/itm/MUGENPOWER5400mAhEXTENDEDXLBATTERYBACKDOORSAMSUNGALAXYNOTEWHITEATT/270963466305/>, Downloaded May 3, 2016, 3 Pages.

Mybat Natural Gray/Black Tuff Hybrid Phone Protector Cover (with Stand),<https://www.2valor.com/product/productinfo.aspx?pid=73296>, Downloaded Oct. 14, 2016, 2 Pages.

NXE Recline Case for iPhone 4,<http://thegadgeteer.com/2011/03/14/nxereclinecaseforiphone4/>, Downloaded Oct. 19, 2016, 6 Pages.

NXE Recline iPhone 4 Case with Practical Stand,<http://gadgets.in.com/nxereclineiphone4casewithpracticalstand.htm>, Downloaded Oct. 19, 2016, 5 Pages.

OtterBox Defender Case for HTC Thunderbolt Smartphone Review,[http://www.legitreviews.com/otterboxdefendercaseforhththunderboltsmartphonereview\\_1648/4](http://www.legitreviews.com/otterboxdefendercaseforhththunderboltsmartphonereview_1648/4), Downloaded Oct. 19, 2016, 5 Pages.

Quick Look: HTC Kickstand Case for HTC Inspire 4G& HTC Desire HD,<http://htcpedia.com/news/htcdesirehdinspire4gkickstandcase.html>, Downloaded Oct. 19, 2016, 3 Pages.

Seidio Active Case(with metal kickstand) for HTC One X,<https://www.youtube.com/watch?v=W5EGPgGw7Hw>, Downloaded Oct. 14, 2016, 3 Pages.

Seidio Surface Case with Kickstand for HTC EVO 3D-1 Pack-Case-Retail Packaging-Black,<https://www.amazon.com/SeidioSURFACECaseKickstandHTC/dp/B005EEO4OA>, Downloaded Oct. 19, 2016, 6 Pages.

Trident Case Kracken,<http://www.tekgoblin.com/2011/09/04/tridentcasekrakenireviewforiphone4/>, Downloaded Oct. 19, 2016, 5 Pages.

iPhone 6S Case,[https://www.amazon.com/iPhoneShieldKickstandCrystalProtection/dp/B014QDKKMY/ref=sr\\_1\\_2?ie=UTF8&qid=1473199610&sr=82&keywords=obliq+iph...](https://www.amazon.com/iPhoneShieldKickstandCrystalProtection/dp/B014QDKKMY/ref=sr_1_2?ie=UTF8&qid=1473199610&sr=82&keywords=obliq+iph...), Downloaded Sep. 7, 2016, 9 Pages.

iPhone 6S Plus Case, [https://www.amazon.com/iPhone-Shield-Kickstand-Crystal-Protection/dp/B014QDKKMY/ref=sr\\_1\\_2?ie=UTF8&qid=1473199610&sr=82&keywords=obliq+iphone+6+case+kickstand](https://www.amazon.com/iPhone-Shield-Kickstand-Crystal-Protection/dp/B014QDKKMY/ref=sr_1_2?ie=UTF8&qid=1473199610&sr=82&keywords=obliq+iphone+6+case+kickstand), Downloaded Sep. 7, 2016, 9Page.

\* cited by examiner

FIG. 1

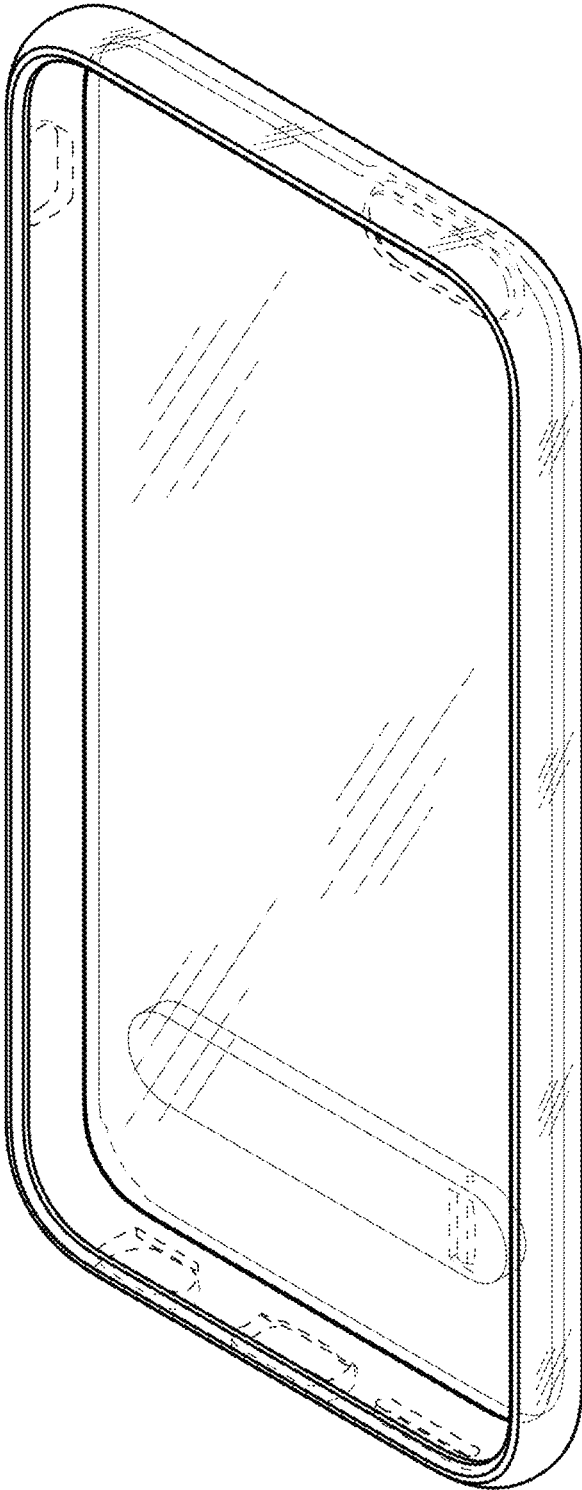

FIG. 2

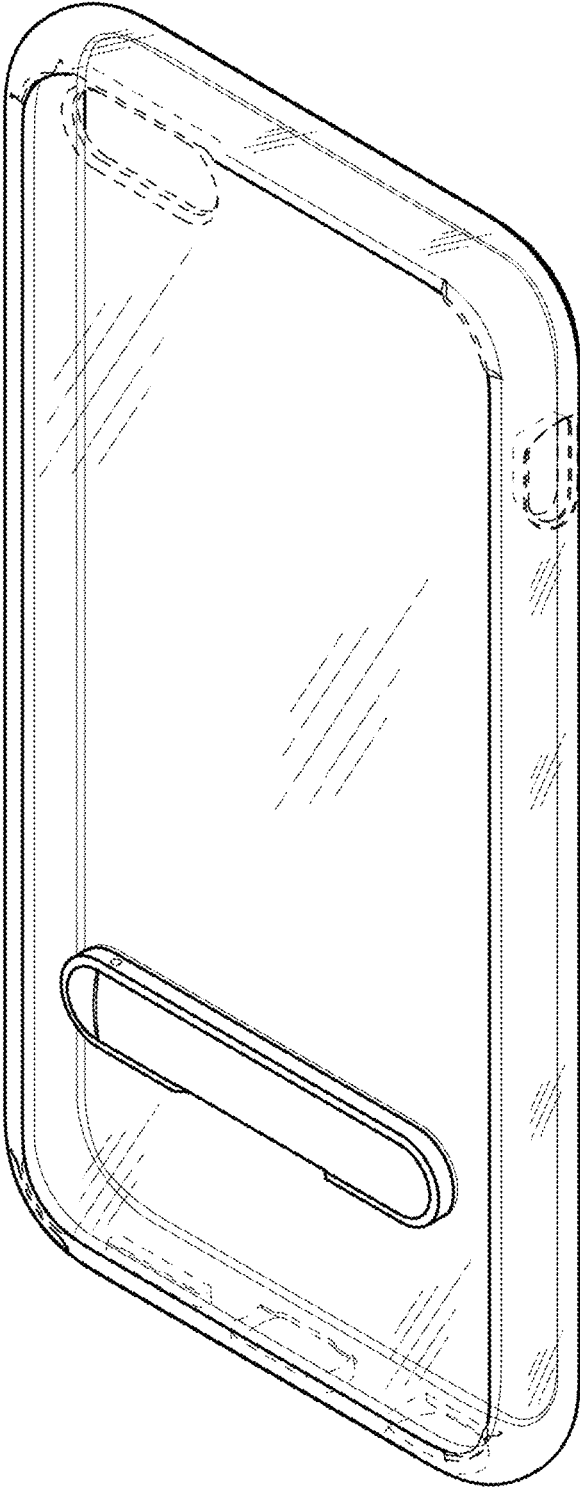

FIG. 3

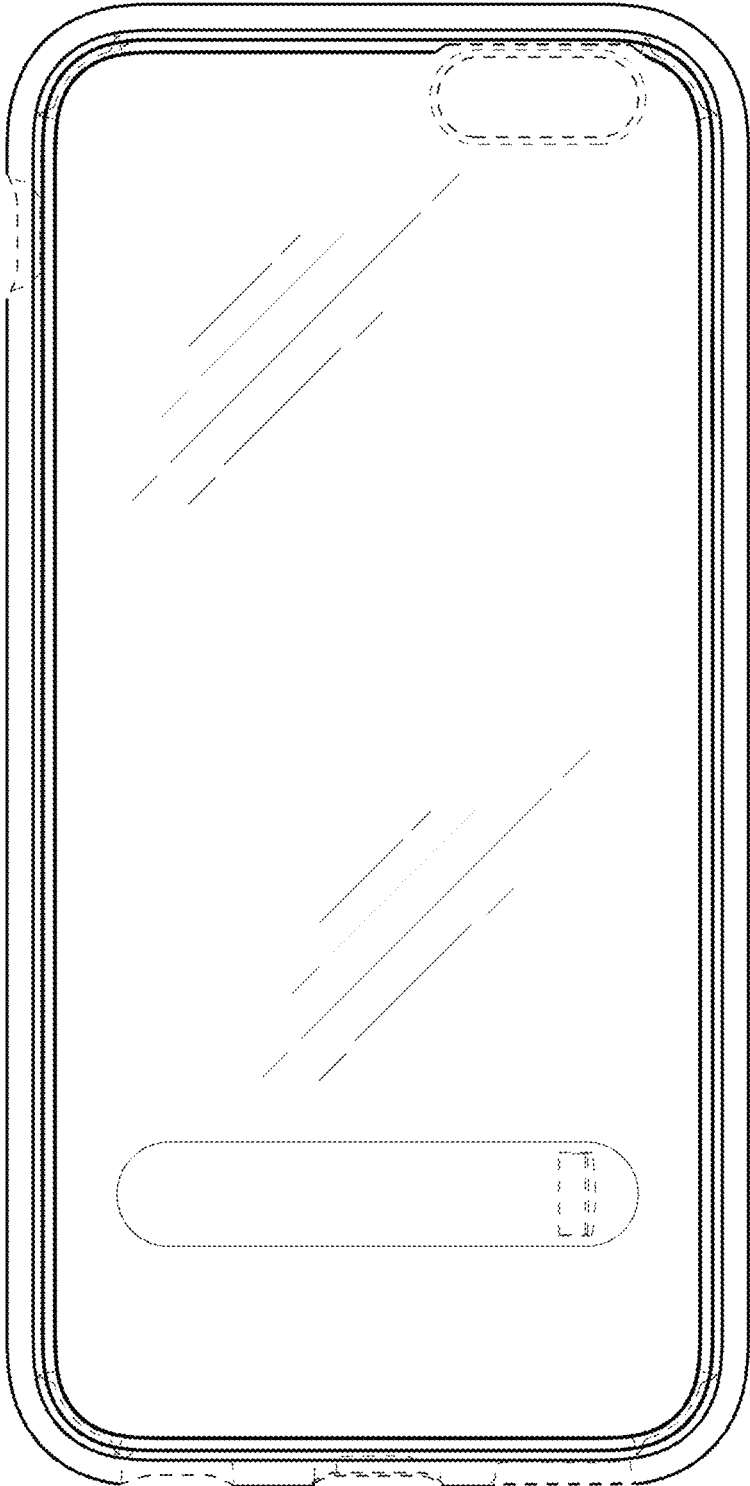

FIG. 4

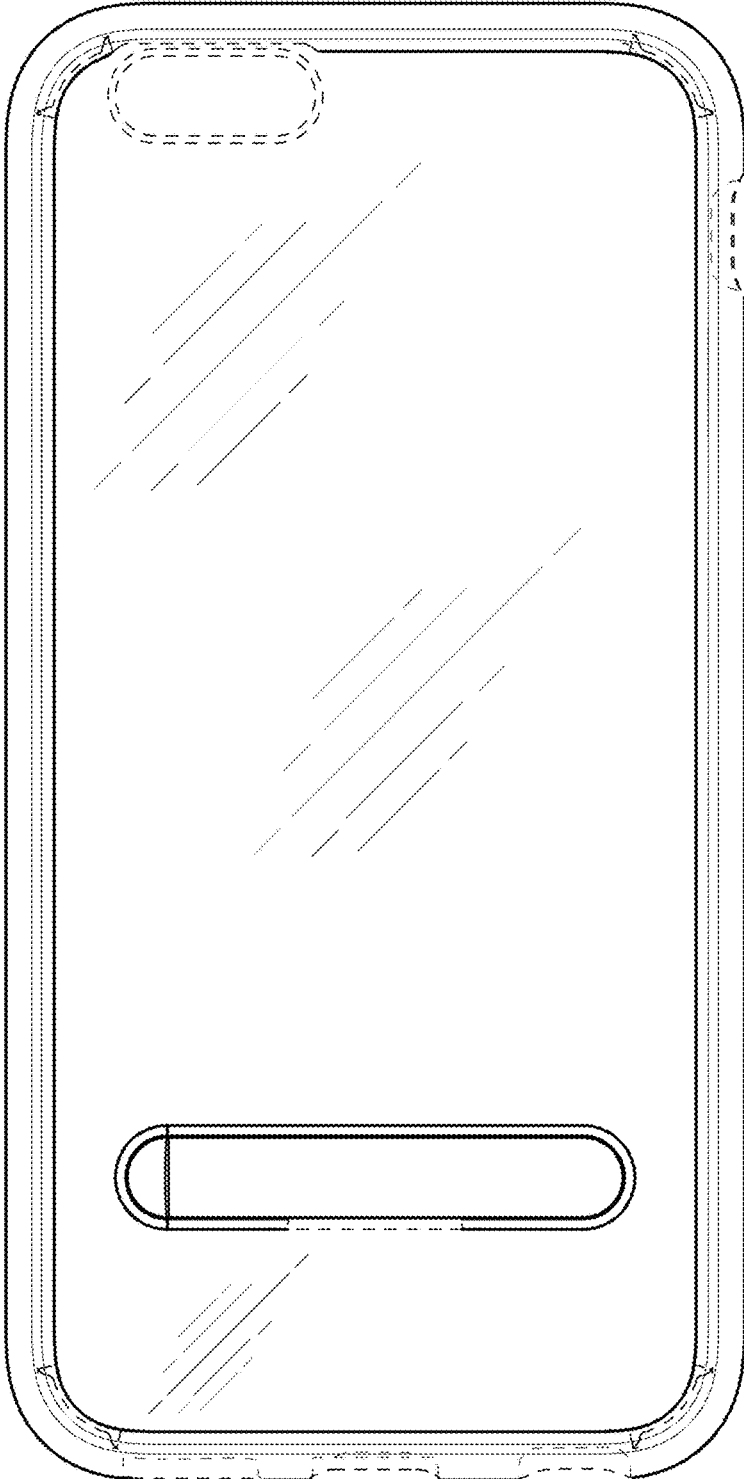

FIG. 5

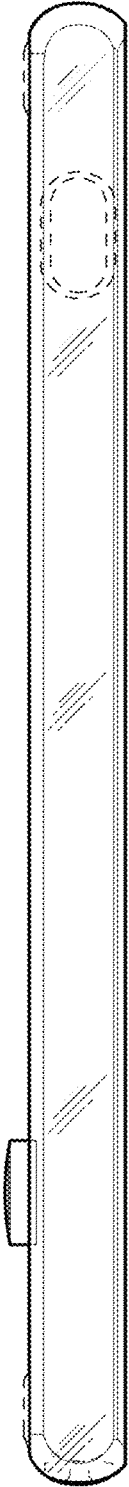

FIG. 6

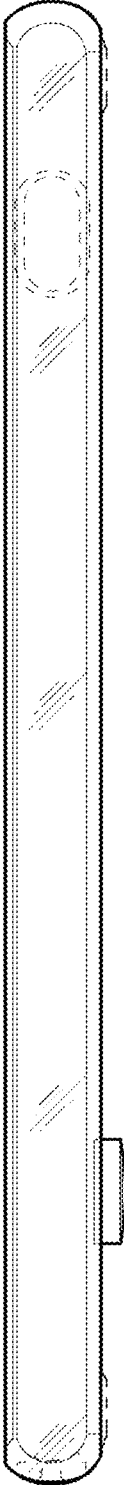



FIG. 7

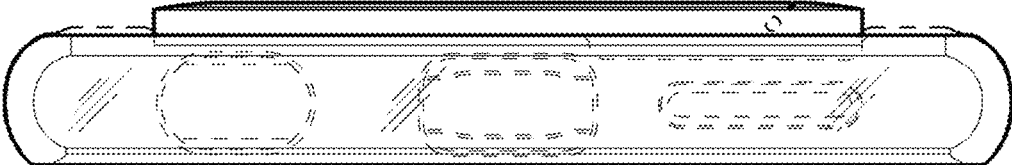

FIG. 8

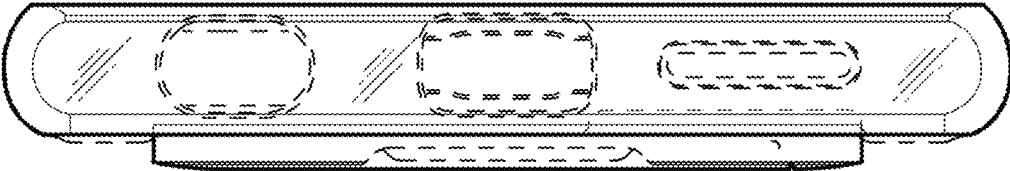

FIG. 9

