



US00D672720S

(12) **United States Design Patent**
Lyford et al.

(10) **Patent No.:** **US D672,720 S**

(45) **Date of Patent:** **** *Dec. 18, 2012**

(54) **PLUG FOR ACCESSORY-HOST INTERFACE**

(75) Inventors: **J. Steven Lyford**, Portland, OR (US);
Robert R. Kreitzer, Tigard, OR (US)

(73) Assignee: **Tektronix, Inc.**, Beaverton, OR (US)

(*) Notice: This patent is subject to a terminal disclaimer.

(**) Term: **14 Years**

(21) Appl. No.: **29/417,831**

(22) Filed: **Apr. 9, 2012**

Related U.S. Application Data

(62) Division of application No. 29/382,278, filed on Dec. 30, 2010.

(51) **LOC (9) Cl.** **13-03**

(52) **U.S. Cl.** **D13/133**

(58) **Field of Classification Search** D13/133,
D13/134, 135, 147, 154, 184, 199; D14/217,
D14/356, 358, 369, 383, 385, 432, 433, 439,
D14/440, 447, 454; D10/76, 78, 80; 439/180,
439/246, 252, 278, 374, 378, 379, 380, 381,
439/527, 529, 530, 533, 892, 894, 630

See application file for complete search history.

(56) **References Cited**

U.S. PATENT DOCUMENTS

D566,047 S 4/2008 Gabel et al.

Primary Examiner — Daniel Bui

(74) *Attorney, Agent, or Firm* — William K. Bucher

(57) **CLAIM**

The ornamental design for a plug for accessory-host interface, as shown and described.

DESCRIPTION

FIG. 1 is a front perspective view of a first embodiment of a plug for accessory-host interface showing our new design; FIG. 2 is a front elevation view thereof; FIG. 3 is a left side elevation view thereof; FIG. 4 is a right side elevation view thereof; FIG. 5 is a top plan view thereof; FIG. 6 is a bottom plan view thereof; FIG. 7 is a front perspective view of a second embodiment of a plug for accessory-host interface showing our new design; FIG. 8 is a front elevation view thereof; FIG. 9 is a left side elevation view thereof; FIG. 10 is a right side elevation view thereof; FIG. 11 is a top plan view thereof; FIG. 12 is a bottom plan view thereof; FIG. 13 is a front perspective view of a third embodiment of a plug for accessory-host interface showing our new design; FIG. 14 is a front elevation view thereof; FIG. 15 is a left side elevation view thereof; FIG. 16 is a right side elevation view thereof; FIG. 17 is a top plan view thereof; FIG. 18 is a bottom plan view thereof; FIG. 19 is a front perspective view of a fourth embodiment of a plug for accessory-host interface showing our new design; FIG. 20 is a front elevation view thereof; FIG. 21 is a left side elevation view thereof; FIG. 22 is a right side elevation view thereof; FIG. 23 is a top plan view thereof; and, FIG. 24 is a bottom plan view thereof.

The broken line portion of the figure drawings is included for the purpose of illustrating environment and forms no part of the claimed design.

1 Claim, 4 Drawing Sheets

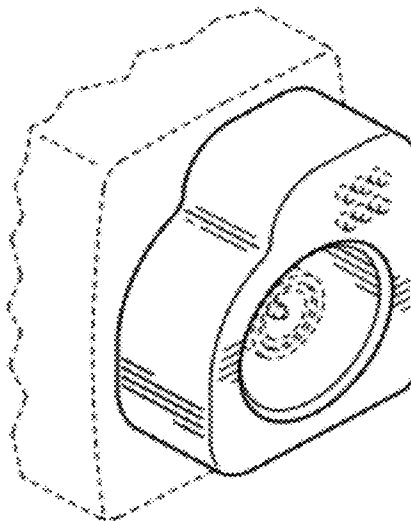
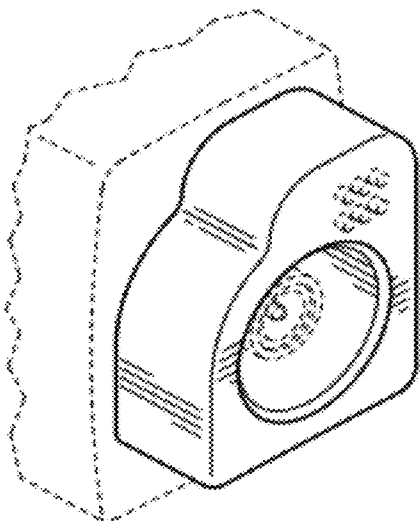

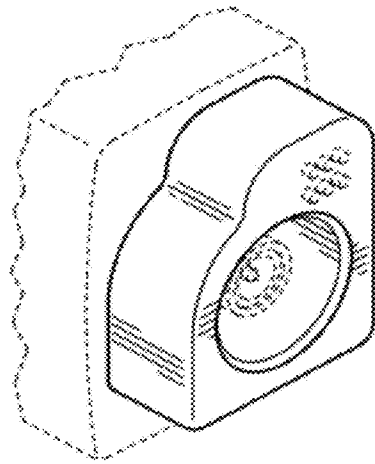

Figure 1

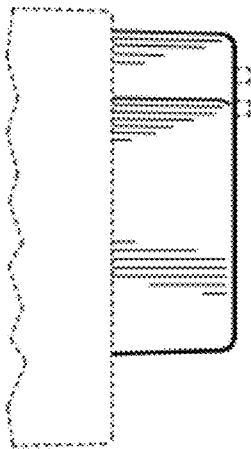

Figure 3

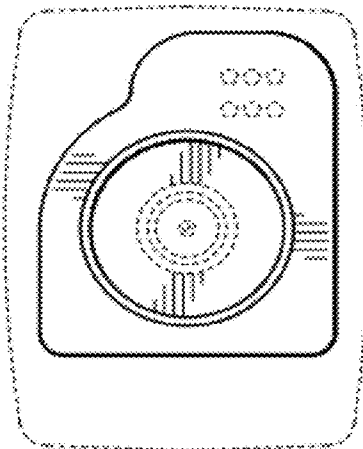

Figure 2

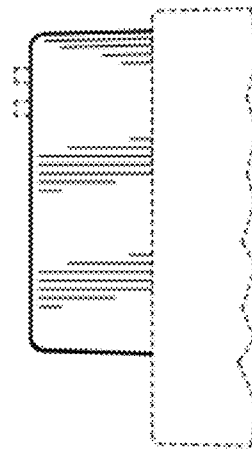

Figure 4

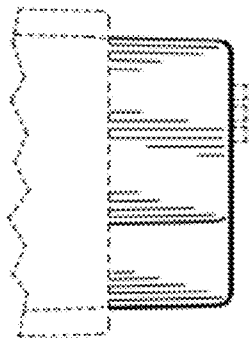

Figure 5

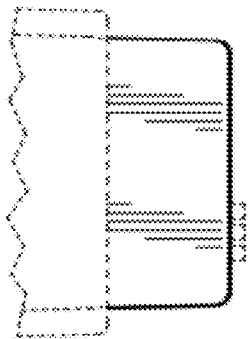

Figure 6

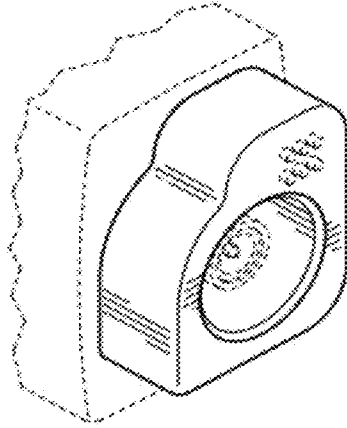

Figure 7

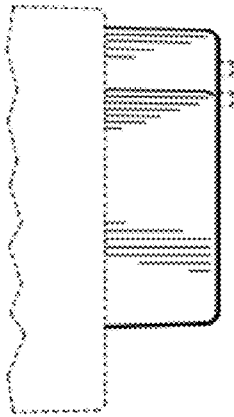

Figure 9

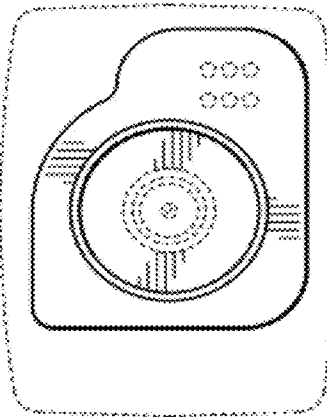

Figure 8

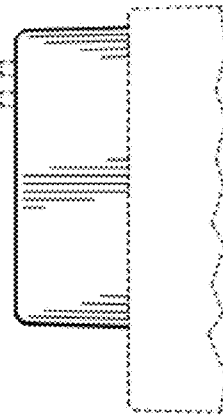

Figure 10

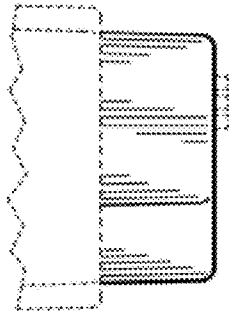

Figure 11

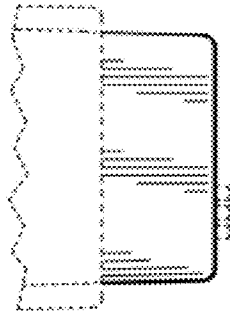

Figure 12

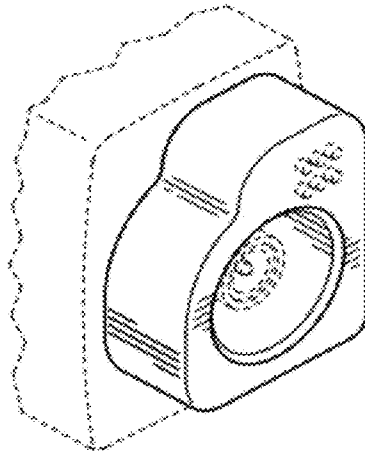

Figure 13

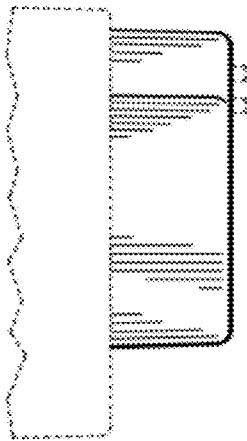

Figure 15

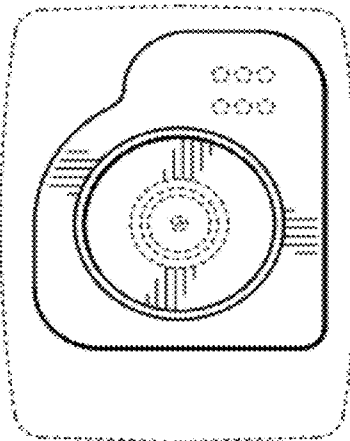

Figure 14

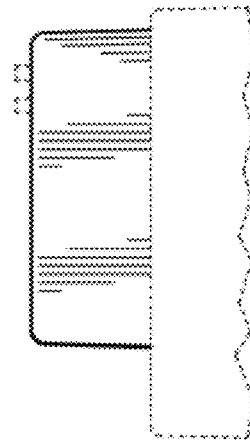

Figure 16

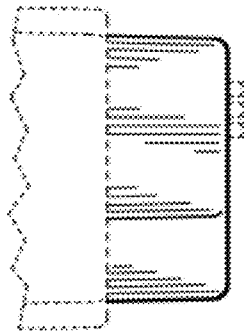

Figure 17

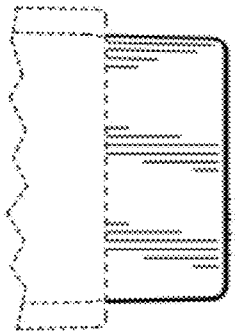

Figure 18

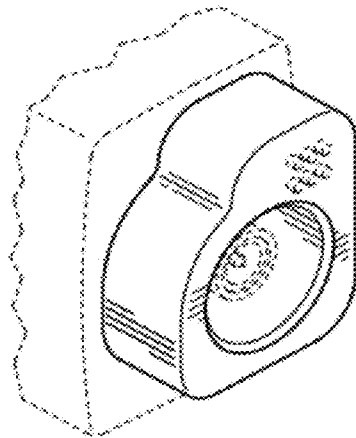

Figure 19

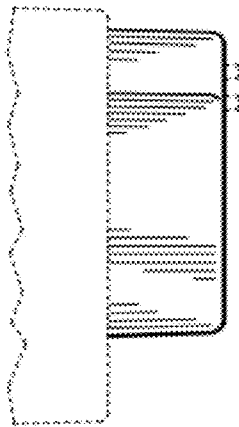

Figure 21

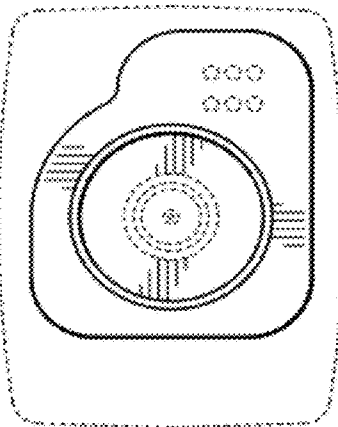

Figure 20

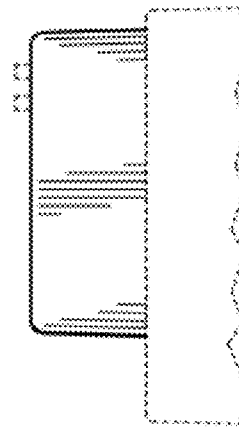

Figure 22

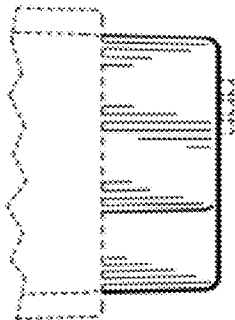

Figure 23

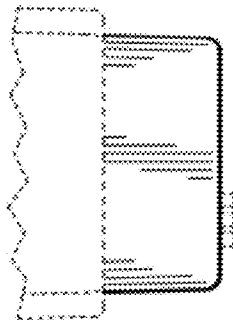

Figure 24