



US0D1042140S

(12) **United States Design Patent**  
**Cox et al.**

(10) **Patent No.:** **US D1,042,140 S**

(45) **Date of Patent:** **\*\* \*Sep. 17, 2024**

(54) **DISPENSING BOTTLE**

FOREIGN PATENT DOCUMENTS

(71) Applicant: **Henkel AG & Co. KGaA**, Duesseldorf (DE)

CN 303205468 5/2015  
CN 305193695 6/2019

(Continued)

(72) Inventors: **Peter Cox**, Dublin (IE); **Glenn Doogan**, Dublin (IE); **Peter O’Sullivan**, Dublin (IE); **Jason Tilk**, Cleveland Heights, OH (US); **Maynard Payumo**, Parma, OH (US)

OTHER PUBLICATIONS

Amazon, Aug. 11, 2017, Amazon.com Product|Walrus Oil—Cutting Board Oil and Wood Butcher Block Oil, 8 oz Bottle, FDA Food-Safe, URL: <https://www.amazon.com/WALRUS-OIL-Cutting-Butcher-Food-Safe/dp/B074QVDKYC/> (Year: 2017).\*

(Continued)

(73) Assignee: **Henkel AG & Co. KGaA**, Duesseldorf (DE)

*Primary Examiner* — Michael C Stout

*Assistant Examiner* — Rami J Abdallah

(74) *Attorney, Agent, or Firm* — Steven C. Bauman

(\* ) Notice: This patent is subject to a terminal disclaimer.

(\*\*) Term: **15 Years**

(21) Appl. No.: **29/850,562**

(57) **CLAIM**

The ornamental design for a dispensing bottle, as shown and described.

(22) Filed: **Aug. 22, 2022**

**Related U.S. Application Data**

**DESCRIPTION**

(63) Continuation of application No. 29/807,776, filed on Sep. 14, 2021, now Pat. No. Des. 961,395, which is (Continued)

FIG. 1 is a front, top, and right side perspective view of a dispensing bottle showing our new design;

FIG. 2 is a front view thereof;

FIG. 3 is a rear view thereof;

FIG. 4 is a left view thereof;

FIG. 5 is a right view thereof;

FIG. 6 is a top view thereof;

FIG. 7 is a bottom view thereof;

FIG. 8 is a front, top, and right side perspective view of a dispensing bottle showing our new design according to another embodiment;

FIG. 9 is a front view thereof;

FIG. 10 is a rear view thereof;

FIG. 11 is a left view thereof;

FIG. 12 is a right view thereof;

FIG. 13 is a top view thereof; and,

FIG. 14 is a bottom view thereof.

(Continued)

(51) **LOC (14) Cl.** ..... **09-01**

(52) **U.S. Cl.**  
USPC ..... **D9/516**; D9/550; D9/563; D9/574

(58) **Field of Classification Search**  
USPC ..... D9/500, 516, 521, 530, 536, 542, 544, D9/549, 550, 556, 558, 559, 562, 563,  
(Continued)

(56) **References Cited**

U.S. PATENT DOCUMENTS

D184,593 S 11/1876 Curtice  
1,602,391 A 10/1926 Creaver

(Continued)

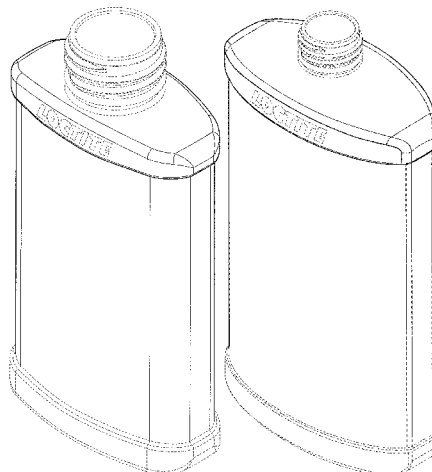

The broken lines depict environment and form no part of the claimed design.

**1 Claim, 10 Drawing Sheets**

**Related U.S. Application Data**

a continuation of application No. 29/696,787, filed on Jul. 1, 2019, now Pat. No. Des. 932,907.

(58) **Field of Classification Search**

USPC ..... D9/565, 572, 573, 574, 575, 552, 560, D9/571, 557; D4/114; D7/590  
 CPC ..... B65D 1/0223; B65D 23/102; B65D 2501/0081; B65D 2501/0036; B65D 79/005; B65D 1/44; C08L 33/08; A61J 1/03; A61J 1/00

See application file for complete search history.

(56) **References Cited**

U.S. PATENT DOCUMENTS

D109,928 S	5/1938	Williams
D176,975 S	2/1956	Chilton
D254,773 S	4/1980	Kretz
D260,367 S	8/1981	Grip
D278,515 S	4/1985	Adams
D279,261 S	6/1985	Blocksom
D286,986 S	12/1986	Rader
D290,342 S	6/1987	Lyons
D309,714 S	8/1990	Biesecker
D316,225 S	4/1991	Edstrom et al.
D319,582 S	9/1991	Crawford
D325,167 S	4/1992	Humfress
5,156,285 A	10/1992	Zogg et al.
D333,435 S	2/1993	Blair
D348,613 S	7/1994	Gonda
D352,461 S	11/1994	Flanagan
5,435,451 A	7/1995	Dyer
D367,010 S	2/1996	Moore
D372,675 S	8/1996	Pollard
D394,211 S	5/1998	Kuzma et al.
6,129,802 A	10/2000	Key
6,536,977 B1	3/2003	Hammel
D505,078 S	5/2005	Fischer et al.
6,913,405 B2	7/2005	Fischer et al.
6,997,337 B1	2/2006	Wurster

D528,429 S	9/2006	Bartel	
D529,814 S	10/2006	Winkler	
D533,456 S	12/2006	Schuller et al.	
D534,804 S	1/2007	Muehlihausen	
D614,036 S	4/2010	Gedanke	
D619,471 S	7/2010	Graunstadt	
D932,907 S	10/2021	Cox	
D932,908 S	10/2021	Cox	
D932,909 S	10/2021	Cox	
D932,910 S	10/2021	Cox	
D932,911 S	10/2021	Cox	
D932,912 S	10/2021	Cox	
D932,913 S	10/2021	Cox	
D932,914 S	10/2021	Cox	
D932,915 S	10/2021	Cox	
D932,916 S	10/2021	Cox	
D932,919 S	10/2021	Cox	
D934,083 S	10/2021	Cox	
D938,281 S	12/2021	Pham	
D955,221 S *	6/2022	Miller	D9/574
D961,390 S *	8/2022	Cox	D9/563
D961,391 S *	8/2022	Cox	D9/563
D961,392 S *	8/2022	Cox	D9/563
D961,393 S *	8/2022	Cox	D9/563
D961,394 S *	8/2022	Cox	D9/563
D961,395 S *	8/2022	Cox	D9/563
D961,396 S *	8/2022	Cox	D9/563
11,577,877 B2 *	2/2023	Jarman	B65D 41/3428
2001/0022291 A1	9/2001	Shimada et al.	
2005/0189314 A1	9/2005	Carbone	
2007/0090083 A1	10/2007	Trude	
2009/0255893 A1	10/2009	Zummo et al.	
2013/0008913 A1	1/2013	Boukobza	
2015/0158620 A1	6/2015	Sekiguchi et al.	
2020/0198826 A1	6/2020	Koy et al.	
2023/0106082 A1 *	4/2023	Cox	B65D 1/0223 215/382

FOREIGN PATENT DOCUMENTS

KR	300423334.0000	8/2006
KR	3020180001616	12/2018

OTHER PUBLICATIONS

Loctite, Jul. 15, 2020, Loctite Youtube Page Video Post, URL:https://www.youtube.com/watch?v=2J8vesV5fRU (Year: 2020).  
 New Packing, Feb. 28, 2020, Henkel website post, U RL:https://www.henkel-adhesives.com/uk/en/product/threadlockers/ loctite\_222. html (Year: 2020).

\* cited by examiner

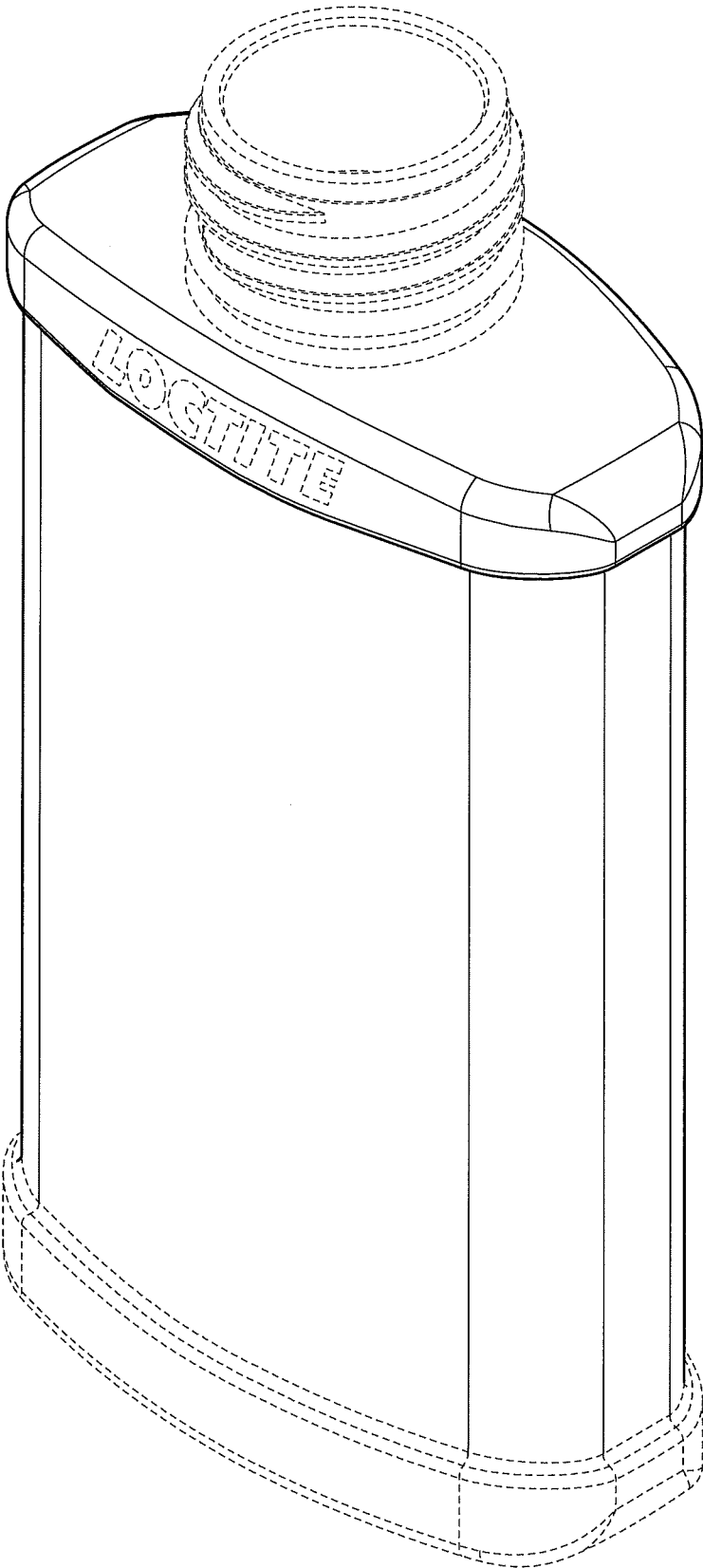

FIG. 1

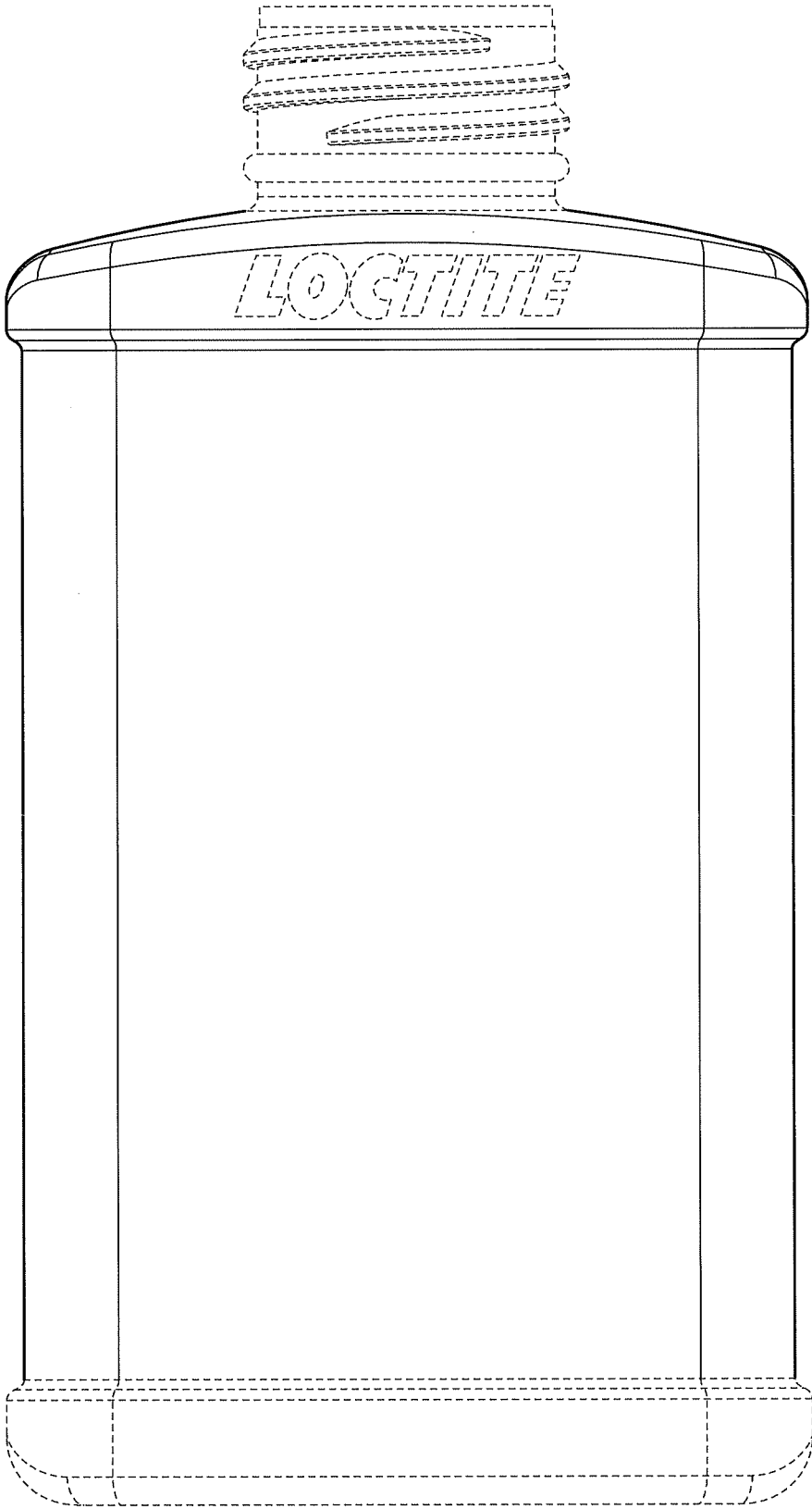

FIG. 2

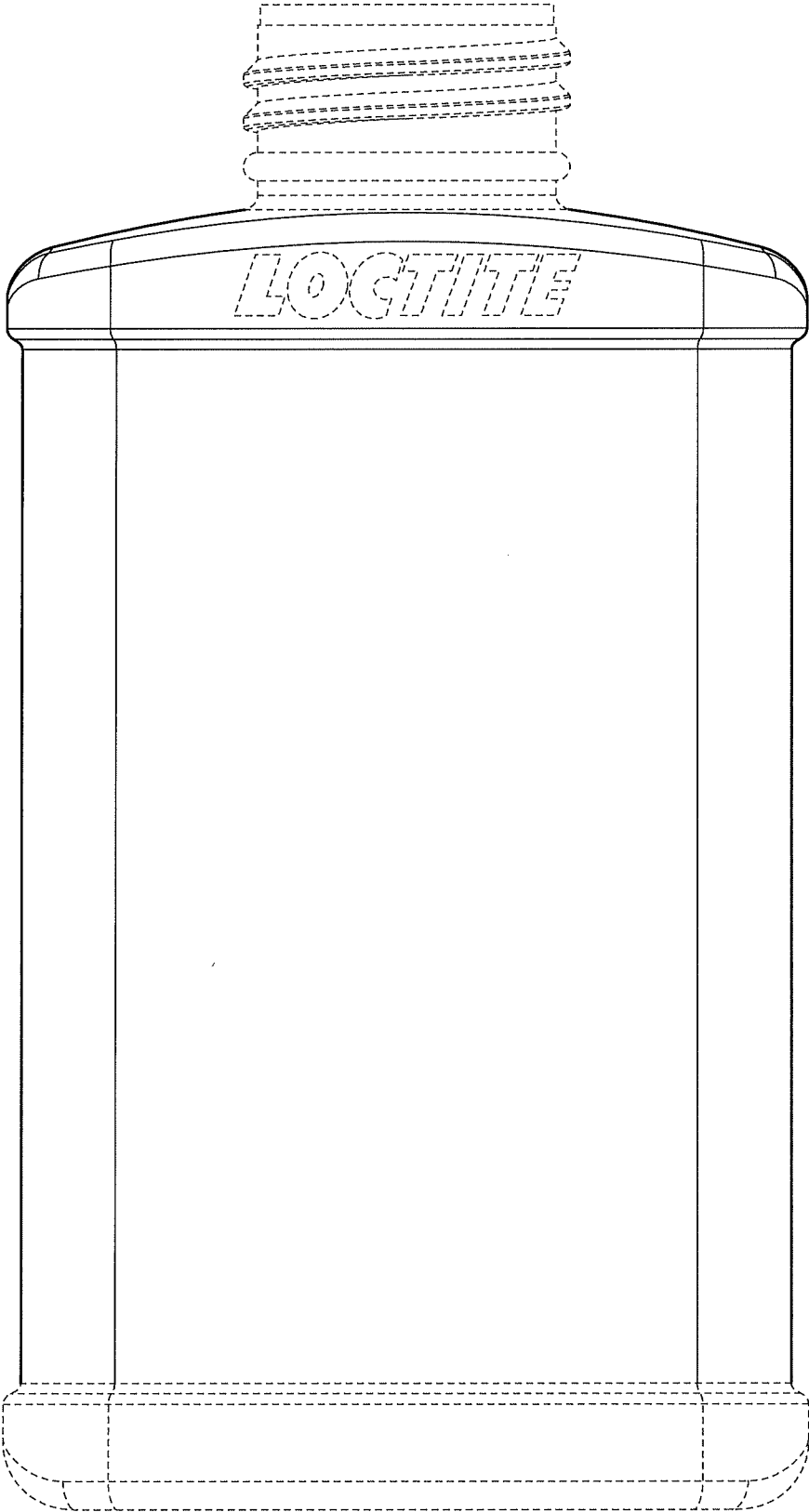

FIG. 3

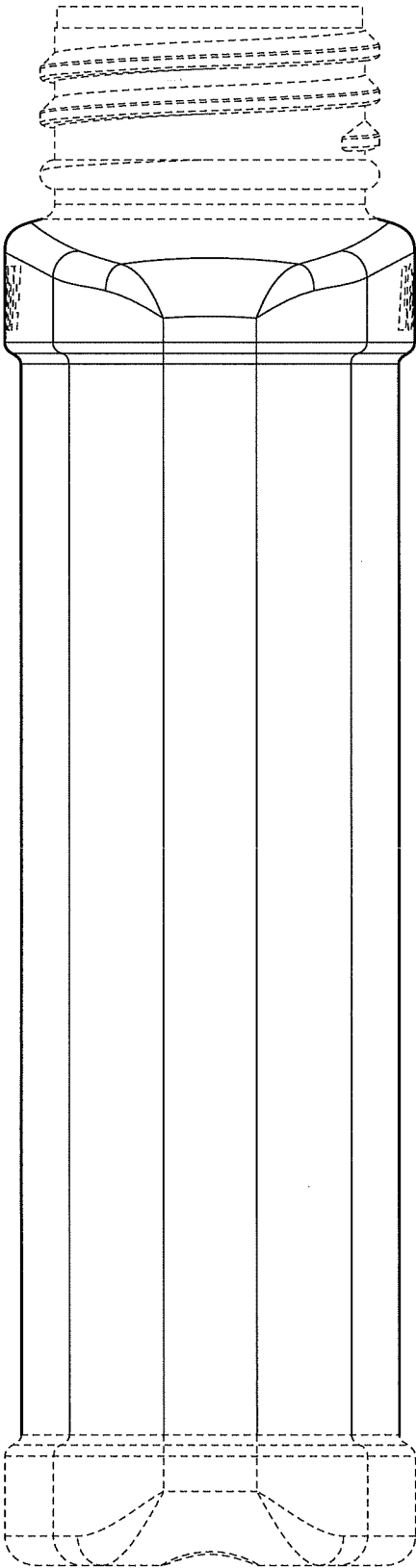

FIG. 4

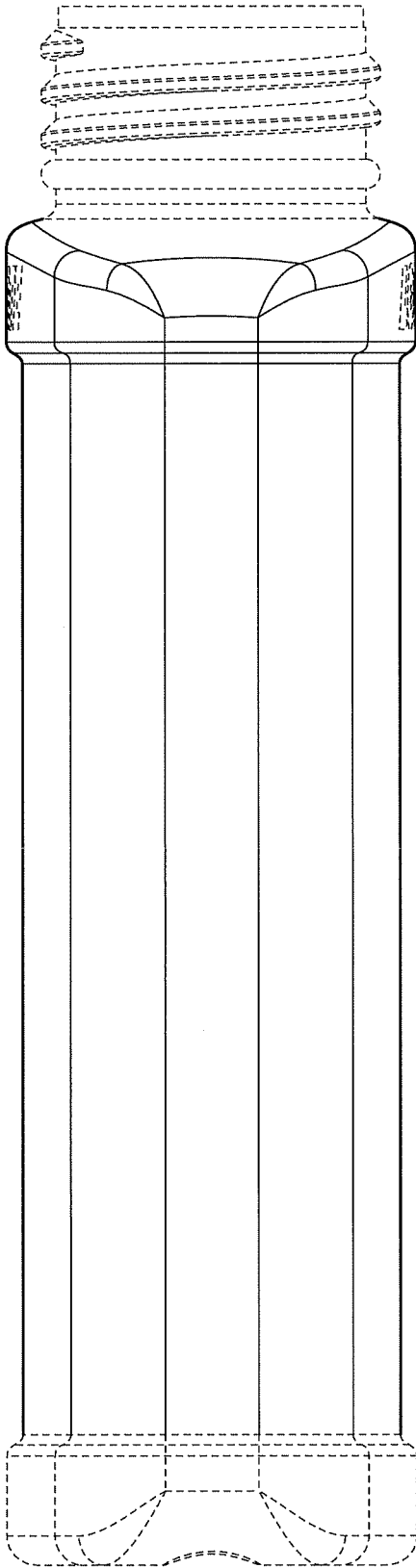

FIG. 5

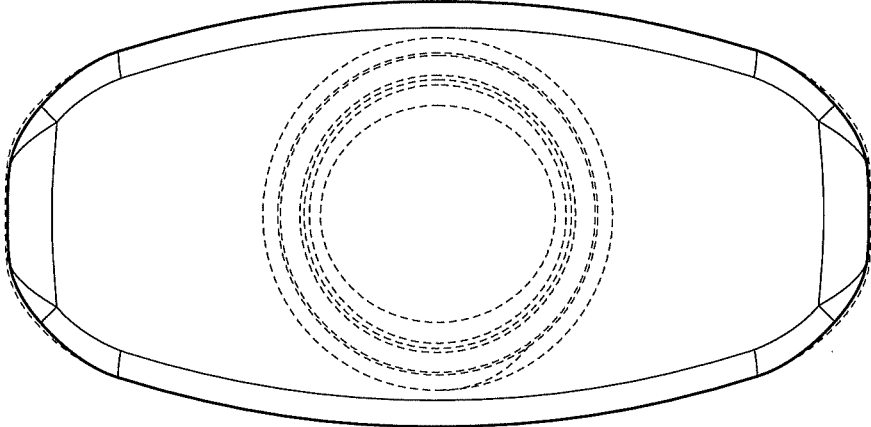

FIG. 6

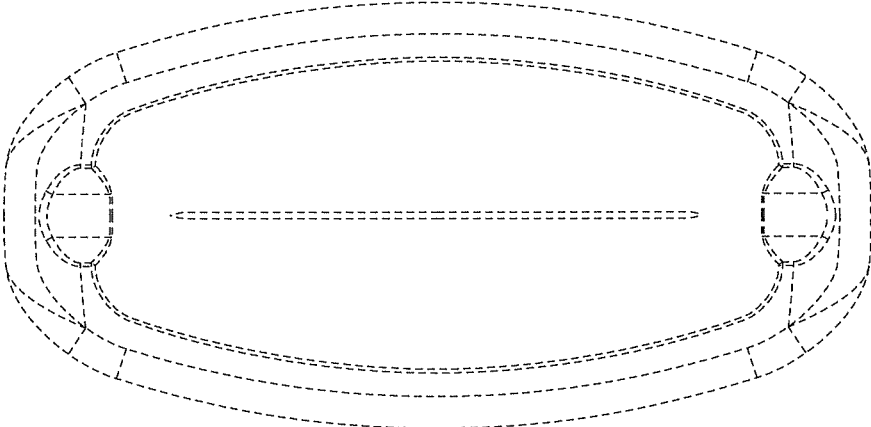

FIG. 7

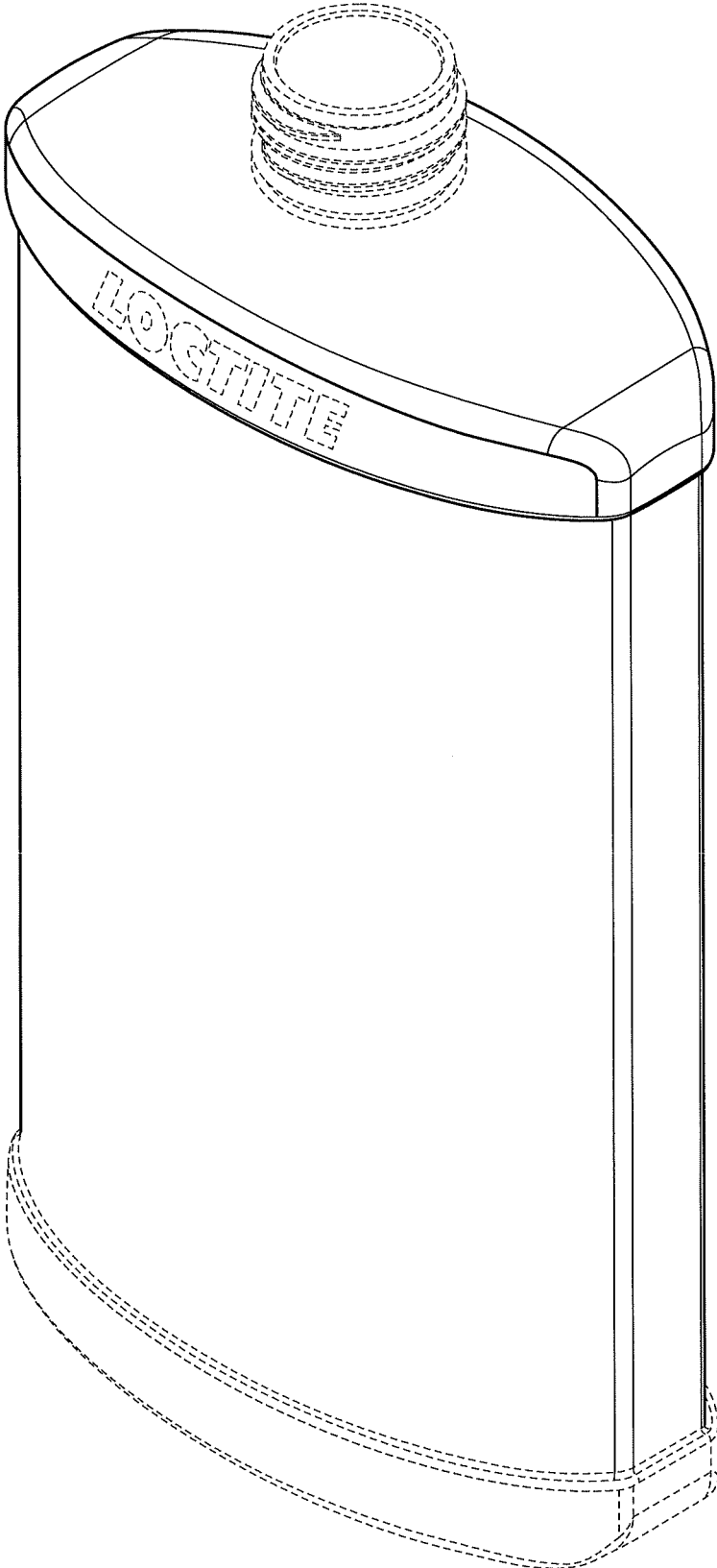

FIG. 8



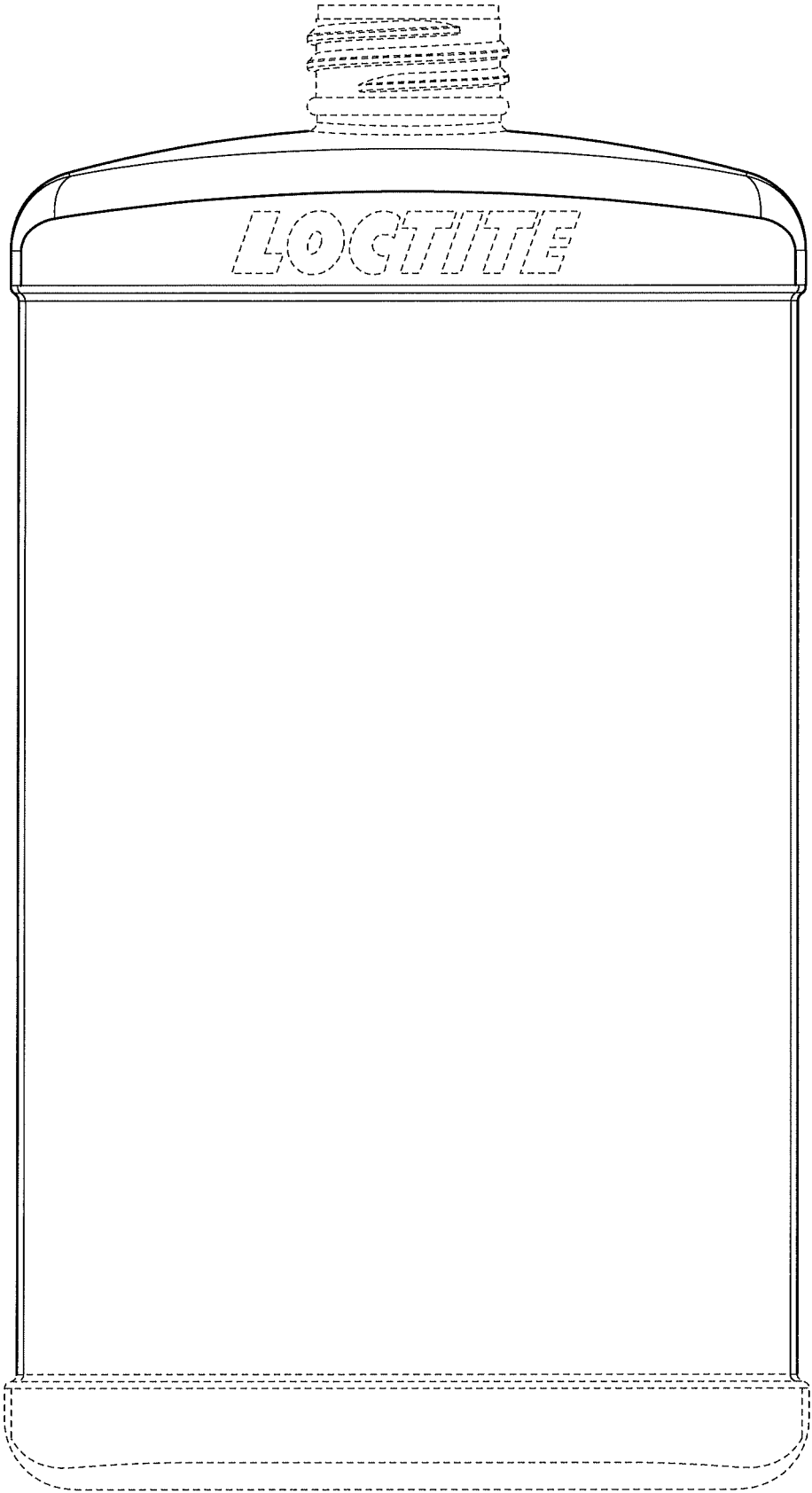

FIG. 9

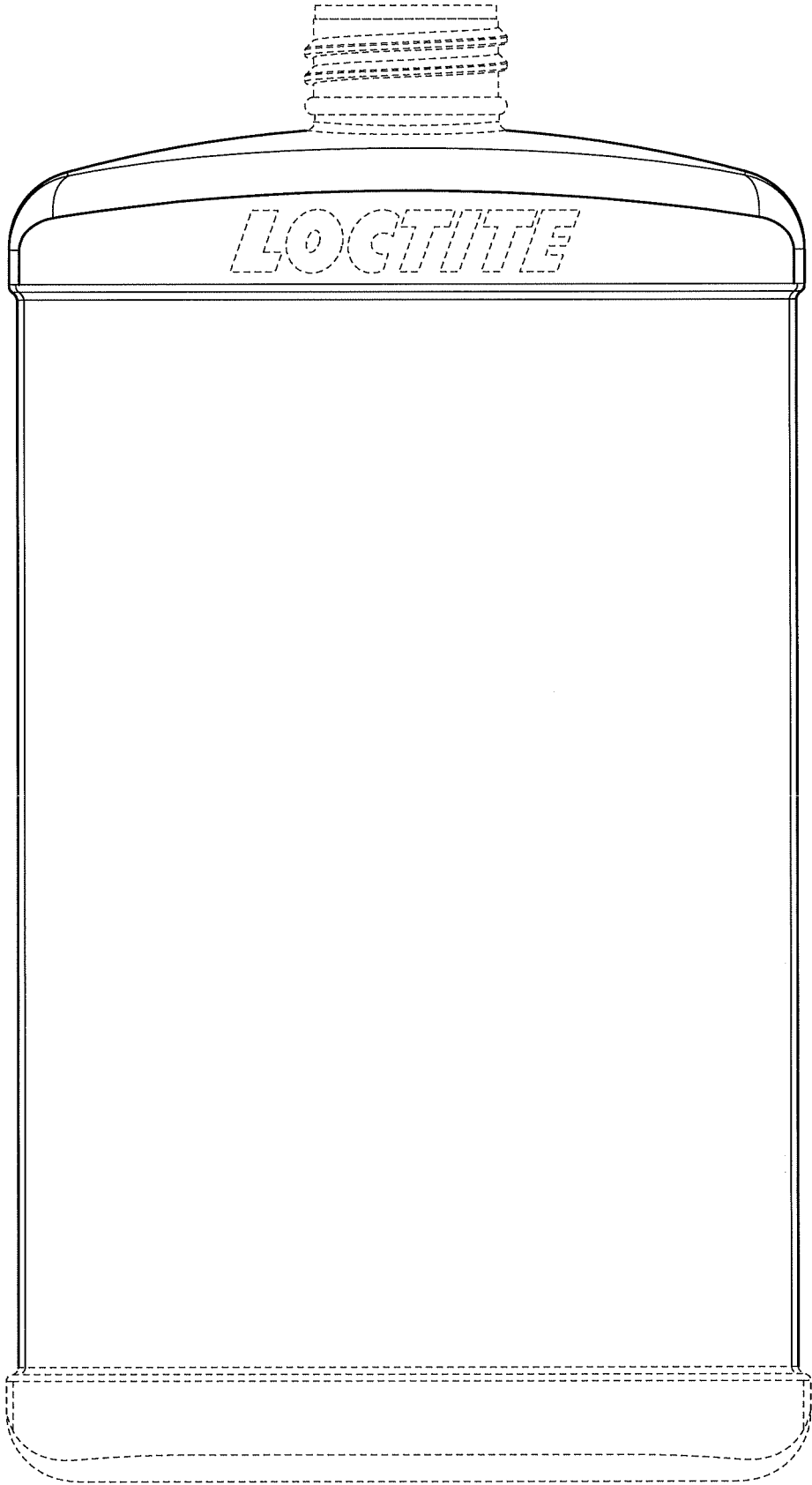

FIG. 10

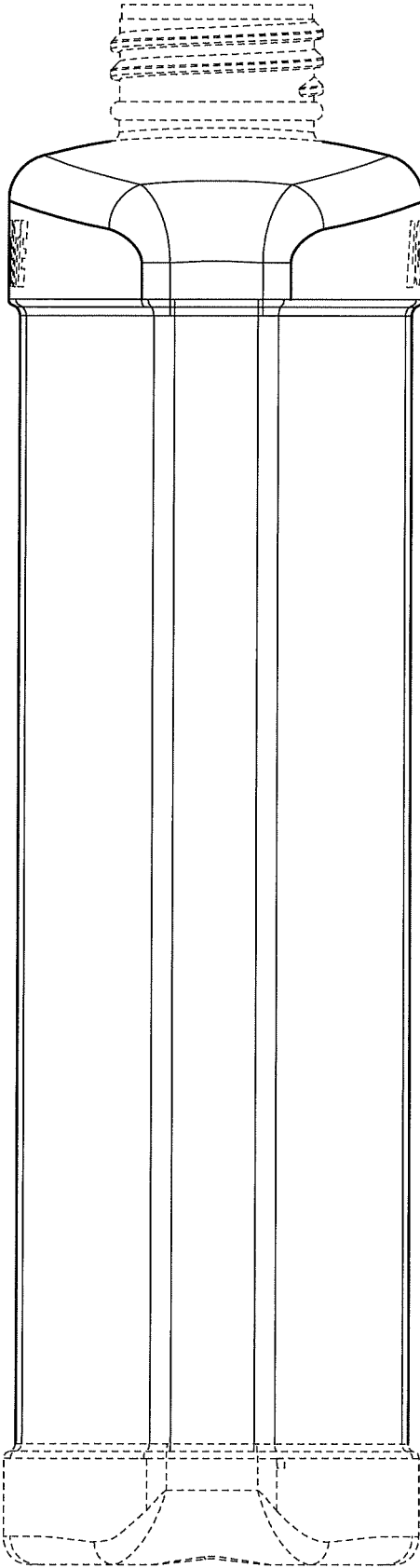

FIG. 11

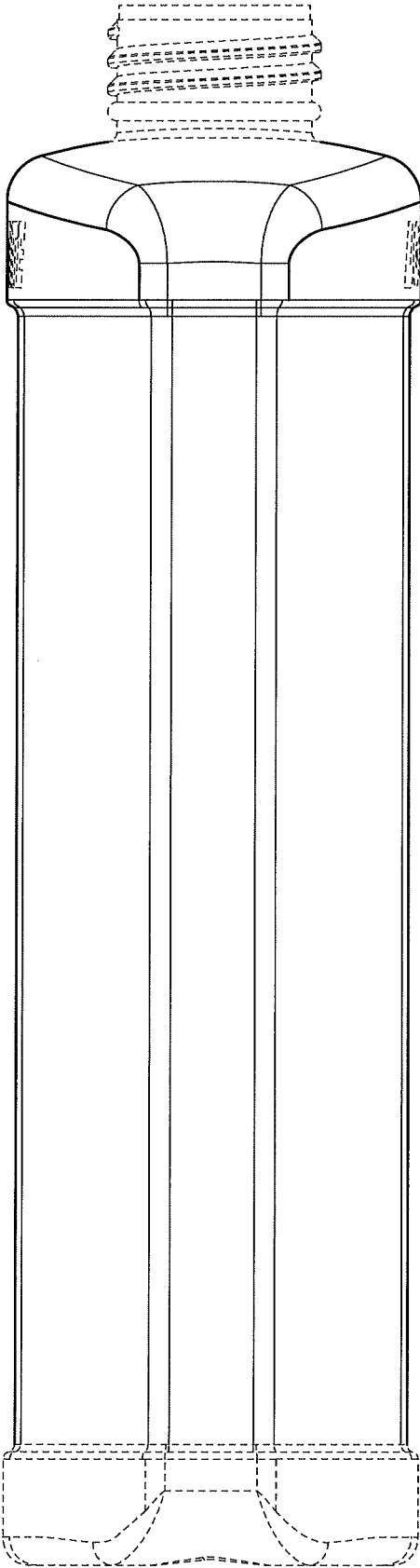

FIG. 12

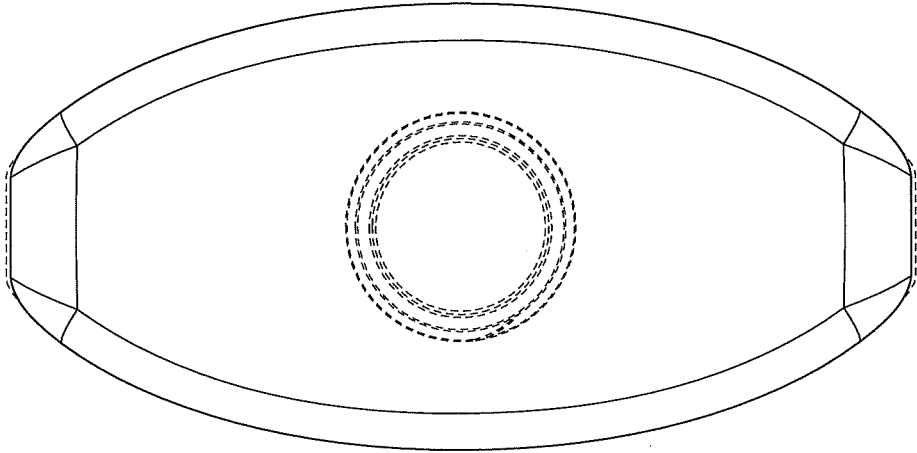

FIG. 13

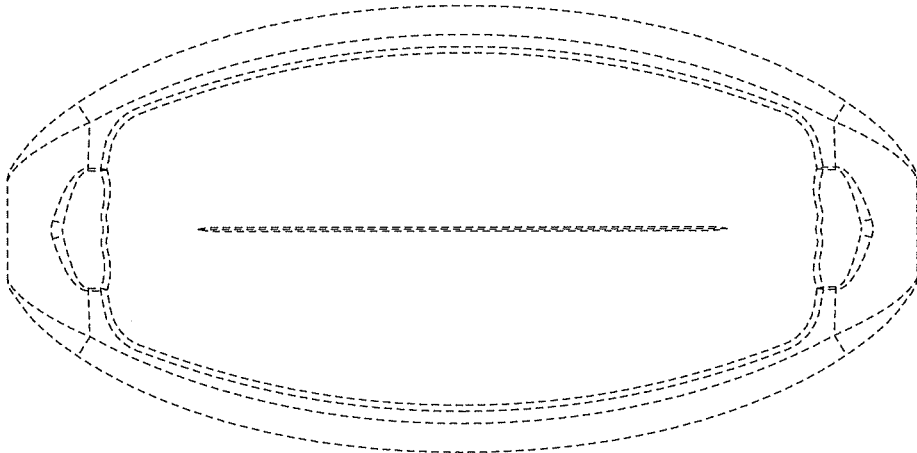

FIG. 14