



US00D703651S

(12) **United States Design Patent**
Ehrlich

(10) **Patent No.:** **US D703,651 S**

(45) **Date of Patent:** **** Apr. 29, 2014**

(54) **MOBILE DEVICE CASE WITH STORAGE COMPARTMENT**

(71) Applicant: **Jake Ehrlich**, San Francisco, CA (US)

(72) Inventor: **Jake Ehrlich**, San Francisco, CA (US)

(**) Term: **14 Years**

(21) Appl. No.: **29/437,545**

(22) Filed: **Nov. 18, 2012**

(51) **LOC (10) Cl.** **14-03**

(52) **U.S. Cl.**
USPC **D14/250**

(58) **Field of Classification Search**
USPC D14/250, 440, 238.1, 251-253,
D14/203.3-203.7, 217, 496, 248, 240, 447,
D14/341-347, 432, 434; D13/110, 118,
D13/184, 199, 103, 107, 108, 119;
220/4.02; 320/107; 224/191, 240, 241,
224/245, 682, 683; D3/201, 218, 247, 269,
D3/273, 301, 303; 361/679.56, 679.3,
361/679.25, 816; 379/426, 433.11, 455;
455/575.1, 575.8

See application file for complete search history.

(56) **References Cited**

U.S. PATENT DOCUMENTS

D403,858	S	*	1/1999	Wicks	D3/249
D426,703	S	*	6/2000	Kojoori	D3/249
D431,719	S	*	10/2000	Mucarquer	D3/247
D434,899	S	*	12/2000	Kojoori	D3/249
D575,506	S	*	8/2008	Huang	D3/247
D610,346	S	*	2/2010	Eriksen et al.	D3/247
D615,078	S	*	5/2010	Bradley	D14/250
D619,130	S	*	7/2010	Fellig	D14/250

D624,064	S	*	9/2010	Esposito	D14/250
D625,920	S	*	10/2010	Lyon et al.	D3/247
D650,810	S	*	12/2011	Lemelman et al.	D14/496
D654,931	S	*	2/2012	Lemelman et al.	D14/496
D681,620	S	*	5/2013	Huskinson	D14/250
D688,654	S	*	8/2013	Stevinson	D14/250
D691,636	S	*	10/2013	Bunton	D14/496
2013/0095898	A1	*	4/2013	Altschul et al.	455/575.8

* cited by examiner

Primary Examiner — Adir Aronovich

Assistant Examiner — Ethiene Salgado-Rodriguez

(74) *Attorney, Agent, or Firm* — Olsen Patent Law

(57) **CLAIM**

I claim the ornamental design for a mobile device case with storage compartment, as shown and described.

DESCRIPTION

FIG. 1 is a front and right side perspective view of the mobile device case with storage compartment showing my new design;

FIG. 2 is a rear and left side perspective view thereof;

FIG. 3 is a rear and left side perspective view thereof with storage compartment door open;

FIG. 4 is a front elevation view thereof;

FIG. 5 is a right side elevation view thereof;

FIG. 6 is a rear elevation view thereof;

FIG. 7 is a left side elevation view thereof;

FIG. 8 is a top plan view thereof; and,

FIG. 9 is a bottom plan view thereof.

The broken lines showing of the environment in the drawings is for illustrative purposes only and forms no part of the claimed invention.

1 Claim, 6 Drawing Sheets

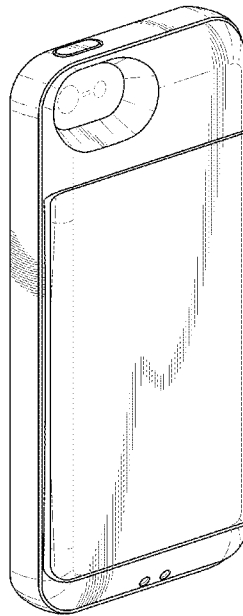
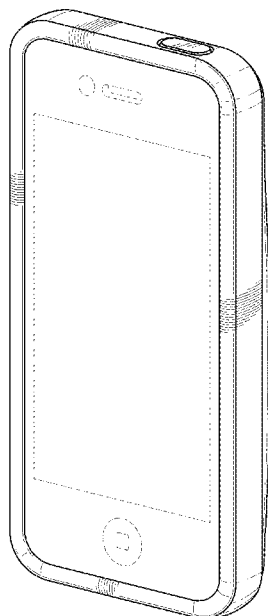

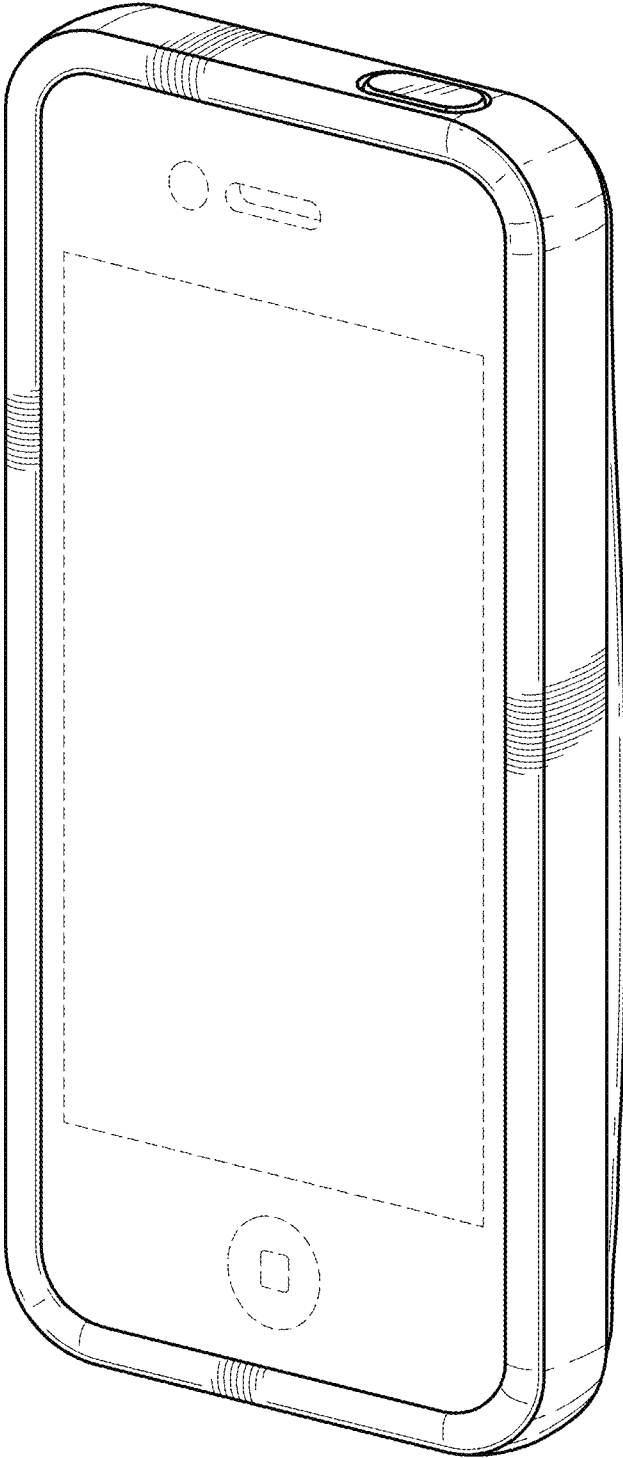

FIG. 1

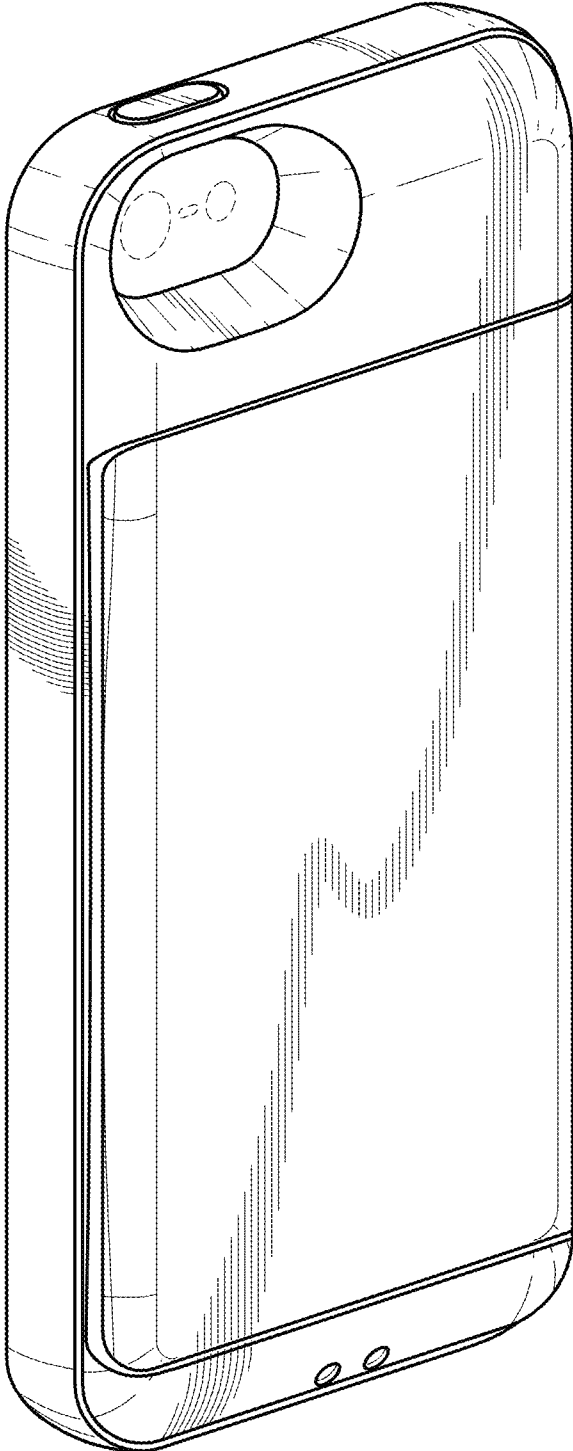

FIG. 2

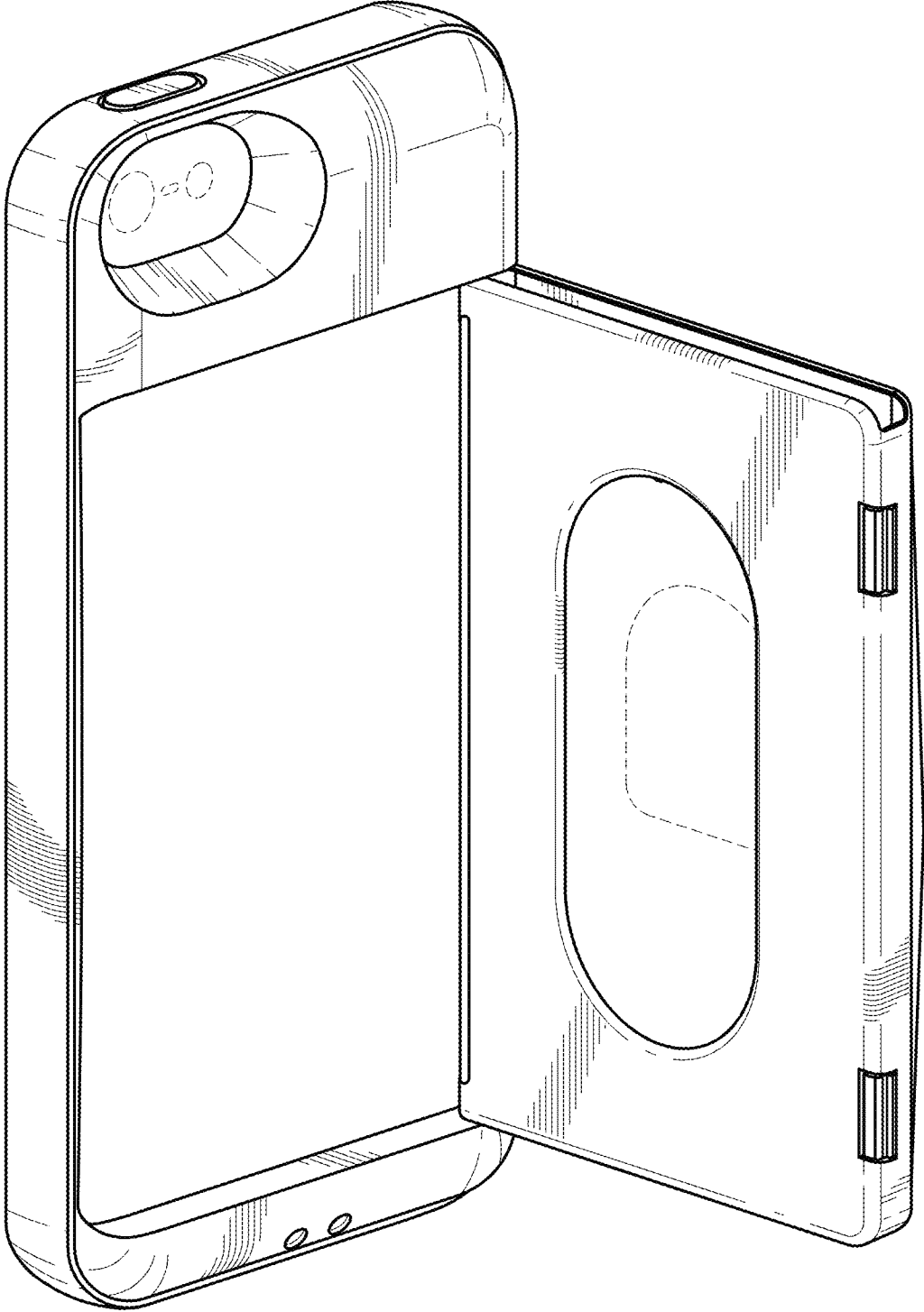

FIG. 3

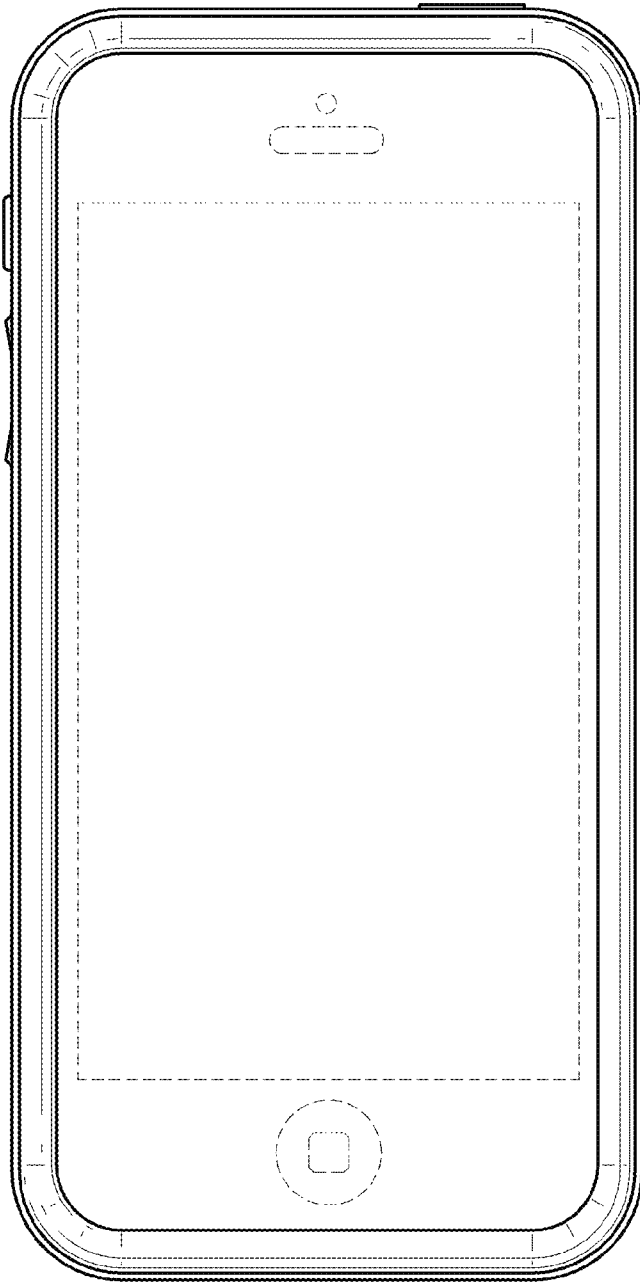

FIG. 4

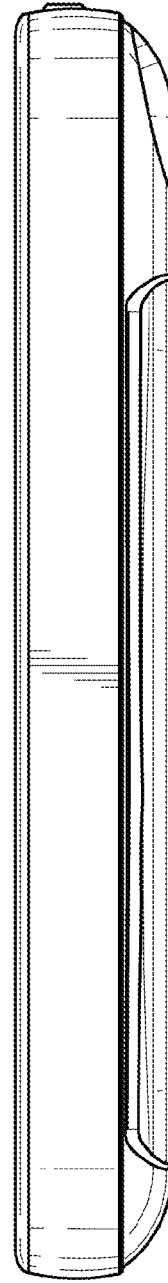

FIG. 5

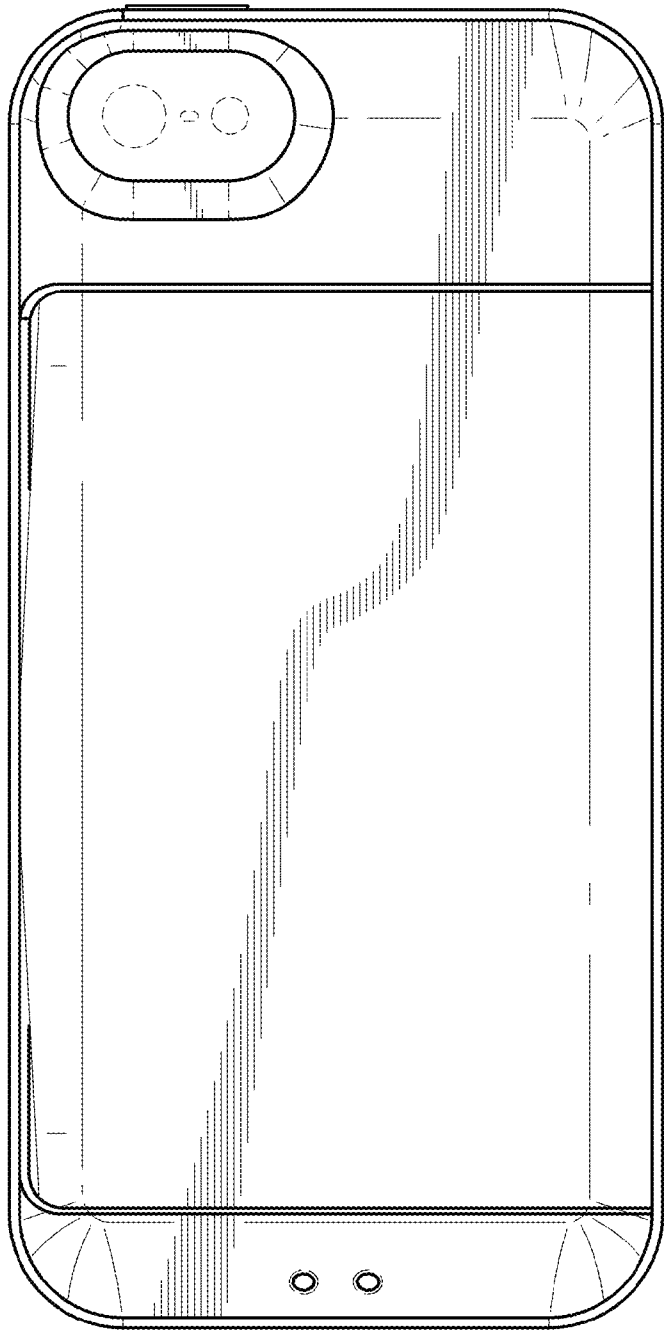

FIG. 6

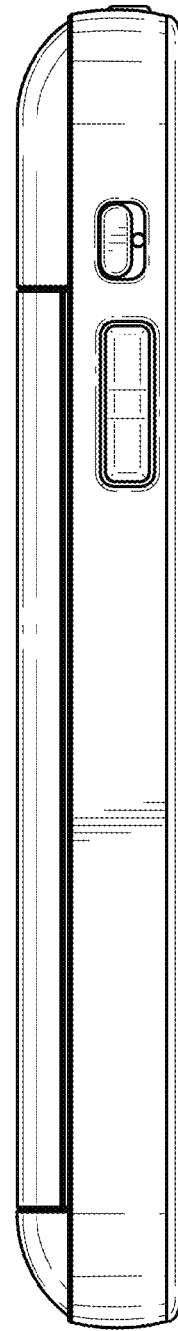

FIG. 7

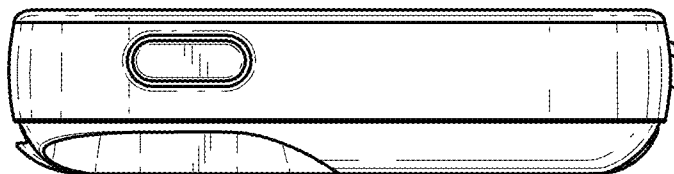

FIG. 8

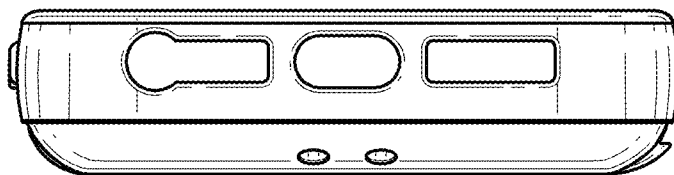

FIG. 9