



US00D704346S

(12) **United States Design Patent**
Tai

(10) **Patent No.:** **US D704,346 S**

(45) **Date of Patent:** **** May 6, 2014**

(54) **PERSONAL MASSAGER**

OTHER PUBLICATIONS

(71) Applicant: **Gizmospring.com Dongguan Limited,**
Dongguan (CN)

DHgate, Wholesale—7 Functional Sex Massager/Sex Vibrator/
Tongue Vibrator/Sex Products for Female, Retrieved Sep. 25, 2013,
from <http://www.dhgate.com/product/7-functional-sex-massager-sex-vibrator-tongue/76266244.html>.

(72) Inventor: **Chih-Yao Tai,** Admiralty (HK)

(Continued)

(73) Assignee: **Gizmospring.com Dongguan Limited,**
Dongguan (CN)

Primary Examiner — Sandra Snapp

(74) *Attorney, Agent, or Firm* — Davis Wright Tremaine
LLP; Heather M. Colburn

(**) Term: **14 Years**

(57) **CLAIM**

(21) Appl. No.: **29/462,360**

The ornamental design for a personal massager, as shown and
described.

(22) Filed: **Aug. 1, 2013**

DESCRIPTION

(30) **Foreign Application Priority Data**

Jul. 19, 2013 (CN) 2013 3 0340773

(51) **LOC (10) Cl.** **28-03**

(52) **U.S. Cl.**
USPC **D24/215**

(58) **Field of Classification Search**
USPC D24/200, 211, 212, 213, 214, 215;
601/114, 120, 121, 124, 125, 130, 131,
601/134, 135, 136, 137

See application file for complete search history.

FIG. 1 is a left side perspective view of a personal massager
showing my new design.

FIG. 2 is a front elevation view thereof.

FIG. 3 is a top side plan view thereof.

FIG. 4 is a bottom side plan view thereof.

FIG. 5 is a left plan view thereof.

FIG. 6 is a right plan view thereof.

FIG. 7 is a rear elevation view thereof.

FIG. 8 is a left side perspective view of a second embodiment
thereof.

FIG. 9 is a front elevation view of the second embodiment
thereof.

FIG. 10 is a top side plan view of the second embodiment
thereof.

FIG. 11 is a bottom side plan view of the second embodiment
thereof.

FIG. 12 is a left plan view of the second embodiment thereof.

FIG. 13 is a right plan view of the second embodiment
thereof; and,

FIG. 14 is a rear elevation view of the second embodiment
thereof.

The broken lines represent portions of the personal massager
that form no part of the claim.

(56) **References Cited**

U.S. PATENT DOCUMENTS

2,350,817 A 10/1940 Purves et al.
2,286,089 A 6/1942 Harris
2,287,501 A 9/1942 Thomas

(Continued)

FOREIGN PATENT DOCUMENTS

CN 2880053 Y 3/2007
CN 202637414 U 1/2013

(Continued)

1 Claim, 12 Drawing Sheets

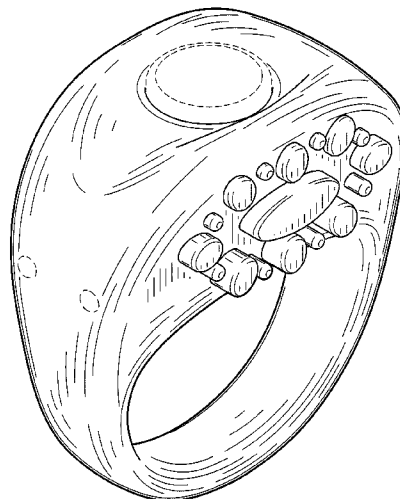

(56)

References Cited

U.S. PATENT DOCUMENTS

2,480,023 A 8/1949 Holden
 2,686,325 A 3/1950 Silver
 2,918,055 A 12/1959 Boerger
 3,461,859 A 8/1969 Fortnam
 3,585,990 A 6/1971 Blachly et al.
 3,623,481 A 11/1971 Curran
 4,116,233 A 9/1978 Scaduto
 4,308,860 A 1/1982 Sanders et al.
 4,747,397 A 5/1988 Magovern
 5,413,551 A 5/1995 Wu
 5,519,292 A 5/1996 Taylor et al.
 5,601,529 A 2/1997 Wollman
 6,053,881 A 4/2000 Boodramsingh et al.
 D430,677 S 9/2000 Robinson
 6,203,509 B1 3/2001 Duboff
 D459,478 S 6/2002 Perricone
 D496,458 S * 9/2004 Lin D24/143
 6,964,643 B2 11/2005 Hovland et al.
 D523,151 S 6/2006 Telford
 D523,152 S 6/2006 Telford
 D523,561 S 6/2006 Telford
 D523,562 S 6/2006 Telford
 D523,958 S * 6/2006 Fang D24/143
 D523,963 S 6/2006 Telford
 D552,748 S * 10/2007 Gromosaik et al. D24/215
 D552,749 S * 10/2007 Gromosaik et al. D24/215
 D552,750 S * 10/2007 Gromosaik et al. D24/215
 D557,806 S * 12/2007 Gromosaik et al. D24/143
 D566,289 S * 4/2008 Tasker et al. D24/215
 D567,958 S 4/2008 Talbot et al.
 D581,544 S * 11/2008 Adams D24/215
 D597,215 S 7/2009 Wu
 D604,860 S 11/2009 Wu
 D611,161 S 3/2010 Wu
 7,871,386 B2 1/2011 Nan
 7,931,605 B2 4/2011 Murison
 D637,302 S * 5/2011 Post D24/215
 D637,305 S 5/2011 Feuerabend et al.
 8,033,985 B2 10/2011 Smith
 D652,942 S 1/2012 Murison
 D669,996 S 10/2012 Chen

D677,394 S 3/2013 Grust et al.
 D690,430 S 9/2013 McVay
 2003/0181835 A1 9/2003 Klein
 2004/0020241 A1 2/2004 Boiadjian
 2005/0143679 A1 6/2005 Gelber et al.
 2005/0283044 A1* 12/2005 Chang 600/38
 2008/0027361 A1* 1/2008 Lin 601/46
 2012/0116273 A1 5/2012 Nan
 2013/0060177 A1 3/2013 Künnecke

FOREIGN PATENT DOCUMENTS

DE 9309142 U1 8/1993
 DE 4432184 C1 12/1995
 FR 59368 5/1954
 GB 427349 4/1935
 GB 2451282 B 1/2012

OTHER PUBLICATIONS

Eden Fantasys, Bunny Finger Friend, Retrieved Sep. 25, 2013, from <http://www.edenfantasys.com/sex-toy-reviews/vibrators/great-material-but-moderate-vibrations>.
 English-language Abstract for Chinese Publication No. 2880053 (Y), Retrieved Aug. 7, 2013, from Espacenet.
 English-language Machine Translation for Chinese Publication No. 2880053 (Y), Retrieved Oct. 1, 2013, from Espacenet.
 English-language Abstract for Chinese Publication No. 202637414 (U), Retrieved Oct. 1, 2013, from Espacenet.
 English-language Abstract for German Publication No. 4432184 (C1), Retrieved Oct. 2, 2013, from Espacenet.
 English-language Machine Translation for German Publication No. 4432184 (C1), Retrieved Oct. 2, 2013, from Espacenet.
 English-language Abstract for French Publication No. 59368, Retrieved Oct. 3, 2013, from Espacenet.
 English-language Abstract for German Publication No. 9309142 (U1), Retrieved Oct. 1, 2013, from Espacenet.
 English-language Machine Translation for German Publication No. 9309142 (U1), Retrieved Oct. 1, 2013, from Espacenet.
 Information Disclosure Statement Transmittal Letter filed herewith, Oct. 9, 2013, 3 pages.

* cited by examiner

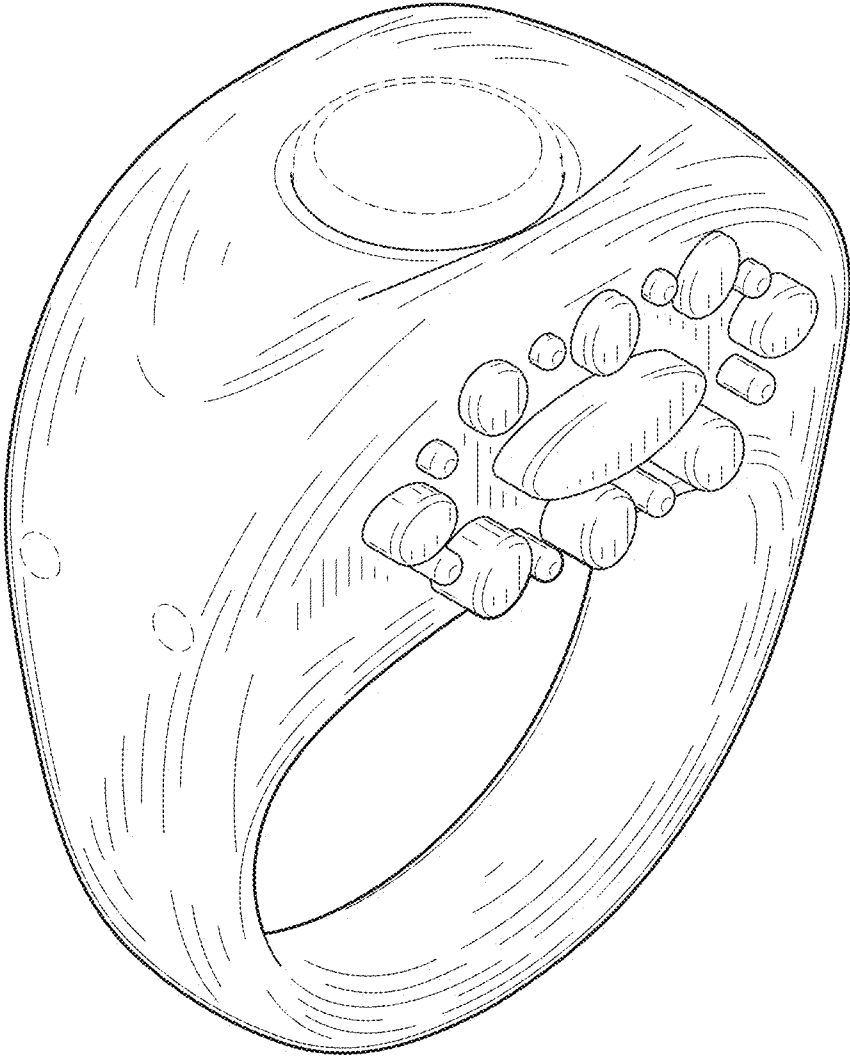

FIG.1

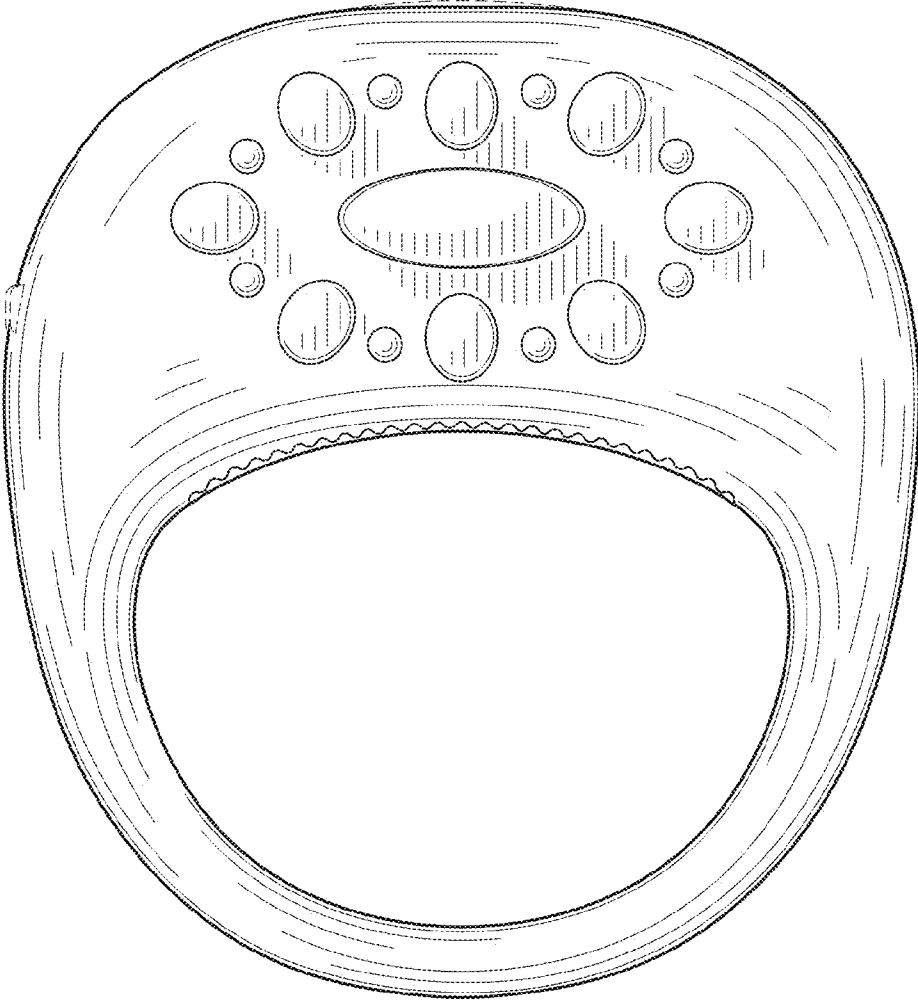

FIG.2

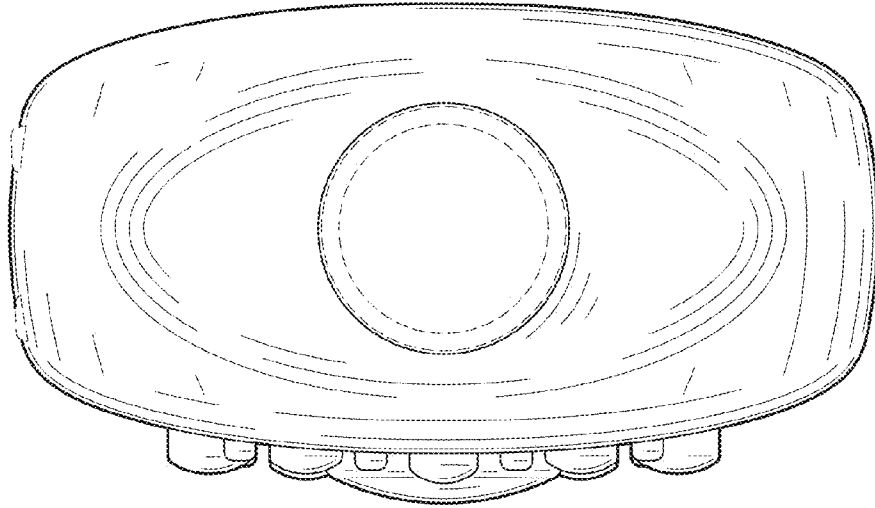

FIG. 3

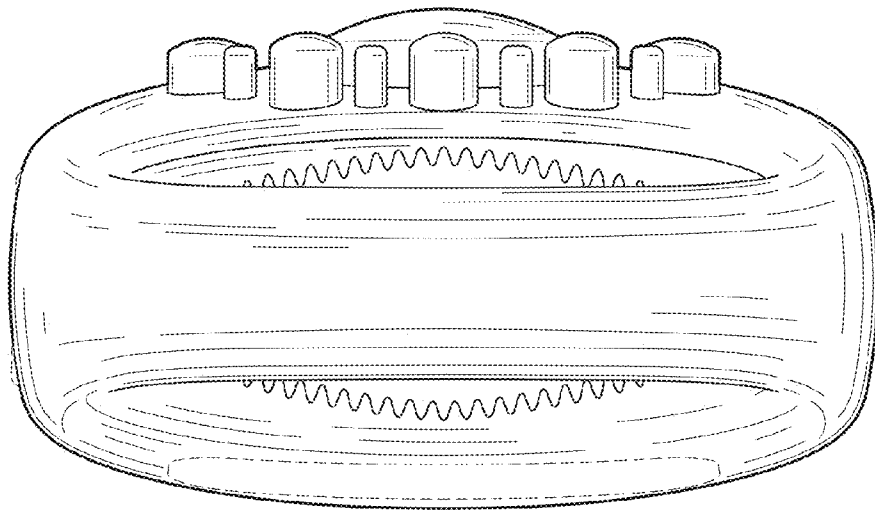

FIG. 4

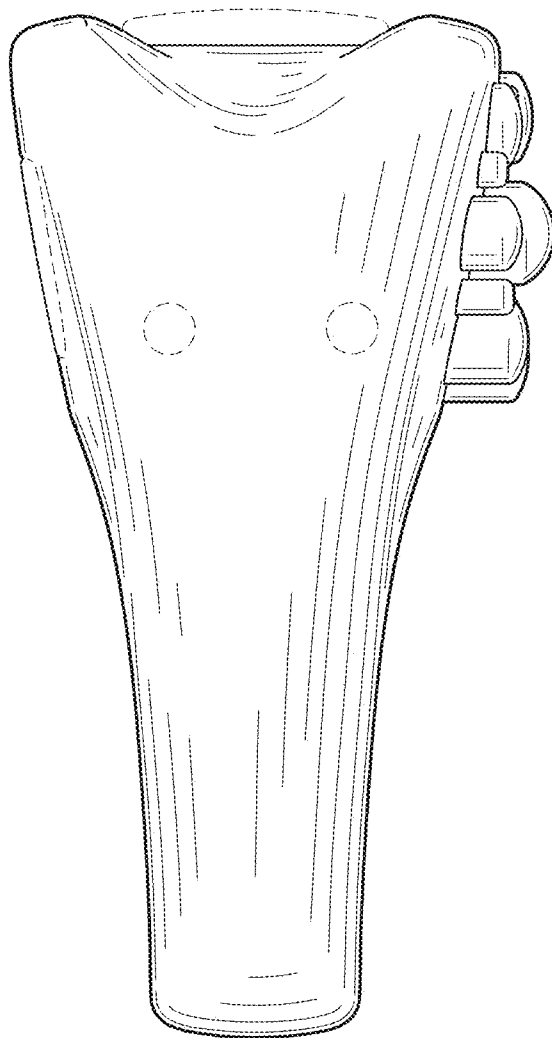

FIG.5

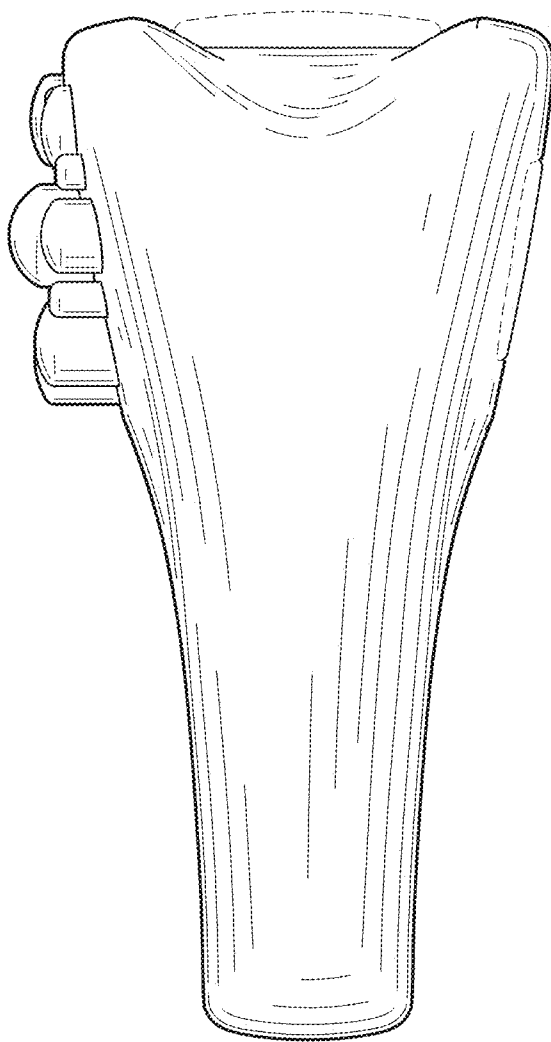

FIG.6

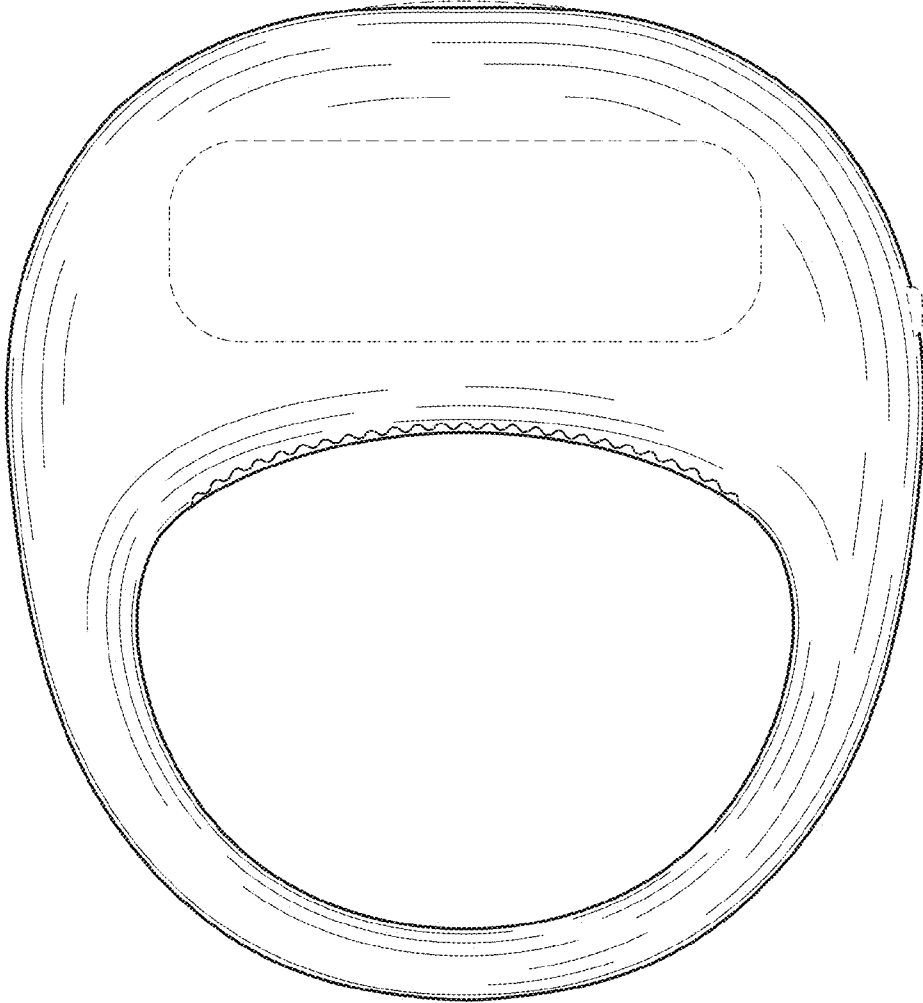

FIG. 7



FIG. 8

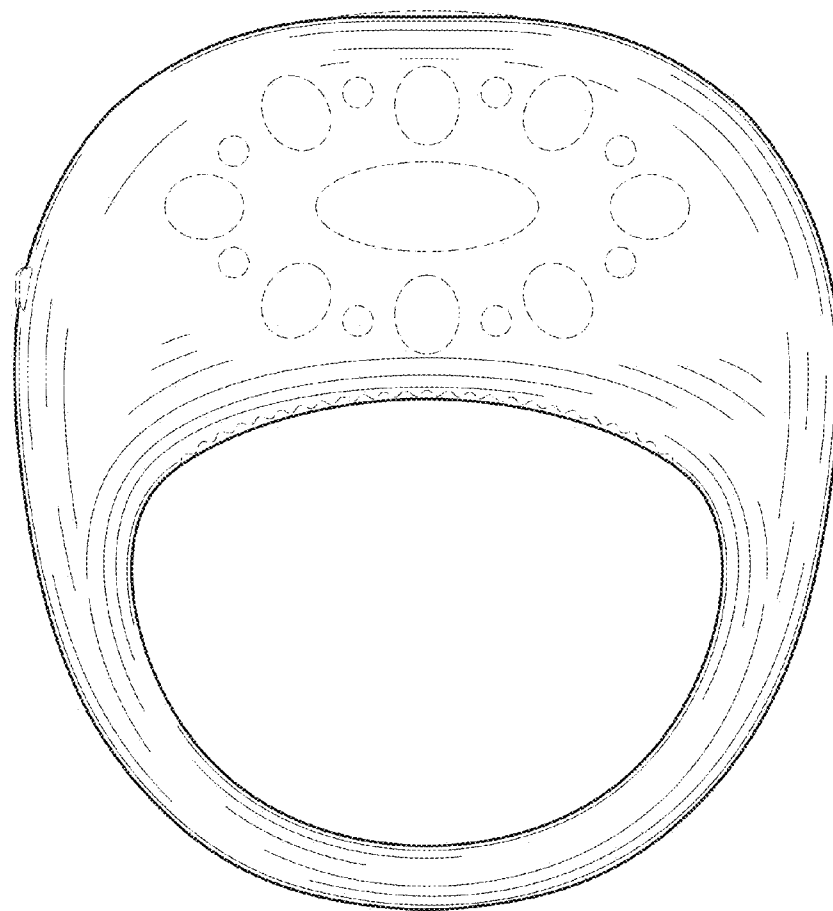

FIG. 9

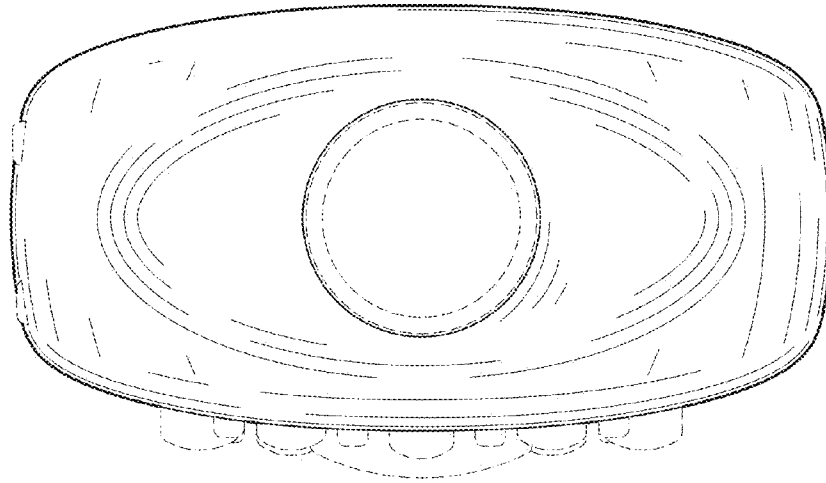

FIG. 10

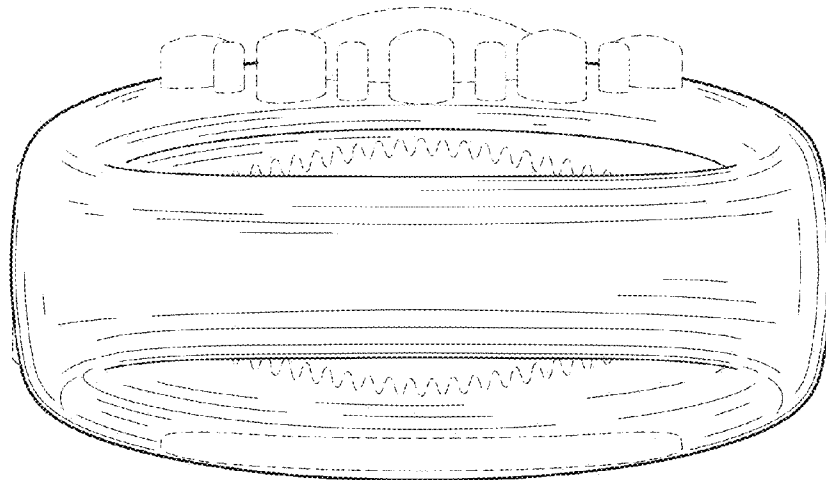

FIG. 11

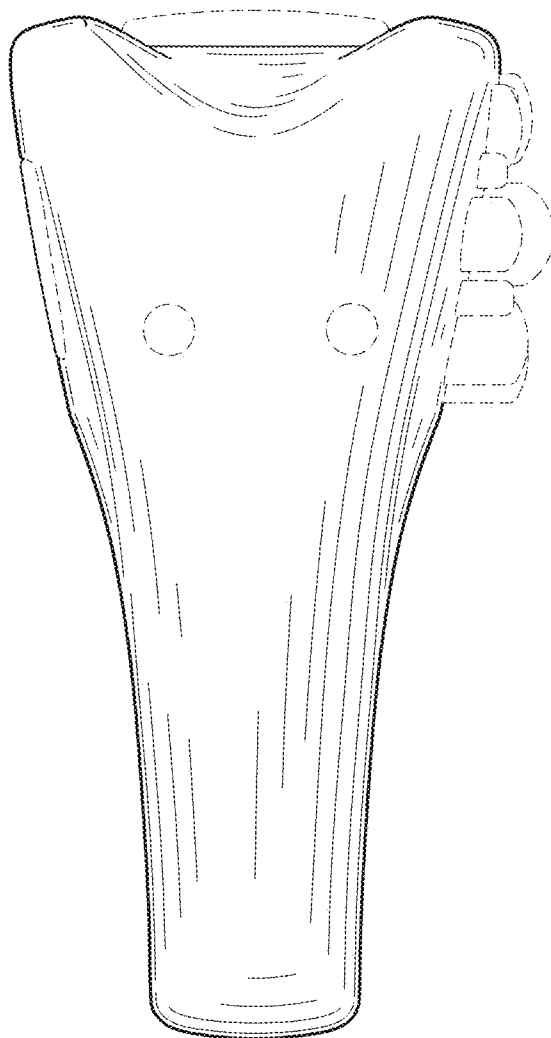

FIG.12

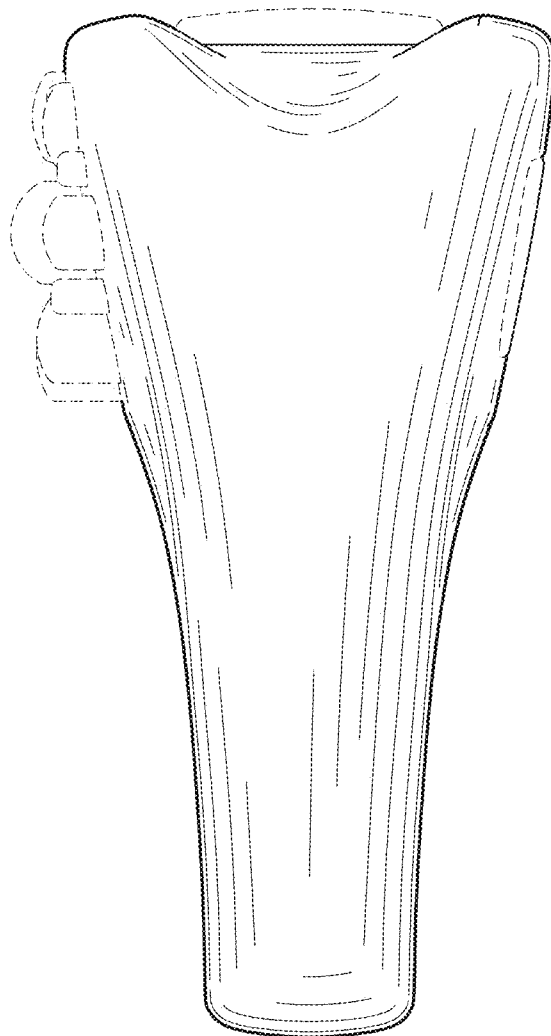

FIG.13

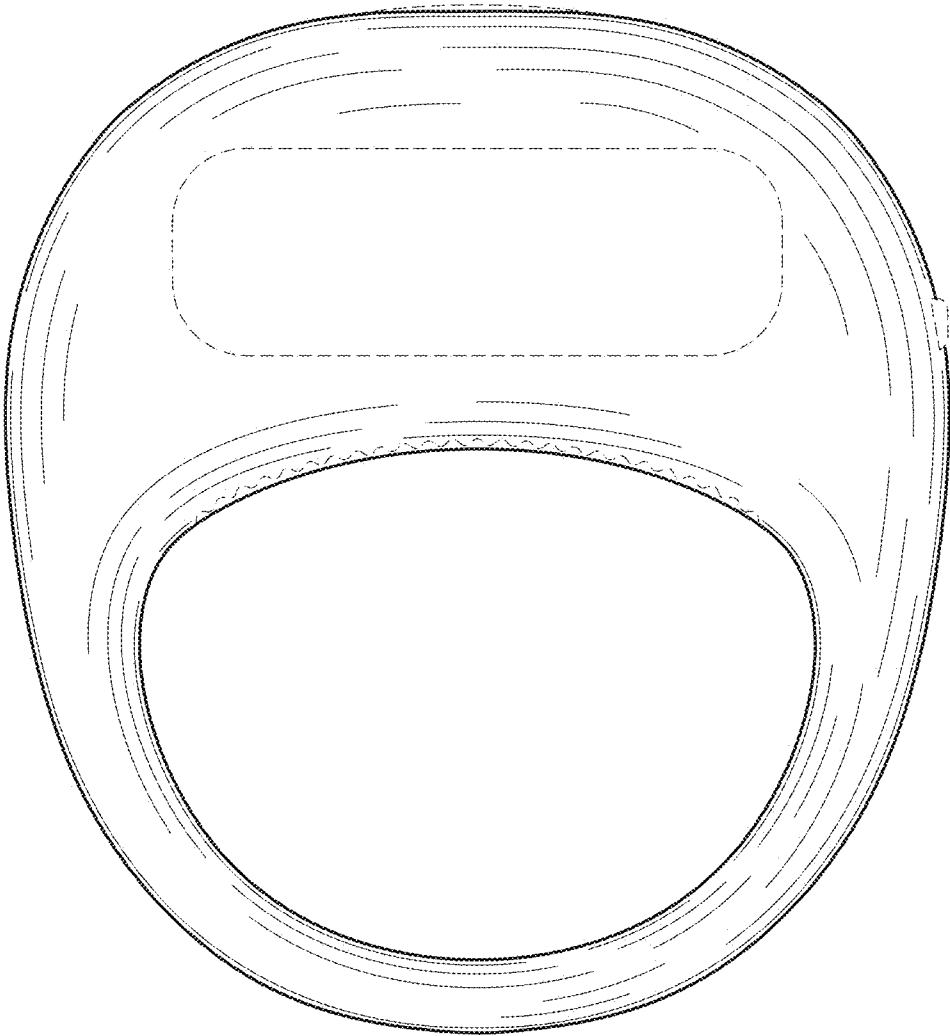

FIG.14