



US00D396242S

United States Patent [19]

[11] **Patent Number:** **Des. 396,242**

Ito

[45] **Date of Patent:** ****Jul. 21, 1998**

[54] **CAMERA**

D. 352,519	11/1994	Ito et al.	D16/209
D. 360,217	7/1995	Shull et al.	D16/209
4,556,304	12/1985	Fukuda	396/448

[75] **Inventor:** **Hideki Ito, Kawasaki, Japan**

[73] **Assignee:** **Canon Kabushiki Kaisha, Tokyo, Japan**

[**] **Term:** **14 Years**

[21] **Appl. No.:** **74,802**

[22] **Filed:** **Aug. 12, 1997**

[30] **Foreign Application Priority Data**

Feb. 19, 1997 [JP] Japan 9-4719

[51] **LOC (6) Cl.** **16-01**

[52] **U.S. Cl.** **D16/209; D16/218**

[58] **Field of Search** **D16/200-209, D16/216-218; 396/448, 535, 543**

[56] **References Cited**

U.S. PATENT DOCUMENTS

D. 191,237	8/1961	Hennig et al.	D16/218
D. 313,423	1/1991	Onuma et al.	D16/209
D. 323,523	1/1992	Tanaka et al.	D16/209

OTHER PUBLICATIONS

W. Bell & Co., p. 234 (Canon's Snappy S) 1987-88.

Primary Examiner—Ted Shooman

Assistant Examiner—Adir Aronovich

Attorney, Agent, or Firm—Fitzpatrick, Cella, Harper & Scinto

[57] **CLAIM**

The ornamental design for a camera, as shown and described.

DESCRIPTION

FIG. 1 is a front view of a camera showing my new design;
 FIG. 2 is a rear view thereof;
 FIG. 3 is a top plan view thereof;
 FIG. 4 is a bottom plan view thereof;
 FIG. 5 is a left side view thereof;
 FIG. 6 is a right side view thereof; and
 FIG. 7 is a perspective view thereof.

1 Claim, 3 Drawing Sheets

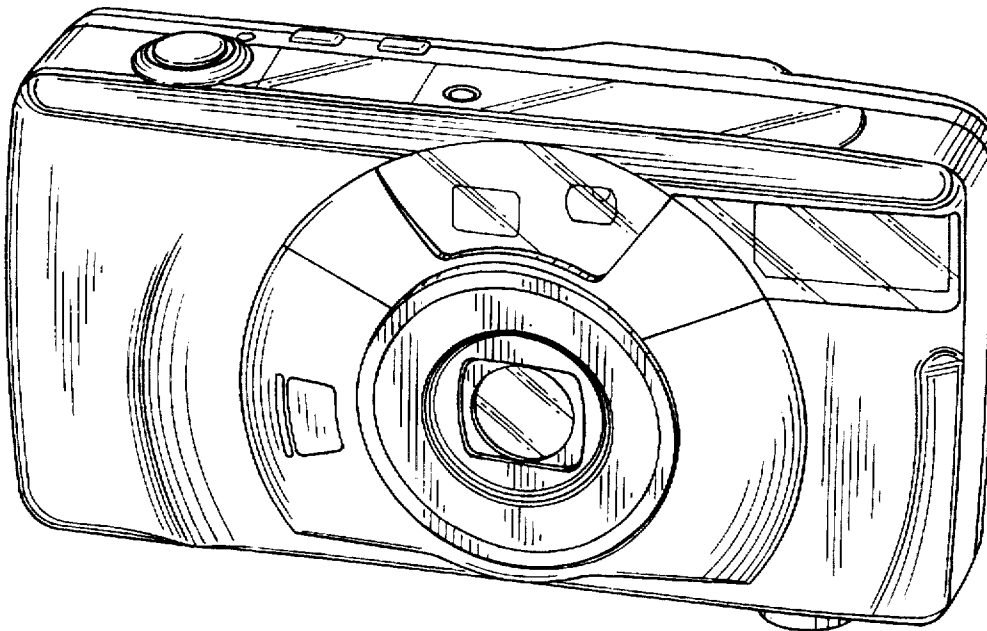

FIG. 1

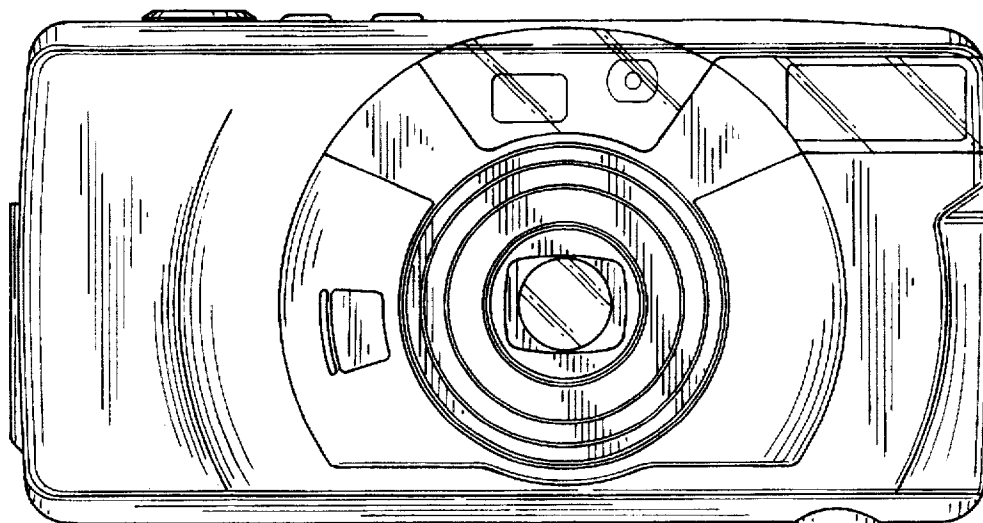

FIG. 2

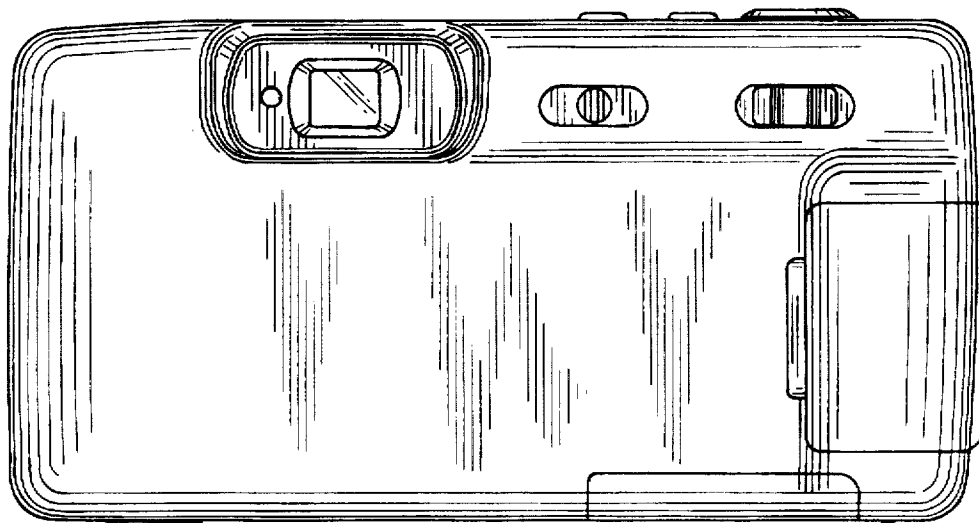

FIG. 3

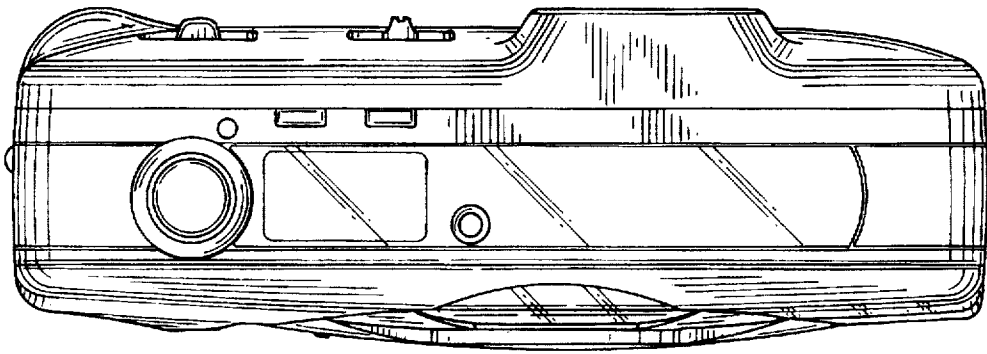

FIG. 4

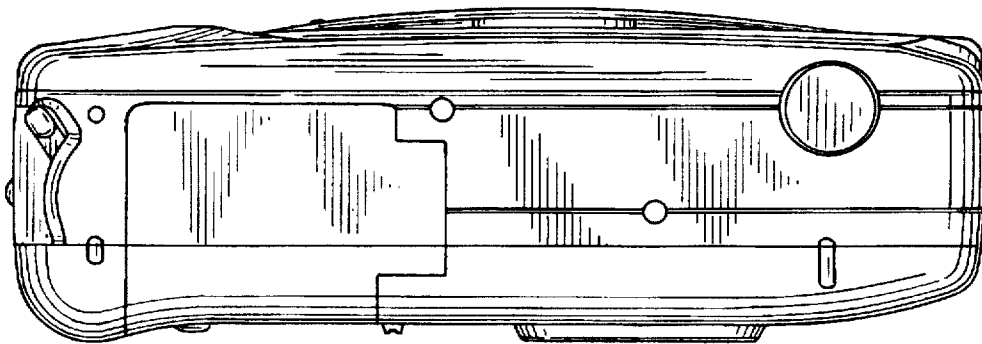

FIG. 5

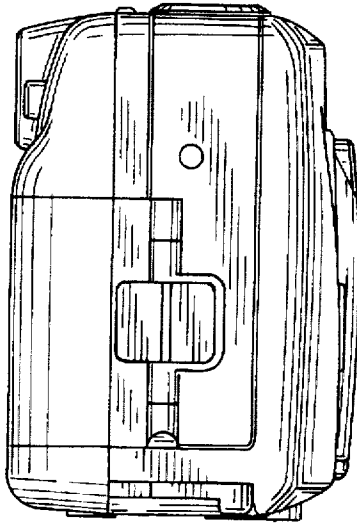

FIG. 6

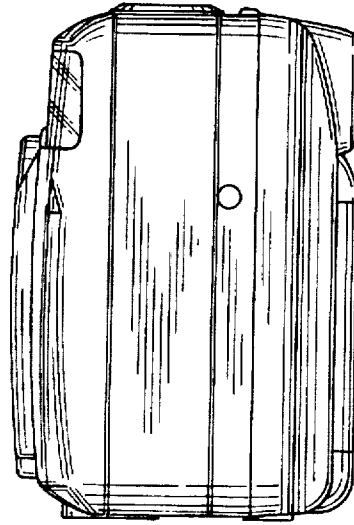

FIG. 7

