



(51) International Patent Classification:

C07D 403/14 (2006.01) A61K 31/498 (2006.01)
C07D 417/14 (2006.01) A61P 35/00 (2006.01)
A61K 31/496 (2006.01)

(21) International Application Number:

PCT/US2016/053987

(22) International Filing Date:

27 September 2016 (27.09.2016)

(25) Filing Language:

English

(26) Publication Language:

English

(30) Priority Data:

62/233,597 28 September 2015 (28.09.2015) US

(71) Applicant: ARAXES PHARMA LLC [US/US]; 11119 North Torrey Pines Road, Suite 125, La Jolla, California 92037 (US).

(72) Inventors: LI, Liansheng; 13569 Arroyo Dale Lane, San Diego, California 92130 (US). FENG, Jun; 6160 Quail Run Street, San Diego, California 92130 (US). LONG, Yun, Oliver; 10763 Santa Tomasa Avenue, San Diego, California 92127 (US). REN, Pingda; 5534 Havenridge Way, San Diego, California 92130 (US). LIU, Yi; 4841 Barlows Landing Cove, San Diego, California 92130 (US).

(74) Agents: HARWOOD, Eric, A. et al.; Seed Intellectual Property Law Group LLP, Suite 5400, 701 Fifth Avenue, Seattle, Washington 98104-7064 (US).

(81) Designated States (unless otherwise indicated, for every kind of national protection available): AE, AG, AL, AM,

AO, AT, AU, AZ, BA, BB, BG, BH, BN, BR, BW, BY, BZ, CA, CH, CL, CN, CO, CR, CU, CZ, DE, DJ, DK, DM, DO, DZ, EC, EE, EG, ES, FI, GB, GD, GE, GH, GM, GT, HN, HR, HU, ID, IL, IN, IR, IS, JP, KE, KG, KN, KP, KR, KW, KZ, LA, LC, LK, LR, LS, LU, LY, MA, MD, ME, MG, MK, MN, MW, MX, MY, MZ, NA, NG, NI, NO, NZ, OM, PA, PE, PG, PH, PL, PT, QA, RO, RS, RU, RW, SA, SC, SD, SE, SG, SK, SL, SM, ST, SV, SY, TH, TJ, TM, TN, TR, TT, TZ, UA, UG, US, UZ, VC, VN, ZA, ZM, ZW.

(84) Designated States (unless otherwise indicated, for every kind of regional protection available): ARIPO (BW, GH, GM, KE, LR, LS, MW, MZ, NA, RW, SD, SL, ST, SZ, TZ, UG, ZM, ZW), Eurasian (AM, AZ, BY, KG, KZ, RU, TJ, TM), European (AL, AT, BE, BG, CH, CY, CZ, DE, DK, EE, ES, FI, FR, GB, GR, HR, HU, IE, IS, IT, LT, LU, LV, MC, MK, MT, NL, NO, PL, PT, RO, RS, SE, SI, SK, SM, TR), OAPI (BF, BJ, CF, CG, CI, CM, GA, GN, GQ, GW, KM, ML, MR, NE, SN, TD, TG).

Declarations under Rule 4.17:

- as to applicant's entitlement to apply for and be granted a patent (Rule 4.17(ii))
- as to the applicant's entitlement to claim the priority of the earlier application (Rule 4.17(iii))

Published:

- with international search report (Art. 21(3))

(54) Title: INHIBITORS OF KRAS G12C MUTANT PROTEINS

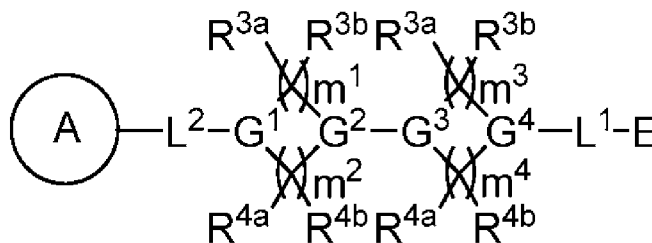

(I)

(57) Abstract: Compounds having activity as inhibitors of G12C mutant KRAS protein are provided. The compounds have the following structure (I): (I) or a pharmaceutically acceptable salt, tautomer, stereoisomer or prodrug thereof, wherein A, R^{3a}, R^{3b}, R^{4a}, R^{4b}, G¹, G², G³, G⁴, m¹, m², m³, m⁴, L¹, L² and E are as defined herein. Methods associated with preparation and use of such compounds, pharmaceutical compositions comprising such compounds and methods to modulate the activity of G12C mutant KRAS protein for treatment of disorders, such as cancer, are also provided.

INHIBITORS OF KRAS G12C MUTANT PROTEINS

BACKGROUND

Technical Field

The present invention is generally directed to novel compounds and
5 methods for their preparation and use as therapeutic or prophylactic agents, for example
for treatment of cancer.

Description of the Related Art

RAS represents a group of closely related monomeric globular proteins
of 189 amino acids (21 kDa molecular mass) which are associated with the plasma
10 membrane and which bind either GDP or GTP. RAS acts as a molecular switch. When
RAS contains bound GDP, it is in the resting or off position and is "inactive". In
response to exposure of the cell to certain growth promoting stimuli, RAS is induced to
exchange its bound GDP for a GTP. With GTP bound, RAS is "switched on" and is
able to interact with and activate other proteins (its "downstream targets"). The RAS
15 protein itself has a very low intrinsic ability to hydrolyze GTP back to GDP, thus
turning itself into the off state. Switching RAS off requires extrinsic proteins termed
GTPase-activating proteins (GAPs) that interact with RAS and greatly accelerate the
conversion of GTP to GDP. Any mutation in RAS which affects its ability to interact
with GAP or to convert GTP back to GDP will result in a prolonged activation of the
20 protein and consequently a prolonged signal to the cell telling it to continue to grow and
divide. Because these signals result in cell growth and division, overactive RAS
signaling may ultimately lead to cancer.

Structurally, RAS proteins contain a G domain which is responsible for
the enzymatic activity of RAS - the guanine nucleotide binding and the hydrolysis
25 (GTPase reaction). It also contains a C-terminal extension, known as the CAAX box,
which may be post-translationally modified and is responsible for targeting the protein
to the membrane. The G domain is approximately 21-25 kDa in size and it contains a

phosphate binding loop (P-loop). The P-loop represents the pocket where the nucleotides are bound in the protein, and this is the rigid part of the domain with conserved amino acid residues which are essential for nucleotide binding and hydrolysis (Glycine 12, Threonine 26 and Lysine 16). The G domain also contains the so called Switch I (residues 30-40) and Switch II (residues 60-76) regions, both of which are the dynamic parts of the protein which are often represented as the “spring-loaded” mechanism because of their ability to switch between the resting and loaded state. The key interaction is the hydrogen bonds formed by Threonine-35 and glycine-60 with the γ -phosphate of GTP which maintain Switch 1 and Switch 2 regions respectively in their active conformation. After hydrolysis of GTP and release of phosphate, these two relax into the inactive GDP conformation.

The most notable members of the RAS subfamily are HRAS, KRAS and NRAS, mainly for being implicated in many types of cancer. However, there are many other members including DIRAS1; DIRAS2; DIRAS3; ERAS; GEM; MRAS; NKIRAS1; NKIRAS2; NRAS; RALA; RALB; RAP1A; RAP1B; RAP2A; RAP2B; RAP2C; RASD1; RASD2; RASL10A; RASL10B; RASL11A; RASL11B; RASL12; REM1; REM2; RERG; RERGL; RRAD; RRAS and RRAS2.

Mutations in any one of the three main isoforms of RAS (HRAS, NRAS, or KRAS) genes are among the most common events in human tumorigenesis. About 30% of all human tumors are found to carry some mutation in RAS genes. Remarkably, KRAS mutations are detected in 25-30% of tumors. By comparison, the rates of oncogenic mutation occurring in the NRAS and HRAS family members are much lower (8% and 3% respectively). The most common KRAS mutations are found at residue G12 and G13 in the P-loop and at residue Q61.

G12C is a frequent mutation of KRAS gene (glycine-12 to cysteine). This mutation had been found in about 13% of cancer occurrences, about 43% of lung cancer occurrences, and in almost 100% of MYH-associated polyposis (familial colon cancer syndrome). However targeting this gene with small molecules is a challenge.

Accordingly, while progress has been made in this field, there remains a need in the art for improved compounds and methods for treatment of cancer, for

example by inhibition of KRAS, HRAS or NRAS. The present invention fulfills this need and provides further related advantages.

BRIEF SUMMARY

In brief, the present invention provides compounds, including
 5 stereoisomers, pharmaceutically acceptable salts, tautomers and prodrugs thereof, which are capable of modulating G12C mutant KRAS, HRAS and/or NRAS proteins. In some instances, the compounds act as electrophiles which are capable of forming a covalent bond with the cysteine residue at position 12 of a KRAS, HRAS or NRAS G12C mutant protein. Methods for use of such compounds for treatment of various
 10 diseases or conditions, such as cancer, are also provided.

In one embodiment, compounds having the following structure (I) are provided:

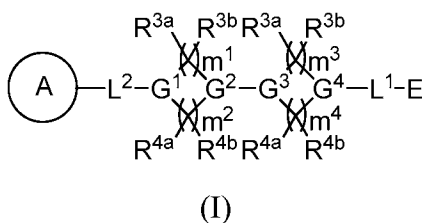

15 or a pharmaceutically acceptable salt, tautomer, stereoisomer or prodrug thereof, wherein A, R^{3a}, R^{3b}, R^{4a}, R^{4b}, G¹, G², G³, G⁴, m¹, m², m³, m⁴, L¹, L² and E are as defined herein. Pharmaceutical compositions comprising one or more of the foregoing compounds of Structure (I) and a pharmaceutically acceptable carrier are also provided in various other embodiments.

20 In other embodiments, the present invention provides a method for treatment of cancer, the method comprising administering an effective amount of a pharmaceutical composition comprising any one or more of the compounds of structure (I) to a subject in need thereof.

Other provided methods include a method for regulating activity of a
 25 KRAS, HRAS or NRAS G12C mutant protein, the method comprising reacting the KRAS, HRAS or NRAS G12C mutant protein with any one of the compounds of structure (I). In other embodiments, a method for inhibiting proliferation of a cell

population, the method comprising contacting the cell population with any one of the compounds of structure (I) is also provided.

In other embodiments, the invention is directed to a method for treating a disorder mediated by a KRAS, HRAS or NRAS G12C mutation in a subject in need thereof, the method comprising:

determining if the subject has a KRAS, HRAS or NRAS G12C mutation; and

if the subject is determined to have the KRAS, HRAS or NRAS G12C mutation, then administering to the subject a therapeutically effective amount of a pharmaceutical composition comprising any one or more compounds of structure (I).

In still more embodiments, the invention is directed to a method for preparing a labeled KRAS, HRAS or NRAS G12C mutant protein, the method comprising reacting the KRAS, HRAS or NRAS G12C mutant with a compound of structure (I), to result in the labeled KRAS, HRAS or NRAS G12C protein.

These and other aspects of the invention will be apparent upon reference to the following detailed description.

BRIEF DESCRIPTION OF THE DRAWINGS

In the figures, identical reference numbers identify similar elements. The sizes and relative positions of elements in the figures are not necessarily drawn to scale and some of these elements are arbitrarily enlarged and positioned to improve figure legibility. Further, the particular shapes of the elements as drawn are not intended to convey any information regarding the actual shape of the particular elements, and have been solely selected for ease of recognition in the figures.

Fig. 1 illustrates the enzymatic activity of RAS.

Fig. 2 depicts a signal transduction pathway for RAS.

Fig. 3 shows some common oncogenes, their respective tumor type and cumulative mutation frequencies (all tumors).

DETAILED DESCRIPTION

In the following description, certain specific details are set forth in order to provide a thorough understanding of various embodiments of the invention.

5 However, one skilled in the art will understand that the invention may be practiced without these details.

Unless the context requires otherwise, throughout the present specification and claims, the word “comprise” and variations thereof, such as, “comprises” and “comprising” are to be construed in an open, inclusive sense, that is as “including, but not limited to”.

10 Reference throughout this specification to “one embodiment” or “an embodiment” means that a particular feature, structure or characteristic described in connection with the embodiment is included in at least one embodiment of the present invention. Thus, the appearances of the phrases “in one embodiment” or “in an embodiment” in various places throughout this specification are not necessarily all referring to the same embodiment. Furthermore, the particular features, structures, or characteristics may be combined in any suitable manner in one or more embodiments.

Unless defined otherwise, all technical and scientific terms used herein have the same meaning as is commonly understood by one of skill in the art to which this invention belongs. As used in the specification and claims, the singular form “a”, “an” and “the” include plural references unless the context clearly dictates otherwise.

20 “Amidinyl” refers to a radical of the form $-(C=NR_a)NR_bR_c$, wherein R_a , R_b and R_c are each independently H or C_1 - C_6 alkyl.

“Amino” refers to the $-NH_2$ radical.

“Aminylsulfone” refers to the $-S(O)_2NH_2$ radical.

25 “Carboxy” or “carboxyl” refers to the $-CO_2H$ radical.

“Cyano” refers to the $-CN$ radical.

“Guanidinyl” refers to a radical of the form $-NR_d(C=NR_a)NR_bR_c$, wherein R_a , R_b , R_c and R_d are each independently H or C_1 - C_6 alkyl.

“Hydroxy” or “hydroxyl” refers to the $-OH$ radical.

30 “Imino” refers to the $=NH$ substituent.

“Nitro” refers to the -NO₂ radical.

“Oxo” refers to the =O substituent.

“Thioxo” refers to the =S substituent.

“Alkyl” refers to a straight or branched hydrocarbon chain radical
5 consisting solely of carbon and hydrogen atoms, which is saturated or unsaturated (*i.e.*,
contains one or more double and/or triple bonds), having from one to twelve carbon
atoms (C₁-C₁₂ alkyl), preferably one to eight carbon atoms (C₁-C₈ alkyl) or one to six
carbon atoms (C₁-C₆ alkyl), and which is attached to the rest of the molecule by a single
bond, *e.g.*, methyl, ethyl, *n*-propyl, 1-methylethyl (*iso*-propyl), *n*-butyl, *n*-pentyl,
10 1,1-dimethylethyl (*t*-butyl), 3-methylhexyl, 2-methylhexyl, ethenyl, prop-1-enyl,
but-1-enyl, pent-1-enyl, penta-1,4-dienyl, ethynyl, propynyl, butynyl, pentynyl,
hexynyl, and the like. Alkyl includes alkenyls (one or more carbon-carbon double
bonds) and alkynyls (one or more carbon-carbon triple bonds such as ethynyl and the
like). “Amidinylalkyl” refers to an alkyl group comprising at least one amidinyl
15 substituent. “Guanidinylalkyl” refers to an alkyl group comprising at least one
guanidinyl substituent. Unless stated otherwise specifically in the specification, an
alkyl, amidinylalkyl and/or guanidinylalkyl group is optionally substituted.

“Alkylene” or “alkylene chain” refers to a straight or branched divalent
hydrocarbon chain linking the rest of the molecule to a radical group, consisting solely
20 of carbon and hydrogen, which is saturated or unsaturated (*i.e.*, contains one or more
double and/or triple bonds), and having from one to twelve carbon atoms, *e.g.*,
methylene, ethylene, propylene, *n*-butylene, ethenylene, propenylene, *n*-butenylene,
propynylene, *n*-butynylene, and the like. The alkylene chain is attached to the rest of
the molecule through a single or double bond and to the radical group through a single
25 or double bond. The points of attachment of the alkylene chain to the rest of the
molecule and to the radical group can be through one carbon or any two carbons within
the chain. Unless stated otherwise specifically in the specification, an alkylene chain is
optionally substituted.

“Alkylcycloalkyl” refers to a radical of the formula -R_bR_d where R_b is
30 cycloalkyl chain as defined herein and R_d is an alkyl radical as defined above. Unless

stated otherwise specifically in the specification, a alkylcycloalkyl group is optionally substituted.

“Alkoxy” refers to a radical of the formula $-OR_a$ where R_a is an alkyl radical as defined above containing one to twelve carbon atoms. “Amidinylalkoxy” refers to an alkoxy group comprising at least one amidinyl substituent on the alkyl group. “Guanidinylalkoxy” refers to an alkoxy group comprising at least one guanidinyl substituent on the alkyl group. “Alkylcarbonylaminyalkoxy” refers to an alkoxy group comprising at least one alkylcarbonylaminy substituent on the alkyl group. “Heterocyclalkoxy” refers to an alkoxy group comprising at least one heterocycl substituent on the alkyl group. “Heteroarylalkoxy” refers to an alkoxy group comprising at least one heteroaryl substituent on the alkyl group. “Aminylalkoxy” refers to an alkoxy group comprising at least one substituent of the form $-NR_aR_b$, where R_a and R_b are each independently H or C_1-C_6 alkyl, on the alkyl group. Unless stated otherwise specifically in the specification, an alkoxy, amidinylalkoxy, guanidinylalkoxy, alkylcarbonylaminy, heterocyclalkoxy, heteroarylalkoxy and/or aminylalkoxy group is optionally substituted.

“Alkoxyalkyl” refers to a radical of the formula $-R_bOR_a$ where R_a is an alkyl radical as defined above containing one to twelve carbon atoms and R_b is an alkylene radical as defined above containing one to twelve carbon atoms. Unless stated otherwise specifically in the specification, an alkoxyalkyl group is optionally substituted.

“Alkoxycarbonyl” refers to a radical of the formula $-C(=O)OR_a$ where R_a is an alkyl radical as defined above containing one to twelve carbon atoms. Unless stated otherwise specifically in the specification, an alkoxycarbonyl group is optionally substituted.

“Aryloxy” refers to a radical of the formula $-OR_a$ where R_a is an aryl radical as defined herein. Unless stated otherwise specifically in the specification, an aryloxy group is optionally substituted.

“Alkylaminy” refers to a radical of the formula $-NHR_a$ or $-NR_aR_a$ where each R_a is, independently, an alkyl radical as defined above containing one to twelve

carbon atoms. A “haloalkylaminyl” group is an alkylaminyl group comprising at least one halo substituent on the alkyl group. A “hydroxylalkylaminyl” group is an alkylaminyl group comprising at least one hydroxyl substituent on the alkyl group. A “amidinylalkylaminyl” group is an alkylaminyl group comprising at least one amidinyl substituent on the alkyl group. A “guanidinylalkylaminyl” group is an alkylaminyl group comprising at least one guanidinyl substituent on the alkyl group. Unless stated otherwise specifically in the specification, an alkylaminyl, haloalkylaminyl, hydroxylalkylaminyl, amidinylalkylaminyl and/or guanidinylalkylaminyl group is optionally substituted.

10 “Aminylalkyl” refers to an alkyl group comprising at least one aminyl substituent ($-NR_aR_b$ wherein R_a and R_b are each independently H or C_1 - C_6 alkyl). The aminyl substituent can be on a tertiary, secondary or primary carbon. Unless stated otherwise specifically in the specification, an aminylalkyl group is optionally substituted.

15 “Aminylalkylaminyl” refers to a radical of the formula $-NR_aR_b$ wherein R_a is H or C_1 - C_6 alkyl and R_b is aminylalkyl. Unless stated otherwise specifically in the specification, an aminylalkylaminyl group is optionally substituted.

Alkylcarbonylaminyll” refers to a radical of the formula $-NH(C=O)R_a$ where R_a is an alkyl radical as defined above containing one to twelve carbon atoms. Unless stated otherwise specifically in the specification, an alkylcarbonylaminyll group is optionally substituted. An alkenylcarbonylaminyll is an alkylcarbonylaminyll containing at least one carbon-carbon double bond. An alkenylcarbonylaminyll group is optionally substituted.

25 “Alkylaminylalkyl” refers to an alkyl group comprising at least one alkylaminyl substituent. The alkylaminyl substituent can be on a tertiary, secondary or primary carbon. Unless stated otherwise specifically in the specification, an alkylaminylalkyl group is optionally substituted.

30 “Aminylcarbonyl” refers to a radical of the formula $-C(=O)NH_2$. Unless stated otherwise specifically in the specification, an aminylcarbonyl group is optionally substituted.

Alkylaminylcarbonyl” refers to a radical of the formula $-C(=O)NR_aR_b$, where R_a and R_b are each independently H or alkyl, provided at least one of R_a or R_b is alkyl. Unless stated otherwise specifically in the specification, an alkylaminylcarbonyl group is optionally substituted.

5 “Aminylcarbonylalkyl” refers to a radical of the formula $-R_cC(=O)NR_aR_b$, where R_a and R_b are each independently H or alkyl and R_c is alkylene. Unless stated otherwise specifically in the specification, an aminylcarbonylalkyl group is optionally substituted.

10 “Aminylcarbonylcycloalkylalkyl” refers to a radical of the formula $-R_cC(=O)NR_aR_b$, where R_a and R_b are each independently H or alkyl and R_c is cycloalkyl. Unless stated otherwise specifically in the specification, an aminylcarbonylcycloalkyl group is optionally substituted.

15 “Aryl” refers to a hydrocarbon ring system radical comprising hydrogen, 6 to 18 carbon atoms and at least one aromatic ring. For purposes of this invention, the aryl radical is a monocyclic, bicyclic, tricyclic or tetracyclic ring system, which may include fused or bridged ring systems. Aryl radicals include, but are not limited to, aryl radicals derived from aceanthrylene, acenaphthylene, acephenanthrylene, anthracene, azulene, benzene, chrysene, fluoranthene, fluorene, *as*-indacene, *s*-indacene, indane, indene, naphthalene, phenalene, phenanthrene, pleiadene, pyrene, and triphenylene.

20 Unless stated otherwise specifically in the specification, the term “aryl” or the prefix “ar-“ (such as in “aralkyl”) is meant to include aryl radicals that are optionally substituted.

 “Aralkyl” refers to a radical of the formula $-R_b-R_c$ where R_b is an alkylene chain as defined above and R_c is one or more aryl radicals as defined above, for example, benzyl, diphenylmethyl and the like. Unless stated otherwise specifically

25 in the specification, an aralkyl group is optionally substituted.

 “Carboxyalkyl” refers to a radical of the formula $-R_b-R_c$ where R_b is an alkylene chain as defined above and R_c is a carboxy group as defined above. Unless

30 stated otherwise specifically in the specification, carboxyalkyl group is optionally substituted.

“Cyanoalkyl” refers to a radical of the formula $-R_b-R_c$ where R_b is an alkylene chain as defined above and R_c is a cyano group as defined above. Unless stated otherwise specifically in the specification, a cyanoalkyl group is optionally substituted.

5 “Cycloalkyl” or “carbocyclic ring” refers to a stable non-aromatic monocyclic or polycyclic hydrocarbon radical consisting solely of carbon and hydrogen atoms, which may include fused or bridged ring systems, having from three to fifteen carbon atoms, preferably having from three to ten carbon atoms, and which is saturated or unsaturated and attached to the rest of the molecule by a single bond. Monocyclic
10 radicals include, for example, cyclopropyl, cyclobutyl, cyclopentyl, cyclohexyl, cycloheptyl, and cyclooctyl. Polycyclic radicals include, for example, adamantyl, norbornyl, decalanyl, 7,7-dimethyl-bicyclo[2.2.1]heptanyl, and the like. A “cycloalkenyl” is a cycloalkyl comprising one or more carbon-carbon double bonds within the ring. Unless otherwise stated specifically in the specification, a cycloalkyl
15 (or cycloalkenyl) group is optionally substituted.

“Cyanocycloalkyl” refers to a radical of the formula $-R_b-R_c$ where R_b is cycloalkylene chain and R_c is a cyano group as defined above. Unless stated otherwise specifically in the specification, a cyanocycloalkyl group is optionally substituted.

“Cycloalkylaminylcarbonyl” refers to a radical of the formula $-C(=O)NR_aR_b$, where R_a and R_b are each independently H or cycloalkyl, provided at
20 least one of R_a or R_b is cycloalkyl. Unless stated otherwise specifically in the specification, a cycloalkylaminylcarbonyl group is optionally substituted.

“Cycloalkylalkyl” refers to a radical of the formula $-R_bR_d$ where R_b is an alkylene chain as defined above and R_d is a cycloalkyl radical as defined above. Unless
25 stated otherwise specifically in the specification, a cycloalkylalkyl group is optionally substituted.

“Fused” refers to any ring structure described herein which is fused to an existing ring structure in the compounds of the invention. When the fused ring is a heterocyclyl ring or a heteroaryl ring, any carbon atom on the existing ring structure

which becomes part of the fused heterocyclyl ring or the fused heteroaryl ring is replaced with a nitrogen atom.

“Halo” or “halogen” refers to bromo, chloro, fluoro or iodo.

“Haloalkyl” refers to an alkyl radical, as defined above, that is substituted by one or more halo radicals, as defined above, *e.g.*, trifluoromethyl, difluoromethyl, trichloromethyl, 2,2,2-trifluoroethyl, 1,2-difluoroethyl, 3-bromo-2-fluoropropyl, 1,2-dibromoethyl, and the like. Unless stated otherwise specifically in the specification, a haloalkyl group is optionally substituted.

“Halolkoxy” refers to a radical of the formula $-OR_a$ where R_a is a haloalkyl radical as defined herein containing one to twelve carbon atoms. Unless stated otherwise specifically in the specification, a haloalkoxy group is optionally substituted.

“Heterocyclyl” or “heterocyclic ring” refers to a stable 3- to 18-membered non-aromatic ring radical which consists of two to twelve carbon atoms and from one to six heteroatoms selected from the group consisting of nitrogen, oxygen and sulfur. Unless stated otherwise specifically in the specification, the heterocyclyl radical is a monocyclic, bicyclic, tricyclic or tetracyclic ring system, which may include fused or bridged ring systems; and the nitrogen, carbon or sulfur atoms in the heterocyclyl radical is optionally oxidized; the nitrogen atom is optionally quaternized; and the heterocyclyl radical is partially or fully saturated. Examples of such heterocyclyl radicals include, but are not limited to, dioxolanyl, thienyl[1,3]dithianyl, decahydroisoquinolyl, imidazolyl, imidazolidinyl, isothiazolidinyl, isoxazolidinyl, morpholyl, octahydroindolyl, octahydroisoindolyl, 2-oxopiperazinyl, 2-oxopiperidinyl, 2-oxopyrrolidinyl, oxazolidinyl, piperidinyl, piperazinyl, 4-piperidonyl, pyrrolidinyl, pyrazolidinyl, quinuclidinyl, thiazolidinyl, tetrahydrofuryl, trithianyl, tetrahydropyranlyl, thiomorpholyl, thiamorpholyl, 1-oxo-thiomorpholyl, and 1,1-dioxo-thiomorpholyl. Unless stated otherwise specifically in the specification. “Heterocyclyloxy” refers to a heterocyclyl group bound to the remainder of the molecule via an oxygen bond (-O-). “Heterocyclylaminyl” refers to a heterocyclyl group bound to the remainder of the molecule via a nitrogen bond ($-NR_a-$,

where R_a is H or C_1 - C_6 alkyl). Unless stated otherwise specifically in the specification, a heterocyclyl, heterocyclyloxy and/or heterocyclaminyl group is optionally substituted.

“*N*-heterocyclyl” refers to a heterocyclyl radical as defined above
5 containing at least one nitrogen and where the point of attachment of the heterocyclyl radical to the rest of the molecule is through a nitrogen atom in the heterocyclyl radical. Unless stated otherwise specifically in the specification, a *N*-heterocyclyl group is optionally substituted.

“Heterocyclylalkyl” refers to a radical of the formula $-R_bR_c$ where R_b is
10 an alkylene chain as defined above and R_c is a heterocyclyl radical as defined above, and if the heterocyclyl is a nitrogen-containing heterocyclyl, the heterocyclyl is optionally attached to the alkyl radical at the nitrogen atom. Unless stated otherwise specifically in the specification, a heterocyclylalkyl group is optionally substituted.

“Heteroaryl” refers to a 5- to 14-membered ring system radical
15 comprising hydrogen atoms, one to thirteen carbon atoms, one to six heteroatoms selected from the group consisting of nitrogen, oxygen and sulfur, and at least one aromatic ring. For purposes of this invention, the heteroaryl radical may be a monocyclic, bicyclic, tricyclic or tetracyclic ring system, which may include fused or bridged ring systems; and the nitrogen, carbon or sulfur atoms in the heteroaryl radical
20 may be optionally oxidized; the nitrogen atom may be optionally quaternized. Examples include, but are not limited to, azepinyl, acridinyl, benzimidazolyl, benzothiazolyl, benzindolyl, benzodioxolyl, benzofuranyl, benzoaxazolyl, benzothiazolyl, benzothiadiazolyl, benzo[*b*][1,4]dioxepinyl, 1,4-benzodioxanyl, benzonaphthofuranyl, benzoxazolyl, benzodioxolyl, benzodioxinyl, benzopyranyl,
25 benzopyranonyl, benzofuranyl, benzofuranonyl, benzothienyl (benzothiophenyl), benzotriazolyl, benzo[4,6]imidazo[1,2-*a*]pyridinyl, carbazolyl, cinnolinyl, dibenzofuranyl, dibenzothiophenyl, furanyl, furanonyl, isothiazolyl, imidazolyl, indazolyl, indolyl, indazolyl, isoindolyl, indolinyl, isoindolinyl, isoquinolyl, indolizinyll, isoxazolyl, naphthyridinyl, oxadiazolyl, 2-oxoazepinyl, oxazolyl, oxiranyl, 1-
30 oxidopyridinyl, 1-oxidopyrimidinyl, 1-oxidopyrazinyl, 1-oxidopyridazinyl,

1-phenyl-1*H*-pyrrolyl, phenaziny, phenothiaziny, phenoxaziny, phthalaziny, pteridinyl, purinyl, pyrrolyl, pyrazoly, pyridinyl, pyrazinyl, pyrimidinyl, pyridazinyl, quinazoliny, quinoxaliny, quinolinyl, quinuclidiny, isoquinolinyl, tetrahydroquinolinyl, thiazoly, thiadiazoly, triazolyl, tetrazoly, triazinyl, and thiophenyl (i.e. thienyl). “Heteroaryloxy” refers to a heteroaryl group bound to the remainder of the molecule via an oxygen bond (-O-). “Heteroarylaminy” refers to a heteroaryl group bound to the remainder of the molecule via a nitrogen bond (-NR_a-, where R_a is H or C₁-C₆ alkyl). Unless stated otherwise specifically in the specification, a heteroaryl, heteroaryloxy and/or heteroarylaminy group is optionally substituted.

10 “*N*-heteroaryl” refers to a heteroaryl radical as defined above containing at least one nitrogen and where the point of attachment of the heteroaryl radical to the rest of the molecule is through a nitrogen atom in the heteroaryl radical. Unless stated otherwise specifically in the specification, an *N*-heteroaryl group is optionally substituted.

15 “Heteroarylalkyl” refers to a radical of the formula -R_bR_f where R_b is an alkylene chain as defined above and R_f is a heteroaryl radical as defined above. Unless stated otherwise specifically in the specification, a heteroarylalkyl group is optionally substituted.

20 “Hydroxylalkyl” refers to an alkyl group comprising at least one hydroxyl substituent. The -OH substituent may be on a primary, secondary or tertiary carbon. Unless stated otherwise specifically in the specification, a hydroxylalkyl group is optionally substituted.

25 “Thioalkyl” refers to a radical of the formula -SR_a where R_a is an alkyl radical as defined above containing one to twelve carbon atoms. Unless stated otherwise specifically in the specification, a thioalkyl group is optionally substituted.

The term “substituted” used herein means any of the above groups (*e.g.*, alkyl, alkylene, alkylcycloalkyl, alkoxy, alkoxyalkyl, alkoxycarbonyl, aryloxy, alkylaminy, alkylcarbonylaminy, alkylaminyalkyl, aminylcarbonyl, alkylaminyalkyl, aminylcarbonylalkyl, aminylcarbonylcycloalkylalkyl, thioalkyl, aryl, aralkyl, carboxyalkyl, cyanoalkyl, cycloalkyl, cyanocycloalkyl,

cycloalkylaminylcarbonyl, cycloalkylalkyl, haloalkyl, haloalkoxy, heterocyclyl, *N*-heterocyclyl, heterocyclylalkyl, heteroaryl, *N*-heteroaryl and/or heteroarylalkyl) wherein at least one hydrogen atom is replaced by a bond to a non-hydrogen atoms such as, but not limited to: a halogen atom such as F, Cl, Br, and I; an oxygen atom in groups such as hydroxyl groups, alkoxy groups, and ester groups; a sulfur atom in groups such as thiol groups, thioalkyl groups, sulfone groups, sulfonyl groups, and sulfoxide groups; a nitrogen atom in groups such as amines, amides, alkylamines, dialkylamines, arylamines, alkylarylamines, diarylamines, *N*-oxides, imides, and enamines; a silicon atom in groups such as trialkylsilyl groups, dialkylarylsilyl groups, alkylarylsilyl groups, and triarylsilyl groups; and other heteroatoms in various other groups.

“Substituted” also means any of the above groups in which one or more hydrogen atoms are replaced by a higher-order bond (e.g., a double- or triple-bond) to a heteroatom such as oxygen in oxo, carbonyl, carboxyl, and ester groups; and nitrogen in groups such as imines, oximes, hydrazones, and nitriles. For example, “substituted” includes any of the above groups in which one or more hydrogen atoms are replaced with $-NR_gR_h$, $-NR_gC(=O)R_h$, $-NR_gC(=O)NR_gR_h$, $-NR_gC(=O)OR_h$, $-NR_gSO_2R_h$, $-OC(=O)NR_gR_h$, $-OR_g$, $-SR_g$, $-SOR_g$, $-SO_2R_g$, $-OSO_2R_g$, $-SO_2OR_g$, $=NSO_2R_g$, and $-SO_2NR_gR_h$.

“Substituted also means any of the above groups in which one or more hydrogen atoms are replaced with $-C(=O)R_g$, $-C(=O)OR_g$, $-C(=O)NR_gR_h$, $-CH_2SO_2R_g$, $-CH_2SO_2NR_gR_h$.

In the foregoing, R_g and R_h are the same or different and independently hydrogen, alkyl, alkoxy, alkylaminyl, thioalkyl, aryl, aralkyl, cycloalkyl, cycloalkylalkyl, haloalkyl, heterocyclyl, *N*-heterocyclyl, heterocyclylalkyl, heteroaryl, *N*-heteroaryl and/or heteroarylalkyl. “Substituted” further means any of the above groups in which one or more hydrogen atoms are replaced by a bond to an aminyl, cyano, hydroxyl, imino, nitro, oxo, thioxo, halo, alkyl, alkoxy, alkylaminyl, thioalkyl, aryl, aralkyl, cycloalkyl, cycloalkylalkyl, haloalkyl, heterocyclyl, *N*-heterocyclyl, heterocyclylalkyl, heteroaryl, *N*-heteroaryl and/or heteroarylalkyl group. In addition, each of the foregoing substituents may also be optionally substituted with one or more of the above substituents.

“Electrophile” or “electrophilic moiety” is any moiety capable of reacting with a nucleophile (e.g., a moiety having a lone pair of electrons, a negative charge, a partial negative charge and/or an excess of electrons, for example a –SH group). Electrophiles typically are electron poor or comprise atoms which are electron
5 poor. In certain embodiments an electrophile contains a positive charge or partial positive charge, has a resonance structure which contains a positive charge or partial positive charge or is a moiety in which delocalization or polarization of electrons results in one or more atom which contains a positive charge or partial positive charge. In some embodiments, the electrophiles comprise conjugated double bonds, for example
10 an α,β -unsaturated carbonyl or α,β -unsaturated thiocarbonyl compound.

The term "effective amount" or "therapeutically effective amount" refers to that amount of a compound described herein that is sufficient to effect the intended application including but not limited to disease treatment, as defined below. The therapeutically effective amount may vary depending upon the intended treatment
15 application (in vivo), or the subject and disease condition being treated, e.g., the weight and age of the subject, the severity of the disease condition, the manner of administration and the like, which can readily be determined by one of ordinary skill in the art. The term also applies to a dose that will induce a particular response in target cells, e.g. reduction of platelet adhesion and/or cell migration. The specific dose will
20 vary depending on the particular compounds chosen, the dosing regimen to be followed, whether it is administered in combination with other compounds, timing of administration, the tissue to which it is administered, and the physical delivery system in which it is carried.

As used herein, “treatment” or “treating” refer to an approach for
25 obtaining beneficial or desired results with respect to a disease, disorder or medical condition including but not limited to a therapeutic benefit and/or a prophylactic benefit. By therapeutic benefit is meant eradication or amelioration of the underlying disorder being treated. Also, a therapeutic benefit is achieved with the eradication or amelioration of one or more of the physiological symptoms associated with the
30 underlying disorder such that an improvement is observed in the subject,

notwithstanding that the subject may still be afflicted with the underlying disorder. In certain embodiments, for prophylactic benefit, the compositions are administered to a subject at risk of developing a particular disease, or to a subject reporting one or more of the physiological symptoms of a disease, even though a diagnosis of this disease may
5 not have been made.

A “therapeutic effect,” as that term is used herein, encompasses a therapeutic benefit and/or a prophylactic benefit as described above. A prophylactic effect includes delaying or eliminating the appearance of a disease or condition, delaying or eliminating the onset of symptoms of a disease or condition, slowing,
10 halting, or reversing the progression of a disease or condition, or any combination thereof.

The term “co-administration,” “administered in combination with,” and their grammatical equivalents, as used herein, encompass administration of two or more agents to an animal, including humans, so that both agents and/or their metabolites are
15 present in the subject at the same time. Co-administration includes simultaneous administration in separate compositions, administration at different times in separate compositions, or administration in a composition in which both agents are present.

“Pharmaceutically acceptable salt” includes both acid and base addition salts.

20 “Pharmaceutically acceptable acid addition salt” refers to those salts which retain the biological effectiveness and properties of the free bases, which are not biologically or otherwise undesirable, and which are formed with inorganic acids such as, but are not limited to, hydrochloric acid, hydrobromic acid, sulfuric acid, nitric acid, phosphoric acid and the like, and organic acids such as, but not limited to, acetic acid,
25 2,2-dichloroacetic acid, adipic acid, alginic acid, ascorbic acid, aspartic acid, benzenesulfonic acid, benzoic acid, 4-acetamidobenzoic acid, camphoric acid, camphor-10-sulfonic acid, capric acid, caproic acid, caprylic acid, carbonic acid, cinnamic acid, citric acid, cyclamic acid, dodecylsulfuric acid, ethane-1,2-disulfonic acid, ethanesulfonic acid, 2-hydroxyethanesulfonic acid, formic acid, fumaric acid,
30 galactaric acid, gentisic acid, glucoheptonic acid, gluconic acid, glucuronic acid,

glutamic acid, glutaric acid, 2-oxo-glutaric acid, glycerophosphoric acid, glycolic acid, hippuric acid, isobutyric acid, lactic acid, lactobionic acid, lauric acid, maleic acid, malic acid, malonic acid, mandelic acid, methanesulfonic acid, mucic acid, naphthalene-1,5-disulfonic acid, naphthalene-2-sulfonic acid, 1-hydroxy-2-naphthoic acid, nicotinic acid, oleic acid, orotic acid, oxalic acid, palmitic acid, pamoic acid, propionic acid, pyroglutamic acid, pyruvic acid, salicylic acid, 4-aminosalicylic acid, sebacic acid, stearic acid, succinic acid, tartaric acid, thiocyanic acid, *p*-toluenesulfonic acid, trifluoroacetic acid, undecylenic acid, and the like.

“Pharmaceutically acceptable base addition salt” refers to those salts which retain the biological effectiveness and properties of the free acids, which are not biologically or otherwise undesirable. These salts are prepared from addition of an inorganic base or an organic base to the free acid. Salts derived from inorganic bases include, but are not limited to, the sodium, potassium, lithium, ammonium, calcium, magnesium, iron, zinc, copper, manganese, aluminum salts and the like. Preferred inorganic salts are the ammonium, sodium, potassium, calcium, and magnesium salts. Salts derived from organic bases include, but are not limited to, salts of primary, secondary, and tertiary amines, substituted amines including naturally occurring substituted amines, cyclic amines and basic ion exchange resins, such as ammonia, isopropylamine, trimethylamine, diethylamine, triethylamine, tripropylamine, diethanolamine, ethanolamine, deanol, 2-dimethylaminoethanol, 2-diethylaminoethanol, dicyclohexylamine, lysine, arginine, histidine, caffeine, procaine, hydrabamine, choline, betaine, benethamine, benzathine, ethylenediamine, glucosamine, methylglucamine, theobromine, triethanolamine, tromethamine, purines, piperazine, piperidine, *N*-ethylpiperidine, polyamine resins and the like. Particularly preferred organic bases are isopropylamine, diethylamine, ethanolamine, trimethylamine, dicyclohexylamine, choline and caffeine.

The terms “antagonist” and “inhibitor” are used interchangeably, and they refer to a compound having the ability to inhibit a biological function of a target protein, whether by inhibiting the activity or expression of the protein, such as KRAS, HRAS or NRAS G12C. Accordingly, the terms “antagonist” and “inhibitors” are

defined in the context of the biological role of the target protein. While preferred antagonists herein specifically interact with (e.g. bind to) the target, compounds that inhibit a biological activity of the target protein by interacting with other members of the signal transduction pathway of which the target protein is a member are also specifically included within this definition. A preferred biological activity inhibited by an antagonist is associated with the development, growth, or spread of a tumor.

The term “agonist” as used herein refers to a compound having the ability to initiate or enhance a biological function of a target protein, whether by inhibiting the activity or expression of the target protein. Accordingly, the term “agonist” is defined in the context of the biological role of the target polypeptide. While preferred agonists herein specifically interact with (e.g. bind to) the target, compounds that initiate or enhance a biological activity of the target polypeptide by interacting with other members of the signal transduction pathway of which the target polypeptide is a member are also specifically included within this definition.

As used herein, “agent” or “biologically active agent” refers to a biological, pharmaceutical, or chemical compound or other moiety. Non-limiting examples include a simple or complex organic or inorganic molecule, a peptide, a protein, an oligonucleotide, an antibody, an antibody derivative, antibody fragment, a vitamin derivative, a carbohydrate, a toxin, or a chemotherapeutic compound. Various compounds can be synthesized, for example, small molecules and oligomers (e.g., oligopeptides and oligonucleotides), and synthetic organic compounds based on various core structures. In addition, various natural sources can provide compounds for screening, such as plant or animal extracts, and the like.

"Signal transduction" is a process during which stimulatory or inhibitory signals are transmitted into and within a cell to elicit an intracellular response. A modulator of a signal transduction pathway refers to a compound which modulates the activity of one or more cellular proteins mapped to the same specific signal transduction pathway. A modulator may augment (agonist) or suppress (antagonist) the activity of a signaling molecule.

An “anti-cancer agent”, “anti-tumor agent” or “chemotherapeutic agent” refers to any agent useful in the treatment of a neoplastic condition. One class of anti-cancer agents comprises chemotherapeutic agents. “Chemotherapy” means the administration of one or more chemotherapeutic drugs and/or other agents to a cancer patient by various methods, including intravenous, oral, intramuscular, intraperitoneal, intravesical, subcutaneous, transdermal, buccal, or inhalation or in the form of a suppository.

The term “cell proliferation” refers to a phenomenon by which the cell number has changed as a result of division. This term also encompasses cell growth by which the cell morphology has changed (e.g., increased in size) consistent with a proliferative signal.

The term “selective inhibition” or “selectively inhibit” refers to a biologically active agent refers to the agent’s ability to preferentially reduce the target signaling activity as compared to off-target signaling activity, via direct or indirect interaction with the target.

"Subject" refers to an animal, such as a mammal, for example a human. The methods described herein can be useful in both human therapeutics and veterinary applications. In some embodiments, the subject is a mammal, and in some embodiments, the subject is human.

“Mammal” includes humans and both domestic animals such as laboratory animals and household pets (e.g., cats, dogs, swine, cattle, sheep, goats, horses, rabbits), and non-domestic animals such as wildlife and the like.

“Radiation therapy” means exposing a subject, using routine methods and compositions known to the practitioner, to radiation emitters such as alpha-particle emitting radionuclides (e.g., actinium and thorium radionuclides), low linear energy transfer (LET) radiation emitters (i.e. beta emitters), conversion electron emitters (e.g. strontium-89 and samarium-153-EDTMP, or high-energy radiation, including without limitation x-rays, gamma rays, and neutrons.

An “anti-cancer agent”, “anti-tumor agent” or “chemotherapeutic agent” refers to any agent useful in the treatment of a neoplastic condition. One class of anti-

cancer agents comprises chemotherapeutic agents. "Chemotherapy" means the administration of one or more chemotherapeutic drugs and/or other agents to a cancer patient by various methods, including intravenous, oral, intramuscular, intraperitoneal, intravesical, subcutaneous, transdermal, buccal, or inhalation or in the form of a
5 suppository.

"Prodrug" is meant to indicate a compound that may be converted under physiological conditions or by solvolysis to a biologically active compound described herein (e.g., compound of structure (I)). Thus, the term "prodrug" refers to a precursor of a biologically active compound that is pharmaceutically acceptable. In some aspects,
10 a prodrug is inactive when administered to a subject, but is converted in vivo to an active compound, for example, by hydrolysis. The prodrug compound often offers advantages of solubility, tissue compatibility or delayed release in a mammalian organism (see, e.g., Bundgard, H., Design of Prodrugs (1985), pp. 7-9, 21-24 (Elsevier, Amsterdam). A discussion of prodrugs is provided in Higuchi, T., et al., "Pro-drugs as
15 Novel Delivery Systems," A.C.S. Symposium Series, Vol. 14, and in Bioreversible Carriers in Drug Design, ed. Edward B. Roche, American Pharmaceutical Association and Pergamon Press, 1987, both of which are incorporated in full by reference herein. The term "prodrug" is also meant to include any covalently bonded carriers, which release the active compound in vivo when such prodrug is administered to a
20 mammalian subject. Prodrugs of an active compound, as described herein, are typically prepared by modifying functional groups present in the active compound in such a way that the modifications are cleaved, either in routine manipulation or in vivo, to the parent active compound. Prodrugs include compounds wherein a hydroxy, amino or mercapto group is bonded to any group that, when the prodrug of the active compound
25 is administered to a mammalian subject, cleaves to form a free hydroxy, free amino or free mercapto group, respectively. Examples of prodrugs include, but are not limited to, acetate, formate and benzoate derivatives of a hydroxy functional group, or acetamide, formamide and benzamide derivatives of an amine functional group in the active compound and the like.

30 The term "in vivo" refers to an event that takes place in a subject's body.

The invention disclosed herein is also meant to encompass all pharmaceutically acceptable compounds of structure (I) being isotopically-labelled by having one or more atoms replaced by an atom having a different atomic mass or mass number. Examples of isotopes that can be incorporated into the disclosed compounds include isotopes of hydrogen, carbon, nitrogen, oxygen, phosphorous, fluorine, chlorine, and iodine, such as ^2H , ^3H , ^{11}C , ^{13}C , ^{14}C , ^{13}N , ^{15}N , ^{15}O , ^{17}O , ^{18}O , ^{31}P , ^{32}P , ^{35}S , ^{18}F , ^{36}Cl , ^{123}I , and ^{125}I , respectively. These radiolabelled compounds could be useful to help determine or measure the effectiveness of the compounds, by characterizing, for example, the site or mode of action, or binding affinity to pharmacologically important site of action. Certain isotopically-labelled compounds of structure (I), for example, those incorporating a radioactive isotope, are useful in drug and/or substrate tissue distribution studies. The radioactive isotopes tritium, *i.e.* ^3H , and carbon-14, *i.e.* ^{14}C , are particularly useful for this purpose in view of their ease of incorporation and ready means of detection.

Substitution with heavier isotopes such as deuterium, *i.e.* ^2H , may afford certain therapeutic advantages resulting from greater metabolic stability, for example, increased *in vivo* half-life or reduced dosage requirements, and hence are preferred in some circumstances.

Substitution with positron emitting isotopes, such as ^{11}C , ^{18}F , ^{15}O and ^{13}N , can be useful in Positron Emission Topography (PET) studies for examining substrate receptor occupancy. Isotopically-labeled compounds of structure (I) can generally be prepared by conventional techniques known to those skilled in the art or by processes analogous to those described in the Preparations and Examples as set out below using an appropriate isotopically-labeled reagent in place of the non-labeled reagent previously employed.

The invention disclosed herein is also meant to encompass the *in vivo* metabolic products of the disclosed compounds. Such products may result from, for example, the oxidation, reduction, hydrolysis, amidation, esterification, and the like of the administered compound, primarily due to enzymatic processes. Accordingly, the invention includes compounds produced by a process comprising administering a

compound of this invention to a mammal for a period of time sufficient to yield a metabolic product thereof. Such products are typically identified by administering a radiolabelled compound of the invention in a detectable dose to an animal, such as rat, mouse, guinea pig, monkey, or to human, allowing sufficient time for metabolism to occur, and isolating its conversion products from the urine, blood or other biological samples.

“Stable compound” and “stable structure” are meant to indicate a compound that is sufficiently robust to survive isolation to a useful degree of purity from a reaction mixture, and formulation into an efficacious therapeutic agent.

Often crystallizations produce a solvate of the compound of the invention. As used herein, the term “solvate” refers to an aggregate that comprises one or more molecules of a compound of the invention with one or more molecules of solvent. In some embodiments, the solvent is water, in which case the solvate is a hydrate. Alternatively, in other embodiments, the solvent is an organic solvent. Thus, the compounds of the present invention may exist as a hydrate, including a monohydrate, dihydrate, hemihydrate, sesquihydrate, trihydrate, tetrahydrate and the like, as well as the corresponding solvated forms. In some aspects, the compound of the invention is a true solvate, while in other cases, the compound of the invention merely retains adventitious water or is a mixture of water plus some adventitious solvent.

“Optional” or “optionally” means that the subsequently described event of circumstances may or may not occur, and that the description includes instances where said event or circumstance occurs and instances in which it does not. For example, “optionally substituted aryl” means that the aryl radical may or may not be substituted and that the description includes both substituted aryl radicals and aryl radicals having no substitution.

A “pharmaceutical composition” refers to a formulation of a compound of the invention and a medium generally accepted in the art for the delivery of the biologically active compound to mammals, *e.g.*, humans. Such a medium includes all pharmaceutically acceptable carriers, diluents or excipients therefor.

“Pharmaceutically acceptable carrier, diluent or excipient” includes without limitation any adjuvant, carrier, excipient, glidant, sweetening agent, diluent, preservative, dye/colorant, flavor enhancer, surfactant, wetting agent, dispersing agent, suspending agent, stabilizer, isotonic agent, solvent, or emulsifier which has been
5 approved by the United States Food and Drug Administration as being acceptable for use in humans or domestic animals.

The compounds of the invention, or their pharmaceutically acceptable salts may contain one or more asymmetric centers and may thus give rise to enantiomers, diastereomers, and other stereoisomeric forms that are defined, in terms of
10 absolute stereochemistry, as (*R*)- or (*S*)- or, as (*D*)- or (*L*)- for amino acids. The present invention is meant to include all such possible isomers, as well as their racemic and optically pure forms. Optically active (+) and (-), (*R*)- and (*S*)-, or (*D*)- and (*L*)- isomers may be prepared using chiral synthons or chiral reagents, or resolved using conventional techniques, for example, chromatography and fractional crystallization.
15 Conventional techniques for the preparation/isolation of individual enantiomers include chiral synthesis from a suitable optically pure precursor or resolution of the racemate (or the racemate of a salt or derivative) using, for example, chiral high pressure liquid chromatography (HPLC). When the compounds described herein contain olefinic double bonds or other centres of geometric asymmetry, and unless specified otherwise,
20 it is intended that the compounds include both E and Z geometric isomers. Likewise, all tautomeric forms are also intended to be included.

The present invention includes all manner of rotamers and conformationally restricted states of a compound of the invention.

A “stereoisomer” refers to a compound made up of the same atoms
25 bonded by the same bonds but having different three-dimensional structures, which are not interchangeable. The present invention contemplates various stereoisomers and mixtures thereof and includes “enantiomers”, which refers to two stereoisomers whose molecules are nonsuperimposable mirror images of one another.

A "tautomer" refers to a proton shift from one atom of a molecule to another atom of the same molecule. The present invention includes tautomers of any said compounds.

The chemical naming protocol and structure diagrams used herein are a modified form of the I.U.P.A.C. nomenclature system, using the ACD/Name Version 9.07 software program and/or ChemDraw Ultra Version 11.0.1 software naming program (CambridgeSoft). For complex chemical names employed herein, a substituent group is typically named before the group to which it attaches. For example, cyclopropylethyl comprises an ethyl backbone with a cyclopropyl substituent. Except as described below, all bonds are identified in the chemical structure diagrams herein, except for all bonds on some carbon atoms, which are assumed to be bonded to sufficient hydrogen atoms to complete the valency.

Compounds

In an aspect, the invention provides compounds which are capable of selectively binding to and/or modulating a G12C mutant KRAS, HRAS or NRAS protein. The compounds may modulate the G12C mutant KRAS, HRAS or NRAS protein by reaction with an amino acid. While not wishing to be bound by theory, the present applicants believe that, in some embodiments, the compounds of the invention selectively react with the G12C mutant KRAS, HRAS or NRAS proteins by forming a covalent bond with the cysteine at the 12 position of a G12C mutant KRAS, HRAS or NRAS protein. By binding to the cysteine 12, the compounds of the invention may lock the switch II of the G12C mutant KRAS, HRAS or NRAS into an inactive stage. This inactive stage may be distinct from those observed for GTP and GDP bound KRAS, HRAS or NRAS. Some compounds of the invention may also be able to perturb the switch I conformation. Some compounds of the invention may favor the binding of the bound KRAS, HRAS or NRAS to GDP rather than GTP and therefore sequester the KRAS, HRAS or NRAS into an inactive KRAS, HRAS or NRAS GDP state. Because effector binding to KRAS, HRAS or NRAS is highly sensitive to the

conformation of switch I and II, the irreversible binding of these compounds may disrupt KRAS, HRAS or NRAS downstream signaling.

As noted above, in one embodiment of the present invention, compounds having activity as modulators of a G12C mutant KRAS, HRAS or NRAS protein are provided. In some embodiments the compounds have the following structure (I):

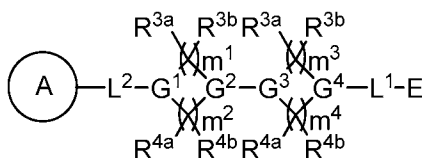

(I)

or a pharmaceutically acceptable salt, tautomer, stereoisomer or prodrug thereof, wherein:

G^1 , G^2 , G^3 and G^4 are each independently N or CR, where R is H, cyano, halo or C₁-C₆alkyl;

A is a fused bicyclic heteroaryl comprising two or more heteroatoms, wherein H is substituted with R¹ and R²;

R¹ and R² are each independently H, halo, hydroxyl, cyano, aminocarbonyl, formyl, C₁-C₆alkyl, C₁-C₆alkylsulfonyl, C₁-C₆haloalkyl, C₃-C₈cycloalkyl, C₁-C₆alkoxy, C₁-C₆hydroxylalkyl, C₁-C₆alkoxyalkyl, C₁-C₆aminoalkyl, aliphatic heterocyclyl, heteroaryl or aryl, provided that at least one of R¹ or R² is not H;

R^{3a} and R^{3b} are, at each occurrence, independently

H, -OH, -NH₂, -CO₂H, halo, cyano, C₁-C₆alkyl, C₁-C₆alkynyl, hydroxylalkyl, aminylalkyl, alkylaminylalkyl, cyanoalkyl, carboxyalkyl, aminocarbonylalkyl or aminocarbonyl; or one R^{3a} and one R^{3b} join to form a carbocyclic or heterocyclic ring, and each remaining R^{3a} and R^{3b} are, at each occurrence, independently

H, -OH, -NH₂, -CO₂H, halo, cyano, C₁-C₆alkyl, C₁-C₆alkynyl, hydroxylalkyl, aminylalkyl, alkylaminylalkyl, cyanoalkyl, carboxyalkyl, aminocarbonylalkyl or aminocarbonyl; or one R^{3b} joins with one R^{4b} to form a carbocyclic or heterocyclic ring, and each R^{3a} and each remaining R^{3b} are, at each occurrence, independently

H, -OH, -NH₂, -CO₂H, halo, cyano, C₁-C₆alkyl, C₁-C₆alkynyl, hydroxylalkyl,

aminylalkyl, alkylaminylalkyl, cyanoalkyl, carboxyalkyl, aminylcarbonylalkyl or aminylcarbonyl;

R^{4a} and R^{4b} are, at each occurrence, independently

H, -OH, -NH₂, -CO₂H, halo, cyano, C₁-C₆ alkyl, C₁-C₆ alkynyl, hydroxylalkyl,

5 aminylalkyl, alkylaminylalkyl, cyanoalkyl, carboxyalkyl, aminocarbonylalkyl or aminocarbonyl; or one R^{4a} and one R^{4b} join to form a carbocyclic or heterocyclic ring, and each remaining R^{4a} and R^{4b} are, at each occurrence, independently

H, -OH, -NH₂, -CO₂H, halo, cyano, C₁-C₆ alkyl, C₁-C₆ alkynyl, hydroxylalkyl,

10 aminylalkyl, alkylaminylalkyl, cyanoalkyl, carboxyalkyl, aminocarbonylalkyl or aminocarbonyl; or one R^{4b} joins with one R^{3b} to form a carbocyclic or heterocyclic ring, and each R^{4a} and each remaining R^{4b} are, at each occurrence, independently

H, -OH, -NH₂, -CO₂H, halo, cyano, C₁-C₆ alkyl, C₁-C₆ alkynyl, hydroxylalkyl,

aminylalkyl, alkylaminylalkyl, cyanoalkyl, carboxyalkyl, aminylcarbonylalkyl or aminylcarbonyl;

15 L^1 is a bond or alkylene;

L^2 is a bond or a one or two carbon alkylene optionally substituted with

oxo;

m^1 , m^2 , m^3 and m^4 are each independently 1, 2 or 3; and

20 E is an electrophilic moiety capable of forming a covalent bond with the cysteine residue at position 12 of a KRAS, HRAS or NRAS G12C mutant protein, wherein all valences are satisfied.

In other embodiments, the compound has one of the following structures

(Ia), (Ib), (Ic), (Id), (Ie) or (If):

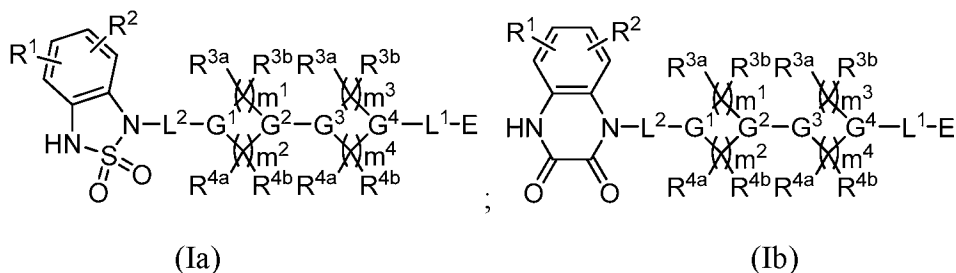

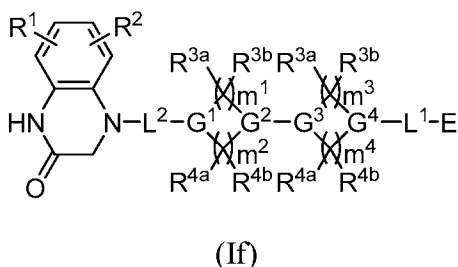
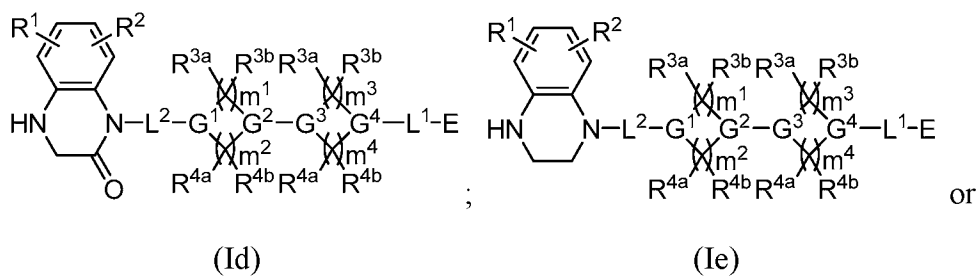

- 5 The structure of E is not particularly limited provided it is capable of forming a covalent bond with a nucleophile, such as the cysteine residue at position 12 of a KRAS, HRAS or NRAS G12C mutant protein. Accordingly, moieties which are capable of reaction with (*e.g.*, by covalent bond formation) a nucleophile are preferred. In certain embodiments, E is capable of reacting in a conjugate addition manner (*e.g.*,
- 10 1.4-conjugate addition) with an appropriately reactive nucleophile. In some embodiments, E comprises conjugated pi bonds such that delocalization of electrons results in at least one atom (*e.g.*, a carbon atom) having a positive charge, partial positive charge or a polarized bond. In other embodiments, E comprises one or more bonds wherein the electronegativity of the two atoms forming the bonds is sufficiently
- 15 different such that a partial positive charge (*e.g.*, by polarization of the bond) resides on one of the atoms, for example on a carbon atom. E moieties comprising carbon-halogen bonds, carbon-oxygen bonds or carbon bonds to various leaving groups known in the art are examples of such E moieties.

In certain embodiments of the foregoing, E has the following structure:



wherein:

\equiv represents a double or triple bond;

Q is $-C(=O)-$, $-C(=NR^7)-$, $-NR^8C(=O)-$, $-S(=O)_2-$ or $-NR^8S(=O)_2-$;

R^7 is H, -OH, -CN or C_1 - C_6 alkyl;

R^8 is H, C_1 - C_6 alkyl or hydroxylalkyl; and

when \equiv is a double bond then R^9 and R^{10} are each independently H, cyano, carboxyl, C_1 - C_6 alkyl, alkoxy carbonyl, aminylalkyl, alkylaminylalkyl, or hydroxylalkyl or R^9 and R^{10} join to form a carbocyclic or heterocyclic ring;

when \equiv is a triple bond; then R^9 is absent and R^{10} is H, C_1 - C_6 alkyl, aminylalkyl, alkylaminylalkyl or hydroxylalkyl.

In certain embodiments when \equiv is a double bond then R^9 and R^{10} are each independently H, cyano, C_1 - C_6 alkyl, aminylalkyl, alkylaminylalkyl, or hydroxylalkyl or R^9 and R^{10} join to form a carbocyclic or heterocyclic ring.

In some of the foregoing embodiments, Q is $-C(=O)-$, $-NR^8C(=O)-$, $-S(=O)_2-$ or $-NR^8S(=O)_2-$.

In some other of the foregoing embodiments, Q is $-C(=NR^7)-$, wherein R^7 is H, -OH, -CN or C_1 - C_6 alkyl. For example, in some embodiments R^7 is H. In other embodiments, R^7 is -CN. In other embodiments, R^7 is -OH.

In yet more of any of the foregoing embodiments, E has the following structure:

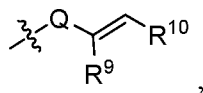

wherein:

Q is $-C(=O)-$, $-C(=NR^7)-$, $-NR^8C(=O)-$, $-S(=O)_2-$ or $-NR^8S(=O)_2-$;

R^7 is H, -OH, -CN or C_1 - C_6 alkyl;

R^8 is H, C_1 - C_6 alkyl or hydroxylalkyl; and

R^9 and R^{10} are each independently H, cyano, C_1 - C_6 alkyl, aminylalkyl, alkylaminylalkyl, or hydroxylalkyl or R^9 and R^{10} join to form a carbocyclic or heterocyclic ring.

In some of the foregoing embodiments, Q is $-C(=O)-$, $-NR^8C(=O)-$, $-S(=O)_2-$ or $-NR^8S(=O)_2-$.

In some other of the foregoing embodiments, Q is $-C(=NR^{8'})-$, wherein $R^{8'}$ is H, -OH, -CN or C_1-C_6 alkyl. For example, in some embodiments $R^{8'}$ is H. In other embodiments, $R^{8'}$ is -CN. In other embodiments, $R^{8'}$ is -OH.

In still other of any of the foregoing embodiments, E has the following structure:

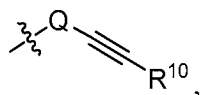

wherein:

Q is $-C(=O)-$, $-NR^8C(=O)-$, $-S(=O)_2-$ or $-NR^8S(=O)_2-$;

R^8 is H, C_1-C_6 alkyl or hydroxylalkyl; and

R^{10} is H, C_1-C_6 alkyl, aminylalkyl, alkylaminylalkyl or hydroxylalkyl.

Still different embodiments of E include the following structure:

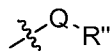

wherein Q is as defined above and R'' is halomethyl or heterocyclyl, for example chloromethyl, fluoromethyl or oxiraneyl.

Accordingly, in some different embodiments the compound has one of the following structures (Ia'), (Ib'), (Ic'), (Id'), (Ie') or (If'):

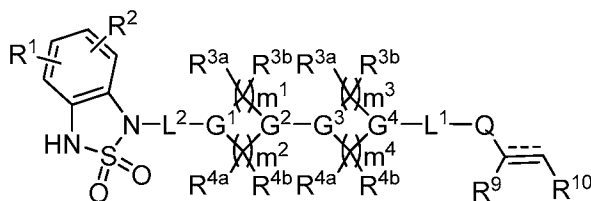

(Ia')

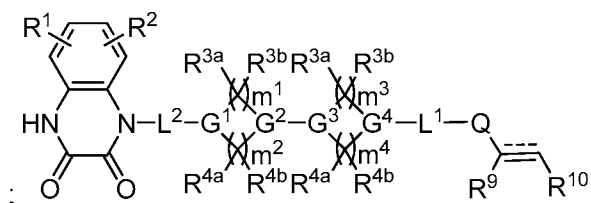

(Ib')

20

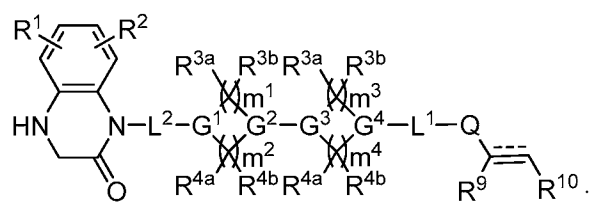

(Id')

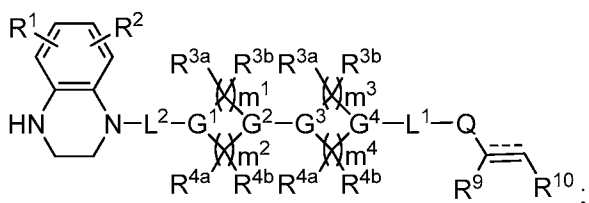

(Ie')

5

or

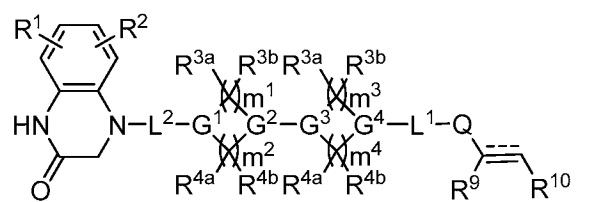

(If')

wherein:

\equiv represents a double or triple bond;

10 Q is $-C(=O)-$, $-C(=NR^7)-$, $-NR^8C(=O)-$, $-S(=O)_2-$ or $-NR^8S(=O)_2-$;

R^7 is H, $-OH$, $-CN$ or C_1-C_6 alkyl;

R^8 is H, C_1-C_6 alkyl or hydroxylalkyl;

when \equiv is a double bond then R^9 and R^{10} are each independently H, cyano, carboxyl, C_1-C_6 alkyl, alkoxy carbonyl, aminylalkyl, alkylaminylalkyl, heteroaryl
15 or hydroxylalkyl or R^9 and R^{10} join to form a carbocyclic or heterocyclic ring; and

when \equiv is a triple bond then R^9 is absent and R^{10} is H, C_1-C_6 alkyl, aminylalkyl, alkylaminylalkyl or hydroxylalkyl.

In other embodiments, the compound has one of the following structures (Ia''), (Ib''), (Ic''), (Id''), (Ie'') or (If''):

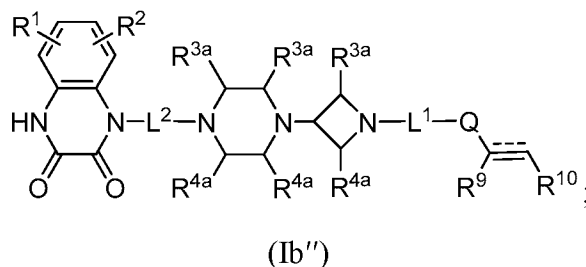
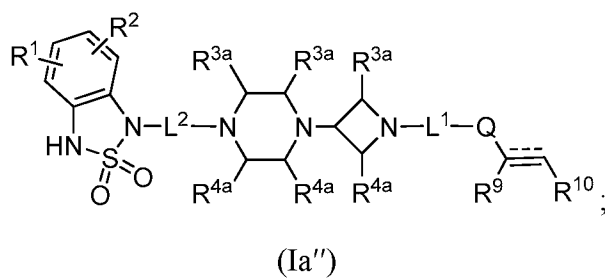

5

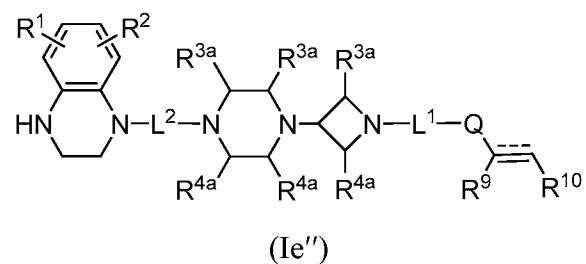
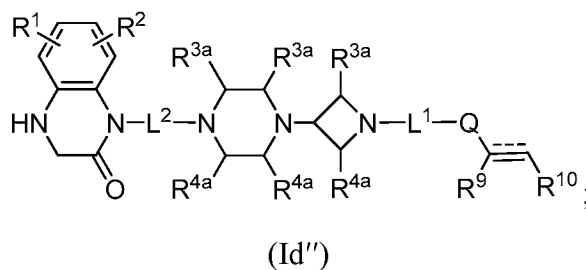

or

10

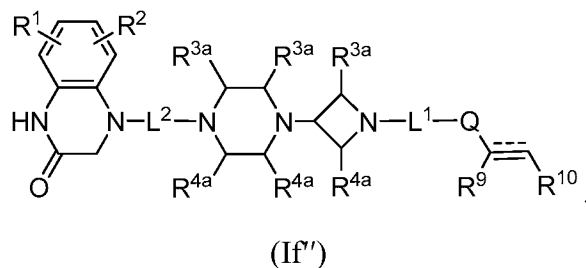

Without wishing to be bound by theory, Applicants believe correct selection of the “A” moiety may play a part in the compounds’ inhibitory activity (*e.g.*, against KRAS, HRAS or NRAS G12C). In some embodiments, A comprises nitrogen or sulfur or combinations thereof. In other embodiments, A is tetrahydroquinoxalineyl,

dihydroquinoxalinoneyl, quinoxalinedioneyl, benzoimidazolethienyl or indolinoneyl, each of which is optionally substituted with R^1 and R^2 , provided at least one of R^1 or R^2 is not H. In some embodiments, A is capable of reversible interaction with KRAS, HRAS or NRAS G12C mutant protein. In some embodiments A has high affinity
5 towards KRAS, HRAS or NRAS and is highly specific towards G12C KRAS, HRAS or NRAS. In some embodiments A is capable of hydrophobic interaction with KRAS, HRAS or NRAS G12C. In some embodiments A is able to form hydrogen bonds with various residues of G12C KRAS, HRAS or NRAS protein.

In other embodiments, A is substituted with R^1 and R^2 , and neither R^1
10 nor R^2 is H. In still other embodiments, R^2 is H.

In other embodiments, A is substituted with R^1 . In some of these
embodiments, R^2 is H. In some embodiments, R^1 and R^2 are different.

In some different embodiments, R^1 or R^2 is fluoro, chloro, bromo, iodo,
hydroxyl, cyano, methyl, ethyl, isopropyl, methylsulfonyl, methoxy, aminocarbonyl,
15 trifluoromethyl, 2,2,2-trifluoroethyl, cyclobutyl, cyclopropyl or phenyl, wherein the cyclopropyl and phenyl are optionally substituted with one or more substituents selected from C_1 - C_6 alkyl, halo, hydroxyl and cyano.

In some other embodiments, R^1 or R^2 is fluoro, chloro, bromo, iodo,
hydroxyl, methyl, ethyl, cyclobutyl or cyclopropyl, wherein the cyclopropyl is
20 optionally substituted with one or more substituents selected from C_1 - C_6 alkyl, halo, hydroxyl and cyano.

In still more embodiments, R^1 or R^2 is fluoro, chloro, bromo, hydroxyl or
cyclopropyl, wherein the cyclopropyl is optionally substituted with one or more
substituents selected from C_1 - C_6 alkyl, halo, hydroxyl and cyano.

25 In some other specific embodiment, R^1 is chloro and R^2 is chloro or cyclopropyl.

In some exemplary embodiments, A has one of the following structures:

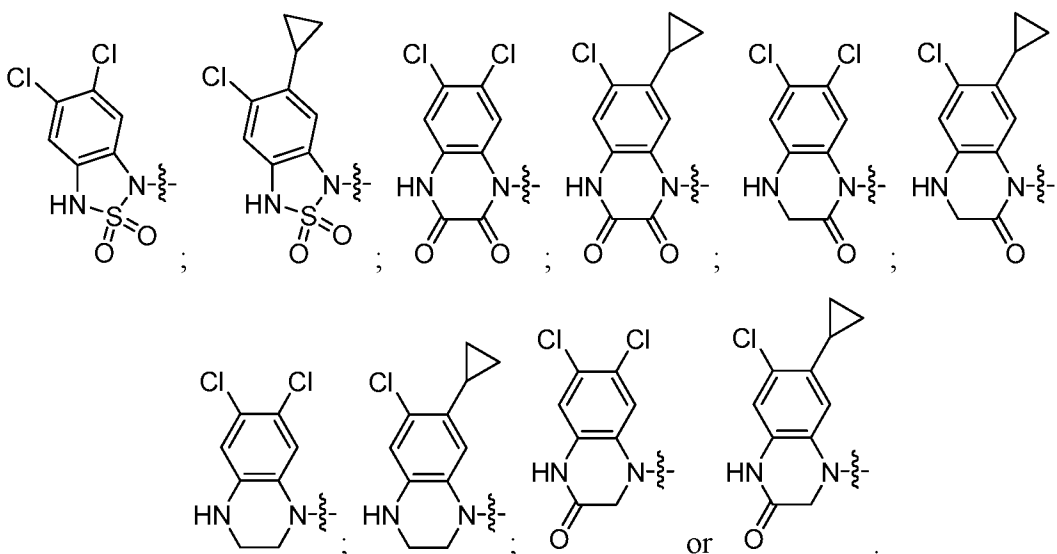

In some embodiments, L^2 is a bond. In some embodiments, L^2 is $-\text{CH}_2\text{C}(=\text{O})-$.

5 The Q moiety is typically selected to optimize the reactivity (i.e., electrophilicity) of E. In some other embodiments of any of the foregoing compounds, Q is $-\text{C}(=\text{O})-$. In other embodiments, Q is $-\text{S}(=\text{O})_2-$. In still more embodiments, Q is $-\text{C}(=\text{NR}^7)-$. In yet other embodiments, Q is $-\text{NR}^8\text{C}(=\text{O})-$. In some different embodiments, Q is $-\text{NR}^8\text{S}(=\text{O})_2-$.

10 In further embodiments of the foregoing, R^8 is H. In other embodiment, R^8 is hydroxylalkyl, such as 2-hydroxylalkyl.

In other embodiments, at least one of R^9 or R^{10} is H. For example, in some embodiments each of R^9 and R^{10} are H.

In more embodiments, R^{10} is alkylaminylalkyl, for example R^{10} has the following structure in some embodiments:

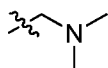

In other embodiments, R^{10} is hydroxylalkyl, such as 2-hydroxylalkyl

In some different embodiments, R^9 and R^{10} join to form a carbocyclic ring, for example a cyclopentene, cyclohexene or phenyl ring.

20 In some of any of the foregoing embodiments E is an electrophile capable of bonding with a KRAS, HRAS or NRAS protein comprising G12C mutation.

In some embodiments, the electrophile E is capable of forming an irreversible covalent bond with a G12C mutant KRAS, HRAS or NRAS protein. In some cases, the electrophile E may bind with the cysteine residue at the position 12 of a G12C mutant KRAS, HRAS or NRAS protein. Non-limiting examples of the E moiety of various

5 embodiments include E one of the following structures:

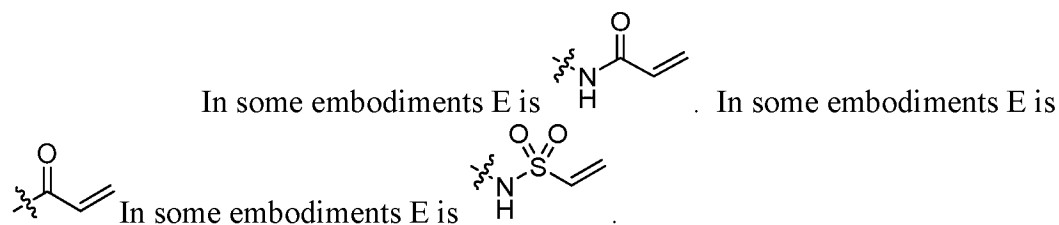
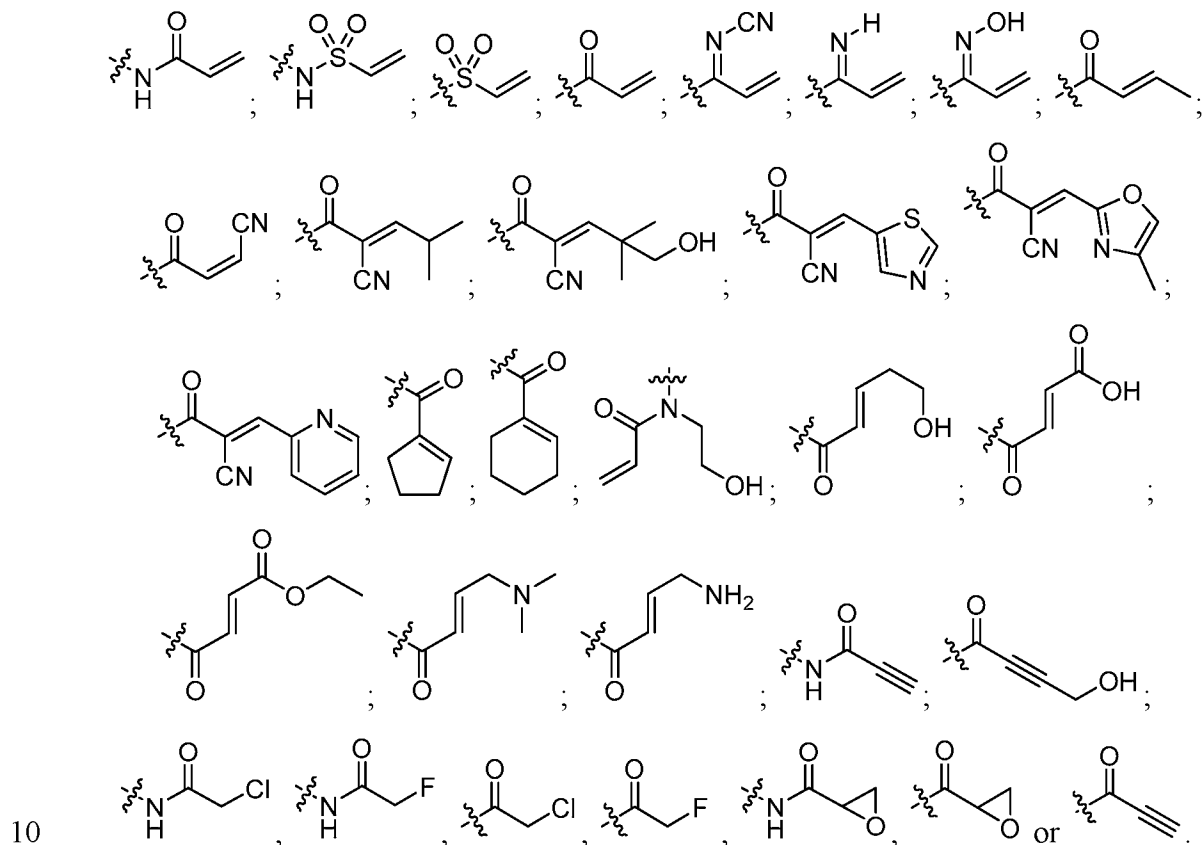

In some embodiments, L^1 is selected to provide proper spacing and/or orientation for the E group to form a bond with the KRAS, HRAS or NRAS protein. In some of the foregoing embodiments, L^1 is a bond. In other of the foregoing

15 embodiments, L^1 is alkylene. In some embodiments, the alkylene is substituted. In other embodiments the alkylene is unsubstituted. For example, in some embodiments L^1 is CH_2 or CH_2CH_2 .

In certain embodiments, R^{3a} and R^{3b} are, at each occurrence, independently H, -OH, -NH₂, -CO₂H, halo, cyano, hydroxylalkly, aminylalkyl, cyanoalkyl, carboxyalkyl or aminylcarbonyl, and R^{4a} and R^{4b} are, at each occurrence, independently H, -OH, -NH₂, -CO₂H, halo, cyano, hydroxylalkly, aminylalkyl,
 5 cyanoalkyl, carboxyalkyl or aminylcarbonyl.

In other of the foregoing embodiments, R^{3a} and R^{4a} are, at each occurrence, independently H, -OH, hydroxylalkly, cyano, or aminylcarbonyl and R^{3b} and R^{4b} are H.

In certain other embodiments, R^{3a} and R^{4a} are H and R^{3b} and R^{4b} are, at
 10 each occurrence, independently H, -OH, -NH₂, -CO₂H, halo, cyano, hydroxylalkly, aminylalkyl, cyanoalkyl, carboxyalkyl or aminylcarbonyl.

In any of the foregoing embodiments, at least one of R^{3a} , R^{3b} , R^{4a} or R^{4b} is H. In some embodiments, each of R^{3a} , R^{3b} , R^{4a} and R^{4b} are H.

In some embodiments, R^{3a} is -OH, -NH₂, -CO₂H, halo, cyano,
 15 hydroxylalkly, aminylalkyl, cyanoalkyl, carboxyalkyl or aminylcarbonyl, and R^{3b} , R^{4a} and R^{4b} are H.

In other embodiments, R^{4a} is -OH, -NH₂, -CO₂H, halo, cyano, hydroxylalkly, aminylalkyl, cyanoalkyl, carboxyalkyl or aminylcarbonyl, and R^{3a} , R^{3b} and R^{4b} are H.

In other embodiments, R^{3a} is H, -OH, -NH₂, -CO₂H, halo, cyano, hydroxylalkly, aminylalkyl, cyanoalkyl, carboxyalkyl or aminylcarbonyl, and R^{3b} joins
 20 with R^{4b} to form a carbocyclic or heterocyclic ring;

In still more embodiments, R^{4a} is H, -OH, -NH₂, -CO₂H, halo, cyano, hydroxylalkly, aminylalkyl, cyanoalkyl, carboxyalkyl or aminylcarbonyl, and R^{4b} joins
 25 with R^{3b} to form a carbocyclic or heterocyclic ring.

In other embodiments, R^{3a} and R^{3b} join to form a carbocyclic or heterocyclic ring. In other embodiments, R^{4a} and R^{4b} join to form a carbocyclic or heterocyclic ring.

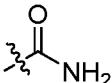
In still other embodiments, at least one R^{3a} or R^{4a} is aminylcarbonyl. For
 30 example, in certain embodiments, the aminylcarbonyl is . In other

embodiments, at least one R^{3a} or R^{4a} is cyano. In other embodiments, R^{3a} or R^{4a} is -OH. In other embodiments, R^{3a} or R^{4a} is hydroxylalkyl, for example hydroxylmethyl.

In some embodiments m^1 is 1. In other embodiments m^1 is 2. In still more embodiments, m^1 is 3. In different embodiments, m^2 is 1. In some other
5 embodiments, m^2 is 2. In yet still more embodiments, m^2 is 3. In some embodiments, m^1 is 2 and m^2 is 2.

In some embodiments m^3 is 1. In other embodiments m^3 is 2. In still more embodiments, m^3 is 3. In different embodiments, m^4 is 1. In some other
embodiments, m^4 is 2. In yet still more embodiments, m^4 is 3. In some embodiments,
10 m^3 is 1 and m^4 is 1.

In some other particular embodiments of any of the foregoing compounds, m^1 is 1, and m^2 is 1. In other embodiments, m^1 is 1 and, m^2 is 2. In still other embodiments m^1 is 2, and m^2 is 2. In more embodiments, m^1 is 1, and m^2 is 3.

In some embodiments, m^1 is 2, m^2 is 2, m^3 is 1 and m^4 is 1
15 G^1 , G^2 , G^3 and G^4 are each independently N or CR, where R is H, cyano, halo or C_1 - C_6 alkyl. In some embodiments, at least one of G^1 or G^2 is N. In some embodiments, G^2 is N. In some embodiments, G^2 is N and G^1 is N or CH. In some embodiments, each of G^1 and G^2 are each N. In some embodiments, each of G^1 and G^2 are N and m^1 and m^2 are each 2. In some other embodiments, at least one of G^1 or G^2 is
20 CH. In other embodiments, each of G^1 and G^2 are CH. In some embodiments, G^1 is N. In some embodiments, G^1 is CH.

In other embodiments of the foregoing, G^3 and G^4 are each independently CH or N. In some embodiments, G^4 is N. In other embodiments, G^3 is CH. In some embodiments, G^3 is CH and G^4 is N. In other embodiments, G^1 , G^2 and
25 G^4 are N. In still other embodiments, G^1 , G^2 and G^4 are N and G^3 is CH.

In various different embodiments, the compound has one of the structures set forth in Table 1 below:

Table 1
Representative Compounds

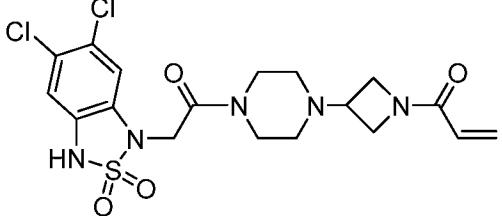
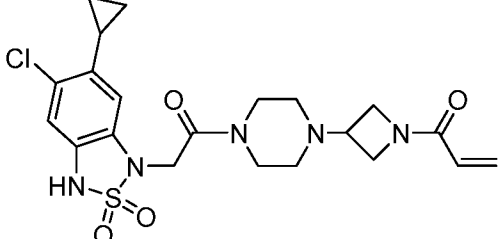
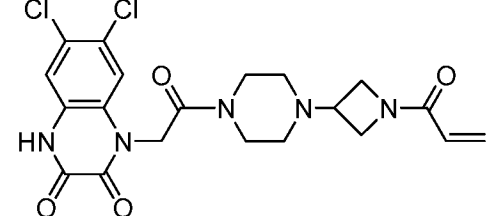
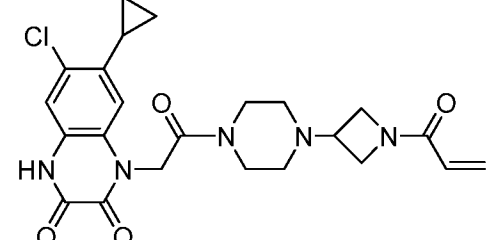
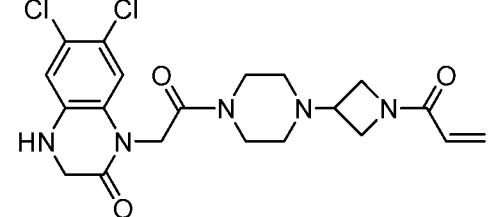
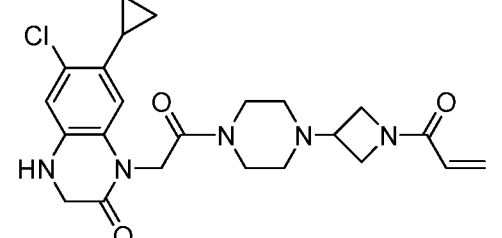
No.	Structure	Name
1		1-(2-(4-(1-acryloylazetid-3-yl)piperazin-1-yl)-2-oxoethyl)-5,6-dichloro-1H-benzo[d]imidazol-2(3H)-one
2		1-(2-(4-(1-acryloylazetid-3-yl)piperazin-1-yl)-2-oxoethyl)-5-chloro-6-cyclopropyl-1H-benzo[d]imidazol-2(3H)-sulfone
3		1-(2-(4-(1-acryloylazetid-3-yl)piperazin-1-yl)-2-oxoethyl)-6,7-dichloroquinoxaline-2,3(1H,4H)-dione
4		1-(2-(4-(1-acryloylazetid-3-yl)piperazin-1-yl)-2-oxoethyl)-6-chloro-7-cyclopropylquinoxaline-2,3(1H,4H)-dione
5		1-(2-(4-(1-acryloylazetid-3-yl)piperazin-1-yl)-2-oxoethyl)-6,7-dichloro-3,4-dihydroquinoxalin-2(1H)-one
6		1-(2-(4-(1-acryloylazetid-3-yl)piperazin-1-yl)-2-oxoethyl)-6-chloro-7-cyclopropyl-3,4-dihydroquinoxalin-2(1H)-one

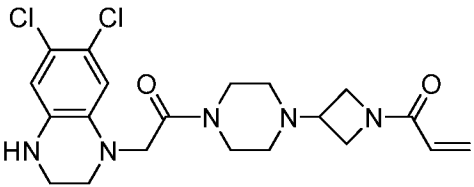
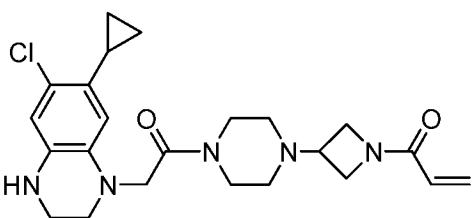
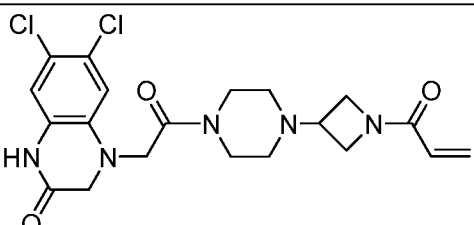
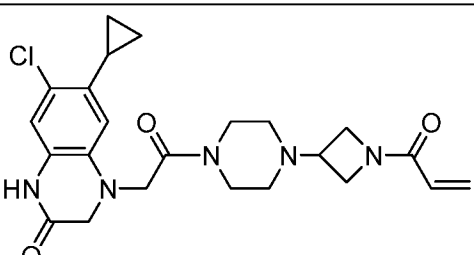
No.	Structure	Name
7		1-(3-(4-(2-(6,7-dichloro-3,4-dihydroquinoxalin-1(2H)-yl)acetyl)piperazin-1-yl)azetidin-1-yl)prop-2-en-1-one
8		1-(3-(4-(2-(6-chloro-7-cyclopropyl-3,4-dihydroquinoxalin-1(2H)-yl)acetyl)piperazin-1-yl)azetidin-1-yl)prop-2-en-1-one
9		4-(2-(4-(1-acryloylazetidin-3-yl)piperazin-1-yl)-2-oxoethyl)-6,7-dichloro-3,4-dihydroquinoxalin-2(1H)-one
10		4-(2-(4-(1-acryloylazetidin-3-yl)piperazin-1-yl)-2-oxoethyl)-7-chloro-6-cyclopropyl-3,4-dihydroquinoxalin-2(1H)-one

The compounds in Table 1 are prepared and analyzed by mass spectrometry and/or ^1H NMR. Exemplary synthetic procedures are described in more detail below. General methods by which the compounds may be prepared are provided

5 below.

It is understood that in the present description, combinations of substituents and/or variables of the depicted formulae are permissible only if such contributions result in stable compounds.

It will also be appreciated by those skilled in the art that in the processes

10 for preparing the compounds described herein the functional groups of intermediate compounds may need to be protected by suitable protecting groups. Such functional groups include, but are not limited to, hydroxy, amino, mercapto and carboxylic acid.

Suitable protecting groups for hydroxy include trialkylsilyl or diarylalkylsilyl (for example, *t*-butyldimethylsilyl, *t*-butyldiphenylsilyl or trimethylsilyl), tetrahydropyranyl, benzyl, and the like. Suitable protecting groups for amino, amidino and guanidino include *t*-butoxycarbonyl, benzyloxycarbonyl, and the like. Suitable protecting groups for mercapto include -C(O)-R'' (where R'' is alkyl, aryl or arylalkyl), *p*-methoxybenzyl, trityl and the like. Suitable protecting groups for carboxylic acid include alkyl, aryl or arylalkyl esters. Protecting groups are optionally added or removed in accordance with standard techniques, which are known to one skilled in the art and as described herein. The use of protecting groups is described in detail in Green, T.W. and P.G.M. Wutz, 10 *Protective Groups in Organic Synthesis* (1999), 3rd Ed., Wiley. As one of skill in the art would appreciate, the protecting group may also be a polymer resin such as a Wang resin, Rink resin or a 2-chlorotrityl-chloride resin.

It will also be appreciated by those skilled in the art, although such protected derivatives of compounds of this invention may not possess pharmacological activity as such, they may be administered to a mammal and thereafter metabolized in the body to form compounds of the invention which are pharmacologically active. Such derivatives may therefore be described as "prodrugs". All prodrugs of compounds of this invention are included within the scope of the invention.

Furthermore, all compounds of the invention which exist in free base or acid form can be converted to their pharmaceutically acceptable salts by treatment with the appropriate inorganic or organic base or acid by methods known to one skilled in the art. Salts of the compounds of the invention can be converted to their free base or acid form by standard techniques.

The following General Reaction Scheme illustrates exemplary methods of making compounds of structure (I):

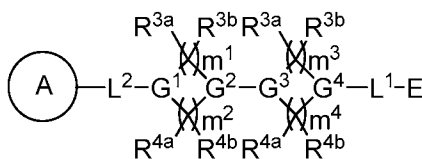

(I)

or a pharmaceutically acceptable salt, tautomer, stereoisomer or prodrug thereof, wherein A, R^{3a}, R^{3b}, R^{4a}, R^{4b}, G¹, G², G³, G⁴, m¹, m², m³, m⁴, L¹, L² and E are as defined herein. It is understood that one skilled in the art may be able to make these compounds by similar methods or by combining other methods known to one skilled in the art. It is also understood that one skilled in the art would be able to make, in a similar manner as described below, other compounds of structure (I) not specifically illustrated below by using the appropriate starting components and modifying the parameters of the synthesis as needed. In general, starting components may be obtained from sources such as Sigma Aldrich, Lancaster Synthesis, Inc., Maybridge, Matrix Scientific, TCI, and Fluorochem USA, etc. or synthesized according to sources known to those skilled in the art (see, for example, *Advanced Organic Chemistry: Reactions, Mechanisms, and Structure*, 5th edition (Wiley, December 2000)) or prepared as described in this invention.

General Reaction Scheme 1

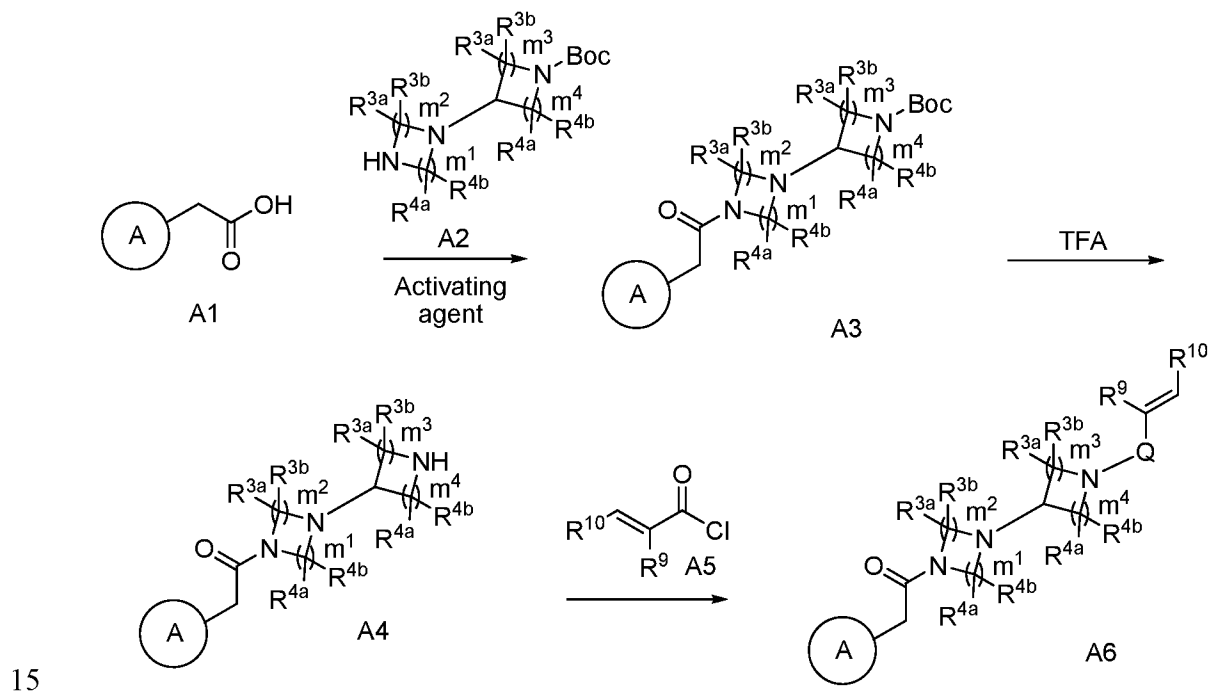

15

Embodiments of the compound of structure (I) (e.g., compound A6) can be prepared according to General Reaction Scheme 1 ("Method A"), wherein A, R^{3a}, R^{3b}, R^{4a}, R^{4b}, R⁹, R¹⁰, Q, m¹, m², m³ and m⁴ are as defined herein above. As shown in

General Reaction Scheme 1, compounds of structure A1 can be purchased from commercial sources or prepared according to methods familiar to one of ordinary skill in the art. Reaction of A1 with heterocycle A2 (which is prepared according to known methods or purchased from commercial sources), yields A3. Exemplary reaction
5 conditions include use of known peptide coupling reagents. Appropriate protecting groups for A2 include butyloxycarbonyl (BOC) as depicted in General reaction Scheme 1, as well as other protecting groups known in the art. If needed, further reactions of A3 may be performed to prepare the desired compound (e.g., add R¹ and/or R² substituents, etc.). Deprotection of A3 followed by acylation with an acid chloride (or
10 other suitable moiety such as an acid or sulfonyl chloride) and appropriate activating reagents yields A6.

It should be noted that General reaction scheme I only depicts an exemplary method for preparation of compounds of structure (I) with an exemplary L² linker, and other methods are available, including methods for preparation of
15 compounds of structure (I) having different substitutions and/or linkers, etc.

Pharmaceutical Compositions

Other embodiments are directed to pharmaceutical compositions. The pharmaceutical composition comprises any one (or more) of the foregoing compounds and a pharmaceutically acceptable carrier. In some embodiments, the pharmaceutical
20 composition is formulated for oral administration. In other embodiments, the pharmaceutical composition is formulated for injection. In still more embodiments, the pharmaceutical compositions comprise a compound as disclosed herein and an additional therapeutic agent (e.g., anticancer agent). Non-limiting examples of such therapeutic agents are described herein below.

25 Suitable routes of administration include, but are not limited to, oral, intravenous, rectal, aerosol, parenteral, ophthalmic, pulmonary, transmucosal, transdermal, vaginal, otic, nasal, and topical administration. In addition, by way of example only, parenteral delivery includes intramuscular, subcutaneous, intravenous,

intramedullary injections, as well as intrathecal, direct intraventricular, intraperitoneal, intralymphatic, and intranasal injections.

In certain embodiments, a compound as described herein is administered in a local rather than systemic manner, for example, via injection of the compound
5 directly into an organ, often in a depot preparation or sustained release formulation. In specific embodiments, long acting formulations are administered by implantation (for example subcutaneously or intramuscularly) or by intramuscular injection. Furthermore, in other embodiments, the drug is delivered in a targeted drug delivery system, for example, in a liposome coated with organ-specific antibody. In such
10 embodiments, the liposomes are targeted to and taken up selectively by the organ. In yet other embodiments, the compound as described herein is provided in the form of a rapid release formulation, in the form of an extended release formulation, or in the form of an intermediate release formulation. In yet other embodiments, the compound described herein is administered topically.

15 The compounds according to the invention are effective over a wide dosage range. For example, in the treatment of adult humans, dosages from 0.01 to 1000 mg, from 0.5 to 100 mg, from 1 to 50 mg per day, and from 5 to 40 mg per day are examples of dosages that are used in some embodiments. An exemplary dosage is 10 to 30 mg per day. The exact dosage will depend upon the route of administration,
20 the form in which the compound is administered, the subject to be treated, the body weight of the subject to be treated, and the preference and experience of the attending physician.

In some embodiments, a compound of the invention is administered in a single dose. Typically, such administration will be by injection, e.g., intravenous
25 injection, in order to introduce the agent quickly. However, other routes are used as appropriate. A single dose of a compound of the invention may also be used for treatment of an acute condition.

In some embodiments, a compound of the invention is administered in multiple doses. In some embdoiments, dosing is about once, twice, three times, four
30 times, five times, six times, or more than six times per day. In other embodiments,

dosing is about once a month, once every two weeks, once a week, or once every other day. In another embodiment a compound of the invention and another agent are administered together about once per day to about 6 times per day. In another embodiment the administration of a compound of the invention and an agent continues
5 for less than about 7 days. In yet another embodiment the administration continues for more than about 6, 10, 14, 28 days, two months, six months, or one year. In some cases, continuous dosing is achieved and maintained as long as necessary.

Administration of the compounds of the invention may continue as long as necessary. In some embodiments, a compound of the invention is administered for
10 more than 1, 2, 3, 4, 5, 6, 7, 14, or 28 days. In some embodiments, a compound of the invention is administered for less than 28, 14, 7, 6, 5, 4, 3, 2, or 1 day. In some embodiments, a compound of the invention is administered chronically on an ongoing basis, e.g., for the treatment of chronic effects.

In some embodiments, the compounds of the invention are administered
15 in dosages. It is known in the art that due to intersubject variability in compound pharmacokinetics, individualization of dosing regimen is necessary for optimal therapy. Dosing for a compound of the invention may be found by routine experimentation in light of the instant disclosure.

In some embodiments, the compounds described herein are formulated
20 into pharmaceutical compositions. In specific embodiments, pharmaceutical compositions are formulated in a conventional manner using one or more physiologically acceptable carriers comprising excipients and auxiliaries which facilitate processing of the active compounds into preparations which can be used pharmaceutically. Proper formulation is dependent upon the route of administration
25 chosen. Any pharmaceutically acceptable techniques, carriers, and excipients are used as suitable to formulate the pharmaceutical compositions described herein: Remington: The Science and Practice of Pharmacy, Nineteenth Ed (Easton, Pa.: Mack Publishing Company, 1995); Hoover, John E., Remington's Pharmaceutical Sciences, Mack Publishing Co., Easton, Pennsylvania 1975; Liberman, H.A. and Lachman, L., Eds.,
30 Pharmaceutical Dosage Forms, Marcel Decker, New York, N.Y., 1980; and

Pharmaceutical Dosage Forms and Drug Delivery Systems, Seventh Ed. (Lippincott Williams & Wilkins 1999).

5 Provided herein are pharmaceutical compositions comprising a compound of structure (I) and a pharmaceutically acceptable diluent(s), excipient(s), or carrier(s). In certain embodiments, the compounds described are administered as pharmaceutical compositions in which compounds of structure (I) are mixed with other active ingredients, as in combination therapy. Encompassed herein are all combinations of actives set forth in the combination therapies section below and throughout this disclosure. In specific embodiments, the pharmaceutical compositions include one or
10 more compounds of structure (I).

A pharmaceutical composition, as used herein, refers to a mixture of a compound of structure (I) with other chemical components, such as carriers, stabilizers, diluents, dispersing agents, suspending agents, thickening agents, and/or excipients. In certain embodiments, the pharmaceutical composition facilitates administration of the
15 compound to an organism. In some embodiments, practicing the methods of treatment or use provided herein, therapeutically effective amounts of compounds of structure (I) provided herein are administered in a pharmaceutical composition to a mammal having a disease, disorder or medical condition to be treated. In specific embodiments, the mammal is a human. In certain embodiments, therapeutically effective amounts vary
20 depending on the severity of the disease, the age and relative health of the subject, the potency of the compound used and other factors. The compounds described herein are used singly or in combination with one or more therapeutic agents as components of mixtures.

In one embodiment, one or more compounds of structure (I) is
25 formulated in an aqueous solution. In specific embodiments, the aqueous solution is selected from, by way of example only, a physiologically compatible buffer, such as Hank's solution, Ringer's solution, or physiological saline buffer. In other embodiments, one or more compound of structure (I) is/are formulated for transmucosal administration. In specific embodiments, transmucosal formulations include penetrants
30 that are appropriate to the barrier to be permeated. In still other embodiments wherein

the compounds described herein are formulated for other parenteral injections, appropriate formulations include aqueous or nonaqueous solutions. In specific embodiments, such solutions include physiologically compatible buffers and/or excipients.

5 In another embodiment, compounds described herein are formulated for oral administration. Compounds described herein are formulated by combining the active compounds with, e.g., pharmaceutically acceptable carriers or excipients. In various embodiments, the compounds described herein are formulated in oral dosage forms that include, by way of example only, tablets, powders, pills, dragees, capsules,
10 liquids, gels, syrups, elixirs, slurries, suspensions and the like.

 In certain embodiments, pharmaceutical preparations for oral use are obtained by mixing one or more solid excipient with one or more of the compounds described herein, optionally grinding the resulting mixture, and processing the mixture of granules, after adding suitable auxiliaries, if desired, to obtain tablets or dragee cores.
15 Suitable excipients are, in particular, fillers such as sugars, including lactose, sucrose, mannitol, or sorbitol; cellulose preparations such as: for example, maize starch, wheat starch, rice starch, potato starch, gelatin, gum tragacanth, methylcellulose, microcrystalline cellulose, hydroxypropylmethylcellulose, sodium
 carboxymethylcellulose; or others such as: polyvinylpyrrolidone (PVP or povidone) or
20 calcium phosphate. In specific embodiments, disintegrating agents are optionally added. Disintegrating agents include, by way of example only, cross-linked croscarmellose sodium, polyvinylpyrrolidone, agar, or alginic acid or a salt thereof such as sodium alginate.

 In one embodiment, dosage forms, such as dragee cores and tablets, are
25 provided with one or more suitable coating. In specific embodiments, concentrated sugar solutions are used for coating the dosage form. The sugar solutions, optionally contain additional components, such as by way of example only, gum arabic, talc, polyvinylpyrrolidone, carbopol gel, polyethylene glycol, and/or titanium dioxide, lacquer solutions, and suitable organic solvents or solvent mixtures. Dyestuffs and/or
30 pigments are also optionally added to the coatings for identification purposes.

Additionally, the dyestuffs and/or pigments are optionally utilized to characterize different combinations of active compound doses.

In certain embodiments, therapeutically effective amounts of at least one of the compounds described herein are formulated into other oral dosage forms. Oral dosage forms include push-fit capsules made of gelatin, as well as soft, sealed capsules made of gelatin and a plasticizer, such as glycerol or sorbitol. In specific embodiments, push-fit capsules contain the active ingredients in admixture with one or more filler. Fillers include, by way of example only, lactose, binders such as starches, and/or lubricants such as talc or magnesium stearate and, optionally, stabilizers. In other embodiments, soft capsules, contain one or more active compound that is dissolved or suspended in a suitable liquid. Suitable liquids include, by way of example only, one or more fatty oil, liquid paraffin, or liquid polyethylene glycol. In addition, stabilizers are optionally added.

In other embodiments, therapeutically effective amounts of at least one of the compounds described herein are formulated for buccal or sublingual administration. Formulations suitable for buccal or sublingual administration include, by way of example only, tablets, lozenges, or gels. In still other embodiments, the compounds described herein are formulated for parental injection, including formulations suitable for bolus injection or continuous infusion. In specific embodiments, formulations for injection are presented in unit dosage form (e.g., in ampoules) or in multi-dose containers. Preservatives are, optionally, added to the injection formulations. In still other embodiments, the pharmaceutical compositions are formulated in a form suitable for parenteral injection as sterile suspensions, solutions or emulsions in oily or aqueous vehicles. Parenteral injection formulations optionally contain formulatory agents such as suspending, stabilizing and/or dispersing agents. In specific embodiments, pharmaceutical formulations for parenteral administration include aqueous solutions of the active compounds in water-soluble form. In additional embodiments, suspensions of the active compounds (e.g., compounds of structure (I)) are prepared as appropriate oily injection suspensions. Suitable lipophilic solvents or vehicles for use in the pharmaceutical compositions described herein include, by way of

example only, fatty oils such as sesame oil, or synthetic fatty acid esters, such as ethyl oleate or triglycerides, or liposomes. In certain specific embodiments, aqueous injection suspensions contain substances which increase the viscosity of the suspension, such as sodium carboxymethyl cellulose, sorbitol, or dextran. Optionally, the suspension contains suitable stabilizers or agents which increase the solubility of the compounds to allow for the preparation of highly concentrated solutions. Alternatively, in other embodiments, the active ingredient is in powder form for constitution with a suitable vehicle, e.g., sterile pyrogen-free water, before use.

In still other embodiments, the compounds of structure (I) are administered topically. The compounds described herein are formulated into a variety of topically administrable compositions, such as solutions, suspensions, lotions, gels, pastes, medicated sticks, balms, creams or ointments. Such pharmaceutical compositions optionally contain solubilizers, stabilizers, tonicity enhancing agents, buffers and preservatives.

In yet other embodiments, the compounds of structure (I) are formulated for transdermal administration. In specific embodiments, transdermal formulations employ transdermal delivery devices and transdermal delivery patches and can be lipophilic emulsions or buffered, aqueous solutions, dissolved and/or dispersed in a polymer or an adhesive. In various embodiments, such patches are constructed for continuous, pulsatile, or on demand delivery of pharmaceutical agents. In additional embodiments, the transdermal delivery of the compounds of structure (I) is accomplished by means of iontophoretic patches and the like. In certain embodiments, transdermal patches provide controlled delivery of the compounds of structure (I). In specific embodiments, the rate of absorption is slowed by using rate-controlling membranes or by trapping the compound within a polymer matrix or gel. In alternative embodiments, absorption enhancers are used to increase absorption. Absorption enhancers or carriers include absorbable pharmaceutically acceptable solvents that assist passage through the skin. For example, in one embodiment, transdermal devices are in the form of a bandage comprising a backing member, a reservoir containing the compound optionally with carriers, optionally a rate controlling barrier to deliver the

compound to the skin of the host at a controlled and predetermined rate over a prolonged period of time, and means to secure the device to the skin.

In other embodiments, the compounds of structure (I) are formulated for administration by inhalation. Various forms suitable for administration by inhalation include, but are not limited to, aerosols, mists or powders. Pharmaceutical compositions of any of compound of structure (I) are conveniently delivered in the form of an aerosol spray presentation from pressurized packs or a nebuliser, with the use of a suitable propellant (*e.g.*, dichlorodifluoromethane, trichlorofluoromethane, dichlorotetrafluoroethane, carbon dioxide or other suitable gas). In specific embodiments, the dosage unit of a pressurized aerosol is determined by providing a valve to deliver a metered amount. In certain embodiments, capsules and cartridges of, such as, by way of example only, gelatin for use in an inhaler or insufflator are formulated containing a powder mix of the compound and a suitable powder base such as lactose or starch.

In still other embodiments, the compounds of structure (I) are formulated in rectal compositions such as enemas, rectal gels, rectal foams, rectal aerosols, suppositories, jelly suppositories, or retention enemas, containing conventional suppository bases such as cocoa butter or other glycerides, as well as synthetic polymers such as polyvinylpyrrolidone, PEG, and the like. In suppository forms of the compositions, a low-melting wax such as, but not limited to, a mixture of fatty acid glycerides, optionally in combination with cocoa butter is first melted.

In certain embodiments, pharmaceutical compositions are formulated in any conventional manner using one or more physiologically acceptable carriers comprising excipients and auxiliaries which facilitate processing of the active compounds into preparations which can be used pharmaceutically. Proper formulation is dependent upon the route of administration chosen. Any pharmaceutically acceptable techniques, carriers, and excipients are optionally used as suitable. Pharmaceutical compositions comprising a compound of structure (I) are manufactured in a conventional manner, such as, by way of example only, by means of conventional

mixing, dissolving, granulating, dragee-making, levigating, emulsifying, encapsulating, entrapping or compression processes.

Pharmaceutical compositions include at least one pharmaceutically acceptable carrier, diluent or excipient and at least one compound of structure (I),
5 described herein as an active ingredient. The active ingredient is in free-acid or free-base form, or in a pharmaceutically acceptable salt form. In addition, the methods and pharmaceutical compositions described herein include the use of N-oxides, crystalline forms (also known as polymorphs), as well as active metabolites of these compounds having the same type of activity. All tautomers of the compounds described herein are
10 included within the scope of the compounds presented herein. Additionally, the compounds described herein encompass unsolvated as well as solvated forms with pharmaceutically acceptable solvents such as water, ethanol, and the like. The solvated forms of the compounds presented herein are also considered to be disclosed herein. In addition, the pharmaceutical compositions optionally include other medicinal or
15 pharmaceutical agents, carriers, adjuvants, such as preserving, stabilizing, wetting or emulsifying agents, solution promoters, salts for regulating the osmotic pressure, buffers, and/or other therapeutically valuable substances.

Methods for the preparation of compositions comprising the compounds described herein include formulating the compounds with one or more inert,
20 pharmaceutically acceptable excipients or carriers to form a solid, semi-solid or liquid. Solid compositions include, but are not limited to, powders, tablets, dispersible granules, capsules, cachets, and suppositories. Liquid compositions include solutions in which a compound is dissolved, emulsions comprising a compound, or a solution containing liposomes, micelles, or nanoparticles comprising a compound as disclosed
25 herein. Semi-solid compositions include, but are not limited to, gels, suspensions and creams. The form of the pharmaceutical compositions described herein include liquid solutions or suspensions, solid forms suitable for solution or suspension in a liquid prior to use, or as emulsions. These compositions also optionally contain minor amounts of nontoxic, auxiliary substances, such as wetting or emulsifying agents, pH buffering
30 agents, and so forth.

In some embodiments, pharmaceutical composition comprising at least one compound of structure (I) illustratively takes the form of a liquid where the agents are present in solution, in suspension or both. Typically when the composition is administered as a solution or suspension a first portion of the agent is present in
5 solution and a second portion of the agent is present in particulate form, in suspension in a liquid matrix. In some embodiments, a liquid composition includes a gel formulation. In other embodiments, the liquid composition is aqueous.

In certain embodiments, useful aqueous suspensions contain one or more polymers as suspending agents. Useful polymers include water-soluble polymers such
10 as cellulosic polymers, e.g., hydroxypropyl methylcellulose, and water-insoluble polymers such as cross-linked carboxyl-containing polymers. Certain pharmaceutical compositions described herein comprise a mucoadhesive polymer, selected for example from carboxymethylcellulose, carbomer (acrylic acid polymer),
poly(methylmethacrylate), polyacrylamide, polycarbophil, acrylic acid/butyl acrylate
15 copolymer, sodium alginate and dextran.

Useful pharmaceutical compositions also, optionally, include solubilizing agents to aid in the solubility of a compound of structure (I). The term “solubilizing agent” generally includes agents that result in formation of a micellar solution or a true solution of the agent. Certain acceptable nonionic surfactants, for
20 example polysorbate 80, are useful as solubilizing agents, as can ophthalmically acceptable glycols, polyglycols, e.g., polyethylene glycol 400, and glycol ethers.

Furthermore, useful pharmaceutical compositions optionally include one or more pH adjusting agents or buffering agents, including acids such as acetic, boric, citric, lactic, phosphoric and hydrochloric acids; bases such as sodium hydroxide,
25 sodium phosphate, sodium borate, sodium citrate, sodium acetate, sodium lactate and tris-hydroxymethylaminomethane; and buffers such as citrate/dextrose, sodium bicarbonate and ammonium chloride. Such acids, bases and buffers are included in an amount required to maintain pH of the composition in an acceptable range.

Additionally, useful compositions also, optionally, include one or more
30 salts in an amount required to bring osmolality of the composition into an acceptable

range. Such salts include those having sodium, potassium or ammonium cations and chloride, citrate, ascorbate, borate, phosphate, bicarbonate, sulfate, thiosulfate or bisulfite anions; suitable salts include sodium chloride, potassium chloride, sodium thiosulfate, sodium bisulfite and ammonium sulfate.

5 Other useful pharmaceutical compositions optionally include one or more preservatives to inhibit microbial activity. Suitable preservatives include mercury-containing substances such as merfen and thiomersal; stabilized chlorine dioxide; and quaternary ammonium compounds such as benzalkonium chloride, cetyltrimethylammonium bromide and cetylpyridinium chloride.

10 Still other useful compositions include one or more surfactants to enhance physical stability or for other purposes. Suitable nonionic surfactants include polyoxyethylene fatty acid glycerides and vegetable oils, e.g., polyoxyethylene (60) hydrogenated castor oil; and polyoxyethylene alkylethers and alkylphenyl ethers, e.g., octoxynol 10, octoxynol 40.

15 Still other useful compositions include one or more antioxidants to enhance chemical stability where required. Suitable antioxidants include, by way of example only, ascorbic acid and sodium metabisulfite.

 In certain embodiments, aqueous suspension compositions are packaged in single-dose non-reclosable containers. Alternatively, multiple-dose reclosable
20 containers are used, in which case it is typical to include a preservative in the composition.

 In alternative embodiments, other delivery systems for hydrophobic pharmaceutical compounds are employed. Liposomes and emulsions are examples of delivery vehicles or carriers useful herein. In certain embodiments, organic solvents
25 such as N-methylpyrrolidone are also employed. In additional embodiments, the compounds described herein are delivered using a sustained-release system, such as semipermeable matrices of solid hydrophobic polymers containing the therapeutic agent. Various sustained-release materials are useful herein. In some embodiments, sustained-release capsules release the compounds for a few weeks up to over 100 days.

Depending on the chemical nature and the biological stability of the therapeutic reagent, additional strategies for protein stabilization are employed.

In certain embodiments, the formulations described herein comprise one or more antioxidants, metal chelating agents, thiol containing compounds and/or other
5 general stabilizing agents. Examples of such stabilizing agents, include, but are not limited to: (a) about 0.5% to about 2% w/v glycerol, (b) about 0.1% to about 1% w/v methionine, (c) about 0.1% to about 2% w/v monothioglycerol, (d) about 1 mM to about 10 mM EDTA, (e) about 0.01% to about 2% w/v ascorbic acid, (f) 0.003% to about 0.02% w/v polysorbate 80, (g) 0.001% to about 0.05% w/v. polysorbate 20, (h)
10 arginine, (i) heparin, (j) dextran sulfate, (k) cyclodextrins, (l) pentosan polysulfate and other heparinoids, (m) divalent cations such as magnesium and zinc; or (n) combinations thereof.

In some embodiments, the concentration of one or more compounds provided in the pharmaceutical compositions of the present invention is less than 100%,
15 90%, 80%, 70%, 60%, 50%, 40%, 30%, 20%, 19%, 18%, 17%, 16%, 15%, 14%, 13%, 12%, 11%, 10%, 9%, 8%, 7%, 6%, 5%, 4%, 3%, 2%, 1%, 0.5%, 0.4%, 0.3%, 0.2%, 0.1%, 0.09%, 0.08%, 0.07%, 0.06%, 0.05%, 0.04%, 0.03%, 0.02%, 0.01%, 0.009%, 0.008%, 0.007%, 0.006%, 0.005%, 0.004%, 0.003%, 0.002%, 0.001%, 0.0009%, 0.0008%, 0.0007%, 0.0006%, 0.0005%, 0.0004%, 0.0003%, 0.0002%, or 0.0001%
20 w/w, w/v or v/v.

In some embodiments, the concentration of one or more compounds of the invention is greater than 90%, 80%, 70%, 60%, 50%, 40%, 30%, 20%, 19.75%, 19.50%, 19.25% 19%, 18.75%, 18.50%, 18.25% 18%, 17.75%, 17.50%, 17.25% 17%, 16.75%, 16.50%, 16.25% 16%, 15.75%, 15.50%, 15.25% 15%, 14.75%, 14.50%,
25 14.25% 14%, 13.75%, 13.50%, 13.25% 13%, 12.75%, 12.50%, 12.25% 12%, 11.75%, 11.50%, 11.25% 11%, 10.75%, 10.50%, 10.25% 10%, 9.75%, 9.50%, 9.25% 9%, 8.75%, 8.50%, 8.25% 8%, 7.75%, 7.50%, 7.25% 7%, 6.75%, 6.50%, 6.25% 6%, 5.75%, 5.50%, 5.25% 5%, 4.75%, 4.50%, 4.25%, 4%, 3.75%, 3.50%, 3.25%, 3%, 2.75%, 2.50%, 2.25%, 2%, 1.75%, 1.50%, 1.25% , 1%, 0.5%, 0.4%, 0.3%, 0.2%, 0.1%, 0.09%,
30 0.08%, 0.07%, 0.06%, 0.05%, 0.04%, 0.03%, 0.02%, 0.01%, 0.009%, 0.008%, 0.007%,

0.006%, 0.005%, 0.004%, 0.003%, 0.002%, 0.001%, 0.0009%, 0.0008%, 0.0007%,
0.0006%, 0.0005%, 0.0004%, 0.0003%, 0.0002%, or 0.0001% w/w, w/v, or v/v.

In some embodiments, the concentration of one or more compounds of
the invention is in the range from approximately 0.0001% to approximately 50%,
5 approximately 0.001% to approximately 40 %, approximately 0.01% to approximately
30%, approximately 0.02% to approximately 29%, approximately 0.03% to
approximately 28%, approximately 0.04% to approximately 27%, approximately 0.05%
to approximately 26%, approximately 0.06% to approximately 25%, approximately
0.07% to approximately 24%, approximately 0.08% to approximately 23%,
10 approximately 0.09% to approximately 22%, approximately 0.1% to approximately
21%, approximately 0.2% to approximately 20%, approximately 0.3% to approximately
19%, approximately 0.4% to approximately 18%, approximately 0.5% to approximately
17%, approximately 0.6% to approximately 16%, approximately 0.7% to approximately
15%, approximately 0.8% to approximately 14%, approximately 0.9% to approximately
15 12%, approximately 1% to approximately 10% w/w, w/v or v/v.

In some embodiments, the concentration of one or more compounds of
the invention is in the range from approximately 0.001% to approximately 10%,
approximately 0.01% to approximately 5%, approximately 0.02% to approximately
4.5%, approximately 0.03% to approximately 4%, approximately 0.04% to
20 approximately 3.5%, approximately 0.05% to approximately 3%, approximately 0.06%
to approximately 2.5%, approximately 0.07% to approximately 2%, approximately
0.08% to approximately 1.5%, approximately 0.09% to approximately 1%,
approximately 0.1% to approximately 0.9% w/w, w/v or v/v.

In some embodiments, the amount of one or more compounds of the
25 invention is equal to or less than 10 g, 9.5 g, 9.0 g, 8.5 g, 8.0 g, 7.5 g, 7.0 g, 6.5 g, 6.0 g,
5.5 g, 5.0 g, 4.5 g, 4.0 g, 3.5 g, 3.0 g, 2.5 g, 2.0 g, 1.5 g, 1.0 g, 0.95 g, 0.9 g, 0.85 g, 0.8
g, 0.75 g, 0.7 g, 0.65 g, 0.6 g, 0.55 g, 0.5 g, 0.45 g, 0.4 g, 0.35 g, 0.3 g, 0.25 g, 0.2 g,
0.15 g, 0.1 g, 0.09 g, 0.08 g, 0.07 g, 0.06 g, 0.05 g, 0.04 g, 0.03 g, 0.02 g, 0.01 g, 0.009
g, 0.008 g, 0.007 g, 0.006 g, 0.005 g, 0.004 g, 0.003 g, 0.002 g, 0.001 g, 0.0009 g,
30 0.0008 g, 0.0007 g, 0.0006 g, 0.0005 g, 0.0004 g, 0.0003 g, 0.0002 g, or 0.0001 g.

In some embodiments, the amount of one or more compounds of the invention is more than 0.0001 g, 0.0002 g, 0.0003 g, 0.0004 g, 0.0005 g, 0.0006 g, 0.0007 g, 0.0008 g, 0.0009 g, 0.001 g, 0.0015 g, 0.002 g, 0.0025 g, 0.003 g, 0.0035 g, 0.004 g, 0.0045 g, 0.005 g, 0.0055 g, 0.006 g, 0.0065 g, 0.007 g, 0.0075 g, 0.008 g, 5 0.0085 g, 0.009 g, 0.0095 g, 0.01 g, 0.015 g, 0.02 g, 0.025 g, 0.03 g, 0.035 g, 0.04 g, 0.045 g, 0.05 g, 0.055 g, 0.06 g, 0.065 g, 0.07 g, 0.075 g, 0.08 g, 0.085 g, 0.09 g, 0.095 g, 0.1 g, , 0.15 g, 0.2 g, , 0.25 g, 0.3 g, , 0.35 g, 0.4 g, , 0.45 g, 0.5 g, 0.55 g, 0.6 g, , 0.65 g, 0.7 g, 0.75 g, 0.8 g, 0.85 g, 0.9 g, 0.95 g, 1 g, 1.5 g, 2 g, 2.5, 3 g, 3.5, 4 g, 4.5 g, 5 g, 5.5 g, 6 g, 6.5g, 7 g, 7.5g, 8 g, 8.5 g, 9 g, 9.5 g, or 10 g.

10 In some embodiments, the amount of one or more compounds of the invention is in the range of 0.0001-10 g, 0.0005-9 g, 0.001-8 g, 0.005-7 g, 0.01-6 g, 0.05-5 g, 0.1-4 g, 0.5-4 g, or 1-3 g.

Kits/Articles of Manufacture

For use in the therapeutic applications described herein, kits and articles 15 of manufacture are also provided. In some embodiments, such kits comprise a carrier, package, or container that is compartmentalized to receive one or more containers such as vials, tubes, and the like, each of the container(s) comprising one of the separate elements to be used in a method described herein. Suitable containers include, for example, bottles, vials, syringes, and test tubes. The containers are formed from a 20 variety of materials such as glass or plastic.

The articles of manufacture provided herein contain packaging materials. Packaging materials for use in packaging pharmaceutical products include those found in, e.g., U.S. Pat. Nos. 5,323,907, 5,052,558 and 5,033,252. Examples of pharmaceutical packaging materials include, but are not limited to, blister packs, 25 bottles, tubes, inhalers, pumps, bags, vials, containers, syringes, bottles, and any packaging material suitable for a selected formulation and intended mode of administration and treatment. For example, the container(s) includes one or more compounds described herein, optionally in a composition or in combination with another agent as disclosed herein. The container(s) optionally have a sterile access port

(for example the container is an intravenous solution bag or a vial having a stopper pierceable by a hypodermic injection needle). Such kits optionally comprising a compound with an identifying description or label or instructions relating to its use in the methods described herein.

5 For example, a kit typically includes one or more additional containers, each with one or more of various materials (such as reagents, optionally in concentrated form, and/or devices) desirable from a commercial and user standpoint for use of a compound described herein. Non-limiting examples of such materials include, but not limited to, buffers, diluents, filters, needles, syringes; carrier, package, container, vial
10 and/or tube labels listing contents and/or instructions for use, and package inserts with instructions for use. A set of instructions will also typically be included. A label is optionally on or associated with the container. For example, a label is on a container when letters, numbers or other characters forming the label are attached, molded or etched into the container itself, a label is associated with a container when it is present
15 within a receptacle or carrier that also holds the container, e.g., as a package insert. In addition, a label is used to indicate that the contents are to be used for a specific therapeutic application. In addition, the label indicates directions for use of the contents, such as in the methods described herein. In certain embodiments, the pharmaceutical composition is presented in a pack or dispenser device which contains one or more unit
20 dosage forms containing a compound provided herein. The pack for example contains metal or plastic foil, such as a blister pack. Or, the pack or dispenser device is accompanied by instructions for administration. Or, the pack or dispenser is accompanied with a notice associated with the container in form prescribed by a governmental agency regulating the manufacture, use, or sale of pharmaceuticals,
25 which notice is reflective of approval by the agency of the form of the drug for human or veterinary administration. Such notice, for example, is the labeling approved by the U.S. Food and Drug Administration for prescription drugs, or the approved product insert. In some embodiments, compositions containing a compound provided herein formulated in a compatible pharmaceutical carrier are prepared, placed in an
30 appropriate container, and labeled for treatment of an indicated condition.

Methods

The present invention provides a method of inhibiting RAS-mediated cell signaling comprising contacting a cell with an effective amount of one or more compounds disclosed herein. Inhibition of RAS-mediated signal transduction can be assessed and demonstrated by a wide variety of ways known in the art. Non-limiting examples include a showing of (a) a decrease in GTPase activity of RAS; (b) a decrease in GTP binding affinity or an increase in GDP binding affinity; (c) an increase in K off of GTP or a decrease in K off of GDP; (d) a decrease in the levels of signaling transduction molecules downstream in the RAS pathway, such as a decrease in pMEK level; and/or (e) a decrease in binding of RAS complex to downstream signaling molecules including but not limited to Raf. Kits and commercially available assays can be utilized for determining one or more of the above.

The invention also provides methods of using the compounds or pharmaceutical compositions of the present invention to treat disease conditions, including but not limited to conditions implicated by G12C KRAS, HRAS or NRAS mutation, G12C HRAS mutation and/or G12C NRAS mutation (*e.g.*, cancer).

In some embodiments, a method for treatment of cancer is provided, the method comprising administering an effective amount of any of the foregoing pharmaceutical compositions comprising a compound of structure (I) to a subject in need thereof. In some embodiments, the cancer is mediated by a KRAS, HRAS or NRAS G12C mutation. In other embodiments, the cancer is pancreatic cancer, colon cancer, MYH associated polyposis, colorectal cancer or lung cancer.

In some embodiments the invention provides method of treating a disorder in a subject in need thereof, wherein the said method comprises determining if the subject has a KRAS, HRAS or NRAS G12C mutation and if the subject is determined to have the KRAS, HRAS or NRAS G12C mutation, then administering to the subject a therapeutically effective dose of at least one compound of structure (I) or a pharmaceutically acceptable salt, ester, prodrug, tautomer, solvate, hydrate or derivative thereof.

The disclosed compounds strongly inhibit anchorage-independent cell growth and therefore have the potential to inhibit tumor metastasis. Accordingly, in another embodiment the disclosure provides a method for inhibiting tumor metastasis, the method comprising administering an effective amount a pharmaceutical
5 composition of comprising any of the compounds disclosed herein and a pharmaceutically acceptable carrier to a subject in need thereof.

KRAS, HRAS or NRAS G12C mutations have also been identified in hematological malignancies (e.g., cancers that affect blood, bone marrow and/or lymph nodes). Accordingly, certain embodiments are directed to administration of a disclosed
10 compounds (e.g., in the form of a pharmaceutical composition) to a patient in need of treatment of a hematological malignancy. Such malignancies include, but are not limited to leukemias and lymphomas. For example, the presently disclosed compounds can be used for treatment of diseases such as Acute lymphoblastic leukemia (ALL), Acute myelogenous leukemia (AML), Chronic lymphocytic leukemia (CLL), small
15 lymphocytic lymphoma (SLL), Chronic myelogenous leukemia (CML), Acute monocytic leukemia (AMoL) and/ or other leukemias. In other embodiments, the compounds are useful for treatment of lymphomas such as all subtypes of Hodgkins lymphoma or non-Hodgkins lymphoma.

Determining whether a tumor or cancer comprises a G12C KRAS,
20 HRAS or NRAS mutation can be undertaken by assessing the nucleotide sequence encoding the KRAS, HRAS or NRAS protein, by assessing the amino acid sequence of the KRAS, HRAS or NRAS protein, or by assessing the characteristics of a putative KRAS, HRAS or NRAS mutant protein. The sequence of wild-type human KRAS, HRAS or NRAS is known in the art, (e.g. Accession No. NP203524).

25 Methods for detecting a mutation in a KRAS, HRAS or NRAS nucleotide sequence are known by those of skill in the art. These methods include, but are not limited to, polymerase chain reaction-restriction fragment length polymorphism (PCR-RFLP) assays, polymerase chain reaction-single strand conformation polymorphism (PCR-SSCP) assays, real-time PCR assays, PCR
30 sequencing, mutant allele-specific PCR amplification (MASA) assays, direct

sequencing, primer extension reactions, electrophoresis, oligonucleotide ligation assays, hybridization assays, TaqMan assays, SNP genotyping assays, high resolution melting assays and microarray analyses. In some embodiments, samples are evaluated for G12C KRAS, HRAS or NRAS mutations by real-time PCR. In real-time PCR, fluorescent probes specific for the KRAS, HRAS or NRAS G12C mutation are used. When a mutation is present, the probe binds and fluorescence is detected. In some embodiments, the KRAS, HRAS or NRAS G12C mutation is identified using a direct sequencing method of specific regions (e.g., exon 2 and/or exon 3) in the KRAS, HRAS or NRAS gene. This technique will identify all possible mutations in the region sequenced.

Methods for detecting a mutation in a KRAS, HRAS or NRAS protein are known by those of skill in the art. These methods include, but are not limited to, detection of a KRAS, HRAS or NRAS mutant using a binding agent (e.g., an antibody) specific for the mutant protein, protein electrophoresis and Western blotting, and direct peptide sequencing.

Methods for determining whether a tumor or cancer comprises a G12C KRAS, HRAS or NRAS mutation can use a variety of samples. In some embodiments, the sample is taken from a subject having a tumor or cancer. In some embodiments, the sample is taken from a subject having a cancer or tumor. In some embodiments, the sample is a fresh tumor/cancer sample. In some embodiments, the sample is a frozen tumor/cancer sample. In some embodiments, the sample is a formalin-fixed paraffin-embedded sample. In some embodiments, the sample is processed to a cell lysate. In some embodiments, the sample is processed to DNA or RNA.

The invention also relates to a method of treating a hyperproliferative disorder in a mammal that comprises administering to said mammal a therapeutically effective amount of a compound of the present invention, or a pharmaceutically acceptable salt, ester, prodrug, solvate, hydrate or derivative thereof. In some embodiments, said method relates to the treatment of cancer such as acute myeloid leukemia, cancer in adolescents, adrenocortical carcinoma childhood, AIDS-related cancers (e.g. Lymphoma and Kaposi's Sarcoma), anal cancer, appendix cancer,

astrocytomas, atypical teratoid, basal cell carcinoma, bile duct cancer, bladder cancer, bone cancer, brain stem glioma, brain tumor, breast cancer, bronchial tumors, burkitt lymphoma, carcinoid tumor, atypical teratoid, embryonal tumors, germ cell tumor, primary lymphoma, cervical cancer, childhood cancers, chordoma, cardiac tumors, 5 chronic lymphocytic leukemia (CLL), chronic myelogenous leukemia (CML), chronic myeloproliferative disorders, colon cancer, colorectal cancer, craniopharyngioma, cutaneous T-cell lymphoma, extrahepatic ductal carcinoma in situ (DCIS), embryonal tumors, CNS cancer, endometrial cancer, ependymoma, esophageal cancer, esthesioneuroblastoma, ewing sarcoma, extracranial germ cell tumor, extragonadal 10 germ cell tumor, eye cancer, fibrous histiocytoma of bone, gall bladder cancer, gastric cancer, gastrointestinal carcinoid tumor, gastrointestinal stromal tumors (GIST), germ cell tumor, gestational trophoblastic tumor, hairy cell leukemia, head and neck cancer, heart cancer, liver cancer, hodgkin lymphoma, hypopharyngeal cancer, intraocular melanoma, islet cell tumors, pancreatic neuroendocrine tumors, kidney cancer, 15 laryngeal cancer, lip and oral cavity cancer, liver cancer, lobular carcinoma in situ (LCIS), lung cancer, lymphoma, metastatic squamous neck cancer with occult primary, midline tract carcinoma, mouth cancer multiple endocrine neoplasia syndromes, multiple myeloma/plasma cell neoplasm, mycosis fungoides, myelodysplastic syndromes, myelodysplastic/myeloproliferative neoplasms, multiple 20 myeloma, merkel cell carcinoma, malignant mesothelioma, malignant fibrous histiocytoma of bone and osteosarcoma, nasal cavity and paranasal sinus cancer, nasopharyngeal cancer, neuroblastoma, non-hodgkin lymphoma, non-small cell lung cancer (NSCLC), oral cancer, lip and oral cavity cancer, oropharyngeal cancer, ovarian cancer, pancreatic cancer, papillomatosis, paraganglioma, paranasal sinus and nasal 25 cavity cancer, parathyroid cancer, penile cancer, pharyngeal cancer, pleuropulmonary blastoma, primary central nervous system (CNS) lymphoma, prostate cancer, rectal cancer, transitional cell cancer, retinoblastoma, rhabdomyosarcoma, salivary gland cancer, skin cancer, stomach (gastric) cancer, small cell lung cancer, small intestine cancer, soft tissue sarcoma, T-Cell lymphoma, testicular cancer, throat cancer, 30 thymoma and thymic carcinoma, thyroid cancer, transitional cell cancer of the renal

pelvis and ureter, trophoblastic tumor, unusual cancers of childhood, urethral cancer, uterine sarcoma, vaginal cancer, vulvar cancer, or Viral-Induced cancer. In some embodiments, said method relates to the treatment of a non-cancerous hyperproliferative disorder such as benign hyperplasia of the skin (e. g., psoriasis),
5 restenosis, or prostate (e. g., benign prostatic hypertrophy (BPH)).

In certain particular embodiments, the invention relates to methods for treatment of lung cancers, the methods comprise administering an effective amount of any of the above described compound (or a pharmaceutical composition comprising the same) to a subject in need thereof. In certain embodiments the lung cancer is a non-
10 small cell lung carcinoma (NSCLC), for example adenocarcinoma, squamous-cell lung carcinoma or large-cell lung carcinoma. In other embodiments, the lung cancer is a small cell lung carcinoma. Other lung cancers treatable with the disclosed compounds include, but are not limited to, glandular tumors, carcinoid tumors and undifferentiated carcinomas.

15 Subjects that can be treated with compounds of the invention, or pharmaceutically acceptable salt, ester, prodrug, solvate, tautomer, hydrate or derivative of said compounds, according to the methods of this invention include, for example, subjects that have been diagnosed as having acute myeloid leukemia, acute myeloid leukemia, cancer in adolescents, adrenocortical carcinoma childhood, AIDS-related
20 cancers (e.g. Lymphoma and Kaposi's Sarcoma), anal cancer, appendix cancer, astrocytomas, atypical teratoid, basal cell carcinoma, bile duct cancer, bladder cancer, bone cancer, brain stem glioma, brain tumor, breast cancer, bronchial tumors, burkitt lymphoma, carcinoid tumor, atypical teratoid, embryonal tumors, germ cell tumor, primary lymphoma, cervical cancer, childhood cancers, chordoma, cardiac tumors,
25 chronic lymphocytic leukemia (CLL), chronic myelogenous leukemia (CML), chronic myeloproliferative disorders, colon cancer, colorectal cancer, craniopharyngioma, cutaneous T-cell lymphoma, extrahepatic ductal carcinoma in situ (DCIS), embryonal tumors, CNS cancer, endometrial cancer, ependymoma, esophageal cancer, esthesioneuroblastoma, ewing sarcoma, extracranial germ cell tumor, extragonadal
30 germ cell tumor, eye cancer, fibrous histiocytoma of bone, gall bladder cancer, gastric

cancer, gastrointestinal carcinoid tumor, gastrointestinal stromal tumors (GIST), germ cell tumor, gestational trophoblastic tumor, hairy cell leukemia, head and neck cancer, heart cancer, liver cancer, hodgkin lymphoma, hypopharyngeal cancer, intraocular melanoma, islet cell tumors, pancreatic neuroendocrine tumors, kidney cancer, laryngeal cancer, lip and oral cavity cancer, liver cancer, lobular carcinoma in situ (LCIS), lung cancer, lymphoma, metastatic squamous neck cancer with occult primary, midline tract carcinoma, mouth cancer multiple endocrine neoplasia syndromes, multiple myeloma/plasma cell neoplasm, mycosis fungoides, myelodysplastic syndromes, myelodysplastic/myeloproliferative neoplasms, multiple myeloma, merkel cell carcinoma, malignant mesothelioma, malignant fibrous histiocytoma of bone and osteosarcoma, nasal cavity and paranasal sinus cancer, nasopharyngeal cancer, neuroblastoma, non-hodgkin lymphoma, non-small cell lung cancer (NSCLC), oral cancer, lip and oral cavity cancer, oropharyngeal cancer, ovarian cancer, pancreatic cancer, papillomatosis, paraganglioma, paranasal sinus and nasal cavity cancer, parathyroid cancer, penile cancer, pharyngeal cancer, pleuropulmonary blastoma, primary central nervous system (CNS) lymphoma, prostate cancer, rectal cancer, transitional cell cancer, retinoblastoma, rhabdomyosarcoma, salivary gland cancer, skin cancer, stomach (gastric) cancer, small cell lung cancer, small intestine cancer, soft tissue sarcoma, T-Cell lymphoma, testicular cancer, throat cancer, thymoma and thymic carcinoma, thyroid cancer, transitional cell cancer of the renal pelvis and ureter, trophoblastic tumor, unusual cancers of childhood, urethral cancer, uterine sarcoma, vaginal cancer, vulvar cancer, or Viral-Induced cancer. In some embodiments subjects that are treated with the compounds of the invention include subjects that have been diagnosed as having a non-cancerous hyperproliferative disorder such as benign hyperplasia of the skin (e. g., psoriasis), restenosis, or prostate (e. g., benign prostatic hypertrophy (BPH)).

The invention further provides methods of modulating a G12C Mutant KRAS, HRAS or NRAS protein activity by contacting the protein with an effective amount of a compound of the invention. Modulation can be inhibiting or activating protein activity. In some embodiments, the invention provides methods of inhibiting

protein activity by contacting the G12C Mutant KRAS, HRAS or NRAS protein with an effective amount of a compound of the invention in solution. In some embodiments, the invention provides methods of inhibiting the G12C Mutant KRAS, HRAS or NRAS protein activity by contacting a cell, tissue, organ that express the protein of interest. In
5 some embodiments, the invention provides methods of inhibiting protein activity in subject including but not limited to rodents and mammal (e.g., human) by administering into the subject an effective amount of a compound of the invention. In some
embodiments, the percentage modulation exceeds 25%, 30%, 40%, 50%, 60%, 70%, 80%, or 90%. In some embodiments, the percentage of inhibiting exceeds 25%, 30%,
10 40%, 50%, 60%, 70%, 80%, or 90%.

In some embodiments, the invention provides methods of inhibiting KRAS, HRAS or NRAS G12C activity in a cell by contacting said cell with an amount of a compound of the invention sufficient to inhibit the activity of KRAS, HRAS or NRAS G12C in said cell. In some embodiments, the invention provides methods of
15 inhibiting KRAS, HRAS or NRAS G12C activity in a tissue by contacting said tissue with an amount of a compound of the invention sufficient to inhibit the activity of KRAS, HRAS or NRAS G12C in said tissue. In some embodiments, the invention provides methods of inhibiting KRAS, HRAS or NRAS G12C activity in an organism by contacting said organism with an amount of a compound of the invention sufficient
20 to inhibit the activity of KRAS, HRAS or NRAS G12C in said organism. In some embodiments, the invention provides methods of inhibiting KRAS, HRAS or NRAS G12C activity in an animal by contacting said animal with an amount of a compound of the invention sufficient to inhibit the activity of KRAS, HRAS or NRAS G12C in said animal. In some embodiments, the invention provides methods of inhibiting KRAS,
25 HRAS or NRAS G12C activity in a mammal by contacting said mammal with an amount of a compound of the invention sufficient to inhibit the activity of KRAS, HRAS or NRAS G12C in said mammal. In some embodiments, the invention provides methods of inhibiting KRAS, HRAS or NRAS G12C activity in a human by contacting said human with an amount of a compound of the invention sufficient to inhibit the
30 activity of KRAS, HRAS or NRAS G12C in said human. The present invention

provides methods of treating a disease mediated by KRAS, HRAS or NRAS G12C activity in a subject in need of such treatment.

The present invention also provides methods for combination therapies in which an agent known to modulate other pathways, or other components of the same pathway, or even overlapping sets of target enzymes are used in combination with a
5 compound of the present invention, or a pharmaceutically acceptable salt, ester, prodrug, solvate, tautomer, hydrate or derivative thereof. In one aspect, such therapy includes but is not limited to the combination of one or more compounds of the invention with chemotherapeutic agents, therapeutic antibodies, and radiation treatment,
10 to provide a synergistic or additive therapeutic effect.

In various embodiments, inhibition of mutant KRAS dramatically sensitizes cancer cells to the described combination therapies, leading to robust cell death. Such combination methods have the possibility to greatly improve the outcomes for patients with tumors harboring the KRAS, NRAS or HRAS G12C mutation.

15 Accordingly, in one embodiment a method for treating a KRAS, HRAS or NRAS G12C mutant cancer is provided, the method comprising administering an effective amount of a KRAS, HRAS or NRAS G12C mutant modulating compound and an additional therapeutic agent to a subject in need thereof. In certain embodiments, the cancer is a KRAS G12C mutant cancer. The KRAS, HRAS or NRAS G12C mutant
20 modulating compound is not particularly limited provided the compound modulates (e.g., inhibits) the activity of the KRAS, HRAS or NRAS G12C mutant. Exemplary compounds for this purpose are described herein in the section entitled "Compounds."

In various embodiments of the method, the additional therapeutic agent is an epidermal growth factor receptor (EGFR) inhibitor, phosphatidylinositol kinase
25 (PI3K) inhibitor, insulin-like growth factor receptor (IGF1R) inhibitor, Janus kinase (JAK) inhibitor, a Met kinase inhibitor, a SRC family kinase inhibitor, a mitogen-activated protein kinase (MEK) inhibitor, an extracellular-signal-regulated kinase (ERK) inhibitor, , a topoisomerase inhibitors (such as irinotecan, or such as etoposide, or such as doxorubicin) , taxanes (such as anti-microtubule agents including paclitaxel

and docetaxel), anti-metabolite agents (such as 5-FU or such as gemcitabine), alkylating agents (such as cisplatin or such as cyclophosphamide), or a taxane.

In some embodiments, the additional therapeutic agent is an epidermal growth factor receptor (EGFR) inhibitor, such as Erlotinib or such as Afatinib. In some
5 embodiments the additional therapeutic agent is Iressa. In some embodiments the
additional therapeutic agent is a monoclonal antibody such as cetuximab (Erbix) or
panitumumab (Vectibix). In some embodiments the GFR inhibitor is a dual or pan-
HER inhibitor. In other embodiments, the additional therapeutic agent is a
phosphatidylinositol-3kinase (PI3K) inhibitor, such as GDC0941, MLN1117, BYL719
10 (Alpelisib) or BKM120 (Buparlisib). GDC0941 refers to 2-(1H-indazol-4-yl)-6-(4-
methanesulfonyl-piperazin-1-ylmethyl)-4-morpholin-4-yl-thieno[3,2-d]pyrimidine or a
salt thereof (e.g., bismesylate salt).

In still different embodiments, the additional therapeutic agent is an
insulin-like growth factor receptor (IGF1R) inhibitor. For example, in some
15 embodiments the insulin-like growth factor receptor (IGF1R) inhibitor is NVP-
AEW541. In other embodiments, the additional therapeutic agent is IGOSI-906
(Linsitinib), BMS-754807, or in other embodiments the additional therapeutic agent is a
neutralizing monoclonal antibodies specific to IGF1R such as AMG-479 (ganitumab),
CP-751,871 (figitumumab), IMC-A12 (cixutumumab), MK-0646 (dalotuzumab), and
20 R-1507 (robitumumab).

In some other embodiments, the additional therapeutic agent is a Janus
kinase (JAK) inhibitor. In some embodiments, the additional therapeutic agent is
CYT387, GLPG0634, Baricitinib, Lestaurtinib, momelotinib, Pacritinib, Ruxolitinib or
TG101348

25 In some other embodiments the additional therapeutic agent is an MET
kinase inhibitor, such as Crizotinib, tivantinib, AMG337, cabozantinib, foretinib. In
other embodiments the additional therapeutic agent is a neutralizing monoclonal
antibody to MET such as onartuzumab.

In more embodiments, the additional therapeutic agent is a SRC family
30 non-receptor tyrosine kinase inhibitor. For example in some embodiments the

additional therapeutic agent is an inhibitor of the subfamily of SRC family non-receptor tyrosine kinases. Exemplary inhibitors in this respect include Dasatinib. Other examples in this regard include Ponatinib, saracatinib, and bosutinib

In yet different embodiments, the additional therapeutic agent is a
5 mitogen-activated protein kinase (MEK) inhibitor. In some of these embodiments, the mitogen-activated protein kinase (MEK) inhibitor is trametinib, selumetinib, cobimetinib, PD0325901, or RO5126766. In other embodiments the MEK inhibitor is GSK-1120212, also known as trametinib.

In yet different embodiments, the additional therapeutic agent is an
10 extracellular-signal-regulated kinase (ERK) inhibitor. In some of these embodiments, the mitogen-activated protein kinase (MEK) inhibitor is SCH722984 or GDC-0994.

The exact method for administering the compound and the additional therapeutic agent will be apparent to one of ordinary skill in the art. In some exemplary embodiments the compound and the additional therapeutic agent are co-administered.
15 In other embodiments, the compound and the additional therapeutic agent are separately administered.

In some embodiments, the compound and the additional therapeutic agent are administered with the second agent simultaneously or separately. This administration in combination can include simultaneous administration of the two
20 agents in the same dosage form, simultaneous administration in separate dosage forms, and separate administration. That is, the compound and any of the additional therapeutic agents described herein can be formulated together in the same dosage form and administered simultaneously. Alternatively, the compound and any of the additional therapeutic agents described herein can be simultaneously administered,
25 wherein both the agents are present in separate formulations. In another alternative, the compound can be administered just followed by and any of the additional therapeutic agents described herein, or vice versa. In some embodiments of the separate administration protocol, the compound and any of the additional therapeutic agents described herein are administered a few minutes apart, or a few hours apart, or a few
30 days apart.

In other embodiments, the additional therapeutic agent is a protein kinase inhibitor, such as Staurosporine or Midostaurin. In other embodiments the protein kinase inhibitor is Afatinib, Axitinib, Bevacizumab, Bostutinib, Cetuximab, Crizotinib, Dasatinib, Erlotinib, Fostamatinib, Gefitinib, Imatinib, Lapatinib, Lenvatinib, Ibrutinib, Nilotinib, Panitumumab, Pazopanib, Pegaptanib, Ranibizumab, Ruxolitinib, Sorafenib, Sunitinib, SU6656, Trastuzumab, Tofacitinib, Vandetanib, or Vemurafenib. In still more embodiments, the additional therapeutic agent is a topoisomerase inhibitor. In some of these embodiments, the topoisomerase inhibitor is Irinotecan. In some more embodiments, the additional therapeutic agent is a taxane. Exemplary taxanes include Taxol and Docetaxel.

In addition to the above additional therapeutic agent, other chemotherapeutics are presently known in the art and can be used in combination with the compounds of the invention. In some embodiments, the chemotherapeutic is selected from the group consisting of mitotic inhibitors, alkylating agents, anti-metabolites, intercalating antibiotics, growth factor inhibitors, cell cycle inhibitors, enzymes, topoisomerase inhibitors, biological response modifiers, anti-hormones, angiogenesis inhibitors, and anti-androgens.

Non-limiting examples are chemotherapeutic agents, cytotoxic agents, and non-peptide small molecules such as Gleevec® (Imatinib Mesylate), Velcade® (bortezomib), Casodex (bicalutamide), Iressa® (gefitinib), and Adriamycin as well as a host of chemotherapeutic agents. Non-limiting examples of chemotherapeutic agents include alkylating agents such as thiotepa and cyclophosphamide (CYTOXANTM); alkyl sulfonates such as busulfan, improsulfan and piposulfan; aziridines such as benzodopa, carboquone, meturedopa, and uredopa; ethylenimines and methylamelamines including altretamine, triethylenemelamine, triethylenephosphoramidate, triethylenethiophosphoramidate and trimethylolomelamine; nitrogen mustards such as chlorambucil, chlornaphazine, cholophosphamide, estramustine, ifosfamide, mechlorethamine, mechlorethamine oxide hydrochloride, melphalan, novembichin, phenesterine, prednimustine, trofosfamide, uracil mustard; nitrosureas such as carmustine, chlorozotocin, fotemustine, lomustine, nimustine,

ranimustine; antibiotics such as aclacinomysins, actinomycin, anthramycin, azaserine, bleomycins, cactinomycin, calicheamicin, carabycin, carminomycin, carzinophilin, CasodexTM, chromomycins, dactinomycin, daunorubicin, detorubicin, 6-diazo-5-oxo-L-norleucine, doxorubicin, epirubicin, esorubicin, idarubicin, marcellomycin, 5 mitomycins, mycophenolic acid, nogalamycin, olivomycins, peplomycin, potfiromycin, puromycin, quelamycin, rodorubicin, streptonigrin, streptozocin, tubercidin, ubenimex, zinostatin, zorubicin; anti-metabolites such as methotrexate and 5-fluorouracil (5-FU); folic acid analogues such as denopterin, methotrexate, pteropterin, trimetrexate; purine analogs such as fludarabine, 6-mercaptopurine, thiamiprine, thioguanine; pyrimidine 10 analogs such as ancitabine, azacitidine, 6-azauridine, carmofur, cytarabine, dideoxyuridine, doxifluridine, enocitabine, floxuridine, androgens such as calusterone, dromostanolone propionate, epitiostanol, mepitiothane, testolactone; anti-adrenals such as aminoglutethimide, mitotane, trilostane; folic acid replenisher such as frolic acid; aceglatone; aldophosphamide glycoside; aminolevulinic acid; amsacrine; bestrabucil; 15 bisantrene; edatraxate; defofamine; demecolcine; diaziquone; elfomithine; elliptinium acetate; etoglucid; gallium nitrate; hydroxyurea; lentinan; lonidamine; mitoguanzone; mitoxantrone; mopidamol; nitracrine; pentostatin; phenamet; pirarubicin; podophyllinic acid; 2-ethylhydrazide; procarbazine; PSK.RTM.; razoxane; sizofiran; spirogermanium; tenuazonic acid; triaziquone; 2,2',2''-trichlorotriethylamine; urethan; vindesine; 20 dacarbazine; mannomustine; mitobronitol; mitolactol; pipobroman; gacytosine; arabinoside ("Ara-C"); cyclophosphamide; thiotepa; taxanes, e.g. paclitaxel (TAXOLTM, Bristol-Myers Squibb Oncology, Princeton, N.J.) and docetaxel (TAXOTERETTM, Rhone-Poulenc Rorer, Antony, France); retinoic acid; esperamicins; capecitabine; and pharmaceutically acceptable salts, acids or derivatives of any of the 25 above. Also included as suitable chemotherapeutic cell conditioners are anti-hormonal agents that act to regulate or inhibit hormone action on tumors such as anti-estrogens including for example tamoxifen, (NolvadexTM), raloxifene, aromatase inhibiting 4(5)-imidazoles, 4-hydroxytamoxifen, trioxifene, keoxifene, LY 117018, onapristone, and toremifene (Fareston); and anti-androgens such as flutamide, nilutamide, bicalutamide, 30 leuprolide, and goserelin; chlorambucil; gemcitabine; 6-thioguanine; mercaptopurine;

methotrexate; platinum analogs such as cisplatin and carboplatin; vinblastine; platinum; etoposide (VP-16); ifosfamide; mitomycin C; mitoxantrone; vincristine; vinorelbine; navelbine; novantrone; teniposide; daunomycin; aminopterin; xeloda; ibandronate; camptothecin-11 (CPT-11); topoisomerase inhibitor RFS 2000;

5 difluoromethylornithine (DMFO). Where desired, the compounds or pharmaceutical composition of the present invention can be used in combination with commonly prescribed anti-cancer drugs such as Herceptin®, Avastin®, Erbitux®, Rituxan®, Taxol®, Arimidex®, Taxotere®, ABVD, AVICINE, Abagovomab, Acridine carboxamide, Adecatumumab, 17-N-Allylamino-17-demethoxygeldanamycin,

10 Alfaradin, Alvocidib, 3-Aminopyridine-2-carboxaldehyde thiosemicarbazone, Amonafide, Anthracenedione, Anti-CD22 immunotoxins, Antineoplastic, Antitumorigenic herbs, Apaziquone, Atiprimod, Azathioprine, Belotecan, Bendamustine, BIBW 2992, Biricodar, Brostallicin, Bryostatin, Buthionine sulfoximine, CBV (chemotherapy), Calyculin, cell-cycle nonspecific antineoplastic

15 agents, Dichloroacetic acid, Discodermolide, Elsamitrucin, Enocitabine, Epothilone, Eribulin, Everolimus, Exatecan, Exisulind, Ferruginol, Forodesine, Fosfestrol, ICE chemotherapy regimen, IT-101, Imexon, Imiquimod, Indolocarbazole, Irofulven, Laniquidar, Larotaxel, Lenalidomide, Lucanthone, Lurtotecan, Mafosfamide, Mitozolomide, Nafoxidine, Nedaplatin, Olaparib, Ortataxel, PAC-1, Pawpaw,

20 Pixantrone, Proteasome inhibitor, Rebeccamycin, Resiquimod, Rubitecan, SN-38, Salinosporamide A, Sapacitabine, Stanford V, Swainsonine, Talaporfin, Tariquidar, Tegafur-uracil, Temodar, Tesetaxel, Triplatin tetranitrate, Tris(2-chloroethyl)amine, Troxacitabine, Uramustine, Vadimezan, Vinflunine, ZD6126 or Zosuquidar.

The exact method for administering the compound and the additional

25 therapeutic agent will be apparent to one of ordinary skill in the art. In some exemplary embodiments the compound and the additional therapeutic agent are co-administered. In other embodiments, the compound and the additional therapeutic agent are separately administered.

In some embodiments, the compound and the additional therapeutic

30 agent are administered with the second agent simultaneously or separately. This

administration in combination can include simultaneous administration of the two agents in the same dosage form, simultaneous administration in separate dosage forms, and separate administration. That is, the compound and any of the additional therapeutic agents described herein can be formulated together in the same dosage form and administered simultaneously. Alternatively, the compound and any of the additional therapeutic agents described herein can be simultaneously administered, wherein both the agents are present in separate formulations. In another alternative, the compound can be administered just followed by and any of the additional therapeutic agents described herein, or vice versa. In some embodiments of the separate administration protocol, the compound and any of the additional therapeutic agents described herein are administered a few minutes apart, or a few hours apart, or a few days apart.

This invention further relates to a method for using the compounds or pharmaceutical compositions provided herein, in combination with radiation therapy for inhibiting abnormal cell growth or treating the hyperproliferative disorder in the mammal. Techniques for administering radiation therapy are known in the art, and these techniques can be used in the combination therapy described herein. The administration of the compound of the invention in this combination therapy can be determined as described herein.

Radiation therapy can be administered through one of several methods, or a combination of methods, including without limitation external-beam therapy, internal radiation therapy, implant radiation, stereotactic radiosurgery, systemic radiation therapy, radiotherapy and permanent or temporary interstitial brachytherapy. The term "brachytherapy," as used herein, refers to radiation therapy delivered by a spatially confined radioactive material inserted into the body at or near a tumor or other proliferative tissue disease site. The term is intended without limitation to include exposure to radioactive isotopes (e.g. At-211, I-131, I-125, Y-90, Re-186, Re-188, Sm-153, Bi-212, P-32, and radioactive isotopes of Lu). Suitable radiation sources for use as a cell conditioner of the present invention include both solids and liquids. By way of non-limiting example, the radiation source can be a radionuclide, such as I-125, I-131,

Yb-169, Ir-192 as a solid source, I-125 as a solid source, or other radionuclides that emit photons, beta particles, gamma radiation, or other therapeutic rays. The radioactive material can also be a fluid made from any solution of radionuclide(s), e.g., a solution of I-125 or I-131, or a radioactive fluid can be produced using a slurry of a suitable fluid containing small particles of solid radionuclides, such as Au-198, Y-90. Moreover, the radionuclide(s) can be embodied in a gel or radioactive micro spheres.

Without being limited by any theory, the compounds of the present invention can render abnormal cells more sensitive to treatment with radiation for purposes of killing and/or inhibiting the growth of such cells. Accordingly, this invention further relates to a method for sensitizing abnormal cells in a mammal to treatment with radiation which comprises administering to the mammal an amount of a compound of the present invention or pharmaceutically acceptable salt, ester, prodrug, solvate, hydrate or derivative thereof, which amount is effective is sensitizing abnormal cells to treatment with radiation. The amount of the compound, salt, or solvate in this method can be determined according to the means for ascertaining effective amounts of such compounds described herein.

The compounds or pharmaceutical compositions of the invention can be used in combination with an amount of one or more substances selected from anti-angiogenesis agents, signal transduction inhibitors, antiproliferative agents, glycolysis inhibitors, or autophagy inhibitors.

Anti-angiogenesis agents, such as MMP-2 (matrix-metalloproteinase 2) inhibitors, MMP-9 (matrix-metalloprotenase 9) inhibitors, and COX-11 (cyclooxygenase 11) inhibitors, can be used in conjunction with a compound of the invention and pharmaceutical compositions described herein. Anti-angiogenesis agents include, for example, rapamycin, temsirolimus (CCI-779), everolimus (RAD001), sorafenib, sunitinib, and bevacizumab. Examples of useful COX-II inhibitors include CELEBREXTM (alecoxib), valdecoxib, and rofecoxib. Examples of useful matrix metalloproteinase inhibitors are described in WO 96/33172 (published October 24, 1996), WO 96/27583 (published March 7, 1996), European Patent Application No. 97304971.1 (filed July 8, 1997), European Patent Application No. 99308617.2 (filed

October 29, 1999), WO 98/07697 (published February 26, 1998), WO 98/03516 (published January 29, 1998), WO 98/34918 (published August 13, 1998), WO 98/34915 (published August 13, 1998), WO 98/33768 (published August 6, 1998), WO 98/30566 (published July 16, 1998), European Patent Publication 606,046 (published July 5 13, 1994), European Patent Publication 931, 788 (published July 28, 1999), WO 90/05719 (published May 31, 1990), WO 99/52910 (published October 21, 1999), WO 99/52889 (published October 21, 1999), WO 99/29667 (published June 17, 1999), PCT International Application No. PCT/IB98/01113 (filed July 21, 1998), European Patent Application No. 99302232.1 (filed March 25, 1999), Great Britain Patent Application 10 No. 9912961.1 (filed June 3, 1999), United States Provisional Application No. 60/148,464 (filed August 12, 1999), United States Patent 5,863, 949 (issued January 26, 1999), United States Patent 5,861, 510 (issued January 19, 1999), and European Patent Publication 780,386 (published June 25, 1997), all of which are incorporated herein in their entireties by reference. Preferred MMP-2 and MMP-9 inhibitors are 15 those that have little or no activity inhibiting MMP-1. More preferred, are those that selectively inhibit MMP-2 and/or AMP-9 relative to the other matrix-metalloproteinases (i. e., MAP-1, MMP-3, MMP-4, MMP-5, MMP-6, MMP- 7, MMP- 8, MMP-10, MMP-11, MMP-12, and MMP-13). Some specific examples of MMP inhibitors useful in the invention are AG-3340, RO 32-3555, and RS 13-0830.

20 Autophagy inhibitors include, but are not limited to chloroquine, 3-methyladenine, hydroxychloroquine (Plaquenil™), bafilomycin A1, 5-amino-4-imidazole carboxamide riboside (AICAR), okadaic acid, autophagy-suppressive algal toxins which inhibit protein phosphatases of type 2A or type 1, analogues of cAMP, and drugs which elevate cAMP levels such as adenosine, LY204002, N6-mercaptopurine 25 riboside, and vinblastine. In addition, antisense or siRNA that inhibits expression of proteins including but not limited to ATG5 (which are implicated in autophagy), may also be used.

The invention also relates to a method of and to a pharmaceutical composition for treating a cardiovascular disease in a mammal which comprises an 30 amount of a compound of the invention, or a pharmaceutically acceptable salt, ester,

prodrug, solvate, tautomer, hydrate or derivative thereof, or an isotopically-labeled derivative thereof, and an amount of one or more therapeutic agents use for the treatment of cardiovascular diseases.

Exemplary agents for use in cardiovascular disease applications are anti-
5 thrombotic agents, e.g., prostacyclin and salicylates, thrombolytic agents, e.g.,
streptokinase, urokinase, tissue plasminogen activator (TPA) and anisoylated
plasminogen-streptokinase activator complex (APSAC), anti-platelets agents, e.g.,
acetyl-salicylic acid (ASA) and clopidrogel, vasodilating agents, e.g., nitrates, calcium
channel blocking drugs, anti-proliferative agents, e.g., colchicine and alkylating agents,
10 intercalating agents, growth modulating factors such as interleukins, transformation
growth factor-beta and congeners of platelet derived growth factor, monoclonal
antibodies directed against growth factors, anti-inflammatory agents, both steroidal and
non-steroidal, and other agents that can modulate vessel tone, function, arteriosclerosis,
and the healing response to vessel or organ injury post intervention. Antibiotics can
15 also be included in combinations or coatings comprised by the invention. Moreover, a
coating can be used to effect therapeutic delivery focally within the vessel wall. By
incorporation of the active agent in a swellable polymer, the active agent will be
released upon swelling of the polymer.

In some embodiments, the compounds described herein are formulated
20 or administered in conjunction with liquid or solid tissue barriers also known as
lubricants. Examples of tissue barriers include, but are not limited to, polysaccharides,
polyglycans, seprafilm, interceed and hyaluronic acid.

In some embodiments, medicaments which are administered in
conjunction with the compounds described herein include any suitable drugs usefully
25 delivered by inhalation for example, analgesics, e.g. codeine, dihydromorphine,
ergotamine, fentanyl or morphine; anginal preparations, e.g. diltiazem; antiallergics,
e.g. cromoglycate, ketotifen or nedocromil; anti-infectives, e.g. cephalosporins,
penicillins, streptomycin, sulphonamides, tetracyclines or pentamidine; antihistamines,
e.g. methapyrilene; anti-inflammatories, e.g. beclomethasone, flunisolide, budesonide,
30 tiptredane, triamcinolone acetone or fluticasone; antitussives, e.g. noscapine;

bronchodilators, e.g. ephedrine, adrenaline, fenoterol, formoterol, isoprenaline, metaproterenol, phenylephrine, phenylpropanolamine, pirbuterol, reproterol, rimiterol, salbutamol, salmeterol, terbutalin, isoetharine, tulobuterol, orciprenaline or (-)-4-amino-3,5-dichloro- α -[[[6-[2-(2-pyridinyl)ethoxy]hexyl]-amino]methyl]benzenemethanol;

5 diuretics, e.g. amiloride; anticholinergics e.g. ipratropium, atropine or oxitropium; hormones, e.g. cortisone, hydrocortisone or prednisolone; xanthines e.g. aminophylline, choline theophyllinate, lysine theophyllinate or theophylline; and therapeutic proteins and peptides, e.g. insulin or glucagon. It will be clear to a person skilled in the art that, where appropriate, the medicaments are used in the form of salts (e.g. as alkali metal or

10 amine salts or as acid addition salts) or as esters (e.g. lower alkyl esters) or as solvates (e.g. hydrates) to optimize the activity and/or stability of the medicament.

Other exemplary therapeutic agents useful for a combination therapy include but are not limited to agents as described above, radiation therapy, hormone antagonists, hormones and their releasing factors, thyroid and antithyroid drugs,

15 estrogens and progestins, androgens, adrenocorticotrophic hormone; adrenocortical steroids and their synthetic analogs; inhibitors of the synthesis and actions of adrenocortical hormones, insulin, oral hypoglycemic agents, and the pharmacology of the endocrine pancreas, agents affecting calcification and bone turnover: calcium, phosphate, parathyroid hormone, vitamin D, calcitonin, vitamins such as water-soluble

20 vitamins, vitamin B complex, ascorbic acid, fat-soluble vitamins, vitamins A, K, and E, growth factors, cytokines, chemokines, muscarinic receptor agonists and antagonists; anticholinesterase agents; agents acting at the neuromuscular junction and/or autonomic ganglia; catecholamines, sympathomimetic drugs, and adrenergic receptor agonists or antagonists; and 5-hydroxytryptamine (5-HT, serotonin) receptor agonists

25 and antagonists.

Therapeutic agents can also include agents for pain and inflammation such as histamine and histamine antagonists, bradykinin and bradykinin antagonists, 5-hydroxytryptamine (serotonin), lipid substances that are generated by biotransformation of the products of the selective hydrolysis of membrane phospholipids, eicosanoids,

30 prostaglandins, thromboxanes, leukotrienes, aspirin, nonsteroidal anti-inflammatory

agents, analgesic-antipyretic agents, agents that inhibit the synthesis of prostaglandins and thromboxanes, selective inhibitors of the inducible cyclooxygenase, selective inhibitors of the inducible cyclooxygenase-2, autacoids, paracrine hormones, somatostatin, gastrin, cytokines that mediate interactions involved in humoral and cellular immune responses, lipid-derived autacoids, eicosanoids, β -adrenergic agonists, ipratropium, glucocorticoids, methylxanthines, sodium channel blockers, opioid receptor agonists, calcium channel blockers, membrane stabilizers and leukotriene inhibitors.

Additional therapeutic agents contemplated herein include diuretics, vasopressin, agents affecting the renal conservation of water, rennin, angiotensin, agents useful in the treatment of myocardial ischemia, anti-hypertensive agents, angiotensin converting enzyme inhibitors, β -adrenergic receptor antagonists, agents for the treatment of hypercholesterolemia, and agents for the treatment of dyslipidemia.

Other therapeutic agents contemplated include drugs used for control of gastric acidity, agents for the treatment of peptic ulcers, agents for the treatment of gastroesophageal reflux disease, prokinetic agents, antiemetics, agents used in irritable bowel syndrome, agents used for diarrhea, agents used for constipation, agents used for inflammatory bowel disease, agents used for biliary disease, agents used for pancreatic disease. Therapeutic agents used to treat protozoan infections, drugs used to treat Malaria, Amebiasis, Giardiasis, Trichomoniasis, Trypanosomiasis, and/or Leishmaniasis, and/or drugs used in the chemotherapy of helminthiasis. Other therapeutic agents include antimicrobial agents, sulfonamides, trimethoprim-sulfamethoxazole quinolones, and agents for urinary tract infections, penicillins, cephalosporins, and other, β -lactam antibiotics, an agent comprising an aminoglycoside, protein synthesis inhibitors, drugs used in the chemotherapy of tuberculosis, mycobacterium avium complex disease, and leprosy, antifungal agents, antiviral agents including nonretroviral agents and antiretroviral agents.

Examples of therapeutic antibodies that can be combined with a compound of the invention include but are not limited to anti-receptor tyrosine kinase antibodies (cetuximab, panitumumab, tRAStuzumab), anti CD20 antibodies (rituximab,

tositumomab), and other antibodies such as alemtuzumab, bevacizumab, and gemtuzumab.

Moreover, therapeutic agents used for immunomodulation, such as immunomodulators, immunosuppressive agents, tolerogens, and immunostimulants are contemplated by the methods herein. In addition, therapeutic agents acting on the blood and the blood-forming organs, hematopoietic agents, growth factors, minerals, and vitamins, anticoagulant, thrombolytic, and antiplatelet drugs.

For treating renal carcinoma, one may combine a compound of the present invention with sorafenib and/or avastin. For treating an endometrial disorder, one may combine a compound of the present invention with doxorubicin, taxotere (taxol), and/or cisplatin (carboplatin). For treating ovarian cancer, one may combine a compound of the present invention with cisplatin (carboplatin), taxotere, doxorubicin, topotecan, and/or tamoxifen. For treating breast cancer, one may combine a compound of the present invention with taxotere (taxol), gemcitabine (capecitabine), tamoxifen, letrozole, tarceva, lapatinib, PD0325901, avastin, herceptin, OSI-906, and/or OSI-930. For treating lung cancer, one may combine a compound of the present invention with taxotere (taxol), gemcitabine, cisplatin, pemetrexed, Tarceva, PD0325901, and/or avastin.

Further therapeutic agents that can be combined with a compound of the invention are found in Goodman and Gilman's "The Pharmacological Basis of Therapeutics" Tenth Edition edited by Hardman, Limbird and Gilman or the Physician's Desk Reference, both of which are incorporated herein by reference in their entirety.

The compounds described herein can be used in combination with the agents disclosed herein or other suitable agents, depending on the condition being treated. Hence, in some embodiments the one or more compounds of the invention will be co-administered with other agents as described above. When used in combination therapy, the compounds described herein are administered with the second agent simultaneously or separately. This administration in combination can include simultaneous administration of the two agents in the same dosage form, simultaneous

administration in separate dosage forms, and separate administration. That is, a compound described herein and any of the agents described above can be formulated together in the same dosage form and administered simultaneously. Alternatively, a compound of the invention and any of the agents described above can be

5 simultaneously administered, wherein both the agents are present in separate formulations. In another alternative, a compound of the present invention can be administered just followed by and any of the agents described above, or vice versa. In some embodiments of the separate administration protocol, a compound of the invention and any of the agents described above are administered a few minutes apart,

10 or a few hours apart, or a few days apart.

The examples and preparations provided below further illustrate and exemplify the compounds of the present invention and methods of preparing such compounds. It is to be understood that the scope of the present invention is not limited in any way by the scope of the following examples and preparations. In the following

15 examples, and throughout the specification and claims, molecules with a single chiral center, unless otherwise noted, exist as a racemic mixture. Those molecules with two or more chiral centers, unless otherwise noted, exist as a racemic mixture of diastereomers. Single enantiomers/diastereomers may be obtained by methods known to those skilled in the art.

20

EXAMPLE 1

BIOCHEMICAL ASSAY OF THE COMPOUNDS

Test compounds are prepared as 10 mM stock solutions in DMSO (Fisher cat# BP-231-100). KRAS G12C 1-169, his-tagged protein, GDP-loaded is
5 diluted to 2 μ m in buffer (20mM Hepes, 150mM NaCl, 1mM MgCl₂). Compounds are tested for activity as follows:

Compounds are diluted to 50X final test concentration in DMSO in 96-well storage plates. Compound stock solutions are vortexed before use and observed carefully for any sign of precipitation. Dilutions are as follow:

10 For 100 μ M final compound concentration, compounds are diluted to 5000 μ M (5 μ l 10mM compound stock + 5 μ l DMSO and mixed well by pipetting.

For 30 μ M final compound concentration, compounds are diluted to 1500 μ M (3 μ l 10mM compound stock + 17 μ l DMSO) and mixed well by pipetting.

For 10 μ M final compound concentration, compounds are diluted to
15 500 μ M (2 μ l 10mM compound stock + 38 μ l DMSO) and mixed well by pipetting. 49 μ l of the stock protein solution is added to each well of a 96-well PCR plate (Fisher cat# 1423027). 1 μ l of the diluted 50X compounds are added to appropriate wells in the PCR plate using 12-channel pipettor. Reactions are mixed carefully and thoroughly by pipetting up/down with a 200 μ l multi-channel pipettor. The plate is sealed well with
20 aluminum plate seal, and stored in drawer at room temperature for 24hrs. 5 μ l of 2% formic acid (Fisher cat# A117) in DI H₂O is then added to each well followed by mixing with a pipette. The plate is then resealed with aluminum seal and stored on dry ice until analyzed as described below.

The above described assays are analyzed by mass spectrometry
25 according to the following procedure:

The MS instrument is set to positive polarity, 2 GHz resolution, and low mass (1700) mode and allowed to equilibrate for 30 minutes. The instrument is then calibrated, switched to acquisition mode and the appropriate method loaded.

After another 30 minute equilibration time, a blank batch (*i.e.*, buffer) is
30 run to ensure equipment is operating properly. The samples are thawed at 37°C for 10

minutes, briefly centrifuged, and transfer to the bench top. Wells A1 and H12 are spiked with 1 uL 500 uM internal standard peptide, and the plates centrifuged at 2000 x g for 5 minutes. The method is then run and masses of each individual well recorded.

The masses (for which integration data is desired) for each well are
5 pasted into the platemap and exported from the analysis. Masses for the internal standards are exported as well. The data at 50 ppm is extracted for the +19 charge state, and identity of well A1 is assigned using the internal standard spike and integrated. Peak data is exported as a TOF list and the above steps are repeated individually, for the +20, 21, 22, 23, 24, and 25 charge states.

10 Other in vitro analyses are as follows:

Inhibition of Cell Growth:

The ability of the subject compounds to inhibit RAS-mediated cell growth is assessed and demonstrated as follows. Cells expressing a wildtype or a mutant RAS are plated in white, clear bottom 96 well plates at a density of 5,000 cells
15 per well. Cells are allowed to attach for about 2 hours after plating before a compound disclosed herein is added. After certain hours (e.g., 24 hours, 48 hours, or 72 hours of cell growth), cell proliferation is determined by measuring total ATP content using the Cell Titer Glo reagent (Promega) according to manufacturer's instructions. Proliferation EC50s is determined by analyzing 8 point compound dose responses at
20 half-log intervals decreasing from 100 μ M.

Inhibition of RAS-mediated signaling transduction:

The ability of the compounds disclosed herein in inhibiting RAS-mediated signaling is assessed and demonstrated as follows. Cells expressing wild type or a mutant RAS (such as G12C, G12V, or G12A) are treated with or without (control
25 cells) a subject compound. Inhibition of RAS signaling by one or more subject compounds is demonstrated by a decrease in the steady-state level of phosphorylated MEK, and/or Raf binding in cells treated with the one or more of the subject compounds as compared to the control cells.

Inhibition of RAS-mediated signaling transduction:

The ability of the compounds disclosed herein in inhibiting RAS-mediated signaling is assessed and demonstrated as follows. Cells expressing wild type or a mutant RAS (such as G12C, G12V, or G12A) are treated with or without (control
5 cells) a subject compound. Inhibition of RAS signaling by one or more subject compounds is demonstrated by percentage binding of compound to the G12C mutated RAS protein in cells treated with the one or more of the subject compounds as compared to the control cells.

Inhibition of RAS-mediated signaling transduction:

10 The ability of the compounds disclosed herein in inhibiting RAS-mediated signaling is assessed and demonstrated as follows. Cells expressing wild type or a mutant RAS (such as G12C, G12V, or G12A) are treated with or without (control cells) a subject compound. Inhibition of RAS signaling by one or more subject
15 compounds is demonstrated by a decrease in binding of RAS complex to downstream signaling molecules (for example Raf) in cells treated with the one or more of the subject compounds as compared to the control cells.

Exemplary compounds of structure (I), including exemplary compounds from Table 1 are tested according to the above methods and found to covalently bind to KRAS G12C to the extent of at least about 5% after 2 hour incubation (*i.e.*, at least
20 about 5% of the protein present in the well was found to be covalently bound to test compound).

All of the U.S. patents, U.S. patent application publications, U.S. patent applications, foreign patents, foreign patent applications and non-patent publications referred to in this specification or the attached Application Data Sheet are incorporated
25 herein by reference, in their entirety to the extent not inconsistent with the present description.

U.S. provisional patent application Serial No. 62/233,597 filed September 28, 2015, entitled "INHIBITORS OF KRAS G12C MUTANT PROTEINS" is incorporated herein by reference, in its entirety.

From the foregoing it will be appreciated that, although specific embodiments of the invention have been described herein for purposes of illustration, various modifications may be made without deviating from the spirit and scope of the invention. Accordingly, the invention is not limited except as by the appended claims.

CLAIMS

1. A compound having the following structure (I):

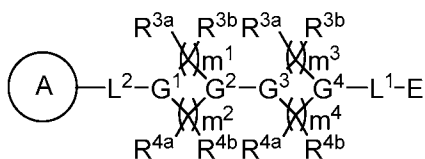

(I)

or a pharmaceutically acceptable salt, tautomer, stereoisomer or prodrug thereof, wherein:

G^1 , G^2 , G^3 and G^4 are each independently N or CR, where R is H, cyano, halo or C_1 - C_6 alkyl;

A is a fused bicyclic heteroaryl comprising two or more heteroatoms, wherein H is substituted with R^1 and R^2 ;

R^1 and R^2 are each independently H, halo, hydroxyl, cyano, aminocarbonyl, formyl, C_1 - C_6 alkyl, C_1 - C_6 alkylsulfonyl, C_1 - C_6 haloalkyl, C_3 - C_8 cycloalkyl, C_1 - C_6 alkoxy, C_1 - C_6 hydroxylalkyl, C_1 - C_6 alkoxyalkyl, C_1 - C_6 aminoalkyl, aliphatic heterocyclyl, heteroaryl or aryl, provided that at least one of R^1 or R^2 is not H;

R^{3a} and R^{3b} are, at each occurrence, independently H, -OH, -NH₂, -CO₂H, halo, cyano, C_1 - C_6 alkyl, C_1 - C_6 alkynyl, hydroxylalkyl, aminylalkyl, alkylaminylalkyl, cyanoalkyl, carboxyalkyl, aminocarbonylalkyl or aminocarbonyl; or one R^{3a} and one R^{3b} join to form a carbocyclic or heterocyclic ring, and each remaining R^{3a} and R^{3b} are, at each occurrence, independently H, -OH, -NH₂, -CO₂H, halo, cyano, C_1 - C_6 alkyl, C_1 - C_6 alkynyl, hydroxylalkyl, aminylalkyl, alkylaminylalkyl, cyanoalkyl, carboxyalkyl, aminocarbonylalkyl or aminocarbonyl; or one R^{3b} joins with one R^{4b} to form a carbocyclic or heterocyclic ring, and each R^{3a} and each remaining R^{3b} are, at each occurrence, independently H, -OH, -NH₂, -CO₂H, halo, cyano, C_1 - C_6 alkyl, C_1 - C_6 alkynyl, hydroxylalkyl, aminylalkyl, alkylaminylalkyl, cyanoalkyl, carboxyalkyl, aminylcarbonylalkyl or aminylcarbonyl;

R^{4a} and R^{4b} are, at each occurrence, independently

H, -OH, -NH₂, -CO₂H, halo, cyano, C₁-C₆ alkyl, C₁-C₆ alkynyl, hydroxylalkyl, aminylalkyl, alkylaminylalkyl, cyanoalkyl, carboxyalkyl, aminocarbonylalkyl or aminocarbonyl; or one R^{4a} and one R^{4b} join to form a carbocyclic or heterocyclic ring, and each remaining R^{4a} and R^{4b} are, at each occurrence, independently

H, -OH, -NH₂, -CO₂H, halo, cyano, C₁-C₆ alkyl, C₁-C₆ alkynyl, hydroxylalkyl, aminylalkyl, alkylaminylalkyl, cyanoalkyl, carboxyalkyl, aminocarbonylalkyl or aminocarbonyl; or one R^{4b} joins with one R^{3b} to form a carbocyclic or heterocyclic ring, and each R^{4a} and each remaining R^{4b} are, at each occurrence, independently

H, -OH, -NH₂, -CO₂H, halo, cyano, C₁-C₆ alkyl, C₁-C₆ alkynyl, hydroxylalkyl, aminylalkyl, alkylaminylalkyl, cyanoalkyl, carboxyalkyl, aminylcarbonylalkyl or aminylcarbonyl;

L^1 is a bond or alkylene;

L^2 is a bond or a one or two carbon alkylene optionally substituted with oxo;

m^1 , m^2 , m^3 and m^4 are each independently 1, 2 or 3; and

E is an electrophilic moiety capable of forming a covalent bond with the cysteine residue at position 12 of a KRAS, HRAS or NRAS G12C mutant protein, wherein all valences are satisfied.

2. The compound of claim 1, wherein the compound has one of the following structures (Ia), (Ib), (Ic), (Id), (Ie) or (If):

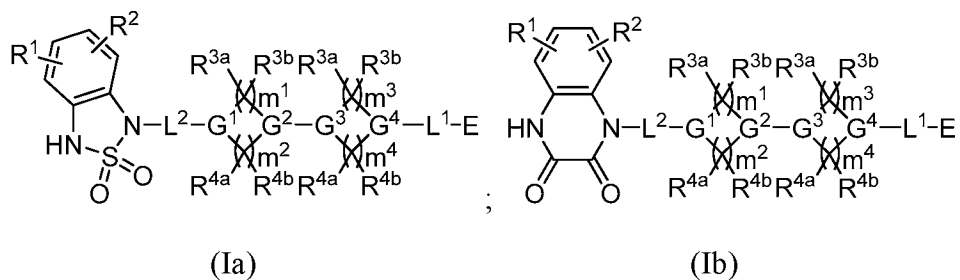

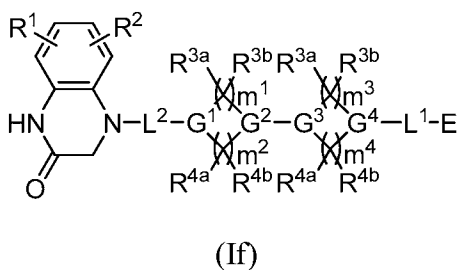
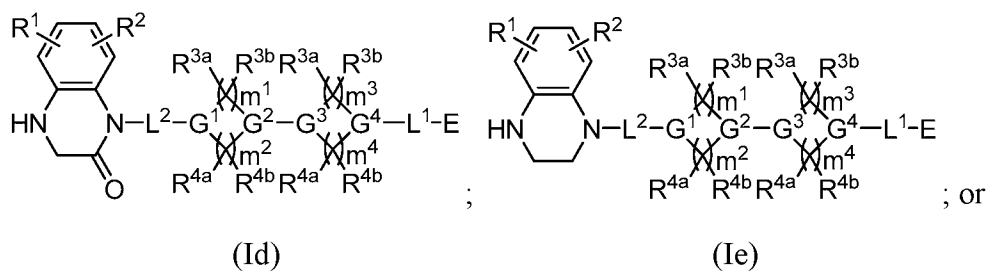

3. The compound of claim 1, wherein the compound has one of the following structures (Ia'), (Ib'), (Ic'), (Id'), (Ie') or (If'):

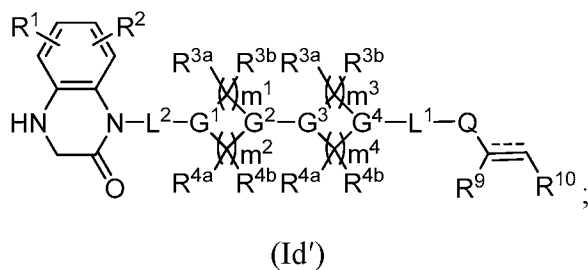
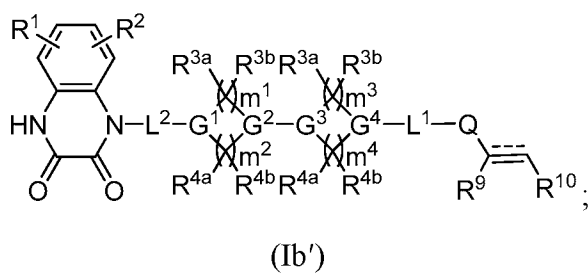
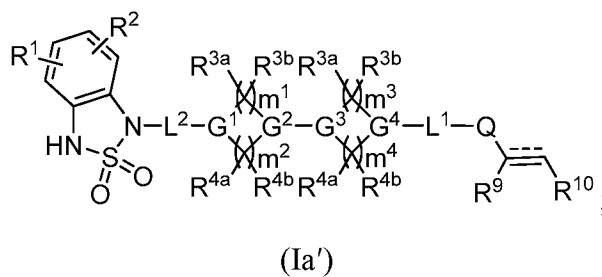

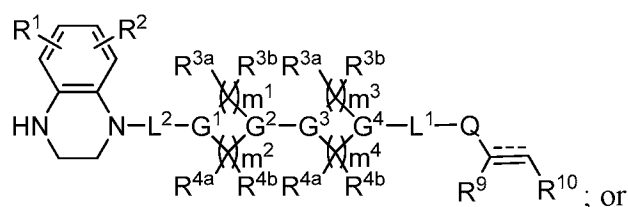

(Ie')

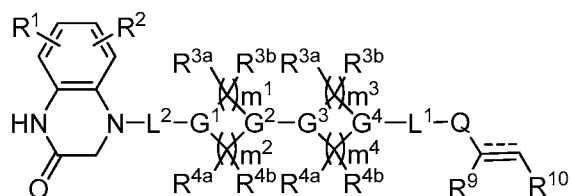

(If')

wherein:

\equiv represents a double or triple bond;

Q is $-C(=O)-$, $-C(=NR^7)-$, $-NR^8C(=O)-$, $-S(=O)_2-$ or $-NR^8S(=O)_2-$;

R^7 is H, $-OH$, $-CN$ or C_1-C_6 alkyl;

R^8 is H, C_1-C_6 alkyl or hydroxylalkyl;

when \equiv is a double bond then R^9 and R^{10} are each independently H, cyano, carboxyl, C_1-C_6 alkyl, alkoxycarbonyl, aminylalkyl, alkylaminylalkyl, heteroaryl or hydroxylalkyl or R^9 and R^{10} join to form a carbocyclic or heterocyclic ring; and

when \equiv is a triple bond then R^9 is absent and R^{10} is H, C_1-C_6 alkyl, aminylalkyl, alkylaminylalkyl or hydroxylalkyl.

4. The compound of claim 3, wherein the compound has one of the following structures (Ia''), (Ib''), (Ic''), (Id''), (Ie'') or (If''):

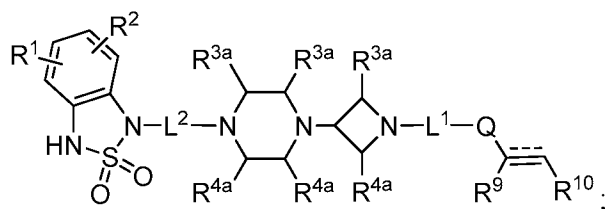

(Ia'')

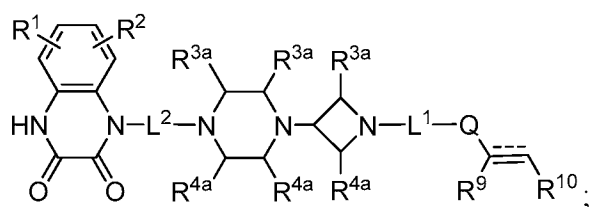

(Ib'')

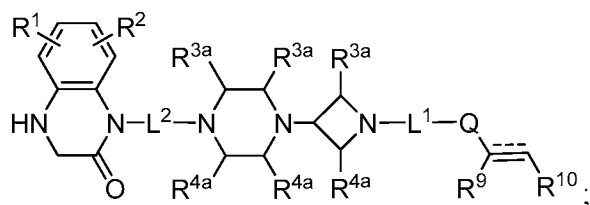

(Id'')

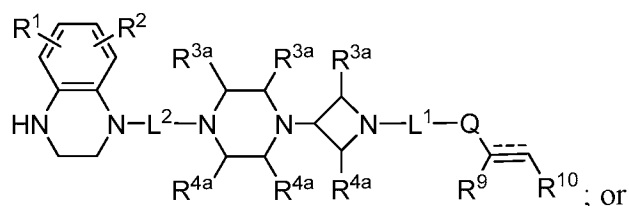

(Ie'')

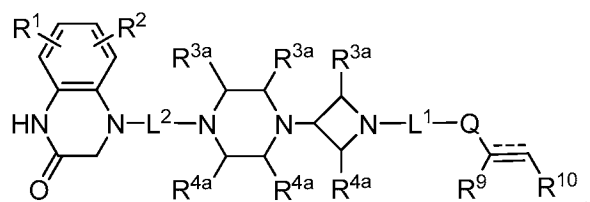

(If'')

5. The compound of any one of claims 1-4, wherein A comprises Nitrogen or sulfur or combinations thereof.

6. The compound of claim 5, wherein A is tetrahydroquinoxalineyl, dihydroquinoxalinoneyl, quinoxalinedioneyl, benzoimidazolethienyl or indolinoneyl.

7. The compound of any one of claims 5-6, wherein A is substituted with R¹ and R².

8. The compound of any one of claims 5-6, wherein A is substituted with R¹.
9. The compound of any one of claims 5-6, wherein R¹ and R² are different.
10. The compound of claim 8, wherein R¹ or R² is fluoro, chloro, bromo, iodo, hydroxyl, cyano, methyl, ethyl, isopropyl, methylsulfonyl, methoxy, aminocarbonyl, trifluoromethyl, 2,2,2-trifluorethyl, cyclobutyl, cyclopropyl or phenyl, wherein the cyclopropyl and phenyl are optionally substituted with one or more substituents selected from C₁-C₆alkyl, halo, hydroxyl and cyano.
11. The compound of claim 8, wherein R¹ or R² is fluoro, chloro, bromo, iodo, hydroxyl, methyl, ethyl, cyclobutyl or cyclopropyl, wherein the cyclopropyl is optionally substituted with one or more substituents selected from C₁-C₆alkyl, halo, hydroxyl and cyano.
12. The compound of claim 8, wherein R¹ or R² is fluoro, chloro, bromo, hydroxyl or cyclopropyl, wherein the cyclopropyl is optionally substituted with one or more substituents selected from C₁-C₆alkyl, halo, hydroxyl and cyano.
13. The compound of claim 8, wherein R¹ is chloro and R² is chloro or cyclopropyl.
14. The compound of any one of claims 1-13, wherein A has one of the following structures:

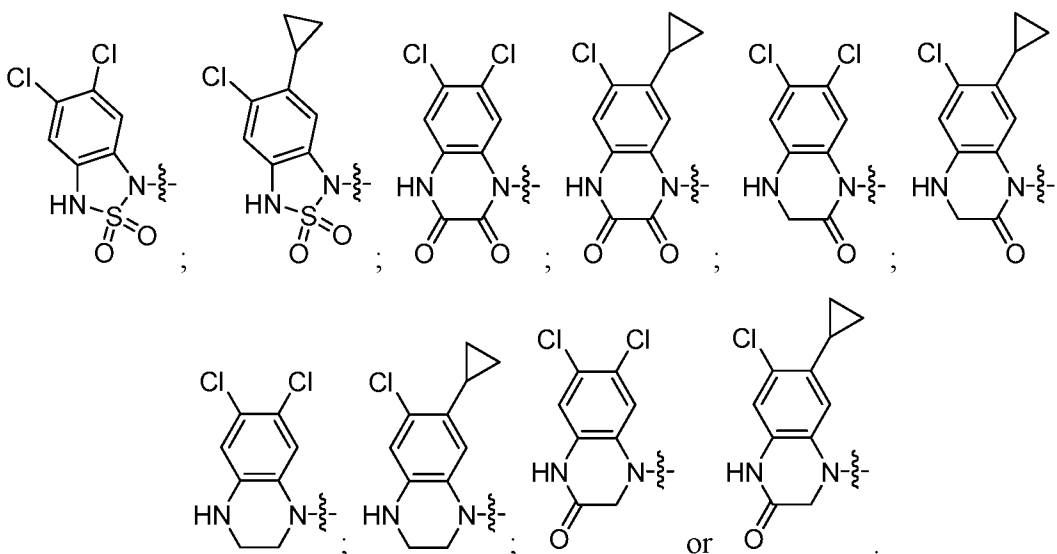

15. The compound of any one of claims 1-14, wherein L^2 is a bond.
16. The compound of any one of claims 1-14, wherein L^2 is $-\text{CH}_2\text{C}(=\text{O})-$.
17. The compound of any one of claims 3-16, wherein Q is $-\text{C}(=\text{O})-$.
18. The compound of any one of claims 3-16, wherein Q is $-\text{S}(=\text{O})_2-$.
19. The compound of any one of claims 3-16, wherein Q is $-\text{C}(=\text{NR}^7)-$.
20. The compound of any one of claims 3-16, wherein Q is $-\text{NR}^8\text{C}(=\text{O})-$.
21. The compound of any one of claims 3-16, wherein Q is $-\text{NR}^8\text{S}(=\text{O})_2-$.
22. The compound of any one of claims 20 or 21, wherein R^8 is H.

23. The compound of any one of claims 20 or 21, wherein R⁸ is hydroxylalkyl.
24. The compound of claim 23, wherein hydroxylalkyl is 2-hydroxylalkyl.
25. The compound of any one of claims 3-24, wherein at least one of R⁹ or R¹⁰ is H.
26. The compound of claim 25, wherein each of R⁹ and R¹⁰ are H.
27. The compound of any of one of claims 3-25, wherein R¹⁰ is alkylaminylalkyl.
28. The compound of claim 27, wherein R¹⁰ has the following structure:
- CN(C)C
29. The compound of any of one of claims 3-25, wherein R¹⁰ is hydroxylalkyl.
30. The compound of claim 29, wherein hydroxylalkyl is 2-hydroxylalkyl
31. The compound of any one of claims 3-24, wherein R⁹ and R¹⁰ join to form a carbocyclic ring.
32. The compound of claim 31, wherein the carbocyclic ring is a cyclopentene, cyclohexene or phenyl ring.

33. The compound of any one of claims 1-32, wherein E has one of the following structures:

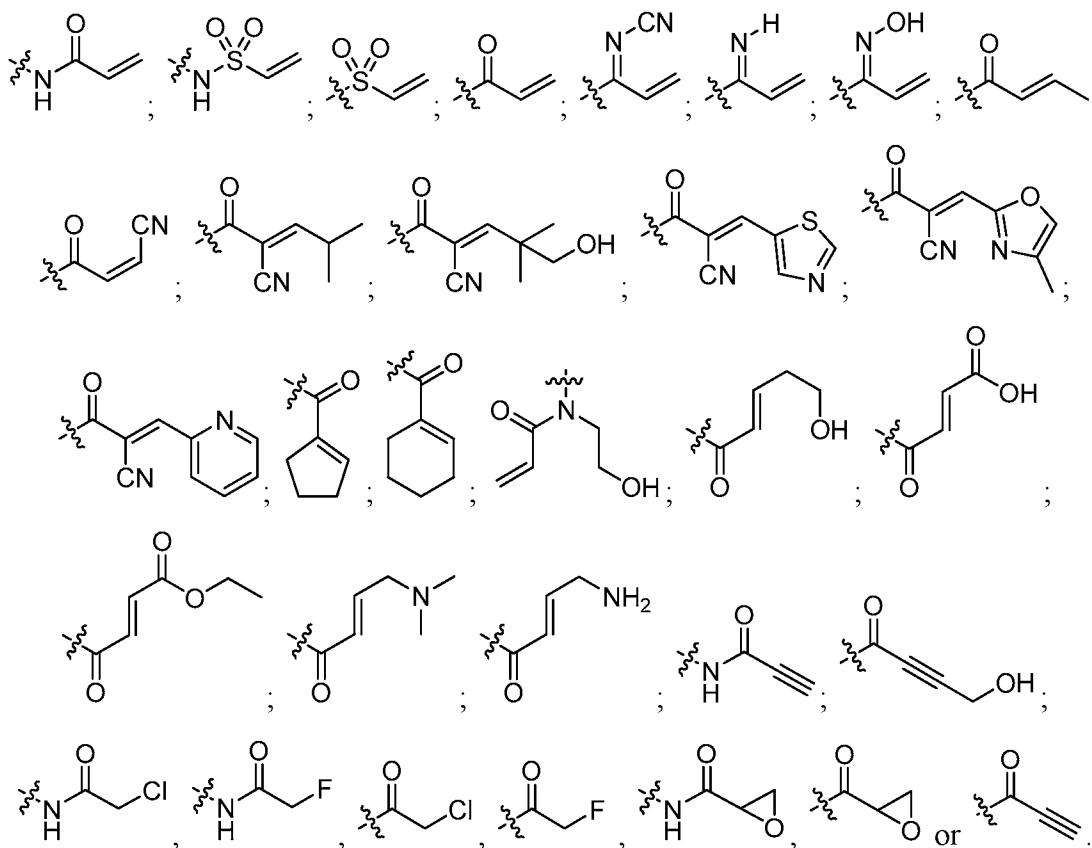

34. The compound of any one of claims 1-33, wherein L^1 is a bond.

35. The compound of any one of claims 1-34, wherein each R^{3a} , R^{3b} , R^{4a} and R^{4b} are H.

36. The compound of any one of claims 1-34, wherein at least one R^{3a} or at least one R^{4a} is aminylcarbonyl.

37. The compound of claim 36, wherein aminylcarbonyl is

38. The compound of any one of claims 1-34, wherein at least one R^{3a} or at least one R^{4a} is cyano.
39. The compound of any one of claims 1-38, wherein m^3 is 1.
40. The compound of any one of claims 1-38, wherein m^4 is 1.
41. The compound of any one of claims 1-40, wherein m^1 is 2.
42. The compound of any one of claims 1-41, wherein each of m^1 and m^2 are 2.
43. The compound of any one of claims 1-42, wherein G^1 , G^2 and G^4 are N.
44. The compound of any one of claims 1-43, wherein G^3 is CH.
45. The compound of claim 1, wherein the compound has one of the following structures:

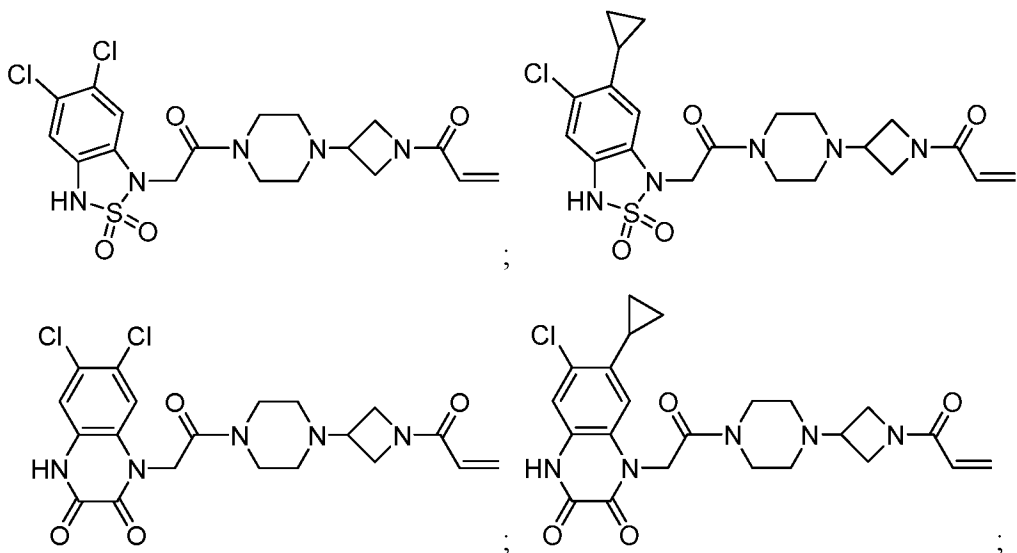

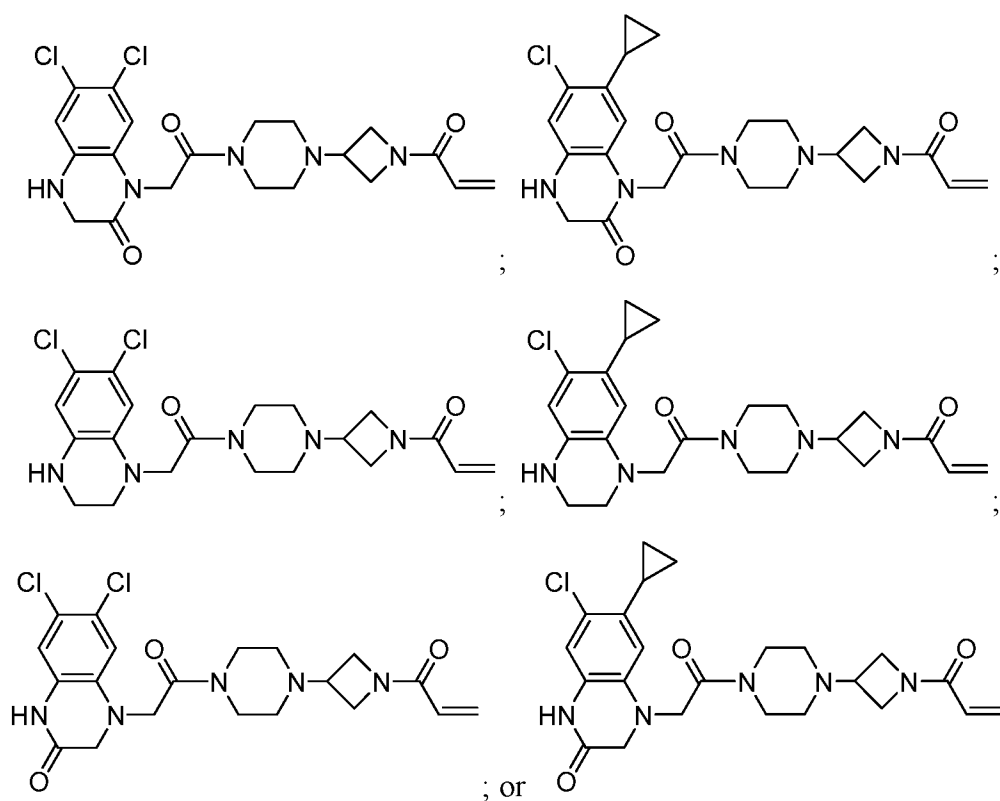

46. A pharmaceutical composition comprising a compound of any one of claims 1-45 and a pharmaceutically acceptable carrier.

47. The pharmaceutical composition of claim 46, wherein the pharmaceutical composition is formulated for oral administration.

48. The pharmaceutical composition of claim 46, wherein the pharmaceutical composition is formulated for injection.

49. A method for treatment of cancer, the method comprising administering an effective amount of the pharmaceutical composition of claim 46 to a subject in need thereof.

50. The method of claim 49, wherein the cancer is mediated by a KRAS G12C, HRAS G12C or NRAS G12C mutation.

51. The method of claim 49 or 50, wherein the cancer is a hematological cancer, pancreatic cancer, MYH associated polyposis, colorectal cancer or lung cancer.

52. The method of any one of claims 49-51, further comprising administering an additional therapeutic agent for treatment of cancer to the subject.

53. A method for regulating activity of a KRAS, HRAS or NRAS G12C mutant protein, the method comprising reacting the KRAS G12C mutant protein with the compound of any one of claims 1-45.

54. A method for inhibiting proliferation of a cell population, the method comprising contacting the cell population with the compound of any one of claims 1-45.

55. The method of claim 54, wherein inhibition of proliferation is measured as a decrease in cell viability of the cell population.

56. A method for treating a disorder mediated by a KRAS G12C, HRAS G12C or NRAS G12C mutation in a subject in need thereof, the method comprising:

determining if the subject has a KRAS, HRAS or NRAS G12C mutation;
and

if the subject is determined to have the KRAS, HRAS or NRAS G12C mutation, then administering to the subject a therapeutically effective amount of the pharmaceutical composition of claim 46.

57. The method of claim 56, wherein the disorder is a cancer.

58. The method of claim 57, wherein the cancer is a hematological cancer, pancreatic cancer, MYH associated polyposis, colorectal cancer or lung cancer.

59. A method for preparing a labeled KRAS, HRAS or NRAS G12C mutant protein, the method comprising reacting the KRAS, HRAS or NRAS G12C mutant with a compound of any one of claims 1-45, to result in the labeled KRAS, HRAS or NRAS G12C protein.

60. A method for inhibiting tumor metastasis, the method comprising administering an effective amount of the pharmaceutical composition of claim 46 to a subject in need thereof.

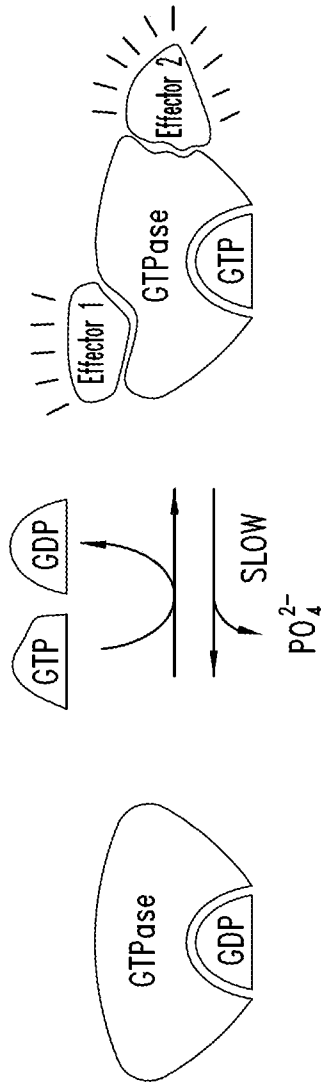

FIG. 1

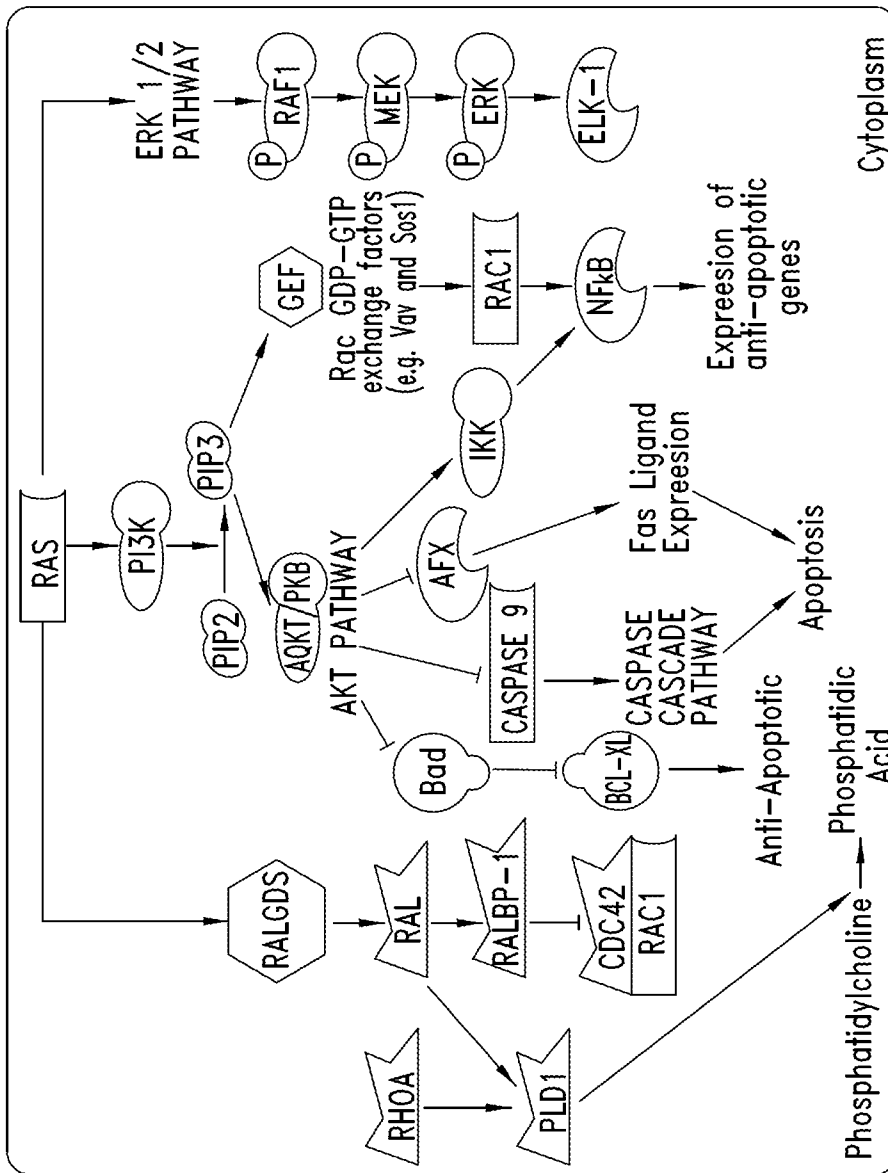

FIG. 2

Oncogene	Tumor Type	Cumulative Mutation Frequency (All Tumors)
Bcr-Abl	90% CML	<1%
EGFR	10% NSCLC	<5%
ALK	5% NSCLC	<1%
B-Raf	66% Melanoma	<5%
Flt3	25% AML	<1%
PI3k α	25% Breast; 25% Endometrial; 15% CRC	15-20%
K-Ras	>80% Pancreatic; >40% colon >20% lung	~20%

FIG. 3

INTERNATIONAL SEARCH REPORT

International application No
PCT/US2016/053987

A. CLASSIFICATION OF SUBJECT MATTER INV. C07D403/14 C07D417/14 A61K31/496 A61K31/498 A61P35/00 ADD.		
According to International Patent Classification (IPC) or to both national classification and IPC		
B. FIELDS SEARCHED		
Minimum documentation searched (classification system followed by classification symbols) C07D A61K A61P		
Documentation searched other than minimum documentation to the extent that such documents are included in the fields searched		
Electronic data base consulted during the international search (name of data base and, where practicable, search terms used) EPO-Internal		
C. DOCUMENTS CONSIDERED TO BE RELEVANT		
Category*	Citation of document, with indication, where appropriate, of the relevant passages	Relevant to claim No.
X	WO 2014/152588 A1 (ARAXES PHARMA LLC [US]) 25 September 2014 (2014-09-25) compounds V-42 the whole document	1-60
X	----- WO 96/13262 A1 (MERCK & CO INC [US]; THOMPSON WAYNE J [US]; SUGRUE MICHAEL F [US]; RAN) 9 May 1996 (1996-05-09)	1,5, 7-12,15, 17,25, 34,35, 41,42,44
A	The compound in lines 26-27 on page 12 ----- -/--	2-4,6, 13,14, 16, 18-24, 26-33, 36-40, 43,45-60
<input checked="" type="checkbox"/> Further documents are listed in the continuation of Box C. <input checked="" type="checkbox"/> See patent family annex.		
* Special categories of cited documents :		
"A" document defining the general state of the art which is not considered to be of particular relevance "E" earlier application or patent but published on or after the international filing date "L" document which may throw doubts on priority claim(s) or which is cited to establish the publication date of another citation or other special reason (as specified) "O" document referring to an oral disclosure, use, exhibition or other means "P" document published prior to the international filing date but later than the priority date claimed		"T" later document published after the international filing date or priority date and not in conflict with the application but cited to understand the principle or theory underlying the invention "X" document of particular relevance; the claimed invention cannot be considered novel or cannot be considered to involve an inventive step when the document is taken alone "Y" document of particular relevance; the claimed invention cannot be considered to involve an inventive step when the document is combined with one or more other such documents, such combination being obvious to a person skilled in the art "&" document member of the same patent family
Date of the actual completion of the international search 28 October 2016		Date of mailing of the international search report 10/11/2016
Name and mailing address of the ISA/ European Patent Office, P.B. 5818 Patentlaan 2 NL - 2280 HV Rijswijk Tel. (+31-70) 340-2040, Fax: (+31-70) 340-3016		Authorized officer Sarakinis, Georgios

INTERNATIONAL SEARCH REPORT

International application No

PCT/US2016/053987

C(Continuation). DOCUMENTS CONSIDERED TO BE RELEVANT		
Category*	Citation of document, with indication, where appropriate, of the relevant passages	Relevant to claim No.
X	US 2011/230476 A1 (NIU DEQIANG [US] ET AL) 22 September 2011 (2011-09-22)	1,5,7-9, 15,17, 33-35, 41-44, 46-49, 51,52, 54,55,60
A	compounds II-a-120 the whole document	2-4,6, 10-14, 16, 18-32, 36-40, 45,50, 53,56-59

INTERNATIONAL SEARCH REPORT

Information on patent family members

International application No PCT/US2016/053987

Patent document cited in search report	Publication date	Patent family member(s)	Publication date	
WO 2014152588	A1	25-09-2014	AU 2014239542 A1	01-10-2015
			CA 2904393 A1	25-09-2014
			CN 105189456 A	23-12-2015
			JP 2016519072 A	30-06-2016
			TW 201524952 A	01-07-2015
			WO 2014152588 A1	25-09-2014

WO 9613262	A1	09-05-1996	AU 701127 B2	21-01-1999
			AU 3967495 A	23-05-1996
			CA 2200468 A1	09-05-1996
			EP 0786997 A1	06-08-1997
			JP 2002515008 A	21-05-2002
			WO 9613262 A1	09-05-1996

US 2011230476	A1	22-09-2011	AU 2010292198 A1	05-04-2012
			CA 2773848 A1	17-03-2011
			CN 102625708 A	01-08-2012
			EP 2475375 A2	18-07-2012
			JP 2013504325 A	07-02-2013
			KR 20120063515 A	15-06-2012
			NZ 598808 A	25-07-2014
			NZ 626650 A	24-12-2015
			RU 2012110024 A	10-11-2013
			SG 179085 A1	27-04-2012
			SG 10201405598Q A	27-11-2014
			TW 201120047 A	16-06-2011
			TW 201609747 A	16-03-2016
			US 2011230476 A1	22-09-2011
			WO 2011031896 A2	17-03-2011
