



US00D441417S

(12) **United States Design Patent**
Wilson

(10) **Patent No.:** **US D441,417 S**

(45) **Date of Patent:** **** May 1, 2001**

(54) **SHOE UPPER**

(75) **Inventor:** **Ralph Davis Wilson, Torrance, CA (US)**

(73) **Assignee:** **Skechers U.S.A., Inc., II, Manhattan Beach, CA (US)**

(**) **Term:** **14 Years**

(21) **Appl. No.:** **29/127,972**

(22) **Filed:** **Aug. 15, 2000**

(51) **LOC (7) Cl.** **02-04**

(52) **U.S. Cl.** **D21/972**

(58) **Field of Search** D2/896, 902, 903,
D2/907, 969-971, 919, 916, 927, 946-960;
36/45, 50.1, 51, 77 M, 77 R, 81, 83, 88,
113, 114, 126-130

(56) **References Cited**

U.S. PATENT DOCUMENTS

- D. 112,629 12/1938 Zohlman .
- D. 132,630 6/1942 Pfeiffer .
- D. 142,432 9/1945 Lissak et al. .
- D. 169,556 5/1953 Maling .
- D. 233,805 12/1974 Kubo .
- D. 239,342 3/1976 Dassler .
- D. 240,280 6/1976 Semter .
- D. 247,073 1/1978 Kane et al. .
- D. 247,201 2/1978 Krome .
- D. 248,512 7/1978 Nova et al. .
- D. 248,513 7/1978 Soler .
- D. 257,074 9/1980 Gucci .
- D. 263,643 4/1982 Vermonet .
- D. 264,394 5/1982 Hlustik .
- D. 265,015 6/1982 Higgins .
- D. 270,870 10/1983 Tilles .
- D. 271,633 12/1983 Casetta .
- D. 273,632 5/1984 Ueda .
- D. 275,145 8/1984 Glatz .
- D. 276,569 12/1984 Kohno .
- D. 279,620 7/1985 Ueda .
- D. 283,366 4/1986 Chassaing .
- D. 283,463 4/1986 Chassaing .

- D. 284,043 6/1986 Lowe, Jr. et al. .
- D. 287,782 1/1987 Palacio .
- D. 290,900 7/1987 Schornstein et al. .
- D. 293,970 2/1988 Brown et al. .
- D. 294,654 3/1988 Liggett et al. .
- D. 295,341 4/1988 Liggett et al. .
- D. 295,578 5/1988 Tong .
- D. 296,037 6/1988 Brown et al. .
- D. 296,491 7/1988 Diaz .
- D. 297,069 8/1988 Le .
- D. 297,183 8/1988 Selbiger .
- D. 297,382 8/1988 Swett .
- D. 298,882 12/1988 Selbiger .
- D. 299,181 1/1989 Harken et al. .
- D. 299,783 2/1989 Brown et al. .
- D. 299,784 2/1989 Brown et al. .
- D. 299,886 2/1989 Brown et al. .
- D. 300,782 4/1989 Brown et al. .
- D. 300,983 5/1989 Le .
- D. 301,183 5/1989 Duclos .
- D. 303,868 10/1989 Argyropoulos .
- D. 306,370 3/1990 Selbiger et al. .
- D. 306,371 3/1990 Feller et al. .
- D. 307,350 4/1990 Brown et al. .

(List continued on next page.)

Primary Examiner—Dominic Simone

(74) *Attorney, Agent, or Firm*—Marshall A. Lerner, Esq.; Finn T. Simmens, Esq.; Kleinberg & Lerner, LLP

(57) **CLAIM**

The ornamental design for a shoe upper, as shown and described.

DESCRIPTION

FIG. 1 is a perspective view;
FIG. 2 is a left side elevational view thereof;
FIG. 3 is a top plan view thereof;
FIG. 4 is a right side elevational view thereof;
FIG. 5 is a front side elevational view thereof; and,
FIG. 6 is a rear elevational view.

The broken line showing the sole in the figures is for illustrative purposes only and forms no part of the claimed design.

1 Claim, 3 Drawing Sheets

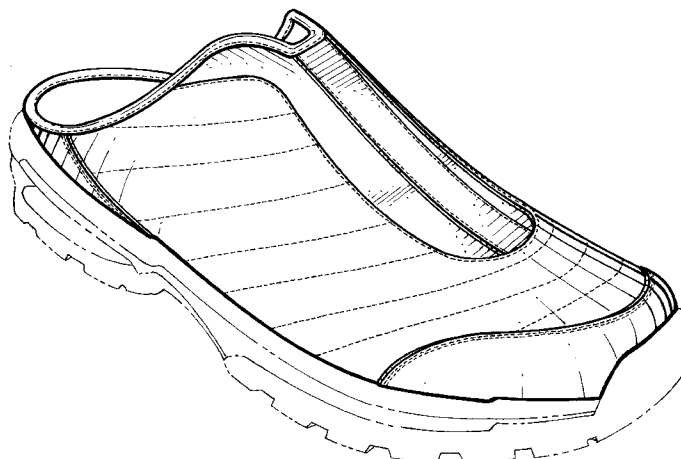

US D441,417 S

Page 2

U.S. PATENT DOCUMENTS

D. 310,289	9/1990	Farina .	D. 392,792	3/1998	Obi .
D. 310,291	9/1990	Selbiger .	D. 392,793	3/1998	Koh .
D. 311,268	10/1990	Hatfield .	D. 393,142	4/1998	Brown .
D. 315,054	3/1991	Hatfield .	D. 394,145	5/1998	von Conta .
D. 317,224	6/1991	Lucas .	D. 399,043	10/1998	Duclos et al. .
D. 317,823	7/1991	Hatfield .	D. 399,044	10/1998	Hamel .
D. 318,944	8/1991	Lucas .	D. 400,697	11/1998	Egelja et al. .
D. 326,354	5/1992	Hatfield .	D. 400,699	11/1998	Brooks et al. .
D. 326,950	6/1992	Legacki et al. .	D. 401,049 *	11/1998	Greenberg D2/969
D. 328,667	8/1992	Tonkel et al. .	D. 402,100	12/1998	Greenberg .
D. 329,734	9/1992	Preskar et al. .	D. 402,454	12/1998	Kelchak .
D. 330,626	11/1992	McDonald et al. .	D. 403,148	12/1998	Kelchak .
D. 333,553	3/1993	Bevier .	D. 403,849	1/1999	Greenberg .
D. 334,651	4/1993	Smith .	D. 404,553	1/1999	Greenberg .
D. 337,649	7/1993	Greene .	D. 404,905	2/1999	Kelchak .
D. 341,476	11/1993	Duclos .	D. 405,238	2/1999	Hamel .
D. 341,937	12/1993	Minkin .	D. 405,599	2/1999	Hamel .
D. 342,370	12/1993	Keen .	D. 405,600	2/1999	Hamel .
D. 345,460	3/1994	Ryder .	D. 408,124	4/1999	Reynolds .
D. 346,897	5/1994	Morris et al. .	D. 408,979	5/1999	Boyer .
D. 349,806	8/1994	Minkin .	D. 410,326	6/1999	Duclos .
D. 350,021	8/1994	Stein .	D. 431,350 *	10/2000	Matis et al. D2/969
D. 351,275	10/1994	Hatfield et al. .	D. 434,894 *	12/2000	Burt D2/972
D. 351,939	11/1994	Ryder .	1,952,628	3/1934	MacDonald .
D. 353,481	12/1994	Cintron .	1,973,292	9/1934	Littell et al. .
D. 353,482	12/1994	Cintron .	2,226,110	12/1940	Bass .
D. 354,165	1/1995	Werman .	2,247,459	7/1941	Wolfhard et al. .
D. 355,069	2/1995	Aveni .	2,299,500	10/1942	Sawyer .
D. 356,436	3/1995	Sutton et al. .	2,311,746	2/1943	Ghez et al. .
D. 358,702	5/1995	Edwards .	2,330,273	9/1943	Finn .
D. 358,930	6/1995	Blanchini .	2,370,109	2/1945	Pipitone .
D. 361,884	9/1995	Lozano .	2,591,211	4/1952	Spencer .
D. 362,333	9/1995	Teague .	2,642,677	6/1953	Yates .
D. 363,158	10/1995	Matis et al. .	2,853,806	9/1958	White .
D. 365,199	12/1995	Avar .	2,889,639	6/1959	Rudine .
D. 365,200	12/1995	Teague .	2,932,911	4/1960	Musebeck et al. .
D. 365,922	1/1996	O'Rorke .	2,978,817	4/1961	Brenner .
D. 366,141	1/1996	von Conta .	3,095,656	7/1963	Lipare .
D. 367,161	2/1996	Shea .	3,323,233	6/1967	Scholl .
D. 368,578	4/1996	Smith .	3,545,107	12/1970	Cinquegrana et al. .
D. 369,456	5/1996	Peterson .	3,672,078	6/1972	Fukuoka .
D. 370,554	6/1996	Greene .	3,729,840	5/1973	Famolare, Jr. .
D. 374,763	10/1996	von Conta .	3,798,804	3/1974	Funck .
D. 375,615	11/1996	McDonald .	3,890,725	6/1975	Lea et al. .
D. 377,860	2/1997	Renault .	4,290,212	9/1981	Matsson .
D. 379,030	5/1997	Egelja .	4,300,256	11/1981	Laganas .
D. 380,594	7/1997	von Conta .	4,314,413	2/1982	Dassler .
D. 380,597	7/1997	Brooks et al. .	4,538,366	9/1985	Norton .
D. 381,492	7/1997	Nakano .	4,651,447	3/1987	Sullivan .
D. 381,794	8/1997	Gelli .	4,670,998	6/1987	Pasternak .
D. 381,798	8/1997	Cyr .	4,736,531	4/1988	Richard .
D. 382,389	8/1997	Morris .	4,742,625	5/1988	Sydor et al. .
D. 382,992	9/1997	Chiu .	4,896,440	1/1990	Salaverria .
D. 384,195	9/1997	Brooks et al. .	4,949,476	8/1990	Anderie .
D. 385,395	10/1997	Morris .	4,972,610	11/1990	Tong .
D. 385,397	10/1997	Duclos et al. .	5,369,895	12/1994	Hammerschmidt .
D. 385,689	11/1997	James .	5,371,957	12/1994	Gaudio .
D. 387,194	12/1997	Serna .	5,621,986	4/1997	Medina et al. .

* cited by examiner

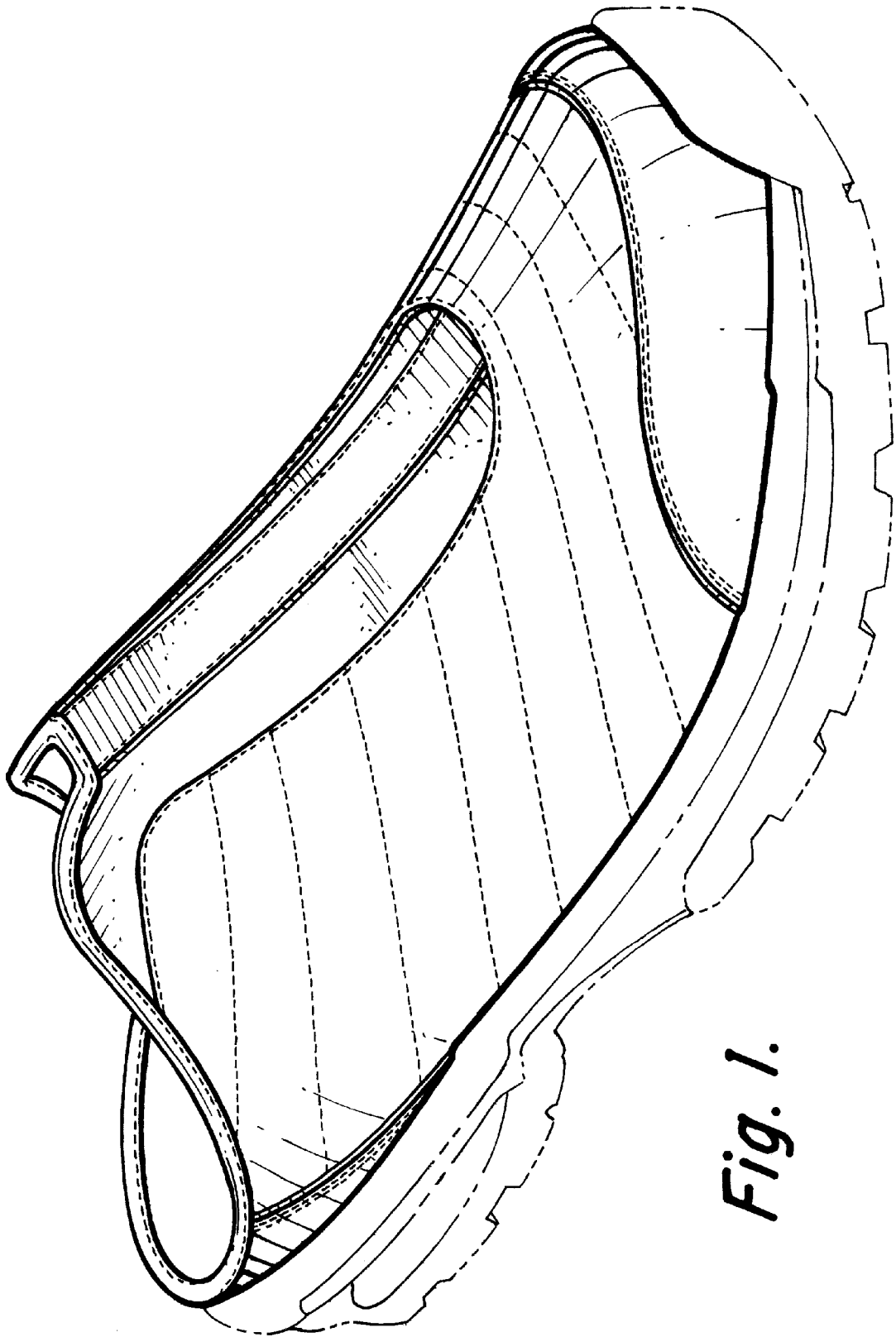

Fig. 1.

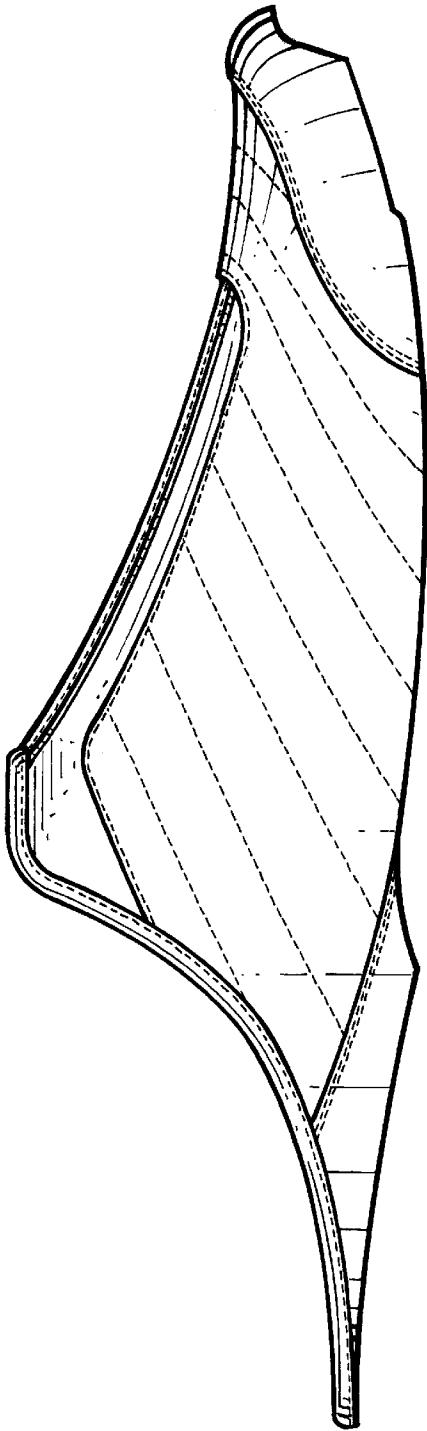

Fig. 2.

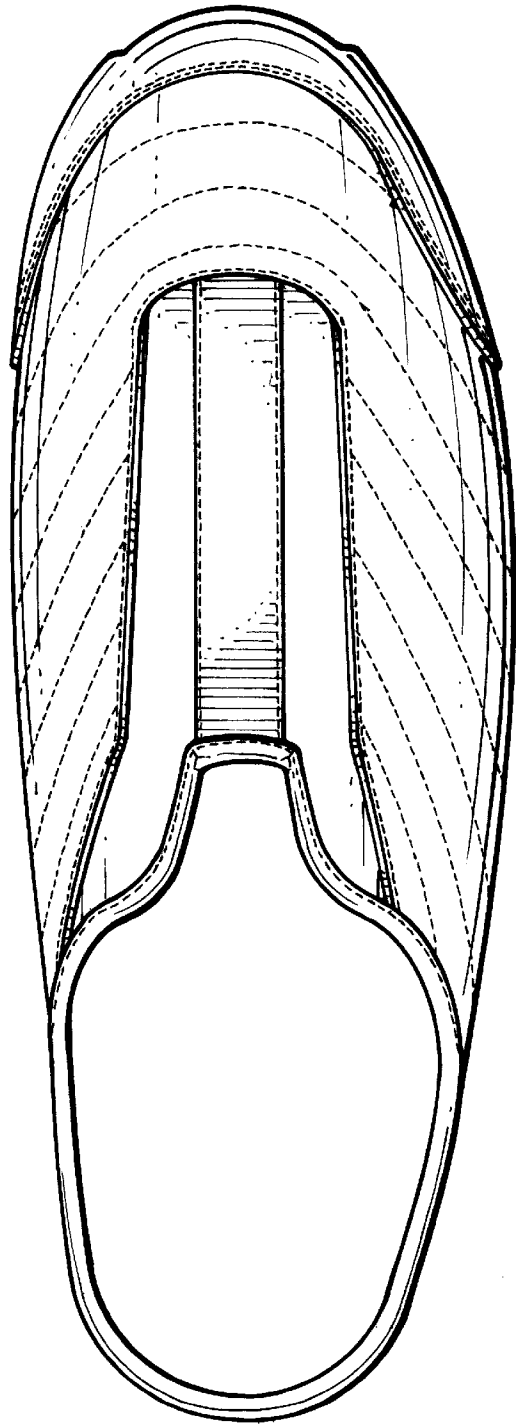

Fig. 3.

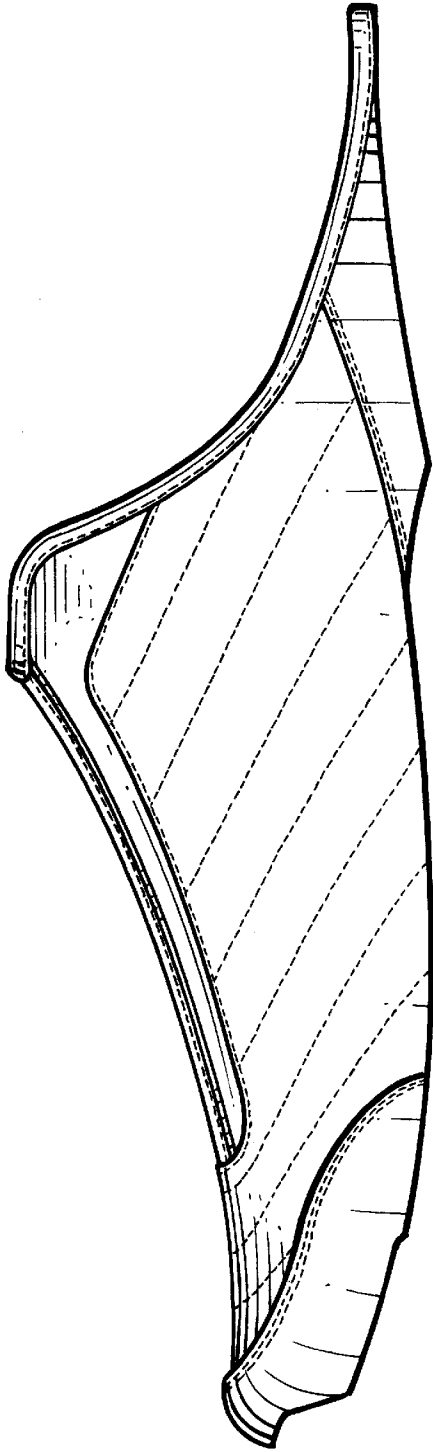

Fig. 4.

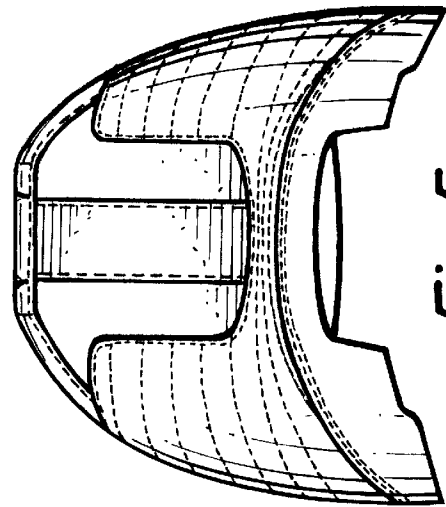

Fig. 5.

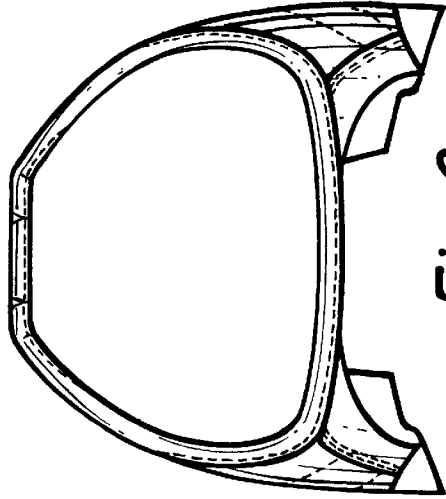

Fig. 6.