



US00D419879S

# United States Patent [19] Robbins, III

[11] Patent Number: **Des. 419,879**  
[45] Date of Patent: **\*\* Feb. 1, 2000**

[54] **DISPENSING CAP**

[76] Inventor: **Edward S. Robbins, III**, 2802 E. Avalon Ave., Muscle Shoals, Ala. 35662

[\*\*] Term: **14 Years**

[21] Appl. No.: **29/083,172**

[22] Filed: **Jan. 30, 1998**

[51] **LOC (7) Cl.** ..... **09-07**

[52] **U.S. Cl.** ..... **D9/449**

[58] **Field of Search** ..... D9/435, 436, 447, D9/449, 450, 523; D7/300.1, 589, 591, 612; 215/236; 220/501, 521, 522; 222/142.1, 142.6, 142.7, 158, 159, 442, 448, 454, 456, 556

[56] **References Cited**

**U.S. PATENT DOCUMENTS**

D. 287,469	12/1986	Weinberger	.....	D9/435
D. 363,649	10/1995	Robbins, III	.	
D. 378,273	3/1997	Robbins, III et al.	.	
D. 379,148	5/1997	Robbins, III et al.	.	
D. 379,434	5/1997	Robbins, III et al.	.	
5,465,871	11/1995	Robbins, III	.	
5,487,494	1/1996	Robbins, III	.	

5,509,582	4/1996	Robbins, III	.	
5,547,109	8/1996	Robbins, III	.....	222/158
5,632,417	5/1997	Robbins, III et al.	.....	222/158
5,667,106	9/1997	Robbins, III	.....	222/158
5,871,116	2/1999	Picchietti	.....	220/501

*Primary Examiner*—Cathron B. Matta  
*Attorney, Agent, or Firm*—Nixon & Vanderhuy P.C.

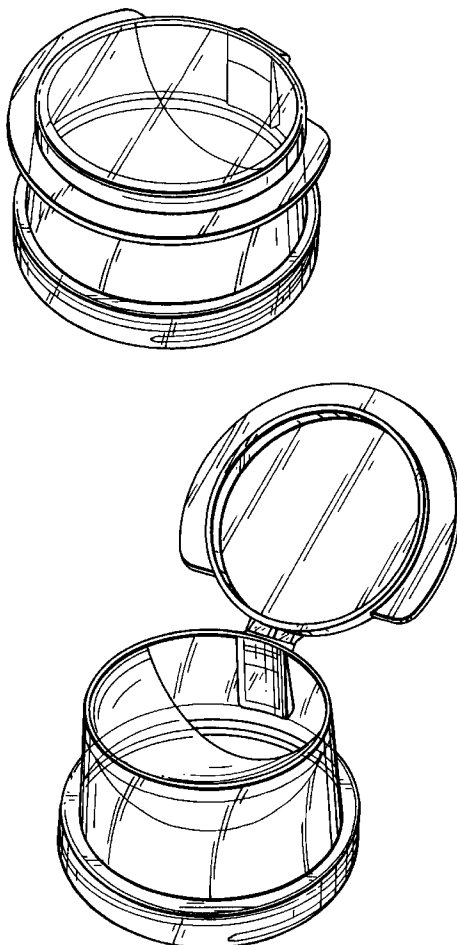
[57] **CLAIM**

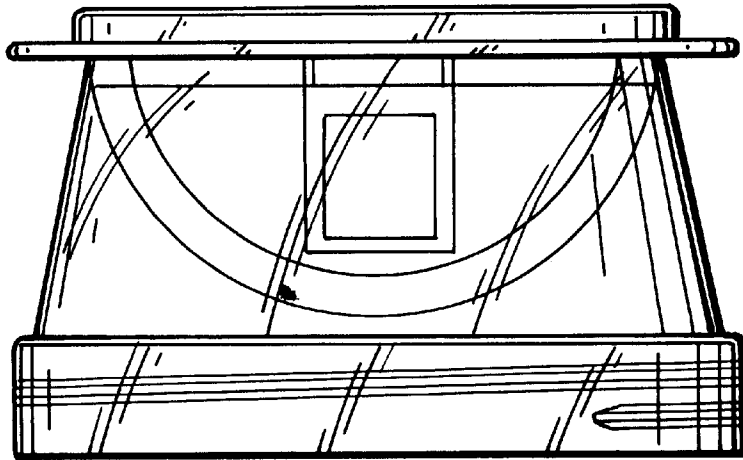
The ornamental design for a “dispensing cap,” as shown and described.

**DESCRIPTION**

FIG. 1 is a front elevation view of a dispensing cap in accordance with my new design;  
FIG. 2 is a top plan view thereof;  
FIG. 3 is a left side elevation thereof, the right side view being a mirror image thereof, except for differences in the threading;  
FIG. 4 is a rear elevation view thereof;  
FIG. 5 is a bottom plan view thereof;  
FIG. 6 is a perspective view thereof; and,  
FIG. 7 is a perspective view similar to FIG. 6 but with the lid portion of the cap in an open position.

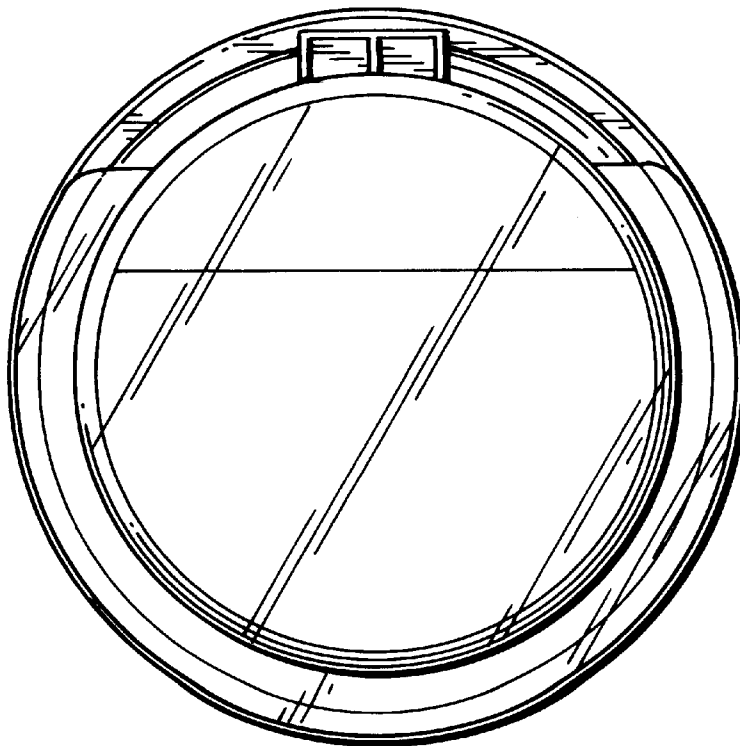
**1 Claim, 4 Drawing Sheets**

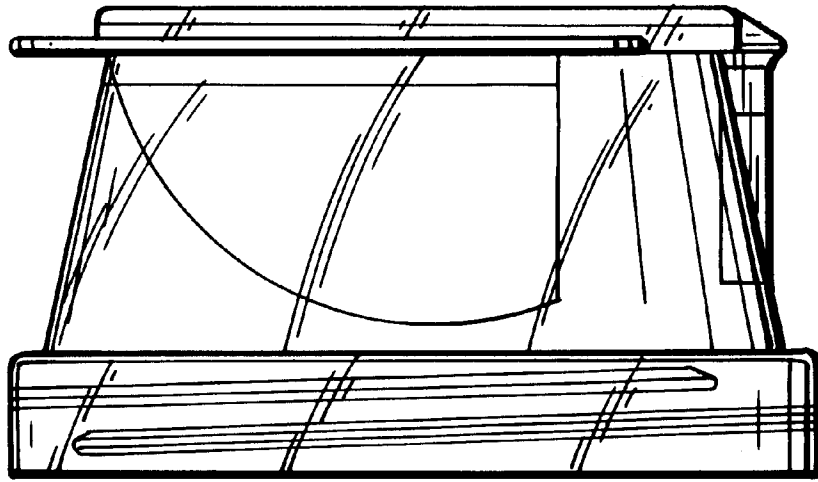




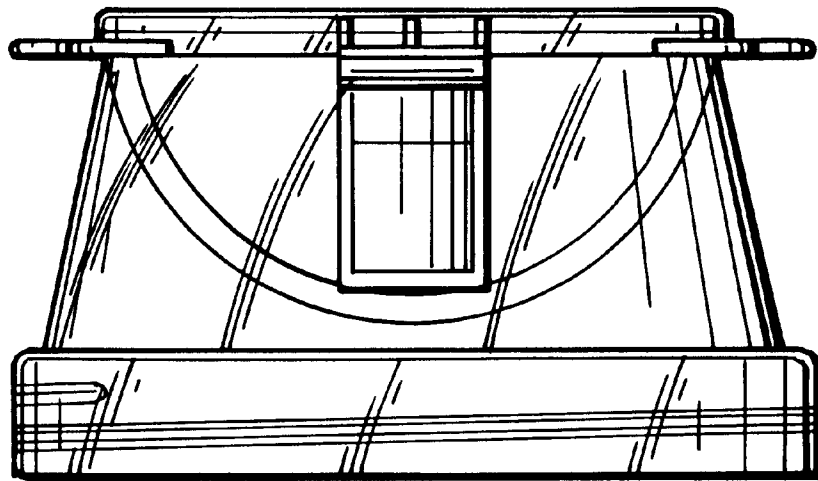
**FIG. 1**

**FIG. 2**

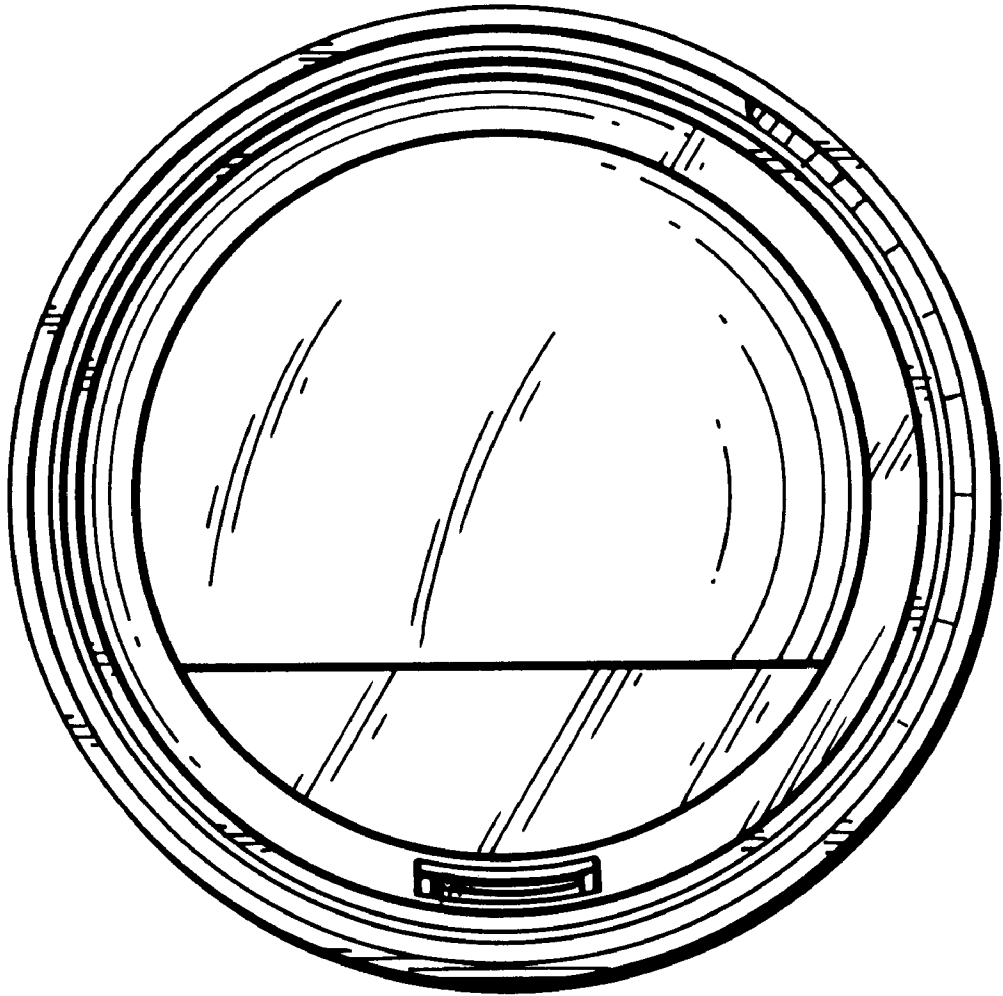




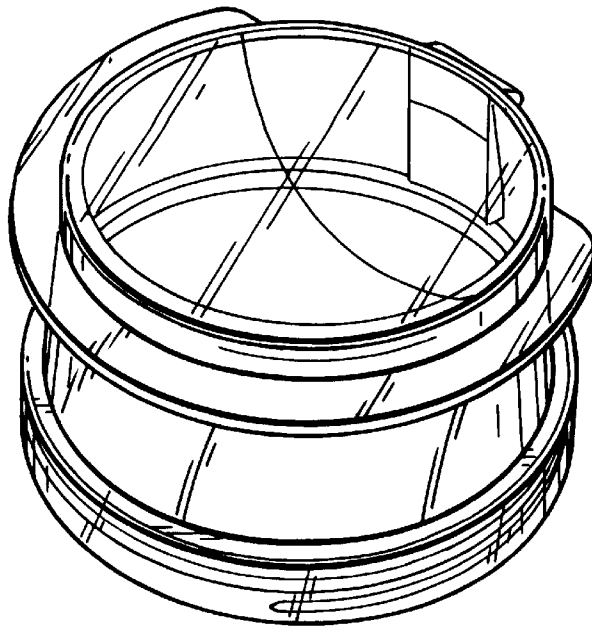
**FIG. 3**



**FIG. 4**



***FIG. 5***



*FIG. 6*

*FIG. 7*

