



US00D775594S

(12) **United States Design Patent**  
**Shibukawa et al.**

(10) **Patent No.:** **US D775,594 S**  
(45) **Date of Patent:** **\*\* Jan. 3, 2017**

(54) **TELEVISION RECEIVER**

FOREIGN PATENT DOCUMENTS

(71) Applicant: **Sony Corporation**, Tokyo (JP)  
(72) Inventors: **Kentaro Shibukawa**, Kanagawa (JP);  
**Kenzo Nakajima**, Kanagawa (JP);  
**Shigeya Kuwao**, Kanagawa (JP);  
**Daisuke Shiono**, Tokyo (JP)  
(73) Assignee: **Sony Corporation**, Tokyo (JP)

JP D1158435 S 11/2002  
JP D1432717 S 1/2012  
JP D1462440 S 2/2013

*Primary Examiner* — Eric Goodman  
*Assistant Examiner* — Clese Moore, Jr.  
(74) *Attorney, Agent, or Firm* — Michael Best and Friedrich LLP

(\*\*) Term: **14 Years**

(57) **CLAIM**

(21) Appl. No.: **29/483,929**

The ornamental design for a television receiver, as shown and described.

(22) Filed: **Mar. 4, 2014**

(30) **Foreign Application Priority Data**

**DESCRIPTION**

Sep. 3, 2013 (JP) ..... D2013-020340  
Sep. 3, 2013 (JP) ..... D2013-020343  
(Continued)

FIG. 1 is a perspective view of a first embodiment of a television receiver showing our new design; FIG. 2 is a front elevational view thereof; FIG. 3 is a rear elevational view thereof; FIG. 4 is a right side elevational view thereof; and FIG. 5 is a top plan view thereof. FIG. 6 is an enlarged partial perspective view along the lines 6-6 of FIG. 1; and FIG. 7 is an enlarged partial right side elevational view along the line 7-7 of FIG. 4. FIG. 8 is a perspective view of a second embodiment of a television receiver showing our new design; FIG. 9 is a front elevational view thereof; FIG. 10 is a rear elevational view thereof; FIG. 11 is a right side elevational view thereof; and FIG. 12 is a top plan view thereof. FIG. 13 is an enlarged partial perspective view along the lines 13-13 of FIG. 8; and FIG. 14 is an enlarged partial right side elevational view along the line 14-14 of FIG. 11.

(51) **LOC (10) Cl.** ..... **14-03**

(52) **U.S. Cl.** ..... **D14/126**  
USPC .....

(58) **Field of Classification Search**  
USPC ..... D14/125-134, 239, 371, 374-377, 448, D14/450, 451, 336, 159, 209.1; D6/300; D10/15, 26; D16/241; D21/329, 515, 577, D21/333, 331; 312/7.2; 345/104, 156, 168, 87, 345/173, 690; 446/484, 175; 273/148 B; 248/917-924, 465; 348/836, 838, 180, 184, 348/325, 739  
(Continued)

The broken lines shown in the drawings illustrate portions of the television receiver that form no part of the claimed design.

(56) **References Cited**

U.S. PATENT DOCUMENTS

1,869,753 A \* 8/1932 Kamm ..... B44D 3/125  
206/361  
2,290,359 A \* 7/1942 Ringler ..... B44D 3/123  
206/15.3

(Continued)

**1 Claim, 12 Drawing Sheets**

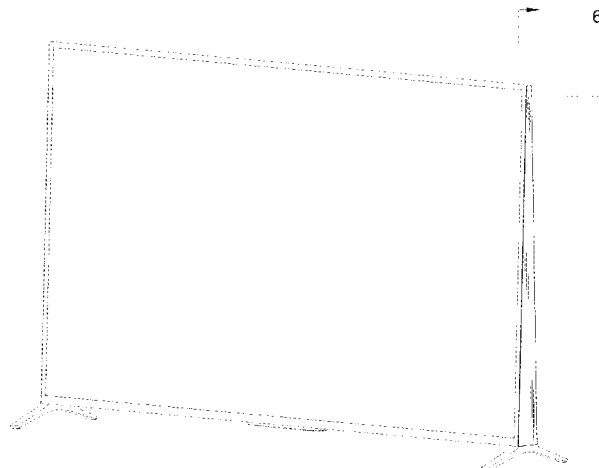

(30) Foreign Application Priority Data

Sep. 3, 2013 (JP) ..... D2013-020344  
 Dec. 24, 2013 (CN) ..... 2013 3 0643199  
 Dec. 24, 2013 (JP) ..... D2013-030169  
 Dec. 24, 2013 (JP) ..... D2013-030170

(58) Field of Classification Search

CPC ..... H05K 5/0004; H05K 5/0017; H05K 5/02;  
 H05K 5/0216; G06F 1/1601; G06F  
 1/1643

See application file for complete search history.

(56) References Cited

U.S. PATENT DOCUMENTS

2,453,973 A \* 11/1948 Coats ..... A47L 13/52  
 15/257.05  
 D169,116 S \* 3/1953 Wienke ..... 428/14  
 D307,675 S \* 5/1990 Jordan ..... D6/300  
 D320,346 S \* 10/1991 Wagner ..... D9/415  
 D338,685 S \* 8/1993 Dakich ..... D19/92  
 D350,234 S \* 9/1994 Losole ..... D4/199  
 5,432,391 A \* 7/1995 Zawoysky ..... H02K 3/51  
 310/201  
 D367,545 S \* 2/1996 Burke ..... D28/65  
 5,536,096 A \* 7/1996 Nowak ..... B26F 1/36  
 402/1  
 D393,545 S \* 4/1998 Fernandes ..... D4/199  
 D412,891 S 8/1999 Sumii  
 5,986,380 A \* 11/1999 Kaminski ..... H02K 3/51  
 310/179  
 6,002,194 A \* 12/1999 Asao ..... H02K 21/044  
 310/181  
 D420,658 S \* 2/2000 Eyler ..... D14/436  
 D431,188 S \* 9/2000 Monn ..... D3/295  
 6,258,444 B1 \* 7/2001 Muramoto ..... G06F 3/0395  
 248/346.01  
 D453,160 S \* 1/2002 Pentz ..... D14/436  
 D454,533 S \* 3/2002 Benson ..... D12/425  
 6,396,181 B1 \* 5/2002 Akemakou ..... H02K 21/048  
 310/156.01  
 6,703,741 B1 \* 3/2004 Ifrim ..... H02K 1/2773  
 310/156.19  
 D522,854 S \* 6/2006 Engels ..... D9/417  
 7,067,954 B2 \* 6/2006 Kuribayashi ..... H02K 21/044  
 310/263  
 D529,883 S 10/2006 Hoehn et al.  
 D551,583 S \* 9/2007 Evans ..... D10/121

D555,655 S \* 11/2007 Iu ..... D14/447  
 D564,872 S \* 3/2008 Kamins ..... D9/418  
 D568,268 S \* 5/2008 Lee ..... D14/126  
 D574,005 S \* 7/2008 Chung ..... D14/447  
 D577,206 S 9/2008 Chang et al.  
 D580,383 S \* 11/2008 Kuramashi ..... D14/126  
 D583,821 S \* 12/2008 Richter ..... D14/447  
 D595,287 S \* 6/2009 Nazar ..... D14/251  
 D616,219 S \* 5/2010 Herron ..... D6/672  
 D620,461 S 7/2010 Han et al.  
 D623,619 S \* 9/2010 Roed et al. .... D14/126  
 D634,722 S 3/2011 Kim et al.  
 D634,723 S \* 3/2011 Park et al. .... D14/126  
 D642,172 S \* 7/2011 Akana ..... D14/318  
 D649,818 S \* 12/2011 Dye ..... D6/705  
 D650,764 S \* 12/2011 Chiu ..... D14/126  
 D653,534 S \* 2/2012 Shinn ..... D9/415  
 D658,615 S \* 5/2012 Chiu ..... D14/126  
 D660,086 S \* 5/2012 Buchman ..... D7/553.2  
 D668,237 S \* 10/2012 Chino et al. .... D14/126  
 D670,257 S 11/2012 Yang et al.  
 D673,571 S \* 1/2013 Akana ..... D14/447  
 D673,572 S \* 1/2013 Akana ..... D14/447  
 D680,089 S 4/2013 Cho et al.  
 D691,571 S \* 10/2013 Park et al. .... D14/126  
 D695,245 S \* 12/2013 Hara et al. .... D14/126  
 D699,204 S \* 2/2014 Jung ..... D14/126  
 D699,713 S \* 2/2014 Seong ..... D14/239  
 D700,170 S \* 2/2014 Choi et al. .... D14/239  
 D703,169 S \* 4/2014 Kim et al. .... D14/126  
 D705,200 S \* 5/2014 Choi ..... D14/239  
 D708,157 S \* 7/2014 Park ..... D14/126  
 D708,596 S \* 7/2014 Park ..... D14/126  
 D709,467 S \* 7/2014 Jiang et al. .... D14/126  
 D714,757 S \* 10/2014 Lee et al. .... D14/209.1  
 D714,758 S \* 10/2014 Lee et al. .... D14/209.1  
 D715,756 S \* 10/2014 Lim ..... D14/126  
 D716,244 S \* 10/2014 Kim et al. .... D14/126  
 D719,120 S \* 12/2014 Park et al. .... D14/126  
 D720,709 S \* 1/2015 Lee et al. .... D14/126  
 D723,485 S \* 3/2015 Hwangbo et al. .... D14/126  
 D723,486 S \* 3/2015 Lee et al. .... D14/126  
 D723,487 S \* 3/2015 Lee et al. .... D14/126  
 D725,121 S \* 3/2015 Kim ..... D14/451  
 D727,863 S \* 4/2015 Sung ..... D14/126  
 2002/0088765 A1 \* 7/2002 Waldron ..... A47F 7/145  
 211/128.1  
 2004/0256535 A1 \* 12/2004 Desch ..... A47B 23/042  
 248/460

\* cited by examiner

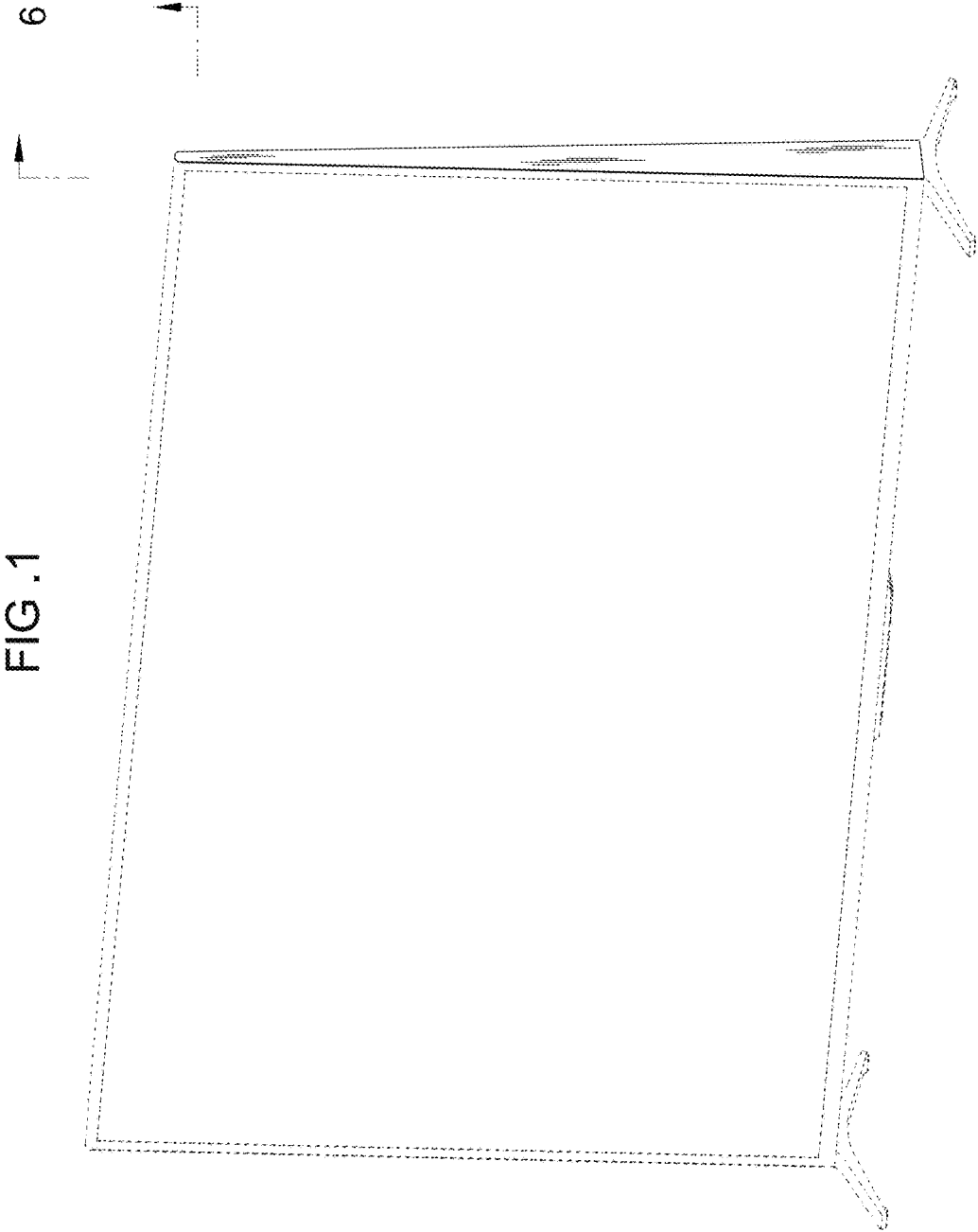

FIG. 1

FIG.2

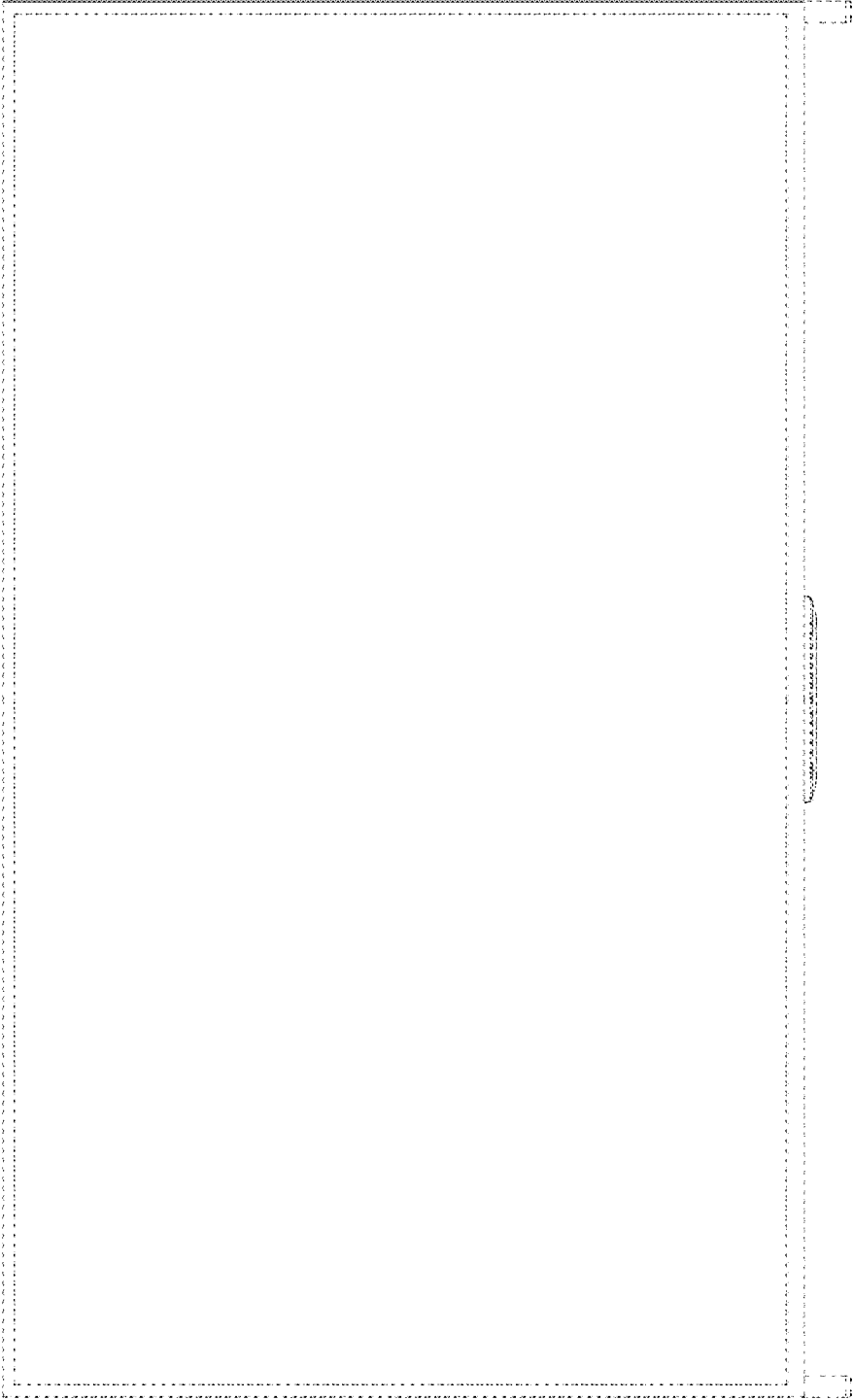

FIG.3

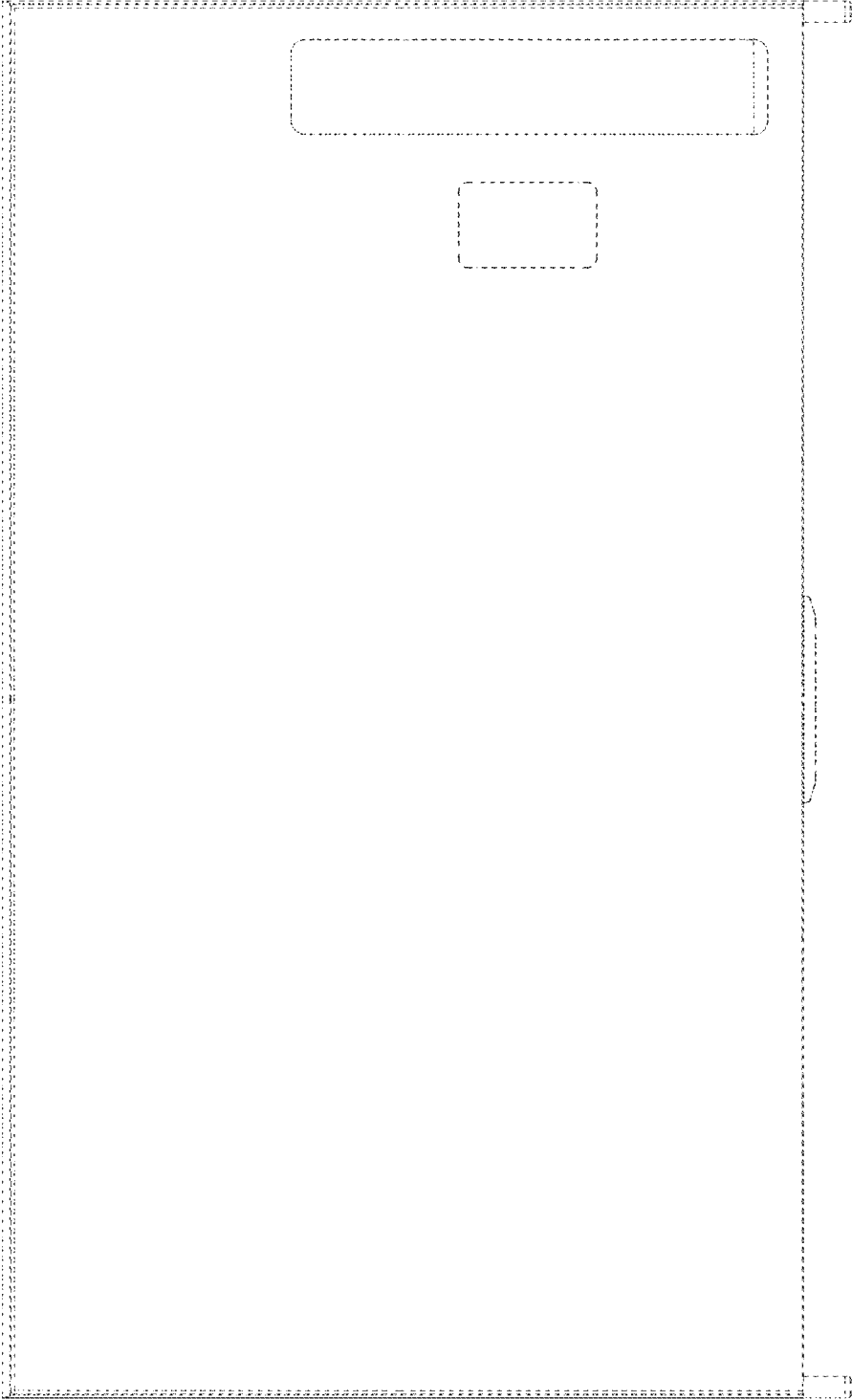

FIG.4

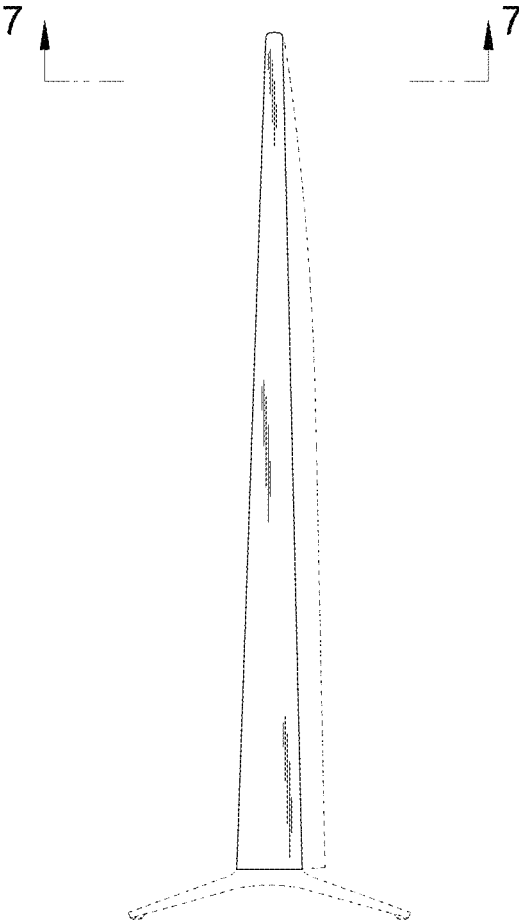

FIG.5

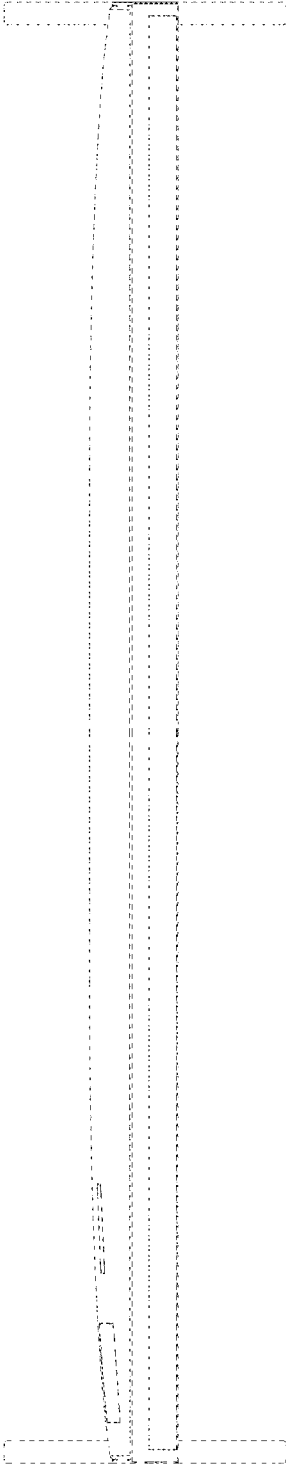

FIG.6

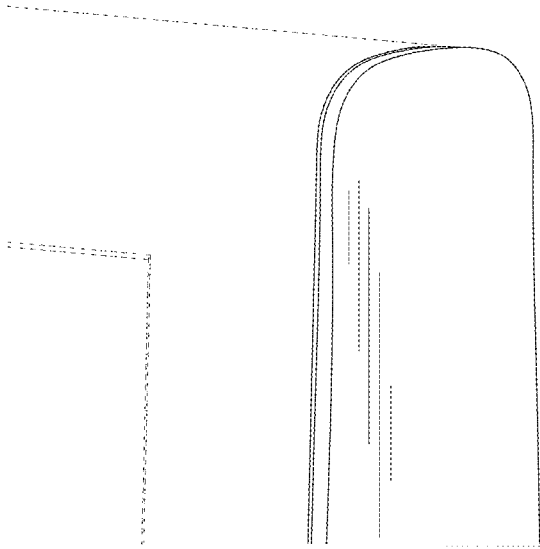
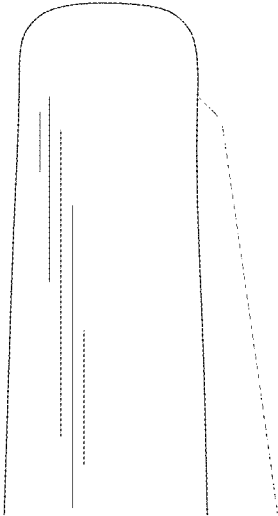

FIG.7





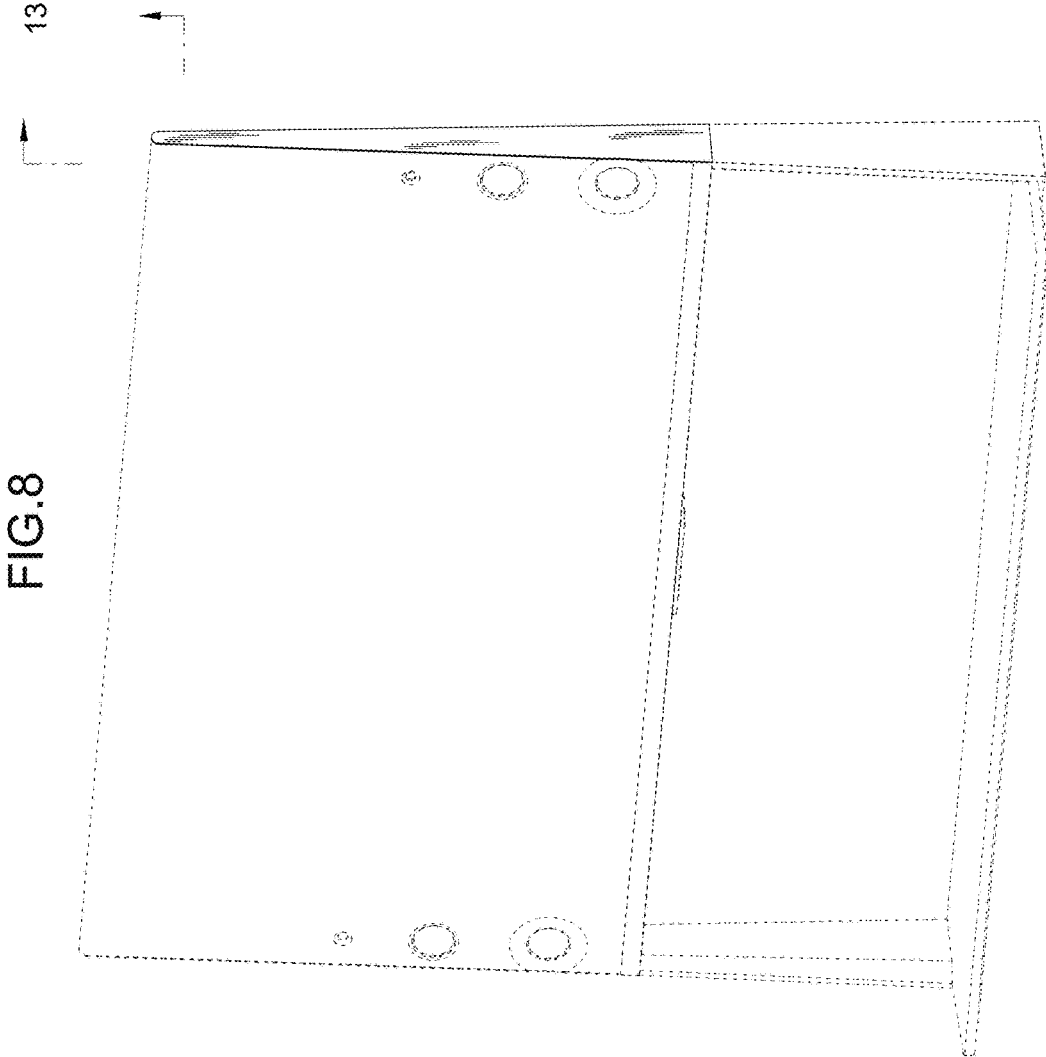

FIG.9

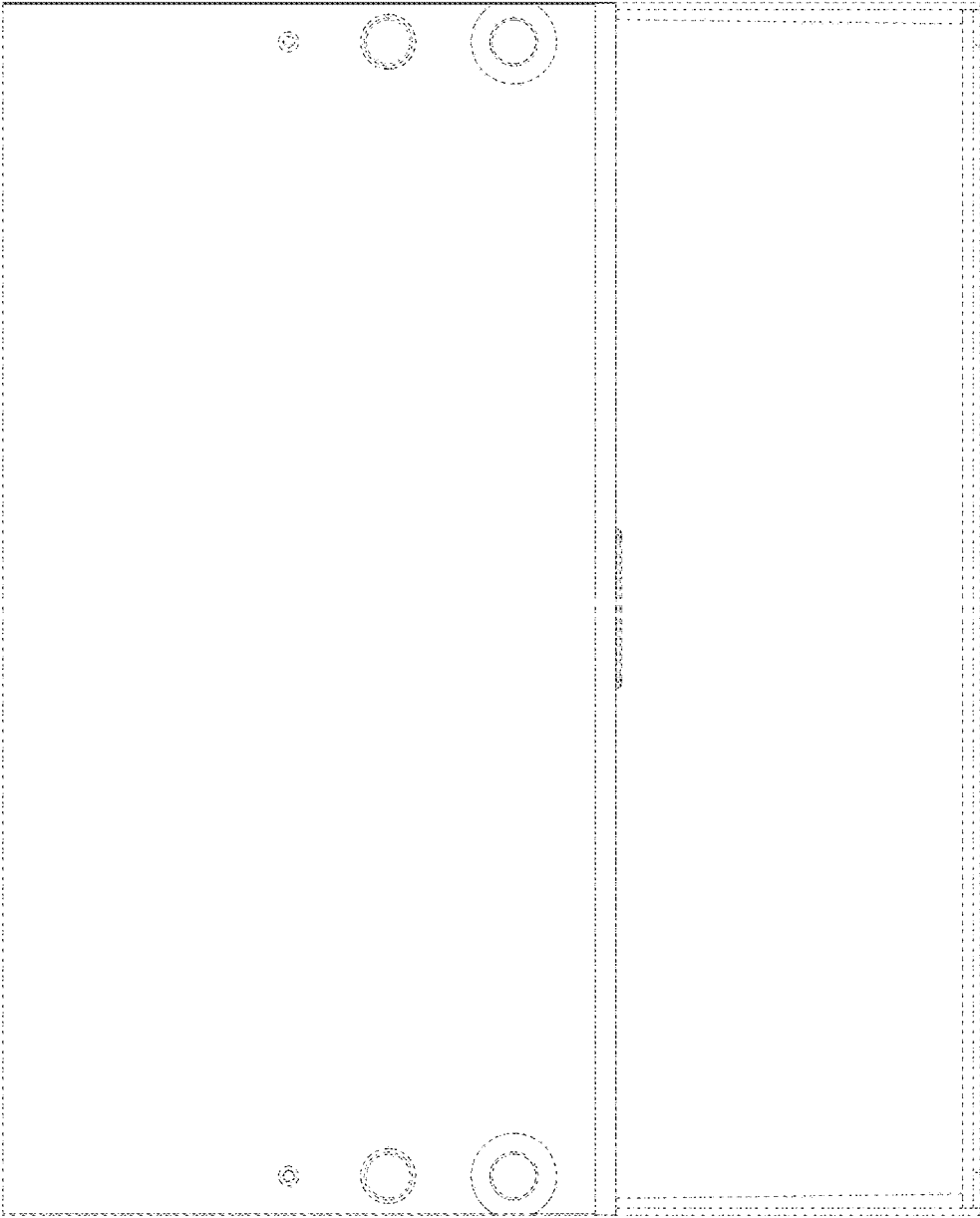

FIG.10

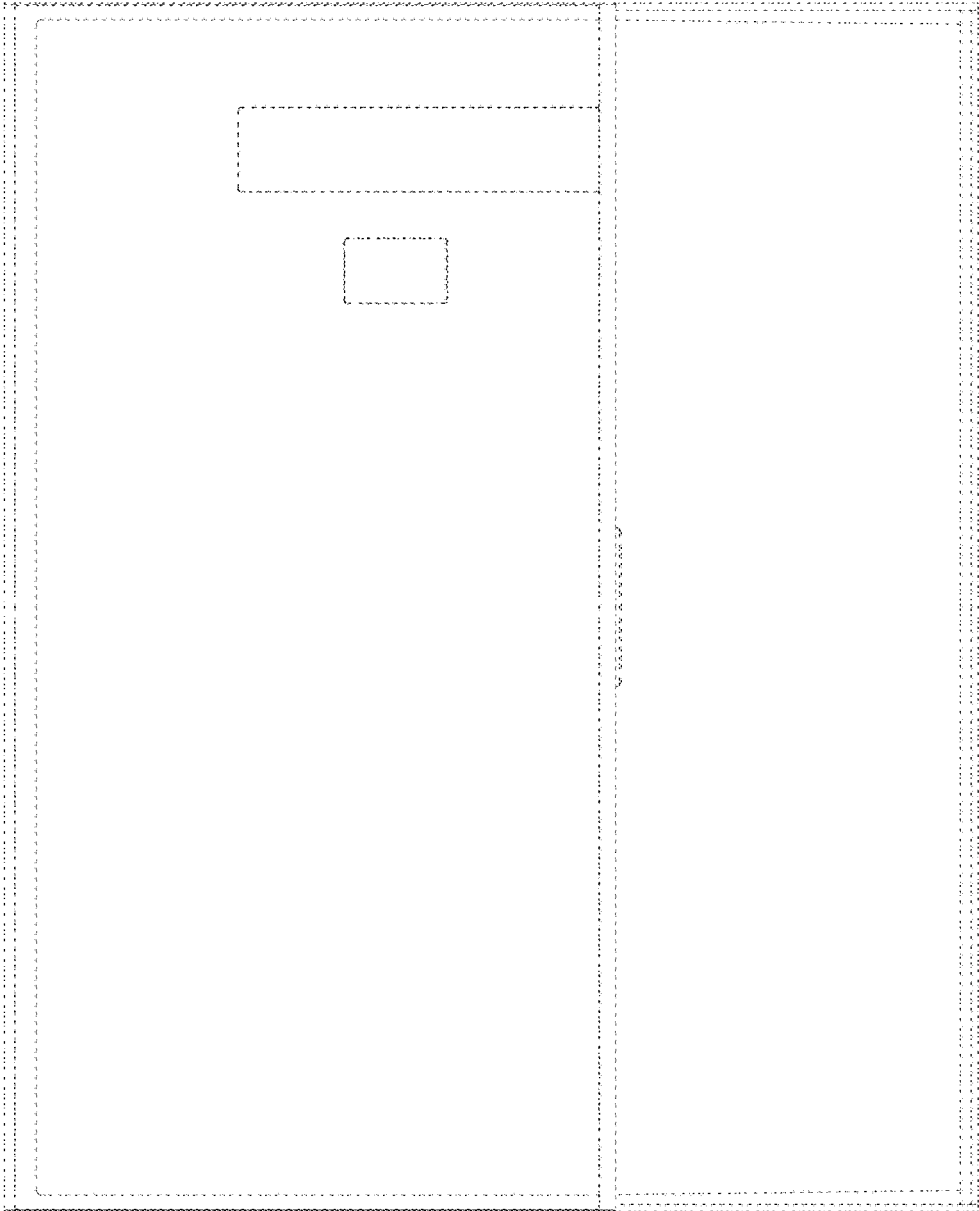

FIG.11

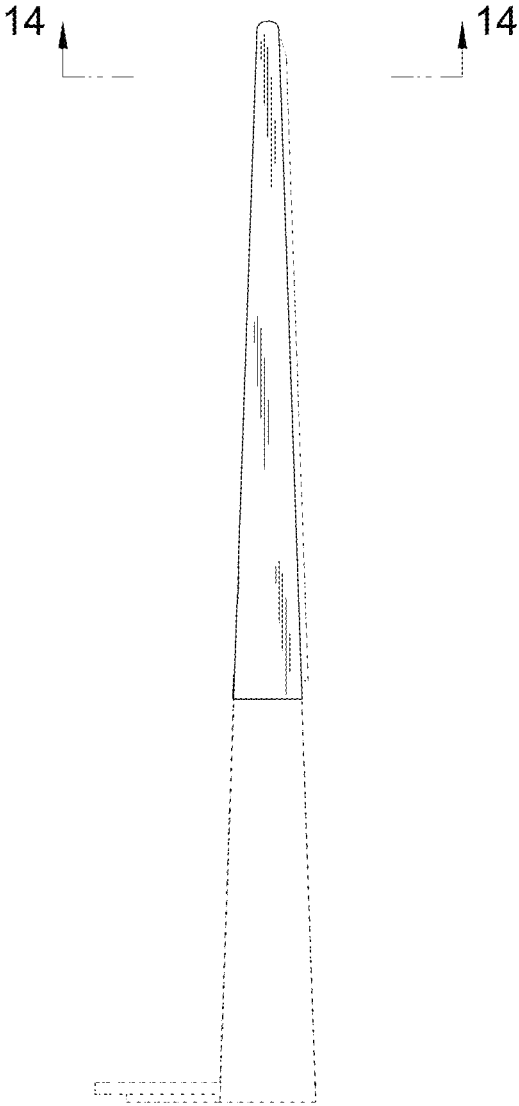

FIG.12

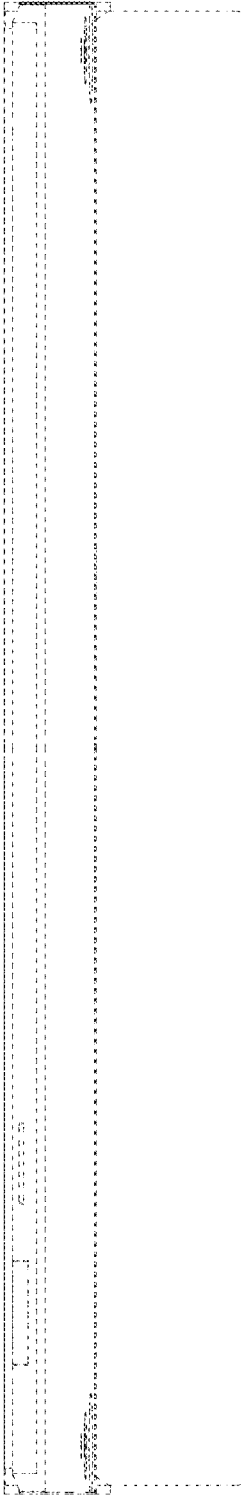

FIG.13

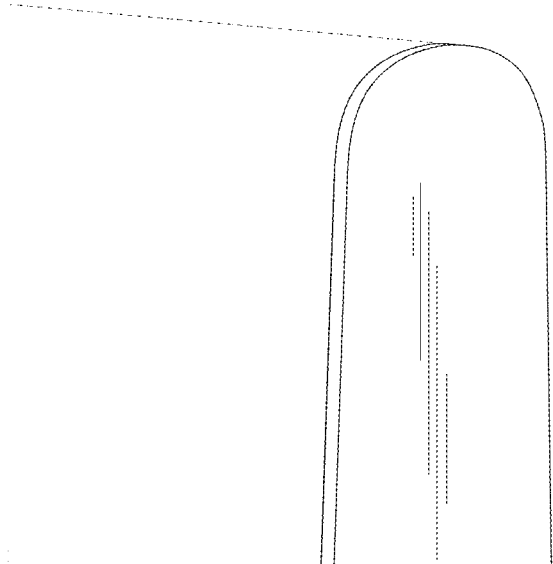

FIG.14

