



(12) **United States Design Patent**
Liu

(10) **Patent No.:** **US D996,253 S**
(45) **Date of Patent:** **** Aug. 22, 2023**

(54) **WATCH PROTECTIVE COVER**

(71) Applicant: **Wen Liu**, Shenzhen (CN)

(72) Inventor: **Wen Liu**, Shenzhen (CN)

(**) Term: **15 Years**

(21) Appl. No.: **29/884,062**

(22) Filed: **Feb. 7, 2023**

(51) **LOC (14) Cl.** **10-07**

(52) **U.S. Cl.** **D10/132**
USPC **D10/132**

(58) **Field of Classification Search**
USPC D10/30–39, 122, 128, 129–132; D11/3;
D14/344, 440
CPC A44C 5/00; A44C 5/0007; A44C 5/147;
A44C 17/02; A45C 2011/001–003; A45C
15/08; A45C 11/10; A45C 11/12; G04B
37/005; G04B 37/0058; G04B 37/084;
G04B 37/087; G04G 17/08

See application file for complete search history.

(56) **References Cited**

U.S. PATENT DOCUMENTS

D897,350 S *	9/2020	Wang	D14/440
D897,882 S *	10/2020	Yi	D14/440
D909,903 S	2/2021	Lin		
D920,147 S	5/2021	Qu		
D939,360 S *	12/2021	Qu	D10/32
D957,266 S *	7/2022	Zhou	D10/38
D958,683 S *	7/2022	Liu	D14/440
D960,020 S *	8/2022	Qin	D14/440

OTHER PUBLICATIONS

Polyjoy Screen Protector Verizon Gizmo Watch Disney Edition | amazon.com; date first avail. Sep. 1, 2022 [online]. © 1996-2023,

Amazon.com, Inc [retrieved Mar. 23, 2023] from Internet: <https://www.amazon.com/Polyjoy-Protector-Compatible-Smartwatch-Coverage/dp/B0BCQFP9GD?ref_=ast_sto_dp&th=1&psc=1> (Year: 2022).*

Kuaguoazhe Screen Protector Compaitble with Verizon Gizmo Watch | amazon.com; date first avial. Sep. 20, 2022 [online]. © 1996-2023, Amazon.com, Inc [retrieved Mar. 23, 2023] from Internet: <https://www.amazon.com/Kuaguoazhe-Protector-Compatible-Black%EF%BC%88Not-GizmoWatch/dp/B0BFW7B6BL> (Year: 2022).*

Besinpo Case for Gizmo Watch Disney Edition | amazon.com; date first avail. Sep. 27, 2022 [online]. © 1996-2023, Amazon.com, Inc [retrieved Mar. 23, 2023] from Internet: <https://www.amazon.com/BESINPO-Tempered-Protector-Protective-GizmoWatch/dp/B0BGLK5SNW?th=1> (Year: 2022).*

* cited by examiner

Primary Examiner — Katherine Glennon
(74) *Attorney, Agent, or Firm* — Daniel M. Cohn;
Howard M. Cohn

(57) **CLAIM**

The ornamental design for a watch protective cover, as shown and described.

DESCRIPTION

FIG. 1 is a perspective view of a watch protective cover showing my new design;
FIG. 2 is another perspective view thereof;
FIG. 3 is a front elevational view thereof;
FIG. 4 is a rear elevational view thereof;
FIG. 5 is a left side elevational view thereof;
FIG. 6 is a right side elevational view thereof;
FIG. 7 is a top plan view thereof; and,
FIG. 8 is a bottom plan view thereof.

1 Claim, 8 Drawing Sheets

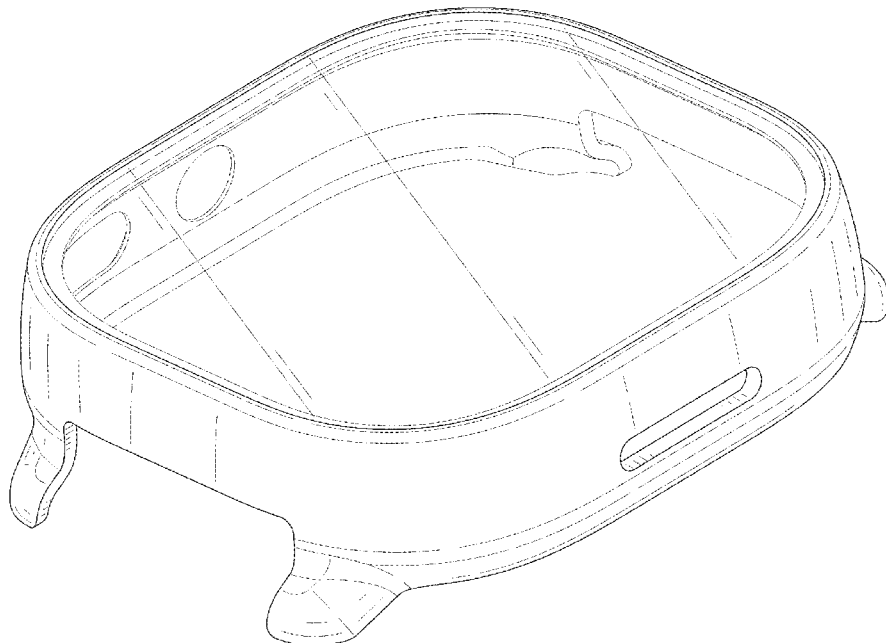

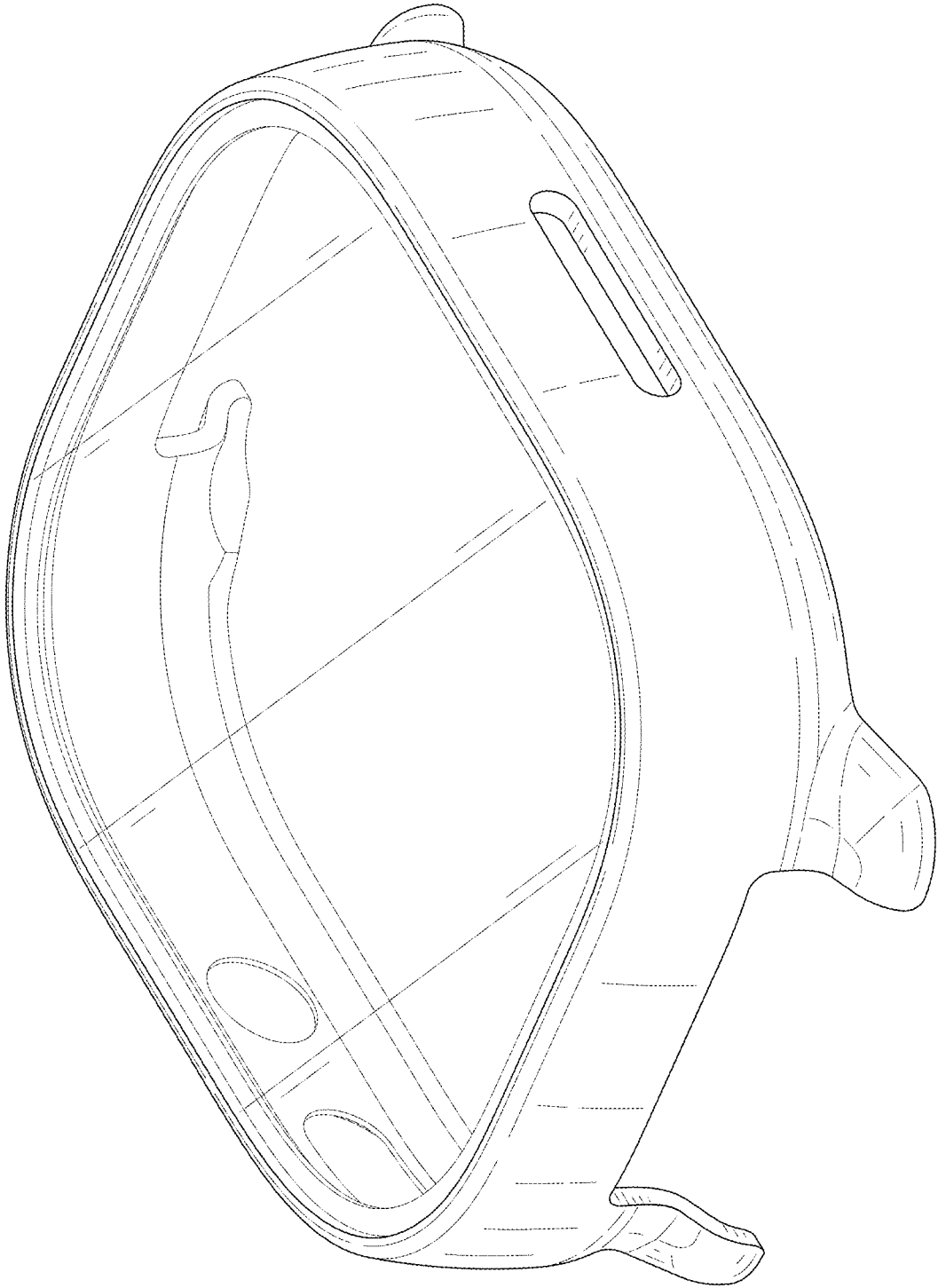

FIG. 1

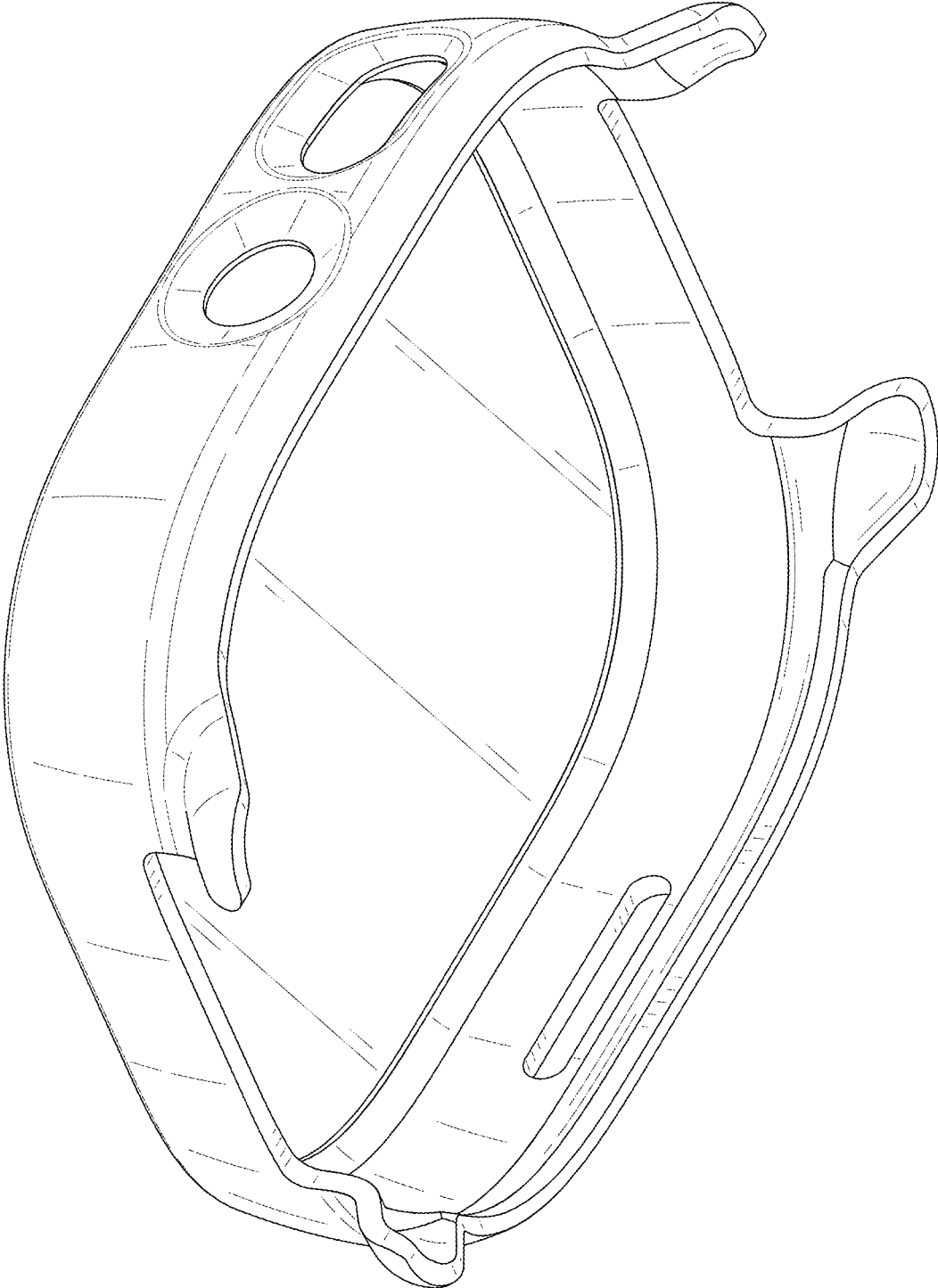

FIG. 2

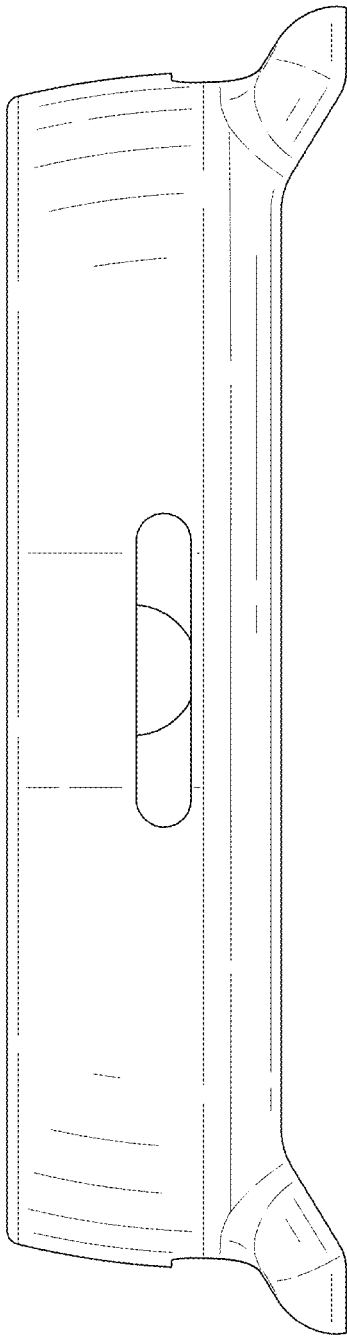

FIG. 3

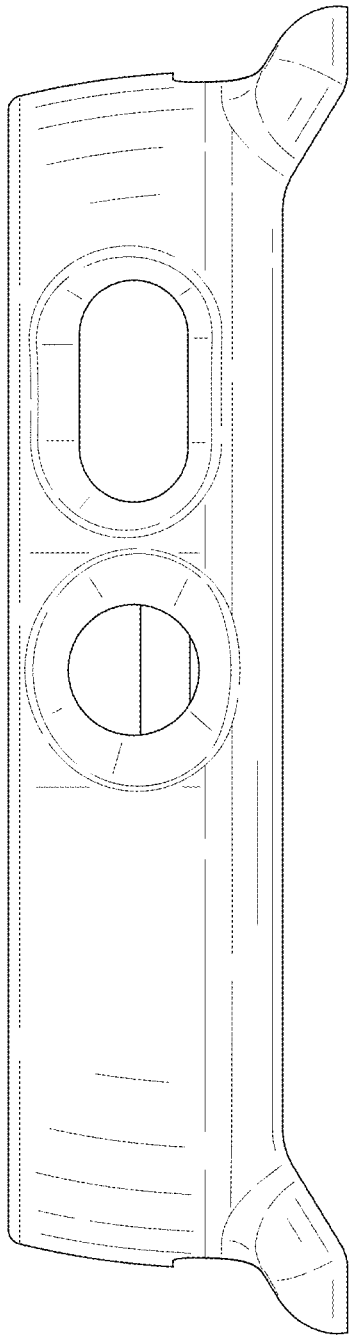

FIG. 4

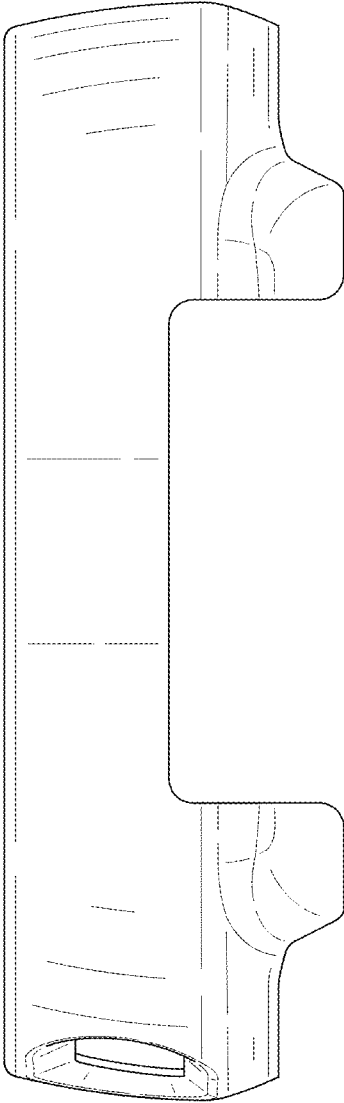

FIG. 5

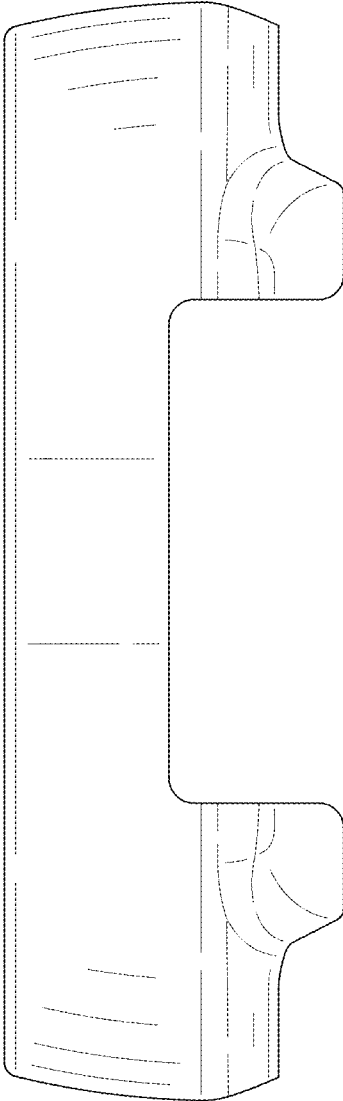

FIG. 6

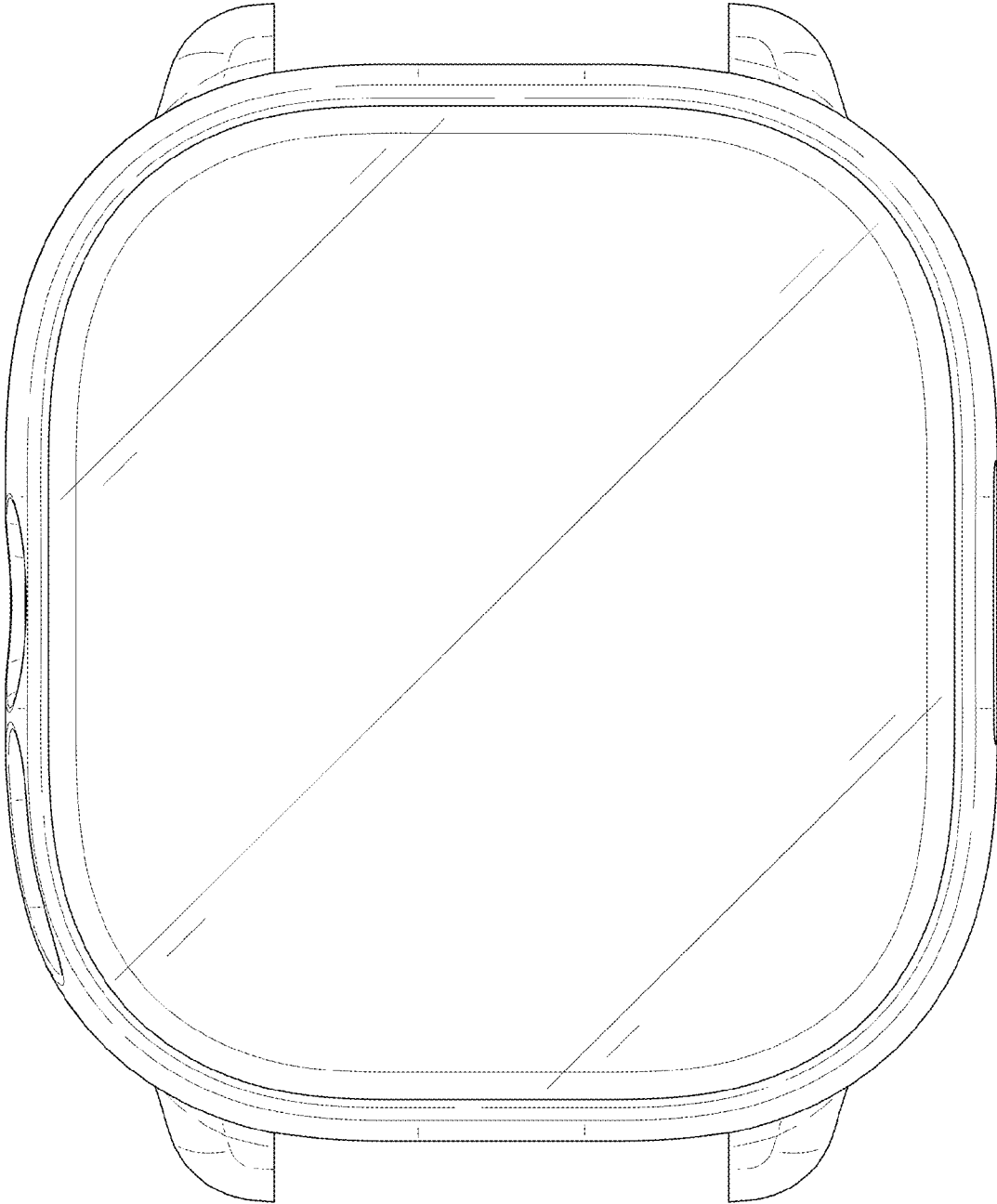

FIG. 7

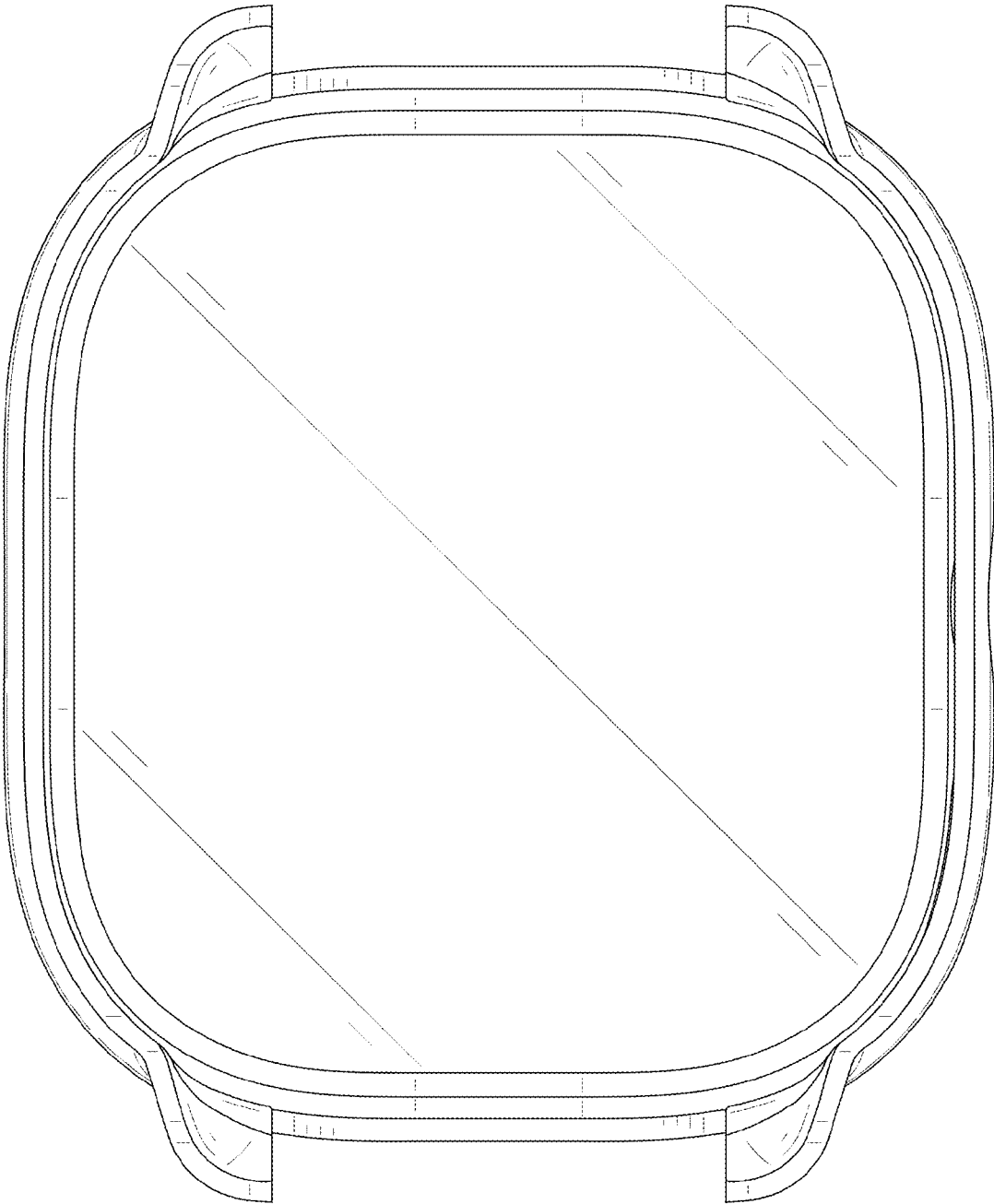

FIG. 8