



US00D940684S

(12) **United States Design Patent**
Snow

(10) **Patent No.:** **US D940,684 S**
(45) **Date of Patent:** **** Jan. 11, 2022**

- (54) **EARPHONES**
- (71) Applicant: **Buddy Snow**, Medina, MN (US)
- (72) Inventor: **Buddy Snow**, Medina, MN (US)
- (**) Term: **15 Years**
- (21) Appl. No.: **29/706,448**
- (22) Filed: **Sep. 20, 2019**

Related U.S. Application Data

- (63) Continuation-in-part of application No. 29/684,785, filed on Mar. 24, 2019.
- (51) **LOC (13) Cl.** **14-01**
- (52) **U.S. Cl.**
USPC **D14/205; D14/223**
- (58) **Field of Classification Search**
USPC ... D14/205, 188, 192, 217, 372, 224.1, 639, D14/496, 432, 371, 125, 126, 129, 223; 2/171, 181, 209.13; 381/380, 381, 376, 381/312, 315, 322; 345/8; D24/190, D24/214; 601/57, 66, 46; 128/907; D6/601; 4/575.1
CPC H04R 25/00; H04R 1/10; H04R 1/1058; H04R 1/02; H04R 5/02; A42B 1/24; A42B 3/30; G02B 27/01; G02B 27/017; A61H 1/00; A61N 5/06; A61N 7/00; A61B 5/11
See application file for complete search history.

(56) **References Cited**

U.S. PATENT DOCUMENTS

- 2,101,033 A * 12/1937 Mashbir H01Q 1/273
343/718
- 2,474,386 A * 6/1949 Volkmann A42B 3/166
381/378
- 2,553,089 A * 5/1951 Holder G04B 37/005
368/282

- 3,134,861 A * 5/1964 Dempsey H04R 1/105
381/326
- 3,747,171 A * 7/1973 Montague, Jr. A44C 5/2071
24/265 WS
- 3,983,483 A * 9/1976 Pando H01Q 1/273
455/90.2
- D247,312 S * 2/1978 Zeiss D24/215
- 4,135,653 A * 1/1979 Sieloff A45F 5/00
224/222
- 4,231,117 A * 11/1980 Aileo G02B 27/0176
2/420
- D262,455 S * 12/1981 Bulmash D14/192
- 4,412,106 A * 10/1983 Pavel G11B 25/063
224/673
- D282,020 S * 1/1986 Gwon D14/192
- 4,584,718 A * 4/1986 Fuller G11B 33/025
181/149
- D284,080 S * 6/1986 Swezey D14/192
- 4,682,363 A * 7/1987 Goldfarb H04B 1/44
381/189

(Continued)

Primary Examiner — Paula Allen Greene
(74) *Attorney, Agent, or Firm* — Jose W. Jimenez;
Jimenez Law Firm

(57) **CLAIM**

The ornamental design for earphones, as shown and described.

DESCRIPTION

FIG. 1 is a perspective view of earphones showing my new design;
FIG. 2 is a front view thereof;
FIG. 3 is a rear view of earphones thereof;
FIG. 4 is a right side elevation view of earphones showing my new design;
FIG. 5 is a left side view of the earphones;
FIG. 6 is a top view thereof; and,
FIG. 7 is a bottom view thereof.
The broken lines depict environment that forms no part of the claimed design.

1 Claim, 7 Drawing Sheets

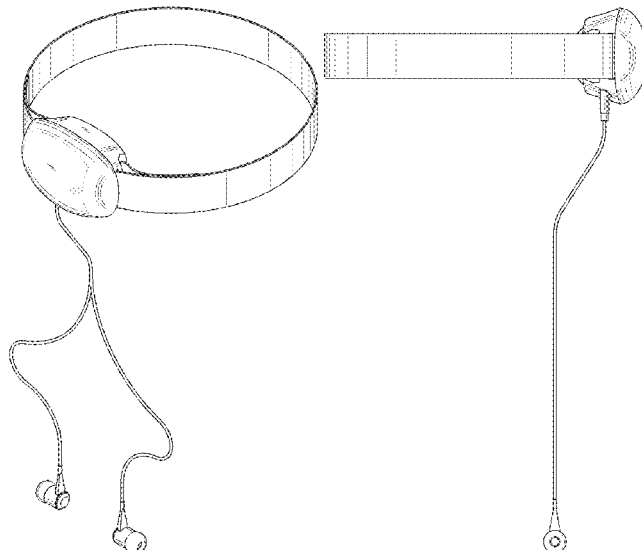

US D940,684 S

(56)

References Cited

U.S. PATENT DOCUMENTS

4,727,599	A *	2/1988	Rappaport	A42B 1/245 2/DIG. 11
D296,930	S *	7/1988	Carabelli	D24/190
4,864,619	A *	9/1989	Spates	H04R 1/10 381/309
4,913,326	A *	4/1990	Echelson	A45F 5/00 224/222
D310,907	S *	10/1990	Mark	D14/192
4,993,065	A *	2/1991	Chiou	H04M 1/05 379/430
5,034,995	A *	7/1991	Ciccone	H04B 1/088 455/344
5,109,421	A *	4/1992	Fox	G09B 19/00 381/333
D328,074	S *	7/1992	Yamazaki	D14/205
5,164,987	A *	11/1992	Raven	H04R 1/10 381/309
5,265,165	A *	11/1993	Rauch	A61F 9/045 2/10
5,305,244	A *	4/1994	Newman	G01R 1/025 704/E15.045
5,329,592	A *	7/1994	Altman	A41D 20/00 2/171
D351,172	S *	10/1994	Nakamura	D14/205
5,374,238	A *	12/1994	Xiao	A61H 23/0218 601/46
5,438,698	A *	8/1995	Burton	H01Q 1/276 2/209.13
D375,825	S *	11/1996	Whidden	D2/866
5,617,477	A *	4/1997	Boyden	H04R 3/12 381/309
5,646,635	A *	7/1997	Cockson	H01Q 1/2275 343/702
D384,790	S *	10/1997	Juergens	D14/192
5,680,465	A *	10/1997	Boyden	H04R 3/12 381/309
5,767,820	A *	6/1998	Bassett	G02B 27/017 345/7
5,881,390	A *	3/1999	Young	A41D 20/00 2/209.13
5,953,434	A *	9/1999	Boyden	H04R 3/12 381/301
5,956,630	A *	9/1999	Mackey	H04B 1/086 2/60
6,000,062	A *	12/1999	Trakh	A41D 20/00 2/171
D440,967	S *	4/2001	Jung	D14/372
D449,034	S *	10/2001	Weikel	D14/205
6,483,925	B1 *	11/2002	Shen	H04R 1/105 381/370
6,594,370	B1 *	7/2003	Anderson	H01Q 1/273 381/315
D486,478	S *	2/2004	Swan	D14/223
6,798,391	B2 *	9/2004	Peterson, III	G06F 1/163 345/8
D511,157	S *	11/2005	Johnson	D14/223
D512,981	S *	12/2005	Jacobson	D14/205
6,980,165	B2 *	12/2005	Yuasa	H01Q 1/273 343/718
D534,155	S *	12/2006	Obata	D14/205
D541,257	S *	4/2007	Thursfield	D14/205
D552,077	S *	10/2007	Brunner	D14/205
D578,120	S *	10/2008	Lowe	D14/372
D583,362	S *	12/2008	Hsu	D14/205
D601,641	S *	10/2009	Yeung	D16/306
D617,769	S *	6/2010	Birger	D14/205
7,848,512	B2 *	12/2010	Eldracher	H04B 1/385 379/450
D632,668	S *	2/2011	Brunner	D14/205
D635,959	S *	4/2011	Hutchieson	D14/205
7,983,437	B2 *	7/2011	Wong	H04R 1/1075 381/370
8,009,853	B2 *	8/2011	Ito	H04R 1/1066 381/381
D652,406	S *	1/2012	Lee	D14/205
8,111,859	B2 *	2/2012	Phillips	H04R 5/0335 381/376
D657,344	S *	4/2012	Brunner	D14/205
D660,823	S *	5/2012	Hardi	D14/205
D660,824	S *	5/2012	Hardi	D14/205
8,174,569	B2 *	5/2012	Tanijiri	G02B 27/0176 348/115
D663,716	S *	7/2012	Hardi	D14/205
8,213,632	B2 *	7/2012	Yamagishi	H04R 5/033 381/87
D685,345	S *	7/2013	Serota	D14/205
D687,434	S *	8/2013	Serota	D14/372
8,577,427	B2 *	11/2013	Serota	G02B 27/0176 455/575.2
D698,749	S *	2/2014	Brunner	D14/206
D703,634	S *	4/2014	Han	H04R 1/1016 D14/205
D704,706	S *	5/2014	Serota	D14/372
8,787,006	B2 *	7/2014	Golko	H04M 1/0254 361/679.03
D722,054	S *	2/2015	Serota	D14/372
D736,178	S *	8/2015	Tsou	D14/206
D741,327	S *	10/2015	Reznik	D14/372
D771,010	S *	11/2016	Louis	D14/205
D773,461	S *	12/2016	Jiang	D14/372
D776,110	S *	1/2017	Gribetz	D14/372
D780,752	S *	3/2017	Park	D14/372
D781,288	S *	3/2017	Park	D14/372
D781,822	S *	3/2017	Morris	D14/223
D785,619	S *	5/2017	Su	D14/372
D791,741	S *	7/2017	Chen	D14/223
9,858,030	B2 *	1/2018	Serota	G06F 3/011
9,864,200	B2 *	1/2018	Chen	G02B 27/0176
D813,202	S *	3/2018	Johnson	D14/217
D817,327	S *	5/2018	Sun	D14/372
D817,955	S *	5/2018	Sun	D14/372
D824,904	S *	8/2018	Hitch	D14/372
D861,682	S *	10/2019	Serota	D14/372
D869,446	S *	12/2019	Bryant	D14/225
D870,062	S *	12/2019	Peng	D14/192
D885,383	S *	5/2020	Chang	D14/372
10,695,263	B2 *	6/2020	Snow	A61H 23/0218
D900,054	S *	10/2020	Kim	D14/192
2005/0123151	A1 *	6/2005	Whipple	H04R 5/023 381/103
2006/0076375	A1 *	4/2006	Bhakta	A45F 5/00 224/222
2006/0186150	A1 *	8/2006	Willows	A45F 3/00 224/222
2008/0112581	A1 *	5/2008	Kim	H04R 1/1075 381/151
2010/0107292	A1 *	5/2010	Chevallier	A42B 3/223 2/6.2
2013/0237146	A1 *	9/2013	Serota	H04M 1/05 455/12.1
2018/0035189	A1 *	2/2018	Givens	H04R 1/028
2020/0159028	A1 *	5/2020	Araki	G06F 1/1605

* cited by examiner

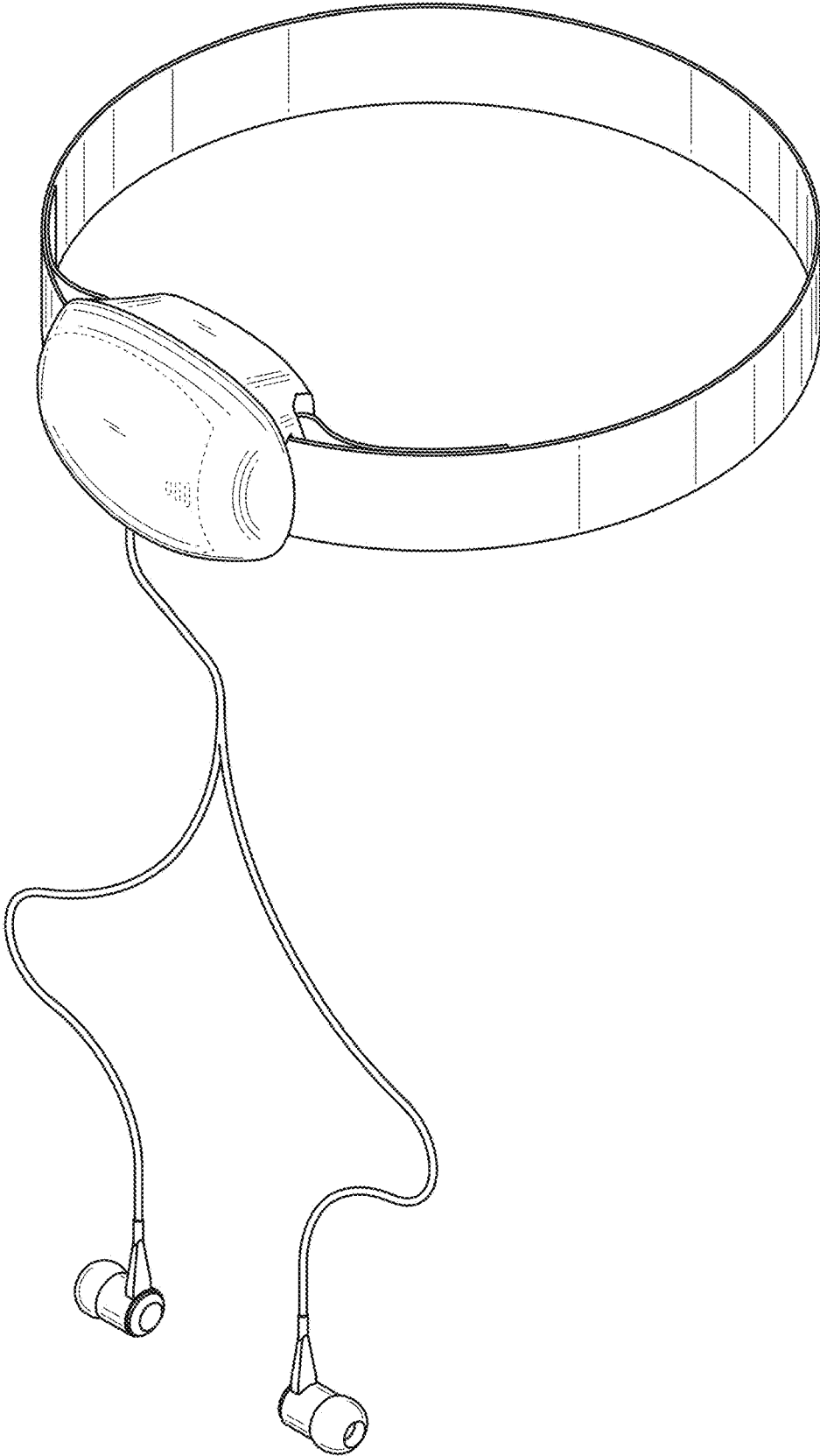

FIG. 1

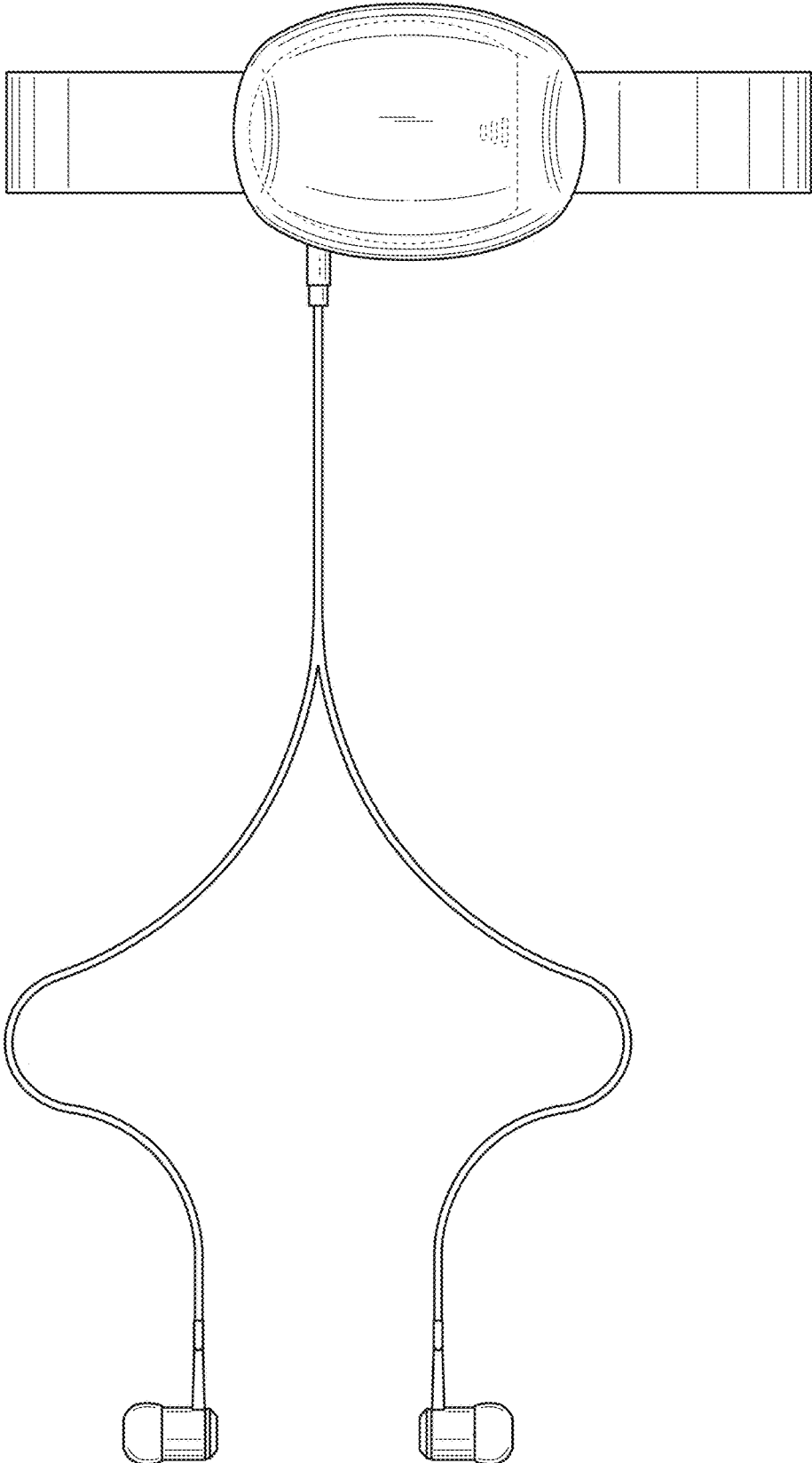

FIG. 2

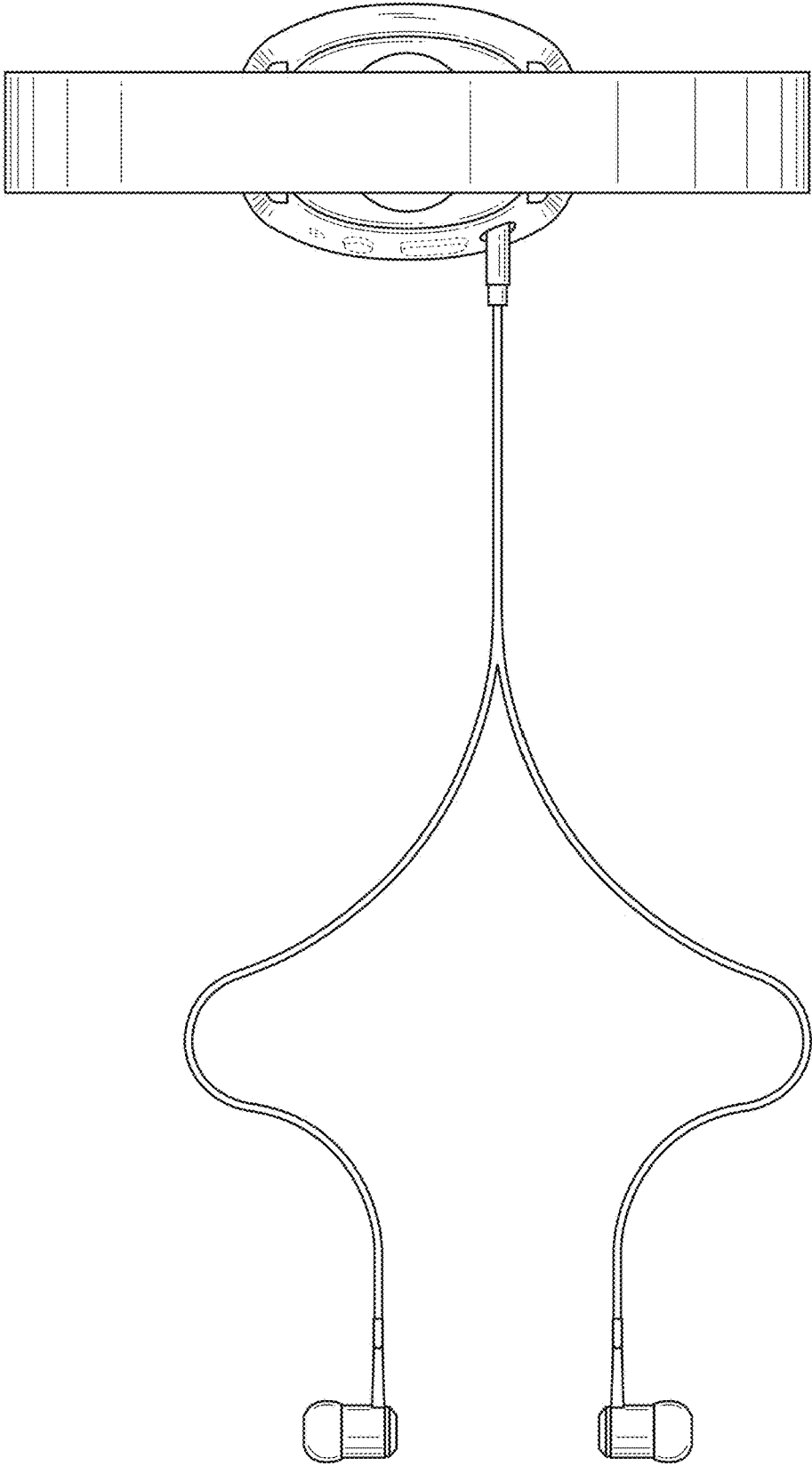

FIG. 3

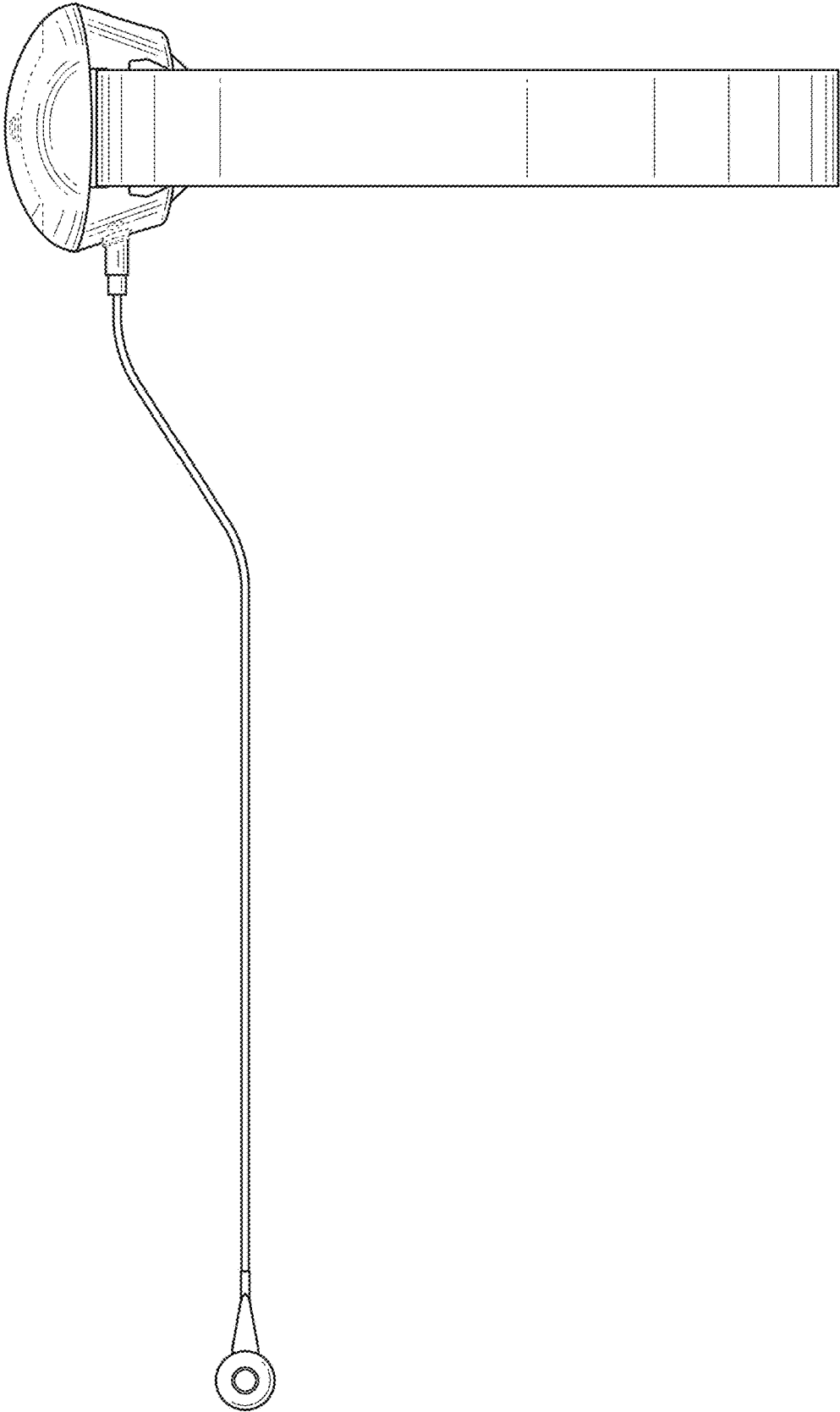

FIG. 4

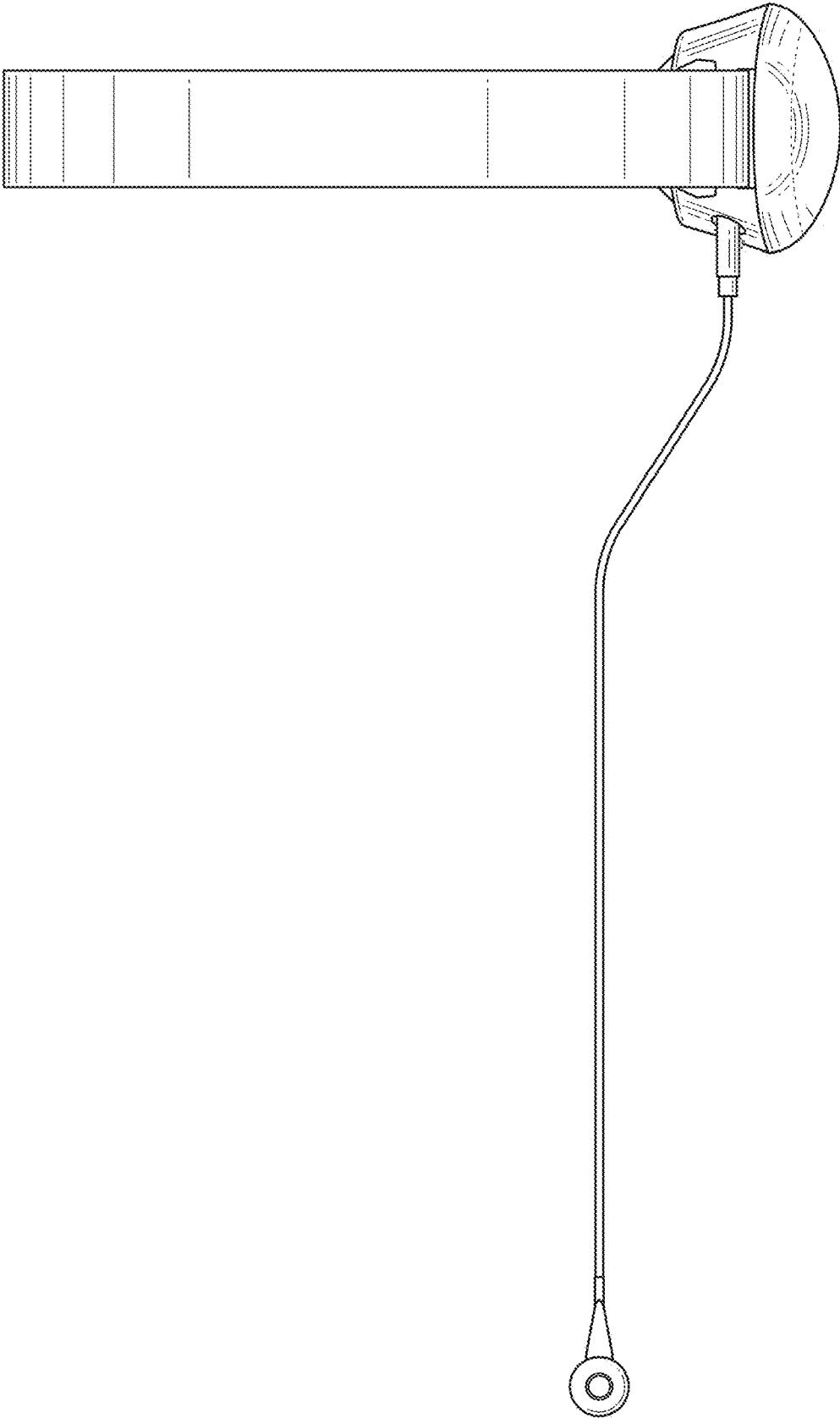

FIG. 5

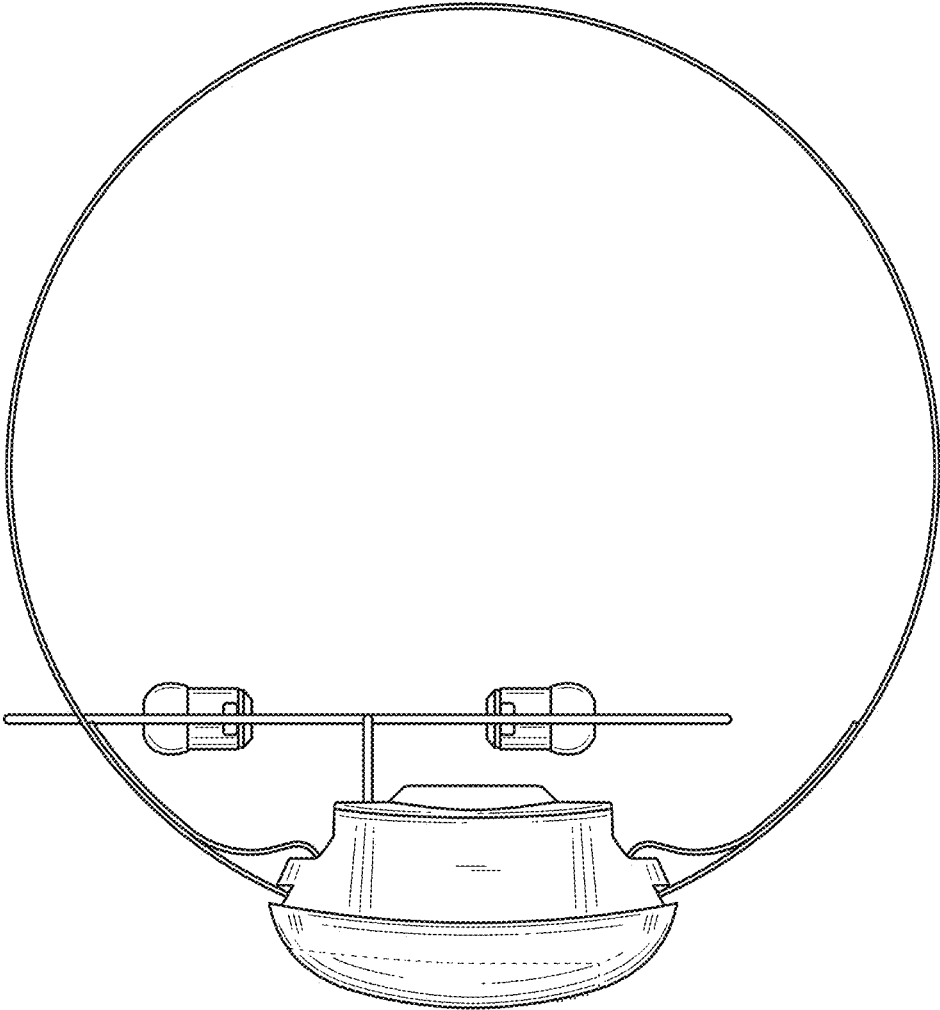

FIG. 6

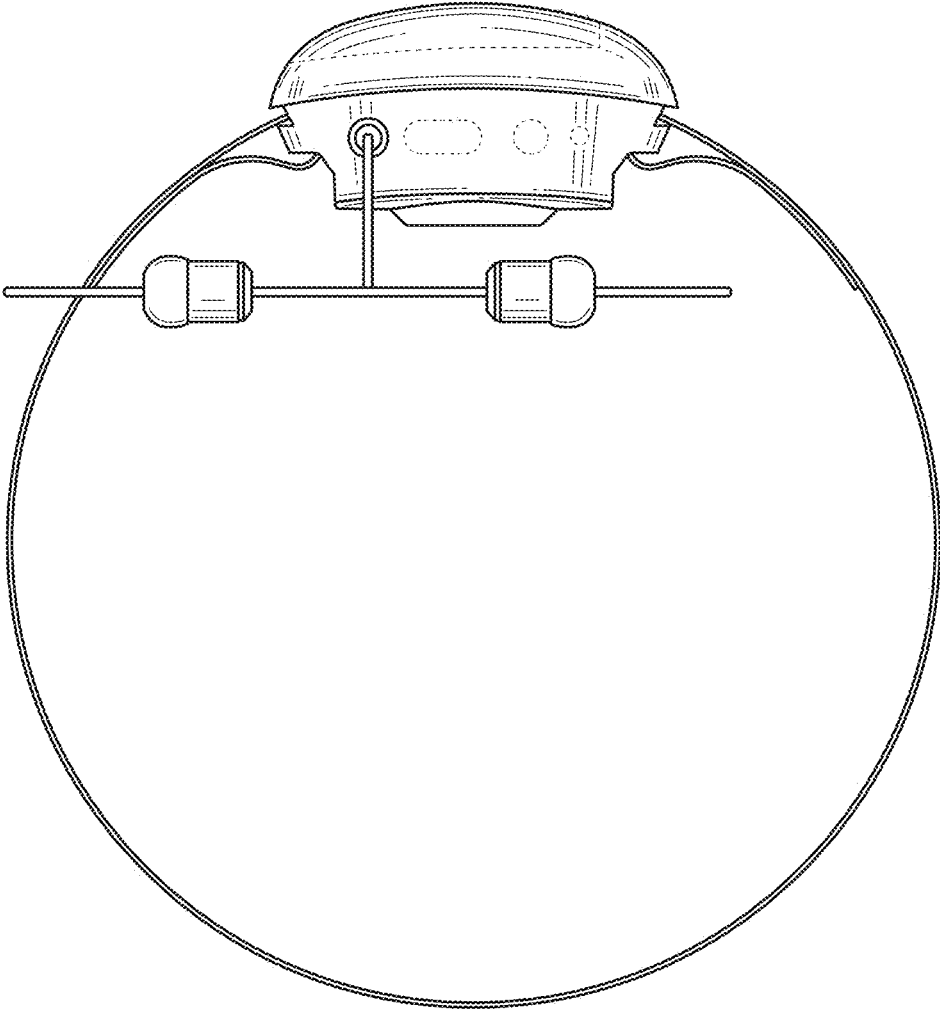

FIG. 7