

(19) AUSTRALIAN PATENT OFFICE

(54) Title
A fingerguard

(51) 6 International Patent Classification(s)
E06B 7/36 20060101AFI20
(2006.01) 060101BHAU
E06B 7/36

(21) Application No: 2003200433 (22) Application Date: 2003.02.10

(30) Priority Data

(31) Number	(32) Date	(33) Country
0207651.1	2002.04.03	GB

(43) Publication Date : 2003.10.23
(43) Publication Journal Date : 2003.10.23

(71) Applicant(s)
Lorient Polyproducts Ltd

(72) Inventor(s)
Mann, Robert McGowan; Newcombe, Giles; Tapper, Tony

(74) Agent/Attorney
Griffith Hack, 509 St Kilda Road, Melbourne, VIC, 3004

(56) Related Art
US 2910741, US 1444398

ABSTRACT

A FINGERGUARD

A fingerguard for mounting between a support frame and a leaf
5 which is hingedly mounted on the support frame for movement between a
closed position and an open position, the leaf having an end edge defined at
the juncture of an end face and a front face of the leaf, the end face of the
leaf being closely spaced from the support frame when in its closed position
to define a gap, the end face being moved away from the support frame to
10 cause said gap to be widened on movement of the leaf to its open position,
the fingerguard including a first mounting strip for mounting on the support
frame along one side of said gap and a second mounting strip for mounting
on said leaf along an opposite side of the gap, a cover strip having a pair of
spaced longitudinal edges, one of said longitudinal edges being secured to
15 and along said first mounting strip and the other of said longitudinal edges
being secured to and along the second mounting strip such that in use the
cover strip extends across and prevents access into said gap, the cover strip
including a sealing formation on its inner face opposed to the front face of
the leaf, said sealing formation in use being held in sealing contact with said
20 front face of the leaf so as to sealingly isolate said gap when the leaf is in its
closed position.

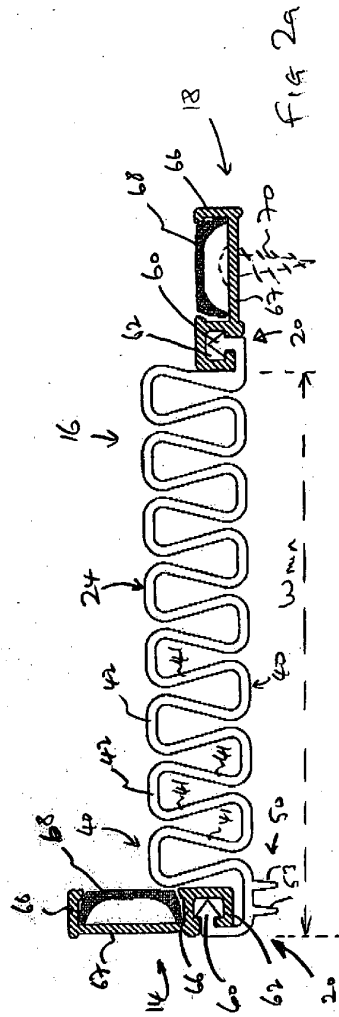

FIG 2a

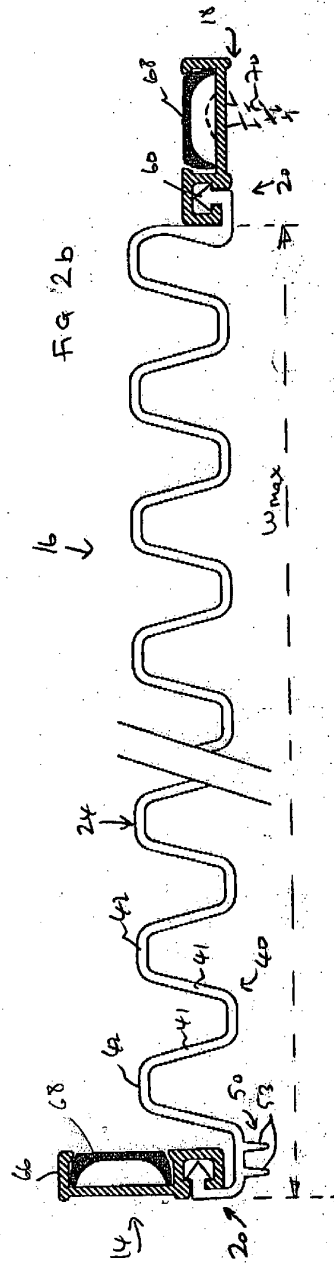

FIG 2b

AUSTRALIA
Patents Act 1990

COMPLETE SPECIFICATION
STANDARD PATENT

Applicant:

LORIENT POLYPRODUCTS LTD

Invention Title:

A FINGERGUARD

The following statement is a full description of this invention, including the best method of performing it known to me/us:

A FINGERGUARD

The present invention relates to a fingerguard, in particular, but not
exclusively a fingerguard which prevents fingers being trapped within a gap
5 formed between a door and door frame.

According to one aspect of the invention there is provided a fingerguard for
mounting between a support frame and a leaf which is hingedly mounted on
the support frame for movement between a closed position and an open
10 position, the leaf having an end edge defined at the juncture of an end face
and a front face of the leaf, the end face of the leaf being closely spaced
from the support frame when in its closed position to define a gap, the end
face being moved away from the support frame to cause said gap to be
widened on movement of the leaf to its open position, the fingerguard
15 including a first mounting strip for mounting on the support frame along
one side of said gap and a second mounting strip for mounting on said leaf
along an opposite side of the gap, a cover strip having a pair of spaced
longitudinal edges, one of said longitudinal edges being secured to and
along said first mounting strip and the other of said longitudinal edges
20 being secured to and along the second mounting strip such that in use the
cover strip extends across and prevents access into said gap, the cover strip
including a sealing formation on its inner face opposed to the front face of
the leaf, said sealing formation being located adjacent to the longitudinal
edge secured to and along said first mounting strip, said sealing formation
25 in use being held in sealing contact with said front face of the leaf so as to
sealingly isolate said gap when the leaf is in its closed position.

Preferably, the cover strip is generally planar and in use extends in a plane
generally parallel to the front face of the leaf, the cover being resiliently
30 extensible across its width as defined between said pair of longitudinal
edges so as to have a minimum width when the leaf is in its fully closed
position and a maximum width when the leaf is in its fully open position.

Preferably, the cover strip, in cross-section, comprises a series of
35 undulations which define a concertina-like body.

Typically, the cover strip is extruded from a suitable resilient plastics

material, preferably an elastomer, and each mounting strip is an extrusion formed from a suitable rigid material.

5 Preferably, the cover strip and each mounting strip are integrally joined by being co-extruded with one another.

Preferably, the sealing formation is defined by one or more sealing lips projecting from said inner face of the cover.

10 Various aspects of the present invention are hereinafter described with reference to the accompanying drawings, in which:-

Figure 1 is a part perspective view of a fingerguard according to a first embodiment of the invention shown in situ;

15 Figures 2a, 2b are cross-sectional views of the first embodiment shown in a fully contracted and fully extended condition, respectively;

Figure 3 is a cross-sectional view of a second embodiment according to the present invention.

20 A fingerguard 10 according to a first embodiment of the present invention is illustrated in Figures 1 and 2 and comprises a first mounting strip 14, a cover strip 16 and a second mounting strip 18.

The cover strip 16 has a pair of longitudinal sides or edges 20, 21 which are spaced apart from one another to define the width of the cover strip 16.

25

The cover strip 16, inbetween the longitudinal sides 20, 21 has a planar body 24 which is adapted such that it is extensible in the widthwise direction whilst remaining substantially planar to enable the width of the cover strip 16 to be increased and decreased between a minimum width dimension and a maximum width dimension (illustrated schematically in
5 Figures 2a, 2b as W_{\min} and W_{\max} respectively).

As shown in Figures 1 and 2, in use, the fingerguard 10 is mounted on a door frame 30 and door leaf 31. The door leaf 31 has a door edge 32 at the
10 juncture between a door end face 33 and door front face 34.

The door end face 33 is closely spaced from the door frame 30 to define a gap 38 therebetween. The door leaf 31 is hingedly mounted on the door frame 30 so as to be hingedly connected thereto for movement between a
15 fully closed position (as shown in Figure 1) and a fully open position. The hinge axis about which the door leaf 31 moves is located adjacent to the door edge 37.

Accordingly when the door leaf 31 moves towards its fully open position,
20 the end face 33 moves away from the door frame 30 to cause the gap 38 to widen, particularly in the region of door edge 32.

The first mounting strip 14 is mounted on the door frame 30 close to the front face 34 and along one side of the gap 38. The second mounting strip
25 18 is mounted on the front face 34 along the opposite side of the gap 38. Accordingly, the cover strip 16 extends across the gap 38 and prevents access into it. The fingerguard 10 preferably extends along the full height of the door leaf 31.

As seen in Figures 1 and 2, the first and second mounting strips 14, 18 are arranged at 90° relative to one another with the planar body 24 of the cover strip 16 extending in parallel and along the front face 34.

- 5 Accordingly, when the door leaf 31 is moved to its fully open position, the width of the body 24 is extended to its maximum width dimension W_{max} and when the door leaf 31 is moved back to its fully closed position, the body 24 is contracted back to its minimum width dimension W_{min} .
- 10 A minor portion of the planar body 24 is caused to arc across the gap 38 as the door is opened and closed. Thus it will be appreciated that the extension and contraction of the planar body 24 primarily occurs within the plane of the planar body 24 and so the majority of the planar body 24 remains in a plane parallel to the front face 34 during opening and closing of the door
- 15 leaf 31. This ensures that the fingerguard 10 of the present invention is relatively compact.

To enable the cover strip 16 to extend and contract within a plane, the body 24 is preferably formed from a resilient plastics sheet which is formed into a series of undulations 40 and thereby define a concertina-like body. The

20 undulations 40 are preferably of loop-like shape in cross-section having a pair of legs 41 extending from a base 42. Preferably the pair of legs 41 are inwardly inclined from their associated base 42 and each base 42 is preferably substantially flat. This enables adjacent bases 42 to be located in

25 a closely spaced side by side manner and provide the body 24 with substantially flat outer and inner faces.

It will be appreciated that extension of the body 24 to its maximum width W_{max} is caused by a pulling force exerted between the mounting strips 14,

30 18 and that the pulling force causes the legs 41 to bend outwardly relative to their associated base 42.

b

Preferably the length of the legs 41 is chosen to ensure that extension of the body 24 to its maximum width W_{max} is accommodated by resilient bending of legs 41 only and not stretching of the plastics sheet from which the legs
5 41 are formed.

Preferably the juncture between each leg 41 and their associated base 42 is curved in order to spread the bending stresses evenly.

10 Contraction of the body 24 from its maximum width W_{max} to its minimum width W_{min} is achieved by resilient recovery of the bent legs 41 back to their original positions as the door leaf is moved back to its fully closed position.

Preferably the cover strip 16 is moulded by extrusion from a suitable
15 elastomer, such as a conventional rubber, a silicone rubber, an ethylene propylene diene monomer or a non-elastomeric material such as flexible polyvinylchloride.

A sealing formation 50 is preferably provided on the inner face of the planar
20 body 24 adjacent to the longitudinal side 20 of the cover strip 16.

The sealing formation 50 extends the full length of the cover strip 16 and preferably comprises two sealing lips 53 which project substantially perpendicularly away from the body 24 towards the front face 34 of the
25 door leaf.

Preferably the lips 53 are integrally connected with the body 24 by being co-extruded therewith. The lips 53 may be formed from the same elastomer from which the body 24 is formed or may be a different extrudable
30 elastomer.

Preferably as illustrated in Figures 2 and 3, the sealing formation at least in part underlies the mounting strip 14 such that when the door leaf 31 is in its fully closed position, the sealing formation 50 is directly located between the front face 34 of the door leaf and the facing side 14a of the mounting strip 14.

As schematically illustrated in Figure 3, the mounting strip 14 is preferably mounted on the frame 30 so that its facing side 14a is spaced from the front face 34 by a distance D_1 which is less than the distance D_2 by which the terminal ends of the lips 53 project from the mounting strip 14.

Accordingly, when the door leaf 31 is in its fully closed position, sealing lips 53 are compressed between the front face 34 and mounting strip 14 and so are resiliently urged into contact with the front face 34 to provide an effective seal.

It will be appreciated that, if desired, the sealing formation 50 may comprise one or more than two sealing lips 53.

It will be appreciated that the sealing formation 50 in combination with the mounting strip 14 and that portion of the cover strip 16 inbetween the sealing formation 50 and strip 14 form an effective seal to sealingly isolate the gap 38 and so act to prevent smoke or sound passing from one side of the door leaf to the other through the gap 38.

In the embodiment of Figure 2, the cover strip 16 is provided with enlarged rib formations 60 extending along its opposed longitudinal sides 20, 21. The rib formations 60 enable the sides of the cover strip 16 to be attached to a respective mounting strip 14, 18 by being secured within a closed channel 62 formed in the body of the mounting strip 14, 18. Preferably each rib formation 60 is a push-fit within the receiving channel 62. With this arrangement, the mounting strip 14, 18 may be formed, preferably by

extrusion, from any suitable rigid material such as a metal, e.g. aluminium or a plastics material.

5 Preferably each mounting strip 14, 18 has a main body in the form of an open topped channel having sides 66 and a bottom wall 67.

10 Preferably the strips 14, 18 are each secured to the frame 30 or door leaf 31 by fixing means 70, such as screws, passing through the bottom wall 67. A capping strip 68 is preferably provided which is a snap-fit between the sides 66; the capping strip 68 serving to hide the fixing means 70 and improve the aesthetic appearance of the mounting strip.

15 The capping strip 68 is preferably extruded from a rigid or flexible polyvinylchloride.

The embodiment of Figure 3 is the same as the embodiment of Figure 2 except for the manner of attachment of the cover strip 16 to the mounting strips 14, 18.

20 In this respect, in the embodiment of Figure 3, the sides of the cover strip 16 are integrally connected to the mounting strips 14, 18. Preferably the integral connection is achieved by co-extruding the cover strip 16 and the bodies of the mounting strips 14, 18 from compatible plastics material such as rigid polyvinylchloride or polypropylene.

25 In the above described embodiments, the leaf comprises a door leaf. It will be appreciated that the term leaf may apply to other types of planar body which are hingedly secured to a frame, such as for example a glazed assembly or window frame.

30

8a

For the purposes of this specification it will be clearly understood that the word "comprising" means "including but not limited to", and that the word "comprises" has a corresponding meaning.

It is to be understood that, if any prior art publication is referred to herein, such reference does not constitute an admission that the publication forms a part of the common general knowledge in the art, in Australia or any other country.

THE CLAIMS DEFINING THE INVENTION ARE AS FOLLOWS:

- 5 1. A fingerguard for mounting between a support frame and a leaf which is hingedly mounted on the support frame for movement between a closed position and an open position, the leaf having an end edge defined at the juncture of an end face and a front face of the leaf, the end face of the leaf being closely spaced from the support frame when in its closed position to define a gap, the end face being moved away from the support frame to cause said gap to be widened on movement of the leaf to its open position, 10 the fingerguard including a first mounting strip for mounting on the support frame along one side of said gap and a second mounting strip for mounting on said leaf along an opposite side of the gap, a cover strip having a pair of spaced longitudinal edges, one of said longitudinal edges being secured to and along said first mounting strip and the other of said longitudinal edges 15 being secured to and along the second mounting strip such that in use the cover strip extends across and prevents access into said gap, the cover strip including a sealing formation on its inner face opposed to the front face of the leaf, said sealing formation being located adjacent to the longitudinal edge secured to and along said first mounting strip, said sealing formation 20 in use being held in sealing contact with said front face of the leaf so as to sealingly isolate said gap when the leaf is in its closed position.
- 25 2. A fingerguard according to claim 1 wherein the cover strip is generally planar and in use extends in a plane generally parallel to the front face of the leaf, the cover being resiliently extensible across its width as defined between said pair of longitudinal edges so as to have a minimum width when the leaf is in its fully closed position and a maximum width when the leaf is in its fully open position.
- 30 3. A fingerguard according to claim 2 wherein the cover strip, in cross-section, comprises a series of undulations which define a concertina-like body.
- 35 4. A fingerguard according to any preceding claim wherein the cover strip is extruded from a suitable resilient plastics material, preferably an elastomer.

5. A fingerguard according to claim 4 wherein each mounting strip is an extrusion formed from a suitable rigid material.
6. A fingerguard according to claim 5 wherein the cover strip and each mounting strip are integrally joined by being co-extruded with one another.
7. A fingerguard according to any preceding claim wherein the sealing formation is defined by one or more sealing lips projecting from said inner face of the cover.
8. A fingerguard substantially as herein described with reference to the accompanying drawings.
- 15 Dated this 1st day of February 2006
LORIENT POLYPRODUCTS LTD
By their Patent Attorneys
GRIFFITH HACK
Fellows Institute of Patent and
20 Trade Mark Attorneys of Australia



Melbourne Office
509 St Kilda Road Melbourne
VIC 3004 Australia
GPO Box 1285K Melbourne
VIC 3001 Australia

Telephone +61 3 9243 8300
Facsimile +61 3 9243 8333
Facsimile +61 3 9243 8334
ghmelb@griffithhack.com.au
www.griffithhack.com.au

The Commissioner of Patents

28 March 2003

Madam

IN THE MATTER OF Australian Patent Application No. 2003200433
in the name of LORIENT POLYPRODUCTS LTD
Our Ref: PNF:LW:P48626

Further to our letter of 10 February 2003, we lodge herewith formal drawings (3 sheets). It is hereby requested that the drawings lodged on 10 February 2003 be deleted and replaced with the formal drawings lodged herewith.

Yours faithfully

GRIFFITH HACK
MELBOURNE OFFICE

C.M. BENTLEY

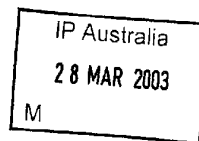

MELBOURNE SYDNEY PERTH BRISBANE

Associated with Computer Patent Annuities Limited Partnership Affiliated with Griffith Hack Lawyers

1/3

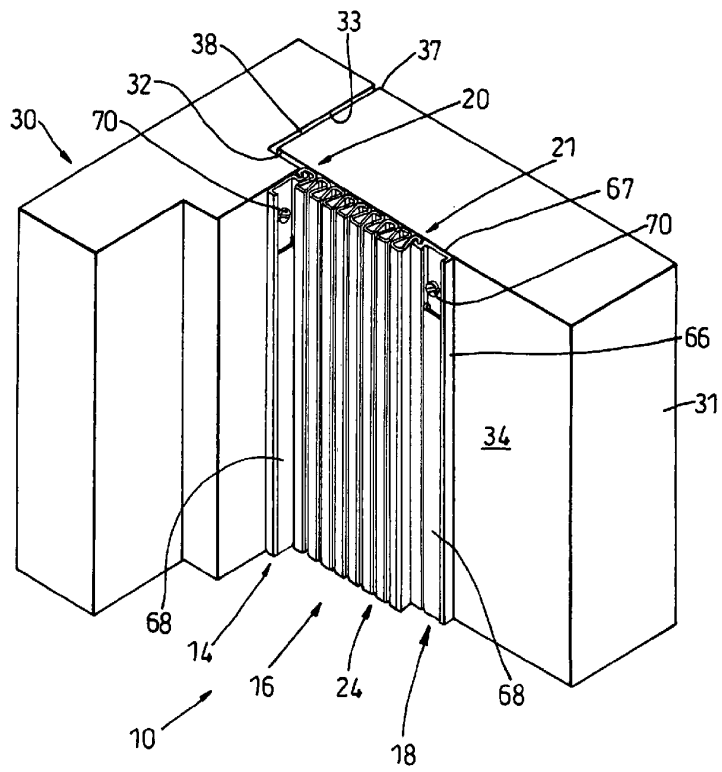

Fig. 1

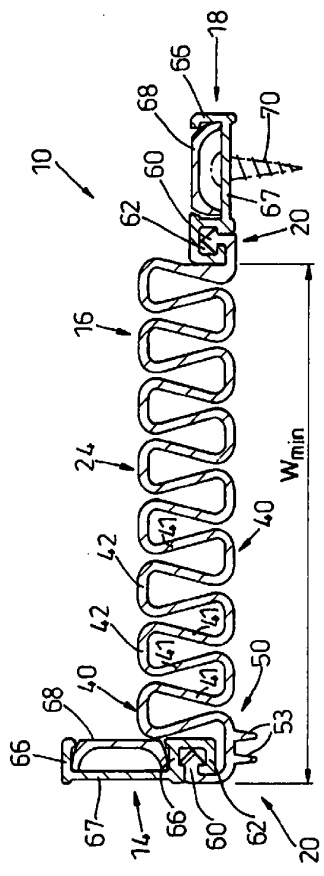

Fig. 2a

2/3

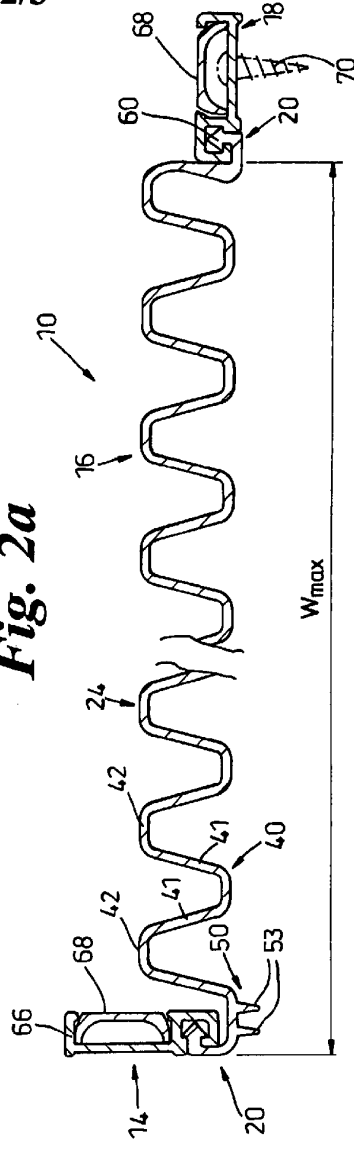

Fig. 2b

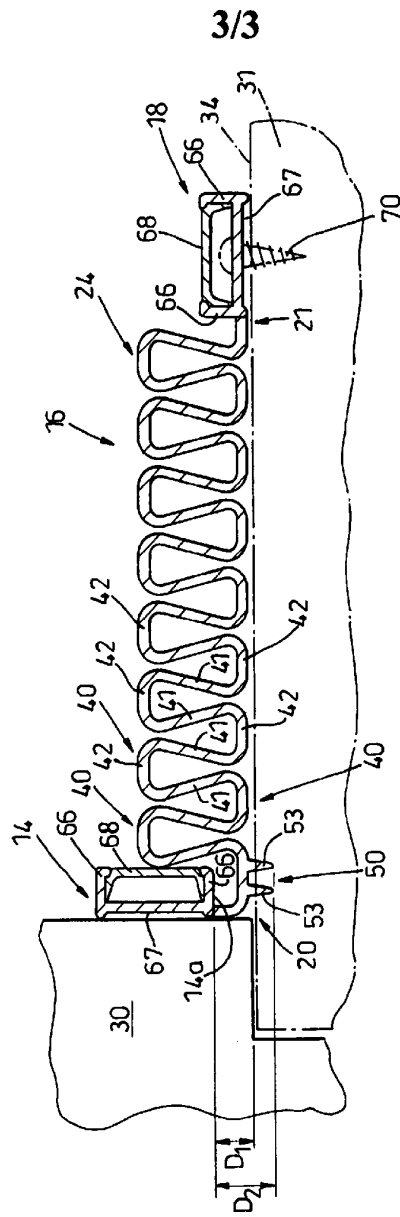

Fig. 3