



US00D803633S

(12) **United States Design Patent**
Boroski

(10) **Patent No.:** **US D803,633 S**

(45) **Date of Patent:** **** Nov. 28, 2017**

- (54) **CONTAINER WITH LID**
- (71) Applicant: **THERMOS L.L.C.**, Schaumburg, IL (US)
- (72) Inventor: **Dwayne Boroski**, Lake in the Hills, IL (US)
- (73) Assignee: **THERMOS L.L.C.**, Schaumburg, IL (US)

D455,612 S	4/2002	Gullickson et al.	
6,530,496 B2	3/2003	Moran	
D479,785 S	9/2003	Schuler	
6,626,326 B2	9/2003	Murakami	
D497,778 S	11/2004	Rich	
D503,589 S	4/2005	Schuler	
D530,161 S	10/2006	Carreno et al.	
D587,534 S	3/2009	Carreno	
7,614,516 B2	11/2009	Beggins	
D629,691 S *	12/2010	Cresswell	D9/500
D630,062 S *	1/2011	Carreno	D7/608
D660,084 S *	5/2012	Gilbert	D7/510

(**) Term: **15 Years**

(21) Appl. No.: **29/556,411**

(22) Filed: **Mar. 1, 2016**

(51) **LOC (10) Cl.** **07-01**

(52) **U.S. Cl.**
USPC **D7/608**

(58) **Field of Classification Search**
USPC D7/605-608, 619.1-625, 509-511;
D9/500-505, 537, 522, 558, 516, 532,
D9/443

CPC A47G 23/0216; A47G 23/0258; F17C
13/001; B65D 81/3886; B65D 81/3823;
B65D 81/3818; B65D 81/3846; B65D
1/0215; F25D 3/08; F25D 3/14; F25D
2331/804; A47J 42/02; A47J 41/0077;
A47J 41/02; A47J 41/022; A47J 41/024;
A47J 41/026; A47J 41/028; A47J 41/00

See application file for complete search history.

(56) **References Cited**

U.S. PATENT DOCUMENTS

1,927,553 A	12/1932	Lusher
5,329,778 A	7/1994	Padamsee
6,119,888 A	9/2000	Goto et al.
D432,367 S	10/2000	Segura
D455,052 S	4/2002	Gullickson et al.

OTHER PUBLICATIONS

U.S. Appl. No. 29/596,618, filed Mar. 9, 2017 (23 pages).

* cited by examiner

Primary Examiner — Terry A Wallace

(74) *Attorney, Agent, or Firm* — Polsinelli PC

(57) **CLAIM**

The ornamental design for a container with lid, as shown and described.

DESCRIPTION

FIG. 1 is a perspective view of the container with lid;
FIG. 2 is a front view of the container with lid;
FIG. 3 is a left side view of the container with lid;
FIG. 4 is a right side view of the container with lid;
FIG. 5 is a rear view of the container with lid;
FIG. 6 is a top view of the container with lid; and,
FIG. 7 is a bottom view of the container with lid.
The broken lines showing in the figures are included for the purpose of illustrating portions of the container with lid that form no part of the claimed design. The dash-dot lines showing in the figures are included for defining the bounds of the claimed design that form no part thereof.

1 Claim, 4 Drawing Sheets

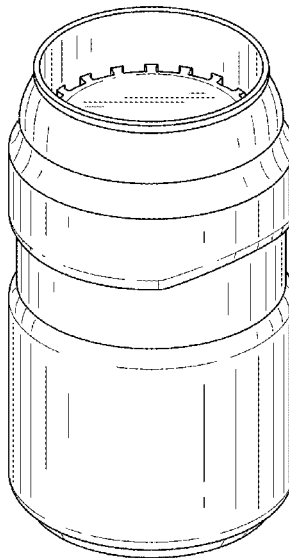

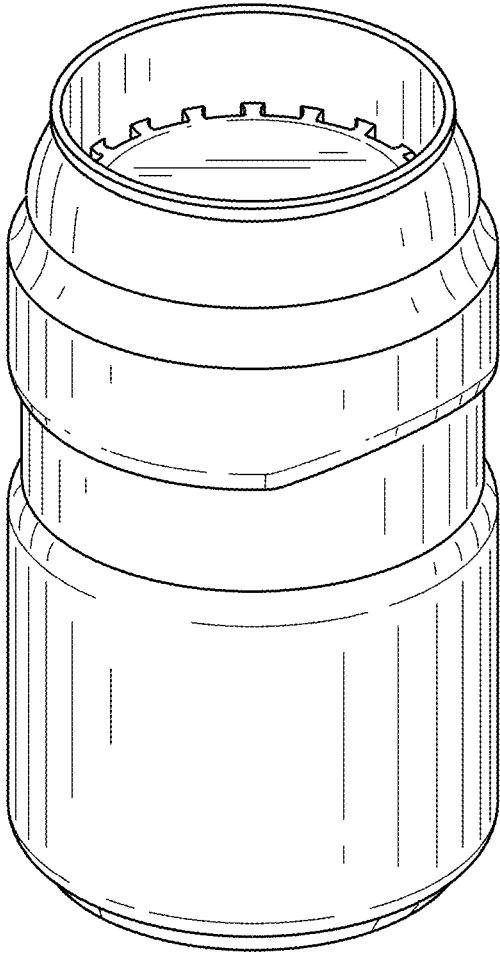

FIG. 1

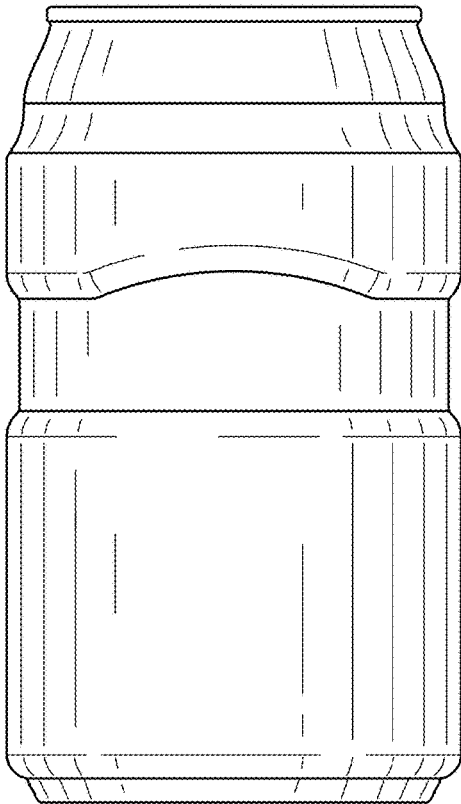

FIG. 2

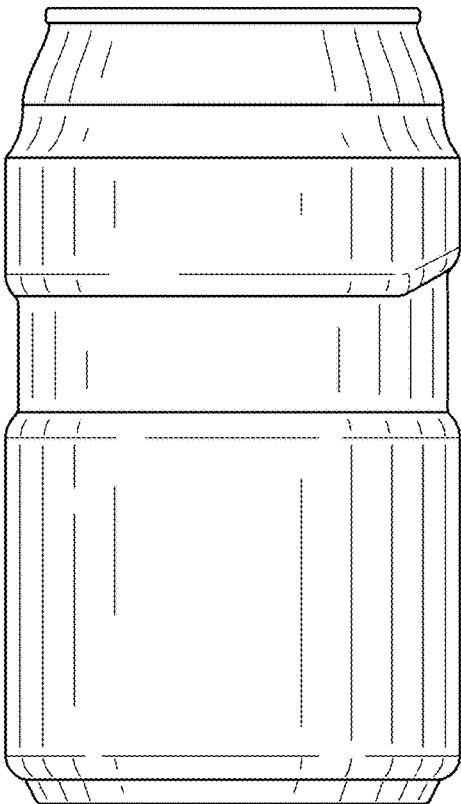

FIG. 3

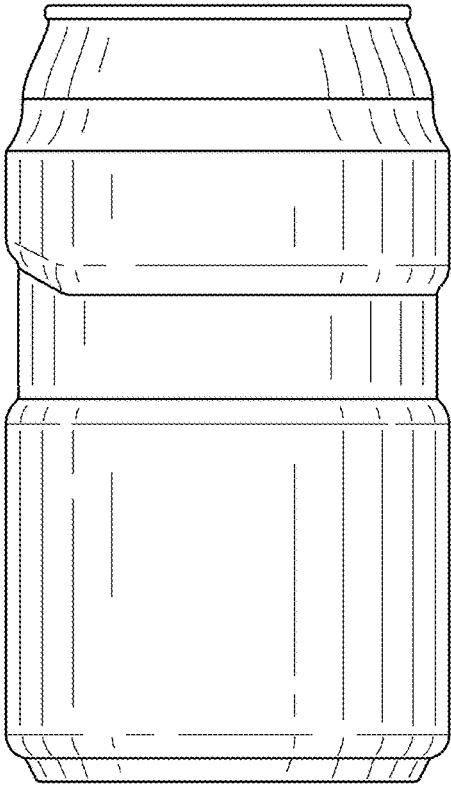

FIG. 4

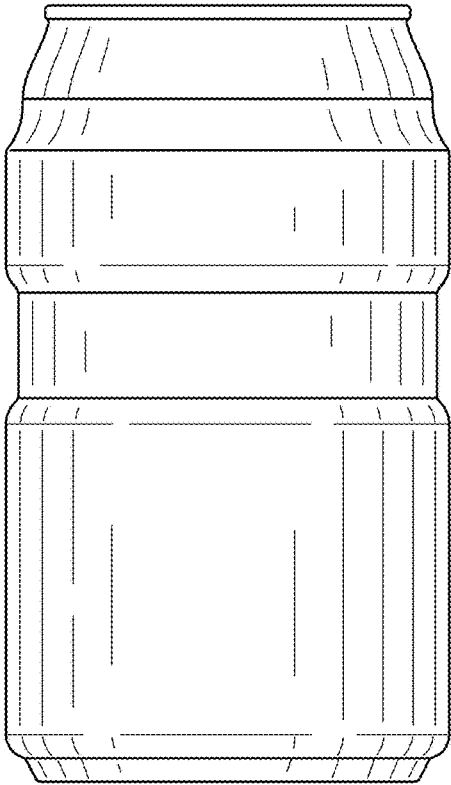

FIG. 5

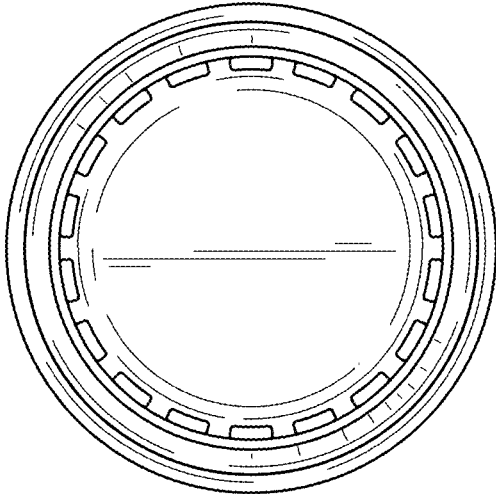

FIG. 6

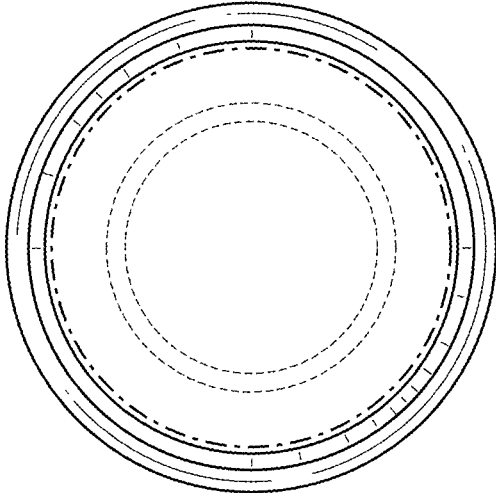

FIG. 7