

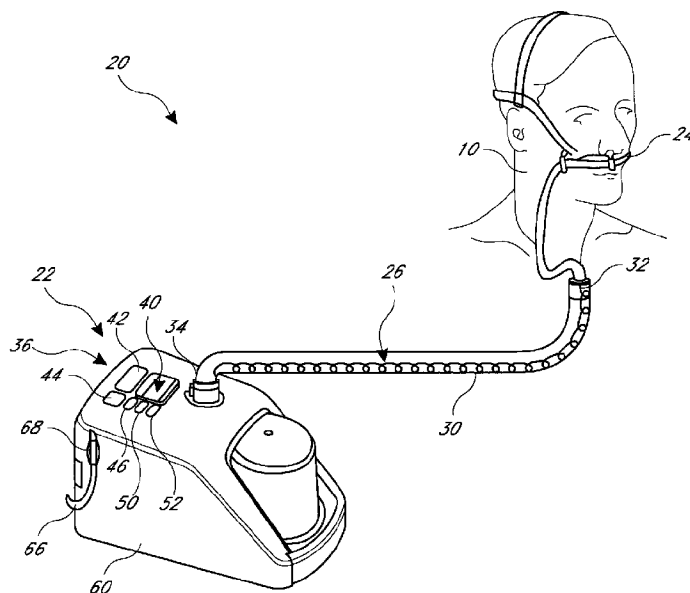

(86) Date de dépôt PCT/PCT Filing Date: 2013/04/05
 (87) Date publication PCT/PCT Publication Date: 2013/10/10
 (45) Date de délivrance/Issue Date: 2021/09/21
 (85) Entrée phase nationale/National Entry: 2014/09/30
 (86) N° demande PCT/PCT Application No.: NZ 2013/000060
 (87) N° publication PCT/PCT Publication No.: 2013/151448
 (30) Priorité/Priority: 2012/04/05 (US61/620,676)

(51) Cl.Int./Int.Cl. *A61M 16/16* (2006.01)
 (72) Inventeurs/Inventors:
 FRAME, SAMUEL ROBERTSON, NZ;
 CRONE, CHRISTOPHER MALCOLM, NZ;
 QUILL, CHRISTOPHER SIMON JAMES, NZ;
 O'DONNELL, KEVIN PETER, NZ;
 HSU, JACK CHE-WEI, NZ;
 HAN, JOHN, NZ
 (73) Propriétaire/Owner:
 FISHER & PAYKEL HEALTHCARE LIMITED, NZ
 (74) Agent: ROBIC

(54) Titre : APPAREIL D'ASSISTANCE RESPIRATOIRE PRESENTANT DES CARACTERISTIQUES D'APTITUDE A L'USAGE
 (54) Title: BREATHING ASSISTANCE APPARATUS WITH SERVICEABILITY FEATURES



(57) Abrégé/Abstract:

A breathing assistance apparatus is configured with features that improve serviceability of the apparatus. The apparatus can include animations to provide instruction regarding correcting easily-identified fault conditions and to provide instruction regarding routine maintenance routines. The apparatus also can be configured with top level control menus that are obscured in a manner to limit manipulation of the top level control elements by unauthorized users.

(12) INTERNATIONAL APPLICATION PUBLISHED UNDER THE PATENT COOPERATION TREATY (PCT)

(19) World Intellectual Property Organization
International Bureau

(43) International Publication Date
10 October 2013 (10.10.2013)



(10) International Publication Number
WO 2013/151448 A2

- (51) International Patent Classification:
A61M 16/16 (2006.01)
- (21) International Application Number:
PCT/NZ2013/000060
- (22) International Filing Date:
5 April 2013 (05.04.2013)
- (25) Filing Language:
English
- (26) Publication Language:
English
- (30) Priority Data:
61/620,676 5 April 2012 (05.04.2012) US
- (71) Applicant: FISHER & PAYKEL HEALTHCARE LIMITED [NZ/NZ]; 15 Maurice Paykel Place, East Tamaki, Auckland, 2013 (NZ).
- (72) Inventors: FRAME, Samuel Robertson; 27A Awanui Street, Merrilands, New Plymouth, 4360 (NZ). CRONE, Christopher Malcolm; 30 Kenyon Ave, Mount Eden, Auckland, 1024 (NZ). QUILL, Christopher Simon James; 195A Riverside Ave, Point England, Auckland, 1072 (NZ). O'DONNELL, Kevin Peter; 27 The Esplanade, Eastern Beach, Auckland, 2012 (NZ). HSU,

Jack Che-Wei; 30 Pigeon Mountain Road, Half Moon Bay, Manukau, 2012 (NZ). HAN, John; 3/18 Walmsley Road, St. Heliers, Auckland, 1071 (NZ).

(74) Agent: BALDWINS INTELLECTUAL PROPERTY; PO Box 852, Wellington, 6011 (NZ).

(81) Designated States (unless otherwise indicated, for every kind of national protection available): AE, AG, AL, AM, AO, AT, AU, AZ, BA, BB, BG, BH, BN, BR, BW, BY, BZ, CA, CH, CL, CN, CO, CR, CU, CZ, DE, DK, DM, DO, DZ, EC, EE, EG, ES, FI, GB, GD, GE, GH, GM, GT, HN, HR, HU, ID, IL, IN, IS, JP, KE, KG, KM, KN, KP, KR, KZ, LA, LC, LK, LR, LS, LT, LU, LY, MA, MD, ME, MG, MK, MN, MW, MX, MY, MZ, NA, NG, NI, NO, NZ, OM, PA, PE, PG, PH, PL, PT, QA, RO, RS, RU, RW, SC, SD, SE, SG, SK, SL, SM, ST, SV, SY, TH, TJ, TM, TN, TR, TT, TZ, UA, UG, US, UZ, VC, VN, ZA, ZM, ZW.

(84) Designated States (unless otherwise indicated, for every kind of regional protection available): ARIPO (BW, GH, GM, KE, LR, LS, MW, MZ, NA, RW, SD, SL, SZ, TZ, UG, ZM, ZW), Eurasian (AM, AZ, BY, KG, KZ, RU, TJ, TM), European (AL, AT, BE, BG, CH, CY, CZ, DE, DK, EE, ES, FI, FR, GB, GR, HR, HU, IE, IS, IT, LT, LU, LV,

[Continued on next page]

(54) Title: BREATHING ASSISTANCE APPARATUS WITH SERVICEABILITY FEATURES

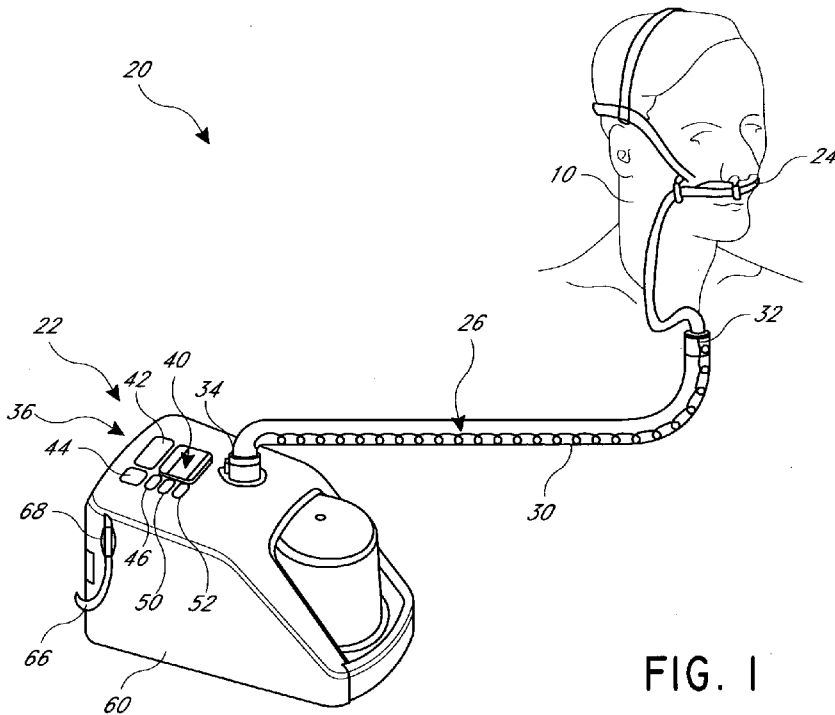

FIG. 1

(57) Abstract: A breathing assistance apparatus is configured with features that improve serviceability of the apparatus. The apparatus can include animations to provide instruction regarding correcting easily-identified fault conditions and to provide instruction regarding routine maintenance routines. The apparatus also can be configured with top level control menus that are obscured in a manner to limit manipulation of the top level control elements by unauthorized users.

WO 2013/151448 A2

WO 2013/151448 A2 

MC, MK, MT, NL, NO, PL, PT, RO, RS, SE, SI, SK, **Published:**
SM, TR), OAPI (BF, BJ, CF, CG, CI, CM, GA, GN, GQ, — *without international search report and to be republished*
GW, ML, MR, NE, SN, TD, TG). *upon receipt of that report (Rule 48.2(g))*

**BREATHING ASSISTANCE APPARATUS WITH SERVICEABILITY
FEATURES**

5 **[0001]** DELETED

BACKGROUND

10 Field

[0002] The present disclosure generally relates to a gases supply and gases humidification apparatus. More particularly, features, aspects and advantages of the present disclosure relate to such apparatuses that can coach a user regarding the correction of a fault condition.

15 Description of Related Art

[0003] A variety of machines can be used to assist with the breathing of a patient. Some of these machines are used among a plurality of users and are used almost continuously. Some of the machines are used by very few users and are used intermittently. These machines can deliver a heated and/or humidified flow of breathing
20 gases to the user.

[0004] The machines may be operated by individuals and trained health professionals. From time to time, the machine may experience a condition that requires correction. For example, a breathing conduit could become detached or a breathing conduit could become at least partially blocked. In most instances, such conditions
25 would be indicated by a numerical fault code. Such numerical fault codes would require the user or operator to consult a look-up table or call a technician. Often, this technique of correcting an easily corrected problem can be more time consuming than desired.

SUMMARY

[0005] Accordingly, a breathing apparatus comprises a flow generator; a humidifier chamber connected to the flow generator; wherein the apparatus is configured to be connected to a conduit; the conduit being for connection to a user breathing interface; the apparatus further comprising a display screen adapted to provide visual information to a user. The apparatus is configured to monitor one or more characteristics of use, and upon an occurrence of a triggering event to provide a series of image frames to the display, the series of image frames depicting an animated action configured to instruct a user to make an adjustment to the apparatus based upon the animated action to address the occurrence of the triggering event.

[0006] In one aspect, a breathing assistance apparatus is provided that includes a flow generator, a humidifier chamber connected to the flow generator, a conduit connected to the flow generator, a user breathing interface connected to the conduit, and a display screen adapted to provide visual information to a user. The apparatus can advantageously be configured to monitor one or more characteristics of use; and, upon an occurrence of a triggering event, to provide a series of image frames to the display. The series of image frames can depict an animated action that is configured to instruct a user to make an adjustment to the apparatus based upon the animated action to address the occurrence of the triggering event.

[0007] In some embodiments, the apparatus includes a button and depression of the button stops the display of the series of image frames. In some embodiments, the animated action includes a sequence that repeats until the triggering event is corrected.

[0008] In some embodiments, the triggering event comprises usage exceeding an upper limit of time. In a further embodiment, the animated action includes steps for replacing a filter.

[0009] In some embodiments, the triggering event comprises detection of at least one of a faulty heater wire, a faulty conduit temperature sensor, or a disconnected conduit. The animated action includes steps for replacing a breathing conduit.

[0010] In some embodiments, the triggering event comprises a reduction in resistance to flow. The animated action includes steps for reseating a chamber, reconnecting a conduit, or reconnecting an interface to the conduit.

[0011] In some embodiments, the triggering event comprises an increase in resistance to flow. The animated action includes steps for unbending a conduit, unclogging an interface, or checking that the correct interface is connected to the conduit.

[0012] In some embodiments, triggering event comprises detecting an oxygen
5 level outside of a desired oxygen level. The animated action includes steps for adjusting the oxygen supply.

[0013] In some embodiments, the triggering event comprises detecting a low water supply level. The animated action includes steps for replenishing the water supply.

[0014] In some embodiments, the triggering event comprises detecting a
10 presence of an oxygen supply during disinfection mode. The animated action includes steps for removing the oxygen supply. In a further embodiment, the apparatus is adapted to shut off power to a disinfection conduit heater until the triggering event is corrected.

[0015] In some embodiments, the triggering event comprises detecting
15 disconnection, depletion, or prolonged interruption of an oxygen supply. The animated action includes steps for reconnecting the oxygen supply.

[0016] In some embodiments, the triggering event comprises failing to detect a breathing pattern. The animated action includes steps for reattaching a user interface.

[0017] In some embodiments, the triggering event comprises a breathing rate
20 exceeding a predetermined breathing rate. The animated action includes illustrating the breathing rate.

[0018] In some embodiments, the triggering event comprises one of usage
exceeding an upper limit of time, detecting a faulty heater wire, detecting a faulty conduit temperature sensor, detecting a disconnected conduit, a reduction in resistance to flow, an increase in resistance to flow, detecting an oxygen level outside of a desired oxygen level,
25 detecting a low water supply level, detecting a presence of an oxygen supply during disinfection mode, detecting disconnection of an oxygen supply, detecting depletion or prolonged interruption of an oxygen supply, failing to detect a breathing

pattern, or a breathing rate exceeding a predetermined breathing rate; and the animated action comprises a sequence that repeats until the triggering event is corrected.

5 [0019] In another aspect, some embodiments provide for a breathing assistance apparatus that includes a flow generator; a humidifier chamber; wherein the apparatus is configured to be connected to a conduit; the conduit being for connection to a user breathing interface. The apparatus further comprising a controller electrically coupled to the apparatus; and a display screen electrically coupled to the controller and adapted to provide visual information to a user. The apparatus is configured to monitor one or more characteristics of use; detect an occurrence of a triggering event using the
10 controller, the detection of the triggering event being at least partly based on the monitored characteristics of use; select a series of image frames depicting an animated action; and provide the series of image frames to the display. The animated action is configured to instruct a user to make an adjustment to the apparatus based upon the animated action to address the occurrence of the triggering event by providing visual cues in the series of
15 image frames indicating a region of interest and at least one audible cue corresponding to an occurrence of an action in the series of image frames wherein the audible cue and the occurrence of the action are configured to be presented substantially simultaneously.

[0020] In some embodiments of the second aspect, the audible cue is configured to approximate a sound produced when the action occurs. In some
20 embodiments of the second aspect, the visual cues comprise flashing lights surrounding the region of interest.

[0021] In some embodiments of the second aspect, the series of image frames comprises a first subset of image frames depicting the apparatus with a first level of detail and a second subset of image frames depicting a second level of detail, the second level
25 of detail being greater than the first level of detail. In a further embodiment, the second subset of image frames presents a zoomed-in depiction of a portion of the apparatus that includes the region of interest.

[0022] In some embodiments, the one or more characteristics of use includes at least one of usage time, heater wire status, oxygen supply status, temperature sensor
30

status, conduit status, water level, flow rate, resistance to flow, oxygen level, breathing rate, gas temperature, or heater plate power.

[0023] In some embodiments, the apparatus includes a button and depression of the button stops the display of the series of image frames. In some embodiments, the
5 animated action includes a sequence that repeats until the triggering event is corrected.

[0024] In another aspect, a method of indicating an alarm on a breathing assistance apparatus is provided. The method can include detecting an occurrence of a triggering event using a controller of the apparatus. The method can include selecting an animated action corresponding to the detected occurrence of the triggering event. The
10 method can include displaying on a display of the apparatus a series of image frames depicting the animated action. The method can include detecting a correction of the triggering event using a controller of the apparatus. The method can include ending the display of the series of image frames upon detection of the correction of the triggering event. The series of image frames can advantageously be configured to instruct a user to
15 make an adjustment to the apparatus based upon the animated action to address the occurrence of the triggering event.

[0024a] In another aspect, a breathing assistance apparatus is provided, comprising a flow generator; a humidifier chamber connected to the flow generator; wherein the apparatus is configured to be connected to a conduit; the conduit being for
20 connection to a user breathing interface; the apparatus further comprising a display screen adapted to provide visual information to a user, wherein the apparatus is configured to monitor one or more characteristics of use, and upon an occurrence of a triggering event to provide a series of image frames to the display, the series of image frames depicting an animated action configured to instruct a user to make an adjustment to the apparatus based
25 upon the animated action to address the occurrence of the triggering event, wherein the breathing assistance apparatus is removably connectable to an oxygen supply, and wherein the triggering event comprises detecting a presence of a connected oxygen supply during disinfection mode.

[0024b] In another aspect, a breathing assistance apparatus is provided,
30 comprising a flow generator; a humidifier chamber; wherein the apparatus is configured to be connected to a conduit; the conduit being for connection to a user breathing interface;

the apparatus further comprising; a controller electrically coupled to the apparatus; and a display screen electrically coupled to the controller and adapted to provide visual information to a user, wherein the apparatus is configured to: monitor one or more characteristics of use; detect an occurrence of a triggering event using the controller, the
5 detection of the triggering event being at least partly based on the monitored characteristics of use; select a series of image frames depicting an animated action; and provide the series of image frames to the display, wherein the animated action is configured to instruct a user to make an adjustment to the apparatus based upon the animated action to address the occurrence of the triggering event by providing visual cues
10 in the series of image frames indicating a region of interest and at least one audible cue corresponding to an occurrence of an action in the series of image frames wherein the audible cue and the occurrence of the action are configured to be presented substantially simultaneously; wherein the breathing assistance apparatus is removably connectable to an oxygen supply, and wherein the triggering event comprises detecting a presence of a
15 connected oxygen supply during disinfection mode.

[0024c] In another aspect, a breathing assistance apparatus is provided, configured to deliver a heated and/or humidified flow of breathing gases to a user via a breathing interface and a conduit, the apparatus comprising a flow generator configured to connect to a humidifier chamber, and a display screen adapted to provide visual
20 information to a user, wherein the apparatus is configured to be operated in at least two modes, wherein one of the modes is a normal mode and another of the modes is a transport mode, the display screen being configured to a display a transport mode screen, when the apparatus is in transport mode, wherein the apparatus is configured to reduce or minimize power usage when in the transport mode as compared to the normal mode of operation.

[0024d] In another aspect, electronic method of controlling a breathing assistance apparatus is provided, the breathing assistance apparatus configured to connect to a conduit to provide a humidified flow of gas to a user via a user breathing interface, the electronic method comprising: monitoring one or more characteristics of use; detecting an occurrence of a triggering event, the detection of the triggering event being
25 at least partly based on the monitored characteristics of use; selecting a series of image frames depicting an animated action; providing the series of image frames to a display;
30

and transmitting at least one audible cue corresponding to an occurrence of an action in the series of image frames; wherein the animated action is configured to instruct a user to make an adjustment to the breathing assistance apparatus based upon the animated action to address the occurrence of the triggering event by providing visual cues in the series of image frames indicating a region of interest and wherein the audible cue and the occurrence of the animated action are configured to be presented substantially simultaneously.

5
[0024e] In another aspect, an electronic apparatus of controlling a breathing assistance apparatus is provided, the breathing assistance apparatus configured to connect to a conduit to provide a humidified flow of gas to a user via a user breathing interface, the electronic apparatus being configured to monitor one or more characteristics of use; detect an occurrence of a triggering event, the detection of the triggering event being at least partly based on the monitored characteristics of use; select a series of image frames depicting an animated action; provide the series of image frames to a display; and transmit at least one audible cue corresponding to an occurrence of an action in the series of image frames; wherein the animated action is configured to instruct a user to make an adjustment to the breathing assistance apparatus based upon the animated action to address the occurrence of the triggering event by providing visual cues in the series of image frames indicating a region of interest and wherein the audible cue and the occurrence of the animated action are configured to be presented substantially simultaneously.

15
[0024f] In another aspect, a breathing assistance apparatus is provided, comprising a flow generator; a humidifier chamber connected to the flow generator; a conduit connected to the flow generator; a user breathing interface connected to the conduit; and a display screen adapted to provide visual information to a user, wherein the apparatus is configured to monitor one or more characteristics of use, and upon an occurrence of a triggering event to provide a series of image frames to the display, the series of image frames depicting an animated action configured to instruct a user to make an adjustment to the apparatus based upon the animated action to address the occurrence of the triggering event.

20
[0024g] In another aspect, a breathing assistance apparatus is provided, comprising a flow generator; a humidifier chamber coupled to the flow generator; a

conduit coupled to the flow generator; a user breathing interface connected to the conduit; a controller electrically coupled to the apparatus; and a display screen electrically coupled to the controller and adapted to provide visual information to a user, wherein the apparatus is configured to monitor one or more characteristics of use; detect an occurrence of a triggering event using the controller, the detection of the triggering event being at least partly based on the monitored characteristics of use; select a series of image frames depicting an animated action; and provide the series of image frames to the display, wherein the animated action is configured to instruct a user to make an adjustment to the apparatus based upon the animated action to address the occurrence of the triggering event by providing visual cues in the series of image frames indicating a region of interest and at least one audible cue corresponding to an occurrence of an action in the series of image frames wherein the audible cue and the occurrence of the action are configured to be presented substantially simultaneously.

[0024h] In another aspect, an electronic method of controlling a breathing assistance apparatus is provided, comprising a flow generator; a humidifier chamber connected to the flow generator; conduit connected to the flow generator; a user breathing interface connected to the conduit; and a display screen adapted to provide visual information to a user, wherein the electronic method comprises monitoring one or more characteristics of use, and upon an occurrence of a triggering event providing a series of image frames to the display, the series of image frames depicting an animated action configured to instruct a user to make an adjustment to the apparatus based upon the animated action to address the occurrence of the triggering event.

[0024i] In another aspect, a breathing assistance apparatus is provided, comprising a flow generator configured to generate a flow of gas and connect with a humidifier chamber; a display screen adapted to display visual information to a user; and a controller configured to: monitor one or more characteristics of use; detect a presence of an oxygen supply during a disinfection mode based on the monitoring; and generate a plurality of image frames for the display based on the detection of the presence of the oxygen supply during disinfection mode, the plurality of image frames depicting an animated action configured to instruct a user to make an adjustment to the apparatus.

[0024j] In another aspect, a method of indicating an alarm on a breathing assistance apparatus is provided, including: detecting an occurrence of a triggering event using a controller of the apparatus, selecting an animated action corresponding to the detected occurrence of the triggering event, displaying on a display of the apparatus a series of image frames depicting the animated action, detecting a correction of the triggering event using a controller of the apparatus, ending the display of the series of image frames upon detection of the correction of the triggering event, wherein the series of image frames can be configured to instruct a user to make an adjustment to the apparatus based upon the animated action to address the occurrence of the triggering event.

[0024k] In another aspect, a method of indicating an alarm on a breathing assistance apparatus is provided, including: detecting a triggering event using a controller of the apparatus, selecting an animated action corresponding to the detected triggering event, displaying on a display of the apparatus a series of image frames depicting the animated action, emitting an audible noise with a speaker of the apparatus, detecting a correction of the triggering event using a controller of the apparatus, ending the display of the series of image frames and the emission of the audible noise upon detection of the correction of the triggering event, wherein the series of image frames can be configured to instruct a user to make an adjustment to the apparatus based upon the animated action to address the triggering event by providing visual cues in the series of image frames indicating a region of interest and at least one audible cue corresponding to an occurrence of an action in the series of image frames, and wherein the audible cue and the occurrence of the action can be configured to be presented substantially simultaneously.

[0024l] In another aspect, a breathing assistance apparatus is provided, comprising a flow generator, a humidifier chamber fluidly connected to the flow generator, a display screen adapted to provide visual information to a user, a gases outlet in fluid communication with humidifier chamber, a gases flow path formed between the flow generator and the gases outlet via the humidifier chamber, a conduit removably connectable to the gases outlet, a controller configured to detect if the conduit is incorrectly connected, wherein if the conduit is connected incorrectly, the controller is configured to display an image or icon of the conduit, the displayed image or icon of the

conduit being displayed as flashing red or having a colored outline or glowing in a pulsating fashion or having an arrow pointing to the conduit, and display instructions to and/or provide audible instructions to communicate a corrective action.

[0024m] A breathing assistance apparatus is provided, comprising a housing, a
5 flow generator provided in the housing, a heater plate located on or in the housing, a humidifier chamber fluidly coupled to the flow generator and removably positionable on the heater plate, a display screen on the housing, the display screen adapted to provide visual information to a user, a gases outlet in fluid communication with the humidifier chamber and a gas path formed between the flow generator and the gases outlet via the
10 humidifier chamber, wherein the display screen comprises an LED screen, the display screen is a full color display, the display screen comprises a pixel count between 6000 pixels and 500,000 pixels, or the display screen comprises a screen size of 128 pixel by 160 pixel or 1.8 inches to 4 inches diagonally.

[0024n] In another aspect, a breathing assistance apparatus is provided,
15 comprising a housing, a flow generator, a humidifier, wherein the flow generator and humidifier are located within the housing and pneumatically coupled to each other, a display on the housing, a series of images depicting one or more animated actions being presented on the display along with a series of audible cues, wherein the apparatus is configured to emit audible cues that simulate or approximate the sound a user would hear
20 when performing one or more animated actions illustrated on the display, and wherein the timing of the emitted sound corresponds to the timing of the animated action such that the time when the animated action displays the action that produces the sound, the apparatus is configured to emit the corresponding audible cue.

[0024o] In another aspect, A breathing assistance apparatus is provided,
25 comprising a flow generator, a humidifier in fluid communication with the flow generator, and configured to receive gases flow from the flow generator to humidify gases, a user interface, a controller in electronic communication with the flow generator and the humidifier and configured to control operation of each of them, the controller being in electronic communication with the user interface, wherein the apparatus is operable in a
30 plurality of operating modes, and wherein one of the plurality of operating modes is

selected by a user via the user interface or the apparatus automatically selects one of the plurality of operating modes as the default mode.

[0025] In another aspect, a method of indicating an alarm on a breathing assistance apparatus is provided. The method can include detecting a triggering event
5 using a controller of the apparatus. The method can include selecting an animated action corresponding to the detected triggering event. The method can include displaying on a display of the apparatus a series of image frames depicting the animated action. The method can include emitting an audible noise with a speaker of the apparatus. The method can include detecting a correction of the triggering event using a controller of the
10 apparatus. The method can include ending the display of the series of image frames and the emission of the audible noise upon detection of the correction of the triggering event. The series of image frames can advantageously be configured to instruct a user to make an adjustment to the apparatus based upon the animated action to address the triggering event by providing visual cues in the series of image frames indicating a region of interest
15 and at least one audible cue corresponding to an occurrence of an

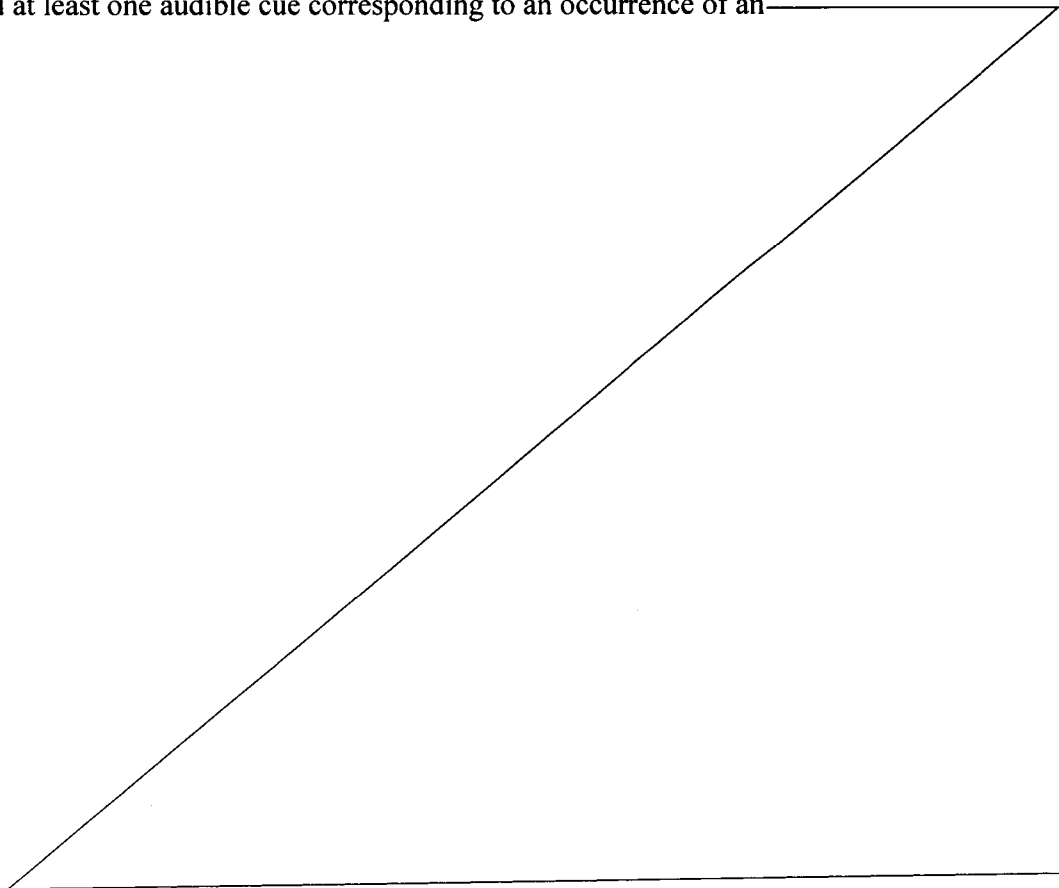

action in the series of image frames. The audible cue and the occurrence of the action can advantageously be configured to be presented substantially simultaneously.

[0026] In some embodiments of the fourth aspect, the audible cue is configured to approximate a sound produced when the action occurs. In some
5 embodiments of the fourth aspect, the visual cues comprise flashing lights surrounding the region of interest.

[0027] In some embodiments of the fourth aspect, the series of image frames comprises a first subset of image frames depicting the apparatus with a first level of detail and a second subset of image frames depicting a second level of detail, the second
10 level of detail being greater than the first level of detail. In a further embodiment, the second subset of image frames presents a zoomed-in depiction of a portion of the apparatus that includes the region of interest.

[0028] In some embodiments of the fourth aspect, the method can include monitoring one or more characteristics of use. In a further embodiment, the one or more
15 characteristics of use includes at least one of usage time, heater wire status, oxygen supply status, temperature sensor status, conduit status, water level, flow rate, resistance to flow, oxygen level, breathing rate, gas temperature, or heater plate power.

[0028a] In another aspect, some embodiments provide for a breathing assistance apparatus configured to deliver a heated and/or humidified flow of breathing
20 gases to a user via a breathing interface and a conduit. The apparatus comprising a flow generator configured to connect to a humidifier chamber and a display screen adapted to provide visual information to a user. The apparatus is configured to be operated in at least two modes, wherein one of the modes is a normal mode and another of the modes is a transport mode, the display screen being configured to a display a transport mode
25 screen, when the apparatus is in transport mode, wherein the apparatus is configured to reduce or minimize power usage when in the transport mode as compared to the normal mode of operation.

[0028b] In yet another aspect, some embodiments provide for a breathing assistance apparatus configured to deliver a heated and/or humidified flow of breathing
30 gases to a user via a breathing interface and a conduit. The apparatus comprising a user

interface enabling interaction between the user and the apparatus. The apparatus comprises an inlet to the flow generator configured to connect to an oxygen supply, the user interface being configured to allow the user to indicate the oxygen concentration of oxygen that is supplied from the oxygen supply.

5 **[0029]** In summary, the disclosure may be described according to the following numbered clauses:

[0030] Clause 1. A breathing assistance apparatus comprising: a flow generator; a humidifier chamber connected to the flow generator; a conduit connected to the flow generator; a user breathing interface connected to the conduit; and a display
10 screen adapted to provide visual information to a user, wherein the apparatus is configured to monitor one or more characteristics of use, and upon an occurrence of a triggering event to provide a series of image frames to the display, the series of image frames depicting an animated action configured to instruct a user to make an adjustment to the apparatus based upon the animated action to address the occurrence of the
15 triggering event.

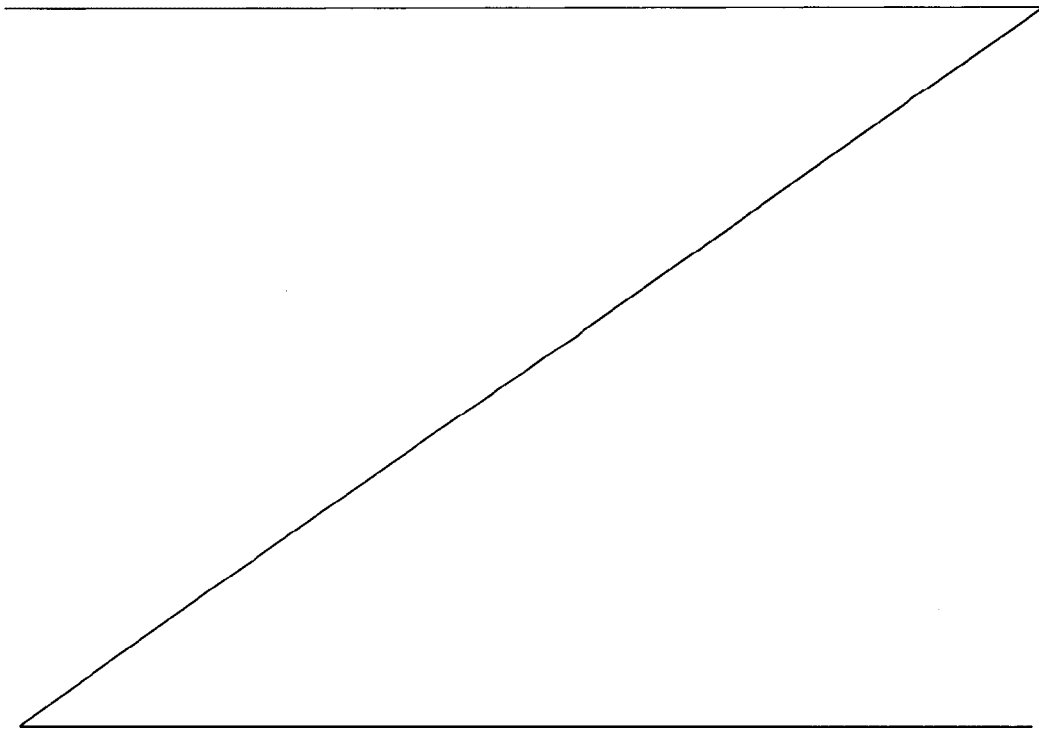

[0031] Clause 2. The apparatus of Clause 1, further comprising a button and depression of the button stops the display of the series of image frames.

[0032] Clause 3. The apparatus of Clause 1, wherein the triggering event comprises usage exceeding an upper limit of time.

5 [0033] Clause 4. The apparatus of Clause 3, wherein the animated action comprises steps for replacing a filter.

[0034] Clause 5. The apparatus of Clause 1, wherein the triggering event comprises detection of at least one of a faulty heater wire, a faulty conduit temperature sensor, or a disconnected conduit.

10 [0035] Clause 6. The apparatus of Clause 5, wherein the animated action comprises steps for replacing a breathing conduit.

[0036] Clause 7. The apparatus of Clause 1, wherein the triggering event comprises a reduction in resistance to flow.

[0037] Clause 8. The apparatus of Clause 7, wherein the animated action
15 comprises steps for reseating a chamber, reconnecting a conduit or reconnecting an interface to the conduit.

[0038] Clause 9. The apparatus of Clause 1, wherein the triggering event comprises an increase in resistance to flow.

[0039] Clause 10. The apparatus of Clause 9, wherein the animated action
20 comprises steps for unbending a conduit, unclogging an interface or checking that the correct interface is connected to the conduit.

[0040] Clause 11. The apparatus of Clause 1, wherein the triggering event comprises detecting an oxygen level outside of a desired oxygen level.

[0041] Clause 12. The apparatus of Clause 11, wherein the animated action
25 comprises steps for adjusting the oxygen supply.

[0042] Clause 13. The apparatus of Clause 1, wherein the triggering event comprises detecting a low water supply level.

[0043] Clause 14. The apparatus of Clause 13, wherein the animated action comprises steps for replenishing the water supply.

[0044] Clause 15. The apparatus of Clause 1, wherein the triggering event comprises detecting a presence of an oxygen supply during disinfection mode.

[0045] Clause 16. The apparatus of Clause 15, wherein the animated action comprises steps for removing the oxygen supply.

5 [0046] Clause 17. The apparatus of Clause 16, wherein the apparatus also shuts off power to a disinfection conduit heater until the triggering event is corrected.

[0047] Clause 18. The apparatus of Clause 1, wherein the triggering event comprises detecting disconnection, depletion or prolonged interruption of an oxygen supply.

10 [0048] Clause 19. The apparatus of Clause 18, wherein the animated action comprises steps for reconnecting the oxygen supply.

[0049] Clause 20. The apparatus of Clause 1, wherein the triggering event comprises failing to detect a breathing pattern.

15 [0050] Clause 21. The apparatus of Clause 20, wherein the animated action comprises steps for reattaching a user interface.

[0051] Clause 22. The apparatus of Clause 1, wherein the triggering event comprises a breathing rate exceeding a predetermined breathing rate.

[0052] Clause 23. The apparatus of Clause 22, wherein the animated action comprises illustrating the breathing rate.

20 [0053] Clause 24. The apparatus of any of Clauses 3-23, wherein the animated action comprises a sequence that repeats until the triggering event is corrected.

[0054] Clause 24. The apparatus of Clause 1, wherein the triggering event comprises one of usage exceeding an upper limit of time, detecting a faulty heater wire, detecting a faulty conduit temperature sensor, detecting a disconnected conduit, a
25 reduction in resistance to flow, an increase in resistance to flow, detecting an oxygen level outside of a desired oxygen level, detecting a low water supply level, detecting a presence of an oxygen supply during disinfection mode, detecting disconnection of an oxygen supply, detecting depletion or prolonged interruption of an oxygen supply, failing to detect a breathing pattern, or a breathing rate exceeding a predetermined

breathing rate; and the animated action comprises a sequence that repeats until the triggering event is corrected.

[0055] Clause 25. A breathing assistance apparatus comprising: a flow generator; a humidifier chamber coupled to the flow generator; a conduit coupled to the flow generator; a user breathing interface connected to the conduit; a controller electrically coupled to the apparatus; and a display screen electrically coupled to the controller and adapted to provide visual information to a user, wherein the apparatus is configured to: monitor one or more characteristics of use; detect an occurrence of a triggering event using the controller, the detection of the triggering event being at least partly based on the monitored characteristics of use; select a series of image frames depicting an animated action; and provide the series of image frames to the display, wherein the animated action is configured to instruct a user to make an adjustment to the apparatus based upon the animated action to address the occurrence of the triggering event by providing visual cues in the series of image frames indicating a region of interest and at least one audible cue corresponding to an occurrence of an action in the series of image frames wherein the audible cue and the occurrence of the action are configured to be presented substantially simultaneously.

[0056] Clause 26. The apparatus of Clause 25, wherein the audible cue is configured to approximate a sound produced when the action occurs.

[0057] Clause 27. The apparatus of Clause 25, wherein the visual cues comprise flashing lights surrounding the region of interest.

[0058] Clause 28. The apparatus of Clause 25, wherein the series of image frames comprises a first subset of image frames depicting the apparatus with a first level of detail and a second subset of image frames depicting a second level of detail, the second level of detail being greater than the first level of detail.

[0059] Clause 29. The apparatus of Clause 28, wherein the second subset of image frames presents a zoomed-in depiction of a portion of the apparatus that includes the region of interest.

[0060] Clause 30. The apparatus of Clause 25, wherein the one or more characteristics of use includes at least one of usage time, heater wire status, oxygen

supply status, temperature sensor status, conduit status, water level, flow rate, resistance to flow, oxygen level, breathing rate, gas temperature, or heater plate power.

[0061] Clause 31. The apparatus of Clause 25, wherein the triggering event comprises one of usage exceeding an upper limit of time, detecting a faulty heater wire,
5 detecting a faulty conduit temperature sensor, detecting a disconnected conduit, a reduction in resistance to flow, an increase in resistance to flow, detecting an oxygen level outside of a desired oxygen level, detecting a low water supply level, detecting a presence of an oxygen supply during disinfection mode, detecting disconnection of an oxygen supply, detecting depletion or prolonged interruption of an oxygen supply,
10 failing to detect a breathing pattern, or a breathing rate exceeding a predetermined breathing rate; and the animated action comprises a sequence that repeats until the triggering event is corrected.

[0062] Clause 32. The apparatus of Clause 31, wherein the animated action comprises steps for replacing a filter.

15 [0063] Clause 33. The apparatus of Clause 31, wherein the animated action comprises steps for replacing a breathing conduit.

[0064] Clause 34. The apparatus of Clause 31, wherein the animated action comprises steps for reseating a chamber, reconnecting a conduit or reconnecting an interface to the conduit.

20 [0065] Clause 35. The apparatus of Clause 31, wherein the animated action comprises steps for unbending a conduit, unclogging an interface or checking that the correct interface is connected to the conduit.

[0066] Clause 36. The apparatus of Clause 31, wherein the animated action comprises steps for adjusting the oxygen supply.

25 [0067] Clause 37. The apparatus of Clause 31, wherein the animated action comprises steps for replenishing the water supply.

[0068] Clause 38. The apparatus of Clause 31, wherein the animated action comprises steps for removing the oxygen supply.

30 [0069] Clause 39. The apparatus of Clause 38, wherein the apparatus also shuts off power to a disinfection conduit heater until the triggering event is corrected.

[0070] Clause 40. The apparatus of Clause 31, wherein the animated action comprises steps for reconnecting the oxygen supply.

[0071] Clause 41. The apparatus of Clause 31, wherein the animated action comprises steps for reattaching a user interface.

5 [0072] Clause 42. The apparatus of Clause 31, wherein the animated action comprises illustrating the breathing rate.

[0073] Clause 43. A method of indicating an alarm on a breathing assistance apparatus, the method comprising: detecting an occurrence of a triggering event using a controller of the apparatus; selecting an animated action corresponding to the detected
10 occurrence of the triggering event; displaying on a display of the apparatus a series of image frames depicting the animated action; detecting a correction of the triggering event using a controller of the apparatus; and ending the display of the animated action upon detection of the correction of the triggering event, wherein the series of image frames are configured to instruct a user to make an adjustment to the apparatus based
15 upon the animated action to address the occurrence of the triggering event.

[0074] Clause 44. A method of indicating an alarm on a breathing assistance apparatus, the method comprising: detecting a triggering event using a controller of the apparatus; selecting an animated action corresponding to the detected triggering event; displaying on a display of the apparatus a series of image frames depicting the animated
20 action; emitting an audible noise with a speaker of the apparatus; detecting a correction of the triggering event using a controller of the apparatus; and ending the display of the animated action and the emission of the audible noise upon detection of the correction of the triggering event, wherein the animated action is configured to instruct a user to make an adjustment to the apparatus based upon the animated action to address the triggering
25 event by providing visual cues in the series of image frames indicating a region of interest and at least one audible cue corresponding to an occurrence of an action in the series of image frames wherein the audible cue and the occurrence of the action are configured to be presented substantially simultaneously.

BRIEF DESCRIPTION OF THE DRAWINGS

[0075] These and other features, aspects, and advantages will now be described with reference to the drawings of some embodiments, which embodiments are intended to illustrate and not to limit the scope of the disclosure, and in which figures:

5 [0076] Figure 1 is a perspective view of an apparatus that provides a humidified and heated flow of fluid to a user or patient.

[0077] Figure 2 is a rear perspective view of a portion of the apparatus of Figure 1.

[0078] Figure 3 is a front perspective view of the portion of Figure 2.

10 [0079] Figure 4 is a front perspective view of the portion of Figure 2 awaiting connection of a disinfection conduit for a disinfection mode.

[0080] Figure 5 illustrates the portion of Figure 4 with the disinfection conduit connected.

15 [0081] Figures 6A-6D illustrates a display flow for the apparatus in a primary mode.

[0082] Figure 7 illustrates a disinfection mode display flow for the apparatus.

[0083] Figures 8A-8D illustrate a series of images used in an animation showing how to replace a filter of the apparatus.

20 [0084] Figures 9A-9C illustrate another display flow for the apparatus in a secondary mode.

[0085] Figure 10 illustrates a fault condition correction display flow for the apparatus.

[0086] Figure 11 illustrates a series of images used in an animation showing how to connect a breathing circuit of the apparatus.

25 [0087] Figures 12A-12M illustrate a series of images used in an example animation showing a chamber installation sequence.

DETAILED DESCRIPTION

30 [0088] Figure 1 illustrates an apparatus 20 that provides a humidified and heated flow of fluid to a user or patient 10. The illustrated apparatus 20 comprises a

high-flow breathing assistance apparatus; however, features, aspects, and advantages of some embodiments can be used with other types of apparatus used to supply a humidified and/or heated flow of fluid (e.g., gases or air) to the user or patient 10. For example, features, aspects, and advantages of some embodiments can be used with
5 CPAP machines, insufflation humidifiers for laparoscopic or other surgical procedures, respiratory humidifiers, humidifiers for noninvasive ventilation applications, humidifiers for invasive ventilation applications, infant resuscitation devices, and the like. The apparatus can be configured as disclosed in U.S. Patent Publication No. 2008-0310994, filed on June 13, 2008, U.S. Patent Publication No. 2008-0196722, filed on June 29,
10 2006, and/or U.S. Patent Publication No. 2003-0066526, filed on September 18, 2002.

[0089] In some embodiments, the apparatus 20 can include a display 40 configured to display a series of images in succession that illustrate an animated action. The animated action can be used to instruct a user on how to perform a particular action. The series of images can be displayed in response to a triggering event and the animated
15 action can be configured to present one or more methods of responding to the triggering event. The apparatus 20 can be configured to detect various triggering events and to automatically display a corresponding series of images. For example, the apparatus 20 can be configured to detect when a chamber is not correctly installed (e.g., the triggering event). In response, the apparatus 20 can display a series of images identifying the
20 location of the problem, the element of the apparatus that triggered the event, and a method of correcting the problem (e.g., the animated action).

[0090] In some embodiments, the series of images displayed on the display 40 can include flashing lights, coloring, shading, or other similar visual cues to indicate the element or location of the triggering event. For example, if a conduit is not properly
25 connected, the conduit can be displayed as flashing red, having a colored outline, glowing in a pulsating fashion, having an arrow pointing to the conduit, or the like. The animated action can display a method of properly connecting the conduit, after which the conduit can be displayed as flashing green, having a different colored outline, glowing in a relatively constant fashion, or the like to indicate a change from an incorrect to a

correct configuration. In some embodiments, no words are used such that the visual images can communicate corrective actions to any user independent of language or technical background. In some embodiments, a user can choose to display written instructions and/or provide audible instructions in addition to the visual images.

5 However, these written and/or audible instructions are not generally necessary because the visual images provide universal visual instructions as described herein below.

[0091] In some embodiments, the apparatus 20 can be configured to provide audible cues that correspond to the series of images presented on the display 40. For example, when an element of the apparatus 20 is illustrated as being “clicked” into

10 place, the apparatus can emit a sound indicating that a corresponding sound should be heard when the user performs the action being illustrated. In some embodiments, the audible cue can be configured to approximate or simulate the sound a user would hear when performing the animated action. In some embodiments, the timing of the emitted sound corresponds to the timing of the animated action, such that at the time when the

15 animated action displays the action that produces a sound, the apparatus can emit the corresponding audible cue.

[0092] With continued reference to Figure 1, the apparatus 20 comprises a flow generating apparatus 22. The illustrated flow generating apparatus 22 can be connected to a patient interface 24 with a flexible conduit 26. The patient interface 24

20 can be any suitable patient interface. For example, but without limitation, the patient interface 24 can comprise noninvasive interfaces including, but not limited to, adult nasal cannula, infant nasal cannula, full face masks, combination oral/nasal masks, nasal masks, nasal pillows, high flow cannula, or the like. In some configurations, the patient interface 24 can comprise invasive or minimally invasive interfaces including, but not

25 limited to, endotracheal tubes, insufflation devices, or the like. In some configurations, adaptors and connectors can be provided for coupling to tracheotomy devices and masks.

[0093] In the illustrated configuration, the flexible conduit 26 can comprise a heating element 30 and a sensing element 32. In some configurations, the sensing

30 element 32 can be positioned at an end portion of the flexible conduit 26 closest to the

patient interface 24. In some configurations, the sensing element 32 is positioned within the lumen defined by the flexible conduit 26 such that the sensing element 32 is exposed to the fluid being carried within the lumen. The sensing element 32 can sense a characteristic or attribute of the fluid being carried within the lumen. In some configurations, the sensing element 32 is arranged and configured to sense the temperature of the fluid passing through the lumen. In some configurations, the heating element 30 and the sensing element 32 can be arranged as described in co-pending U.S. Patent Publication No. 2010-0218763, published on September 2, 2010.

[0094] The end of the flexible conduit 26 closest to the flow generating apparatus 22 comprises a connector 34. The connector 34 can be configured to establish both a pneumatic connection between the flow generating apparatus 22 and the lumen of the flexible conduit 26 and an electrical connection between at least the heating element 30 of the flexible conduit 26 and the flow generating apparatus 22. In some configurations, the connector 34 facilitates establishing both the pneumatic connection and the electrical connection in a single step. In some configurations, the connector 34 can be configured as disclosed in U.S. Patent No. 6,953,354, issued on October 11, 2005 and entitled "Connector for Breathing Circuits".

[0095] With continued reference to Figure 1, the flow generating apparatus 22 comprises a user control interface 36. The user control interface 36 enables interaction between the user, patient 10, or another person (e.g., without limitation, health professionals, distributors, or the like) and the flow generating apparatus 22. The illustrated user control interface 36 comprises a display screen 40. The display screen 40 can be any suitable display screen. In some configurations, the display screen 40 comprises an organic light-emitting diode (OLED) screen. In some configurations, the display screen 40 can comprise a full color display with a pixel count of between about 6,000 pixels and about 500,000 pixels. In some configurations, the display screen 40 can comprise a pixel count of about 20,480 pixels. In some configurations, the display screen can comprise a screen size of about 128 pixels by about 160 pixels (vertical by

30

horizontal). In some configurations, the display screen can be about 1.8 inches diagonally to about 4 inches diagonally. To reduce heat transferred from the screen to other components of the apparatus 22, the screen can be run with a black screen (e.g., most of the pixels are inactive during operation of the apparatus 22).

5 **[0096]** The illustrated user interface 36 comprises five different keys: a power key/button 42, a mute key/button 44, an up arrow key/button 46, a down arrow key/button 50 and a mode key/button 52. In some configurations, the user interface 36 can include some combination of mechanical keys, electro-mechanical keys, and touch-sensitive capabilities such as where the display 40 comprises a touch-screen and
10 navigation through a menu structure or other suitable manner of device operation can be provided via the display 40. In some configurations, a joystick, a toggle, or the like can be provided for navigation through a menu structure or other suitable manner of device operation.

[0097] With reference to Figure 2, the illustrated flow generating apparatus
15 22 comprises an outer housing 60. The outer housing 60 contains a flow generator (not shown). The flow generator can be any suitable component or components for generating a source of pressurized air, which generates a flow of gases through the conduit 26. As shown in Figure 2, the housing 60 can define an inlet to the flow generator, which inlet is covered with a filter cover 62. The filter cover 62 can contain a
20 replaceable filter element 64 that overlies the inlet to the flow generator such that it filters a flow of air that passes into the housing through openings in the filter cover 62.

[0098] With continued reference to Figure 2, a first end of an oxygen supply conduit 66 can be connected to the filter cover 62. A second end of the oxygen supply conduit 66 can have a fitting 68 used to connect to a supply conduit from a wall supply
25 or the like, as shown in Figure 1. Returning to Figure 2, the filter cover 62 or a region contained between the filter cover and the flow generator can define a mixing region for ambient air and the oxygen supplied through the conduit 66.

[0099] With reference to Figure 3, flow from the flow generator (not shown) passes into and through a chamber 70. An outlet port 72 (see Figure 4) from the flow
30 generator connects to an inlet port (not shown) of the chamber 70. A water supply can

be contained within the chamber 70 such that the flow passes over the surface of the water supply to be humidified. An outlet port of the chamber 70 connects to an inlet end 74 of an elbow 76. The elbow has an outlet end 78 that connects to the conduit 26 as described above.

5 **[0100]** The chamber 70 rests atop a heater plate 80 (see Figure 4) or other suitable heating element. The heater plate 80 can be controlled by the apparatus 22 such that the water contained within the chamber 70 can be heated to a suitable level. The water contained within the chamber 70 can be replenished from a feed set and water bag configuration, if desired.

10 **[0101]** In some configurations, the apparatus 22 can comprise one or more temperature sensors that are positioned downstream of the humidification chamber 70. In some configurations, two temperature sensors can be positioned within the elbow 76. Output from the temperature sensor in the elbow 76 and information regarding the heater plate duty cycle can be used in connection with an algorithm to detect the humidity. A
15 system can be used such as that disclosed in WO2009/145646, filed on May 27, 2009 and published on December 3, 2009.

[0102] The apparatus 22 also can comprise an airflow sensor that is positioned upstream of the flow generator as well as a temperature sensor that is positioned upstream of the humidification chamber 70. In some configurations, the
20 temperature sensor is positioned upstream of the flow generator as well. In some configurations, an oxygen sensor also can be positioned upstream of the humidification chamber or the flow generator. In some configurations, an ultrasound principle can be used to detect the oxygen content in the air based upon the detected humidity level can improve the detection of oxygen content.

25 **[0103]** The apparatus 22 also comprises a suitable controller, which includes memory and other components used for sensing various characteristics of flows and

30

operation of the apparatus. Moreover, the apparatus 22 can comprise a speaker or other audible alert generator.

[0104] With reference to Figure 5, in order to disinfect the apparatus 22 between users, for example, a disinfection conduit 82 can be connected to the outlet 72 from the flow generator and to the outlet 78 of the elbow 76. The disinfection conduit 82 can include a heater coil 84 that is electrically connected to the electrical connection with a connector that is similar to, or the same as, the connector 34 described above. A filter cap 86 can be positioned over the inlet end 74 of the elbow 76.

10 Start-Up Operation

[0105] With reference now to Figures 6A-6D, control and operation of some features, aspects, and advantages of the illustrated apparatus 20 will be described. As will be described, the illustrated apparatus 20 can be operated in at least two main modes. In the illustrated configuration, the apparatus 20 has a primary mode that can be used in multiple-user applications and a secondary mode that can be used in single-user applications, for example but without limitation. In some configurations, the apparatus 20 can be used in the primary mode with multiple users and under generally continuous use conditions and in the secondary mode with a small number of users and under intermittent use. In other words, the apparatus 20 can be used in the primary mode in a setting such as a hospital or other healthcare facility and the same apparatus 20 can be used in the secondary mode in a setting such as a home. Such a configuration is advantageous in that a smaller number of machines need to be stocked for supply by distributors because of the ability to customize the machine to the end user.

[0106] In the description below, either the primary mode or the secondary mode may be referred to as the default mode but the apparatus 22 need not default to this mode at start up. In some configurations, the apparatus 20 comprises a disinfection mode for use between users. In some configurations, the apparatus 20 also can comprise a youth sub-mode that can be configured for use with younger users. In some configurations, the apparatus 20 can comprise a youth sub-mode for each of the primary mode and the secondary mode, which youth sub-modes can be configured for use with

younger users. In some configurations, at least one of the primary mode and the secondary mode can include a conduit drying sub-mode, breathing pattern feedback sub-mode, a night-use sub-mode, and/or a transport mode. In some configurations, the secondary mode can include one or more of the conduit drying sub-mode and the night use sub-mode. Any of these modes and sub-modes, or even some other mode of operation, can be the startup mode. In some embodiments, the apparatus 20 can be configured to request an input of the desired mode or sub-mode of operation such that there is no generally pre-specified operational mode.

[0107] With reference now to Figure 6A, the apparatus 22 starts with the depression of the power button 42. See S-1. In some configurations, the power button 42 can be pressed and held for at least a minimum period of time in order to start the apparatus 22. Upon starting, one or more start screens can be presented on the screen or display 40 of the apparatus 22. See S-2. In some configurations, activation of the apparatus 22 also can be indicated audibly. For example, the apparatus 20 can include a speaker that emits a single solid tone, a series of tones, a recorded or synthesized voice, music, a chime, or other such noise or series of noises, for example but without limitation.

[0108] With continued reference to Figure 6A, when in the primary mode or the primary mode's youth sub-mode, following the display of the start screens, the illustrated configuration presents a screen that indicates the last event. See S-3. As illustrated, if a successful disinfection was the last event, then the apparatus 22 can indicate the number of completed disinfection cycles and the time since the last disinfection cycle, for example but without limitation. Also, a graphical indicator can be presented of whether the apparatus 22 has been recently disinfected. In the illustrated embodiment, for example but without limitation, there is a green light on a traffic light. If the last event was not a successful disinfection, then a different graphical indicator can be presented (e.g., an amber light on a traffic light). In some configurations, such as the illustrated configuration, the display will alternate between the number of disinfection cycles completed and the time since the last disinfection cycle.

[0109] After a period of time, the apparatus 22 begins a warm-up procedure. In some configurations, during the warm-up procedure, the heating element 30 is energized, which heats a water supply in the chamber 70. With continued reference to Figure 6A, a swirling icon indicates the warm-up procedure is underway. See S-4. In
5 some configurations, the swirling icon comprises multiple stationary images that, when played in series, provide the appearance of a revolving circle animation. Other configurations also can be used to create an animation indicative of on-going warm-up. The animation, however, advantageously provides a visual indicator of on-going activity. In some embodiments, the animation can include text, sound, or some
10 combination of images, animation, text, and/or sound.

[0110] With continued reference to Figure 6A, once the warm-up procedure has been completed, the swirling icon (see S-4) changes to a check-mark (i.e., tick). See S-5. The completion of the warm-up procedure also can be indicated by an audible tone or range of tones (e.g., ascending scale of tones), a recorded voice or synthesized voice,
15 a chime, a series of tones, or the like. In the illustrated configuration, the display 40 also shows a graphical depiction of values for dew point temperature, flow rate, and oxygen alarm level. This can be referred to as the main screen, the multiple value screen, or the summary screen. In some embodiments, the main screen can include additional or different information including, but not limited to, an indication of a mode or sub-mode
20 (e.g., transport mode indicators, youth sub-mode indicators, feedback sub-mode indicators), values for other parameters, disinfection information, or the like.

[0111] Advantageously, the multiple values shown on the screen are concurrently displayed to provide a simple review of these values. The readings can advantageously be displayed in other than a straight line to improve readability. In other
25 words, to aid reading, one or more of the multiple values are offset relative to the others of the multiple values. For example but without limitation, in the illustrated configuration (see S-5), the temperature is illustrated higher on the screen than the flow rate and the flow rate is illustrated higher on the screen than the oxygen alarm level. The display also can be provided with a screen saver (see S-6) that displays after a set period

of display inactivity. In some embodiments, the screen saver can include additional information, animations, or the like.

[0112] The menus and display screens of the apparatus 22 can advantageously be configured to be graphics-based instead of, or in addition to, being text-based. By displaying information, options, menus, instructions, and the like in a graphical manner, the display can be utilized in situations where different languages are spoken and/or where multiple languages are spoken. This can reduce or eliminate a need to translate instructions or information when the apparatus is used in various locations. This can also reduce or eliminate misunderstandings or mistakes that occur due to language differences or inaccurate translations of text-based information.

Mode Selection and High Level Settings

[0113] With reference to Figure 6B, from the main screen (see S-5) a key combination can be used to enter a top-level control menu, until ready to use. See S-7. In the illustrated configuration, the key combination comprises pressing the top three buttons (e.g., mute key 44, up arrow key 46, down arrow key 50) for at least a minimum period of time. In some configurations, the minimum period of time is 10 seconds. Other key combinations and minimum periods of time can be used.

[0114] In the illustrated configuration, the top-level control mode is accessible in the default mode (e.g., the primary mode or the secondary mode). The top-level control menu is used by individuals other than the user or patient 10. For example, the top-level control menu can be used by someone other than the ultimate user/patient 10 or the healthcare provider. In some configurations, the top-level control menu can be used by individuals authorized by the owner, distributor, or manufacture of the apparatus 22 such that various set points can be established for the owner that are not available for use by the user (e.g., the user 10 is unaware of the top-level control menu and/or the key combination used to access the top-level control menu).

[0115] Upon entry into the top-level control menu, the illustrated apparatus 22 enters a mode adjustment screen. See S-8. The mode adjustment screen allows changing between the primary mode and the secondary mode. The mode adjustment

screen presents information regarding the current mode (e.g., primary mode (“Primary”), secondary mode (“Secondary”), etc.).

[0116] While the mode adjustment screen is presented (see S-8), pressing and holding the up and down arrow keys together for a preset period of time unlocks the mode for adjustment. See S-9. The up arrow key 46 and the down arrow key 50 enable changing between available modes. Once a mode has been selected, pressing the mode button 52 reboots the machine in the selected mode. In some embodiments, the apparatus 22 only reboots when the selected mode is different from the previous mode.

[0117] In the illustrated configuration, while in the mode adjustment screen (see S-8), pressing the mode button 52 activates a language adjustment screen. See S-10. While the language adjustment screen is presented, pressing and holding the up arrow key 46 and the down arrow key 50 together for at least a minimum period of time unlocks the language adjustment selection. See S-11. The up arrow key 46 and the down arrow key 50 enable changing between languages. Once a language has been identified, pressing the mode button 52 confirms the identified language setting.

[0118] In the illustrated configuration, while in the language adjustment screen (see S-10), pressing the mode button 52 activates a target limit adjustment screen. See S-12. While the target limit adjustment screen is presented, pressing and holding the up arrow key 46 and the down arrow key 50 together for at least a minimum period of time unlocks the target limit adjustment. See S-13. In the target limit adjustment screen, the limits (e.g., lower limit and upper limit) between which target values can be set will be adjustable. Thus, if an owner or provider of the apparatus 22 desires that the flow target be selected from within a range between 15 L/min and 30 L/min at all times, those values can be set using the target limit adjustment screen.

[0119] While any of a number of parameters can be monitored and/or adjusted, the illustrated embodiment demonstrates monitoring, using, setting and/or adjusting the dew point temperature, the flow rate, the oxygen level, the oxygen setting, and the disinfection setting, for example but without limitation. In the illustrated configuration, the oxygen level is merely detected and is not adjusted by the apparatus 22. In some embodiments, the values defining the range are locked and, when in the

target limit adjustment screen (see S-12), depressing the up arrow key 46 and the down arrow key 50 together for a set period of time can unlock the values for adjustment. The unlocking of the values can be audibly indicated through the speaker (e.g., a solid tone, series of tones, music, chime, click, or the like).

5 **[0120]** With continued reference to Figure 6B, in the illustrated configuration, the lower limit for the temperature range can be adjusted while the upper limit is not adjustable. In some configurations, the upper limit is about 37 C. The lower limit, in the illustrated configuration can be about 31 C. In some configurations, the temperature can be adjusted in increments of 3 C and, as such, the lower limit
10 temperature can be set to 31 C, 34 C or 37 C. In the illustrated configuration, both the upper limit and the lower limit of the flow rate range can be adjusted. The flow range can be adjusted in 5 L/min increments between about 50 and about 15. In the illustrated configuration, the oxygen alarm level can be adjusted in 5% increments between about 90 and about 0. In some configurations, there is no lower limit for the oxygen alarm
15 level. The oxygen alarm level does not change the level of oxygen supplied but is used to provide an alarm if the level of oxygen being supplied is outside of a specified level.

[0121] In the illustrated configuration, the oxygen setting can be used to indicate whether the oxygen source is 100% bottle oxygen or a lower fraction from a concentrator which also has an argon content, for example. See S-13.2. The oxygen
20 concentration can be set and can range between about 20% and about 100%. Typically, the oxygen concentration can range between about 90% and about 95%. Pressing the up and down buttons allows the user to select the oxygen source and/or to adjust the oxygen concentration. Pressing the mode button can lock-in or confirm the selection and/or toggle the selection of the oxygen source. See S-13.4.

25 **[0122]** With continued reference to Figure 6B, the disinfection setting can be used to require a user to acknowledge a disinfection warning (e.g., by pressing the mode button 52) when the apparatus is being restarted in a defined disinfection state. See S-13.6. For example, when an apparatus is turned on without being disinfected prior to being shut off the last time it was in use, an amber or orange indicator light can be
30 displayed during startup. If disinfection acknowledgement is selected, the user will be

required to acknowledge the warning by pressing the mode button 52 when the indicator is displayed before resuming normal operation or startup. This can be set to force an acknowledgement on the part of the person operating the apparatus 22 that no disinfection mode has been run on the apparatus 22 since it was last used. In other words, the person operating the apparatus must consciously depress the mode button 52 to acknowledge this information. Using the up and down arrows can alternatively select and deselect this setting. Pressing the mode button confirms the selection. See S-13.8.

[0123] In some embodiments, the person changing the settings is alerted to the value being changed by a visual indicator. In the illustrated configuration, the number being adjusted changes between a colored number and a white number. In this manner, the number being adjusted appears to be pulsating or blinking. For example, as the user uses the mode button 52 to cycle from “temperature lower limit” to “flow lower limit” to “flow upper limit” to “oxygen alarm upper limit,” the number being adjusted has the appearance of blinking due to being displayed in more than one color in succession.

[0124] In some embodiments, pressing the mode button allows the user to cycle through the settings screens. When adjustments have been made, the apparatus 22 reverts to the swirling icon (see S-4) or the summary screen (see S-5) after an inactivity period has elapsed or after a particular key combination is pressed (e.g., holding down the mute, up, and down buttons for at least a minimum period of time).

Value Level Settings

[0125] As discussed above, on the main multiple value screen (see S-5) of the illustrated embodiment, the display screen 40 can illustrate current dew point temperature, current flow rate and current oxygen level, for example but without limitation. These values are based upon real time readings. In some embodiments, the readings are made during warm up as well as during use. During any changes to the readings (e.g., until set points have been reached), the numbers flash between a white illustration and a colored illustration to provide a visual pulsing effect such as that described above. Once a set point value (e.g., the target value) has been obtained, the number will go solid.

[0126] With reference to Figure 6C, in any mode, when not on the main screen (e.g., when on the temperature target screen and/or the flow target screen), depressing the mode button will cycle among a plurality of values. The values can be represented by smaller icons or other shapes that, when selected, increase in size and possibly detail. The plurality of smaller icons or other shapes facilitate an expandable scrolling menu that allows a large number of values to be displayed even on a smaller display screen 40. See S-18.1. While the illustrated configuration depicts a temperature target screen (S-14), a flow rate target screen (S-15) and an oxygen level alarm target screen (S-16), any number of additional screens can be presented. For example, the apparatus 22 can display a day/night sub-mode screen, a transport mode screen, or the like. Each of these screens can be used to select a value within the preset range (e.g., the range specified in S-12 and S13). In some configurations, a default setting for the dew point temperature target is 37 C.

[0127] In any mode, when not on the main screen, depressing the up and down arrows together for at least a minimum period of time will allow the user to adjust the temperature target (S-17) and/or the flow rate target (S-18). In some configurations, these values are locked and depressing the up arrow key 46 and the down arrow key 50 at the same time for at least a minimum period of time can unlock the values. The unlocking of the values for adjustment can be audibly indicated (e.g., a solid tone, series of tones, click, voice, music, chimes, etc.).

[0128] Once unlocked, the values for the target temperature and the target flow rate can be adjusted within the preset range of values using the up arrow key and the down arrow key. See S-17 and S-18. For example, in some configurations, the dew point temperature can be adjusted between 31 C and 37 C. For example, 31 C might be used if delivery of the flow is through a mask, while 37 C might be used where upper airway is bypassed (e.g., tracheotomy) and 34 C might be used for a small, petite patient receiving nasal gas delivery. By way of further example, the flow rate may be adjusted within a range of about 15 L/min. and 50 L/min. While not illustrated, the oxygen level at which the apparatus will alarm can be adjusted within a range of 20% and 90% (i.e., any adjustment of oxygen levels will be made at the wall valve or another valve).

[0129] When on the temperature adjustment screen, pressing the mode button 52 for at least a minimum period of time (e.g., at least about 5 seconds) can display the transport mode screens. See S-17.1 and S-17.2. The up and down arrows can be used to alternate between selecting the normal mode or the transport mode.

5 Pressing the mode button again confirms the selection. In the transport mode, the temperature setting for the heater plate can be reduced (e.g., typically to about 31 C from about 37 C in the normal mode). In some embodiments, entering the transport mode can cause the apparatus 22 to reduce or minimize power usage by the heater plate 80, motors, and the like. The reduction or minimization of power can be done to reduce

10 power consumption when connected to a universal power supply (“UPS”) for transportation from one location to another when the apparatus cannot or will not be plugged into an electrical socket. When in transport mode, the apparatus 22 can have a countdown timer with a preset period of time (e.g., about 30 minutes), after the expiration of which the apparatus 22 automatically reverts to a normal mode of

15 operation. The screen can display the temperature setting and the countdown timer indicating when the apparatus will automatically revert to a normal mode of operation. In some embodiments, the countdown timer can be reset by the user if the transportation will last longer than the timer provides. In some embodiments, the apparatus reverts to the mode of operation it was in prior to being put into the transportation mode. In some

20 embodiments, the transportation mode screen (S-17.2) can display other information or indicators, such as a flow rate, an oxygen setting, a youth-sub mode, or the like.

[0130] In some embodiments, the apparatus 22 can be configured to enter transport mode when connected to a UPS. The apparatus 22 can be configured to understand and communicate appropriate handshake protocols with UPS systems so as

25 to recognize when it is connected to a UPS rather than an electrical wall socket. In some embodiments, the apparatus 22 can remain in transport mode until disconnected from the UPS and/or connected to an electrical wall socket.

[0131] Following adjustment, the selected value will be locked after a set period of time (e.g., five or seven seconds) or when the mode button 52 is pressed to

30 move to the next screen. After a preset period of time, when adjustments have been

made, the apparatus 22 reverts to the swirling icon (see S-4) or the summary screen (see S-5) after an inactivity period has elapsed or when a defined key combination has been pressed.

Youth Sub-mode

5 **[0132]** In either the primary mode or the secondary mode, at any time during warm-up (see S-4) or after the apparatus is ready for use and when the main screen is visible (see S-5), the apparatus 22 enters a youth sub-mode when the mode button 52 is pressed for at least a minimum period of time (e.g., about 10 seconds), as illustrated in Figure 6D. After each disinfection, which should be performed after use and prior to a
10 subsequent patient/user, the apparatus 22 can be configured to require depression of the mode button 52 to enter the youth sub-mode. This forces an acknowledgement on the part of the person operating the apparatus 22 that the settings have changed. In other words, the person operating the apparatus must consciously depress and hold the mode button 52.

15 **[0133]** Upon entry into the youth sub-mode, one or more entrance screen can be provided. See S-19. At least one entrance screen, in some embodiments, is distinct from the default mode entrance screen. In the illustrated configuration, attention-getting animations are provided on the youth sub-mode entrance screen. The animations in the illustrated configuration are a butterfly and a bird. The butterfly and the bird move onto
20 the screen. In some configurations, the butterfly and the bird can move inward from the edges of the screen to attract attention.

[0134] The apparatus 22, when first entering the youth sub-mode, can adjust the target temperature and/or the target flow rate. In some configurations, the target temperature is adjusted to a level lower than the level available in the default (e.g.,
25 primary or secondary) mode, which was discussed above. In some configurations, the target temperature in the youth sub-mode is about 34 C. The target flow rate can be set to the flow rate closest to the prior setting in the default (e.g., primary or secondary) mode. If the prior flow was above the youth sub-mode range, then the highest flow in the range will be selected. If the prior flow was within the youth sub-mode range, then
30 the prior flow will be used. In some configurations, if the target flow rate set in the

default (e.g., primary or secondary) mode is above about 20 L/min, the target flow rate will adjust to 20 L/min in the youth sub-mode. If the apparatus 22 has been used in the youth sub-mode previously, the apparatus 22 will recall the settings from the prior use in the youth sub-mode and set the targets according to the prior settings. See S-20.

5 **[0135]** An additional animation (e.g., an eye and water bag) also can be provided to remind the person operating the apparatus 22 that the water supply should be monitored because there may be no water out alarm in the youth sub-mode. See S-21. Because the youth sub-mode involves lower flow rates, the rate of evaporation is slower than at higher flow rates. Because there may be no humidity sensor, detection of low
10 water conditions can be based upon a comparison of the energy required to operate with a full chamber and the energy required to run with no water in the chamber. In the default (e.g., primary or secondary) mode, if the current state is trending toward no water, then an alarm is issued. At low flow rates, the difference may be not large enough to detect reliably. The detection is based upon the duty cycle applied to the
15 heater plate. Because less water is evaporated at low flow rates, the change may be too subtle to reliably and repeatably detect.

[0136] Following the depiction of the animations, the new target settings will be presented. See S-22. In addition, the swirling icon discussed above can be presented to demonstrate visually that the apparatus 22 is still warming up. Upon completion of
20 the warm up, the swirling icon can be replaced with a check-mark (i.e., tick). See S-23. As discussed above, after a period of inactivity, a screen saver mode can be entered. See S-24.

Feedback Sub-mode

[0137] In any of the primary mode, the secondary mode, or the associated
25 youth sub-modes, the apparatus 22 can comprise a feedback sub-mode. The feedback sub-mode can be selected by the user or can be automatically selected by the apparatus. For example, if a detected breathing rate exceeds a predetermined breathing rate, the apparatus can enter the feedback sub-mode to assist the user in attaining a desired breathing pattern or breathing rate. The feedback sub-mode can provide visual and/or

audible cues to coach a patient/user to obtain the desired breathing pattern or breathing rate.

Disinfection Mode

[0138] After shutdown, the disinfection conduit 82 can be connected to the apparatus 22. On one end, the disinfection conduit 82 has the same connector as the patient conduit 26. On the other end, the disinfection conduit 82 is sized and configured to mate to the outlet 72 from the flow generator. The heater wire 84 with the same resistance as the heater wire 30 in the patient conduit 26 can be installed within the disinfection conduit 82. In some embodiments, the disinfection conduit 82 does not include a temperature sensor. The disinfection conduit 82 can be coaxial in construction with an insulating sleeve surrounding the conduit that defines the flow path such that insulating air can be trapped between the inner conduit and the outer sleeve.

[0139] The filter cap 86 can be joined to the end of the disinfection conduit 82 opposite to the connector with the heater wire connection. The cap 86 can be joined by a strap to the disinfection conduit 82 to reduce the likelihood of the cap 86 being lost between uses. During disinfection, the cap 86 can be installed over the inlet 74 to the elbow 76, as will be described below.

[0140] In some embodiments, the elbow 76 is mechanically cleaned (e.g., bottle brush) and chemically cleaned before the disinfection conduit 82 is connected to the elbow 76. The disinfection conduit 82 is connected to the outlet of the flow generator and the outlet 72 of the elbow 76 such that flow through the elbow 76 is reversed relative to the norm.

[0141] The cap 86 can be installed over the other end of the elbow 76. The cap 86 is secured with an outer sleeve that overlaps an outer surface of the port. The cap comprises a filter medium and a protruding member. The protruding member reduces the likelihood of the cap being installed on the outlet from the flow generator because the protruding member contacts a non-return valve positioned within the outlet from the pressurized air source. The protruding member also decreases the size of the flow path to increase the velocity of the airflow through a non-heated region disposed between the end of the heated disinfection conduit 82 and the discharge point of the filter cap 86. In

addition, the rapid expansion of the higher speed airflow as it exits the cap 86 causes a rapid decrease in temperature of the air. Thus, there is a high disinfection temperature right up until the discharge point of the filter cap 86, following which the temperature drops dramatically.

5 **[0142]** With reference to Figure 7, with disinfection conduit 82 installed, the apparatus 22 is turned on by pressing the power key 42. See U-1. The system detects the disinfection conduit 82 because the temperature sensor is not included in the disinfection conduit 82 but the resistance of the heater wire 84 is detected. Because of the detection of the presence of the disinfection conduit 82, the disinfection mode begins
10 and start screens are provided to the display 40. See U-2. Other manners of starting the disinfection mode also can be used.

[0143] The display then presents a swirling icon similar to that described above to indicate that the apparatus 22 is warming up. See U-3. In some embodiments, the swirling icon has a different color to indicate that the apparatus 22 is warming up for
15 disinfection mode instead of normal operation. In some configurations, other animations or indicators can be used.

[0144] The apparatus 22 monitors usage conditions and, when a target usage limit has been reached, the apparatus 22 provides a suggestion to replace the inlet air filter. See U-4. As shown in Figures 8A-8D, in the illustrated configuration, the
20 apparatus 22 presents an animation illustrating removal and replacement of the air filter. The animation presents the cover being removed, the old filter being removed, the new filter being inserted and the cover being replaced. The animation can comprise a plurality of frames that show slight movement from one frame to the next such that presenting the frames in series provides a visual animation. In some embodiments, a
25 portion of the image sequence presents a “zoomed-in” display of a portion of the apparatus, such as the filter cover in Figure 8C. This may be advantageous to show detailed visual information and/or to present detailed visual information on a relatively small display or a display with relatively few pixels (e.g., a display with a relatively low resolution). In some embodiments, the apparatus 22 can be configured to produce an
30 audible cue or sound at the time in the animation when the filter cover is shown as being

closed, the audible cue being used to indicate that a sound should be produced when the filter cover is correctly closed. Other animations and/or audible cues can be used.

[0145] Returning to Figure 7, the apparatus 22 can be configured to request an acknowledgment of an indication to replace the filter. In the illustrated configuration, 5 the apparatus 22 requests pressing of the mode button 52 in order to proceed with disinfection. Accordingly, the suggestion to replace the air filter is acknowledged through the pressing of the mode button 52.

[0146] As discussed above, during start-up, a colored swirling icon can be used. See U-3. Following start-up, the system monitors temperature in the elbow 76 to 10 detect whether the temperature is rising fast enough in accordance with a disinfection mode. Because the disinfection conduit 82 has a heater 84 and because the airflow is being heated by the heater 84 prior to delivery to the sensor in the elbow 76, the temperature profile varies relative to having a breathing conduit 26 with a heater 30 positioned after the elbow 76 and a chamber 70 positioned before the elbow 76.

[0147] During the disinfection process, a counter is used to show progress. 15 See U-5. The counter can count down the amount of time remaining in the disinfection mode. Pressing the mode button 52 will present a graphical display that updates to show progress of the disinfection. See U-6. The graphical display can be temperature over time and a colored bar can be presented to graphically depict the amount of time over a 20 set temperature (e.g., 90 C). In some embodiments, this is a display that dynamically updates as the disinfection cycle progresses. At the end of the disinfection cycle, the display alternates between announcing a successful completion and the total number of successful disinfections. In some embodiments, announcing the successful completion can comprise displaying visual information, emitting a sound, or some combination of 25 both visual and audible cues.

Secondary mode

[0148] As discussed above, the apparatus 22 can be operated in a secondary mode, which can be designed for more intermittent use (e.g., home use). With reference to Figures 9A-9C, in the secondary mode, the apparatus 22 operates in many ways

similar to the operation of the apparatus 22 in the primary mode. One of the differences, however, relates to the setting of values.

[0149] With reference to Figure 9A, in the illustrated embodiment, the display screen 40 either illustrates the swirling icon (see T-1) discussed above or a checkmark (i.e., tick) (see T-2) also discussed above. As discussed above, current dew point temperature, current flow rate and current oxygen level, for example but without limitation, can be monitored by the apparatus. These values are based upon real time readings. In some embodiments, the readings are made during warm up as well as during use.

10 [0150] In the secondary mode, when the swirling icon (T-1) or the checkmark (T-2) is presented, depressing the mode button 52 will cycle among a plurality of values (T-4, T-5, and T-6), similar to the process depicted in Figure 6C. The values can be represented by smaller icons or other shapes that, when selected, increase in size and possibly detail. The plurality of smaller icons or other shapes facilitate an expandable scrolling menu that allows a large number of values to be displayed even on
15 a smaller display screen 40, as shown in S-18.1.

[0151] While the illustrated configuration depicts a temperature target screen (T-4), a flow rate target screen (T-5) and an oxygen level alarm screen (T-6), any number of additional screens can be presented. In some configurations, a screen can be provided for night-use sub-mode. In the night use sub-mode, non-alarming noises are
20 quieted or cancelled and the brightness of the display screen 40 is adjusted. In some configurations, the apparatus also can display the number of hours, the average hours per day and a value that can be used by a doctor to confirm that accurate numbers are being provided by the user. Moreover, compliance data can be exported using any suitable
25 technique. For example, a serial cable can be plugged into a data port and a USB based modem. Each of these screens can be used to review data or select a value within a preset range. In some embodiments, in the secondary mode, the values are not locked and are easily adjusted without performing an unlocking operation, which can be different from the primary mode as described with reference to Figure 6C. After a

period of inactivity, when adjustments have been made, the apparatus 22 reverts to the swirling icon (see T-1) or the checkmark screen (see T-2).

[0152] Comparing Figures 6A-6D with Figures 9A-9C, another distinction can be shown between the youth sub-mode in the primary mode and the youth sub-mode in the secondary mode. In particular, during warm up (S-22), (T-7) and following warm up (S-23), (T-8), in the primary mode, data is presented regarding various characteristics of operation while, in the secondary mode, the screen does not present the data. This is similar to the screen shown after warm up in the secondary mode (compare S-5 and T-2). While it is possible to present the data in the secondary mode, such data may be less relevant to an intermittent, home-type of user.

Drying Mode in Secondary mode

[0153] Following use in the secondary mode, the user presses the power button 42. Upon shut-down, an audible alert is made and the apparatus 22 enters a drying mode. During drying mode, the apparatus 22 turns off power to the heater plate 80, increases the temperature in the conduit 26 by increasing the heat generated by the heater wire 30 and the flow rate is changed to an appropriate value. In some applications, the flow rate is set to about 15 L/min in default mode (e.g., primary mode or secondary mode) or about 10 L/min in the youth sub-modes.

[0154] In some configurations, during the drying sub-mode, the apparatus 22, including the conduit 26, is controlled to maintain total enthalpy below a desired enthalpy limit as measured at the patient/user end of the conduit 26. For example, as the chamber cools, the temperature of the conduit 26 can be increased by increasing the heat output of the conduit heater wire 30. In some configurations, the enthalpy limit is less than about 194 kJ/kg dry gas when averaged over 30 seconds. In some configurations, the enthalpy limit is about 194 kJ/Kg dry gas when averaged over 30 seconds.

[0155] The drying sub-mode continues for a drying period. At the end of the drying period, the apparatus 22 shuts down.

Fault Conditions

[0156] During operation in any of the modes or sub-modes, a number of operating conditions for the apparatus 22 are monitored for fault conditions. Each fault

condition that is correctable by a user can be configured to have one or more animations showing the problem and/or how to fix the problem. As described above with respect to replacing the filter (see Figures 8A-8D), each animation can comprise a plurality of frames that show slight movement from one frame to the next such that presenting the frames in series provides a visual animation. While certain animations will be discussed below, other animations can be used. Accordingly, the apparatus 22 can be configured to detect fault conditions, select an appropriate animation to display, and detect when the fault condition has been corrected. The selected animation can highlight or indicate the location or components causing the fault condition, illustrate how to correct the fault condition, and provide indicators of success in correcting the fault condition. In some embodiments, the animation only proceeds to a following step when the current step is completed. In some embodiments, the animation is repeated until the fault condition is corrected. In some embodiments, the animation is automatically stopped when the fault condition is corrected. When a fault condition occurs, the apparatus 22 can provide an alarm that can include any combination of audible sounds and visual indicators. The alarm can continue until the fault condition is corrected. For example, the alarm can be configured to automatically cease when the apparatus 22 detects that the problem has been fixed.

[0157] In some embodiments, the animations can include a series of images that present “zoomed-in” pictures or animations of the apparatus 22. For example, for selected parts of the animation, the zoomed-in animation can show sections of the apparatus 22 in more detail to illustrate elements that may otherwise be unclear on a display 40 with a relatively low resolution, such as the display 40 that may be included on the apparatus 22. For example, the series of images can include a first subset of images depicting the apparatus 22 with a first level of detail and a second subset of images depicting a second level of detail, the second level of detail being greater than the first level of detail. This second level of detail can be a zoomed-in depiction of the apparatus, and the zoomed-in depiction can be configured to include a region of interest on the apparatus 22 meriting attention.

[0158] In some configurations, noises or audible cues can be used in conjunction with the animations. The audible cues can be timed to coincide with the display of actions in the animations. In some embodiments, the audible cues are configured to simulate or approximate a sound that would be produced when the animated action occurs.

[0159] In some configurations, flashing lights, colors, glowing effects, and/or other visual cues can be presented in the animations to indicate portions of the address meriting attention (e.g., showing a glowing red effect around a region of interest). These components may be in fault or may be one of the causes of the fault condition that triggered the animation. The visual cues can also be used to indicate the corrected problem, such as how a component should be positioned when it is in the correct location (e.g., showing a glowing green effect around the corrected region of interest). For example, the chamber 70 can be animated to glow red when not properly seated in the apparatus 22, and the animation can illustrate the chamber being correctly positioned and the glowing changing to a green effect.

[0160] With reference to Figures 8A-8D, if the apparatus 22 detects that a filter replacement is warranted (e.g., if the apparatus 22 detects that it has been in use without a filter replacement for over a minimum number of hours, an example of which is described with reference to U-4 in Figure 7), the apparatus 22 can display a series of images depicting removal and replacement of a filter. For example, Figures 8A-8D depict removal of the filter cover, exposing the filter. Beginning at the bottom of Figure 8A and into Figure 8B, the series of images depict the used filter being removed from the apparatus. Beginning at the bottom of Figure 8B and into Figure 8C, the series of images depict the new filter being installed into the apparatus. Once the filter is installed, the series of images depict closing the filter cover. The series of images include a zoomed-in depiction of the filter cover being fastened onto the apparatus housing starting in Figure 8C and into Figure 8D. The zoomed-in series of images present the filter cover and housing in greater detail to provide more information to the user to enable the user to better close and secure the filter cover in place. In some embodiments, the apparatus 22 can play an audible cue (e.g., a clicking noise or other

appropriate sound) to coincide with the depiction of the filter cover being correctly seated or locked-in, as illustrated in the final image in Figure 8D. The audible cue can be configured to provide the user with an indication of an expected sound to be produced when the animated action is performed correctly.

5 **[0161]** With reference to Figure 10, if a disconnection from the conduit heater wire is detected, the apparatus indicates a removal of the circuit. See W-1. There can be an audible alarm (e.g., three short monotones, single tone, series of tones, chime, music, etc.) that indicates a disconnection of the circuit. The display can show an animation of the circuit being removed and being reconnected. Some of the images
10 from such an animation are shown in Figure 11. For example, the series of images in Figure 11 depict the circuit being removed from the apparatus by disengaging the connector from the outlet end of the elbow and lifting the circuit. In some embodiments, the apparatus 22 can emit an audible cue when the circuit is depicted as being removed from the apparatus. The audible cue can be configured to approximate or simulate a
15 sound that would be produced when disengaging the circuit from the apparatus.

[0162] If a loss of resistance to flow is detected (e.g., a system leak, a dislodged interface, a dislodged chamber, etc.), there can be an audible alarm (e.g., three short monotones, single tone, series of tones, chime, music, etc.) that indicates a leak in the system. The display 40 can show an animation or a series of animations. For
20 example but without limitation, the animations can demonstrate reseating the chamber and reseating the interface to the circuit. Similarly, if the apparatus is in the youth sub-mode and an adult cannula is connected, the system indicates a possible leak and issues an audible alarm (e.g., three short monotones, single tone, series of tones, chime, music, etc.). The apparatus 22 also can present an illustration showing the connection of the
25 youth sub-mode cannula (e.g., infant cannula).

[0163] If a higher than expected resistance to flow is detected (e.g., a system blockage), there can be an audible alarm (e.g., three short monotones, single tone, series of tones, chime, music, etc.) that indicates a blockage in the system. See W-3. The display 40 can show an animation or a series of animations. For example but without
30 limitation, the animations can demonstrate unkinking a hose, determining if the youth

sub-mode interface is installed in the default primary mode or secondary mode, unclogging a nasal cannula, or the like.

[0164] If oxygen content is detected above the set level, the system can issue an audible alarm (e.g., three short monotones, single tone, series of tones, chime, music, etc.) and can present an animation illustrating how to decrease the flow of oxygen at the wall connection. See W-4. Similarly, if oxygen content is detected below the set level, the system can issue an audible alarm (e.g., three short monotones, single tone, series of tones, chime, music, etc.) and can present an animation illustrating how to increase the flow of oxygen at the wall connection. See W-5.

10 [0165] If the water level is detected to be low or empty, the system can issue an audible alarm (e.g., three short monotones, single tone, series of tones, chime, music, etc.) and can present an animation illustrating how to remove a depleted water bag and attach a new water bag. See W-6.

[0166] If an oxygen supply is detected during operation in the disinfection mode, the apparatus 22 can issue an audible alarm (e.g., three short monotones, single tone, series of tones, chime, music, etc.) and can present an animation illustrating how to remove the oxygen supply. See W-7. In some embodiments, when such a condition is presented, power is not provided to the conduit heater 84 until after the condition has been rectified.

20 [0167] The apparatus 22 might alarm if the apparatus 22 detects a disconnection, depletion or prolonged interruption of the oxygen supply (e.g., if the oxygen level drops below a certain percentage for a preset period of time, if there is a sudden drop or change in the oxygen level or both). In some configurations, the alarm triggering thresholds indicative of oxygen level events can be different in different modes or sub-modes. In some embodiments, when such a condition is presented, the apparatus can issue an audible alarm (e.g., three short monotones, single tone, series of tones, chime, music, etc.) and the display can present an animation illustrating how to check the connection of the oxygen supply.

[0168] The apparatus 22 also might alarm if user breathing is no longer detected. In some embodiments, when such a condition is presented, the apparatus can

issue an audible alarm (e.g., three short monotones, single tone, series of tones, chime, music, etc.) and the display can present an animation illustrating how to check for a displaced user interface, a disconnected user interface or an adverse clinical event.

5 [0169] The apparatus 22 might alarm if a user breathing rate exceeds a predetermined limit. In some embodiments, when such a condition is presented, the apparatus can issue an audible alarm (e.g., three short tones) and the display can present an animation demonstrating the breathing rate, for example but without limitation.

10 [0170] Any number of other fault conditions also can be detected and other alarms can ensue from such fault conditions. For example, but without limitation, the apparatus 22 might alarm if the target dew point temperature cannot be reached, if the target flow rate cannot be reached, or if there is another operating condition that should be checked and/or corrected. Any or all of these can be indicated with an audible alarm (e.g., three short monotones, single tone, series of tones, chime, music, etc.) and/or an animation or other fault code screen. See W-8. In some embodiments, the audible
15 alarm can be accompanied by animations and the animations and/or the audible alarms can stop automatically when the apparatus 22 detects that the fault conditions has been fixed. Accordingly, the apparatus 22 can be configured to automatically detect the presence and rectification of fault conditions.

20 [0171] The display also can show an international symbol for alarm (e.g., a symbol compliant with IEC 60601-1-8). See W-9. If the mute button is depressed during the alarm, a mute symbol is displayed on the screen and the sound from the alarm can be disabled for a set period of time (e.g., 120 seconds). See W-10. Once any fault condition is resolved, an audible notification can result (e.g., three climbing scale tones) and the system can revert to normal operation.

25 [0172] Thus, in some configurations, the apparatus 22 is configured to prompt users to perform maintenance tasks and troubleshooting through the use of animations or other graphical displays. For example, the apparatus can indicate a desire for a filter replacement as well as coach an individual through changing the filter with a visual representation of the actions to be taken. By way of other examples, the apparatus
30 22 can indicate how to perform disinfection or how to clean the device.

[0173] Moreover, in some configurations, the apparatus 22 can recognize certain fault conditions with the apparatus 20 and coach a person to correct the recognized fault through a video animation of the corrective action or corrective actions desired. For example, where several different causes can underlie a detected loss of resistance to flow, the apparatus 22 can demonstrate several connections and other components to check to restore the anticipated resistance to flow. Where fault codes are primarily used in the apparatus 22 to indicate fault conditions (e.g., E14), it may be problematic for the user 10 to know how to correct the fault based solely upon the fault codes provided by the apparatus 22. Thus, presentation of animations, visual cues, and audible cues can facilitate the rectification of fault conditions.

[0174] Figures 12A-12M illustrates a series of images used in an example animation showing a chamber installation sequence. The animation can be used to indicate a region of interest causing the fault condition. As an example, this is illustrated in Figures 12A and 12B which, when alternated, display a flashing glowing region surrounding the chamber. In some embodiments, the flashing glowing region surrounding the chamber is red, but other colors can be used. The animation can continue and display another glowing region indicating an action to be taken by the user. An example of this is shown in Figures 12C and 12D which, when alternated, display a flashing glowing region surrounding the user's fingers where force should be applied to the chamber. The flashing glowing region can be colored green to show that this is a correct action, and other colors may be used. The animation can show the result of performing the action indicated in Figures 12C-12E, by showing the chamber slide into place in the apparatus (shown in Figures 12F-12M). The animation can zoom-in to the apparatus to show greater detail. For example, the animation can zoom-in beginning in Figure 12F to show the finger guard move into place once the chamber is clear of the guard (as shown in Figure 12L). Prior to the chamber being clear of the guard, the animation can show the finger guard with a flashing glowing region surrounding it (as shown when Figures 12I and 12J are presented in an alternating fashion), and the flashing glowing region can be a first color (e.g., red). When the chamber is correctly positioned, as shown in Figure 12L, the finger guard can be shown with a differently

colored (e.g., green) flashing glowing region (as shown when Figures 12L and 12M are presented in an alternating fashion). The animation can be accompanied by an audible cue, such as a clicking sound, when the finger guard moves into position in Figure 12L. The audible cue can be configured to approximate or simulate the sound of the finger guard clicking into position when the chamber is correctly positioned.

5 [0175] Although the disclosure herein has been presented in terms of some embodiments, other embodiments apparent to those of ordinary skill in the art also are within the scope of this disclosure. Thus, various changes and modifications may be made without departing from the spirit and scope of the disclosure. For instance,
10 various components may be repositioned as desired. Moreover, not all of the features, aspects and advantages are necessarily required to practice embodiments encompassed by this disclosure. Accordingly, the scope of each of the claimed inventions is intended to be defined only by the claims that follow.

WHAT IS CLAIMED IS:

1. A breathing assistance apparatus, comprising:
a flow generator;
a humidifier chamber connected to the flow generator;
5 wherein the apparatus is configured to be connected to a conduit; the conduit being for connection to a user breathing interface;
the apparatus further comprising a display screen adapted to provide visual information to a user,
wherein the apparatus is configured to monitor one or more
10 characteristics of use, and upon an occurrence of a triggering event to provide a series of image frames to the display, the series of image frames depicting an animated action configured to instruct a user to make an adjustment to the apparatus based upon the animated action to address the occurrence of the triggering event,
15 wherein the breathing assistance apparatus is removably connectable to an oxygen supply, and
wherein the triggering event comprises detecting a presence of a connected oxygen supply during disinfection mode.
2. The apparatus of claim 1, wherein the apparatus comprises a button and
20 depression of the button stops the display of the series of image frames.
3. The apparatus of claim 1 or 2, wherein the animated action comprises steps for removing the oxygen supply.
4. The apparatus of any one of claims 1 to 3, wherein the animated action comprises a sequence that repeats until the triggering event is corrected.
- 25 5. The apparatus of any one of claims 1 to 4, wherein the apparatus also shuts off power to a disinfection conduit heater until the triggering event is corrected.
6. The apparatus of any one of claims 1 to 5, comprising a conduit configured to connect to the flow generator or humidifier.
7. The apparatus of claim 6, comprising a user breathing interface
30 configured to connect to the conduit.

8. The apparatus of any one of claims 1 to 7, wherein the display comprises a touch-screen.
9. The apparatus of any one of claims 1 to 8, wherein the display is configured to display color.
- 5 10. The apparatus of any one of claims 1 to 9, wherein the animated action comprises steps for adjusting the oxygen supply.
11. The apparatus of any one of claims 1 to 10, wherein the animated action comprises steps for reconnecting the oxygen supply.
12. A breathing assistance apparatus, comprising:
- 10 a flow generator;
- a humidifier chamber;
- wherein the apparatus is configured to be connected to a conduit; the conduit being for connection to a user breathing interface; the apparatus further comprising;
- 15 a controller electrically coupled to the apparatus; and
- a display screen electrically coupled to the controller and adapted to provide visual information to a user,
- wherein the apparatus is configured to:
- 20 monitor one or more characteristics of use;
- detect an occurrence of a triggering event using the controller, the detection of the triggering event being at least partly based on the monitored characteristics of use;
- select a series of image frames depicting an animated action; and
- provide the series of image frames to the display,
- 25 wherein the animated action is configured to instruct a user to make an adjustment to the apparatus based upon the animated action to address the occurrence of the triggering event by providing visual cues in the series of image frames indicating a region of interest and at least one audible cue corresponding to an occurrence of an action in the series of
- 30 image frames wherein the audible cue and the occurrence of the action are configured to be presented substantially simultaneously;

wherein the breathing assistance apparatus is removably connectable to an oxygen supply; and

wherein the triggering event comprises detecting a presence of a connected oxygen supply during disinfection mode.

5 13. The apparatus of claim 12, wherein the audible cue is configured to approximate a sound produced when the action occurs.

 14. The apparatus of claim 12 or 13, wherein the visual cues comprise flashing lights surrounding the region of interest.

 15. The apparatus of any one of claims 12 to 14, wherein the series of image
10 frames comprises a first subset of image frames depicting the apparatus with a first level of detail and a second subset of image frames depicting a second level of detail, the second level of detail being greater than the first level of detail.

 16. The apparatus of claim 15, wherein the second subset of image frames
15 presents a zoomed-in depiction of a portion of the apparatus that includes the region of interest.

 17. The apparatus of any one of claims 12 to 16, comprising a conduit configured to connect to the flow generator or humidifier.

 18. The apparatus of claim 17, comprising a user breathing interface configured to connect to the conduit.

20 19. The apparatus of any one of claims 12 to 18, wherein the display comprises a touch-screen.

 20. The apparatus of any one of claims 12 to 19, wherein the display is configured to display color.

 21. The apparatus of any one of claims 12 to 20, wherein the animated action
25 comprises steps for adjusting the oxygen supply.

 22. The apparatus of any one of claims 12 to 21, wherein the animated action comprises steps for reconnecting the oxygen supply.

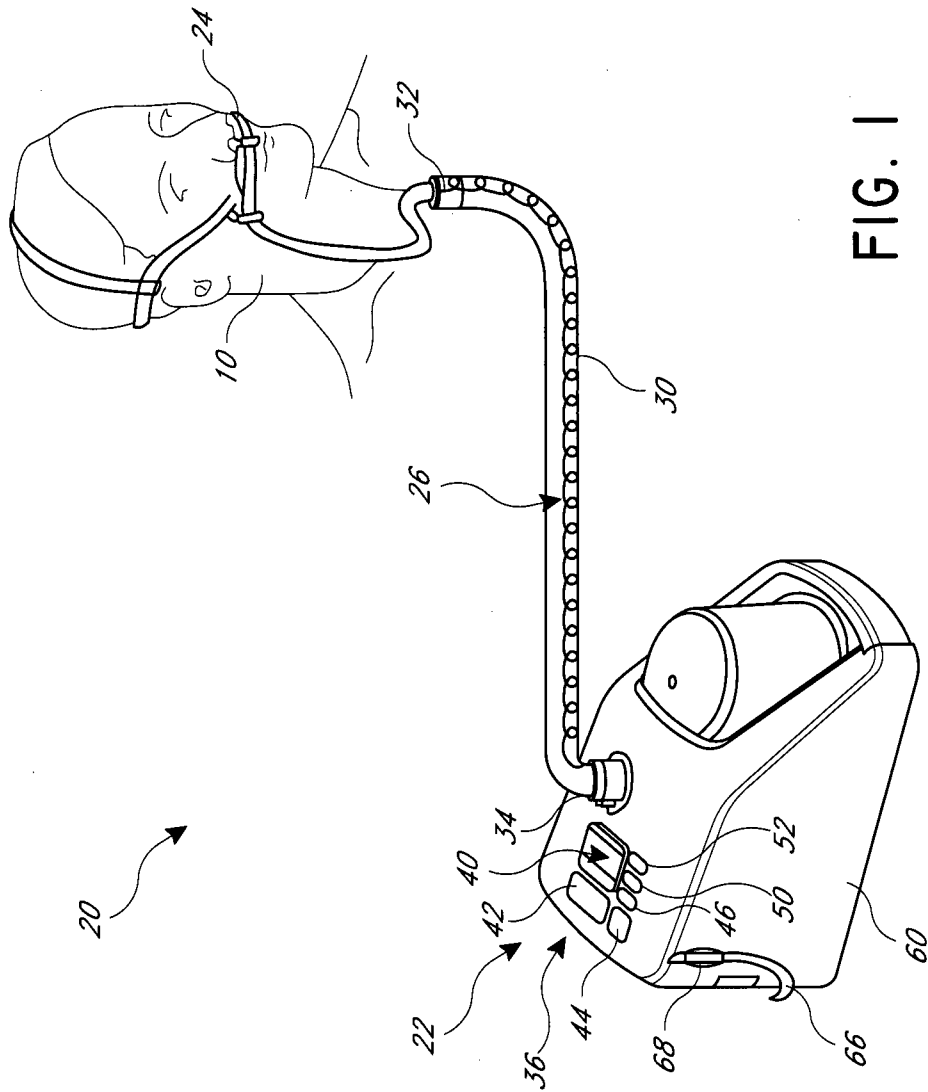

FIG. 1

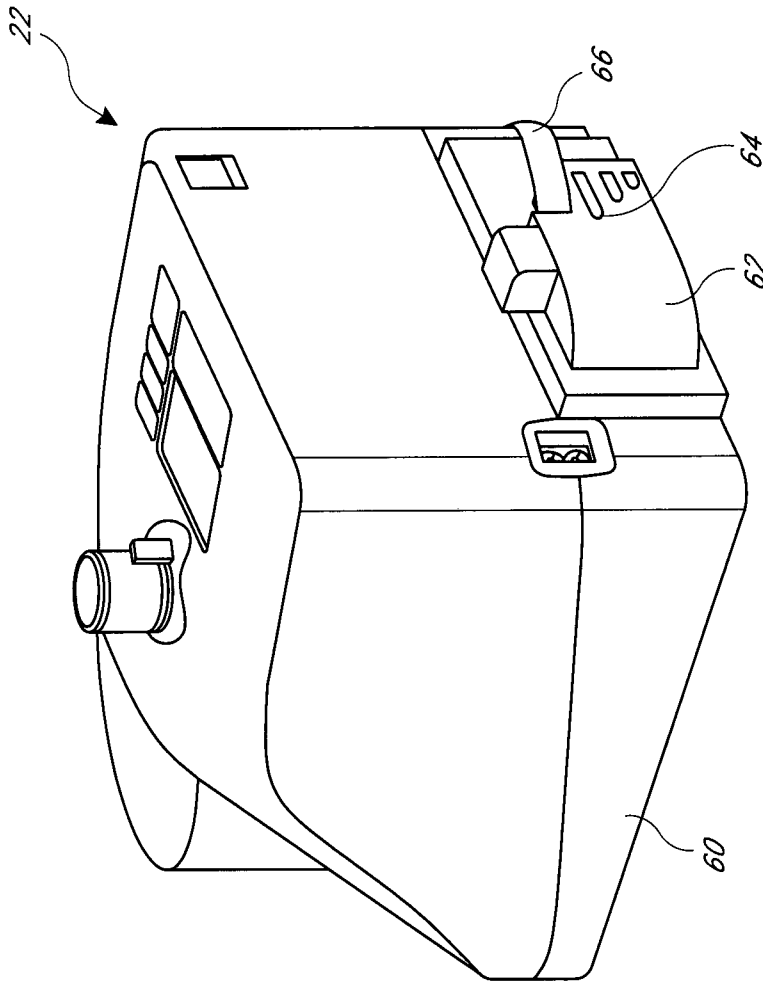

FIG. 2

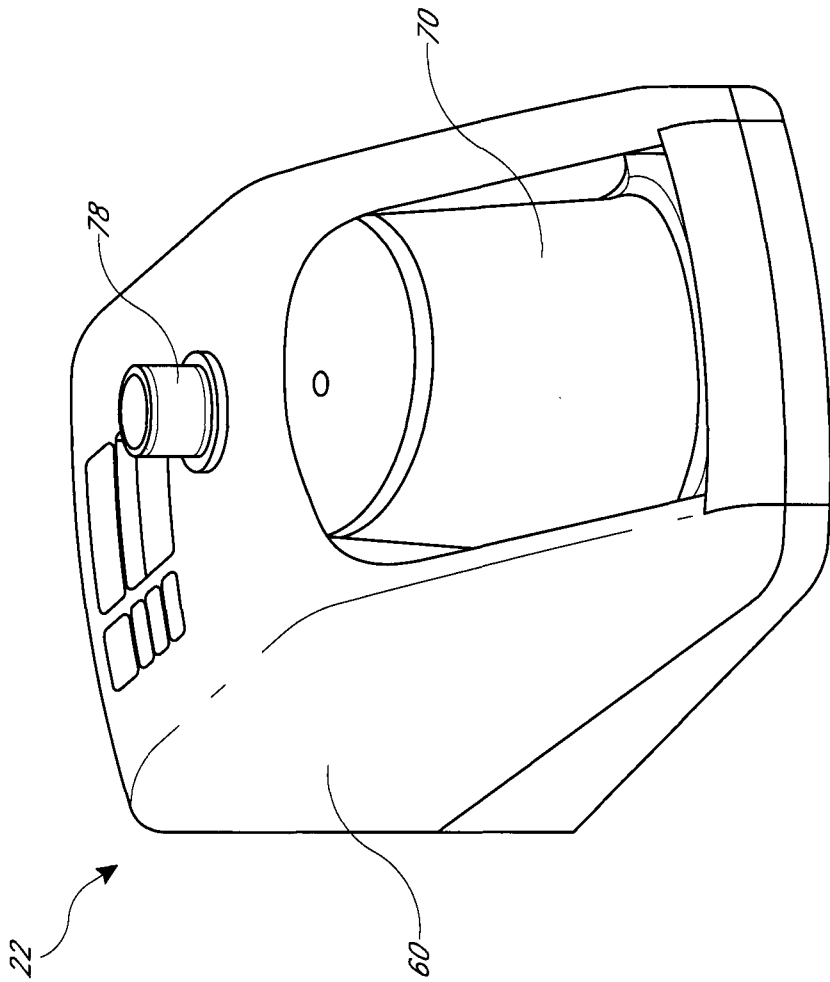

FIG. 3

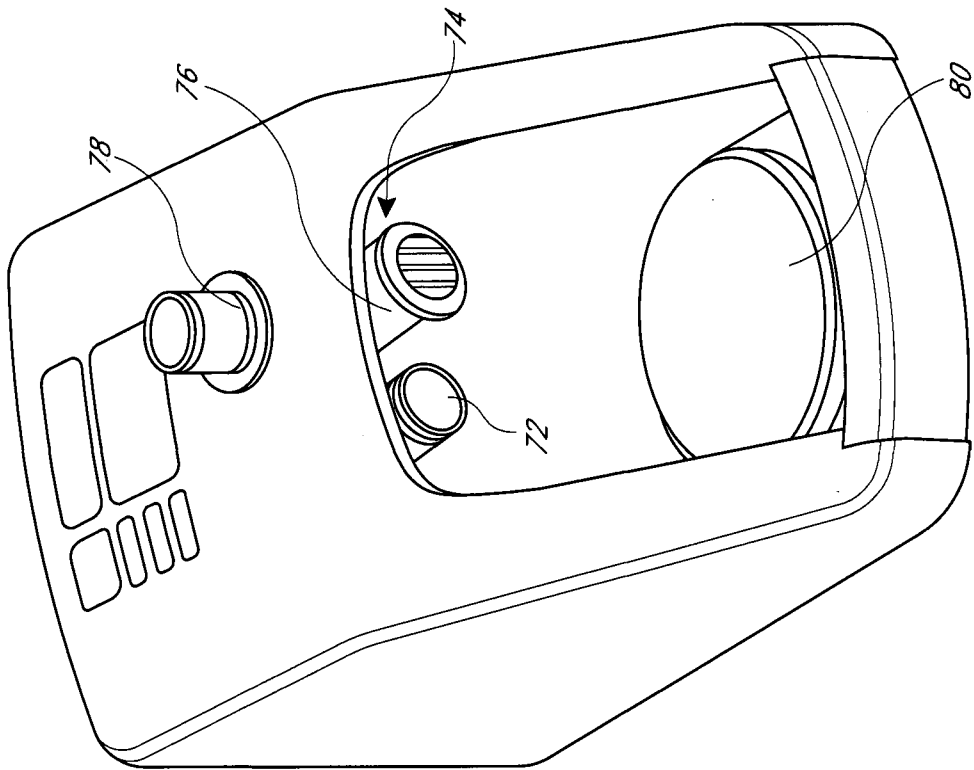

FIG. 4

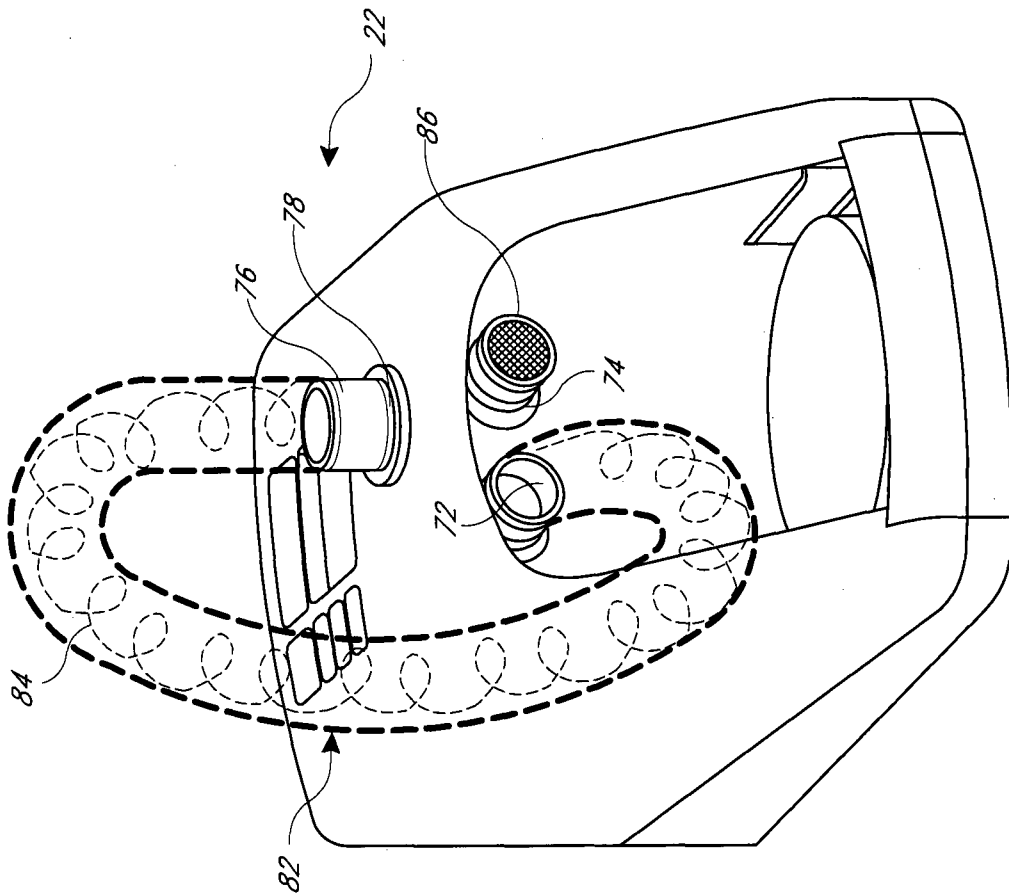

FIG. 5

6/21

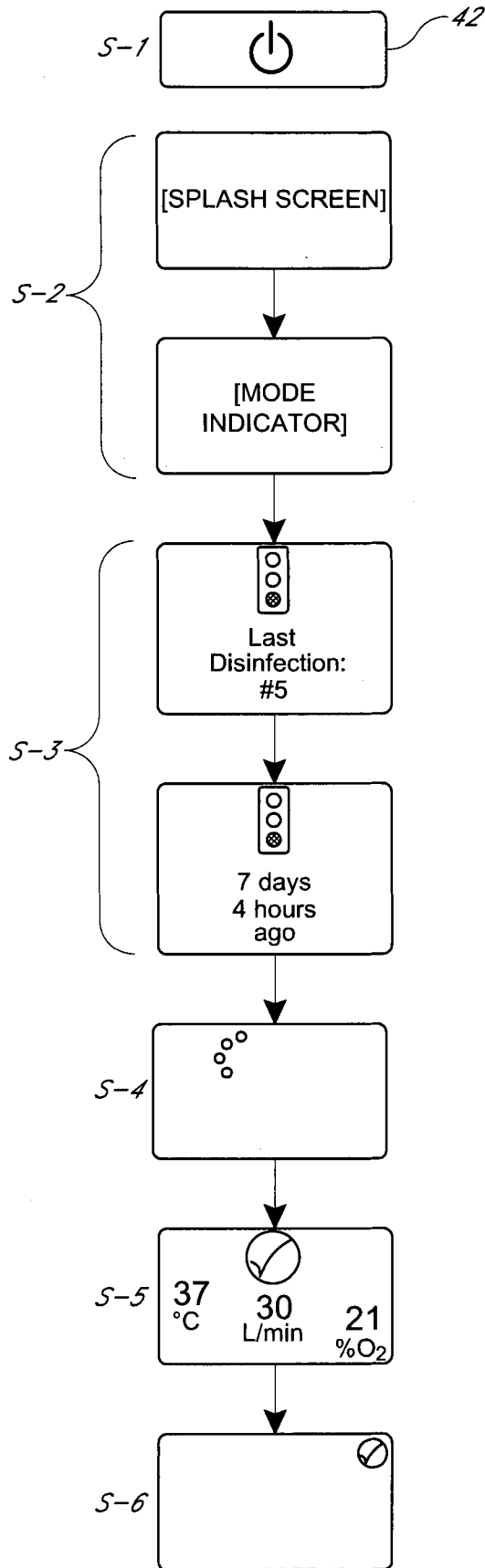
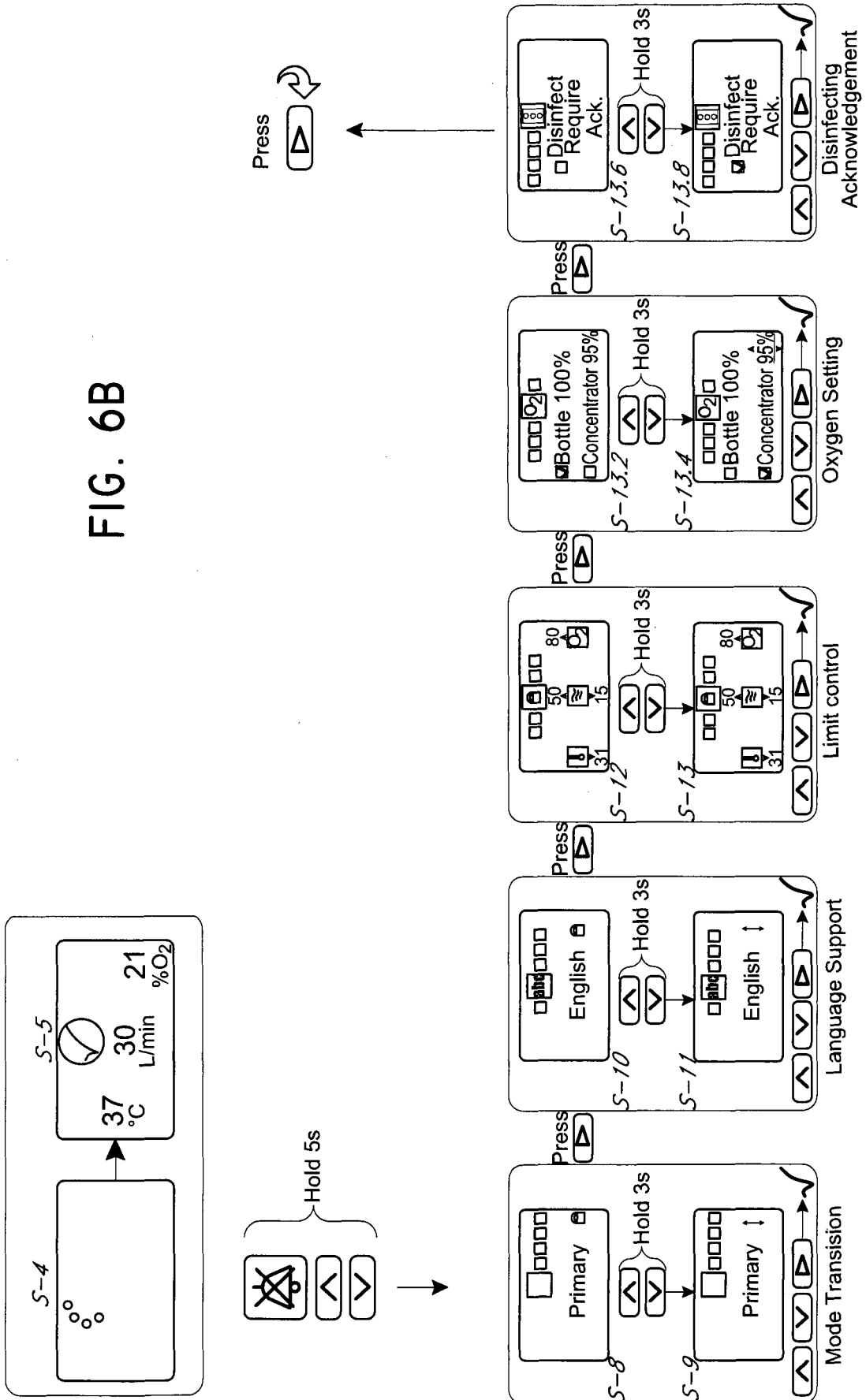

FIG. 6A

FIG. 6B



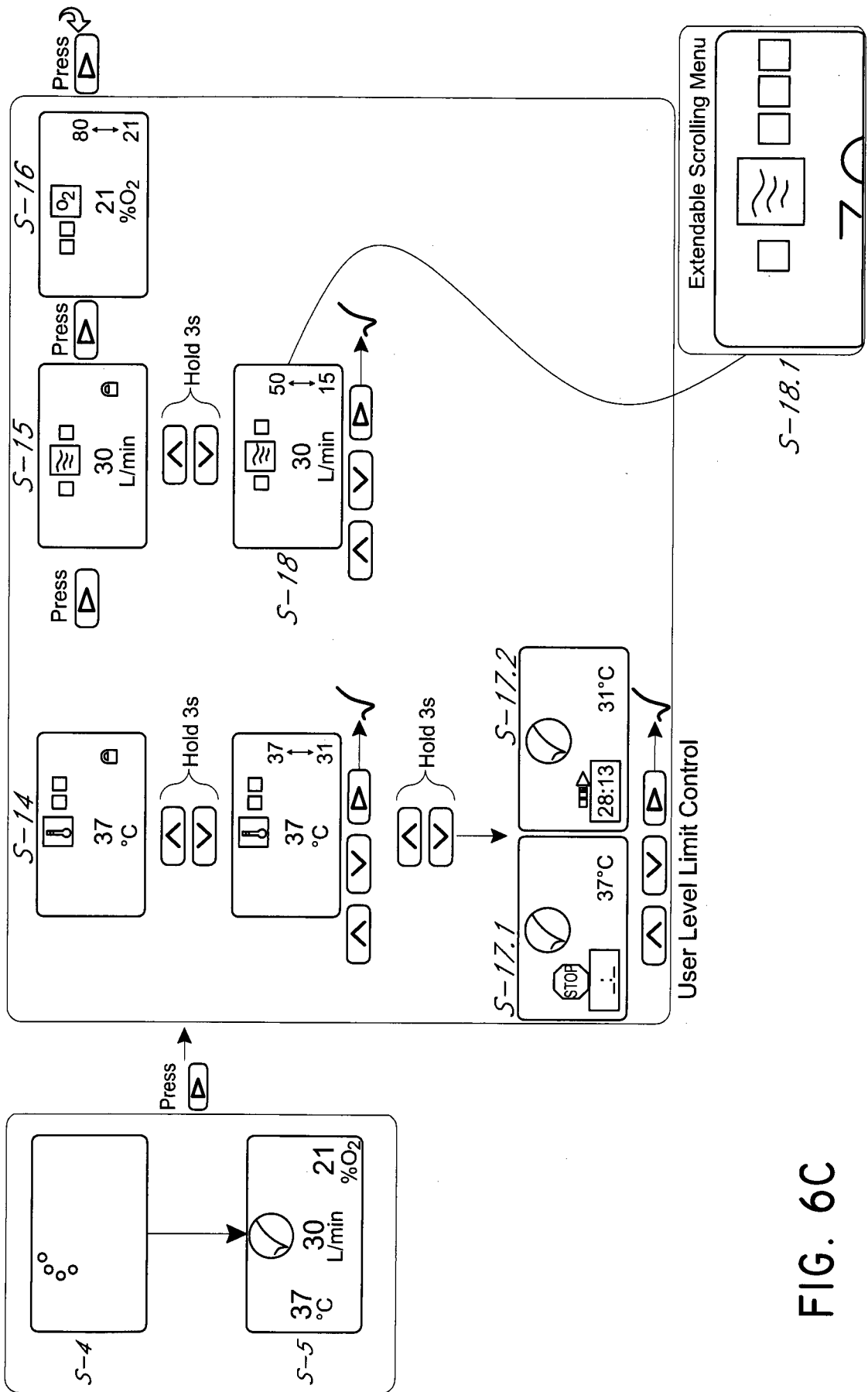
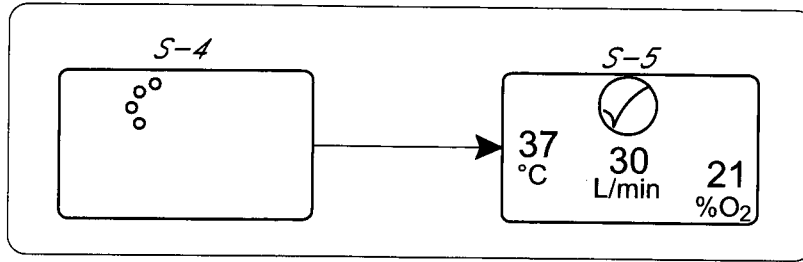

FIG. 6C

9/21



▶ Hold 10s

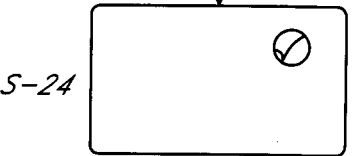
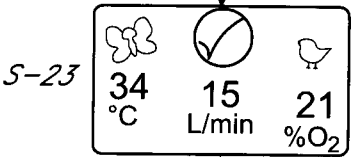
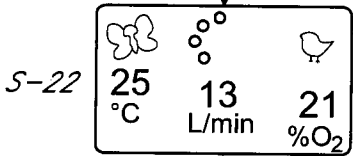
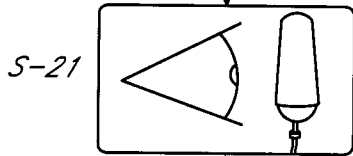
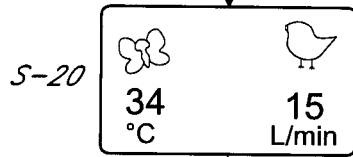
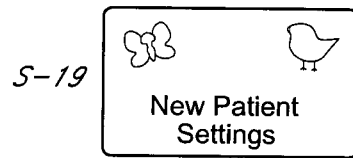
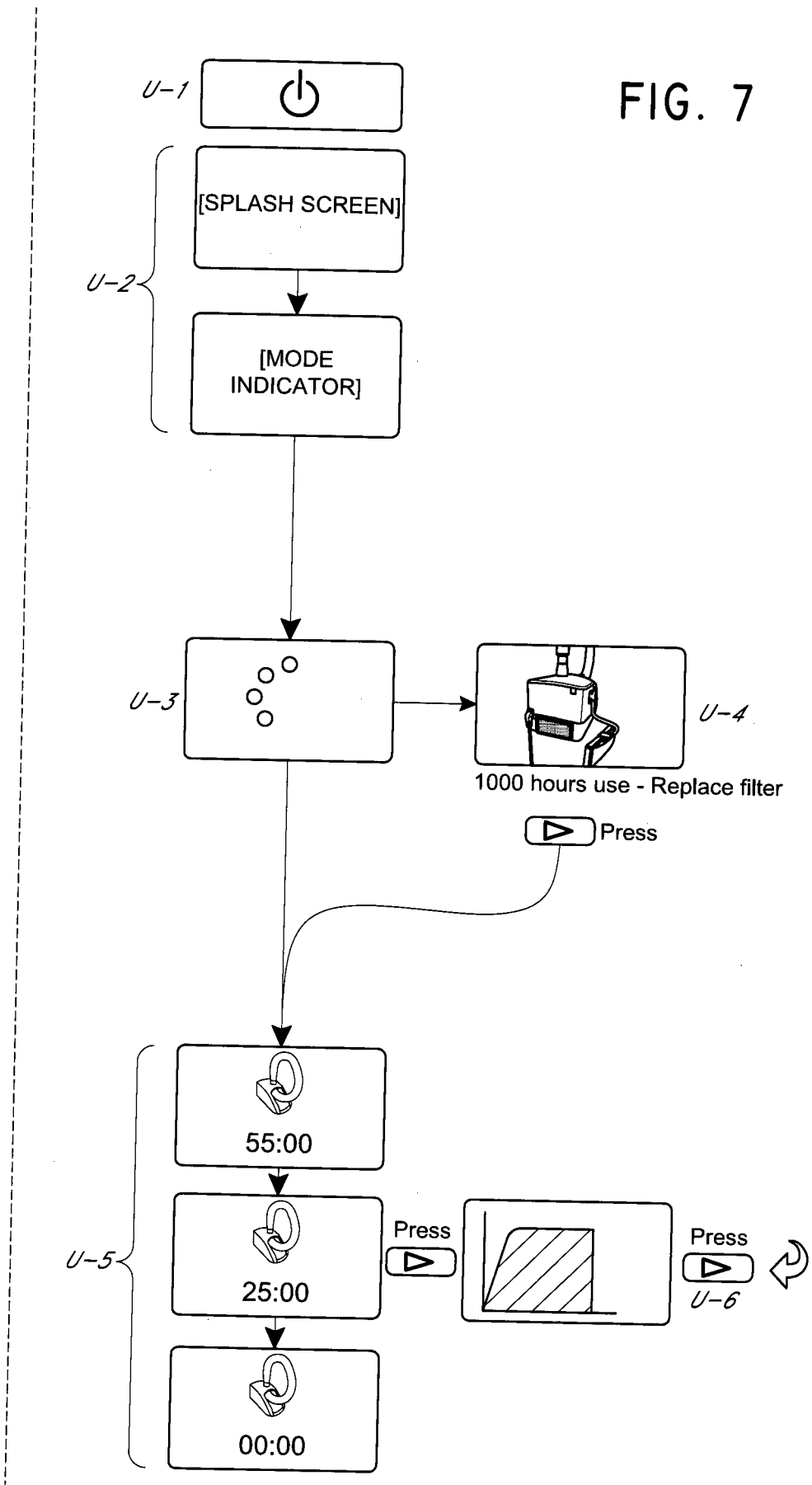

FIG. 6D

FIG. 7



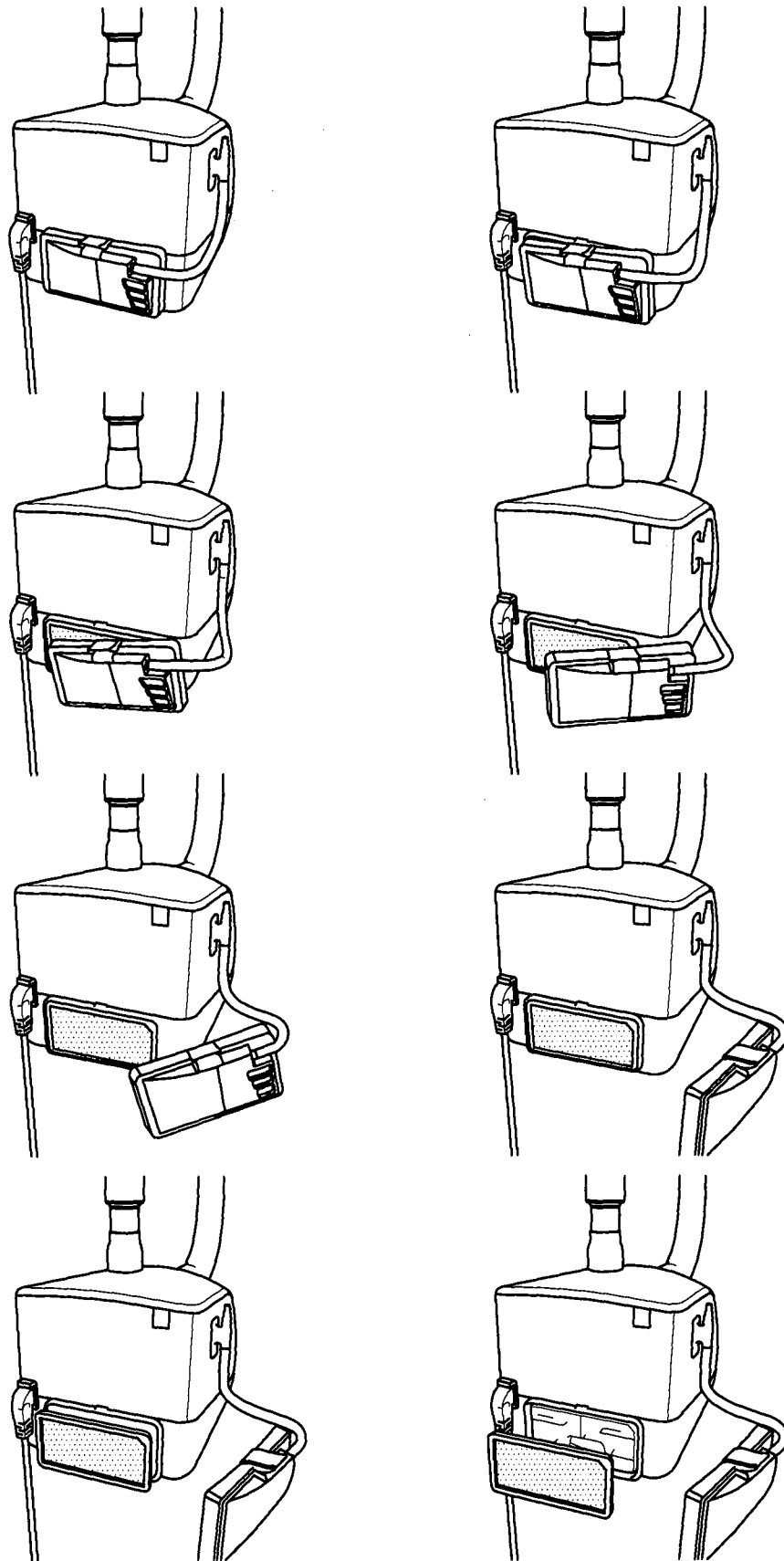

FIG. 8A

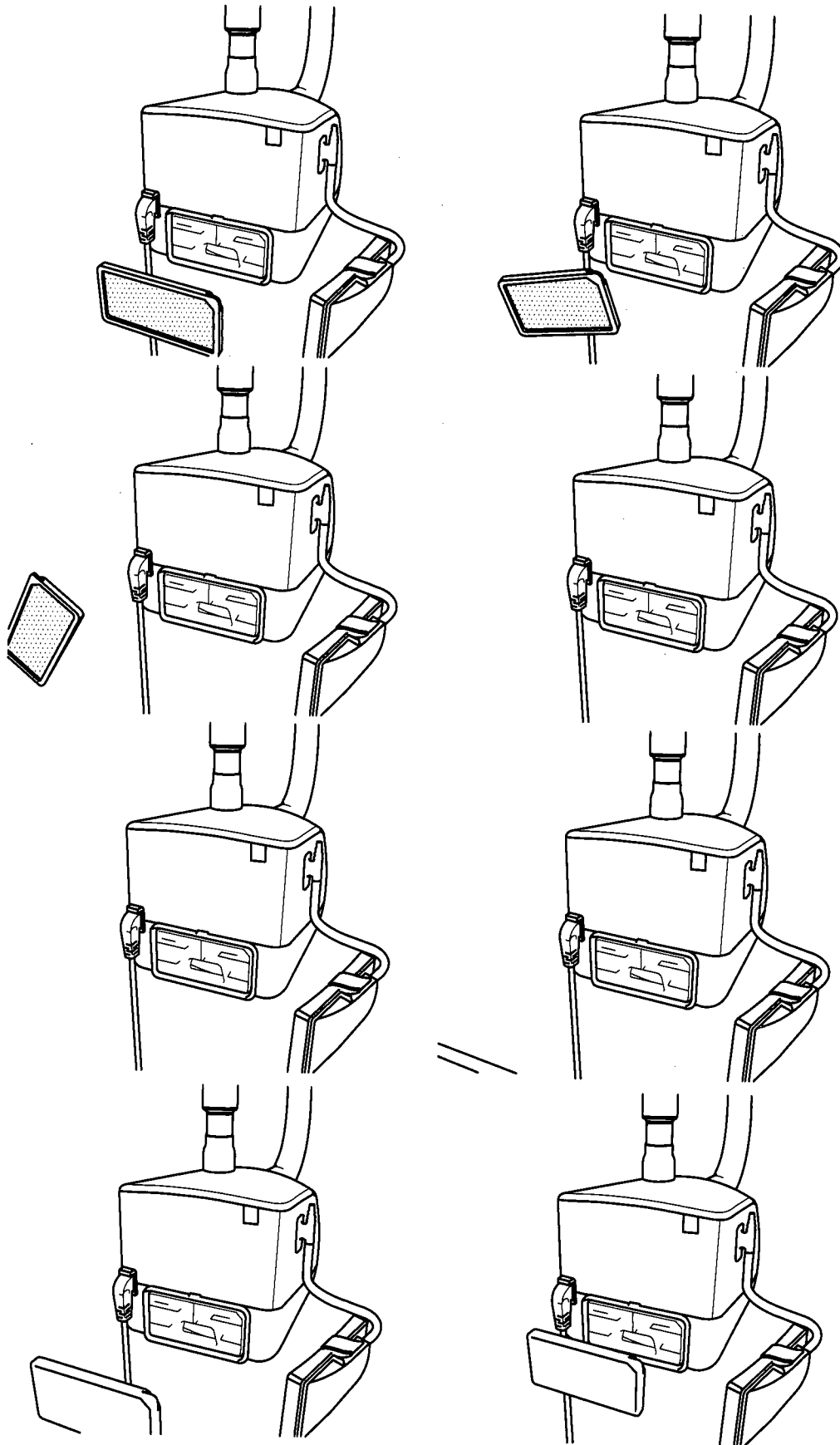

FIG. 8B

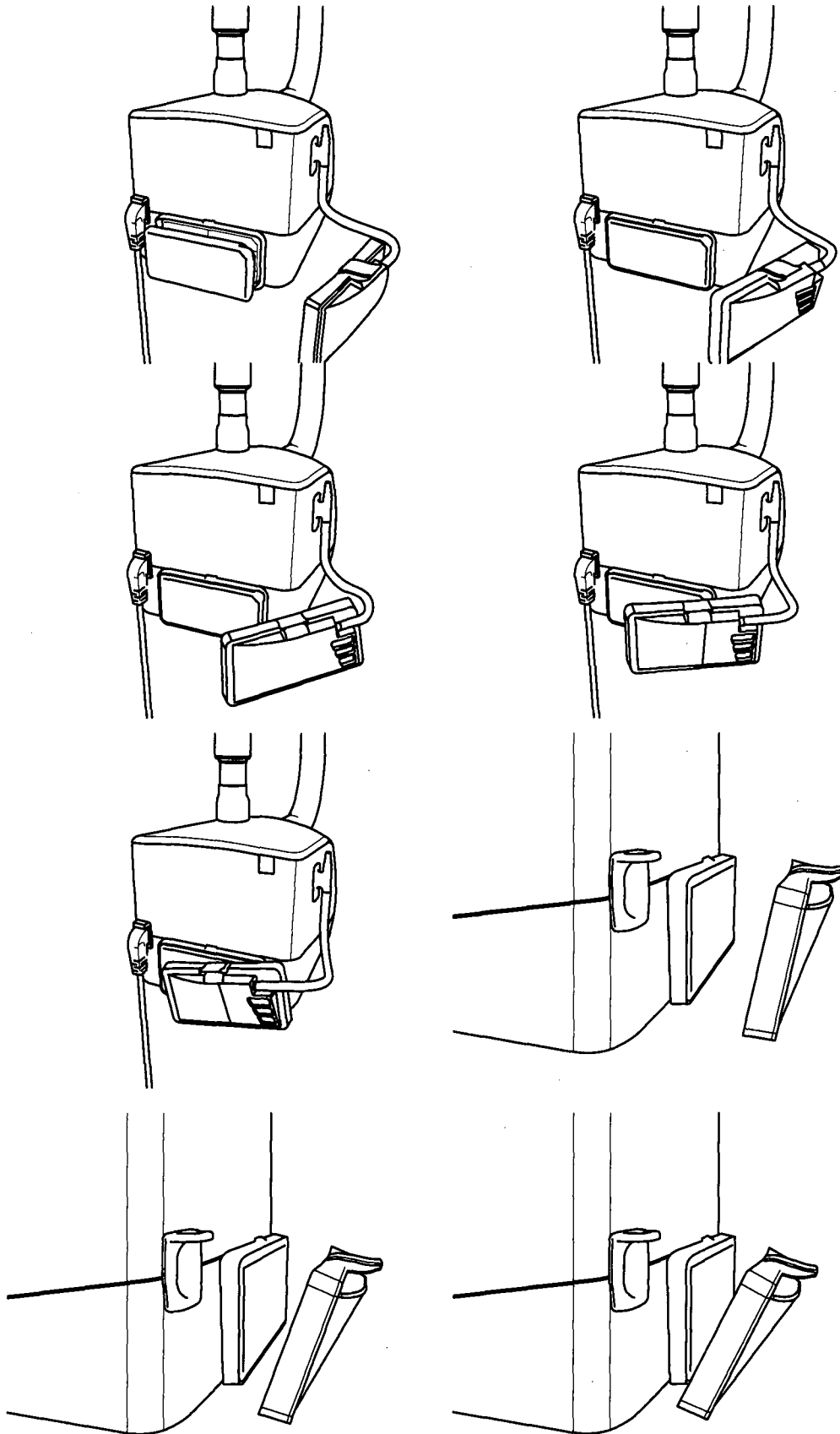

FIG. 8C

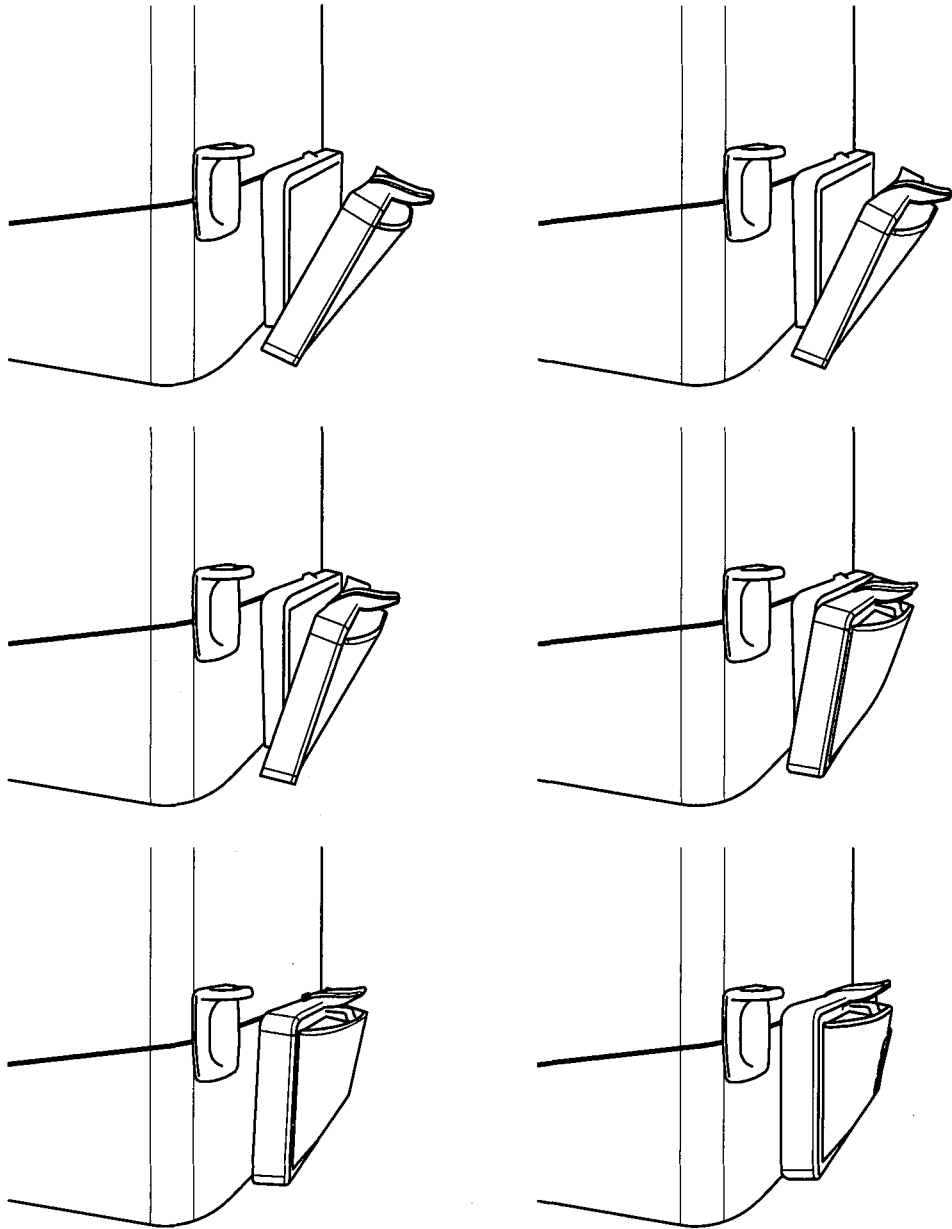

FIG. 8D

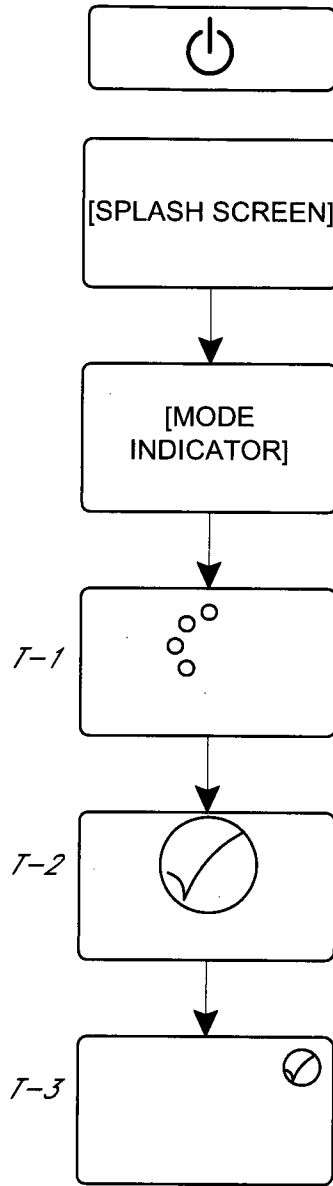

FIG. 9A

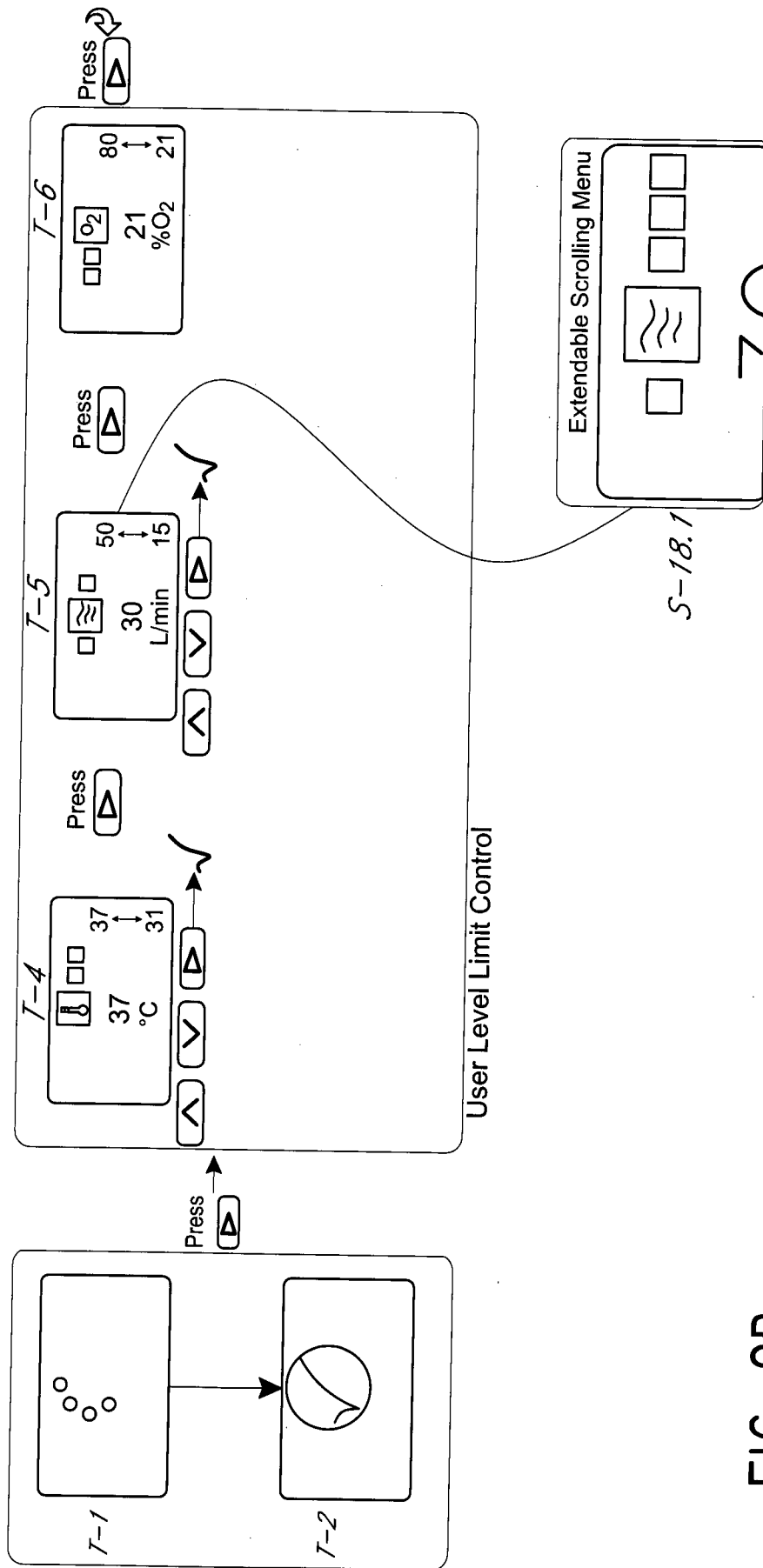
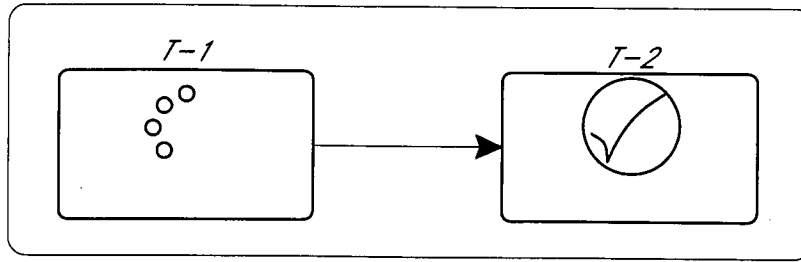

FIG. 9B



 Hold 10s

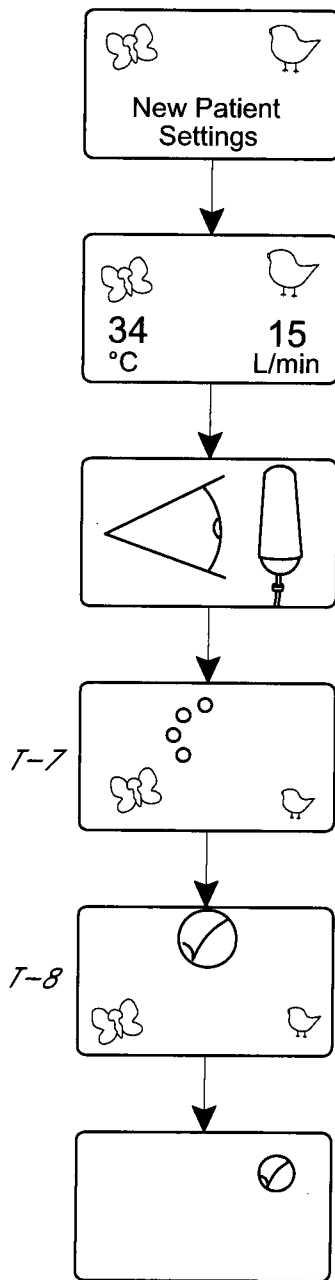

FIG. 9C

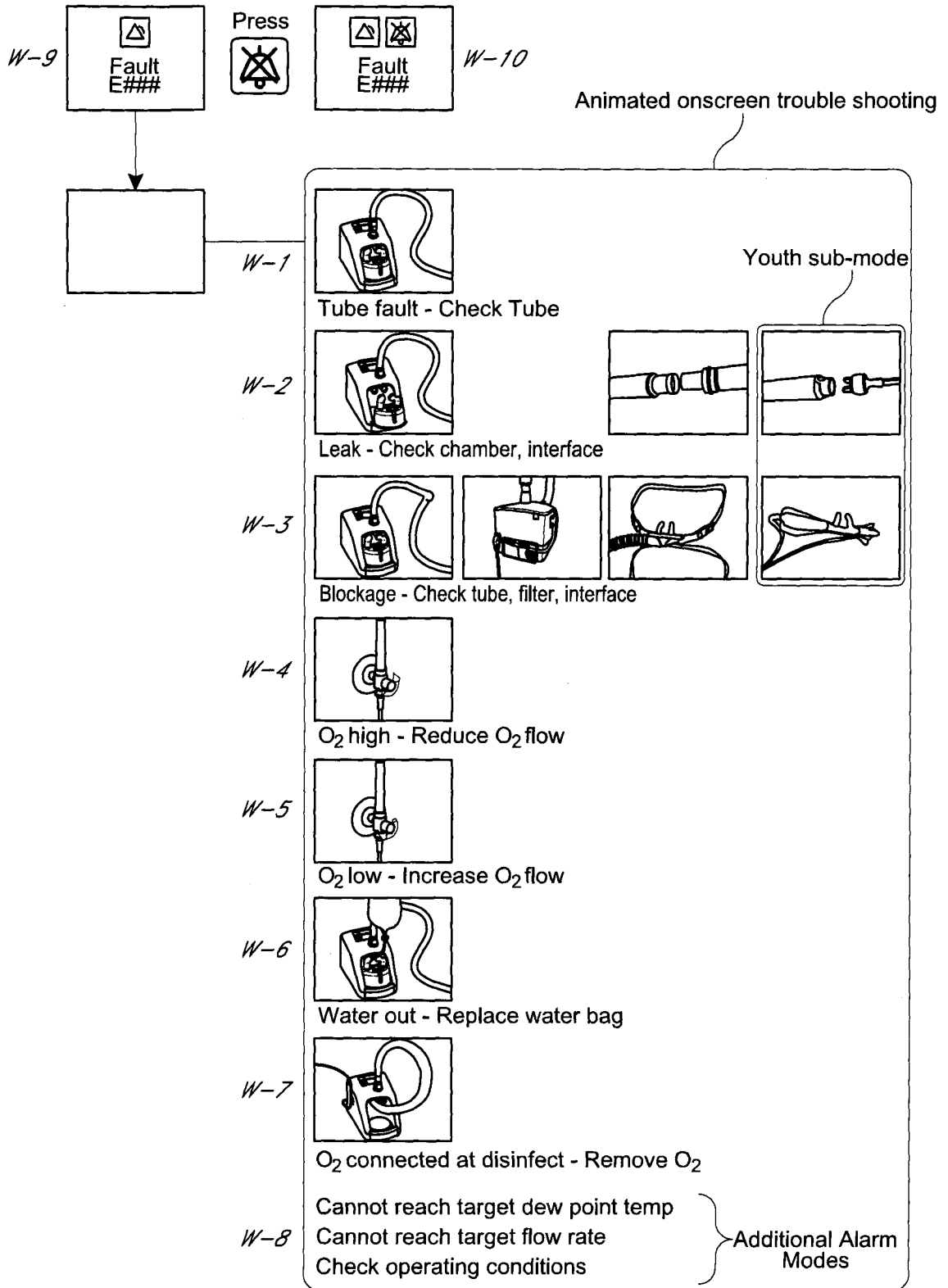

FIG. 10

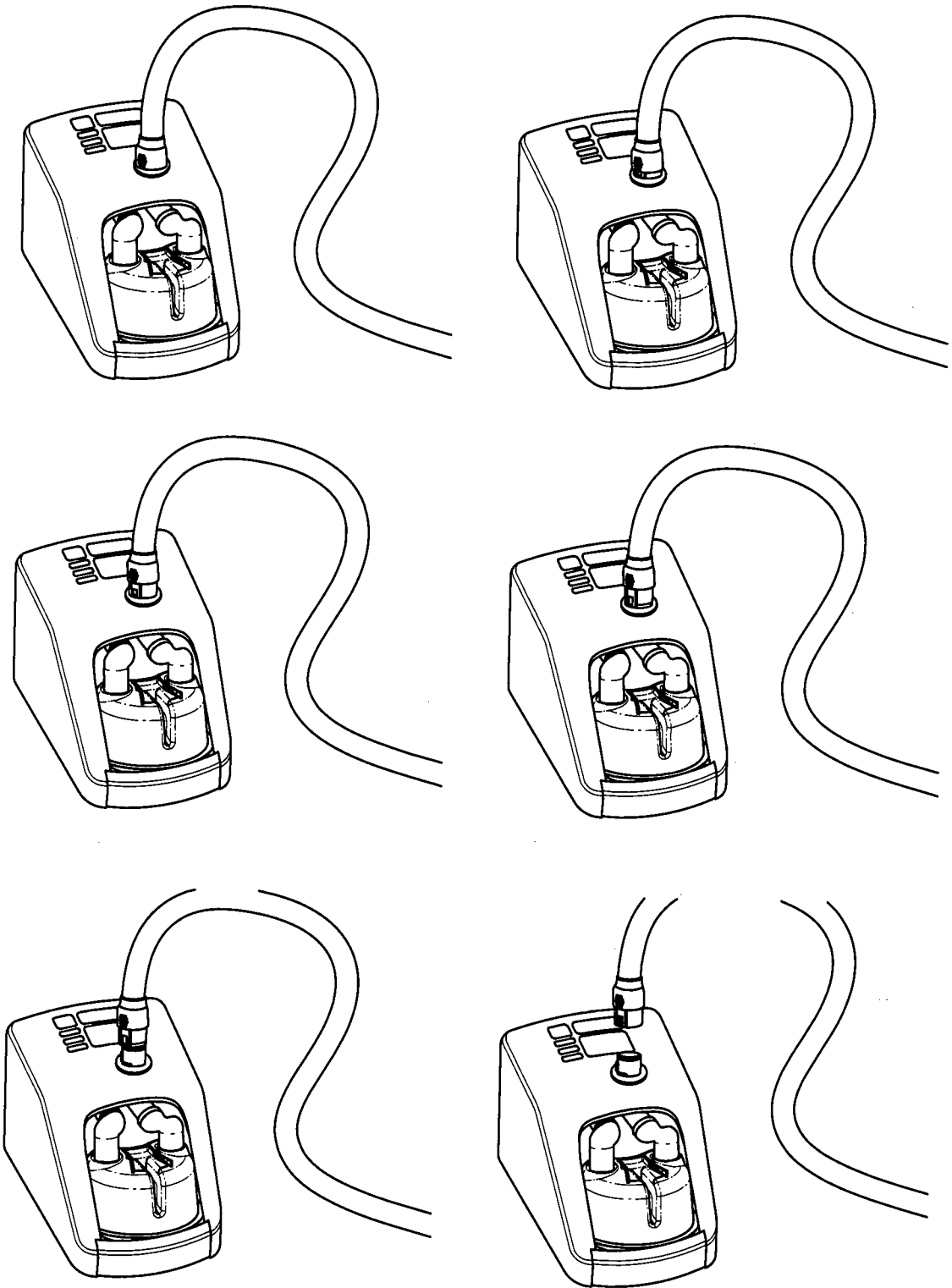

FIG. II

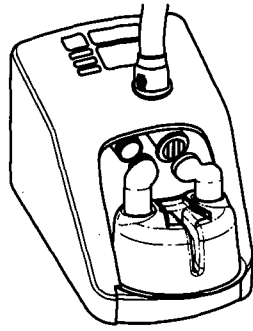

FIG. 12A



FIG. 12B

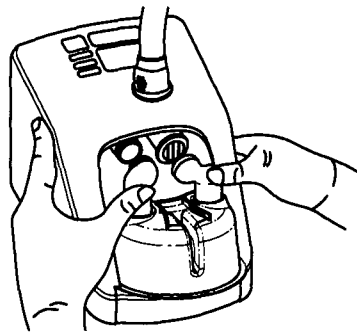

FIG. 12C

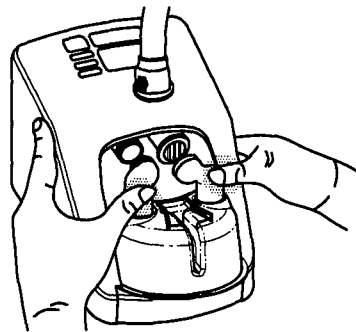

FIG. 12D

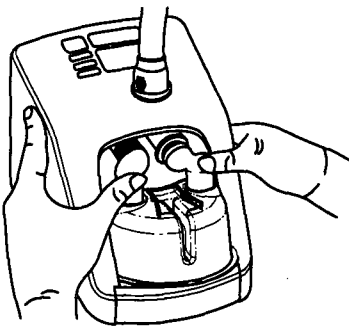

FIG. 12E

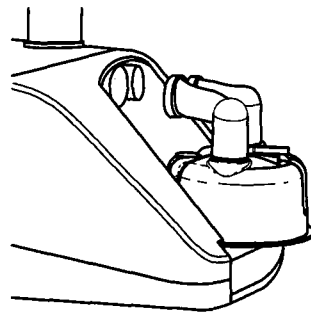

FIG. 12F

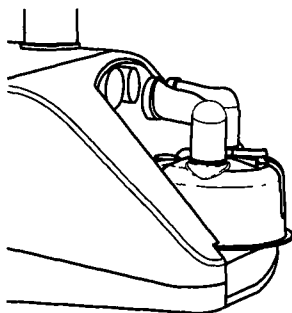

FIG. 12G

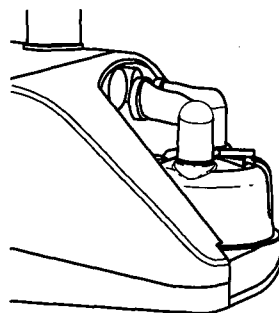

FIG. 12H

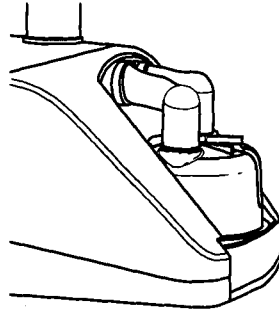

FIG. 12I

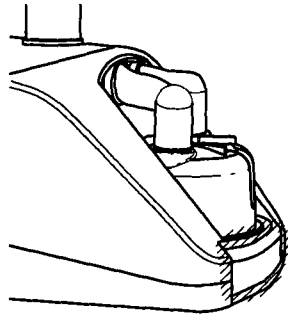

FIG. 12J

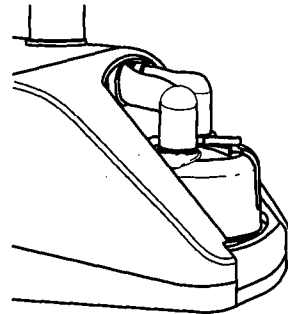

FIG. 12K

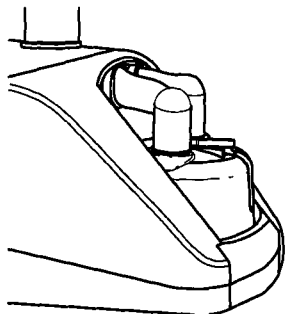

FIG. 12L

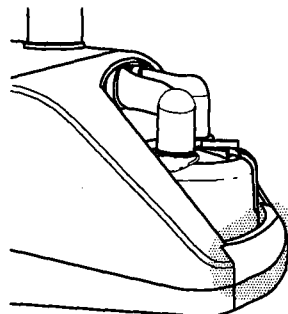

FIG. 12M

