



(12) **United States Design Patent**
Roney et al.

(10) **Patent No.:** **US D900,886 S**
(45) **Date of Patent:** **** Nov. 3, 2020**

(54) **ROW UNIT CROP GUIDES**
(71) Applicant: **DEERE & COMPANY**, Moline, IL (US)
(72) Inventors: **Matthew C. Roney**, Ankeny, IA (US);
Charles F. Ostermeier, Slater, IA (US);
Joel M. Schreiner, Saddlebrooke, MO (US)
(73) Assignee: **DEERE & COMPANY**, Moline, IL (US)
(**) Term: **15 Years**

6,564,536 B1 * 5/2003 Hoffer A01D 41/147
56/119
7,516,603 B2 * 4/2009 Bennett A01D 46/08
56/33
8,635,842 B2 * 1/2014 Markt A01D 45/00
56/15.2

(Continued)

Primary Examiner — Mark A Goodwin
(74) *Attorney, Agent, or Firm* — Taft Stettinius & Hollister LLP; Stephen F. Rost

(57) **CLAIM**
The ornamental design for row unit crop guides, as shown and described.

(21) Appl. No.: **29/676,825**
(22) Filed: **Jan. 15, 2019**
(51) **LOC (12) Cl.** **15-03**
(52) **U.S. Cl.**
USPC **D15/28**
(58) **Field of Classification Search**
USPC D15/10-33; 56/119, 94, DIG. 24
CPC A01D 45/021; A01D 45/02; A01D 45/00;
A01D 75/00
See application file for complete search history.

DESCRIPTION

FIG. 1 is a front, right perspective view of a first embodiment of row unit crop guides shown according to the present design;
FIG. 2 is a rear, left perspective view thereof;
FIG. 3 is a front end view thereof;
FIG. 4 is a rear end view thereof;
FIG. 5 is a left side elevational view thereof;
FIG. 6 is a right side elevational view thereof;
FIG. 7 is a top plan view thereof;
FIG. 8 is a bottom plan view thereof;
FIG. 9 is a front, right perspective view of a second embodiment of row unit crop guides shown according to the present design;
FIG. 10 is a rear, left perspective view thereof;
FIG. 11 is a front end view thereof;
FIG. 12 is a rear end view thereof;
FIG. 13 is a left side elevational view thereof;
FIG. 14 is a right side elevational view thereof;
FIG. 15 is a top plan view thereof; and,
FIG. 16 is a bottom plan view thereof.
The broken line representations in the figures show unclaimed environment or boundaries. The broken line representations thus form no part of the claimed design as filed.

(56) **References Cited**
U.S. PATENT DOCUMENTS
D209,069 S * 10/1967 Markham D15/28
D227,391 S * 6/1973 Lawrence D15/28
4,333,304 A * 6/1982 Greiner A01D 45/021
56/119
5,528,887 A * 6/1996 Nagy A01D 41/147
56/109
5,910,092 A * 6/1999 Bennett A01D 45/021
56/119
5,960,618 A * 10/1999 Kerber A01D 45/021
56/119
6,212,864 B1 * 4/2001 Harden A01D 46/14
56/35

1 Claim, 16 Drawing Sheets

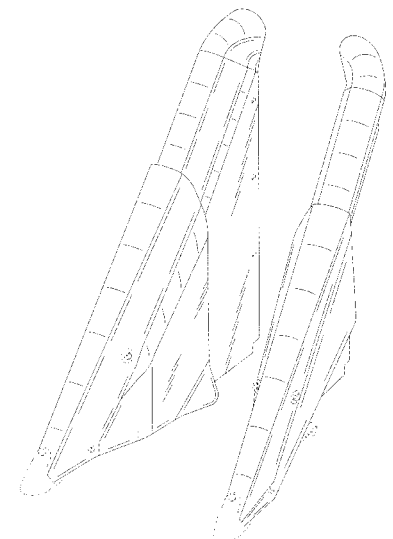

(56)

References Cited

U.S. PATENT DOCUMENTS

8,919,086	B2 *	12/2014	Markt	A01D 45/00	
						56/14.5
9,173,345	B2 *	11/2015	Cressoni	A01D 45/021	
9,210,841	B2 *	12/2015	Lohrentz	A01D 63/00	
9,253,944	B2 *	2/2016	Hulstein	A01D 41/06	
9,615,512	B2 *	4/2017	Allochis	A01D 34/04	
9,801,343	B2 *	10/2017	Markt	A01D 41/14	
10,154,625	B2 *	12/2018	Walker	A01D 41/12	
10,172,288	B2 *	1/2019	Schrattenecker	A01D 41/147	
2006/0174603	A1 *	8/2006	Mossman	A01D 45/021	
						56/314
2009/0308042	A1 *	12/2009	Lovett	A01D 57/20	
						56/153
2016/0324070	A1 *	11/2016	Horning	A01D 45/021	
2019/0335664	A1 *	11/2019	Horning	A01D 43/08	

* cited by examiner

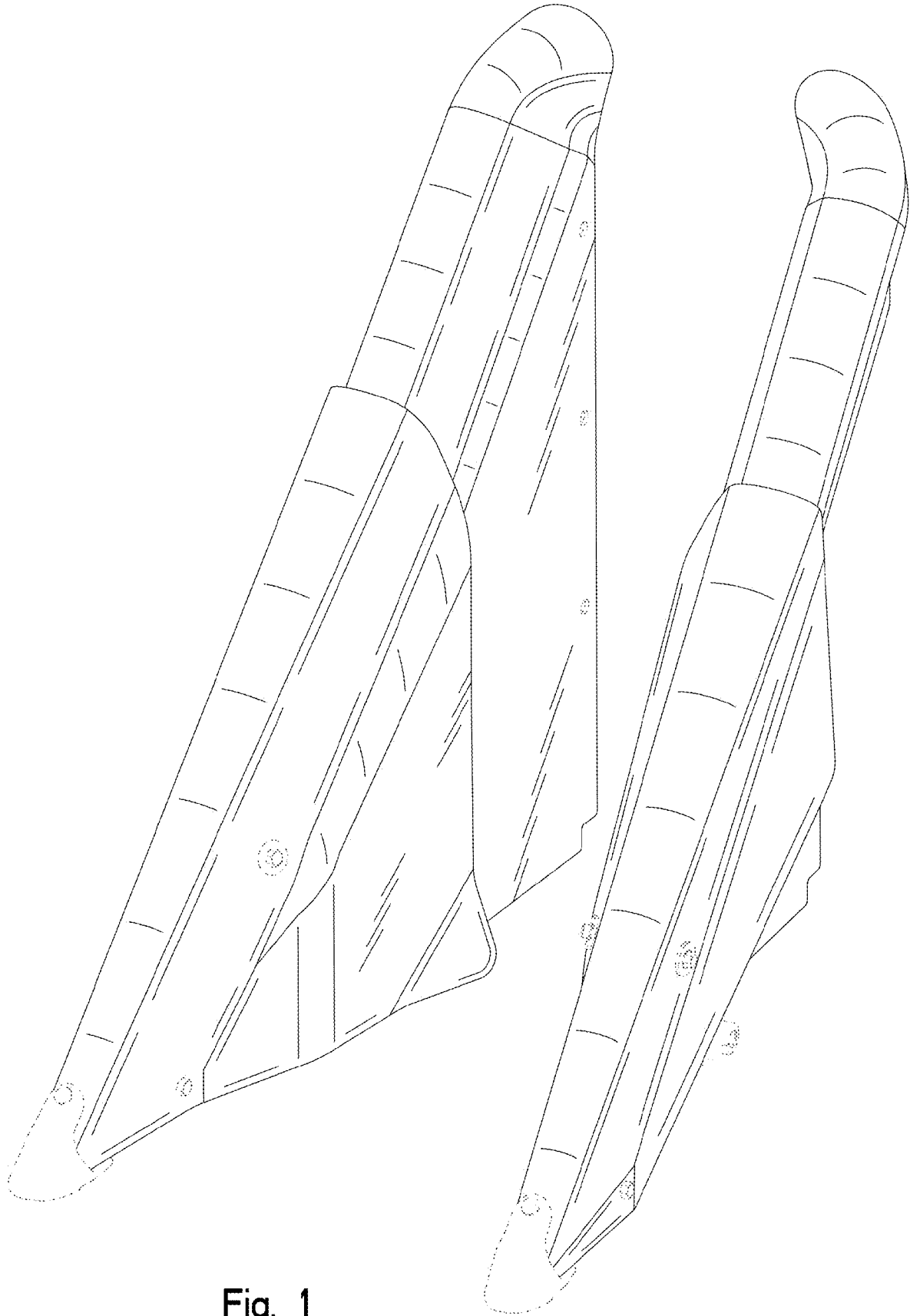

Fig. 1

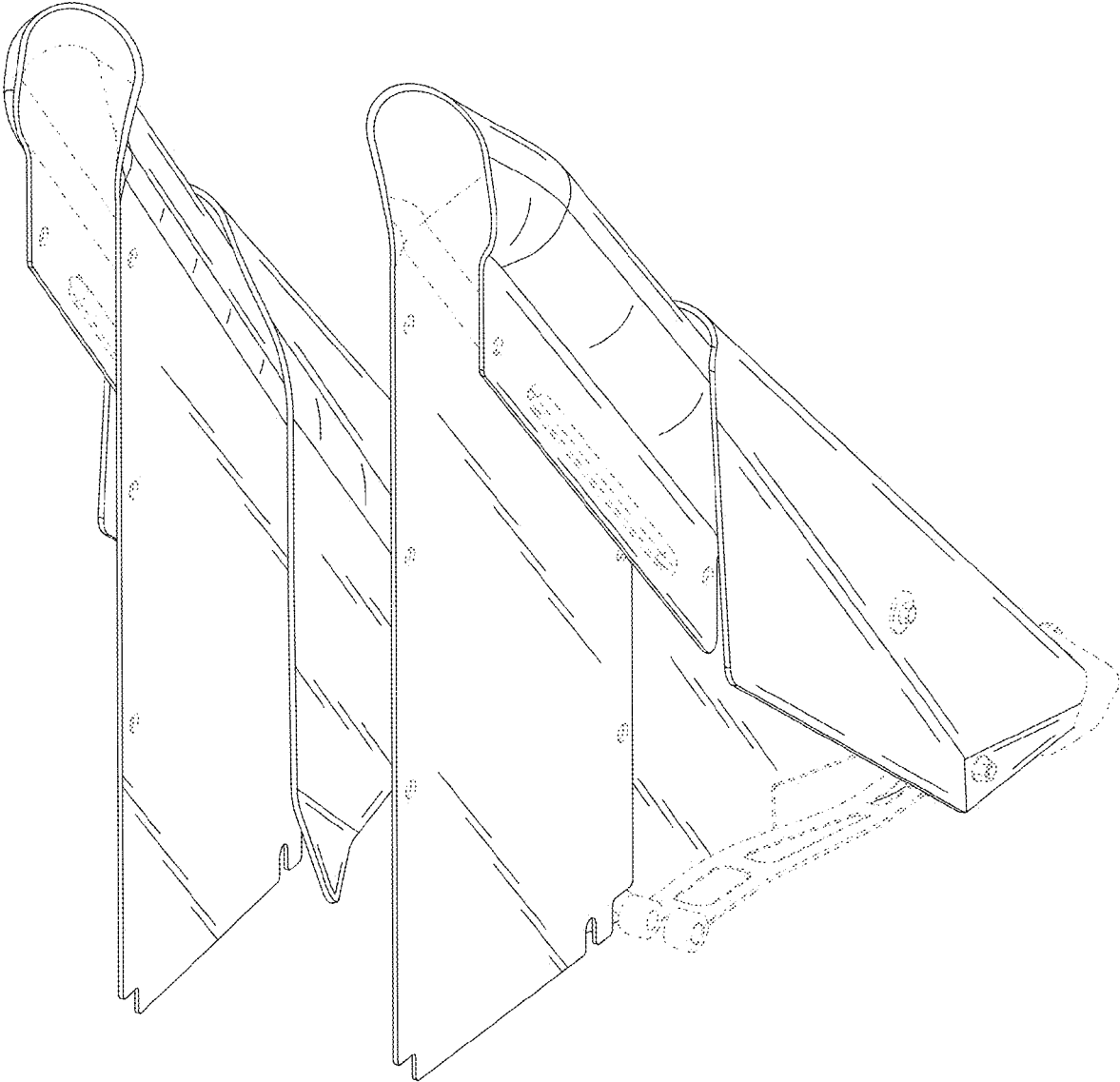

Fig. 2

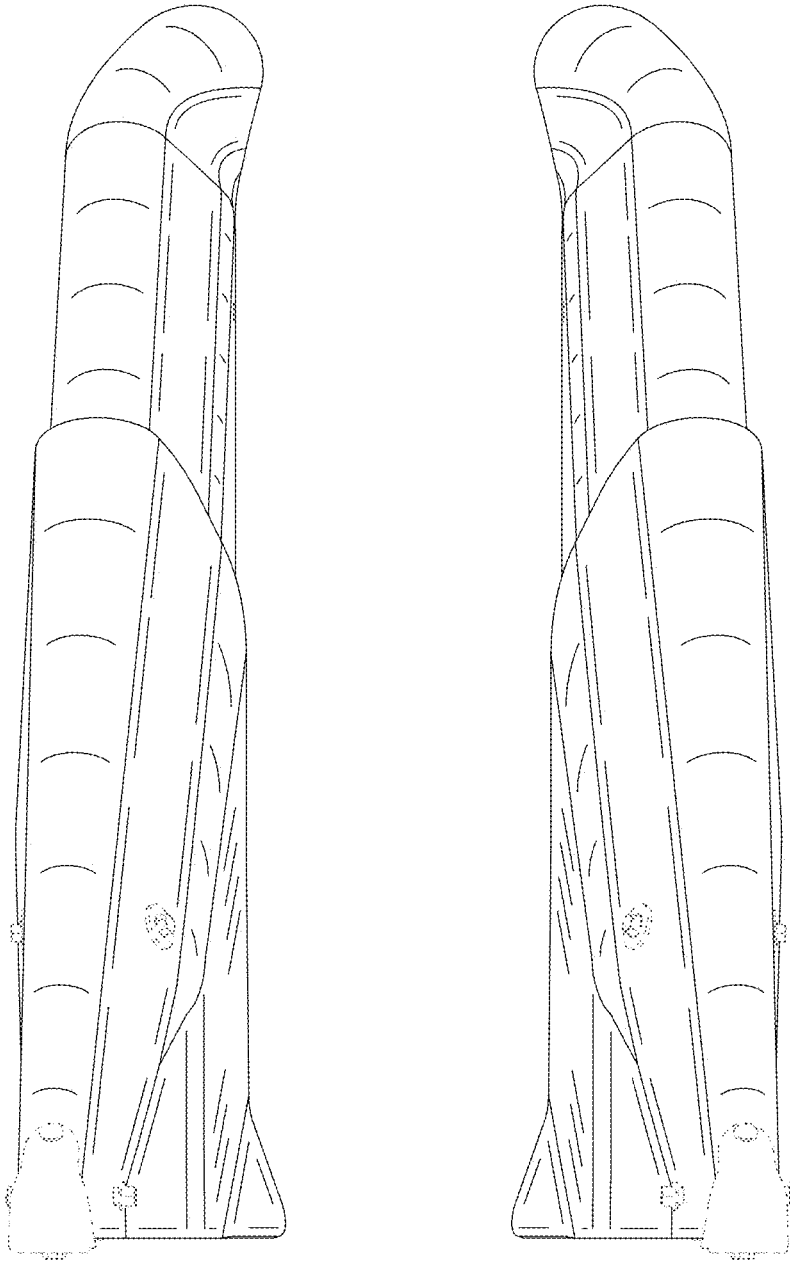

Fig. 3

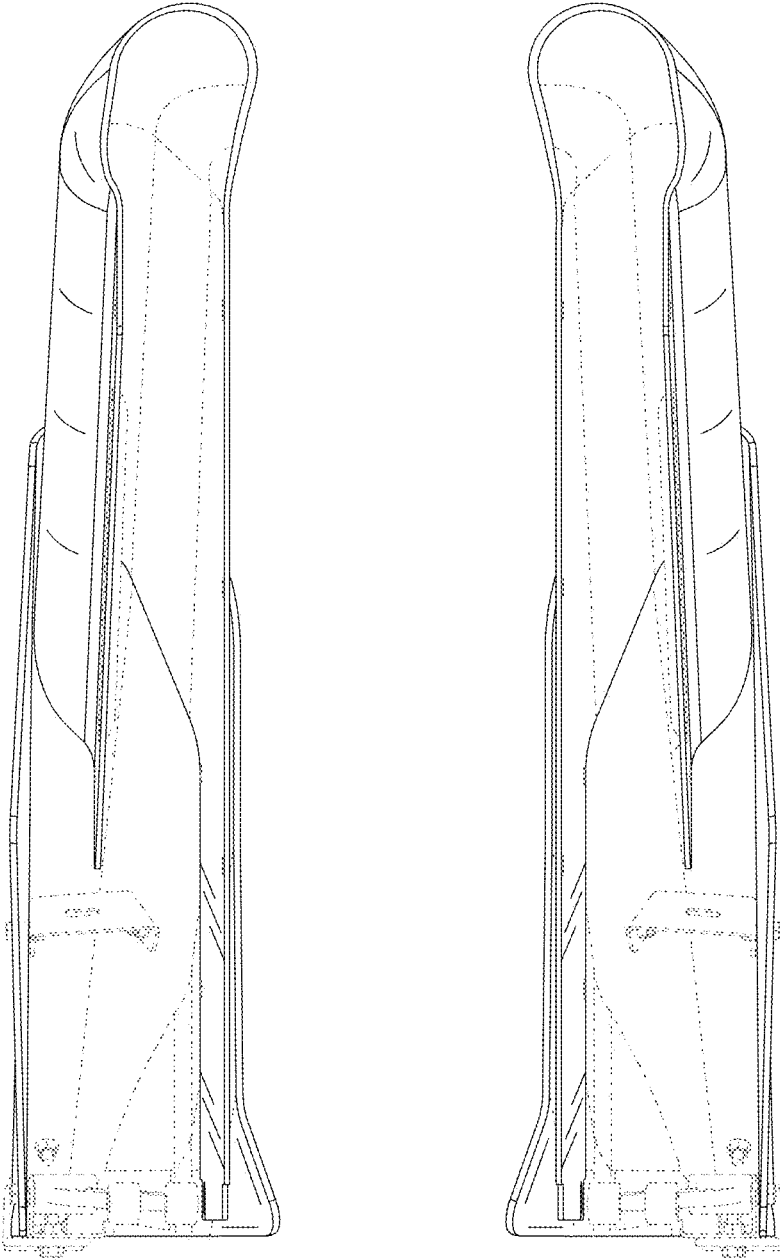

Fig. 4

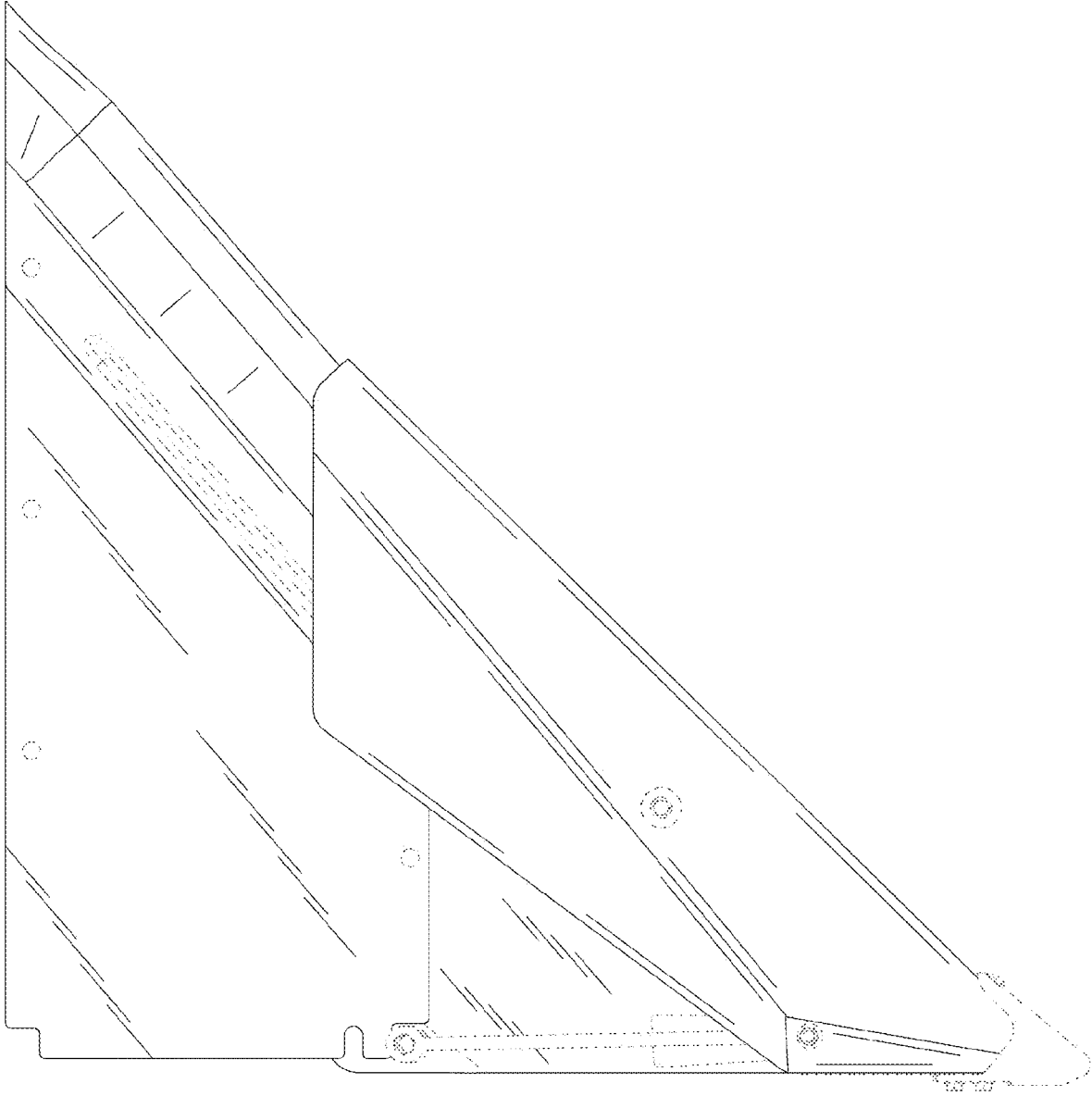

Fig. 5

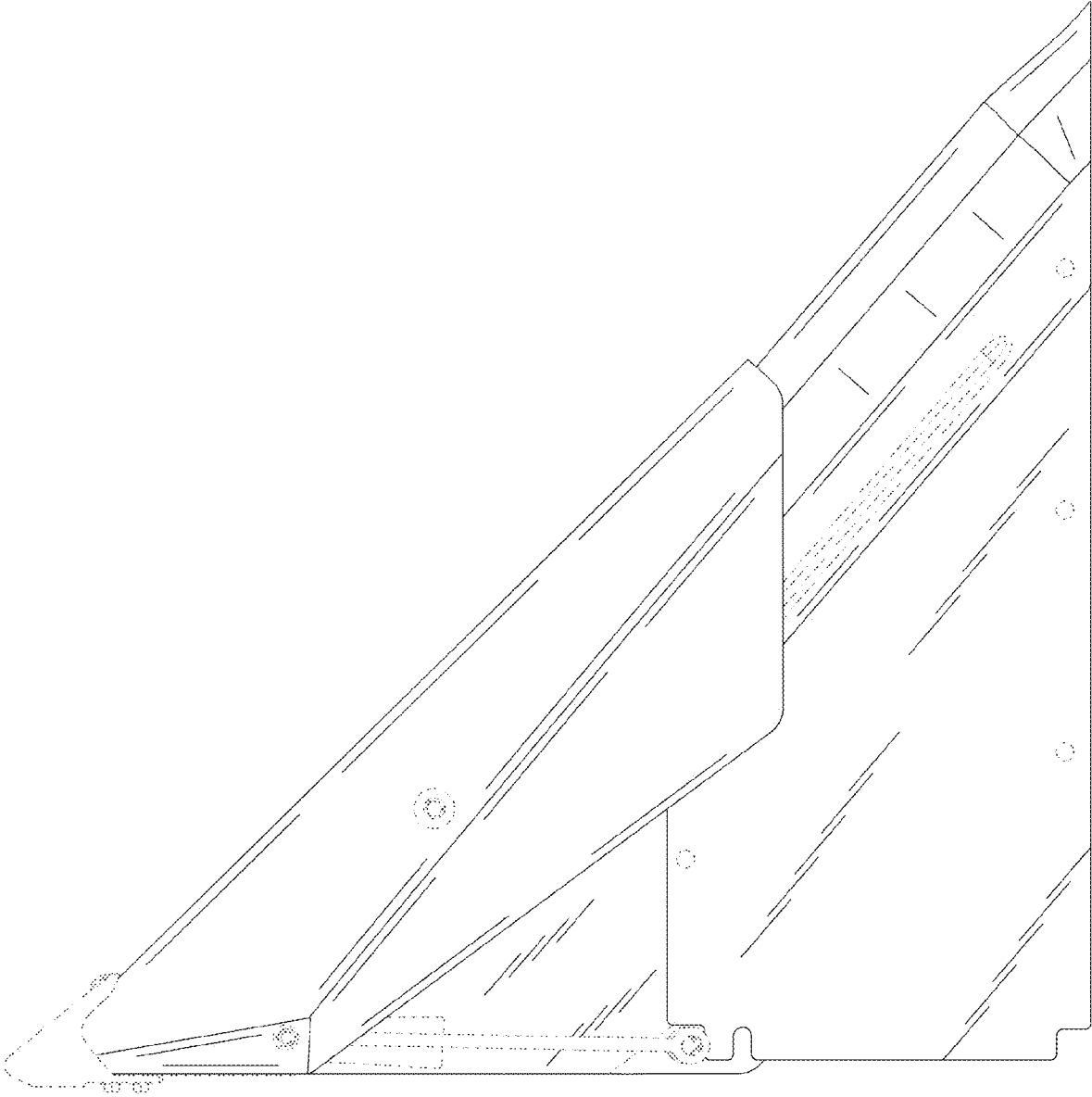

Fig. 6

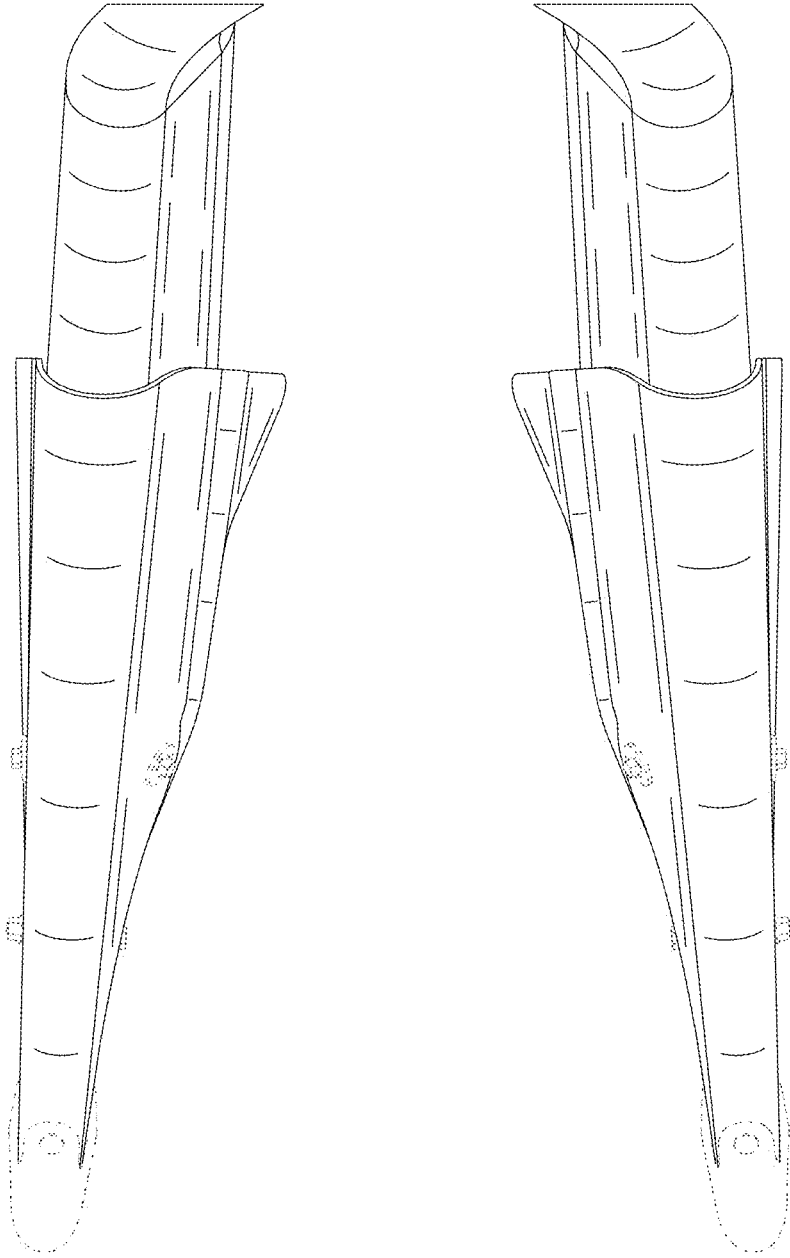

Fig. 7

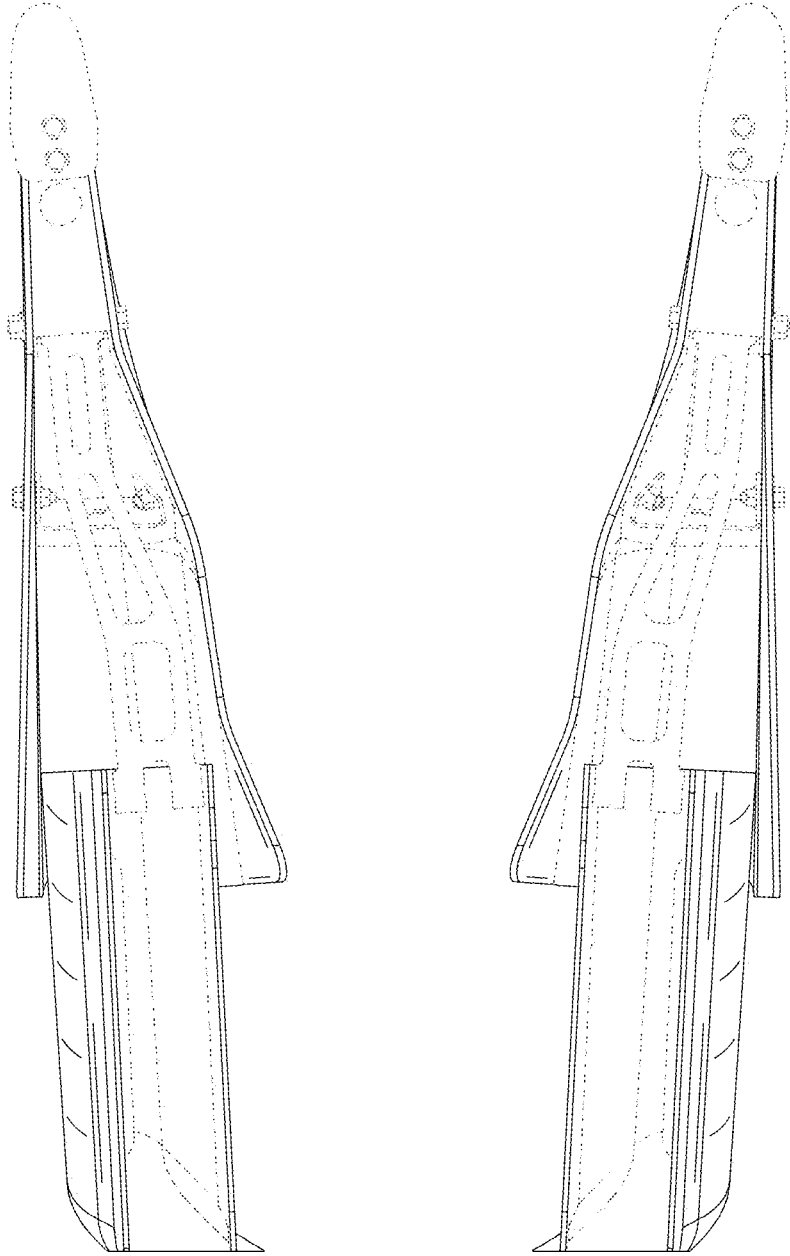

Fig. 8

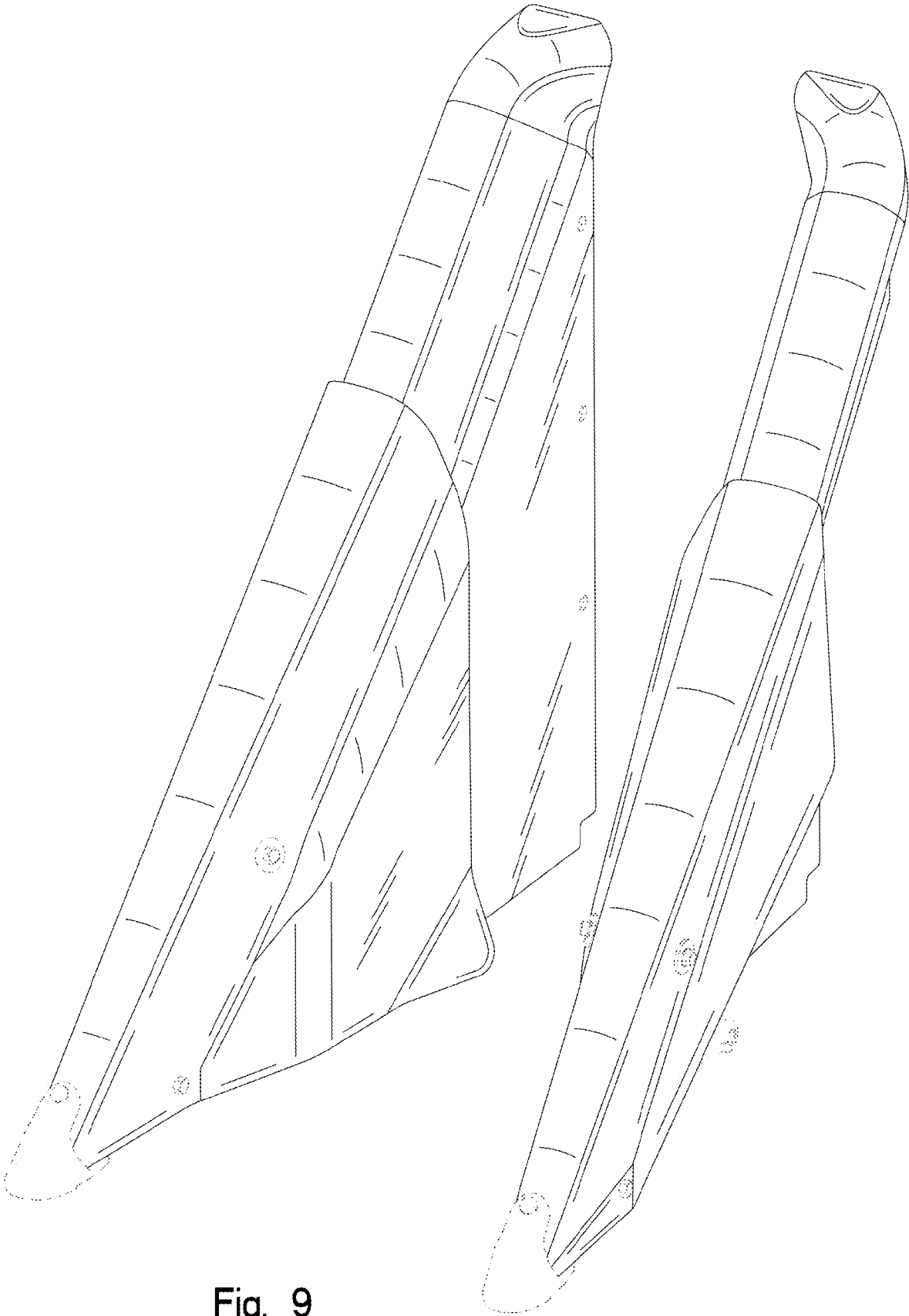

Fig. 9

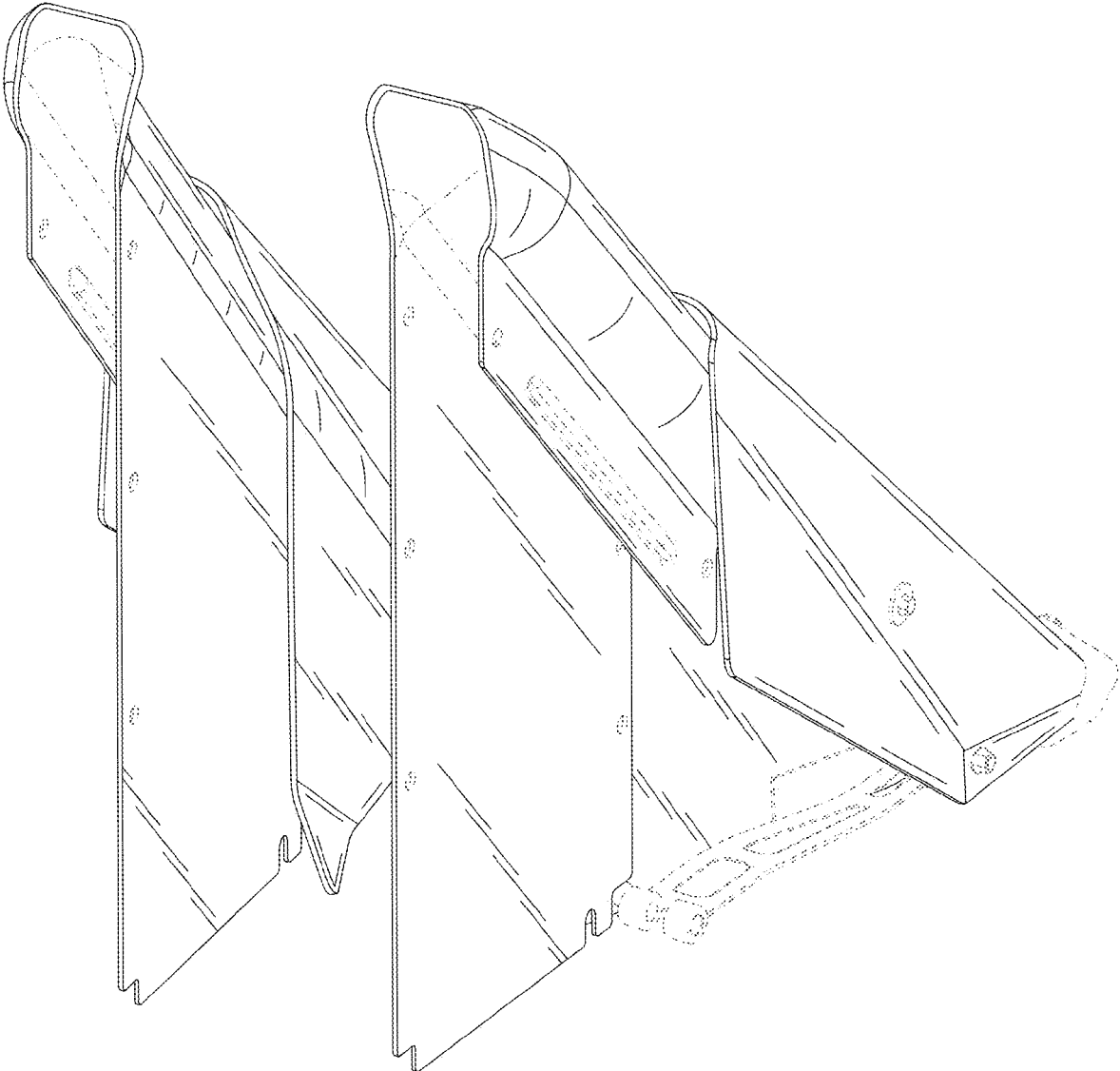

Fig. 10

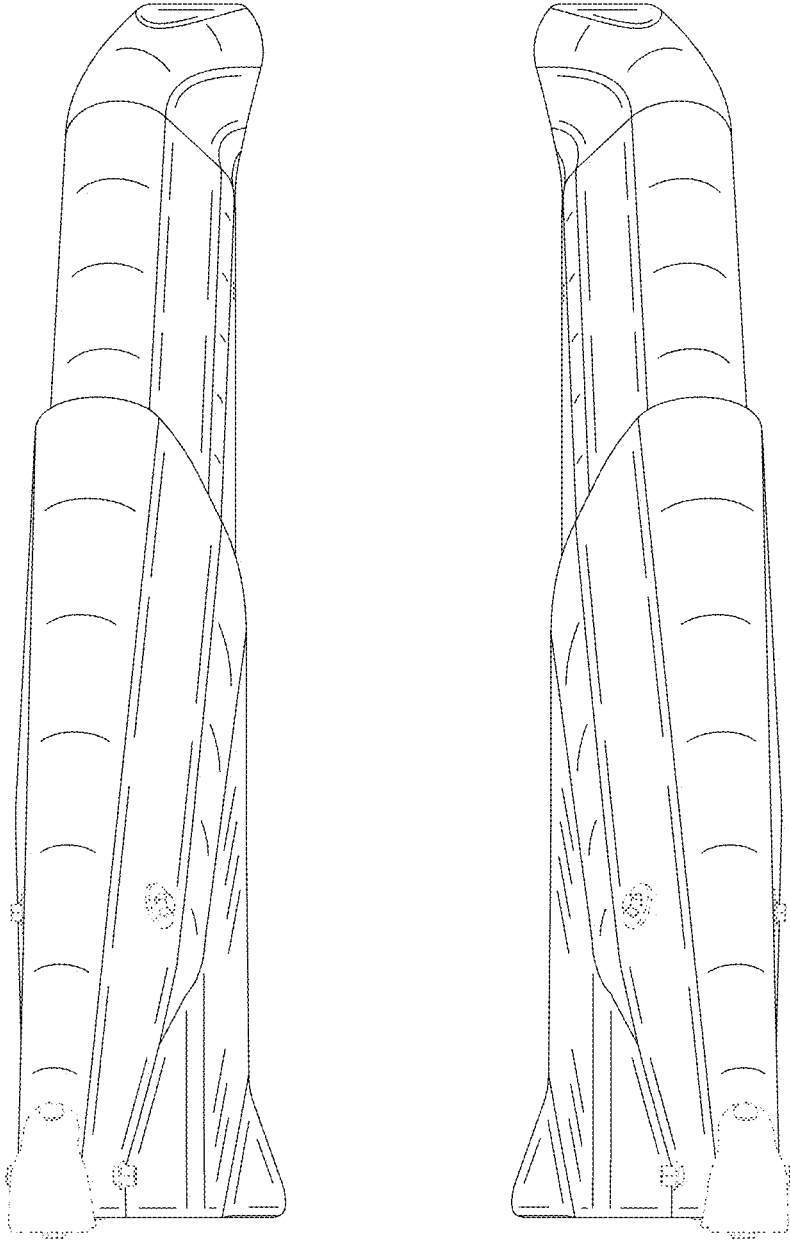

Fig. 11

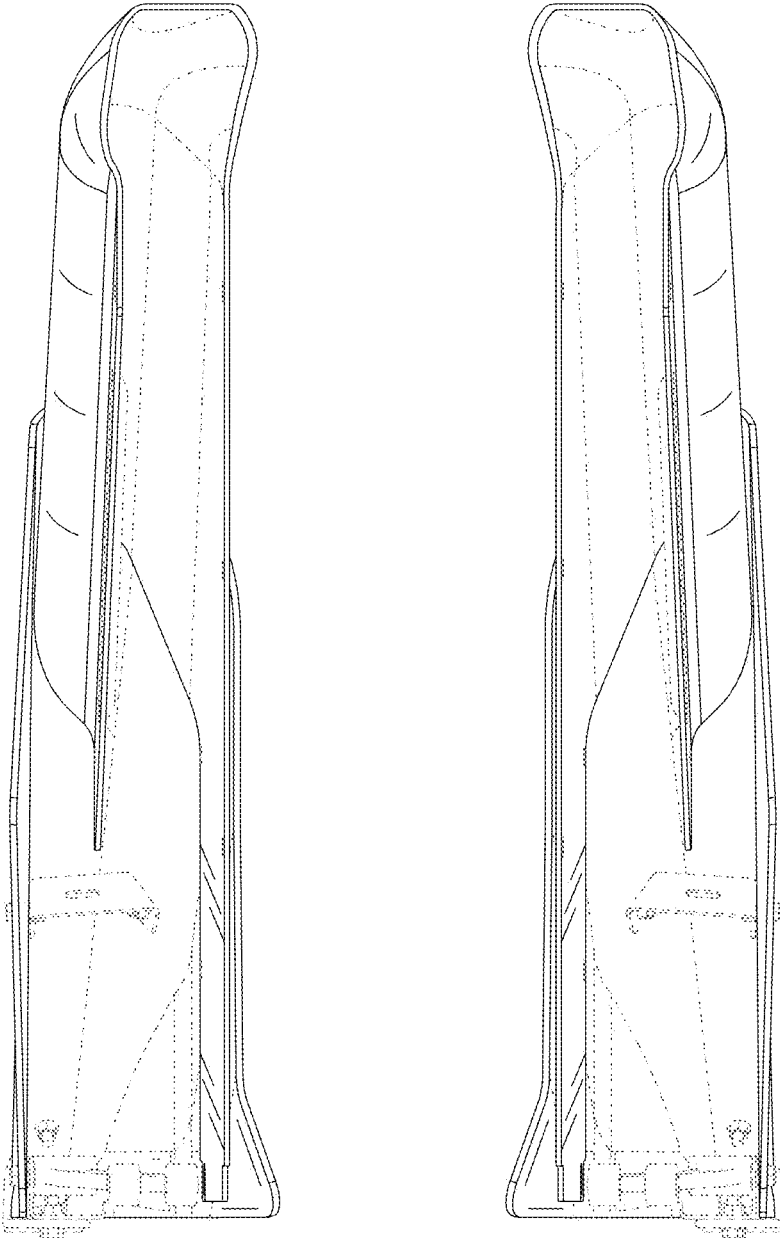

Fig. 12

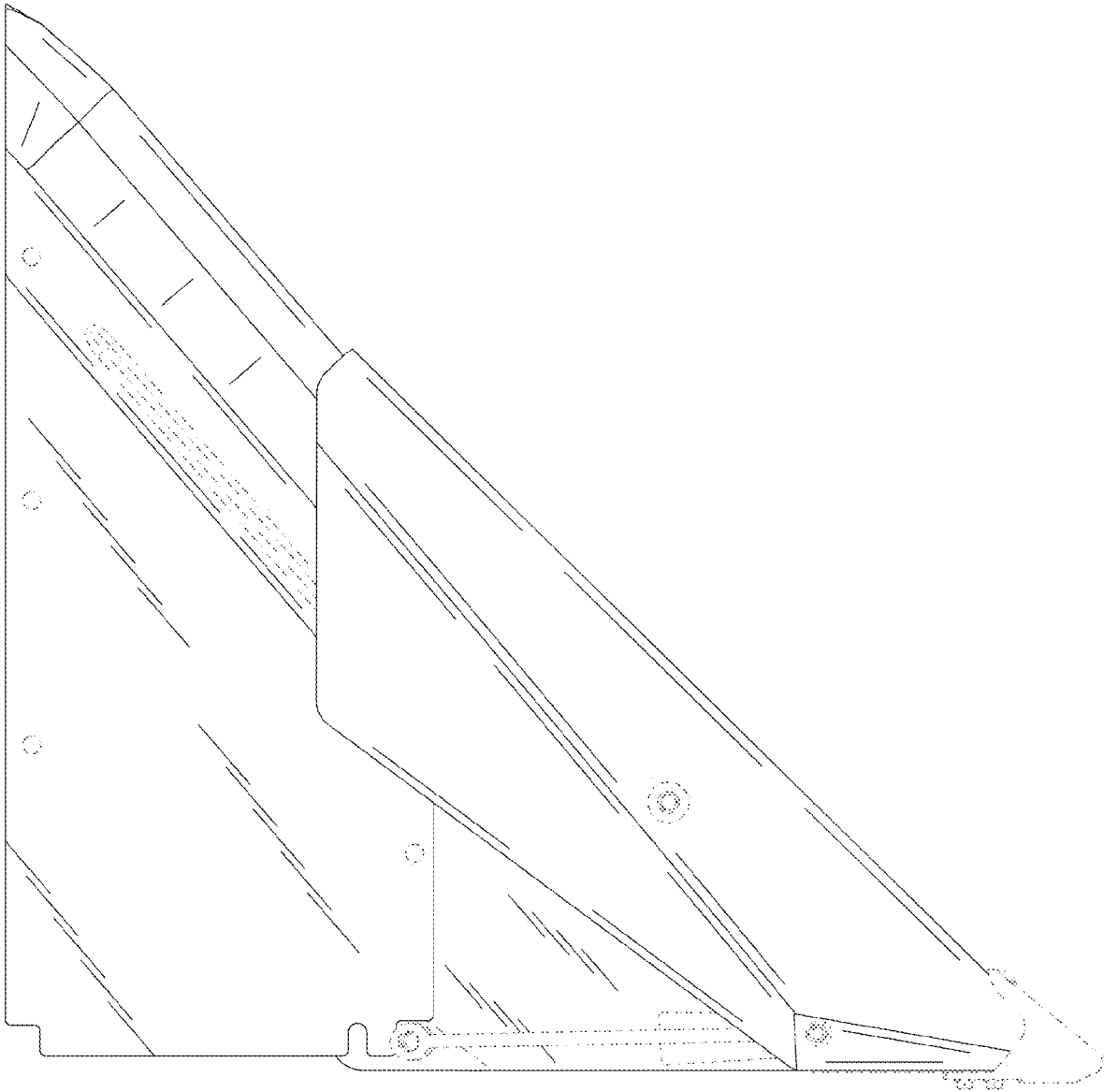

Fig. 13

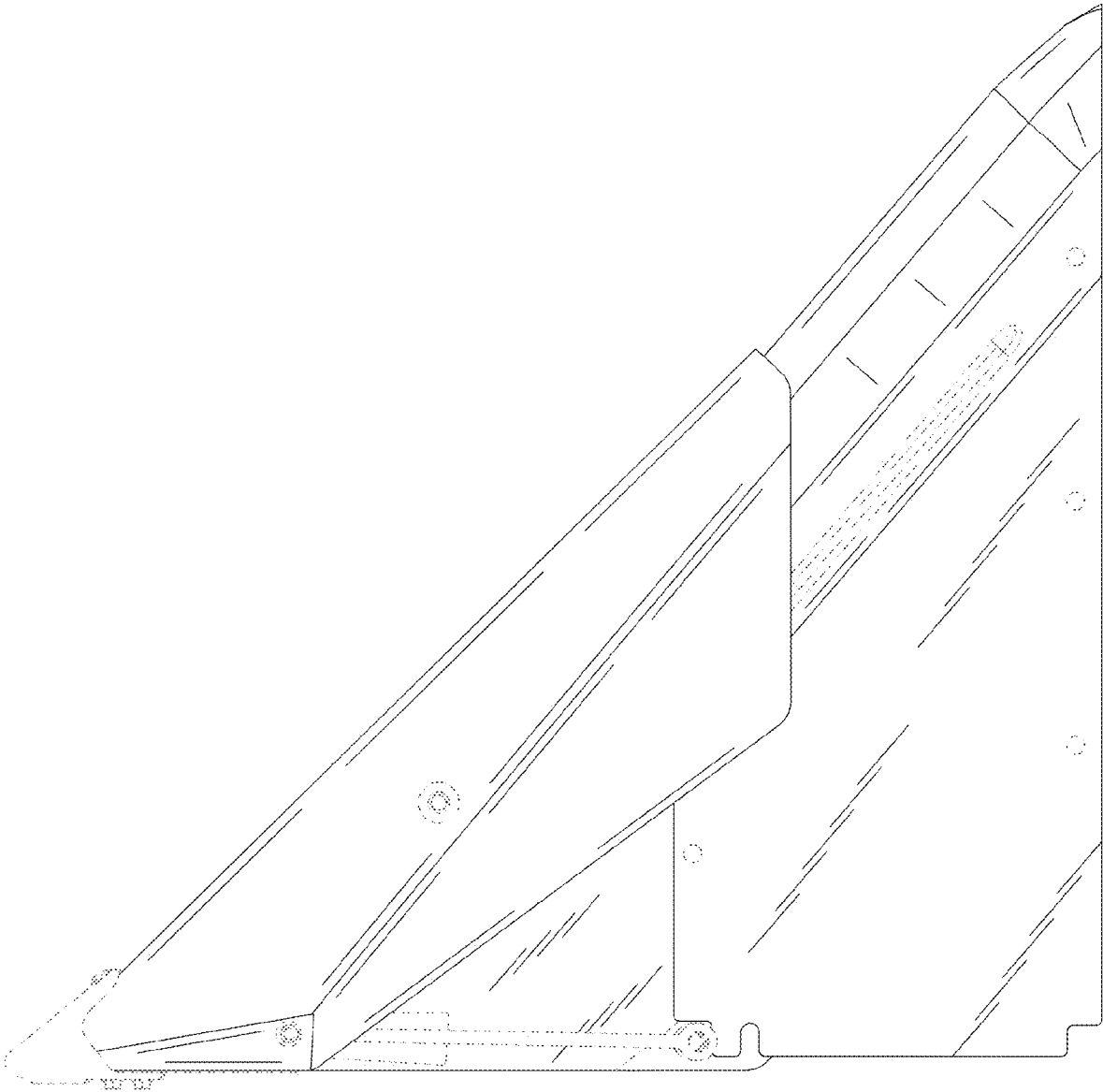

Fig. 14

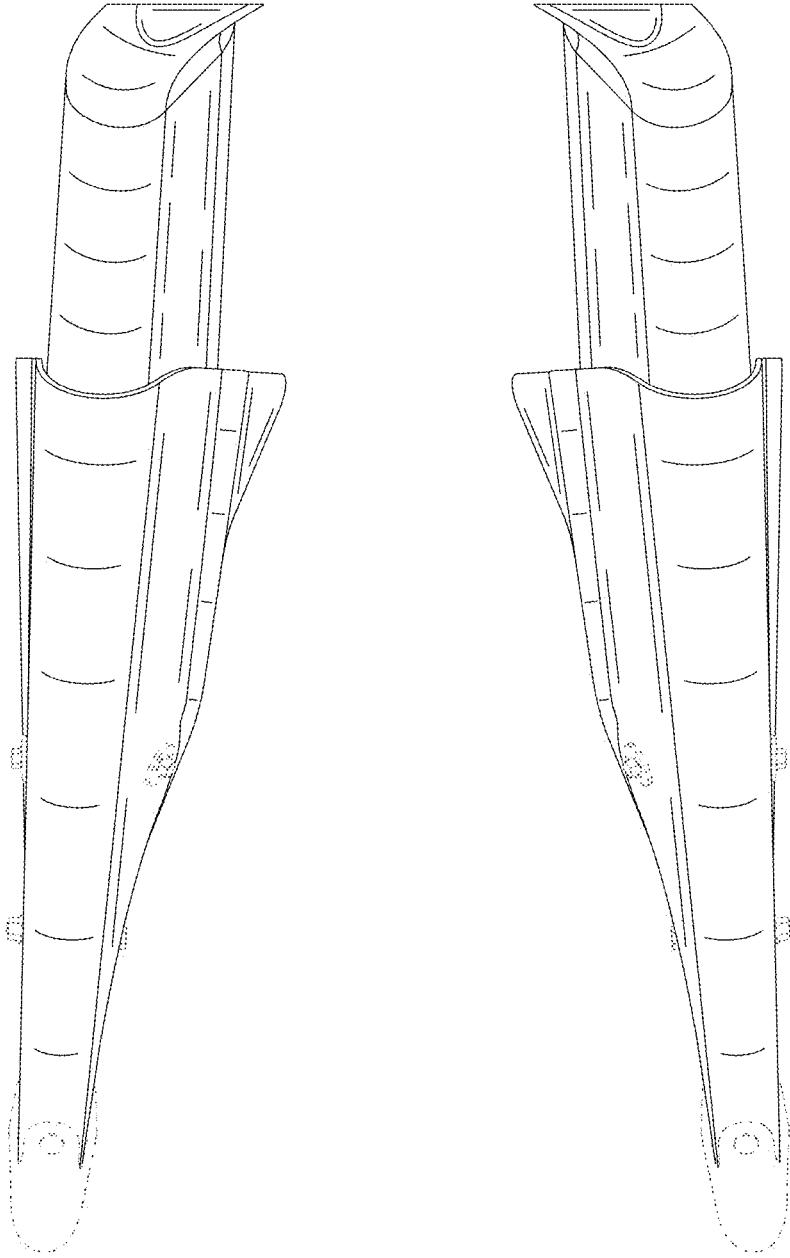

Fig. 15

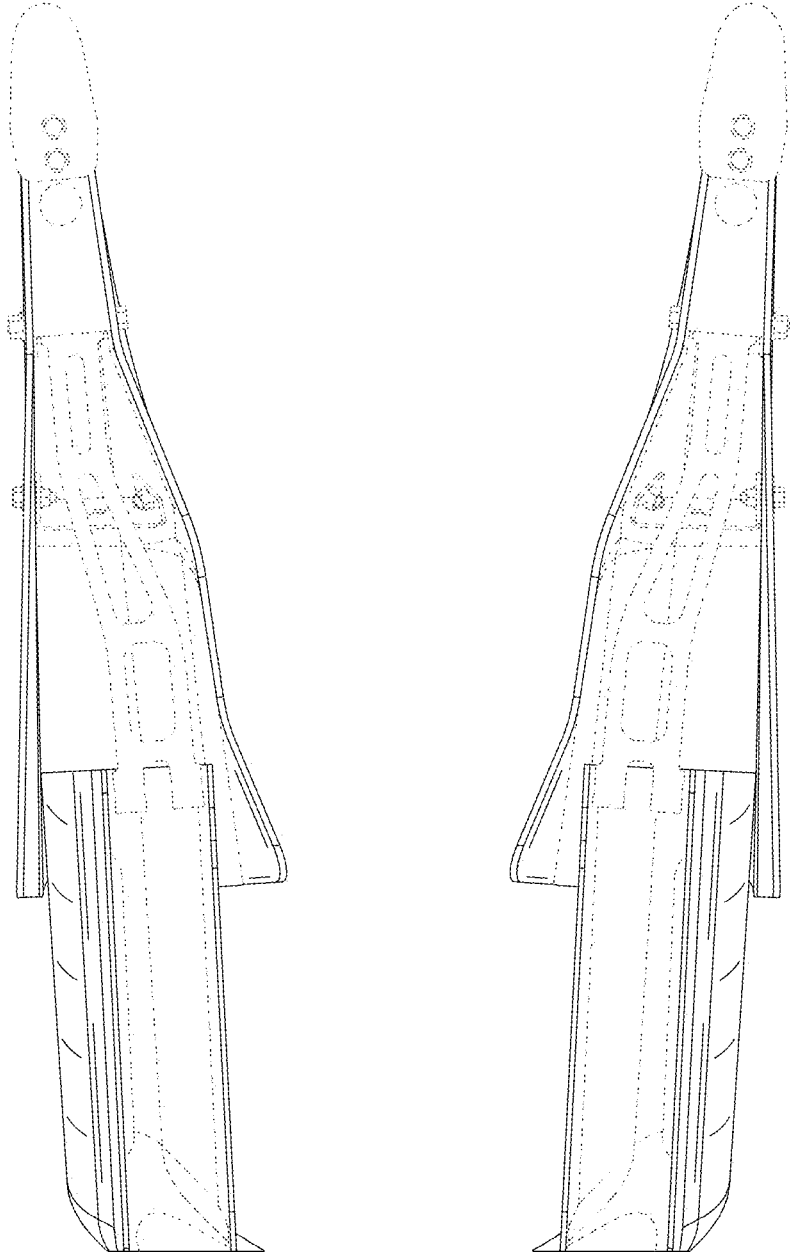

Fig. 16