



(86) **Date de dépôt PCT/PCT Filing Date:** 2008/10/03

(87) **Date publication PCT/PCT Publication Date:** 2009/04/09

(45) **Date de délivrance/Issue Date:** 2020/03/10

(85) **Entrée phase nationale/National Entry:** 2010/04/01

(86) **N° demande PCT/PCT Application No.:** DK 2008/000344

(87) **N° publication PCT/PCT Publication No.:** 2009/043353

(30) **Priorités/Priorities:** 2007/10/04 (US60/977,497);
2007/10/11 (US60/979,217); 2008/02/12 (US61/028,062);
2008/07/17 (EP08104780.5)

(51) **Cl.Int./Int.Cl. C12N 15/113** (2010.01),
A61K 31/7125 (2006.01), **C07H 21/00** (2006.01)

(72) **Inventeurs/Inventors:**
OBAD, SUSANNA, SE;
KAUPPINEN, SAKARI, DK;
ELMEN, JOACIM, SE;
LINDOW, MORTEN, DK;
HEIDENBLAD, MARCUS, SE

(73) **Propriétaire/Owner:**
ROCHE INNOVATION CENTER COPENHAGEN A/S,
DK

(74) **Agent:** BERESKIN & PARR LLP/S.E.N.C.R.L., S.R.L.

(54) **Titre :** OLIGONUCLEOTIQUES QUI CIBLENT ET INHIBENT LES MICRO ARN

(54) **Title:** OLIGONUCLEOTIDES WHICH TARGET AND INHIBIT MICRORNAS

(57) **Abrégé/Abstract:**

The present invention relates to very short heavily modified oligonucleotides which target and inhibit microRNAs in vivo, and their use in medicaments and pharmaceutical compositions.

(12) INTERNATIONAL APPLICATION PUBLISHED UNDER THE PATENT COOPERATION TREATY (PCT)

(19) World Intellectual Property Organization
International Bureau



(43) International Publication Date
9 April 2009 (09.04.2009)

PCT

(10) International Publication Number
WO 2009/043353 A2

- (51) **International Patent Classification:**
C12N 15/11 (2006.01) *A61K 31/7115* (2006.01)
A61K 31/7105 (2006.01) *A61K 31/712* (2006.01)
- (21) **International Application Number:**
PCT/DK2008/000344
- (22) **International Filing Date:** 3 October 2008 (03.10.2008)
- (25) **Filing Language:** English
- (26) **Publication Language:** English
- (30) **Priority Data:**
- | | | |
|------------|-------------------------------|----|
| 60/977,497 | 4 October 2007 (04.10.2007) | US |
| 60/979,217 | 11 October 2007 (11.10.2007) | US |
| 61/028,062 | 12 February 2008 (12.02.2008) | US |
| 08104780.5 | 17 July 2008 (17.07.2008) | EP |
- (71) **Applicant (for all designated States except US):** **SANTARIS PHARMA A/S** [DK/DK]; Kogle Allé 6, DK-2970 Hørsholm (DK).
- (72) **Inventors; and**
- (75) **Inventors/Applicants (for US only):** **OBAD, Susanna** [SE/SE]; Roslins Väg 18D, S-217 55 Malmö (SE). **KAUPPINEN, Sakari** [FI/DK]; Norskekrogen 12, DK-2765 Smørum (DK). **ELMEN, Joacim** [SE/SE]; Föreningsgaten 61, S-211 52 Malmö (SE). **LINDOW, Morten** [DK/DK]; Sønder Boulevard 60, 4, DK-1720 Copenhagen (DK). **HEIDENBLAD, Marcus** [SE/SE]; Bankgatan 26, S-223 52 Lund (SE).
- (74) **Common Representative:** **ABRAHAMSEN, Niels**; Santaris Pharma A/S, Kogle Allé 6, DK-2970 Hørsholm (DK).
- (81) **Designated States (unless otherwise indicated, for every kind of national protection available):** AE, AG, AL, AM, AO, AT, AU, AZ, BA, BB, BG, BH, BR, BW, BY, BZ, CA, CH, CN, CO, CR, CU, CZ, DE, DK, DM, DO, DZ, EC, EE, EG, ES, FI, GB, GD, GE, GH, GM, GT, HN, HR, HU, ID, IL, IN, IS, JP, KE, KG, KM, KN, KP, KR, KZ, LA, LC, LK, LR, LS, LT, LU, LY, MA, MD, ME, MG, MK, MN, MW, MX, MY, MZ, NA, NG, NI, NO, NZ, OM, PG, PH, PL, PT, RO, RS, RU, SC, SD, SE, SG, SK, SL, SM, ST, SV, SY, TJ, TM, TN, TR, TT, TZ, UA, UG, US, UZ, VC, VN, ZA, ZM, ZW.
- (84) **Designated States (unless otherwise indicated, for every kind of regional protection available):** ARIPO (BW, GH, GM, KE, LS, MW, MZ, NA, SD, SL, SZ, TZ, UG, ZM, ZW), Eurasian (AM, AZ, BY, KG, KZ, MD, RU, TJ, TM), European (AT, BE, BG, CH, CY, CZ, DE, DK, EE, ES, FI, FR, GB, GR, HR, HU, IE, IS, IT, LT, LU, LV, MC, MT, NL, NO, PL, PT, RO, SE, SI, SK, TR), OAPI (BF, BJ, CF, CG, CI, CM, GA, GN, GQ, GW, ML, MR, NE, SN, TD, TG).
- Published:**
- without international search report and to be republished upon receipt of that report
 - with sequence listing part of description published separately in electronic form and available upon request from the International Bureau



WO 2009/043353 A2

(54) **Title:** MICROMIRS

(57) **Abstract:** The present invention relates to very short heavily modified oligonucleotides which target and inhibit microRNAs *in vivo*, and their use in medicaments and pharmaceutical compositions.

OLIGONUCLEOTIDES WHICH TARGET AND INHIBIT MICRORNAs

FIELD OF THE INVENTION

The present invention relates to very short oligonucleotides which target and inhibit microRNAs *in vivo*, and their use in medicaments and pharmaceutical compositions.

5 BACKGROUND OF THE INVENTION

MicroRNAs (miRNAs) are an abundant class of short endogenous RNAs that act as post-transcriptional regulators of gene expression by base-pairing with their target mRNAs. They are processed from longer (ca 70-80 nt) hairpin-like precursors termed pre-miRNAs by the RNase III enzyme Dicer. MicroRNAs assemble in ribonucleoprotein complexes termed miRNPs and
10 recognize their target sites by antisense complementarity thereby mediating down-regulation of their target genes. Near-perfect or perfect complementarity between the miRNA and its target site results in target mRNA cleavage, whereas limited complementarity between the microRNA and the target site results in translational inhibition of the target gene.

A summary of the role of microRNAs in human diseases, and the inhibition of microRNAs
15 using single stranded oligonucleotides is provided by WO2007/112754 and WO2007/112753. WO2008046911 provides microRNA sequences which are associated with cancer. Numerous microRNAs have been associated with disease phenotypes and it is therefore desirable to provide substances capable of modulating the availability of microRNAs *in vivo*. WO2007/112754 and
20 WO2007/112753 disclose short single stranded oligonucleotides which are considered to form a strong duplex with their target miRNA. SEQ ID NOs 1 - 45 are examples of anti microRNA oligonucleotides as disclosed in WO2007/112754 and WO2007/112753.

25

30 SUMMARY OF THE INVENTION

The present invention is based upon the discovery that the use of very short oligonucleotides which target microRNAs and which have a high proportion of nucleotide

analogue nucleotides, such as LNA nucleotides, are highly effective in alleviating the repression of RNAs, such as an mRNA, by the targeted microRNAs *in vivo*.

5 The present invention provides an oligomer a contiguous sequence of 7, 8, 9 or 10 nucleotide units in length, for use in reducing the effective amount of a microRNA target in a cell or an organism, wherein at least 70%, such as at least 80% of the nucleotide units of the oligomer are selected from the group consisting of LNA units and 2' substituted nucleotide analogues.

10 The present invention provides an oligomer a contiguous sequence of 7, 8, 9 or 10 nucleotide units in length, for use in reducing the effective amount of a microRNA target in a cell or an organism, wherein at least 70% of the nucleotide units of the oligomer are selected from the group consisting of LNA units and 2' substituted nucleotide analogues, and wherein at least 50%, such as at least 60%, such as at least 70% of the nucleotide units of the oligomer are LNA units.

15 The invention provides oligomers of between 7-10 nucleotides in length which comprises a contiguous nucleotide sequence of a total of between 7-10 nucleotides, such as 7, 8, 9, nucleotide units, wherein at least 50% of the nucleotide units of the oligomer are nucleotide analogues.

20 The invention further provides for an oligomer of between 7-10 nucleotides in length which comprises a contiguous nucleotide sequence of a total of between 7-10 nucleotides, such as 7, 8, 9, or 10, nucleotide units, wherein the nucleotide sequence is complementary to a corresponding nucleotide sequence found in mammalian or viral microRNA, and wherein at least 50% of the nucleotide units of the oligomer are nucleotide analogues.

The present invention provides oligomers according to the invention as a medicament.

25 The present invention provides pharmaceutical compositions comprising the oligomer of the invention and a pharmaceutically acceptable diluent, carrier, salt or adjuvant.

The invention provides for a conjugate comprising an oligomer according to the invention, conjugated to at least one non-nucleotide or polynucleotide entity, such as a sterol, such as cholesterol.

30 The invention provides for the use of an oligomer or a conjugate according to the invention, for the manufacture of a medicament for the treatment of a disease or medical disorder associated with the presence or over-expression of a microRNA, such as one or more of the microRNAs referred to herein.

35 The invention provides for the treatment of a disease or medical disorder associated with the presence or overexpression of the microRNA, comprising the step of administering a composition (such as the pharmaceutical composition) comprising an oligomer or conjugate according to the invention to a patient suffering from or likely to suffer from said disease or medical disorder.

The invention provides for a method for reducing the effective amount of a microRNA target in a cell or an organism, comprising administering the oligomer of the invention, or a composition (such as a pharmaceutical composition) comprising the oligomer or conjugate according to the invention to the cell or organism.

5 The invention provides for a method for reducing the effective amount of a microRNA target in a cell or an organism, comprising administering the oligomer or conjugate or pharmaceutical composition according to the invention to the cell or organism.

The invention provides for a method for de-repression of a target mRNA (or one or more RNAs) in a cell or an organism, comprising administering an oligomer or conjugate according to 10 the invention, or a composition comprising said oligomer or conjugate, to said cell or organism.

The invention provides for the use of an oligomer or a conjugate according to the invention, for inhibiting the microRNA in a cell which comprises said microRNA, such as a human cell. The use may be *in vivo* or *in vitro*.

BRIEF DESCRIPTION OF THE DRAWINGS

15 **Figure 1.** Schematic presentation of the miR-21, miR-155 and miR-122 8-mer LNA-antimiRs, indicating the targeting positions with the fully LNA-modified and phosphorothiolated LNA-antimiR. Preferred hybridisation positions for 7mer, 8mer, 9mer and 10mer LNA oligonucleotides on the mature microRNA are also indicated.

Figure 2. Assessment of miR-21 antagonism by SEQ ID #3205 and SEQ ID #3204 LNA- 20 antimiRs in MCF-7 cells using a luciferase sensor assay. MCF-7 cells were co-transfected with luciferase sensor plasmids containing a perfect match target site for miR-21 or a mismatch target site (.mm2) and LNA-antimiRs at different concentrations. After 24 hours, cells were harvested and luciferase activity measured. Shown are the mean of renilla/firefly ratios for three separate experiments (bars = s.e.m), were all have been normalized against 0 nM psiCHECK2 25 (=control).

Figure 3. Assessment of miR-21 antagonism by SEQ ID #3205 and SEQ ID #3204 LNA- antimiRs in HeLa cells using a luciferase sensor assay. HeLa cells were co-transfected with luciferase sensor plasmids containing a perfect match target site for miR-21 (mir-21) or a mismatch target site (mm2) and LNA-antimiRs at different concentrations. After 24 hours, cells 30 were harvested and luciferase activity measured. Shown are the mean of renilla/firefly ratios for three separate experiments (bars = s.e.m), were all have been normalized against 0 nM psiCHECK2 (=control).

Figure 4. Assessment of miR-155 antagonism by SEQ ID #3206 and SEQ ID #3207 LNA- antimiRs in LPS-treated mouse RAW cells using a luciferase sensor assay. RAW cells were co- 35 transfected with miR-155 and the different LNA-antimiRs at different concentrations. After 24

hours, cells were harvested and luciferase activity measured. Shown are the mean of renilla/firefly, were all have been normalized against 0 nM psiCHECK2.

Figure 5. Assessment of miR-122 antagonism by SEQ ID #3208 and SEQ ID #4 LNA-antimiRs in HuH-7 cells using a luciferase sensor assay. HuH-7 cells were co-transfected with a miR-122 luciferase sensor containing a perfect match miR-122 target site and the different LNA-antimiRs at different concentrations. After 24 hours, cells were harvested and luciferase activity measured. Shown are the mean of renilla/firefly ratios for three separate experiments (bars = s.e.m), where all have been normalized against 0 nM psiCHECK2 (=control).

Figure 6. Schematic presentation of the miR-21 luciferase reporter constructs.

Figure 7. Assessment of miR-21 antagonism by an 8-mer LNA-antimiR (SEQ ID #3205) versus a 15-mer LNA-antimiR (SEQ ID #3204) in PC3 cells using a luciferase reporter assay. PC3 cells were co-transfected with luciferase reporter plasmids containing a perfect match target site for miR-21 or a mismatch target site and LNA-antimiRs at different concentrations. After 24 hours, cells were harvested and luciferase activity measured. Shown are the mean values (bars=s.e.m) of three independent experiments where the renilla/firefly ratios have been normalized against 0 nM empty vector without target site (=control). Shown is also a schematic presentation of the miR-21 sequence and the design and position of the LNA-antimiRs. LNA nucleotides are indicated by ovals, and DNA residues are indicated by bars.

Figure 8. Specificity assessment of miR-21 antagonism by an 8-mer LNA-antimiR in HeLa cells using a luciferase reporter assay. HeLa cells were co-transfected with luciferase reporter plasmids containing a perfect match or a mismatched target site for miR-21 and LNA-antimiRs (SEQ ID #3205) or an 8-mer LNA mismatch control oligo (SEQ ID #3218) at different concentrations. After 24 hours, cells were harvested and luciferase activity was measured. Shown are the mean values (bars=s.e.m) for three independent experiments where the Renilla/firefly ratios have been normalized against 0 nM empty vector without target site (=control). Shown is also a schematic presentation of the miR-21 sequence and the design and position of the LNA-antimiRs. Mismatches are indicated by filled ovals.

Figure 9. Assessment of the shortest possible length of a fully LNA-modified LNA-antimiR that mediates effective antagonism of miR-21. HeLa cells were co-transfected with luciferase reporter plasmids containing a perfect match or a mismatch target site for miR-21 and the LNA-antimiRs at different concentrations (SEQ ID #3209 =6-mer and SEQ ID #3210=7-mer). After 24 hours, cells were harvested and luciferase activity measured. Shown are the mean values (bars=s.e.m) for three independent experiments where the renilla/firefly ratios have been normalized against 0 nM empty vector without target site (=control). Shown is also a schematic presentation of the miR-21 sequence and the design and position of the LNA-antimiRs.

Figure 10. Length assessment of fully LNA-substituted LNA-antimiRs antagonizing miR-21. HeLa cells were co-transfected with luciferase reporter plasmids containing a perfect match or a

mismatch target site for miR-21 and LNA-antimiRs at different concentrations (SEQ ID #3211 =9-mer, SEQ ID #3212=10-mer, SEQ ID #3213=12-mer and SEQ ID #3214=14-mer). After 24 hours, cells were harvested and luciferase activity measured. Shown are the mean values (bars=s.e.m) for three independent experiments where the renilla/firefly ratios have been

5 normalized against 0 nM empty vector without target site (=control). Shown is also a schematic presentation of the miR-21 sequence and the design and position of the LNA-antimiRs.

Figure 11. Determination of the most optimal position for an 8-mer LNA-antimiR within the miR target recognition sequence. HeLa cells were co-transfected with luciferase reporter plasmids containing a perfect match or a mismatch target site for miR-21 and the LNA-antimiRs at

10 different concentrations. After 24 hours, cells were harvested and luciferase activity measured. Shown are the mean values (bars=s.e.m) for three independent experiments where the renilla/firefly ratios have been normalized against 0 nM empty vector without target site (=control). Shown is also a schematic presentation of the miR-21 sequence and the design and position of the LNA-antimiRs.

15 **Figure 12.** Validation of interaction of the Pdc4-3'-UTR and miR-21 by the 8-mer SEQ ID #3205 LNA-antimiR. HeLa cells were co-transfected with a luciferase reporter plasmid containing part of the 3'UTR of Pdc4 gene and LNA-antimiRs at different concentrations (SEQ ID #3205 = 8 mer, perfect match; SEQ ID #3218 = 8 mer, mismatch; SEQ ID #3204 = 15 mer, LNA/DNA mix; SEQ ID #3220 = 15 mer, gapmer). After 24 hours, cells were harvested and

20 luciferase activity measured. Shown are renilla/firefly ratios that have been normalized against 0 nM. Shown is also a schematic presentation of the miR-21 sequence and the design and position of the LNA-antimiRs.

Figure 13. Comparison of an 8-mer LNA-antimiR (SEQ ID #3207) with a 15-mer LNA-antimiR (SEQ ID #3206) in antagonizing miR-155 in mouse RAW cells. Mouse RAW cells were co-

25 transfected with luciferase reporter plasmids containing a perfect match for miR-155 and the different LNA-antimiRs at different concentrations. After 24 hours, cells were harvested and luciferase activity measured. Shown are the mean values (bars=s.e.m) of three independent experiments where the renilla/firefly ratios have been normalized against 0 nM empty vector without miR-155 target site (=control). Shown is also a schematic presentation of the miR-155

30 sequence and the design and position of the LNA-antimiRs.

Figure 14. Assessment of c/EBP β Assessment of c/EBP β LNA-antimiR (SEQ ID #3207) with a 15-mer LNA-antimiR (SEQ ID #3206) in antagonizing miR-155 in mouse RAW cells. Mouse RAW cells were co-transfected with luciferase reporter plasmids containing a perfect match for miR-155 and the diffter 20 hours, cells were harvested and western blot analysis of protein

35 extracts from RAW cells was performed. The different isoforms of c/EBP β are indicated, and the ratios calculated on c/EBP β LIP and beta-tubulin are shown below.

Figure 15. Antagonism of miR-106b by a fully LNA-modified 8-mer (SEQ ID #3221) LNA-antimiR or by a 15-mer mixmer (SEQ ID #3228) antimiR. HeLa cells were co-transfected with luciferase reporter plasmids containing a perfect match for miR-106b and the different LNA-antimiRs at different concentrations. After 24 hours, cells were harvested and luciferase activity measured. Shown are the mean values of four replicates where the renilla/firefly ratios have been normalized against 0 nM empty vector without miRNA target site (=control). Shown is also a schematic presentation of the miR-106b sequence and the design and position of the LNA-antimiRs.

Figure 16. Antagonism of miR-19b by a fully LNA-modified 8-mer (SEQ ID #3222) LNA-antimiR and a 15-mer (SEQ ID #3229) mixmer antimiR. HeLa cells were co-transfected with luciferase reporter plasmids containing a perfect match for miR-19a and the two LNA-antimiRs at different concentrations. After 24 hours, cells were harvested and luciferase activity measured. Shown are the mean values of four replicate experiments, where the renilla/firefly ratios have been normalized against 0 nM empty vector without a miR-19a target site (=control). Shown is also a schematic presentation of the miR-19a sequence and the design and position of the LNA-antimiRs.

Figure 17. Schematic presentation showing the mature human miR-221 and miR-222 sequences. Shown in the square is the seed sequence (7-mer) that is conserved in both miRNA sequences.

Figure 18. Targeting of a microRNA family using short, fully LNA-substituted LNA-antimiR. PC3 cells were co-transfected with luciferase reporter plasmids for miR-221 and miR-222 separately or together and with the different LNA-antimiRs at varying concentrations. When co-transfecting with the LNA-antimiRs (15-mers) SEQ ID #3223 (against miR-221) and SEQ ID #3224 (against miR-222), the total concentration was 2 nM (1 nM each), while transfecting the cells with SEQ ID #3225 (7-mer) the concentrations were 0, 1, 5, 10 or 25 nM. After 24 hours, cells were harvested and luciferase activity measured. Shown are the mean values (bars=s.e.m) of three independent experiments where the renilla/firefly ratios have been normalized against 0 nM empty vector without a miRNA target site (=control). Shown is also a schematic presentation of the miR-221/222 sequence and the design and position of the LNA-antimiRs.

Figure 19. Assessment of p27 protein levels as a functional readout for antagonism of the miR-221/222 family by the 7-mer SEQ ID #3225 LNA-antimiR. PC3 cells were transfected with the 7-mer LNA-antimiR SEQ ID #3225 targeting both miR-221 and miR-222 at varying concentrations. After 24 hours, cells were harvested and protein levels were measured on a western blot. Shown are the ratios of p27/tubulin.

Figure 20. Assessment of miR-21 antagonism by an 8-mer LNA-antimiR (SEQ ID #3205) versus a 15-mer LNA-antimiR (SEQ ID #3204) and an 8-mer with 2 mismatches (SEQ ID #3218) in HepG2 cells using a luciferase reporter assay.

HepG2 cells were co-transfected with luciferase reporter plasmid containing a perfect match target site for miR-21 and LNA-antimiRs at different concentrations. After 24 hours, cells were harvested and luciferase activity measured. Shown are the mean values (bars=s.e.m) of three independent experiments where the renilla/firefly ratios have been normalized against 0 nM empty vector without target site (=control). Shown is also a schematic presentation of the miR-21 sequence and the design and position of the LNA-antimiRs.

Figure 21. Validation of interaction of the Pdc4 3'UTR and miR-21 by the 8-mer SEQ ID #3205 LNA-antimiR versus the 15-mer (SEQ ID #3204) and an 8-mer with two mismatches (SEQ ID #3218).

Huh-7 cells were co-transfected with a luciferase reporter plasmid containing part of the 3'UTR of Pdc4 gene, pre-miR-21 (10 nM) and LNA-antimiRs at different concentrations. After 24 hours, cells were harvested and luciferase activity measured. Shown are the mean values (bars=s.e.m) of three independent experiments where the renilla/firefly ratios have been normalized against 0 nM empty vector without target site (=control). Shown is also a schematic presentation of the miR-21 sequence and the design and position of the LNA-antimiRs.

Figure 22. Antagonism of miR-21 by SEQ ID #3205 leads to increased levels of Pdc4 protein levels.

HeLa cells were transfected with 5 nM LNA-antimiR SEQ ID #3205 (perfect match), or SEQ ID #3219 LNA scrambled (8mer) or SEQ ID #3218 (8-mer mismatch). Cells were harvested after 24 hours and subjected to Western blot with Pdc4 antibody.

Figure 23. ALT and AST levels in mice treated with SEQ ID #3205 (perfect match) or SEQ ID #3218 (mismatch control). Mice were sacrificed after 14 days and after receiving 25 mg/kg every other day.

Figure 24. Assessment of PU.1 protein levels as a functional readout for miR-155 antagonism by short LNA-antimiR (SEQ ID #3207).

THP-1 cells were co-transfected with pre- miR-155 (5 nmol) and different LNA oligonucleotides (5 nM) and 100 ng/ml LPS was added. After 24 hours, cells were harvested and western blot analysis of protein extracts from the THP-1 cells was performed. PU.1 and tubulin are indicated.

Figure 25. Assessment of p27 protein levels as a functional readout for antagonism of the miR-221/222 family by the 7-mer SEQ ID #3225 LNA-antimiR.

PC3 cells were transfected with the 7-mer LNA-antimiR SEQ ID #3225 targeting both miR-221 and miR-222 and a LNA scrambled control at 5 and 25 nM. After 24 hours, cells were harvested and protein levels were measured on a western blot. Shown are the ratios of p27/tubulin.

Figure 26. Knock-down of miR-221/222 by the 7-mer SEQ ID #3225 (perfect match) LNA-antimiR reduces colony formation in soft agar in PC3 cells.

PC3 cells were transfected with 25 nM of the 7-mer LNA-antimiR SEQ ID #3225 targeting both miR-221 and miR-222 or a 7-mer scrambled control ((SEQ ID #3231). After 24 hours, cells were

harvested and seeded on soft agar. After 12 days, colonies were counted. One experiment has been done in triplicate.

Figure 27. Overview of the human let-7 family, and of tested antagonists.

(upper) The sequences represent the mature miRNA for each member and the box depicts nucleotides 2-16, the positions typically antagonized by LNA-antimiRs. Columns to the right show the number of nucleotide differences compared to let-7a, within the seed (S: position 2-8), extended seed (ES; position 2-9), and the remaining sequence typically targeted by LNA-antimiRs (NE; position 9-16), respectively. Nucleotides with inverted colors are altered compared to let-7a. (lower) Summary of tested antagonists against the let-7 family, including information on design, length and perfectly complementary targets. All compounds are fully phosphorothiolated.

Figure 28. Assessment of let-7 antagonism by six different LNA-antimiRs in Huh-7 cells using a luciferase sensor assay.

Huh-7 cells were co-transfected with luciferase sensor plasmids containing a partial HMGA2 3'UTR (with four let-7 binding sites), with or without let-7a precursor (grey and black bars, respectively), and with 6 different LNA-antimiRs at increasing concentrations. After 24 hours, cells were harvested and luciferase activity measured. Shown are the mean of renilla/firefly ratios for duplicate measurements and standard deviations for each assay. Within each LNA-antimiR group all ratios have been normalized to the average of wells containing no let-7a precursor (black bars).

Figure 29. Luciferase results from Huh-7 cells transfected with the HMGA2 3'UTR sensor plasmid, LNA-antimiRs SEQ ID #3226 (left) and SEQ ID #3227 (right), and pre-miRs for let-7a (A), let-7d (B), let-7e (C), and let-7i (D). Grey bars indicate the target de-repression after pre-miR inclusion, whereas black control bars represent the equivalent level without pre-miR addition. Each ratio is based on quadruplicate measurements and have been normalized against the average of wells containing no precursor (black bars) within each treatment group.

Figure 30. Luciferase results from HeLa cells transfected with the HMGA2 3'UTR sensor plasmid or control vector, and the LNA-antimiR SEQ ID #3227 at various concentrations. Each ratio is based on quadruplicate measurements normalized against untreated (0 nM) empty control vector (psi-CHECK-2; grey bars).

Figure 31. Assessment of miR-21 antagonism by 8mer (#3205) in HCT116 cells using a luciferase sensor assay. HCT116 cells were co-transfected with luciferase sensor plasmids containing a perfect match target site for miR-21 (grey bars) and LNA-antimiR and control oligonucleotides at different concentrations. After 24 hours, cells were harvested and luciferase activity measured. Shown is one typical example of two where the renilla/firefly ratios have been normalized against 0 nM empty vector (=black bars).

Figure 32. Silencing of miR-21 by the 8-mer #3205 LNA-antimiR reduces colony formation in soft agar in PC3 cells. PC3 cells were transfected with 25 nM of the 8-mer LNA-antimiR #3205 targeting miR-21. After 24 hours, cells were harvested and seeded on soft agar. After 12 days, colonies were counted. Shown is the mean of three separate experiments, each performed in triplicate, and normalised against 0 nM control (i.e. transfection but with no LNA). $p=0.01898$ for #3205.

Figure 33. Knock-down of miR-21 by the 8-mer #3205 LNA-antimiR reduces colony formation in soft agar in HepG2 cells. HepG2 cells were transfected with 25 nM of the 8-mer LNA-antimiR #3205 targeting miR-21. After 24 hours, cells were harvested and seeded on soft agar. After 17 days, colonies were counted. Shown is the mean of three replicates from one experiment (bars=SEM).

Figure 34. Wound closure in the invasive human prostate cell line PC3 after treatment with #3205. (A) PC3 cells were transfected at day 3 with LNA-antimiR and control oligonucleotides at 25 nM, #3205 (8mer, perfect match) and #3219 (8mer, mismatch) and the following day a scratch was made. Pictures were taken after 24 hours in order to monitor the migration. (B) The area in each timepoint has been measured with the software program Image J and normalized against respective 0 h time-point.

Figure 35. Length assessment of fully LNA-substituted LNA-antimiRs antagonizing miR-155. RAW cells were co-transfected with luciferase reporter plasmids containing a perfect match target site for miR-155 and with LNA-antimiR oligonucleotides at different concentrations. After 24 hours, cells were harvested and luciferase activity measured. Shown are the mean values (bars=s.e.m) for three independent experiments where the renilla/firefly ratios have been normalized against 0 nM empty vector without target site (=mock). Shown is also a schematic presentation of the miR sequence and the design and position of the LNA-antimiRs.

Figure 36. Binding of 5'-FAM labeled LNA-antimiR-21 (#3205) to mouse plasma protein. (A) % unbound LNA-antimiR-21 compound as a function of oligonucleotide concentration in mouse plasma. (B) Concentration of unbound LNA-antimiR-21 compound #3205 as a function of #3205 concentration in mouse plasma.

Figure 37. Quantification Ras protein levels by Western blot analysis.

A. Gel image showing Ras and Tubulin (internal standard) protein in treated (anti-let-7; 8-mer) vs. untreated (saline) lung and kidney samples. B. Quantifications of Ras protein levels in the lung and kidney, respectively, of LNA-antimiR-treated mice (black bars), normalized against equivalent saline controls (grey bars), using tubulin as equal-loading control.

B. Silencing of miR-21 by #3205 leads to increased levels of Pcd4 protein levels *in vivo*.

C. Mice were injected with saline or 25 mg/kg LNA-antimiR (#3205) over 14 days every other day, with a total of 5 doses. Mice were sacrificed and protein was isolated from kidney and subjected to Western blot analysis with Pcd4 antibody. A. Gel image showing Pcd4 and Gapdh (internal standard) protein in treated (antimiR-21; 8-mer) vs. untreated (saline) kidney samples (M1, mouse 1; M2, mouse 2). B. Quantification of Pcd4 protein levels in kidneys of LNA-antimiR-treated mice (dark grey bars), normalized against the average of equivalent saline controls (light grey bars), using Gapdh as loading control.

DETAILED DESCRIPTION OF THE INVENTION

Short oligonucleotides which incorporate LNA are known from the *in vitro* reagents area, (see for example WO2005/098029 and WO 2006/069584). However the molecules designed for diagnostic or reagent use are very different in design than those for *in vivo* or pharmaceutical use. For example, the terminal nucleotides of the reagent oligos are typically not LNA, but DNA, and the internucleoside linkages are typically other than phosphorothioate, the preferred linkage for use in the oligonucleotides of the present invention. The invention therefore provides for a novel class of oligonucleotides (referred to herein as oligomers) per se.

The following embodiments refer to certain embodiments of the oligomer of the invention, which may be used in a pharmaceutical composition. Aspects which refer to the oligomer may also refer to the contiguous nucleotide sequence, and vice versa.

20 **The Oligomer**

The oligomer of the invention is a single stranded oligonucleotide which comprises nucleotide analogues, such as LNA, which form part of, or the entire contiguous nucleotide sequence of the oligonucleotide. The nucleotide sequence of the oligomer consists of a contiguous nucleotide sequence.

The term "oligonucleotide" (or simply "oligo"), which is used interchangeably with the term "oligomer" refers, in the context of the present invention, to a molecule formed by covalent linkage of two or more nucleotides. When used in the context of the oligonucleotide of the invention (also referred to the single stranded oligonucleotide), the term "oligonucleotide" may have, in one embodiment, for example have between 7 - 10 nucleotides, such as in individual embodiments, 7, 8, 9, or 10.

The term 'nucleotide' refers to nucleotides, such as DNA and RNA, and nucleotide analogues. It should be recognised that, in some aspects, the term nucleobase may also be used to refer to a nucleotide which may be either naturally occurring or non-naturally occurring – in this respect the term nucleobase and nucleotide may be used interchangeably herein.

In some embodiments, the contiguous nucleotide sequence consists of 7 nucleotide analogues. In some embodiments, the contiguous nucleotide sequence consists of 8 nucleotide

analogues. In some embodiments, the contiguous nucleotide sequence consists of 9 nucleotide analogues.

In one embodiment at least about 50% of the nucleotides of the oligomer are nucleotide analogues, such as at least about 55%, such as at least about 60%, or at least about 65% or at least about 70%, such as at least about 75%, such as at least about 80%, such as at least about 85%, such as at least about 90%, such as at least about 95% or such as 100%. It will also be apparent that the oligonucleotide may comprise of a nucleotide sequence which consists of only nucleotide analogues. Suitably, the oligomer may comprise at least one LNA monomer, such as 2, 3, 4, 5, 6, 7, 8, 9 or 10 LNA monomers. As described below, the contiguous nucleotide sequence may consist only of LNA units (including linkage groups, such as phosphorothioate linkages), or may consists of LNA and DNA units, or LNA and other nucleotide analogues. In some embodiments, the contiguous nucleotide sequence comprises either one or two DNA nucleotides, the remainder of the nucleotides being nucleotide analogues, such as LNA unit.

In some embodiments, the contiguous nucleotide sequence consists of 6 nucleotide analogues and a single DNA nucleotide. In some embodiments, the contiguous nucleotide consists of 7 nucleotide analogues and a single DNA nucleotide. In some embodiments, the contiguous nucleotide sequence consists of 8 nucleotide analogues and a single DNA nucleotide. In some embodiments, the contiguous nucleotide sequence consists of 9 nucleotide analogues and a single DNA nucleotide. In some embodiments, the contiguous nucleotide sequence consists of 7 nucleotide analogues and two DNA nucleotides. In some embodiments, the contiguous nucleotide sequence consists of 8 nucleotide analogues and two DNA nucleotides.

The oligomer may consist of the contiguous nucleotide sequence.

In a specially preferred embodiment, all the nucleotide analogues are LNA. In a further preferred embodiment, all nucleotides of the oligomer are LNA. In a further preferred embodiment, all nucleotides of the oligomer are LNA and all internucleoside linkage groups are phosphothioate.

Herein, the term "nitrogenous base" is intended to cover purines and pyrimidines, such as the DNA nucleobases A, C, T and G, the RNA nucleobases A, C, U and G, as well as non-DNA/RNA nucleobases, such as 5-methylcytosine (^{Me}C), isocytosine, pseudoisocytosine, 5-bromouracil, 5-propynyluracil, 5-propynyl-6-fluoroluracil, 5-methylthiazoleuracil, 6-aminopurine, 2-aminopurine, inosine, 2,6-diaminopurine, 7-propyne-7-deazaadenine, 7-propyne-7-deazaguanine and 2-chloro-6-aminopurine, in particular ^{Me}C. It will be understood that the actual selection of the non-DNA/RNA nucleobase will depend on the corresponding (or matching) nucleotide present in the microRNA strand which the oligonucleotide is intended to target. For example, in case the corresponding nucleotide is G it will normally be necessary to select a

non-DNA/RNA nucleobase which is capable of establishing hydrogen bonds to G. In this specific case, where the corresponding nucleotide is G, a typical example of a preferred non-DNA/RNA nucleobase is ^{Me}C.

5 It should be recognised that the term in 'one embodiment' should not necessarily be limited to refer to one specific embodiment, but may refer to a feature which may be present in 'some embodiments', or even as a generic feature of the invention. Likewise, the use of the term 'some emboidments' may be used to describe a feature of one specific embodiment, or a collection of embodiments, or even as a generic feature of the invention.

10 The terms "corresponding to" and "corresponds to" refer to the comparison between the nucleotide sequence of the oligomer or contiguous nucleotide sequence (a first sequence) and the equivalent contiguous nucleotide sequence of a further sequence selected from either i) a sub-sequence of the reverse complement of the microRNA nucleic acid target (such as a microRNA target selected from SEQ ID 40 – SEQ ID 976, and/or ii) the sequence of nucleotides provided herein such as the group consisting of SEQ ID NO 977 – 1913, or SEQ ID NO 1914-
15 2850, or SEQ ID NO 2851 - 3787. Nucleotide analogues are compared directly to their equivalent or corresponding nucleotides. A first sequence which corresponds to a further sequence under i) or ii) typically is identical to that sequence over the length of the first sequence (such as the contiguous nucleotide sequence).

20 When referring to the length of a nucleotide molecule as referred to herein, the length corresponds to the number of monomer units, *i.e.* nucleotides, irrespective as to whether those monomer units are nucleotides or nucleotide analogues. With respect to nucleotides or nucleobases, the terms monomer and unit are used interchangeably herein.

25 It should be understood that when the term "about" is used in the context of specific values or ranges of values, the disclosure should be read as to include the specific value or range referred to.

30 As used herein, "hybridisation" means hydrogen bonding, which may be Watson-Crick, Hoogsteen, reversed Hoogsteen hydrogen bonding, etc., between complementary nucleoside or nucleotide bases. The four nucleobases commonly found in DNA are G, A, T and C of which G pairs with C, and A pairs with T. In RNA T is replaced with uracil (U), which then pairs with A. The chemical groups in the nucleobases that participate in standard duplex formation constitute the Watson-Crick face. Hoogsteen showed a couple of years later that the purine nucleobases (G and A) in addition to their Watson-Crick face have a Hoogsteen face that can be recognised from the outside of a duplex, and used to bind pyrimidine oligonucleotides via hydrogen bonding, thereby forming a triple helix structure.

35 In the context of the present invention "complementary" refers to the capacity for precise pairing between two nucleotides sequences with one another. For example, if a nucleotide at a certain position of an oligonucleotide is capable of hydrogen bonding with a nucleotide at the

corresponding position of a DNA or RNA molecule, then the oligonucleotide and the DNA or RNA are considered to be complementary to each other at that position. The DNA or RNA strand are considered complementary to each other when a sufficient number of nucleotides in the oligonucleotide can form hydrogen bonds with corresponding nucleotides in the target DNA or RNA to enable the formation of a stable complex. To be stable *in vitro* or *in vivo* the sequence of an oligonucleotide need not be 100% complementary to its target microRNA. The terms "complementary" and "specifically hybridisable" thus imply that the oligonucleotide binds sufficiently strong and specific to the target molecule to provide the desired interference with the normal function of the target whilst leaving the function of non-target RNAs unaffected. However, in one preferred embodiment the term complementary shall mean 100% complementary or fully complementary.

In a preferred example the oligonucleotide of the invention is 100% complementary to a miRNA sequence, such as a human microRNA sequence, or one of the microRNA sequences referred to herein.

In a preferred example, the oligonucleotide of the invention comprises a contiguous sequence, which is 100% complementary to the seed region of the human microRNA sequence.

Preferably, the term "microRNA" or "miRNA", in the context of the present invention, means an RNA oligonucleotide consisting of between 18 to 25 nucleotides in length. In functional terms miRNAs are typically regulatory endogenous RNA molecules.

The terms "target microRNA" or "target miRNA" refer to a microRNA with a biological role in human disease, e.g. an upregulated, oncogenic miRNA or a tumor suppressor miRNA in cancer, thereby being a target for therapeutic intervention of the disease in question.

The terms "target gene" or "target mRNA" refer to regulatory mRNA targets of microRNAs, in which said "target gene" or "target mRNA" is regulated post-transcriptionally by the microRNA based on near-perfect or perfect complementarity between the miRNA and its target site resulting in target mRNA cleavage; or limited complementarity, often conferred to complementarity between the so-called seed sequence (nucleotides 2-7 of the miRNA) and the target site resulting in translational inhibition of the target mRNA.

In the context of the present invention the oligonucleotide is single stranded, this refers to the situation where the oligonucleotide is in the absence of a complementary oligonucleotide – *i.e.* it is not a double stranded oligonucleotide complex, such as an siRNA. In one embodiment, the composition according to the invention does not comprise a further oligonucleotide which has a region of complementarity with the oligomer of 5 or more, such as 6, 7, 8, 9, or 10 consecutive nucleotides, such as eight or more.

Length

Surprisingly we have found that such short 'antimiRs' provide an improved specific inhibition of microRNAs *in vivo*, whilst retaining remarkable specificity for the microRNA target. A further benefit has been found to be the ability to inhibit several microRNAs simultaneously
5 due to the conservation of homologous short sequences between microRNA species – such as the seed regions as described herein. According to the present invention, it has been found that it is particularly advantageous to have short oligonucleotides of 7, 8, 9, 10 nucleotides, such as 7, 8 or 9 nucleotides.

Sequences

10 The contiguous nucleotide sequence is complementary (such as 100% complementary – *i.e.* perfectly complementary) to a corresponding region of a mammalian, human or viral microRNA (miRNA) sequence, preferably a human or viral miRNA sequence.

The microRNA sequence may suitably be a mature microRNA. In some embodiments the microRNA may be a microRNA precursor.

15 The human microRNA sequence may be selected from SEQ ID No 1 – 558 as disclosed in WO2008/046911. As

described in WO2008/046911, these microRNAs are associated with cancer.

The viral microRNA sequence may, in some embodiments, be selected from the group consisting of Herpes simplex virus 1, Kaposi sarcoma-associated herpesvirus, Epstein Barr
20 virus and Human cytomegalovirus.

In one embodiment, the contiguous nucleotide sequence is complementary (such as 100% complementary) to a corresponding region of a miRNA sequence selected from the group of miRNAs listed in table 1. Table 1 provides 7mer, 8mer and 9mer oligomers which target human and viral microRNAs published in miRBase.

25

In some embodiments, the oligomers according to the invention may consist of or comprise a contiguous nucleotide sequence which is complementary to a corresponding microRNA sequence selected from the group consisting of miR-1, miR-10b, miR-17-3p, miR-18, miR-19a, miR-19b, miR-20, miR-21, miR-34a, miR-93, miR-106a, miR-106b, miR-122, miR-133,
30 miR-134, miR-138, miR-155, miR-192, miR-194, miR-221, miR-222, miR-375.

Therefore, in one embodiment, the miRNA (*i.e.* target miRNA) is selected from the group consisting of miR-1, miR-10b, miR-17-3p, miR-18, miR-19a, miR-19b, miR-20, miR-21, miR-34a, miR-93, miR-106a, miR-106b, miR-122, miR-133, miR-134, miR-138, miR-155, miR-192, miR-194, miR-221, miR-222, and miR-375.

35 In one embodiment, the miRNA target is a member of the miR 17 – 92 cluster, such as miR 17, miR 106a, miR 106b, miR 18, miR 19a, miR 19b/1, miR 19b/2, miR20/93, miR92/1, miR92/2 and miR25.

In some embodiments the contiguous nucleotide sequence is complementary to a corresponding region of a microRNA (miRNA) sequence selected from the group consisting of miR-21, miR-155, miR-221, mir-222, and mir-122.

5 In some embodiments said miRNA is selected from the group consisting of miR-1, miR-10miR-29, miR-125b, miR-126, miR-133, miR-141, miR-143, miR-200b, miR-206, miR-208, miR-302, miR-372, miR-373, miR-375, and miR-520c/e.

10 In some embodiments the contiguous nucleotide sequence is complementary to a corresponding region of a microRNA (miRNA) sequence present in the miR 17 – 92 cluster, such as a microRNA selected from the group consisting of miR-17-5p, miR-20a/b, miR-93, miR-106a/b, miR-18a/b, miR-19a/b, miR-25, miR-92a, , miR-363.

In one embodiment, the miRNA (*i.e* target miRNA) is miR-21, such as hsa-miR-21. In one embodiment, the miRNA (*i.e* target miRNA) is miR-122, such as hsa-miR-122. In one embodiment, the miRNA (*i.e* target miRNA) is miR-19b, such as hsa-miR-19b. In one embodiment, the miRNA (*i.e* target miRNA) is miR-155, such as hsa-miR-155. In one
15 embodiment, the miRNA (*i.e* target miRNA) is miR-375, such as hsa-miR-375. In one embodiment, the miRNA (*i.e* target miRNA) is miR-375, such as hsa-miR-106b.

Suitably, the contiguous nucleotide sequence may be complementary to a corresponding region of the microRNA, such as a hsa-miR selected from the group consisting of 19b, 21, 122, 155 and 375.

20 ***The Seed Region and Seedmers***

The inventors have found that carefully designed short single stranded oligonucleotides comprising or consisting of nucleotide analogues, such as high affinity nucleotide analogues such as locked nucleic acid (LNA) units, show significant silencing of microRNAs, resulting in reduced microRNA levels. It was found that tight binding of said oligonucleotides to the so-called seed sequence, typically nucleotides 2 to 8 or 2 to 7, counting from the 5' end, of the target microRNAs was important. Nucleotide 1 of the target microRNAs is a non-pairing base and is most likely hidden in a binding pocket in the Ago 2 protein. Whilst not wishing to be bound to a specific theory, the present inventors consider that by selecting the seed region sequences, particularly with oligonucleotides that comprise LNA, preferably LNA units in the
30 region which is complementary to the seed region, the duplex between miRNA and oligonucleotide is particularly effective in targeting miRNAs, avoiding off target effects, and possibly providing a further feature which prevents RISC directed miRNA function.

The inventors have found that microRNA silencing is even more enhanced when LNA-modified single stranded oligonucleotides do not contain a nucleotide at the 3' end
35 corresponding to this non-paired nucleotide 1. It was further found that at least two LNA units in the 3' end of the oligonucleotides according to the present invention made said oligonucleotides highly nuclease resistant.

In one embodiment, the first or second 3' nucleotide of the oligomer corresponds to the second 5' nucleotide of the microRNA sequence, and may be a nucleotide analogue, such as LNA.

5 In one embodiment, nucleotide units 1 to 6 (inclusive) of the oligomer as measured from the 3' end the region of the oligomer are complementary to the microRNA seed region sequence, and may all be nucleotide analogues, such as LNA.

In one embodiment, nucleotide units 1 to 7 (inclusive) of the oligomer as measured from the 3' end the region of the oligomer are complementary to the microRNA seed region sequence, and may all be nucleotide analogues, such as LNA.

10 In one embodiment, nucleotide units 2 to 7 (inclusive) of the oligomer as measured from the 3' end the region of the oligomer are complementary to the microRNA seed region sequence, and may all be nucleotide analogues, such as LNA.

In one embodiment, the oligomer comprises at least one nucleotide analogue unit, such as at least one LNA unit, in a position which is within the region complementary to the miRNA seed region. The oligomer may, in one embodiment comprise at between one and 6 or
15 between 1 and 7 nucleotide analogue units, such as between 1 and 6 and 1 and 7 LNA units, in a position which is within the region complementary to the miRNA seed region.

In one embodiment, the contiguous nucleotide sequence consists of or comprises a sequence which is complementary (such as 100% complementary) to the seed sequence of
20 said microRNA.

In one embodiment, the contiguous nucleotide sequence consists of or comprises a sequence selected from any one of the seedmer sequences listed in table 1.

In one embodiment, the 3' nucleotide of the seedmer forms the 3' most nucleotide of the contiguous nucleotide sequence, wherein the contiguous nucleotide sequence may, optionally,
25 comprise one or two further nucleotide 5' to the seedmer sequence.

In one embodiment, the oligomer does not comprise a nucleotide which corresponds to the first nucleotide present in the microRNA sequence counted from the 5' end.

In one embodiment, the oligonucleotide according to the invention does not comprise a nucleotide at the 3' end that corresponds to the first 5' end nucleotide of the target microRNA.

30 ***Nucleotide Analogues***

According to the present invention, it has been found that it is particularly advantageous to have short oligonucleotides of 7, 8, 9, 10 nucleotides, such as 7, 8 or 9 nucleotides, wherein at least 50%, such as 55%, 60%, 65%, 70%, 75%, 80%, 85%, 90%, 95% or such as 100% of the nucleotide units of the oligomer are (preferably high affinity) nucleotide analogues, such as a
35 Locked Nucleic Acid (LNA) nucleotide unit.

In some embodiments, the oligonucleotide of the invention is 7, 8 or 9 nucleotides long, and comprises a contiguous nucleotide sequence which is complementary to a seed region of a

human or viral microRNA, and wherein at least 75 %, such as at least 80 %, such as at least 85%, such as at least 90%, such as at least 95%, such as 100% of the nucleotides are are Locked Nucleic Acid (LNA) nucleotide units.

5 In such oligomers, in some embodiments, the linkage groups are other than phosphodiester linkages, such as are phosphorothioate linkages.

In one embodiment, all of the nucleotide units of the contiguous nucleotide sequence are LNA nucleotide units.

In one embodiment, the contiguous nucleotide sequence comprises or consists of 7, 8, 9 or 10, preferably contiguous, LNA nucleotide units.

10 In a further preferred embodiment, the oligonucleotide of the invention is 7, 8 or 9 nucleotides long, and comprises a contiguous nucleotide sequence which is complementary to a seed region of a human or viral microRNA, and wherein at least 80 % of the nucleotides are LNA, and wherein at least 80%, such as 85%, such as 90%, such as 95%, such as 100% of the internucleotide bonds are phosphorothioate bonds. It will be recognised that the contiguous
15 nucleotide sequence of the oligomer (a seedmer) may extend beyond the seed region.

In some embodiments, the oligonucleotide of the invention is 7 nucleotides long, which are all LNA.

In some embodiments, the oligonucleotide of the invention is 8 nucleotides long, of which up to 1 nucleotide may be other than LNA. In some embodiments, the oligonucleotide of the
20 invention is 9 nucleotides long, of which up to 1 or 2 nucleotides may be other than LNA. In some embodiments, the oligonucleotide of the invention is 10 nucleotides long, of which 1, 2 or 3 nucleotides may be other than LNA. The nucleotides 'other than LNA, may for example, be DNA, or a 2' substituted nucleotide analogues.

High affinity nucleotide analogues are nucleotide analogues which result in
25 oligonucleotides which has a higher thermal duplex stability with a complementary RNA nucleotide than the binding affinity of an equivalent DNA nucleotide. This may be determined by measuring the T_m .

In some embodiments, the nucleotide analogue units present in the contiguous nucleotide sequence are selected, optionally independently, from the group consisting of 2'-O_alkyl-RNA
30 unit, 2'-OMe-RNA unit, 2'-amino-DNA unit, 2'-fluoro-DNA unit, LNA unit, PNA unit, HNA unit, INA unit, and a 2'MOE RNA unit.

In some embodiments, the nucleotide analogue units present in the contiguous nucleotide sequence are selected, optionally independently, from the group consisting of 2'-O_alkyl-RNA
unit, 2'-OMe-RNA unit, 2'-amino-DNA unit, 2'-fluoro-DNA unit, LNA unit, and a 2'MOE RNA unit.

35 The term 2'fluoro-DNA refers to a DNA analogue with a substitution to fluorine at the 2' position (2'F). 2'fluoro-DNA is a preferred form of 2'fluoro-nucleotide.

In some embodiments, the oligomer comprises at least 4 nucleotide analogue units, such as at least 5 nucleotide analogue units, such as at least 6 nucleotide analogue units, such as at least 7 nucleotide analogue units, such as at least 8 nucleotide analogue units, such as at least 9 nucleotide analogue units, such as 10, nucleotide analogue units.

5 In one embodiment, the oligomer comprises at least 3 LNA units, such as at least 4 LNA units, such as at least 5 LNA units, such as at least 6 LNA units, such as at least 7 LNA units, such as at least 8 LNA units, such as at least 9 LNA units, such as 10 LNA.

In one embodiment wherein at least one of the nucleotide analogues, such as LNA units, is either cytosine or guanine, such as between 1 – 10 of the of the nucleotide analogues, such as LNA units, is either cytosine or guanine, such as 2, 3, 4, 5, 6, 7, 8, or 9 of the of the nucleotide analogues, such as LNA units, is either cytosine or guanine.

In one embodiment at least two of the nucleotide analogues such as LNA units are either cytosine or guanine. In one embodiment at least three of the nucleotide analogues such as LNA units are either cytosine or guanine. In one embodiment at least four of the nucleotide analogues such as LNA units are either cytosine or guanine. In one embodiment at least five of the nucleotide analogues such as LNA units are either cytosine or guanine. In one embodiment at least six of the nucleotide analogues such as LNA units are either cytosine or guanine. In one embodiment at least seven of the nucleotide analogues such as LNA units are either cytosine or guanine. In one embodiment at least eight of the nucleotide analogues such as LNA units are either cytosine or guanine.

In a preferred embodiment the nucleotide analogues have a higher thermal duplex stability for a complementary RNA nucleotide than the binding affinity of an equivalent DNA nucleotide to said complementary RNA nucleotide.

In one embodiment, the nucleotide analogues confer enhanced serum stability to the single stranded oligonucleotide.

Whilst the specific SEQ IDs in the sequence listing and table 1 refer to oligomers of LNA monomers with phosphorothioate (PS) backbone, it will be recognised that the invention also encompasses the use of other nucleotide analogues and/or linkages, either as an alternative to, or in combination with LNA. As such, the sequence of nucleotides (bases) shown in the sequence listings may be of LNA such as LNA/PS, LNA or may be oligomers containing alternative backbone chemistry, such as sugar/linkage chemistry, whilst retaining the same base sequence (A, T, C or G).

Whilst it is envisaged that other nucleotide analogues, such as 2'-MOE RNA or 2'-fluoro nucleotides may be useful in the oligomers according to the invention, it is preferred that the oligomers have a high proportion, such as at least 50%, LNA. nucleotides.

The nucleotide analogue may be a DNA analogue such as a DNA analogue where the 2'-H group is substituted with a substitution other than -OH (RNA) e.g. by substitution with -O-CH₃, -

O-CH₂-CH₂-O-CH₃, -O-CH₂-CH₂-CH₂-NH₂, -O-CH₂-CH₂-CH₂-OH or -F. The nucleotide analogue may be a RNA analogues such as a RNA analogue which have been modified in its 2'-OH group, e.g. by substitution with a group other than -H (DNA), for example -O-CH₃, -O-CH₂-CH₂-O-CH₃, -O-CH₂-CH₂-CH₂-NH₂, -O-CH₂-CH₂-CH₂-OH or -F. In one embodiment the nucleotide analogue is "ENA".

LNA

When used in the present context, the terms "LNA unit", "LNA monomer", "LNA residue", "locked nucleic acid unit", "locked nucleic acid monomer" or "locked nucleic acid residue", refer to a bicyclic nucleoside analogue. LNA units are described in *inter alia* WO 99/14226, WO 00/56746, WO 00/56748, WO 01/25248, WO 02/28875, WO 03/006475 and WO 03/095467. The LNA unit may also be defined with respect to its chemical formula. Thus, an "LNA unit", as used herein, has the chemical structure shown in Scheme 1 below:

Scheme 1

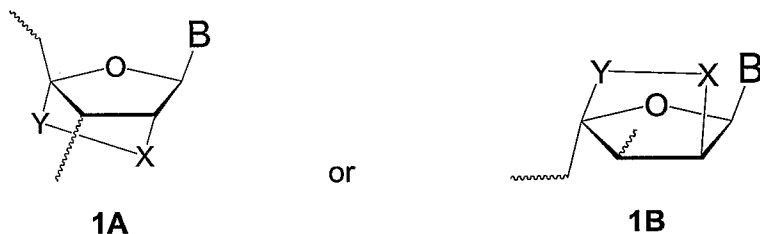

wherein

X is selected from the group consisting of O, S and NR^H, where R^H is H or C₁₋₄-alkyl; Y is (-CH₂)_r, where r is an integer of 1-4; and B is a nitrogenous base.

In a preferred embodiment of the invention, r is 1 or 2, in particular 1, *i.e.* a preferred LNA unit has the chemical structure shown in Scheme 2 below:

Scheme 2

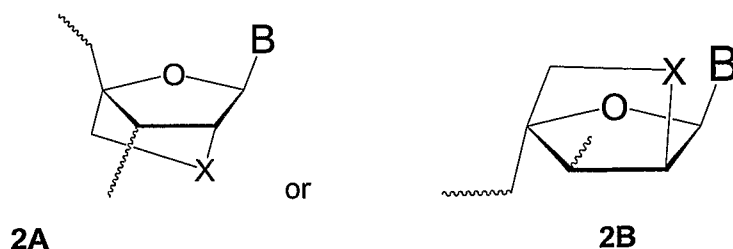

wherein X and B are as defined above.

In an interesting embodiment, the LNA units incorporated in the oligonucleotides of the invention are independently selected from the group consisting of thio-LNA units, amino-LNA units and oxy-LNA units.

Thus, the thio-LNA unit may have the chemical structure shown in Scheme 3 below:

Scheme 3

20

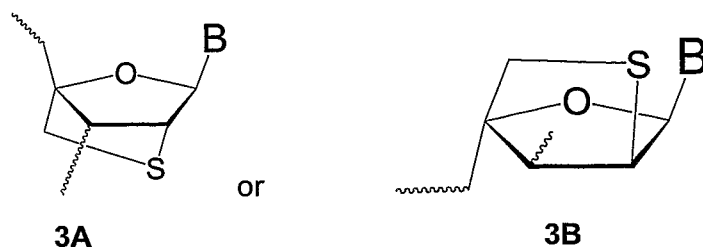

wherein B is as defined above.

Preferably, the thio-LNA unit is in its beta-D-form, i.e. having the structure shown in **3A** above.

5 likewise, the amino-LNA unit may have the chemical structure shown in Scheme 4 below:

Scheme 4

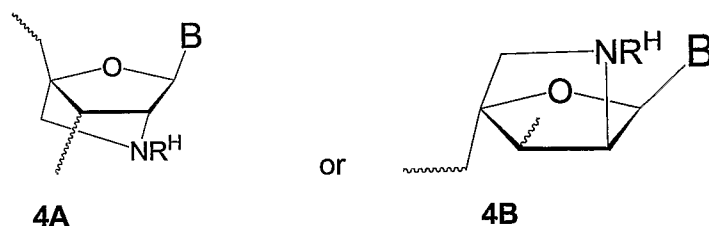

wherein B and R^H are as defined above.

10 Preferably, the amino-LNA unit is in its beta-D-form, i.e. having the structure shown in **4A** above.

The oxy-LNA unit may have the chemical structure shown in Scheme 5 below:

Scheme 5

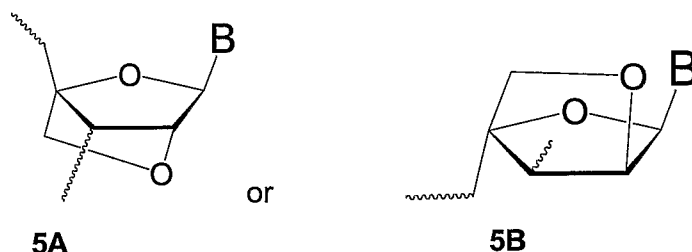

15 wherein B is as defined above.

20 Preferably, the oxy-LNA unit is in its beta-D-form, i.e. having the structure shown in **5A** above. As indicated above, B is a nitrogenous base which may be of natural or non-natural origin. Specific examples of nitrogenous bases include adenine (A), cytosine (C), 5-methylcytosine (^{Me}C), isocytosine, pseudoisocytosine, guanine (G), thymine (T), uracil (U), 5-bromouracil, 5-propynyluracil, 5-propynyl-6, 5-methylthiazoleuracil, 6-aminopurine, 2-aminopurine, inosine, 2,6-diaminopurine, 7-propyne-7-deazaadenine, 7-propyne-7-deazaguanine and 2-chloro-6-aminopurine.

25 The term "thio-LNA unit" refers to an LNA unit in which X in Scheme 1 is S. A thio-LNA unit can be in both the beta-D form and in the alpha-L form. Generally, the beta-D form of the thio-LNA unit is preferred. The beta-D-form and alpha-L-form of a thio-LNA unit are shown in Scheme 3 as compounds **3A** and **3B**, respectively.

The term "amino-LNA unit" refers to an LNA unit in which X in Scheme 1 is NH or NR^H, where R^H is hydrogen or C₁₋₄-alkyl. An amino-LNA unit can be in both the beta-D form and in the alpha-L form. Generally, the beta-D form of the amino-LNA unit is preferred. The beta-D-form and alpha-L-form of an amino-LNA unit are shown in Scheme 4 as compounds **4A** and **4B**,
5 respectively.

The term "oxy-LNA unit" refers to an LNA unit in which X in Scheme 1 is O. An Oxy-LNA unit can be in both the beta-D form and in the alpha-L form. Generally, the beta-D form of the oxy-LNA unit is preferred. The beta-D form and the alpha-L form of an oxy-LNA unit are shown in Scheme 5 as compounds **5A** and **5B**, respectively.

10 In the present context, the term "C₁₋₆-alkyl" is intended to mean a linear or branched saturated hydrocarbon chain wherein the longest chains has from one to six carbon atoms, such as methyl, ethyl, n-propyl, isopropyl, n-butyl, isobutyl, sec-butyl, tert-butyl, pentyl, isopentyl, neopentyl and hexyl. A branched hydrocarbon chain is intended to mean a C₁₋₆-alkyl substituted at any carbon with a hydrocarbon chain.

15 In the present context, the term "C₁₋₄-alkyl" is intended to mean a linear or branched saturated hydrocarbon chain wherein the longest chains has from one to four carbon atoms, such as methyl, ethyl, n-propyl, isopropyl, n-butyl, isobutyl, sec-butyl and tert-butyl. A branched hydrocarbon chain is intended to mean a C₁₋₄-alkyl substituted at any carbon with a hydrocarbon chain.

20 When used herein the term "C₁₋₆-alkoxy" is intended to mean C₁₋₆-alkyl-oxy, such as methoxy, ethoxy, n-propoxy, isopropoxy, n-butoxy, isobutoxy, sec-butoxy, tert-butoxy, pentoxy, isopentoxy, neopentoxy and hexoxy.

In the present context, the term "C₂₋₆-alkenyl" is intended to mean a linear or branched hydrocarbon group having from two to six carbon atoms and containing one or more double
25 bonds. Illustrative examples of C₂₋₆-alkenyl groups include allyl, homo-allyl, vinyl, crotyl, butenyl, butadienyl, pentenyl, pentadienyl, hexenyl and hexadienyl. The position of the unsaturation (the double bond) may be at any position along the carbon chain.

In the present context the term "C₂₋₆-alkynyl" is intended to mean linear or branched hydrocarbon groups containing from two to six carbon atoms and containing one or more triple
30 bonds. Illustrative examples of C₂₋₆-alkynyl groups include acetylene, propynyl, butynyl, pentynyl and hexynyl. The position of unsaturation (the triple bond) may be at any position along the carbon chain. More than one bond may be unsaturated such that the "C₂₋₆-alkynyl" is a di-yne or enedi-yne as is known to the person skilled in the art.

35 When referring to substituting a DNA unit by its corresponding LNA unit in the context of the present invention, the term "corresponding LNA unit" is intended to mean that the DNA unit has been replaced by an LNA unit containing the same nitrogenous base as the DNA unit that it has replaced, e.g. the corresponding LNA unit of a DNA unit containing the nitrogenous base A

also contains the nitrogenous base A. The exception is that when a DNA unit contains the base C, the corresponding LNA unit may contain the base C or the base ^{Me}C, preferably ^{Me}C.

Herein, the term "non-LNA unit" refers to a nucleoside different from an LNA-unit, *i.e.* the term "non-LNA unit" includes a DNA unit as well as an RNA unit. A preferred non-LNA unit is a
5 DNA unit.

The terms "unit", "residue" and "monomer" are used interchangeably herein.

The term "at least one" encompasses an integer larger than or equal to 1, such as 1, 2, 3, 4, 5, 6, 7, 8, 9, 10, 11, 12, 13, 14, 15, 16, 17, 18, 19, 20 and so forth.

The terms "a" and "an" as used about a nucleotide, an agent, an LNA unit, etc., is
10 intended to mean one or more. In particular, the expression "a component (such as a nucleotide, an agent, an LNA unit, or the like) selected from the group consisting of ..." is intended to mean that one or more of the cited components may be selected. Thus, expressions like "a component selected from the group consisting of A, B and C" is intended to include all combinations of A, B and C, *i.e.* A, B, C, A+B, A+C, B+C and A+B+C.

15 ***Internucleoside Linkages***

The term "internucleoside linkage group" is intended to mean a group capable of covalently coupling together two nucleotides, such as between DNA units, between DNA units and nucleotide analogues, between two non-LNA units, between a non-LNA unit and an LNA unit, and between two LNA units, etc. Examples include phosphate, phosphodiester groups and
20 phosphorothioate groups.

In some embodiments, at least one of, such as all of the internucleoside linkage in the oligomer is phosphodiester. However for *in vivo* use, phosphorothioate linkages may be preferred.

Typical internucleoside linkage groups in oligonucleotides are phosphate groups, but
25 these may be replaced by internucleoside linkage groups differing from phosphate. In a further interesting embodiment of the invention, the oligonucleotide of the invention is modified in its internucleoside linkage group structure, *i.e.* the modified oligonucleotide comprises an internucleoside linkage group which differs from phosphate. Accordingly, in a preferred embodiment, the oligonucleotide according to the present invention comprises at least one
30 internucleoside linkage group which differs from phosphate.

Specific examples of internucleoside linkage groups which differ from phosphate

(-O-P(O)₂-O-) include -O-P(O,S)-O-, -O-P(S)₂-O-, -S-P(O)₂-O-, -S-P(O,S)-O-, -S-P(S)₂-O-,
-O-P(O)₂-S-, -O-P(O,S)-S-, -S-P(O)₂-S-, -O-PO(R^H)-O-, O-PO(OCH₃)-O-, -O-PO(NR^H)-O-, -O-
35 PO(OCH₂CH₂S-R)-O-, -O-PO(BH₃)-O-, -O-PO(NHR^H)-O-, -O-P(O)₂-NR^H-, -NR^H-P(O)₂-O-,
-NR^H-CO-O-, -NR^H-CO-NR^H-, -O-CO-O-, -O-CO-NR^H-, -NR^H-CO-CH₂-, -O-CH₂-CO-NR^H-, -
O-CH₂-CH₂-NR^H-, -CO-NR^H-CH₂-, -CH₂-NR^H-CO-, -O-CH₂-CH₂-S-, -S-CH₂-CH₂-O-, -S-CH₂-CH₂-

S-, -CH₂-SO₂-CH₂-, -CH₂-CO-NR^H-, -O-CH₂-CH₂-NR^H-CO -, -CH₂-NCH₃-O-CH₂-, where R^H is hydrogen or C₁₋₄-alkyl.

When the internucleoside linkage group is modified, the internucleoside linkage group is preferably a phosphorothioate group (-O-P(O,S)-O-). In a preferred embodiment, all
5 internucleoside linkage groups of the oligonucleotides according to the present invention are phosphorothioate.

The internucleoside linkage may be selected from the group consisting of: -O-P(O)₂-O-,
-O-P(O,S)-O-, -O-P(S)₂-O-, -S-P(O)₂-O-, -S-P(O,S)-O-, -S-P(S)₂-O-, -O-P(O)₂-S-, -O-P(O,S)-S-,
-S-P(O)₂-S-, -O-PO(R^H)-O-, O-PO(OCH₃)-O-, -O-PO(NR^H)-O-, -O-PO(OCH₂CH₂S-R)-O-,
10 -O-PO(BH₃)-O-, -O-PO(NHR^H)-O-, -O-P(O)₂-NR^H-, -NR^H-P(O)₂-O-, -NR^H-CO-O-,
-NR^H-CO-NR^H-, and/or the internucleoside linkage may be selected from the group consisting
of: -O-CO-O-, -O-CO-NR^H-, -NR^H-CO-CH₂-, -O-CH₂-CO-NR^H-, -O-CH₂-CH₂-NR^H-, -CO-NR^H-
CH₂-, -CH₂-NR^H-CO-, -O-CH₂-CH₂-S-, -S-CH₂-CH₂-O-, -S-CH₂-CH₂-S-, -CH₂-SO₂-CH₂-, -CH₂-
CO-NR^H-, -O-CH₂-CH₂-NR^H-CO -, -CH₂-NCH₃-O-CH₂-, where R^H is selected from hydrogen and
15 C₁₋₄-alkyl. Suitably, in some embodiments, sulphur (S) containing internucleoside linkages as
provided above may be preferred. The internucleoside linkages may be independently
selected, or all be the same, such as phosphorothioate linkages.

In one embodiment, at least 75%, such as 80% or 85% or 90% or 95% or all of the
internucleoside linkages present between the nucleotide units of the contiguous nucleotide
20 sequence are phosphorothioate internucleoside linkages.

Micromir oligonucleotides targeting more than one microRNA

In one embodiment, the contiguous nucleotide sequence is complementary to the
corresponding sequence of at least two miRNA sequences such as 2, 3, 4, 5, 6, 7, 8, 9, or 10
miRNA sequence,. The use of a single universal base may allow a single oligomer of the
25 invention to target two independent microRNAs which either one or both have a single
mismatch in the region which corresponds to oligomer at the position where the universal
nucleotide is positioned.

In one embodiment, the contiguous nucleotide sequence consists of or comprises a
sequence which is complementary to the sequence of at least two miRNA seed region
30 sequences such as 2, 3, 4, 5, 6, 7, 8, 9, or 10 miRNA seed region sequences.

In one embodiment, the contiguous nucleotide sequence is complementary to the
corresponding region of both miR-221 and miR-222.

In one embodiment, the contiguous nucleotide sequence is complementary to the
corresponding region of more than one member of the miR-17-92 cluster – such as two or more
35 or all of miR-17-5p, miR-20a/b, miR-93, miR-106a/b; or two or more or all of miR-25, miR-92a
and miR-363.

In one embodiment, the contiguous nucleotide sequence consists of or comprises a sequence that is complementary to 5'GCTACAT3'.

Oligomer Design

5 In one embodiment, the first nucleotide of the oligomer according to the invention, counting from the 3' end, is a nucleotide analogue, such as an LNA unit. In one embodiment, which may be the same or different, the last nucleotide of the oligomer according to the invention, counting from the 3' end, is a nucleotide analogue, such as an LNA unit.

In one embodiment, the second nucleotide of the oligomer according to the invention, counting from the 3' end, is a nucleotide analogue, such as an LNA unit.

10 In one embodiment, the ninth and/or the tenth nucleotide of the oligomer according to the invention, counting from the 3' end, is a nucleotide analogue, such as an LNA unit.

In one embodiment, the ninth nucleotide of the oligomer according to the invention, counting from the 3' end is a nucleotide analogue, such as an LNA unit.

15 In one embodiment, the tenth nucleotide of the oligomer according to the invention, counting from the 3' end is a nucleotide analogue, such as an LNA unit.

In one embodiment, both the ninth and the tenth nucleotide of the oligomer according to the invention, calculated from the 3' end is a nucleotide analogue, such as an LNA unit.

20 In one embodiment, the oligomer according to the invention does not comprise a region of more than 3 consecutive DNA nucleotide units. In one embodiment, the oligomer according to the invention does not comprise a region of more than 2 consecutive DNA nucleotide units.

In one embodiment, the oligomer comprises at least a region consisting of at least two consecutive nucleotide analogue units, such as at least two consecutive LNA units.

In one embodiment, the oligomer comprises at least a region consisting of at least three consecutive nucleotide analogue units, such as at least three consecutive LNA units.

Other Patterns of Nucleotide Analogues such as LNA in the Oligomer

25 Whilst it is envisaged that oligomers containing at least 6 LNA, such as at least 7 nucleotide units may be preferable, the discovery that such short oligomers are highly effective at targeting microRNAs in vivo can be used to prepare shorter oligomers of the invention which comprise other nucleotide analogues, such as high affinity nucleotide analogues. Indeed, the combination of LNA with other high affinity nucleotide analogues are considered as part of the present invention.

35 Modification of nucleotides in positions 1 to 2, counting from the 3' end. The nucleotide at positions 1 and/ or 2 may be a nucleotide analogue, such as a high affinity nucleotide analogue, such as LNA, or a nucleotide analogue selected from the group consisting of 2'-O-alkyl-RNA unit, 2'-OMe-RNA unit, 2'-amino-DNA unit, 2'-fluoro-DNA unit, 2'-MOE-RNA unit, LNA unit, PNA unit, HNA unit, INA unit. The two 3' nucleotide may therefore be

Xx, xX, XX or xx, wherein: In one embodiment X is LNA and x is DNA or another nucleotide analogue, such as a 2' substituted nucleotide analogue selected from the group consisting of 2'-O_alkyl-RNA unit, 2'-OMe-RNA unit, 2'-amino-DNA unit, 2'-fluoro-DNA unit, LNA, and a 2'MOE RNA unit. Said non-LNA unit (x) may therefore be 2'MOE RNA or 2'-fluoro-DNA.

5 Alternatively X is a nucleotide analogue, and x is DNA.

The above modification at the 2 3' terminal nucleotides may be combined with modification of nucleotides in positions 3 – 8 counting from the 3' end, as described below. In this respect nucleotides designated as X and x may be the same throughout the oligomer. It will be noted that when the oligomer is only 7 nucleotides in length the 8th nucleotide counting from the 3' end should be discarded. In the following embodiments which refer to the modification of nucleotides in positions 3 to 8, counting from the 3' end, the LNA units, in one embodiment, may be replaced with other nucleotide analogues, such as those referred to herein. "X" may, therefore be selected from the group consisting of 2'-O-alkyl-RNA unit, 2'-OMe-RNA unit, 2'-amino-DNA unit, 2'-fluoro-DNA unit, 2'-MOE-RNA unit, LNA unit, PNA unit, HNA unit, INA unit. "x" is preferably DNA or RNA, most preferably DNA. However, it is preferred that X is LNA.

In one embodiment of the invention, the oligonucleotides of the invention are modified in positions 3 to 8, counting from the 3' end. The design of this sequence may be defined by the number of non-LNA units present or by the number of LNA units present. In a preferred embodiment of the former, at least one, such as one, of the nucleotides in positions three to eight, counting from the 3' end, is a non-LNA unit. In another embodiment, at least two, such as two, of the nucleotides in positions three to eight, counting from the 3' end, are non-LNA units. In yet another embodiment, at least three, such as three, of the nucleotides in positions three to eight, counting from the 3' end, are non-LNA units. In still another embodiment, at least four, such as four, of the nucleotides in positions three to eight, counting from the 3' end, are non-LNA units. In a further embodiment, at least five, such as five, of the nucleotides in positions three to eight, counting from the 3' end, are non-LNA units. In yet a further embodiment, all six nucleotides in positions three to eight, counting from the 3' end, are non-LNA units.

Alternatively defined, in an embodiment, the oligonucleotide according to the present invention comprises at least three LNA units in positions three to eight, counting from the 3' end. In an embodiment thereof, the oligonucleotide according to the present invention comprises three LNA units in positions three to eight, counting from the 3' end. The substitution pattern for the nucleotides in positions three to eight, counting from the 3' end, may be selected from the group consisting of XXXxxx, xXXXxx, xxXXXx, xxxXXX, XXxXxx, XXxxXx, XXxxxX, xXXxXx, xXXxxX, xxXXxX, XxXXxx, XxxXXx, XxxxXX, xXxXXx, xXxxXX, xxXxXX, xXxXxX and XxXxXx, wherein "X" denotes an LNA unit and "x" denotes a non-LNA unit. In a preferred embodiment, the substitution pattern for the nucleotides in positions three to eight, counting from the 3' end, is selected from the group consisting of XXxXxx, XXxxXx, XXxxxX, xXXxXx, xXXxxX, xxXXxX,

XxXXxx, XxxXXx, XxxxXX, xXxXXx, xXxxXX, xxXxXX, xXxXxX and XxXxXx, wherein "X" denotes an LNA unit and "x" denotes a non-LNA unit. In a more preferred embodiment, the substitution pattern for the nucleotides in positions three to eight, counting from the 3' end, is selected from the group consisting of xXXxXx, xXXxxX, xxXXxX, xXxXXx, xXxxXX, xxXxXX and
 5 xXxXxX, wherein "X" denotes an LNA unit and "x" denotes a non-LNA unit. In an embodiment, the substitution pattern for the nucleotides in positions three to eight, counting from the 3' end, is xXxXxX or XxXxXx, wherein "X" denotes an LNA unit and "x" denotes a non-LNA unit. In an embodiment, the substitution pattern for the nucleotides in positions three to eight, counting from the 3' end, is xXxXxX, wherein "X" denotes an LNA unit and "x" denotes a non-LNA unit.

10 In a further embodiment, the oligonucleotide according to the present invention comprises at least four LNA units in positions three to eight, counting from the 3' end. In an embodiment thereof, the oligonucleotide according to the present invention comprises four LNA units in positions three to eight, counting from the 3' end. The substitution pattern for the nucleotides in positions three to eight, counting from the 3' end, may be selected from the group consisting of
 15 xxXXXX, xXxXXX, xXXxXX, xXXXxX, xXXXXx, XxxXXX, XxXxXX, XxXXxX, XxXXXx, XXxxXX, XXxXxX, XXxXXx, XXXxxX, XXXxXx and XXXXxx, wherein "X" denotes an LNA unit and "x" denotes a non-LNA unit.

In yet a further embodiment, the oligonucleotide according to the present invention comprises at least five LNA units in positions three to eight, counting from the 3' end. In an
 20 embodiment thereof, the oligonucleotide according to the present invention comprises five LNA units in positions three to eight, counting from the 3' end. The substitution pattern for the nucleotides in positions three to eight, counting from the 3' end, may be selected from the group consisting of xXXXXX, XxXXXX, XXxXXX, XXXxXX, XXXXxX and XXXXXx, wherein "X" denotes an LNA unit and "x" denotes a non-LNA unit.

25 Preferably, the oligonucleotide according to the present invention comprises one or two LNA units in positions three to eight, counting from the 3' end. This is considered advantageous for the stability of the A-helix formed by the oligo: microRNA duplex, a duplex resembling an RNA:RNA duplex in structure.

In yet a further embodiment, the oligonucleotide according to the present invention
 30 comprises at least six LNA units in positions three to eight, counting from the 3' end. In an embodiment thereof, the oligonucleotide according to the present invention comprises at from three to six LNA units in positions three to eight, counting from the 3' end, and in addition from none to three other high affinity nucleotide analogues in the same region, such that the total amount of high affinity nucleotide analogues (including the LNA units) amount to six in the
 35 region from positions three to eight, counting from the 3' end.

In some embodiments, such as when X is LNA, said non-LNA unit (x) is another nucleotide analogue unit, such as a 2' substituted nucleotide analogue selected from the group consisting

of 2'-O_alkyl-RNA unit, 2'-OMe-RNA unit, 2'-amino-DNA unit, 2'-fluoro-DNA unit, LNA, and a 2'MOE RNA unit. Said non-LNA unit (x) may therefore be 2'MOE RNA or 2'-fluoro-DNA.

For oligomers which have 9 or 10 nucleotides, the nucleotide at positions 9 and/ or 10 may be a nucleotide analogue, such as a high affinity nucleotide analogue, such as LNA, or a nucleotide analogue selected from the group consisting of 2'-O-alkyl-RNA unit, 2'-OMe-RNA unit, 2'-amino-DNA unit, 2'-fluoro-DNA unit, 2'-MOE-RNA unit, LNA unit, PNA unit, HNA unit, INA unit. The two 5' nucleotides may therefore be

Xx, xX, XX or xx, wherein: In one embodiment X is LNA and x is DNA or another nucleotide analogue, such as as a 2' substituted nucleotide analogue selected from the group consisting of 2'-O_alkyl-RNA unit, 2'-OMe-RNA unit, 2'-amino-DNA unit, 2'-fluoro-DNA unit, LNA, and a 2'MOE RNA unit. Said non-LNA unit (x) may therefore be 2'MOE RNA or 2'-fluoro-DNA. Alternatively X is a nucleotide analogue, and x is DNA.

The above modification at the 2 5' terminal nucleotides may be combined with modification of nucleotides in positions 3 – 8 counting from the 3' end, and/or the 2 3' nucleotides as described above. In this respect nucleotides designated as X and x may be the same throughout the oligomer.

In a preferred embodiment of the invention, the oligonucleotide according to the present invention contains an LNA unit at the 5' end. In another preferred embodiment, the oligonucleotide according to the present invention contains an LNA unit at the first two positions, counting from the 5' end.

In one embodiment, the invention further provides for an oligomer as described in the context of the pharmaceutical composition of the invention, or for use in vivo in an organism, such as a medicament, wherein said oligomer (or contiguous nucleotide sequence) comprises either

- i) at least one phosphorothioate linkage and/or
- ii) at least one 3' terminal LNA unit, and/or
- iii) at least one 5' terminal LNA unit.

The oligomer may therefore contain at least one phosphorothioate linkage, such as all linkages being phosphorothioates, and at least one 3' terminal LNA unit, and at least one 5' terminal LNA unit.

It is preferable for most therapeutic uses that the oligonucleotide is fully phosphorothiolated – an exception being for therapeutic oligonucleotides for use in the CNS, such as in the brain or spine where phosphorothioation can be toxic, and due to the absence of nucleases, phosphodiester bonds may be used, even between consecutive DNA units.

As referred to herein, other in one aspect of the oligonucleotide according to the invention is that the second 3' nucleotide, and/or the 9th and 10th (from the 3' end), if present, may also be LNA.

In one embodiment, the oligomer comprises at least five nucleotide analogue units, such as at least five LNA units, in positions which are complementary to the miRNA seed region.

In one embodiment, the nucleotide sequence of the oligomer which is complementary to the sequence of the microRNA seed region, is selected from the group consisting of
5 (X)xXXXXX, (X)XxXXXX, (X)XXxXXX, (X)XXXxXX, (X)XXXXxX and (X)XXXXXx, wherein "X" denotes a nucleotide analogue, such as an LNA unit, (x) denotes an optional nucleotide analogue, such as an LNA unit, and "x" denotes a DNA or RNA nucleotide unit.

In one embodiment, the oligomer comprises six or seven nucleotide analogue units, such as six or seven LNA units, in positions which are complementary to the miRNA seed region.

10 In one embodiment, the nucleotide sequence of the oligomer which is complementary to the sequence of the microRNA seed region, is selected from the group consisting of XXXXXX, XxXXXXX, XXxXXXX, XXXxXXX, XXXXxXX, XXXXXxX and XXXXXXx, wherein "X" denotes a nucleotide analogue, such as an LNA unit, such as an LNA unit, and "x" denotes a DNA or RNA nucleotide unit.

15 In one embodiment, the two nucleotide motif at position 7 to 8, counting from the 3' end of the oligomer is selected from the group consisting of xx, XX, xX and Xx, wherein "X" denotes a nucleotide analogue, such as an LNA unit, such as an LNA unit, and "x" denotes a DNA or RNA nucleotide unit.

20 In one embodiment, the two nucleotide motif at position 7 to 8, counting from the 3' end of the oligomer is selected from the group consisting of XX, xX and Xx, wherein "X" denotes a nucleotide analogue, such as an LNA unit, such as an LNA unit, and "x" denotes a DNA or RNA nucleotide unit.

25 In one embodiment, the oligomer comprises at 12 nucleotides and wherein the two nucleotide motif at position 11 to 12, counting from the 3' end of the oligomer is selected from the group consisting of xx, XX, xX and Xx, wherein "X" denotes a nucleotide analogue, such as an LNA unit, such as an LNA unit, and "x" denotes a DNA or RNA nucleotide unit.

30 In one embodiment, the oligomer comprises 12 nucleotides and wherein the two nucleotide motif at position 11 to 12, counting from the 3' end of the oligomer is selected from the group consisting of XX, xX and Xx, wherein "X" denotes a nucleotide analogue, such as an LNA unit, such as an LNA unit, and "x" denotes a DNA or RNA nucleotide unit, such as a DNA unit.

In one embodiment, the oligomer comprises a nucleotide analogue unit, such as an LNA unit, at the 5' end.

35 In one embodiment, the nucleotide analogue units, such as X, are independently selected from the group consisting of: 2'-O-alkyl-RNA unit, 2'-OMe-RNA unit, 2'-amino-DNA unit, 2'-fluoro-DNA unit, 2'-MOE-RNA unit, LNA unit, PNA unit, HNA unit, INA unit.

In one embodiment, all the nucleotides of the oligomer of the invention are nucleotide analogue units.

In one embodiment, the nucleotide analogue units, such as X, are independently selected from the group consisting of: 2'-OMe-RNA units, 2'-fluoro-DNA units, and LNA units,

5 In one embodiment, the oligomer comprises said at least one LNA analogue unit and at least one further nucleotide analogue unit other than LNA.

In one embodiment, the non-LNA nucleotide analogue unit or units are independently selected from 2'-OMe RNA units and 2'-fluoro DNA units.

10 In one embodiment, the oligomer consists of at least one sequence XYX or YXY, wherein X is LNA and Y is either a 2'-OMe RNA unit and 2'-fluoro DNA unit.

In one embodiment, the sequence of nucleotides of the oligomer consists of alternative X and Y units.

In one embodiment, the oligomer comprises alternating LNA and DNA units (Xx) or (xX). In one embodiment, the oligomer comprises a motif of alternating LNA followed by 2 DNA units
15 (Xxx), xXx or xxX.

In one embodiment, at least one of the DNA or non-LNA nucleotide analogue units are replaced with a LNA nucleotide in a position selected from the positions identified as LNA nucleotide units in any one of the embodiments referred to above. In one embodiment, "X" donates an LNA unit.

20 **Further Designs for Oligomers of the invention**

Table 1 below provides non-limiting examples of short microRNA sequences that could advantageously be targeted with an oligonucleotide of the present invention.

The oligonucleotides according to the invention, such as those disclosed in table 1 may, in one embodiment, have a sequence of 7, 8, 9 or 10 LNA nucleotides 5' – 3' LLLLLLL(L)(L)(L)(L),
25 or have a sequence of nucleotides selected from the group consisting of, the first 7, 8, 9 or 10 nucleotides of the following motifs:

LdLddL(L)(d)(d)(L)(d)(L)(d)(L)(L), LdLdLL(L)(d)(d)(L)(L)(L)(d)(L)(L),
LMLMML(L)(M)(M)(L)(M)(L)(M)(L)(L), LMLMLL(L)(M)(M)(L)(L)(L)(M)(L)(L),
LFLFFL(L)(F)(F)(L)(F)(L)(F)(L)(L), LFLFLL(L)(F)(F)(L)(L)(L)(F)(L)(L), and every third designs such as;
30 LddLdd(L)(d)(d)(L)(d)(d)(L)(d)(d)(L)(d) 'dLddLd(d)(L)(d)(d)(L)(d)(d)(L)(d)(d)(L),
ddLddL(d)(d)(L)(d)(d)(L)(d)(d)(L)(d)(d), LMMLMM(L)(M)(M)(L)(M)(M)(L)(M)(M)(L)(M),
MLMMLM(M)(L)(M)(M)(L)(M)(M)(L)(M)(M)(L), MMLMML(M)(M)(L)(M)(M)(L)(M)(M)(L)(M)(M),
LFFLFF(L)(F)(F)(L)(F)(F)(L)(F)(F)(L)(F), FLFFLF(L)(F)(F)(L)(F)(F)(L)(F)(F)(L),
FFLFFL(F)(F)(L)(F)(F)(L)(F)(F)(L)(F)(F), and dLdLdL(d)(L)(d)(L)(d)(L)(d)(L)(d) and an every second
35 design, such as; LdLdLd(L)(d)(L)(d)(L)(d)(L)(d)(L)(d)(L), MLMLML(M)(L)(M)(L)(M)(L)(M)(L)(M)(L)(M),
LMLMLM(L)(M)(L)(M)(L)(M)(L)(M)(L)(M)(L), FLFLFL(F)(L)(F)(L)(F)(L)(F)(L)(F)(L)(F), and
LFLFLF(L)(F)(L)(F)(L)(F)(L)(F)(L)(F)(L); wherein L = LNA unit, d= DNA units, M = 2'MOE RNA, F =
2'Fluoro and residues in brackets are optional.

Pharmaceutical Composition and Medical Application

The invention provides for a pharmaceutical composition comprising the oligomer according to the invention, and a pharmaceutically acceptable diluent, carrier, salt or adjuvant.

5 The invention further provides for the use of an oligonucleotide according to the invention, such as those which may form part of the pharmaceutical composition, for the manufacture of a medicament for the treatment of a disease or medical disorder associated with the presence or over-expression (upregulation) of the microRNA.

10 The invention further provides for a method for the treatment of a disease or medical disorder associated with the presence or over-expression of the microRNA, comprising the step of administering a composition (such as the pharmaceutical composition) according to the invention to a person in need of treatment.

15 The invention further provides for a method for reducing the effective amount of a miRNA in a cell or an organism, comprising administering a composition (such as the pharmaceutical composition) according to the invention or a oligomer according to the invention to the cell or the organism. Reducing the effective amount in this context refers to the reduction of functional miRNA present in the cell or organism. It is recognised that the preferred oligonucleotides according to the invention may not always significantly reduce the actual amount of miRNA in the cell or organism as they typically form very stable duplexes with their miRNA targets. The reduction of the effective amount of the miRNA in a cell may, in one embodiment, be measured
20 by detecting the level of de-repression of the miRNA's target in the cell.

The invention further provides for a method for de-repression of a target mRNA of a miRNA in a cell or an organism, comprising administering a composition (such as the pharmaceutical composition) or a oligomer according to the invention to the cell or the
25 organism.

The invention further provides for the use of a oligomer of between 7 – 10 such as 7, 8, 9, or 10 nucleotides in length, for the manufacture of a medicament for the treatment of a disease or medical disorder associated with the presence or over-expression of the microRNA.

In one embodiment the medical condition (or disease) is hepatitis C (HCV), and the miRNA is miR-122.

30 In one embodiment, the pharmaceutical composition according to the invention is for use in the treatment of a medical disorder or disease selected from the group consisting of: hepatitis C virus infection and hypercholesterolemia and related disorders, and cancers.

In one embodiment the medical disorder or disease is a CNS disease, such as a CNS disease where one or more microRNAs are known to be indicated.

35 In the context of hypercholesterolemia related disorders refers to diseases such as atherosclerosis or hyperlipidemia. Further examples of related diseases also include different types of HDL/LDL cholesterol imbalance; dyslipidemias, e.g., familial combined hyperlipidemia

(FCHL), acquired hyperlipidemia, statin-resistant hypercholesterolemia; coronary artery disease (CAD) coronary heart disease (CHD), atherosclerosis.

In one embodiment, the pharmaceutical composition according to the invention further comprises a second independent active ingredient that is an inhibitor of the VLDL assembly pathway, such as an ApoB inhibitor, or an MTP inhibitor (such as those disclosed in US 5 60/977,497).

The invention further provides for a method for the treatment of a disease or medical disorder associated with the presence or over-expression of the microRNA, comprising the step of administering a composition (such as the pharmaceutical composition) comprising an oligomer of between 7 – 10 such as 7, 8, 9, or 10 nucleotides in length, to a person in need of 10 treatment.

The invention further provides for a method for reducing the effective amount of a miRNA target (*i.e.* 'available' miRNA) in a cell or an organism, comprising administering a composition (such as the pharmaceutical composition) comprising an oligomer of between 6 7 – 10 such as 7, 15 8, 9, or 10 nucleotides in length, to the cell or the organism.

It should be recognised that "reducing the effective amount" of one or more microRNAs in a cell or organism, refers to the inhibition of the microRNA function in the cell or organism. The cell is preferably a mammalian cell or a human cell which expresses the microRNA or microRNAs.

The invention further provides for a method for de-repression of a target mRNA of a miRNA in a cell or an organism, comprising an oligomer of 7 – 10 such as 7, 8, 9, or 10 nucleotides in length, or (or a composition comprising said oligonucleotide) to the cell or the 20 organism.

As mentioned above, microRNAs are related to a number of diseases. Hence, a fourth 25 aspect of the invention relates to the use of an oligonucleotide as defined herein for the manufacture of a medicament for the treatment of a disease associated with the expression of microRNAs selected from the group consisting of spinal muscular atrophy, Tourette's syndrome, hepatitis C, fragile X mental retardation, DiGeorge syndrome and cancer, such as in non limiting example, chronic lymphocytic leukemia, breast cancer, lung cancer and colon cancer, in 30 particular cancer.

Methods of Synthesis

The invention further provides for a method for the synthesis of an oligomer targeted against a human microRNA, such as an oligomer described herein, said method comprising the steps of:

- a. Optionally selecting a first nucleotide, counting from the 3' end, which is a nucleotide 35 analogue, such as an LNA nucleotide.
- b. Optionally selecting a second nucleotide, counting from the 3' end, which is a nucleotide analogue, such as an LNA nucleotide.

c. Selecting a region of the oligomer which corresponds to the miRNA seed region, wherein said region is as defined herein.

d. Selecting a seventh and optionally an eight nucleotides defined herein.

e. Optionally selecting one or two further 5' terminal of the oligomer is as defined herein;

5 wherein the synthesis is performed by sequential synthesis of the regions defined in steps a – e, wherein said synthesis may be performed in either the 3'-5' (a to f) or 5' – 3' (e to a) direction, and wherein said oligomer is complementary to a sequence of the miRNA target.

The invention further provides for a method for the preparation of an oligomer (such as an oligomer according to the invention), said method comprising the steps of a) comparing the
10 sequences of two or more miRNA sequences to identify two or more miRNA sequences which comprise a common contiguous nucleotide sequence of at least 7 nucleotides in length, such as 7, 8, 9 or 10 nucleotides in length (i.e. a sequence found in both non-identical miRNAs), b) preparing an oligomer sequence which consists or comprises of a contiguous nucleotide sequence with is complementary to said common contiguous nucleotide sequence, wherein
15 said oligomer is, as according to the oligomer of the invention. In a preferred example, the common contiguous nucleotide sequence consists or comprises of the seed region of each of said two or more miRNA sequences (which comprise a common contiguous nucleotide sequence of at least 6 nucleotides in length). In one embodiment, the seed regions of the two or more miRNAs are identical. Suitably the oligomer consists or comprises a seedmer
20 sequence of 7 or 8 nucleotides in length which comprises of a sequence which is complementary to said two or more miRNAs. This method may be used in conjunction with step c of the above method.

The method for the synthesis of the oligomer according to the invention may be performed using standard solid phase oligonucleotide synthesis.

25 In one embodiment, the method for the synthesis of a oligomer targeted against a human microRNA, is performed in the 3' to 5' direction a - e.

A further aspect of the invention is a method to reduce the levels of target microRNA by contacting the target microRNA to an oligonucleotide as defined herein, wherein the oligonucleotide (i) is complementary to the target microRNA sequence (ii) does not contain a
30 nucleotide at the 3' end that corresponds to the first 5' end nucleotide of the target microRNA.

Duplex stability and T_m

In one embodiment, the oligomer of the invention is capable of forming a duplex with a complementary single stranded RNA nucleic acid molecule (typically of about the same length of said single stranded oligonucleotide) with phosphodiester internucleoside linkages, wherein
35 the duplex has a T_m of between 30°C and 70°C or 80°C, such as between 30°C and 60°C or 70°C, or between 30°C and 50°C or 60°C. In one embodiment the T_m is at least 40°C. T_m may be determined by determining the T_m of the oligomer and a complementary RNA target in

the following buffer conditions: 100mM NaCl, 0.1mM EDTA, 10mM Na-phosphate, pH 7.0 (see examples for a detailed protocol). A high affinity analogue may be defined as an analogue which, when used in the oligomer of the invention, results in an increase in the T_m of the oligomer as compared to an identical oligomer which contains only DNA bases.

5 **Conjugates**

In one embodiment, said oligomer is conjugated with one or more non-nucleotide (or polynucleotide) compounds.

In the context the term "conjugate" is intended to indicate a heterogenous molecule formed by the covalent attachment ("conjugation") of the oligomer as described herein to one or
10 more non-nucleotide, or non-polynucleotide moieties. Examples of non-nucleotide or non-polynucleotide moieties include macromolecular agents such as proteins, fatty acid chains, sugar residues, glycoproteins, polymers, or combinations thereof. Typically proteins may be antibodies for a target protein. Typical polymers may be polyethylene glycol.

Therefore, in various embodiments, the oligomer of the invention may comprise both a
15 polynucleotide region which typically consists of a contiguous sequence of nucleotides, and a further non-nucleotide region. When referring to the oligomer of the invention consisting of a contiguous nucleotide sequence, the compound may comprise non-nucleotide components, such as a conjugate component.

In various embodiments of the invention the oligomeric compound is linked to
20 ligands/conjugates, which may be used, e.g. to increase the cellular uptake of oligomeric compounds. WO2007/031091 provides suitable ligands and conjugates.

The invention also provides for a conjugate comprising the compound according to the invention as herein described, and at least one non-nucleotide or non-polynucleotide moiety
25 covalently attached to said compound. Therefore, in various embodiments where the compound of the invention consists of a specified nucleic acid or nucleotide sequence, as herein disclosed, the compound may also comprise at least one non-nucleotide or non-polynucleotide moiety (e.g. not comprising one or more nucleotides or nucleotide analogues) covalently attached to said compound.

30 Conjugation (to a conjugate moiety) may enhance the activity, cellular distribution or cellular uptake of the oligomer of the invention. Such moieties include, but are not limited to, antibodies, polypeptides, lipid moieties such as a cholesterol moiety, cholic acid, a thioether, e.g. Hexyl-s-tritylthiol, a thiocholesterol, an aliphatic chain, e.g., dodecandiol or undecyl residues, a phospholipids, e.g., di-hexadecyl-rac-glycerol or triethylammonium 1,2-di-o-
35 hexadecyl-rac-glycero-3-h-phosphonate, a polyamine or a polyethylene glycol chain, an adamantane acetic acid, a palmitoyl moiety, an octadecylamine or hexylamino-carbonyl-oxycholesterol moiety.

The oligomers of the invention may also be conjugated to active drug substances, for example, aspirin, ibuprofen, a sulfa drug, an antidiabetic, an antibacterial or an antibiotic.

In certain embodiments the conjugated moiety is a sterol, such as cholesterol.

In various embodiments, the conjugated moiety comprises or consists of a positively charged polymer, such as a positively charged peptides of, for example between 1 -50, such as 2 – 20 such as 3 – 10 amino acid residues in length, and/or polyalkylene oxide such as polyethylglycol(PEG) or polypropylene glycol – see WO 2008/034123.

Suitably the positively charged polymer, such as a polyalkylene oxide may be attached to the oligomer of the invention via a linker such as the releasable inker described in WO 2008/034123.

By way of example, the following conjugate moieties may be used in the conjugates of the invention:

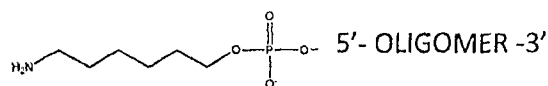
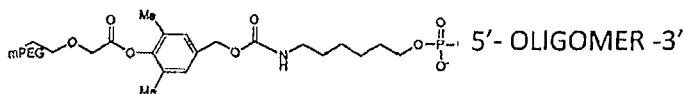

Activated oligomers

The term “activated oligomer,” as used herein, refers to an oligomer of the invention that is covalently linked (i.e., functionalized) to at least one functional moiety that permits covalent linkage of the oligomer to one or more conjugated moieties, *i.e.*, moieties that are not themselves nucleic acids or monomers, to form the conjugates herein described. Typically, a functional moiety will comprise a chemical group that is capable of covalently bonding to the oligomer via, e.g., a 3'-hydroxyl group or the exocyclic NH₂ group of the adenine base, a spacer that is preferably hydrophilic and a terminal group that is capable of binding to a conjugated moiety (e.g., an amino, sulfhydryl or hydroxyl group). In some embodiments, this terminal group is not protected, e.g., is an NH₂ group. In other embodiments, the terminal group is protected, for example, by any suitable protecting group such as those described in “Protective Groups in Organic Synthesis” by Theodora W Greene and Peter G M Wuts, 3rd edition (John Wiley & Sons, 1999). Examples of suitable hydroxyl protecting groups include esters such as acetate ester, aralkyl groups such as benzyl, diphenylmethyl, or triphenylmethyl, and tetrahydropyranyl. Examples of suitable amino protecting groups include benzyl, alpha-methylbenzyl, diphenylmethyl, triphenylmethyl, benzyloxycarbonyl, tert-butoxycarbonyl, and acyl groups such as trichloroacetyl or trifluoroacetyl. In some embodiments, the functional moiety is self-cleaving. In other embodiments, the functional moiety is biodegradable. See e.g., U.S. Patent No. 7,087,229.

In some embodiments, oligomers of the invention are functionalized at the 5' end in order to allow covalent attachment of the conjugated moiety to the 5' end of the oligomer. In other embodiments, oligomers of the invention can be functionalized at the 3' end. In still other embodiments, oligomers of the invention can be functionalized along the backbone or on the heterocyclic base moiety. In yet other embodiments, oligomers of the invention can be functionalized at more than one position independently selected from the 5' end, the 3' end, the backbone and the base.

In some embodiments, activated oligomers of the invention are synthesized by incorporating during the synthesis one or more monomers that is covalently attached to a functional moiety. In other embodiments, activated oligomers of the invention are synthesized with monomers that have not been functionalized, and the oligomer is functionalized upon completion of synthesis. In some embodiments, the oligomers are functionalized with a hindered ester containing an aminoalkyl linker, wherein the alkyl portion has the formula $(\text{CH}_2)_w$, wherein w is an integer ranging from 1 to 10, preferably about 6, wherein the alkyl portion of the alkylamino group can be straight chain or branched chain, and wherein the functional group is attached to the oligomer via an ester group $(-\text{O}-\text{C}(\text{O})-(\text{CH}_2)_w\text{NH})$.

In other embodiments, the oligomers are functionalized with a hindered ester containing a $(\text{CH}_2)_w$ -sulfhydryl (SH) linker, wherein w is an integer ranging from 1 to 10, preferably about 6, wherein the alkyl portion of the alkylamino group can be straight chain or branched chain, and wherein the functional group attached to the oligomer via an ester group $(-\text{O}-\text{C}(\text{O})-(\text{CH}_2)_w\text{SH})$.

In some embodiments, sulfhydryl-activated oligonucleotides are conjugated with polymer moieties such as polyethylene glycol or peptides (via formation of a disulfide bond).

Activated oligomers containing hindered esters as described above can be synthesized by any method known in the art, and in particular by methods disclosed in PCT Publication No. WO 2008/034122 and the examples therein.

In still other embodiments, the oligomers of the invention are functionalized by introducing sulfhydryl, amino or hydroxyl groups into the oligomer by means of a functionalizing reagent substantially as described in U.S. Patent Nos. 4,962,029 and 4,914,210, *i.e.*, a substantially linear reagent having a phosphoramidite at one end linked through a hydrophilic spacer chain to the opposing end which comprises a protected or unprotected sulfhydryl, amino or hydroxyl group. Such reagents primarily react with hydroxyl groups of the oligomer. In some embodiments, such activated oligomers have a functionalizing reagent coupled to a 5'-hydroxyl group of the oligomer. In other embodiments, the activated oligomers have a functionalizing reagent coupled to a 3'-hydroxyl group. In still other embodiments, the activated oligomers of the invention have a functionalizing reagent coupled to a hydroxyl group on the backbone of the oligomer. In yet further embodiments, the oligomer of the invention is functionalized with more than one of the functionalizing reagents as described in U.S. Patent Nos. 4,962,029 and

4,914,210. Methods of synthesizing such functionalizing reagents and incorporating them into monomers or oligomers are disclosed in U.S. Patent Nos. 4,962,029 and 4,914,210.

5 In some embodiments, the 5'-terminus of a solid-phase bound oligomer is functionalized with a dienyl phosphoramidite derivative, followed by conjugation of the deprotected oligomer with, e.g., an amino acid or peptide via a Diels-Alder cycloaddition reaction.

10 In various embodiments, the incorporation of monomers containing 2'-sugar modifications, such as a 2'-carbamate substituted sugar or a 2'-(O-pentyl-N-phthalimido)-deoxyribose sugar into the oligomer facilitates covalent attachment of conjugated moieties to the sugars of the oligomer. In other embodiments, an oligomer with an amino-containing linker at the 2'-position of one or more monomers is prepared using a reagent such as, for example, 5'-dimethoxytrityl-2'-O-(ε-phthalimidylaminopentyl)-2'-deoxyadenosine-3'-- N,N-diisopropyl-cyanoethoxy phosphoramidite. See, e.g., Manoharan, et al., Tetrahedron Letters, 1991, 34, 7171.

15 In still further embodiments, the oligomers of the invention may have amine-containing functional moieties on the nucleotide, including on the N6 purine amino groups, on the exocyclic N2 of guanine, or on the N4 or 5 positions of cytosine. In various embodiments, such functionalization may be achieved by using a commercial reagent that is already functionalized in the oligomer synthesis.

20 Some functional moieties are commercially available, for example, heterobifunctional and homobifunctional linking moieties are available from the Pierce Co. (Rockford, Ill.). Other commercially available linking groups are 5'-Amino-Modifier C6 and 3'-Amino-Modifier reagents, both available from Glen Research Corporation (Sterling, Va.). 5'-Amino-Modifier C6 is also available from ABI (Applied Biosystems Inc., Foster City, Calif.) as Aminolink-2, and 3'-Amino-Modifier is also available from Clontech Laboratories Inc. (Palo Alto, Calif.).

Therapy and pharmaceutical compositions - formulation and administration

30 As explained initially, the oligonucleotides of the invention will constitute suitable drugs with improved properties. The design of a potent and safe drug requires the fine-tuning of various parameters such as affinity/specificity, stability in biological fluids, cellular uptake, mode of action, pharmacokinetic properties and toxicity.

Accordingly, in a further aspect the present invention relates to a pharmaceutical composition comprising an oligonucleotide according to the invention and a pharmaceutically acceptable diluent, carrier or adjuvant. Preferably said carrier is saline or buffered saline.

35 In a still further aspect the present invention relates to an oligonucleotide according to the present invention for use as a medicament.

As will be understood, dosing is dependent on severity and responsiveness of the disease state to be treated, and the course of treatment lasting from several days to several months, or until a cure is effected or a diminution of the disease state is achieved. Optimal dosing schedules can be calculated from measurements of drug accumulation in the body of the patient. Optimum dosages may vary depending on the relative potency of individual oligonucleotides. Generally it can be estimated based on EC50s found to be effective in *in vitro* and *in vivo* animal models. In general, dosage is from 0.01 µg to 1 g per kg of body weight, and may be given once or more daily, weekly, monthly or yearly, or even once every 2 to 10 years or by continuous infusion for hours up to several months. The repetition rates for dosing can be estimated based on measured residence times and concentrations of the drug in bodily fluids or tissues. Following successful treatment, it may be desirable to have the patient undergo maintenance therapy to prevent the recurrence of the disease state.

As indicated above, the invention also relates to a pharmaceutical composition, which comprises at least one oligonucleotide of the invention as an active ingredient. It should be understood that the pharmaceutical composition according to the invention optionally comprises a pharmaceutical carrier, and that the pharmaceutical composition optionally comprises further compounds, such as chemotherapeutic compounds, anti-inflammatory compounds, antiviral compounds and/or immuno-modulating compounds.

The oligonucleotides of the invention can be used "as is" or in form of a variety of pharmaceutically acceptable salts. As used herein, the term "pharmaceutically acceptable salts" refers to salts that retain the desired biological activity of the herein-identified oligonucleotides and exhibit minimal undesired toxicological effects. Non-limiting examples of such salts can be formed with organic amino acid and base addition salts formed with metal cations such as zinc, calcium, bismuth, barium, magnesium, aluminum, copper, cobalt, nickel, cadmium, sodium, potassium, and the like, or with a cation formed from ammonia, *N,N*-dibenzylethylene-diamine, *D*-glucosamine, tetraethylammonium, or ethylenediamine.

In one embodiment of the invention, the oligonucleotide may be in the form of a pro-drug. Oligonucleotides are by virtue negatively charged ions. Due to the lipophilic nature of cell membranes the cellular uptake of oligonucleotides are reduced compared to neutral or lipophilic equivalents. This polarity "hindrance" can be avoided by using the pro-drug approach (see e.g. Crooke, R. M. (1998) in Crooke, S. T. *Antisense research and Application*. Springer-Verlag, Berlin, Germany, vol. 131, pp. 103-140).

Pharmaceutically acceptable binding agents and adjuvants may comprise part of the formulated drug.

Examples of delivery methods for delivery of the therapeutic agents described herein, as well as details of pharmaceutical formulations, salts, may are well described elsewhere.

Pharmaceutical compositions of the present invention include, but are not limited to, solutions, emulsions, and liposome-containing formulations. These compositions may be generated from a variety of components that include, but are not limited to, preformed liquids, self-emulsifying solids and self-emulsifying semisolids. Delivery of drug to tumour tissue may be enhanced by carrier-mediated delivery including, but not limited to, cationic liposomes, cyclodextrins, porphyrin derivatives, branched chain dendrimers, polyethylenimine polymers, nanoparticles and microspheres (Dass CR. J Pharm Pharmacol 2002; 54(1):3-27). The pharmaceutical formulations of the present invention, which may conveniently be presented in unit dosage form, may be prepared according to conventional techniques well known in the pharmaceutical industry. Such techniques include the step of bringing into association the active ingredients with the pharmaceutical carrier(s) or excipient(s). In general the formulations are prepared by uniformly and intimately bringing into association the active ingredients with liquid carriers or finely divided solid carriers or both, and then, if necessary, shaping the product. The compositions of the present invention may be formulated into any of many possible dosage forms such as, but not limited to, tablets, capsules, gel capsules, liquid syrups, soft gels and suppositories. The compositions of the present invention may also be formulated as suspensions in aqueous, non-aqueous or mixed media. Aqueous suspensions may further contain substances which increase the viscosity of the suspension including, for example, sodium carboxymethylcellulose, sorbitol and/or dextran. The suspension may also contain stabilizers. The compounds of the invention may also be conjugated to active drug substances, for example, aspirin, ibuprofen, a sulfa drug, an antidiabetic, an antibacterial or an antibiotic.

In another embodiment, compositions of the invention may contain one or more oligonucleotide compounds, targeted to a first microRNA and one or more additional oligonucleotide compounds targeted to a second microRNA target. Two or more combined compounds may be used together or sequentially.

The compounds disclosed herein are useful for a number of therapeutic applications as indicated above. In general, therapeutic methods of the invention include administration of a therapeutically effective amount of an oligonucleotide to a mammal, particularly a human. In a certain embodiment, the present invention provides pharmaceutical compositions containing (a) one or more compounds of the invention, and (b) one or more chemotherapeutic agents. When used with the compounds of the invention, such chemotherapeutic agents may be used individually, sequentially, or in combination with one or more other such chemotherapeutic agents or in combination with radiotherapy. All chemotherapeutic agents known to a person skilled in the art are here incorporated as combination treatments with compound according to the invention. Other active agents, such as anti-inflammatory drugs, including but not limited to

nonsteroidal anti-inflammatory drugs and corticosteroids, antiviral drugs, and immunomodulating drugs may also be combined in compositions of the invention. Two or more combined compounds may be used together or sequentially.

Examples of therapeutic indications which may be treated by the pharmaceutical compositions of the invention:

5

microRNA	Possible medical indications
miR-1	Cardiac arrhythmia
miR-21	Glioblastoma, breast cancer, hepatocellular carcinoma, colorectal cancer, sensitization of gliomas to cytotoxic drugs, cardiac hypertrophy
miR-21, miR-200b and miR-141	Response to chemotherapy and regulation of cholangiocarcinoma growth
miR-122	hypercholesterolemia, hepatitis C infection, hemochromatosis
miR-19b	lymphoma and other tumour types
miR-26a	Osteoblast differentiation of human stem cells
miR-155	lymphoma, pancreatic tumor development, breast and lung cancer
miR-203	Psoriasis
miR-375	diabetes, metabolic disorders, glucose-induced insulin secretion from pancreatic endocrine cells
miR-181	myoblast differentiation, auto immune disorders
miR-10b	Breast cancer cell invasion and metastasis
miR-125b-1	Breast, lung, ovarian and cervical cancer
miR-221 and 222	Prostate carcinoma, human thyroid papillary car, human hepatocellular carcinoma
miRNA-372 and -373	testicular germ cell tumors.
miR-142	B-cell leukemia
miR-17 – 19b cluster	B-cell lymphomas, lung cancer, hepatocellular carcinoma

Tumor suppressor gene tropomyosin 1 (TPM1) mRNA has been indicated as a target of miR-21. Myotrophin (mtpn) mRNA has been indicated as a target of miR 375.

10 In an even further aspect, the present invention relates to the use of an oligonucleotide according to the invention for the manufacture of a medicament for the treatment of a disease selected from the group consisting of: atherosclerosis, hypercholesterolemia and hyperlipidemia; cancer, glioblastoma, breast cancer, lymphoma, lung cancer; diabetes, metabolic disorders; myoblast differentiation; immune disorders.

15 The invention further refers to oligonucleotides according to the invention for the use in the treatment of from a disease selected from the group consisting of: atherosclerosis, hypercholesterolemia and hyperlipidemia; cancer, glioblastoma, breast cancer, lymphoma, lung cancer; diabetes, metabolic disorders; myoblast differentiation; immune disorders.

20 The invention provides for a method of treating a subject suffering from a disease or condition selected from from the group consisting of: atherosclerosis, hypercholesterolemia and hyperlipidemia; cancer, glioblastoma, breast cancer, lymphoma, lung cancer; diabetes,

metabolic disorders; myoblast differentiation; immune disorders, the method comprising the step of administering an oligonucleotide or pharmaceutical composition of the invention to the subject in need thereof.

The invention further provides for a kit comprising a pharmaceutical composition according to the invention, and a second independent active ingredient that is an inhibitor of the VLDL assembly pathway, such as an ApoB inhibitor, or an MTP inhibitor.

Cancer

In an even further aspect, the present invention relates to the use of an oligonucleotide according to the invention for the manufacture of a medicament for the treatment of cancer. In another aspect, the present invention concerns a method for treatment of, or prophylaxis against, cancer, said method comprising administering an oligonucleotide of the invention or a pharmaceutical composition of the invention to a patient in need thereof.

Such cancers may include lymphoreticular neoplasia, lymphoblastic leukemia, brain tumors, gastric tumors, plasmacytomas, multiple myeloma, leukemia, connective tissue tumors, lymphomas, and solid tumors.

In the use of a compound of the invention for the manufacture of a medicament for the treatment of cancer, said cancer may suitably be in the form of a solid tumor. Analogously, in the method for treating cancer disclosed herein said cancer may suitably be in the form of a solid tumor.

Furthermore, said cancer is also suitably a carcinoma. The carcinoma is typically selected from the group consisting of malignant melanoma, basal cell carcinoma, ovarian carcinoma, breast carcinoma, non-small cell lung cancer, renal cell carcinoma, bladder carcinoma, recurrent superficial bladder cancer, stomach carcinoma, prostatic carcinoma, pancreatic carcinoma, lung carcinoma, cervical carcinoma, cervical dysplasia, laryngeal papillomatosis, colon carcinoma, colorectal carcinoma and carcinoid tumors. More typically, said carcinoma is selected from the group consisting of malignant melanoma, non-small cell lung cancer, breast carcinoma, colon carcinoma and renal cell carcinoma. The malignant melanoma is typically selected from the group consisting of superficial spreading melanoma, nodular melanoma, lentigo maligna melanoma, acral melanoma, amelanotic melanoma and desmoplastic melanoma.

Alternatively, the cancer may suitably be a sarcoma. The sarcoma is typically in the form selected from the group consisting of osteosarcoma, Ewing's sarcoma, chondrosarcoma, malignant fibrous histiocytoma, fibrosarcoma and Kaposi's sarcoma.

Alternatively, the cancer may suitably be a glioma.

A further embodiment is directed to the use of an oligonucleotide according to the invention for the manufacture of a medicament for the treatment of cancer, wherein said

medicament further comprises a chemotherapeutic agent selected from the group consisting of adrenocorticosteroids, such as prednisone, dexamethasone or decadron™; altretamine (hexalen™, hexamethylmelamine (HMM)); amifostine (ethyol™); aminoglutethimide (cytadren™); amsacrine (M-AMSA); anastrozole (arimidex™); androgens, such as testosterone; asparaginase (elspar™); bacillus calmette-gurin; bicalutamide (casodex™); bleomycin (blenoxane™); busulfan (myleran™); carboplatin (paraplatin™); carmustine (BCNU, BiCNU™); chlorambucil (leukeran™); chlorodeoxyadenosine (2-CDA, cladribine, leustatin™); cisplatin (platinol™); cytosine arabinoside (cytarabine); dacarbazine (DTIC™); dactinomycin (actinomycin-D, cosmegen™); daunorubicin (cerubidine™); docetaxel (taxotere™); doxorubicin (adriamycin™); epirubicin; estramustine (emcyt™); estrogens, such as diethylstilbestrol (DES); etoposide (VP-16, VePesid™, etopophos™); fludarabine (fludara™); flutamide (eulexin™); 5-FUDR (floxuridine); 5-fluorouracil (5-FU); gemcitabine (gemzar™); goserelin (zodalex™); herceptin™ (trastuzumab); hydroxyurea (hydrea™); idarubicin (idamycin™); ifosfamide; IL-2 (proleukin™, aldesleukin); interferon alpha (intron A™, roferon A™); irinotecan (camptosar™); leuprolide (lupron™); levamisole (ergamisol™); lomustine (CCNU); mechlorathamine (mustargen™, nitrogen mustard); melphalan (alkeran™); mercaptopurine (purinethol™, 6-MP); methotrexate (mexate™); mitomycin-C (mutamucin); mitoxantrone (novantrone™); octreotide (sandostatin™); pentostatin (2-deoxycoformycin, nipent™); plicamycin (mithramycin, mithracin™); prorocarbazine (matulane™); streptozocin; tamoxifen (nolvadex™); taxol™ (paclitaxel); teniposide (vumon™, VM-26); thiotepa; topotecan (hycamtin™); tretinoin (vesanoid™, all-trans retinoic acid); vinblastine (velban™); vincristine (oncovin™) and vinorelbine (navelbine™). Suitably, the further chemotherapeutic agent is selected from taxanes such as Taxol™, Paclitaxel or Docetaxel.

Similarly, the invention is further directed to the use of an oligonucleotide according to the invention for the manufacture of a medicament for the treatment of cancer, wherein said treatment further comprises the administration of a further chemotherapeutic agent selected from the group consisting of adrenocorticosteroids, such as prednisone, dexamethasone or decadron™; altretamine (hexalen™, hexamethylmelamine (HMM)); amifostine (ethyol™); aminoglutethimide (cytadren™); amsacrine (M-AMSA); anastrozole (arimidex™); androgens, such as testosterone; asparaginase (elspar™); bacillus calmette-gurin; bicalutamide (casodex™); bleomycin (blenoxane™); busulfan (myleran™); carboplatin (paraplatin™); carmustine (BCNU, BiCNU™); chlorambucil (leukeran™); chlorodeoxyadenosine (2-CDA, cladribine, leustatin™); cisplatin (platinol™); cytosine arabinoside (cytarabine™); dacarbazine (DTIC™); dactinomycin (actinomycin-D, cosmegen™); daunorubicin (cerubidine™); docetaxel (taxotere™); doxorubicin (adriamycin™); epirubicin; estramustine (emcyt™); estrogens, such as diethylstilbestrol (DES); etoposide (VP-16, VePesid™, etopophos™); fludarabine (fludara™); flutamide (eulexin™); 5-FUDR (floxuridine); 5-fluorouracil (5-FU); gemcitabine (gemzar™); goserelin (zodalex™); herceptin™ (trastuzumab); hydroxyurea (hydrea™); idarubicin (idamycin™); ifosfamide; IL-2 (proleukin™, aldesleukin); interferon alpha (intron A™, roferon A™); irinotecan (camptosar™); leuprolide (lupron™); levamisole (ergamisol™);

lomustine (CCNU); mechlorathamine (mustargen™, nitrogen mustard); melphalan (alckeran™); mercaptopurine (purinethol™, 6-MP); methotrexate (mexate™); mitomycin-C (mutamucin); mitoxantrone (novantrone™); octreotide (sandostatin™); pentostatin (2-deoxycoformycin, nipent™); plicamycin (mithramycin, mithracin™); prorocarbazine (matulane™); streptozocin; tamoxifen (nolvadex™); taxol™ (paclitaxel); teniposide (vumon™, VM-26); thiotepa; topotecan (hycamtin™); tretinoin (vesanoid™, all-trans retinoic acid); vinblastine (velban™); vincristine (oncovin™) and vinorelbine (navelbine™). Suitably, said treatment further comprises the administration of a further chemotherapeutic agent selected from taxanes, such as Taxol™, Paclitaxel or Docetaxel.

Alternatively stated, the invention is furthermore directed to a method for treating cancer, said method comprising administering an oligonucleotide of the invention or a pharmaceutical composition according to the invention to a patient in need thereof and further comprising the administration of a further chemotherapeutic agent. Said further administration may be such that the further chemotherapeutic agent is conjugated to the compound of the invention, is present in the pharmaceutical composition, or is administered in a separate formulation.

Infectious diseases

It is contemplated that the compounds of the invention may be broadly applicable to a broad range of infectious diseases, such as diphtheria, tetanus, pertussis, polio, hepatitis B, hepatitis C, hemophilus influenza, measles, mumps, and rubella.

Hsa-miR122 is indicated in hepatitis C infection and as such oligonucleotides according to the invention which target miR-122 may be used to treat Hepatitis C infection.

Accordingly, in yet another aspect the present invention relates the use of an oligonucleotide according to the invention for the manufacture of a medicament for the treatment of an infectious disease, as well as to a method for treating an infectious disease, said method comprising administering an oligonucleotide according to the invention or a pharmaceutical composition according to the invention to a patient in need thereof.

In a preferred embodiment, the invention provides for a combination treatment providing an anti miR-122 oligomer in combination with an inhibitor of VLDL assembly, such as an inhibitor of apoB, or of MTP.

Inflammatory diseases

The inflammatory response is an essential mechanism of defense of the organism against the attack of infectious agents, and it is also implicated in the pathogenesis of many acute and chronic diseases, including autoimmune disorders. In spite of being needed to fight pathogens, the effects of an inflammatory burst can be devastating. It is therefore often necessary to restrict the symptomatology of inflammation with the use of anti-inflammatory drugs. Inflammation is a complex process normally triggered by tissue injury that includes activation of a large array of enzymes, the increase in vascular permeability and extravasation

of blood fluids, cell migration and release of chemical mediators, all aimed to both destroy and repair the injured tissue.

In yet another aspect, the present invention relates to the use of an oligonucleotide according to the invention for the manufacture of a medicament for the treatment of an
5 inflammatory disease, as well as to a method for treating an inflammatory disease, said method comprising administering an oligonucleotide according to the invention or a pharmaceutical composition according to the invention to a patient in need thereof.

In one preferred embodiment of the invention, the inflammatory disease is a rheumatic
10 disease and/or a connective tissue diseases, such as rheumatoid arthritis, systemic lupus erythematosus (SLE) or Lupus, scleroderma, polymyositis, inflammatory bowel disease, dermatomyositis, ulcerative colitis, Crohn's disease, vasculitis, psoriatic arthritis, exfoliative psoriatic dermatitis, pemphigus vulgaris and Sjorgren's syndrome, in particular inflammatory bowel disease and Crohn's disease.

Alternatively, the inflammatory disease may be a non-rheumatic inflammation, like
15 bursitis, synovitis, capsulitis, tendinitis and/or other inflammatory lesions of traumatic and/or sportive origin.

Metabolic diseases

A metabolic disease is a disorder caused by the accumulation of chemicals produced naturally in the body. These diseases are usually serious, some even life threatening. Others
20 may slow physical development or cause mental retardation. Most infants with these disorders, at first, show no obvious signs of disease. Proper screening at birth can often discover these problems. With early diagnosis and treatment, metabolic diseases can often be managed effectively.

In yet another aspect, the present invention relates to the use of an oligonucleotide
25 according to the invention or a conjugate thereof for the manufacture of a medicament for the treatment of a metabolic disease, as well as to a method for treating a metabolic disease, said method comprising administering an oligonucleotide according to the invention or a conjugate thereof, or a pharmaceutical composition according to the invention to a patient in need thereof.

In one preferred embodiment of the invention, the metabolic disease is selected from the
30 group consisting of Amyloidosis, Biotinidase, OMIM (Online Mendelian Inheritance in Man), Crigler Najjar Syndrome, Diabetes, Fabry Support & Information Group, Fatty acid Oxidation Disorders, Galactosemia, Glucose-6-Phosphate Dehydrogenase (G6PD) deficiency, Glutaric aciduria, International Organization of Glutaric Acidemia, Glutaric Acidemia Type I, Glutaric Acidemia, Type II, Glutaric Acidemia Type I, Glutaric Acidemia Type-II, F-HYPDRR - Familial
35 Hypophosphatemia, Vitamin D Resistant Rickets, Krabbe Disease, Long chain 3 hydroxyacyl CoA dehydrogenase deficiency (LCHAD), Mannosidosis Group, Maple Syrup Urine Disease,

Mitochondrial disorders, Mucopolysaccharidosis Syndromes: Niemann Pick, Organic acidemias, PKU, Pompe disease, Porphyria, Metabolic Syndrome, Hyperlipidemia and inherited lipid disorders, Trimethylaminuria: the fish malodor syndrome, and Urea cycle disorders.

Liver disorders

5 In yet another aspect, the present invention relates to the use of an oligonucleotide according to the invention or a conjugate thereof for the manufacture of a medicament for the treatment of a liver disorder, as well as to a method for treating a liver disorder, said method comprising administering an oligonucleotide according to the invention or a conjugate thereof, or a pharmaceutical composition according to the invention to a patient in need thereof.

10 In one preferred embodiment of the invention, the liver disorder is selected from the group consisting of Biliary Atresia, Alagille Syndrome, Alpha-1 Antitrypsin, Tyrosinemia, Neonatal Hepatitis, and Wilson Disease.

Other uses

The oligonucleotides of the present invention can be utilized for as research reagents for
15 diagnostics, therapeutics and prophylaxis. In research, the oligonucleotide may be used to specifically inhibit the synthesis of target genes in cells and experimental animals thereby facilitating functional analysis of the target or an appraisal of its usefulness as a target for therapeutic intervention. In diagnostics the oligonucleotides may be used to detect and
20 quantitate target expression in cell and tissues by Northern blotting, *in-situ* hybridisation or similar techniques. For therapeutics, an animal or a human, suspected of having a disease or disorder, which can be treated by modulating the expression of target is treated by administering the oligonucleotide compounds in accordance with this invention. Further provided are methods of treating an animal particular mouse and rat and treating a human,
25 suspected of having or being prone to a disease or condition, associated with expression of target by administering a therapeutically or prophylactically effective amount of one or more of the oligonucleotide compounds or compositions of the invention.

Therapeutic use of oligonucleotides targeting miR-122a

We have demonstrated that a LNA-antimiR, targeting miR-122a reduces plasma
30 cholesterol levels. Therefore, another aspect of the invention is use of the above described oligonucleotides targeting miR-122a as medicine.

Still another aspect of the invention is use of the above described oligonucleotides targeting miR-122a for the preparation of a medicament for treatment of increased plasma cholesterol levels (or hypercholesterolemia and related disorders). The skilled man will appreciate that increased plasma cholesterol levels is undesirable as it increases the risk of
35 various conditions, e.g. atherosclerosis.

Still another aspect of the invention is use of the above described oligonucleotides targeting miR-122a for upregulating the mRNA levels of Nrdg3, Aldo A, Bckdk or CD320.

EMBODIMENTS

The following embodiments of the present invention may be used in combination with the other embodiments described herein.

- 5 1. A pharmaceutical composition comprising an oligomer of between 6-12 nucleotides in length, wherein said oligomer comprises a contiguous nucleotide sequence of a total of between 6-12 nucleotides, such as 6, 7, 8, 9, 10, 11 or 12 nucleotide units, wherein at least 50% of the nucleobase units of the oligomer are high affinity nucleotide analogue units, and a
10 pharmaceutically acceptable diluent, carrier, salt or adjuvant.
2. The pharmaceutical composition according to embodiment 1, wherein the contiguous nucleotide sequence is complementary to a corresponding region of a mammalian, human or viral microRNA (miRNA) sequence.
3. The pharmaceutical composition according to embodiment 2, wherein the contiguous
15 nucleotide sequence is complementary to a corresponding region of a miRNA sequence selected from the group of miRNAs listed in any one of tables 3, 4 or 5.
4. The pharmaceutical composition according to embodiment 2 or 3, wherein the contiguous nucleotide sequence consists of or comprises a sequence which is complementary to the seed sequence of said microRNA.
- 20 5. The pharmaceutical composition according to any one of embodiments 2 - 4, wherein the contiguous nucleotide sequence consists of or comprises a sequence selected from any one of the sequences listed in table 3 or 4.
6. The pharmaceutical composition according to embodiment 4 or 5, wherein the 3' nucleobase of the seedmer forms the 3' most nucleobase of the contiguous nucleotide sequence, wherein
25 the contiguous nucleotide sequence may, optionally, comprise one or two further 5' nucleobases.
7. The pharmaceutical composition according to any one of embodiments 1-6, wherein said contiguous nucleotide sequence does not comprise a nucleotide which corresponds to the first nucleotide present in the micro RNA sequence counted from the 5' end.
- 30 8. The pharmaceutical composition according to any one of embodiments 1-7, wherein the contiguous nucleotide sequence is complementary to a corresponding nucleotide sequence present in a miRNA selected from those shown in table 3 or 4 or 5.
9. The pharmaceutical composition according to embodiment 8, wherein said miRNA is selected from the group consisting of miR-1, miR-10b, miR-17-3p, miR-18, miR-19a, miR-19b,
35 miR-20, miR-21, miR-34a, miR-93, miR-106a, miR-106b, miR-122, miR-133, miR-134, miR-138, miR-155, miR-192, miR-194, miR-221, miR-222, and miR-375.

10. The pharmaceutical composition according to any one of embodiments 1-9, wherein at least 60%, 65%, 70%, 75%, 80%, 85%, 90%, 95% or all of the nucleobase units of the contiguous nucleotide sequence are nucleotide analogue units.
11. The pharmaceutical composition according to embodiment 10, wherein the nucleotide analogue units are selected from the group consisting of 2'-O_alkyl-RNA unit, 2'-OMe-RNA unit, 2'-amino-DNA unit, 2'-fluoro-DNA unit, LNA unit, PNA unit, HNA unit, INA unit, and a 2'MOE RNA unit.
12. The pharmaceutical composition according to embodiment 10 or 11, wherein at least 60%, 65%, 70%, 75%, 80%, 85%, 90%, 95% or all of the nucleobase units of the contiguous nucleotide sequence are Locked Nucleic Acid (LNA) nucleobase units.
13. The pharmaceutical composition according to embodiment 12, wherein all of the nucleobase units of the contiguous nucleotide sequence are LNA nucleobase units.
14. The pharmaceutical composition according to any one of embodiments 1 - 13, wherein the contiguous nucleotide sequence comprises or consists of 7, 8, 9 or 10, preferably contiguous, LNA nucleobase units.
15. The pharmaceutical composition according to any one of embodiments 1-14, wherein the oligomer consist of 7, 8, 9 or 10 contiguous nucleobase units and wherein at least 7 nucleobase units are nucleotide analogue units.
16. The pharmaceutical composition according to embodiment 15, wherein the nucleotide analogue units are Locked Nucleic Acid (LNA) nucleobase units.
17. The pharmaceutical composition according to embodiment 15, wherein the nucleotide analogue units in the molecule consists of a mixture of at least 50% LNA units and up to 50 % other nucleotide analogue units.
18. The pharmaceutical composition according to any one of embodiments 1 - 17, wherein at least 75%, such as 80% or 85% or 90% or 95% or all of the internucleoside linkages present between the nucleobase units of the contiguous nucleotide sequence are phosphorothioate internucleoside linkages.
19. The pharmaceutical composition according to any one of embodiments 1 - 18, wherein said oligomer is conjugated with one or more non-nucleobase compounds.
20. The pharmaceutical composition according to any one of embodiments 1 - 19, wherein the contiguous nucleotide sequence is complementary to the corresponding sequence of at least two miRNA sequences such as 2, 3, 4, 5, 6, 7, 8, 9, or 10 miRNA sequences.
21. The pharmaceutical composition according to any one of embodiments 1 - 20, wherein the contiguous nucleotide sequence consists or comprises of a sequence which is complementary to the sequence of at least two miRNA seed region sequences such as 2, 3, 4, 5, 6, 7, 8, 9, or 10 miRNA seed region sequences.

22. The pharmaceutical composition according to any one of embodiments 20 or 21, wherein the contiguous nucleotide sequence is complementary to the corresponding region of both miR-221 and miR-222.
23. The pharmaceutical composition according to embodiment 22, wherein the contiguous
5 nucleotide sequence consists or comprises of a sequence that is complementary to 5'GCUACAU3'.
24. The pharmaceutical composition according to any one of embodiments 1 - 23, wherein the oligomer is constituted as a prodrug.
25. The pharmaceutical composition according to any one of embodiments 1 - 24, wherein
10 the contiguous nucleotide sequence is complementary to a corresponding region of has-miR-122.
26. The pharmaceutical composition according to embodiment 25, for use in the treatment of a medical disorder or disease selected from the group consisting of: hepatitis C virus infection and hypercholesterolemia and related disorders.
- 15 27. The pharmaceutical composition according to embodiment 25 or 26, wherein the composition further comprises a second independent active ingredient that is an inhibitor of the VLDL assembly pathway, such as an ApoB inhibitor, or an MTP inhibitor.
28. A kit comprising a pharmaceutical composition according to embodiment 25 or 26, and a
20 second independent active ingredient that is an inhibitor of the VLDL assembly pathway, such as an ApoB inhibitor, or an MTP inhibitor.
29. A method for the treatment of a disease or medical disorder associated with the presence or overexpression of a microRNA, comprising the step of administering a the pharmaceutical composition) according to any one of embodiments 1 – 28 to a patient who is suffering from, or is likely to suffer from said disease or medical disorder.
- 25 30. An oligomer, as defined according to anyone of embodiments 1 – 25.
31. A conjugate comprising the oligomer according to embodiment 30, and at least one non-nucleobase compounds.
32. The use of an oligomer or a conjugate as defined in any one of embodiments 30 - 31, for
30 the manufacture of a medicament for the treatment of a disease or medical disorder associated with the presence or over-expression of the microRNA.
33. A method for reducing the amount, or effective amount, of a miRNA in a cell, comprising administering an oligomer, a conjugate or a pharmaceutical composition, according to any one of the preceding embodiments to the cell which is expressing said miRNA so as to reduce the amount, or effective amount of the miRNA in the cell.
- 35 34. A method for de-repression of a mRNA whose expression is repressed by a miRNA in a cell comprising administering an oligomer, a conjugate or a pharmaceutical composition,

according to any one of the preceeding embodiments to the cell to the cell which expressed both said mRNA and said miRNA, in order to de-repress the expression of the mRNA.

References: Details of the reference are provided in the priority documents.

EXAMPLES

5 LNA Monomer and oligonucleotide synthesis were performed using the methodology referred to in Examples 1 and 2 of WO2007/112754. The stability of LNA oligonucleotides in human or rat plasma is performed using the methodology referred to in Example 4 of WO2007/112754. The treatment of in vitro cells with LNA anti-miR antisense oligonucleotide (targeting miR-122) is performed using the methodology referred to in Example 6 of WO2007/112754. The analysis of
10 Oligonucleotide Inhibition of miR expression by microRNA specific quantitative PCR in both an in vitro and in vivo model is performed using the methodology referred to in Example 7 of WO2007/112754. The assessment of LNA antimir knock-down specificity using miRNA microarray expression profiling is performed using the methodology referred to in Example 8 of WO2007/112754. The detection of microRNAs by in situ hybridization is performed using the
15 methodology referred to in Example 9 of WO2007/112754. The Isolation and analysis of mRNA expression (total RNA isolation and cDNA synthesis for mRNA analysis) in both an *in vitro* and *in vivo* model is performed using the methodology referred to in Example 10 of WO2007/112754. In vivo Experiments using Oligomers of the invention targeting microRNA-122. and subsequent analysis are performed using the methods disclosed in Examples 11 – 27
20 of WO2007/112754.

Example 1: Design of the LNA anti-miR oligonucleotides and melting temperatures

Table 2 – Oligomers used in the examples and figures. The SEQ# is an identifier used throughout the examples and figures – the SEQ ID NO which is used in the sequence listing is
25 also provided.

Example/Figure SEQ #	SEQ ID NO	Compound Sequence	Comment
#3204	1	TcAGtCTGaTaAgCT	
#3205	2	GATAAGCT	
#3206	3	TcAcAATtaGCAtTA	
#3207	4	TAGCATTa	
#4	5	CcAttGTcaCaCtCC	
#3208	6	CACACTCC	
#3209	7	TAAGCT	
#3210	8	ATAAGCT	
#3211	9	TGATAAGCT	
#3212	10	CTGATAAGCT	
#3213	11	GTCTGATAAGCT	
#2114	12	CAGTCTGATAAGCT	

#3215	13	TCTGATAA	
#3216	14	ATCAGTCT	
#3217	15	TCAACATC	
#3218/#3230	16	<u>GGTAAACT</u>	Underline = mismatch
#3219	17	<u>CGTAATGA</u>	Underline = mismatch
#3220	18	TCAgctcgataaGCTa	5' fluorescent label (FAM)
#3221	19	AGCACTTT	
#3222	20	ATTTGCAC	
#3223	21	AgCagACaaTgTaGC	5' fluorescent label (FAM)
#3224	22	GtAgcCAgaTgTaGC	5' fluorescent label (FAM)
#3225	23	ATGTAGC	
#3226	24	ACaAcCTacTaCcTC	
#3227	25	ACTACCTC	
#3228	26	CaCtgTCagCaCtTT	
#3229	27	TgCatAGatTiGcAC	
#3231	28	GTAGACT	
#3232	29	TACCTC	
#3233	30	CTACCTC	
#3234	31	TNCTACCTC	N = universal base.
#3235	32	TNCTACCTC	N = universal base.
#3236	33	GCaAcCTacTaCcTC	
#3237	34	ACaAcCTccTaCcTC	
#3238	35	ACaAaCTacTaCcTC	
#3239	36	CTACCTC	
#3240	37	CTAACTC	
#3241	38	TTAGCATTa	
#3242	39	CGATTAGCATTa	
#3243	977	CACGATTAGCATTa	
#3244	978	GCATTa	
#3245	979	AGCATTa	
#3246	980	ATTAGCATTa	
<p>Capital and lower case letters denote LNA and DNA, respectively. LNA cytosines are preferably methyl cytosine/5'methyl-cytosine* All internucleoside linkages are preferably phosphorothioate* All LNA may, for example, be beta-D-oxy LNA* *Used in the specific examples.</p>			

Example 2: In vitro model: Cell culture

The effect of LNA oligonucleotides on target nucleic acid expression (amount) can be tested in any of a variety of cell types provided that the target nucleic acid is present at measurable levels. Target can be expressed endogenously or by transient or stable transfection of a nucleic acid encoding said nucleic acid.

The expression level of target nucleic acid can be routinely determined using, for example, Northern blot analysis (including microRNA northern), Quantitative PCR (including microRNA qPCR), Ribonuclease protection assays. The following cell types are provided for illustrative purposes, but other cell types can be routinely used, provided that the target is expressed in the cell type chosen.

Cells were cultured in the appropriate medium as described below and maintained at 37°C at 95-98% humidity and 5% CO₂. Cells were routinely passaged 2-3 times weekly.

15PC3: The human prostate cancer cell line 15PC3 was kindly donated by Dr. F. Baas,

5 Neurozintuigen Laboratory, AMC, The Netherlands and was cultured in DMEM (Sigma) + 10% fetal bovine serum (FBS) + Glutamax I + gentamicin.

PC3: The human prostate cancer cell line PC3 was purchased from ATCC and was cultured in F12 Coon's with glutamine (Gibco) + 10% FBS + gentamicin.

10 518A2: The human melanoma cancer cell line 518A2 was kindly donated by Dr. B. Jansen, Section of experimental Oncology, Molecular Pharmacology, Department of Clinical Pharmacology, University of Vienna and was cultured in DMEM (Sigma) + 10% fetal bovine serum (FBS) + Glutamax I + gentamicin.

HeLa: The cervical carcinoma cell line HeLa was cultured in MEM (Sigma) containing 10% fetal bovine serum gentamicin at 37°C, 95% humidity and 5% CO₂.

15 MPC-11: The murine multiple myeloma cell line MPC-11 was purchased from ATCC and maintained in DMEM with 4mM Glutamax+ 10% Horse Serum.

DU-145: The human prostate cancer cell line DU-145 was purchased from ATCC and maintained in RPMI with Glutamax + 10% FBS.

20 RCC-4 +/- VHL: The human renal cancer cell line RCC4 stably transfected with plasmid expressing VHL or empty plasmid was purchased from ECACC and maintained according to manufacturers instructions.

786-0: The human renal cell carcinoma cell line 786-0 was purchased from ATCC and maintained according to manufacturers instructions

25 HUVEC: The human umbilical vein endothelial cell line HUVEC was purchased from Camcrex and maintained in EGM-2 medium.

K562: The human chronic myelogenous leukaemia cell line K562 was purchased from ECACC and maintained in RPMI with Glutamax + 10% FBS. U87MG: The human glioblastoma cell line U87MG was purchased from ATCC and maintained according to the manufacturers instructions.

30 B16: The murine melanoma cell line B16 was purchased from ATCC and maintained according to the manufacturers instructions.

LNCap: The human prostate cancer cell line LNCap was purchased from ATCC and maintained in RPMI with Glutamax + 10% FBS

35 Huh-7: Human liver, epithelial like cultivated in Eagles MEM with 10 % FBS, 2mM Glutamax I, 1x non-essential amino acids, Gentamicin 25 µg/ml

L428: (Deutsche Sammlung für Mikroorganismen (DSM, Braunschweig, Germany)): Human B cell lymphoma maintained in RPMI 1640 supplemented with 10% FCS, L-glutamine and antibiotics.

L1236: (Deutsche Sammlung für Mikroorganismen (DSM, Braunschweig, Germany)): Human B
5 cell lymphoma maintained in RPMI 1640 supplemented with 10% FCS, L-glutamine and antibiotics.

Example 3: Design of a LNA anti-miR library for all human microRNA sequences in miRBase microRNA database.

The miRBase version used was version 12, as reported in Griffiths-Jones, S., Grocock, R.J.,
10 van Dongen, S., Bateman, A., Enright, A.J. 2006. miRBase: microRNA sequences, targets and gene nomenclature. Nucleic Acids Res. 34: D140-4.

Table 1 shows 7, 8 and 9mer nucleotide sequences comprising the seedmer sequence of micro
RNA's according to the miRBase micro RNA database. The seedmer sequence comprises the
15 reverse complement of the microRNA seed region. In some embodiments the oligomer of the invention has a contiguous nucleotide sequence selected from the 7mer, 8mer or 9mer sequences. With respect to the 7mer, 8mer and 9mer sequences, in some embodiments, all the internucleoside linkages are phosphorothioate. The 7mer, 8mer and 9mer nucleotide sequences may consist of sequence of nucleotide analogues as described herein, such as LNA
20 nucleotide analogues. LNA cytosines may be methyl-cytosine (5'-methyl-cytosine). In some embodiments, the LNA is beta-D-oxy-LNA.

Table 3 provides a list of microRNAs grouped into those which can be targeted by the same seedmer oligomers, such as the 7, 8 or 9mers provided herein (see table 1).

Table 3
hsa-let-7a*, hsa-let-7f-1*
hsa-let-7a, hsa-let-7b, hsa-let-7c, hsa-let-7d, hsa-let-7f, hsa-miR-98, hsa-let-7g, hsa-let-7i
hsa-miR-1, hsa-miR-206
hsa-miR-103, hsa-miR-107
hsa-miR-10a, hsa-miR-10b
hsa-miR-125b, hsa-miR-125a-5p
hsa-miR-129*, hsa-miR-129-3p
hsa-miR-130a, hsa-miR-301a, hsa-miR-130b, hsa-miR-454, hsa-miR-301b
hsa-miR-133a, hsa-miR-133b
hsa-miR-135a, hsa-miR-135b
hsa-miR-141, hsa-miR-200a
hsa-miR-146a, hsa-miR-146b-5p
hsa-miR-152, hsa-miR-148b
hsa-miR-154*, hsa-miR-487a

hsa-miR-15a, hsa-miR-16, hsa-miR-15b, hsa-miR-195, hsa-miR-497
hsa-miR-17, hsa-miR-20a, hsa-miR-93, hsa-miR-106a, hsa-miR-106b, hsa-miR-20b, hsa-miR-526b*
hsa-miR-181a, hsa-miR-181c
hsa-miR-181b, hsa-miR-181d
hsa-miR-18a, hsa-miR-18b
hsa-miR-190, hsa-miR-190b
hsa-miR-192, hsa-miR-215
hsa-miR-196a, hsa-miR-196b
hsa-miR-199a-3p, hsa-miR-199b-3p
hsa-miR-199a-5p, hsa-miR-199b-5p
hsa-miR-19a*, hsa-miR-19b-1*, hsa-miR-19b-2*
hsa-miR-19a, hsa-miR-19b
hsa-miR-200b, hsa-miR-200c
hsa-miR-204, hsa-miR-211
hsa-miR-208a, hsa-miR-208b
hsa-miR-212, hsa-miR-132
hsa-miR-23a*, hsa-miR-23b*
hsa-miR-23a, hsa-miR-23b, hsa-miR-130a*
hsa-miR-24-1*, hsa-miR-24-2*
hsa-miR-25, hsa-miR-92a, hsa-miR-367, hsa-miR-92b
hsa-miR-26a, hsa-miR-26b
hsa-miR-26a-1*, hsa-miR-26a-2*
hsa-miR-27a, hsa-miR-27b
hsa-miR-29a, hsa-miR-29b, hsa-miR-29c
hsa-miR-302a, hsa-miR-302b, hsa-miR-302c, hsa-miR-302d, hsa-miR-373, hsa-miR-520e, hsa-miR-520a-3p, hsa-miR-520b, hsa-miR-520c-3p, hsa-miR-520d-3p
hsa-miR-302b*, hsa-miR-302d*
hsa-miR-30a*, hsa-miR-30d*, hsa-miR-30e*
hsa-miR-30a, hsa-miR-30c, hsa-miR-30d, hsa-miR-30b, hsa-miR-30e
hsa-miR-330-5p, hsa-miR-326
hsa-miR-34a, hsa-miR-34c-5p, hsa-miR-449a, hsa-miR-449b
hsa-miR-362-3p, hsa-miR-329
hsa-miR-374a, hsa-miR-374b
hsa-miR-376a, hsa-miR-376b
hsa-miR-378, hsa-miR-422a
hsa-miR-379*, hsa-miR-411*
hsa-miR-381, hsa-miR-300
hsa-miR-509-5p, hsa-miR-509-3-5p
hsa-miR-515-5p, hsa-miR-519e*
hsa-miR-516b*, hsa-miR-516a-3p
hsa-miR-517a, hsa-miR-517c
hsa-miR-518a-5p, hsa-miR-527
hsa-miR-518f, hsa-miR-518b, hsa-miR-518c, hsa-miR-518a-3p, hsa-miR-518d-3p
hsa-miR-519c-3p, hsa-miR-519b-3p, hsa-miR-519a
hsa-miR-519c-5p, hsa-miR-519b-5p, hsa-miR-523*, hsa-miR-518f*, hsa-miR-526a, hsa-miR-520c-

5p, hsa-miR-518e*, hsa-miR-518d-5p, hsa-miR-522*, hsa-miR-519a*
hsa-miR-519e, hsa-miR-33b*
hsa-miR-520a-5p, hsa-miR-525-5p
hsa-miR-520g, hsa-miR-520h
hsa-miR-524-5p, hsa-miR-520d-5p
hsa-miR-525-3p, hsa-miR-524-3p
hsa-miR-548b-5p, hsa-miR-548a-5p, hsa-miR-548c-5p, hsa-miR-548d-5p
hsa-miR-7-1*, hsa-miR-7-2*
hsa-miR-99a, hsa-miR-100, hsa-miR-99b

We have constructed an 8-mer LNA-antimiR against miR-21, miR-155 and miR-122 (designated here as micromiR) that is fully LNA modified and phosphorothiolated (see figure 1 and Table 6).

Our results from repeated experiments in MCF-7, HeLa, Raw and Huh-7 cells using a luciferase sensor plasmid for miR-21, miR-155 and miR-122 demonstrate that the fully LNA-modified short

5 LNA-antimiRs are highly potent in antagonizing microRNAs.

Table 4. LNA_antimiR & MicromiR sequences and predicted T_m s

SEQ ID #	microRNA	sequence	T_m (°C)
3204	miR-21	T c A G t C T G a T a A g C T	73
3205		G A T A A G C T	33
3206	miR-155	T c A c A A T t a G C A t T A	63
3207		T A G C A T T A	45
4	miR-122	C c A t t G T c a C a C t C C	73
3208		C A C A C T C C	62

Capital letters are LNA units, such as beta-D-oxo LNA. Lower case letters are DNA units. Internucleoside linkages are preferably phosphorothioate. LNA cytosines are all preferably methylated/5-methyl cytosine.

The melting temperatures can be assessed towards the mature microRNA sequence, using a synthetic microRNA oligonucleotide (typically consisting of RNA nucleotides with a phosphodiester backbone). Typically measured T_m s are higher than predicted T_m s when using LNA oligomers against the RNA target.

10

Example 4: Assessment of miR-21 antagonism by SEQ ID #3205 LNA-antimiR in MCF-7 cells using a luciferase sensor assay.

In order to assess the efficiency of a fully LNA-modified 8-mer LNA-antimiR (SEQ ID #3205) oligonucleotide in targeting and antagonizing miR-21, luciferase sensor constructs were made containing a perfect match target site for the mature miR-21 and as control, a target site with two mutations in the seed (Fig. 6). In order to monitor microRNA-21 inhibition, the breast carcinoma cell line MCF-7 was transfected with the different luciferase constructs together with the miR-21 antagonist SEQ ID #3205 at varying concentrations in comparison with a 15-mer LNA-antimiR SEQ ID #3204 against miR-21. After 24 hours, luciferase activity was measured.

20 **Results:** As seen in Figure 2, the new fully LNA-modified 8-mer LNA-antimiR (SEQ ID #3205) shows two-fold higher potency compared to SEQ ID #3204, as shown by de-repression of the

luciferase activity. By contrast, the control miR-21 sensor construct with two mismatches in the miR-21 seed did not show any de-repression of the firefly luciferase activity, thereby demonstrating the specificity of the perfect match miR-21 sensor in monitoring miR-21 activity in cells. The de-repression of luciferase activity by the 8-mer LNA-antimiR is clearly dose-
5 dependent, which is not seen with SEQ ID #3204. Moreover, the new 8-mer is also much more potent at lower doses than SEQ ID #3204.

To conclude, the 8-mer LNA-antimiR (SEQ ID #3205) shows significantly improved potency in inhibition of miR-21 *in vitro* compared to the 15-mer LNA-antimiR SEQ ID #3204 targeting miR-21.

10 **Materials and Methods:**

Cell line: The breast carcinoma cell line MCF-7 was purchased from ATCC (#HTB-22™). MCF-7 cells were cultured in EMEM medium, supplemented with 10% fetal bovine serum, 2 mM Glutamax, 1x NEAA and 25 ug/ml Gentamicin.

Transfection: 400.000 cells were seeded per well in a 6-well plate the day before transfection in
15 order to receive 50-70% confluency the next day. On the day of transfection, MCF-7 cells were transfected with 0.8 ug miR-21 perfect match/psiCHECK2, miR-21.mm2/psiCHECK2 or empty psiCHECK2 vector (SDS Promega™) together with 1 µl Lipofectamine2000™ (Invitrogen™) according to manufacturer's instructions. After 24 hours, cells were harvested for luciferase measurements.

Luciferase assay: The cells were washed with PBS and harvested with cell scraper, after which
20 cells were centrifugated for 5 min at 10.000 rpm. The supernatant was discarded and 50 µl 1 x Passive Lysis Buffer (Promega™) was added to the cell pellet, after which cells were put on ice for 30 min. The lysed cells were spinned at 10.000 rpm for 30 min after which 20 µl were transferred to a 96 well plate and luciferase measurements were performed according to
25 manufacturer's instructions (Promega).

Example 5: Assessment of miR-21 antagonism by SEQ ID #3205 LNA-antimiR in HeLa cells using a luciferase sensor assay.

To further assess the efficiency of the fully LNA-modified 8-mer LNA-antimiR SEQ ID #3205 in
30 targeting miR-21, the cervix carcinoma cell line HeLa was also transfected with the previously described miR-21 luciferase sensor constructs alongside SEQ ID #3205 at varying concentrations as described in the above section (Figure 3).

Results: The SEQ ID #3205 shows complete de-repression of the miR-21 luciferase sensor construct in HeLa cells already at 5 nM compared to SEQ ID #3204, which did not show
35 complete de-repression until the highest dose (50 nM). In addition, antagonism of miR-21 by the 8-mer SEQ ID #3205 LNA-antimiR is dose-dependent. To demonstrate the specificity of the

miR-21 luciferase sensor assay, a mismatched miR-21 target site (2 mismatches in seed) was also transfected into HeLa cells, but did not show any de-repression of the firefly luciferase activity.

To conclude, the fully LNA-modified SEQ ID #3205 shows significantly improved potency in inhibition of miR-21 *in vitro*, in both MCF-7 and HeLa cells compared to the 15-mer LNA-antimiR SEQ ID #3204.

Materials and Methods:

Cell line: The human cervix carcinoma cell line HeLa was purchased from ECACC (#93021013). HeLa cells were cultured in EMEM medium, supplemented with 10% fetal bovine serum, 2 mM Glutamax, 1x NEAA and 25 ug/ml Gentamicin.

Transfection: 60.000 cells were seeded per well in a 24 well plate the day before transfection in order to receive 50-70% confluency the next day. On the day of transfection, HeLa cells were transfected with 0.2 ug miR-21 perfect match/psiCHECK2™, miR-21.mm2/psiCHECK2™ or empty psiCHECK2™ vector together with 0,7 µl Lipofectamine2000 (Invitrogen) according to manufacturer's instructions. After 24 hours, cells were harvested for luciferase measurements.

Luciferase assay: The cells were washed with PBS and 100 µl 1 x Passive Lysis Buffer (Promega) was added to each well, after which the 24 well plates was put on an orbital shaker for 30 min. The cells were collected and transferred to an eppendorf tube and spinned at 10.000 rpm for 30 min after which 10 µl were transferred to a 96 well plate and luciferase measurements were performed according to manufacturer's instructions (Promega).

Example 6: Assessment of miR-155 antagonism by SEQ ID #3207 LNA-antimiR in mouse RAW cells using a luciferase sensor assay.

To ask whether a fully LNA-modified 8-mer LNA-antimiR can effectively antagonize miR-155, a perfect match target site for miR-155 was cloned into the same luciferase vector (psiCHECK2™) and transfected into the mouse leukaemic monocyte macrophage RAW cell line. Because the endogenous levels of miR-155 are low in the RAW cell line, the cells were treated with 100 ng/ml LPS for 24 hours in order to induce miR-155 accumulation.

Results: Luciferase measurements showed that the fully LNA-modified 8-mer LNA-antimiR SEQ ID #3207 targeting miR-155 was similarly effective in antagonizing miR-155 compared to the 15-mer LNA-antimiR SEQ ID #3206 (Figure 4). Both LNA-antimirs showed a >50% de-repression of the miR-155 luciferase sensor at 0.25 nM concentration and inhibited miR-155 in a dose-dependent manner.

Conclusion: These data further support the results from antagonizing miR-21, as shown in examples 1 and 2, demonstrating that a fully thiolated 8-mer LNA-antimiR is highly potent in microRNA targeting.

Materials and Methods:

Cell line: The mouse leukaemic monocyte macrophage RAW 264.7 was purchased from ATCC (TIB-71). RAW cells were cultured in DMEM medium, supplemented with 10% fetal bovine serum, 4 mM Glutamax and 25 ug/ml Gentamicin.

5 Transfection: 500.000 cells were seeded per well in a 6 well plate the day before transfection in order to receive 50% confluency the next day. On the day of transfection, MCF-7 cells were transfected with 0.3 ug miR-155 or empty psiCHECK2 vector together with 10 µl Lipofectamine2000 (Invitrogen) according to manufacturer's instructions. In order to induce miR-155 accumulation, LPS (100 ng/ml) was added to the RAW cells after the 4 hour incubation with
10 the transfection complexes. After another 24 hours, cells were harvested for luciferase measurements.

Luciferase assay: The cells were washed with PBS and harvested with cell scraper, after which cells were centrifugated for 5 min at 2.500 rpm. The supernatant were discarded and 50 µl 1 x Passive Lysis Buffer (Promega) was added to the cell pellet, after which cells were put on ice
15 for 30 min. The lysed cells were spinned at 10.000 rpm for 30 min after which 20 µl were transferred to a 96 well plate and luciferase measurments were performed according to manufacturer's instructions (Promega).

Example 7: Assessment of miR-122 antagonism by SEQ ID #3208 LNA-antimiR in HuH-7 cells using a luciferase sensor assay.

20 The potency of the fully modified 8-mer LNA-antimiR SEQ ID #3208 against miR-122 was assessed in the human hepatoma cell line HuH-7. The HuH-7 cells were transfected with luciferase sensor construct containing a perfect match miR-122 target site. After 24 hours luciferase measurements were performed (Figure 5).

25 **Results:** The fully LNA-modified 8-mer LNA-antimiR SEQ ID #3208 is more potent than the 15-mer LNA-antimiR SEQ ID #4 at low concentration, as shown by de-repression of the miR-122 luciferase sensor. Both LNA-antimiRs inhibit miR-122 in a dose-dependet manner (Figure 5).

Conclusion: The fully LNA-modified 8-mer LNA-antimiR SEQ ID #3208 targeting miR-122 shows improved potency in inhibition of miR-122 *in vitro*.

Materials and Methods:

30 Cell line: The human hepatoma cell line HuH-7 was a kind gift from R. Bartenschlager, Heidelberg. Huh-7 cells were cultured in EMEM medium, supplemented with 10% fetal bovine serum, 2 mM Glutamax, 1x NEAA and 25 ug/ml Gentamicin.

35 Transfection: 8.000 cells were seeded per well in a 96 well plate the day before transfection in order to receive 50-70% confluency the next day. On the day of transfection, HuH-7 cells were transfected with 57 ng miR-122 or empty psiCHECK2 vector together with 1 µl

Lipofectamine2000 (Invitrogen). After 24 hours, cells were harvested for luciferase measurements.

Luciferase assay: 50 μ l 1 x Passive Lysis Buffer (Promega) was added to each well, after which the 96 well plate was put on an orbital shaker for 30 min. To each well the Dual-luciferase Reporter assay system (Promega) was added and luciferase measurements were performed according to manufacturer's instructions (Promega).

Example 8. Assessment of miR-21 antagonism by comparing an 8-mer (SEQ ID #3205) versus a 15-mer (SEQ ID #3204) LNA-antimiR in human prostate carcinoma cells (PC3).

10 We have previously shown (patent application 1051), that an 8-mer LNA-antimiR that is fully LNA-modified and phosphorothiolated is able to completely de-repress the miR-21 luciferase reporter levels in the human cervix carcinoma cell line HeLa and partly de-repress the miR-21 luciferase reporter levels in the human breast carcinoma cell line MCF-7. We next extended this screening approach to the human prostate cancer cell line PC3. To assess the efficiency of the different LNA-antimiR oligonucleotides against miR-21, luciferase reporter constructs were
15 generated in which a perfect match target site for the mature miR-21 and a target site with two mismatches in the seed were cloned in the 3'UTR of Renilla luciferase gene (Figure 7). In order to monitor miR-21 inhibition, PC3 cells were transfected with the different luciferase constructs together with the miR-21 antagonist SEQ ID #3205 (8-mer) and for comparison with the 15-mer LNA-antimiR perfect match SEQ ID #3204 at varying concentrations. After 24 hours, luciferase
20 activity was measured.

Results: The luciferase reporter experiments showed a dose-dependent de-repression of the luciferase miR-21 reporter activity with the 15-mer LNA-antimiR against miR-21 (SEQ ID #3204). However, complete de-repression of the luciferase reporter was not obtained even at
25 the highest concentrations (Figure 7). In contrast, the cells that were transfected with the 8-mer fully LNA substituted LNA-antimiR showed complete de-repression already at 1 nM, indicating significantly improved potency compared to the 15-mer LNA-antimiR. The luciferase control reporter harboring a mismatch target site for miR-21 was not affected by either LNA-antimiR, demonstrating high specificity of both LNA-antimiRs.

30 **Conclusion:** The micromer is far more potent than the 15-mer LNA-antimiR in targeting miR-21 and has so far shown to be most potent in prostate carcinoma cells.

Materials and Methods:

Cell line: The human prostate carcinoma PC3 cell line was purchased from ECACC (#90112714). PC3 cells were cultured in DMEM medium, supplemented with 10% fetal bovine
35 serum, 2 mM Glutamax and 25 ug/ml Gentamicin.

Transfection: 100.000 cells were seeded per well in a 12-well plate the day before transfection in order to receive 50% confluency the next day. On the day of transfection, PC3 cells were

transfected with 0.3 μg miR-21 or empty psiCHECK2 vector together with 1,2 μl Lipofectamine2000 (Invitrogen) according to manufacturer's instructions. Transfected was also varying concentrations of LNA-antimiRs. After 24 hours, cells were harvested for luciferase measurements.

5 Luciferase assay: The cells were washed with PBS and 250 μl 1 x Passive Lysis Buffer (Promega) was added to the wells. The plates were placed on a shaker for 30 min., after which the cell lysates were transferred to eppendorf tubes. The cell lysate was centrifugated for 10 min at 2.500 rpm after which 20 μl were transferred to a 96 well plate and luciferase measurements were performed according to manufacturer's instructions (Promega).

10

Example 9. Specificity assessment of miR-21 antagonism by an 8-mer LNA-antimiR

To investigate the specificity of our short LNA-antimiR targeting miR-21, we designed an 8-mer mismatch control LNA-antimiR (SEQ ID #3218) containing 2 mismatches in the seed recognition sequence (see Figure 8). The luciferase reporter constructs described in example 1 were transfected into the human cervix carcinoma cell line HeLa together with the LNA mismatch control oligo SEQ ID #3218 and its efficacy was compared with the 8-mer LNA-antimiR (SEQ ID #3205) targeting miR-21. After 24 hours, luciferase activity was measured.

15 **Results:** As shown in Figure 8, transfection of the fully LNA-modified 8-mer LNA-antimiR in HeLa cells resulted in complete de-repression of the luciferase miR-21 reporter already at 5 nM. In contrast, when the cells were transfected with the 8-mer LNA mismatch control oligo, combined with the results obtained with the control miR-21 luciferase reporter having two mismatches in the miR-21 seed, these data demonstrate high specificity of the fully LNA-substituted 8-mer LNA-antimiR in targeting miR-21 in Hela cells.

20 Analysis of the miRBase microRNA sequence database showed that the miR-21 recognition sequence, of the LNA-antimiR SEQ ID #3205 is unique for microRNA-21. However, when decreasing the micromer length to 7 nt, it is not specific for only miR-21, since ath-miR-844, mmu-miR-590-3p and has-miR-590-3p are also targeted.

25 **Conclusion:**Exchanging two nucleotide positions within the 8-mer LNA-antimiR with two mismatching nucleotides completely abolished the antagonizing activity of the LNA-antimiR for miR-21.

Materials and Methods:

Cell line: The human cervix carcinoma cell line HeLa was purchased from ECACC (#93021013). HeLa cells were cultured in EMEM medium, supplemented with 10% fetal bovine serum, 2 mM Glutamax, 1x NEAA and 25 $\mu\text{g}/\text{ml}$ Gentamicin.

35 Transfection: 60.000 cells were seeded per well in a 24-well plate the day before transfection in order to receive 50-70% confluency the next day. On the day of transfection, HeLa cells were

transfected with 0.2 ug miR-21perfect match/psiCHECK2, miR-21.mm2/psiCHECK2 or empty psiCHECK2 vector together with 0,7 µl Lipofectamine2000 (Invitrogen) according to manufacturer's instructions. Transfected was also varying concentrations of LNA-antimiRs. After 24 hours, cells were harvested for luciferase measurements.

5 Luciferase assay: The cells were washed with PBS and 100 µl 1 x Passive Lysis Buffer (Promega) was added to each well, after which the 24-well plates were put on an orbital shaker for 30 min. The cells were collected and transferred to an eppendorf tube and spun at 10.000 rpm for 30 min after which 10 µl were transferred to a 96-well plate and luciferase measurements were performed according to manufacturer's instructions (Promega).

10

Example 10. Assessment of the shortest possible length of a fully LNA-modified LNA-antimiR that mediates effective antagonism of miR-21.

To further investigate the LNA-antimiR length requirements, we designed a 7-mer and a 6-mer LNA-antimiR targeting miR-21, both fully LNA-modified and phosphorothiolated
15 oligonucleotides. The miR-21 luciferase reporter constructs were transfected into HeLa cells along with the LNA-antimiRs at varying concentrations. Luciferase measurements were performed after 24 hours.

Results: As seen in Figure 9, the 7-mer LNA-antimiR mediates de-repression of the miR-21 luciferase reporter plasmid, but at lower potency compared to the 8-mer LNA-antimiR (SEQ ID
20 #3205). Nevertheless, a dose-dependent trend can still be observed. By contrast, the 6-mer LNA-antimiR did not show any inhibitory activity.

Conclusion: To conclude, the shortest possible length of an LNA-antimiR which is able to mediate miR-21 inhibition is 7 nucleotides. However, the 7-mer LNA-antimiR is less potent compared to the 8-mer LNA-antimiR for miR-21.

25 **Materials and Methods:**

Cell line: The human cervix carcinoma cell line HeLa was purchased from ECACC (#93021013). HeLa cells were cultured in EMEM medium, supplemented with 10% fetal bovine serum, 2 mM Glutamax, 1x NEAA and 25 ug/ml Gentamicin.

Transfection: 60.000 cells were seeded per well in a 24 well plate the day before transfection in
30 order to receive 50-70% confluency the next day. On the day of transfection, HeLa cells were transfected with 0.2 ug miR-21perfect match/psiCHECK2, miR-21.mm2/psiCHECK2 or empty psiCHECK2 vector together with 0,7 µl Lipofectamine2000™ (Invitrogen) according to manufacturer's instructions. Transfected was also varying concentrations of LNA-antimiRs. After 24 hours, cells were harvested for luciferase measurements.

35 Luciferase assay: The cells were washed with PBS and 100 µl 1 x Passive Lysis Buffer (Promega) was added to each well, after which the 24-well plates was put on an orbital shaker

for 30 min. The cells were collected and transferred to an eppendorf tube and spinned at 10.000 rpm for 30 min after which 10 µl were transferred to a 96-well plate and luciferase measurements were performed according to manufacturer's instructions (Promega).

5 **Example 11. Length assessment of fully LNA-substituted LNA-antimiRs antagonizing miR-21**

Next, we investigated the effect of increasing the length from a 9-mer to a 14-mer fully LNA substituted LNA-antimiRs on antagonizing miR-21 in HeLa cells. The resulting LNA-antimiRs were transfected into HeLa cells together with the miR-21 luciferase reporter constructs (Figure 10). Luciferase measurements were performed after 24 hours.

Results: The 9-mer LNA-antimiR SEQ ID #3211 (9-mer) showed dose-dependent de-repression of the miR-21 luciferase reporter which did not reach complete de-repression, as demonstrated for the 7-mer LNA-antimiR (SEQ ID #3210). Increasing the length to 10-mer to 14-mer (SEQ ID #3212, SEQ ID #3213 and SEQ ID #3214) decreased the potency as shown by less efficient de-repression of the miR-21 reporter.

Conclusion: As shown in Figure 10, the longest fully LNA-modified and phosphorothiolated LNA-antimiR which is still able to mediate miR-21 inhibition is a 9-mer LNA-antimiR SEQ ID #3211. However, it is clearly less efficient than the 7-mer and 8-mer LNA-antimiRs.

Materials and Methods: Cell line: The human cervix carcinoma cell line HeLa was purchased from ECACC (#93021013). HeLa cells were cultured in EMEM medium, supplemented with 10% fetal bovine serum, 2 mM Glutamax, 1x NEAA and 25 µg/ml Gentamicin.

Transfection: 60.000 cells were seeded per well in a 24-well plate the day before transfection in order to achieve 50-70% confluency the next day. On the day of transfection, HeLa cells were transfected with 0.2 µg miR-21 perfect match/psiCHECK2, miR-21.mm2/psiCHECK2 or empty psiCHECK2 control vector without target site together with 0,7 µl Lipofectamine2000 (Invitrogen) according to manufacturer's instructions. Transfected was also varying concentrations of LNA-antimiRs. After 24 hours, cells were harvested for luciferase measurements.

Luciferase assay: The cells were washed with PBS and 100 µl 1 x Passive Lysis Buffer (Promega) was added to each well, after which the 24-well plates were put on an orbital shaker for 30 min. The cells were collected and transferred to an eppendorf tube and spinned at 10.000 rpm for 30 min after which 10 µl were transferred to a 96-well plate and luciferase measurements were performed according to manufacturer's instructions (Promega).

35 **Example 12. Determination of the most optimal position for an 8-mer LNA-antimiR within the miR target recognition sequence.**

Our experiments have shown that the most potent fully LNA-modified phosphorothiolated LNA-antimiR is 8 nucleotides in length. To assess the most optimal position for an 8-mer LNA-antimiR within the miR target recognition sequence, we designed four different fully LNA-modified 8-mer LNA-antimiRs tiled across the mature miR-21 sequence as shown in Figure 11.

5 The different LNA-antimiRs were co-transfected together with the miR-21 luciferase reporter constructs into HeLa cells. Luciferase measurements were performed after 24 hours.

Results: The only LNA-antimiR that mediated efficient silencing of miR-21 as measured by the luciferase reporter was SEQ ID #3205, which targets the seed region of miR-21. Neither SEQ ID #3215 which was designed to cover the 3' end of the seed (50% seed targeting) did not show
10 any effect, nor did the other two LNA-antimiRs SEQ ID #3216 or SEQ ID #3217, which were positioned to target the central region and the 3' end of the mature miR-21, respectively.

Conclusion: The only 8-mer LNA-antimiR mediating potent silencing of miR-21 is the one targeting the seed of the miR-21.

Materials and Methods:

15 **Cell line:** The human cervix carcinoma cell line HeLa was purchased from ECACC (#93021013). HeLa cells were cultured in EMEM medium, supplemented with 10% fetal bovine serum, 2 mM Glutamax, 1x NEAA and 25 ug/ml Gentamicin.

Transfection: 60.000 cells were seeded per well in a 24-well plate the day before transfection in order to achieve 50-70% confluency the next day. On the day of transfection, HeLa cells were
20 transfected with 0.2 ug miR-21 perfect match/psiCHECK2, miR-21.mm2/psiCHECK2 or empty psiCHECK2 vector together with 0,7 µl Lipofectamine2000 (Invitrogen) according to the manufacturer's instructions. Transfected was also varying concentrations of LNA-antimiRs. After 24 hours, cells were harvested for luciferase measurements.

Luciferase assay: The cells were washed with PBS and 100 µl 1 x Passive Lysis Buffer
25 (Promega) was added to each well, after which the 24-well plates was put on an orbital shaker for 30 min. The cells were collected and transferred to an eppendorf tube and spinned at 10.000 rpm for 30 min after which 10 µl were transferred to a 96 well plate and luciferase measurements were performed according to manufacturer's instructions (Promega).

30 **Example 13. Validation of interaction of the miR-21 target site in the Pcdcd4-3'-UTR and miR-21 using the 8-mer SEQ ID #3205 LNA-antimiR.**

The tumour suppressor protein Pcdcd4 inhibits TPA-induced neoplastic transformation, tumour promotion and progression. Pcdcd4 has also been shown to be upregulated in apoptosis in response to different inducers. Furthermore, downregulation of Pcdcd4 in lung and colorectal
35 cancer has also been associated with a poor patient prognosis. Recently, Asangani *etal* and Frankel *et al* showed that the Pcdcd4-3'-UTR contains a conserved target site for miR-21, and

transfecting cells with an anti-miR-21, resulted in an increase in Pdc4 protein. We therefore constructed a luciferase reporter plasmid, harboring 313 nt of the 3'UTR region of Pdc4 encompassing the aforementioned miR-21 target site, which was co-transfected together with different LNA-anti-miRs into HeLa cells. The different LNA-anti-miRs were; SEQ ID #3205 (8-mer, perfect match) or SEQ ID #3218 (8-mer, mismatch). Luciferase measurements were performed after 24 hours.

Results: As shown in Figure 12, in cells transfected with the Pdc4 3'UTR luciferase reporter and SEQ ID #3205, an increase in luciferase activity was observed, indicating interaction between the Pdc4 3'UTR and miR-21. However, transfecting the cells with the mismatch compound, SEQ ID #3218, no change in luciferase activity was observed, which was expected since the compound does not antagonize miR-21. When comparing the 8-mer LNA-anti-miR against two longer designed LNA-anti-miRs, the short fully LNA-modified and phosphorothiolated LNA-anti-miR was significantly more potent, confirming previous luciferase assay data.

Conclusion: These data conclude that SEQ ID #3205, which antagonizes miR-21, can regulate the interaction between Pdc4 3'UTR and miR-21.

Materials and Methods:

Cell line: The human cervix carcinoma cell line HeLa was purchased from ECACC (#93021013). HeLa cells were cultured in EMEM medium, supplemented with 10% fetal bovine serum, 2 mM Glutamax, 1x NEAA and 25 ug/ml Gentamicin.

Transfection: 60,000 cells were seeded per well in a 24-well plate the day before transfection in order to achieve 50-70% confluency the next day. On the day of transfection, HeLa cells were transfected with 0.2 ug Pdc4-3'UTR/psiCHECK2 or empty psiCHECK2 vector together with 0.7 µl Lipofectamine2000 (Invitrogen) according to the manufacturer's instructions. Varying concentrations of the LNA-anti-miR oligonucleotides were also transfected. After 24 hours, cells were harvested for luciferase measurements.

Luciferase assay: The cells were washed with PBS and 100 µl 1 x Passive Lysis Buffer (Promega) was added to each well, after which the 24-well plates was put on an orbital shaker for 30 min. The cells were collected and transferred to an eppendorf tube and spun at 10,000 rpm for 30 min after which 10 µl were transferred to a 96 well plate and luciferase measurements were performed according to manufacturer's instructions (Promega).

Example 14. Comparison of an 8-mer LNA-anti-miR (SEQ ID #3207) with a 15-mer LNA-anti-miR (SEQ ID #3206) in antagonizing miR-155 in mouse RAW cells.

To ask whether our approach of using short LNA-anti-miRs could be adapted to targeting other miRNAs we designed a fully LNA-modified 8-mer LNA-anti-miR against microRNA-155. A perfect match target site for miR-155 was cloned into the 3'UTR of the luciferase gene in the reporter

plasmid psiCHECK2 and transfected into the mouse RAW macrophage cell line together with an 8-mer or a 15-mer LNA-antimiR. Because the endogenous levels of miR-155 are low in the RAW cell line, the cells were treated with 100 ng/ml LPS for 24 hours in order to induce miR-155 accumulation. After 24 hours, luciferase analysis was performed.

5 **Results:** Luciferase measurements showed that the fully LNA-modified 8-mer LNA-antimiR SEQ ID #3207 targeting miR-155 was similarly effective in antagonizing miR-155 compared to the 15-mer LNA-antimiR SEQ ID #3206 (Figure 13). Both LNA-antimiRs showed a >50% de-repression of the miR-155 luciferase sensor at 0.25 nM concentration and inhibited miR-155 in a dose-dependent manner.

10 Analysis of the miRBase microRNA sequence database showed that the miR-155 recognition sequence, of the LNA-antimiR SEQ ID #3207 is unique for microRNA-155. However, when decreasing the LNA-antimiR length to 7 nt, it is not specific for only miR-155, mdv1-miR-M4 and kshv-miR-K12-11 is also targeted.

.**Conclusion:** A fully LNA-modified and phosphorothiolated 8-mer LNA-antimiR is equally potent
15 compared with a 15-mer LNA-antimiR of a mixed LNA/DNA design in antagonizing miR-155. Thus, our approach of using short LNA-antimiRs can be readily adapted to targeting of other miRNAs

Materials and Methods:

Cell line: The mouse macrophage RAW 264.7 cell line was purchased from ATCC (TIB-71).

20 RAW cells were cultured in DMEM medium, supplemented with 10% fetal bovine serum, 4 mM Glutamax and 25 ug/ml Gentamicin.

Transfection: 500.000 cells were seeded per well in a 6-well plate the day before transfection in order to receive 50% confluency the next day. On the day of transfection, RAW 264.7 cells were transfected with 0.3 ug miR-155 perfect match/psiCHECK2 or empty psiCHECK2 vector
25 together with 10 µl Lipofectamine2000 (Invitrogen) according to the manufacturer's instructions. Transfected was also varying concentrations of LNA-antimiRs. In order to induce miR-155 accumulation, LPS (100 ng/ml) was added to the RAW cells after the 4 hour incubation with the transfection complexes. After another 24 hours, cells were harvested for luciferase measurements.

30 Luciferase assay: The cells were washed with PBS and harvested with cell scraper, after which cells were spinned for 5 min at 2.500 rpm. The supernatant was discarded and 50 µl 1 x Passive Lysis Buffer (Promega) was added to the cell pellet, after which cells were put on ice for 30 min. The lysed cells were spinned at 10.000 rpm for 30 min after which 20 µl were transferred to a 96-well plate and luciferase measurements were performed according to the
35 manufacturer's instructions (Promega).

Example 15. Assessment of c/EBP β protein levels as a functional readout for miR-155 antagonism by short LNA-antimiR (SEQ ID #3207).

As a functional readout for miR-155 antagonism by short LNA-antimiR (SEQ ID #3207) we determined the protein levels of a novel miR-155 target, c/EBP β . The mouse macrophage RAW cell line was transfected together with either an 8-mer (SEQ ID #3207) or a 15-mer (SEQ ID #3206) LNA-antimiR in the absence or presence of pre-miR-155. As mismatch controls for the 15-mer, SEQ ID #4 was used, which targets miR-122 and for the 8-mer SEQ ID #3205 was used, which targets miR-21. These two control miRNAs do not regulate c/EBP β expression levels. LPS was used to induce miR-155 accumulation and cells were harvested after 16 hours with LPS. c/EBP β has three isoforms; LIP, LAP and LAP* that were detected by Western blot analysis and the same membranes were re-probed with beta-tubulin as loading control.

Results: Ratios were calculated for c/EBP β LIP and beta-tubulin as indicated in Figure 14. RAW cells that were transfected with the 15-mer LNA-antimiR and no pre-miR-155 all showed equal c/EBP β LIP/beta-tubulin ratios, due to inhibition of miR-155 increases the c/EBP β LIP levels (Figure 14, left panel). By comparison, transfection of pre-miR-155 in RAW cells resulted in decreased c/EBP β LIP levels as expected, if c/EBP β was a miR-155 target, as shown in lanes with protein extracts from RAW cells treated with no LNA or a mismatch. However, protein extracts from RAW cells transfected with LNA-antimiR against miR-155, showed an increase of c/EBP β LIP levels. The same experiments were also carried out with the 8-mer LNA-antimiR-155 (SEQ ID #3207) and as shown in Figure 14 (right panel) comparable results to those with the 15-mer LNA-antimiR SEQ ID #3206 were obtained.

Conclusion: Antagonism of miR-155 using either an 8-mer or a 15-mer LNA-antimiR leads to de-repression of the direct target c/EBP β .

Materials and Methods:

Cell line: The mouse macrophage RAW 264.7 cell line was purchased from ATCC (TIB-71). RAW cells were cultured in DMEM medium, supplemented with 10% fetal bovine serum, 4 mM Glutamax and 25 ug/ml Gentamicin.

Transfection: 500,000 cells were seeded per well in a 6-well plate the day before transfection in order to achieve 50% confluency the next day. On the day of transfection, RAW 264.7 cells were transfected with 5 nmol pre-miR-155 (Ambion) and/or 5 nM LNA-antimiR together with 10 μ l Lipofectamine2000 (Invitrogen) according to the manufacturer's instructions. Transfected was also varying concentrations of LNA-antimiRs. In order to induce miR-155 accumulation, LPS (100 ng/ml) was added to the RAW cells after the 4 hour incubation with the transfection complexes. After 16 hours, cells were harvested for protein extraction and western blot analysis.

Western blot: Cells were washed with PBS, trypsinated, transferred to eppendorf tubes and 250 μ l lysis buffer (1xRIPA) was added. The cell lysate was placed on ice for 20 min and spinned at

10.000 rpm for 10 minutes. The protein concentration was measured with Coomassie Plus according to the manufacturer's instructions and 80 ug was loaded onto a 4-12% BIS-TRIS gel. The membrane was incubated overnight at 4°C with the primary monoclonal mouse antibody C/EBP β (Santa Cruz) with a 1:100 concentration. Immunoreactive bands were visualized with
5 ECL Plus (Amersham).

Example 16. Antagonism of miR-106b by a fully LNA-modified 8-mer (SEQ ID #3221) LNA-antimiR

To confirm that our approach of using short LNA-antimiRs could be adapted to targeting of other
10 miRNAs we designed a fully LNA-modified 8-mer LNA-antimiR against microRNA-106b. A perfect match target site for miR-106b was cloned into the 3'UTR of the luciferase gene in the vector (psiCHECK2) and transfected into the human cervix carcinoma HeLa cell line together with a short LNA-antimiR (SEQ ID #3221) or with a 15-mer LNA-antimiR (SEQ ID #3228) at varying concentrations. Luciferase measurements were performed after 24 hours.

15 **Results:** Transfection of the 8-mer LNA-antimiR SEQ ID #3221 against miR-106b resulted in dose-dependent inhibition of miR-106b as shown by de-repression of the luciferase reporter, which was completely de-repressed at 1 nM LNA-antimiR concentration (Figure 15).

Comparable results were obtained using the 15-mer LNA-antimiR SEQ ID #3228 demonstrating that an 8-mer LNA-antimiR is similarly potent to a 15-mer.

20 **Conclusion:** Targeting of miR-106b in HeLa cells shows that an 8-mer fully LNA-modified and phosphorotiolated LNA-antimiR is equally potent compared with a 15-mer LNA/DNA mixmer LNA-antimiR.

Materials and Methods:

Cell line: The human cervix carcinoma cell line HeLa was purchased from ECACC
25 (#93021013). HeLa cells were cultured in EMEM medium, supplemented with 10% fetal bovine serum, 2 mM Glutamax, 1x NEAA and 25 ug/ml Gentamicin.

Transfection: 5.200 cells were seeded per well in a 96-well plate the day before transfection in order to achieve 50-70% confluency the next day. On the day of transfection, HeLa cells were transfected with 57 ng miR-21perfect match/psiCHECK2, miR-21.mm2/psiCHECK2 or empty
30 psiCHECK2 vector together with 0,14 μ l Lipofectamine2000 (Invitrogen) according to the manufacturer's instructions. Transfected was also varying concentrations of LNA-antimiRs. After 24 hours, cells were harvested for luciferase measurements.

Luciferase assay: The cells were washed with PBS and 30 μ l 1 x Passive Lysis Buffer (Promega) was added to each well, after which the 24-well plates was put on an orbital shaker
35 for 30 min. The cells were collected and transferred to eppendorf tubes and spinned at 10.000

rpm for 30 min after which luciferase measurements were performed according to the manufacturer's instructions (Promega).

Example 17. Antagonism of miR-19a by a fully LNA-modified 8-mer (SEQ ID #3222) LNA-antimiR

5 To further confirm that our approach of using short LNA-antimiRs can be readily adapted to targeting of other miRNAs we designed a fully LNA-modified 8-mer LNA-antimiR against microRNA-19a. A perfect match target site for miR-19a was cloned in the 3'UTR of the luciferase gene in the psiCHECK2 vector. The reporter plasmid was transfected into the human cervix carcinoma HeLa cell line together with a short LNA-antimiR (SEQ ID #3222) or with a 15-
10 mer LNA-antimiR (SEQ ID #3229) targeting miR-19a at varying concentrations. Luciferase measurements were performed after 24 hours.

Results: As shown in Figure 16, transfection of the 15-mer LNA-antimiR SEQ ID #3229 into HeLa efficiently antagonizes miR-19a as demonstrated by complete de-repression at 1 nM LNA-antimiR concentration. By comparison, transfection of the 8-mer LNA-antimiR SEQ ID
15 #3222 resulted in effective miR-19a antagonism already at 0.5 nM concentration, indicating that this 8-mer LNA-antimiR is at least equally potent compared with a 15-mer LNA-antimiR in HeLa cells.

Conclusion: Targeting of miR-19a in HeLa cells shows that an 8-mer fully LNA-modified and phosphorothiolated LNA-antimiR is at least equally potent compared with a 15-mer LNA/DNA
20 mixmer LNA-antimiR.

Materials and Methods: *Cell line:* The human cervix carcinoma cell line HeLa was purchased from ECACC (#93021013). HeLa cells were cultured in EMEM medium, supplemented with 10% fetal bovine serum, 2 mM Glutamax, 1x NEAA and 25 ug/ml Gentamicin.

Transfection: 5.200 cells were seeded per well in a 96-well plate the day before transfection in
25 order to achieve 50-70% confluency the next day. On the day of transfection, HeLa cells were transfected with 57 ng miR-21perfect match/psiCHECK2, miR-21.mm2/psiCHECK2 or empty psiCHECK2 vector together with 0,14 µl Lipofectamine2000 (Invitrogen) according to manufacturer's instructions. Transfected was also varying concentrations of LNA-antimiRs. After 24 hours, cells were harvested for luciferase measurements.

30 *Luciferase assay:* The cells were washed with PBS and 30 µl 1 x Passive Lysis Buffer (Promega) was added to each well, after which the 24-well plates was put on an orbital shaker for 30 min. The cells were collected and transferred to eppendorf tubes and spinned at 10.000 rpm for 30 min after which luciferase measurements were performed according to the manufacturer's instructions (Promega).

35

Example 18. Targeting of a microRNA family using short, fully LNA-substituted LNA-antimiR.

Next, we investigated whether it is possible to target a microRNA family using a single short 7-mer LNA-antimiR complementary to the seed sequence that is common for all family members (see Figure 17). In this experiment, we focused on miR-221 and miR-222 that are overexpressed in solid tumors of the colon, pancreas, prostate and stomach. It has also been shown that miR-221 and miR-222 are the most significantly upregulated microRNAs in glioblastoma multiforme. Furthermore, overexpression of miR-221 and miR-222 may contribute to the growth and progression of prostate carcinoma, at least in part by blocking the tumor suppressor protein p27. A perfect match target site for both miR-221 and miR-222, respectively, was cloned into the 3'UTR of the luciferase gene resulting in two reporter constructs. These constructs were then transfected either separate or combined into the prostate carcinoma cell line, PC3. In addition to the 7-mer, targeting both miR-221 and miR-222, we also co-transfected a 15-mer LNA-antimiR (15mer) targeting either miR-221 (SEQ ID #3223) or miR-222 (SEQ ID #3224), each transfected separately or together (see Figure 18 left).

Results: As shown in Figure 18, transfection of PC3 cells with the LNA-antimiR SEQ ID #3223 against miR-221 resulted in efficient inhibition of miR-221 at 1 nM LNA-antimiR concentration. An inhibitory effect is also observed when using the luciferase reporter plasmid for miR-222 as well as when co-transfecting both luciferase reporters for miR-221 and miR-222 simultaneously into PC3 cells. This inhibitory effect is most likely due to the shared seed sequence between miR-221 and miR-222. Similarly, transfection of PC3 cells with the LNA-antimiR SEQ ID #3224 against miR-222 resulted in efficient inhibition of miR-222 at 1 nM LNA-antimiR concentration as shown by complete de-repression of the luciferase reporter for miR-222. An inhibitory effect is also observed when using the luciferase reporter plasmid for miR-222 as well as when co-transfecting both luciferase reporters for miR-221 and miR-222 simultaneously into PC3 cells. Co-transfection of both LNA-antimiR compounds SEQ ID #3223 and SEQ ID #3224 against miR-221 and miR-222, respectively, (see Figure 18 left), resulted in effective inhibition of both miRNAs as shown by complete de-repression of the luciferase reporter plasmids both when separately transfected and when co-transfected into PC3 cells. Interestingly, transfection of a single fully LNA-modified 7-mer LNA-antimiR (SEQ ID #3225) targeting the seed sequence of miR-221 and miR-222 into PC3 cells resulted in efficient, dose-dependent antagonism of miR-221 and miR-222 simultaneously as shown by complete de-repression of the luciferase reporter plasmids both when separately transfected and when co-transfected into PC3 cells. This demonstrates that a single, short LNA-substituted LNA-antimiR can effectively target seed sequences thereby antagonizing entire microRNA families simultaneously. Analysis of the miRBase microRNA sequence database showed that the miR-221/222 seed recognition sequence, of the LNA-antimiR SEQ ID #3225 is unique for both miRNAs.

Conclusion: Our results demonstrate that LNA enables design and synthesis of short fully LNA-substituted LNA-antimiR oligonucleotides that can effectively target microRNA seed sequences thereby antagonizing entire microRNA families simultaneously.

Materials and Methods:

5 Cell line: The human prostate carcinoma PC3 cell line was purchased from ECACC (#90112714) PC3 cells were cultured in DMEM medium, supplemented with 10% fetal bovine serum, 2 mM Glutamax and 25 ug/ml Gentamicin.

10 Transfection: 100.000 cells were seeded per well in a 12-well plate the day before transfection in order to receive 50% confluency the next day. On the day of transfection, PC3 cells were transfected with 0.3 ug of luciferase reporter plasmid for miR-221 or for miR-222 or with empty psiCHECK2 vector without miRNA target site as control together with 1,2 µl Lipofectamine2000 (Invitrogen) according to the manufacturer's instructions. After 24 hours, cells were harvested for luciferase measurements.

15 Luciferase assay: The cells were washed with PBS and 250 µl 1 x Passive Lysis Buffer (Promega) was added to the wells. The plates were placed on a shaker for 30 min., after which the cell lysates was transferred to eppendorf tubes. The cell lysate was spinned for 10 min at 2.500 rpm after which 20 µl were transferred to a 96-well plate and luciferase measurements were performed according to the manufacturer's instructions (Promega).

20 **Example 19. Assessment of p27 protein levels as a functional readout for antagonism of the miR-221/222 family by the 7-mer SEQ ID #3225 LNA-antimiR.**

Previous work has shown (le Sage et al. 2007, Galardi et al. 2007) that miR-221 and miR-222 post-transcriptionally regulate the expression of the tumour suppressor gene p27, which is involved in cell cycle regulation. In these studies, down-regulation of miR-221 and miR-222 was shown to increase expression levels of p27. Thus, as a functional readout for antagonism of the miR-221/222 family by the 7-mer SEQ ID #3225 LNA-antimiR we determined the protein levels of p27 after transfection of the LNA-antimiR SEQ ID #3225 into PC3 cells in comparison with an 8-mer LNA mismatch control. After 24 hours the cells were harvested for western blot analysis (Figure 19).

30 **Results:** As shown in Figure 19, transfection of the 7-mer LNA-antimiR SEQ ID #3225 targeting the seed sequence in miR-221 and miR-222 resulted in dose-dependent increase of the p27 protein levels compared to either untransfected or LNA mismatch control transfected PC3 cells. These results clearly demonstrate that the 7-mer LNA-antimiR is able to effectively antagonize the miR-221/222 family leading to de-repression of the direct target p27 at the protein level.

Conclusion: A fully LNA-modified 7-mer LNA-antimiR targeting the seed sequence in the miR-221/222 family effectively antagonized both miRNAs leading to de-repression of the direct target p27 at the protein level.

Materials and Methods:

5 Cell line: The human prostate carcinoma PC3 cell line was purchased from ECACC (#90112714) PC3 cells were cultured in DMEM medium, supplemented with 10% fetal bovine serum, 2 mM Glutamax and 25 ug/ml Gentamicin.

10 Transfection: 250,000 cells were seeded per well in a 6-well plate the day before transfection in order to receive 50% confluency the next day. On the day of transfection, PC3 cells were transfected with LNA-antimiRs at varying concentrations with Lipofectamine2000. Cells were harvested after 24 hours for protein extraction and western blot analysis.

15 Western blot: Cells were washed with PBS, trypsinated, transferred to eppendorf tubes and 250 μ l lysis buffer (1xRIPA) was added. The cell lysate was placed on ice for 20 min, then spinned at 10,000 rpm for 10 minutes. The protein concentration was measured with Coomassie Plus according to the manufacturer's instructions and 100 ug was loaded onto a 4-12% BIS-TRIS gel. The membrane was incubated overnight at 4°C with the primary monoclonal mouse antibody p27 (BD Biosciences) at a 1:1000 dilution. Immunoreactive bands were visualized with ECL Plus (Amersham).

20 **Example 20. Duplex melting temperatures (T_m) of the LNA-antimiRs.**

As shown in Table 5, T_m values increase with increasing the length of short fully modified LNA-antimiRs (see T_m values for SEQ ID #3205, SEQ ID #3209-3214 in Table 7). Most optimal inhibitory effect was achieved with the 8-mer LNA-antimiR SEQ ID #3205 against miR-21, whereas the very low T_m of the 6-mer SEQ ID #3209 is most likely not sufficient to mediate antagonism of the miR-21 target. On the other hand, increasing the length beyond a 10-mer (SEQ ID #3212) significantly increases the T_m , while simultaneously decreasing the inhibitory activity as measured using the luciferase miR-21 reporter, which is most likely due to high propensity of the fully modified 12- and 14-mer LNA-antimiRs to form homodimers. The experiments using a sliding window of fully LNA-modified 8-mer LNA-antimirs across the mir-21 recognition sequence clearly demonstrate that in addition to adequate T_m value of the LNA-antimiR, the seed region is most critical for miRNA function and, thus, the most optimal region to be targeted by an LNA-antimiR.

25

30

Table 5: T_m values for miR-21 LNA-antimiRs, measured against a complementary RNA oligonucleotide

SEQ ID #	microRN A	Length (bp)	Sequence	Measured T_m (RNA) °C
3205	miR-21	8	5'- GATAAGCT -3'	64,0
3209	miR-21	6	5'- TAAGCT -3'	32,0
3210	miR-21	7	5'- ATAAGCT -3'	45,0
3211	miR-21	9	5'- TGATAAGCT -3'	65,0
3212	miR-21	10	5'- CTGATAAGCT -3'	63,0
3213	miR-21	12	5'- GTCTGATAAGCT -3'	86,8
3214	miR-21	14	5'- CAGTCTGATAAGCT -3'	89,9
3215	miR-21	8	5'- TCTGATAA - 3'	56,0
3216	miR-21	8	5'- ATCAGTCT - 3	72,0
3217	miR-21	8	5'- TCAACATC - 3	48,0

Conclusion: The T_m values along with experimental data obtained with luciferase reporters

5 show that potent antagonism by LNA-antimiR is not only dependent on T_m but also depends on the positioning of the LNA-antimiR within the microRNA recognition sequence.

Materials and Methods:

T_m measurements: The oligonucleotide:miR-21 RNA duplexes were diluted to 3 μ M in 500 μ l RNase free H₂O and mixed with 500 μ l 2x T_m -buffer (200 mM NaCl, 0.2 mM EDTA, 20 mM Na-phosphate, pH 7,0). The solution was heated to 95°C for 3 min and then allowed to anneal in
10 RT for 30 min. The duplex melting temperatures (T_m) were measured on a Lambda 40 UV/VIS Spectrophotometer equipped with a Peltier™ temperature programmer PTP6 using PE Templab software (Perkin Elmer). The temperature was ramped up from 20°C to 95°C and then down to 25°C, recording absorption at 260 nm. First derivative and the local maximums of both the
15 melting and annealing were used to assess the duplex melting temperatures.

Example 21. Assessment of miR-21 antagonism by comparing an 8-mer (SEQ ID #3205) versus a 15-mer (SEQ ID #3204) LNA-antimiR in human hepatocytic cell line HepG2.

We have previously shown in this application, that an 8-mer LNA-antimiR that is fully LNA-
20 modified and phosphorothiolated effectively antagonizes miR-21 in the human cervix carcinoma cell line HeLa, the human breast carcinoma cell line MCF-7 and the human prostate cancer cell line PC3. We extended this screening approach to the human hepatocellular cancer cell line HepG2. To assess the efficiency of the 8-mer LNA-antimiR oligonucleotide against miR-21, luciferase reporter constructs were generated in which a perfect match target site for the mature
25 miR-21 was cloned into the 3'UTR of the Renilla luciferase gene. In order to monitor miR-21 inhibition, HepG2 cells were transfected with the luciferase constructs together with the miR-21 antagonist SEQ ID #3205 (8-mer) and for comparison of specificity with the 8-mer LNA-antimiR

mismatch (SEQ ID #3218) and for comparison of potency together with the 15-mer (SEQ ID #3204) at varying concentrations. After 24 hours, luciferase activity was measured.

Results: The luciferase reporter experiments showed a dose-dependent de-repression of the luciferase miR-21 reporter activity with the 15-mer LNA-antimiR against miR-21 (SEQ ID #3204). However, complete de-repression of the luciferase reporter was not obtained, not even at the higher concentrations (Figure 20). In contrast, the cells that were transfected with the 8-mer fully LNA modified LNA-antimiR (SEQ ID #3205) showed complete de-repression already at 5 nM, indicating significantly improved potency compared to the 15-mer LNA-antimiR. Comparing the specificity of the 8-mer perfect match and the 8-mer mismatch, the mismatch LNA-antimiR (SEQ ID #3218) did not show any de-repression at all, demonstrating high specificity of the LNA-antimiR compound against miR-21.

Conclusion: The 8-mer (SEQ ID #3205) is more potent than the 15-mer LNA-antimiR in targeting miR-21 and antagonism of miR-21 by SEQ ID #3205 is specific.

Materials and Methods:

Cell line: The human hepatocytic HepG2 cell line was purchased from ECACC (#85011430). HepG2 cells were cultured in EMEM medium, supplemented with 10% fetal bovine serum, 2 mM Glutamax and 25 ug/ml Gentamicin.

Transfection: 650.000 cells were seeded per well in a 6-well plate and reverse transfection were performed. HepG2 cells were transfected with 0.6 µg miR-21 or empty psiCHECK2 vector together with 2,55 µl Lipofectamine2000 (Invitrogen) according to manufacturer's instructions. Transfected was also varying concentrations of LNA-antimiRs. After 24 hours, cells were harvested for luciferase measurements.

Luciferase assay: The cells were washed with PBS and 300 µl 1 x Passive Lysis Buffer (Promega) was added to the wells. The plates were placed on a shaker for 30 min., after which the cell lysates were transferred to eppendorf tubes. The cell lysate was centrifugated for 10 min at 2.500 rpm after which 50 µl were transferred to a 96 well plate and luciferase measurements were performed according to the manufacturer's instructions (Promega).

Example 22. Validation of interaction of the miR-21 target site in the Pdc4 3'UTR and miR-21 using the 8-mer SEQ ID #3205 LNA-antimiR in human hepatocellular cell line Huh-7.

The tumour suppressor protein Pdc4 inhibits tumour promotion and progression. Furthermore, downregulation of Pdc4 in lung and colorectal cancer has also been associated with poor patient prognosis. Recently, Asangani *et al* (Oncogene 2007) and Frankel *et al* (J Biol Chem 2008) showed that the Pdc4 3'UTR contains a conserved target site for miR-21, and transfecting cells with an antimiR-21, resulted in an increase in Pdc4 protein. We therefore

constructed a luciferase reporter plasmid, harboring 313 nt of the 3'UTR region of Pdc4 encompassing the aforementioned miR-21 target site, which was co-transfected together with different LNA-antimiRs and pre-miR-21 (10 nM) into Huh-7 cells. The different LNA-antimiRs were; SEQ ID #3205 (8-mer, perfect match), SEQ ID #3218 (8-mer, mismatch) and SEQ ID #3204 (15-mer, DNA/LNA mixmer). Luciferase measurements were performed after 24 hours.

Results: As shown in Figure 21, cells transfected with the Pdc4 3'UTR luciferase reporter and SEQ ID #3205, an increase in luciferase activity was observed, indicating interaction between the Pdc4 3'UTR and miR-21. However, transfecting the cells with the mismatch compound, SEQ ID #3218, no change in luciferase activity was observed, which was expected since the compound does not antagonize miR-21. When comparing the 8-mer LNA-antimiR against the 15-mer LNA-antimiR (SEQ ID #3204), the short fully LNA-modified and phosphorothiolated LNA-antimiR was significantly more potent, confirming previous data.

Materials and Methods:

Cell line: The human hepatoma cell line Huh-7 was a kind gift from R. Bartinschlager (Dept Mol Virology, University of Heidelberg). Huh-7 cells were cultured in DMEM medium, supplemented with 10% fetal bovine serum, 2 mM Glutamax, 1x NEAA and 25 ug/ml Gentamicin.

Transfection: 11.000 cells were seeded per well in a 96-well plate the day before transfection in order to achieve 50-70% confluency the next day. On the day of transfection, Huh-7 cells were transfected with 20 ng Pdc4 3'UTR/psiCHECK2 or empty psiCHECK2 vector together with 10 nM pre-miR-21 (Ambion) and 0,14 µl Lipofectamine2000 (Invitrogen) according to the manufacturer's instructions. Varying concentrations of the LNA-antimiR oligonucleotides were also transfected. After 24 hours, cells were harvested for luciferase measurements.

Luciferase assay: Cells were washed and 30 µl 1 x Passive Lysis Buffer (Promega) was added to each well, after which the 96-well plates was put on an orbital shaker. After 30 min., 50 µl luciferase substrate dissolved in Luciferase Assay Buffer II (Dual-Luciferase Reporter Assay System from Promega, Cat# E1910) was added to the wells with lysated cells and luciferase measurements were performed according to the manufacturer's instructions (Promega).

Example 23. Assessment of Pdc4 protein levels as a functional readout for miR-21 antagonism by the 8-mer LNA-antimiR (SEQ ID #3205).

In addition, we also transfected HeLa cells with SEQ ID #3205 (perfect match), SEQ ID #3218 (mismatch), SEQ ID #3219 (scrambled) and analyzed Pdc4 protein levels after 24 hours with Western blot (Figure 22). As shown, in the protein extracts from cells where SEQ ID #3205 had been added, the Pdc4 protein levels increase, due to antagonism of mir-21 by SEQ ID #3205 in contrast to the two control LNA oligonucleotides.

Conclusion: Antagonism of miR-21 using an 8-mer (SEQ ID #3205) leads to derepression of the direct target Pcd4. Antagonism of miR-21

Materials and Methods:

Cell line: The human cervix carcinoma cell line HeLa was purchased from ECACC

5 (#93021013). HeLa cells were cultured in EMEM medium, supplemented with 10% fetal bovine serum, 2 mM Glutamax, 1x NEAA and 25 ug/ml Gentamicin.

Transfection: 200.000 cells were seeded per well in a 6-well plate the day before transfection in order to receive 50-70% confluency the next day. On the day of transfection, HeLa cells were transfected with 5 nM LNA oligonucleotides and 2,5 µg/ml Lipofectamine2000 (Invitrogen) according to the manufacturer's instructions. After 24 hours, cells were harvested for Western blot analysis.

Western blot: Cells were washed with PBS, trypsinated, transferred to eppendorf tubes and 50 µl lysis buffer (1xRIPA) was added. The cell lysate was placed on ice for 20 min and spinned at 10.000 rpm for 10 minutes. Equal amounts (15 µl cell lysate) were loaded onto a 4-12% BIS-TRIS gel. The proteins were transferred to a nitrocellulose membrane using iBlot™ (Invitrogen) according to manufacturers instructions. The membrane was incubated overnight at 4°C with the primary affinity purified rabbit serum antibody Pcd4 (Rockland) with a 1:2000 concentration. As control, anti- beta tubulin antibodies (Thermo Scientific) were used at a 1:5000 dilution. Immunoreactive bands were visualized with ECL Plus™ (Amersham).

Example 24. Assessment of potential hepatotoxicity of the 8-mer perfect match LNA-antimiR SEQ ID #3205 and the LNA mismatch control SEQ ID #3218.

Each compound was injected into female NMRI mice, at doses of 25 mg/kg, 5 mg/kg and 1 mg/kg, every other day for 2 weeks. The animals were sacrificed and serum was collected from whole blood for ALT and AST analyses. As seen in Figure 23, the ALT and AST levels were not elevated for SEQ ID #3205 compared to saline or SEQ ID #3218 (mismatch control). However, one mouse showed increased levels (marked red), since the serum samples were contaminated with red blood cells, which contain 6-8 times higher levels of ALT and AST compared to plasma. The mice that received 5 mg/kg and 1 mg/kg were also analyzed for ALT and AST levels and showed no changes compared to saline treated control animals (data not shown).

Materials and Methods:

Experimental design:

Gr. no.	Animal IDno.	No. of mice	Compound Dose level per day	Conc. at dose vol. 10 ml/ kg	Adm. Route	Dosing
1	1 - 10	10	NaCl 0.9%	-	i.v	0, 2, 4, 7, 9

2	11-15	5	SEQ ID # 3205 25mg/kg	2.5mg/ml	i.v	0, 2, 4, 7, 9
3	16-20	5	SEQ ID # 3205 5mg/kg	0.5mg/ml	i.v	0, 2, 4, 7, 9
4	21-25	5	SEQ ID # 3205 1mg/kg	0.1mg/ml	i.v	0, 2, 4, 7, 9
5	26-30	5	SEQ ID # 3230 25mg/kg	2.5mg/ml	i.v	0, 2, 4, 7, 9
6	31-35	5	SEQ ID # 3230 5mg/kg	0.5mg/ml	i.v	0, 2, 4, 7, 9

Sacrifice: The animals was sacrificed by cervical dislocation.

Sampling of serum for ALT/AST: The animals were anaesthetised with 70% CO₂-30% O₂ before collection of retro orbital sinus blood. The blood was collected into S-monovette Serum-Gel vials. The serum samples were harvested and stored from each individual mouse. The blood samples were stored at room temperature for two hours and thereafter centrifuged 10 min, 3000 rpm, at room temp. The serum fractions were harvested into Eppendorf tubes on wet ice.

ALT and AST measurements: ALT and AST measurements were performed in 96-well plates using ALT and AST reagents from ABX Pentra (A11A01627 – ALT, A11A01629 – AST) according to the manufacturer's instructions. In short, serum samples were diluted 2.5 fold with H₂O and each sample was assayed in duplicate. After addition of 50 µl diluted sample or standard (multical from ABX Pentra - A11A01652) to each well, 200 µl of 37 °C AST or ALT reagent mix was added to each well. Kinetic measurements were performed for 5 min with an interval of 30s at 340 nm and 37 °C.

15 **Example 25. Assessment of PU.1 protein levels as a functional readout for miR-155 antagonism by short LNA-antimiR (SEQ ID #3207).**

We have previously shown that the 8-mer (SEQ ID #3207) antagonizing miR-155 leads to derepression of the miR-155 target c/EBPbeta in the mouse macrophage RAW cells. To further verify the potency of SEQ ID #3207 we determined the protein levels of another miR-155 target, PU.1 As a functional readout for miR-155 antagonism by short LNA-antimiR (SEQ ID #3207) we performed Western blot. The antagonism was verified in the human monocytic THP-1 cell line which was transfected together with either an 8-mer (SEQ ID #3207) perfect match or a 8-mer control LNA in the absence or presence of pre-miR-155. LPS was used to induce miR-155 accumulation and cells were harvested after 24 hours.

25 **Results:** THP-1 cells that were transfected with pre-miR-155 shows a decrease in PU.1 levels (Figure 24). Transfecting the cells with the fully LNA-modified and phosphorothiolated SEQ ID #3207 effectively antagonizes miR-155, leading to unaltered levels of PU.1 protein. By comparison, transfecting the cells with an 8-mer LNA control, PU.1 levels decreased, indicating that antagonism of miR-155 by SEQ ID #3207 LNA-antimiR is specific.

Conclusion: Antagonism of miR-155 using an 8-mer leads to de-repression of the direct target PU.1 in human THP-1 cells.

Materials and Methods:

5 Cell line: The human monocytic THP-1 cell line was purchased from ECACC (#88081201). THP-1 cells were cultured in RPMI with L-glutamine, supplemented with 10% fetal bovine serum.

Transfection: 200.000 cells were seeded per well in a 12-well plate the day before. On the day of transfection, THP-1 cells were transfected with 5 nmol pre-miR-155 (Ambion) and/or 5 nM
10 LNA-antimiR together with Lipofectamine2000 (Invitrogen) according to the manufacturer's instructions. LPS (100 ng/ml) was added to the cells after the 4 hour incubation with the transfection complexes. After 24 hours, cells were harvested for protein extraction and western blot analysis.

Western blot: Cells were washed with PBS, trypsinated, transferred to eppendorf tubes and 50
15 µl lysis buffer (1xRIPA) was added. The cell lysate was placed on ice for 20 min and spun at 10.000 rpm for 10 minutes. Equal amounts (15 µl cell lysate) were loaded onto a 4-12% BIS-TRIS gel. The proteins were transferred to a nitrocellulose membrane using iBlot (Invitrogen) according to manufacturers instructions The membrane was incubated overnight at 4°C with the rabbit monoclonal PU.1 antibody (Cell Signaling) with a 1:2000 concentration. As equal loading,
20 Tubulin (Thermo Scientific) was used at a 1:5000 dilution. Immunoreactive bands were visualized with ECL Plus (Amersham).

Example 26. Assessment of p27 protein levels as a functional readout for antagonism of the miR-221/222 family by the 7-mer SEQ ID #3225 LNA-antimiR.

25 Previous work has shown (le Sage et al. 2007, Galardi et al. 2007) that miR-221 and miR-222 post-transcriptionally regulate the expression of the tumour suppressor gene p27, which is involved in cell cycle regulation. In these studies, down-regulation of miR-221 and miR-222 was shown to increase expression levels of p27. Thus, as a functional readout for antagonism of the miR-221/222 family by the 7-mer SEQ ID #3225 LNA-antimiR we determined the protein levels
30 of p27 after transfection of the LNA-antimiR SEQ ID #3225 into PC3 cells.

Results: As shown in Figure 25, transfection of the 7-mer LNA-antimiR SEQ ID #3225 targeting the seed sequence of miR-221 and miR-222 resulted in dose-dependent increase of the p27 protein levels compared to either untransfected or our LNA scrambled control transfected PC3 cells. These results clearly demonstrate that the 7-mer LNA-antimiR is able to effectively
35 antagonize the miR-221/222 family leading to de-repression of the direct target p27 at the protein level at concentrations as low as 5 nM.

Conclusion: A fully LNA-modified 7-mer LNA-antimiR targeting the seed sequence in the miR-221/222 family at 5 nM can effectively antagonize both miRNAs leading to de-repression of the direct target p27 at protein level.

Materials and Methods:

5 Cell line: The human prostate carcinoma PC3 cell line was purchased from ECACC (#90112714). PC3 cells were cultured in DMEM medium, supplemented with 10% fetal bovine serum, 2 mM Glutamax and 25 ug/ml Gentamicin.

10 Transfection: 250.000 cells were seeded per well in a 6-well plate the day before transfection in order to receive 50% confluency the next day. On the day of transfection, PC3 cells were transfected with LNA-oligonucleotides at varying concentrations (see Figure 25) with Lipofectamine2000. Cells were harvested after 24 hours for protein extraction and western blot analysis.

15 Western blot: Cells were washed with PBS, trypsinated, transferred to eppendorf tubes and 50 µl lysis buffer (1xRIPA) was added. The cell lysate was placed on ice for 20 min, then spinned at 10.000 rpm for 10 minutes. Equal amounts (15 µl cell lysate) were loaded onto a 4-12% BIS-TRIS gel. The proteins were transferred to a nitrocellulose membrane using iBlot (Invitrogen) according to manufacturers instructions. The membrane was incubated overnight at 4°C with the primary monoclonal mouse antibody p27 (BD Biosciences) at a 1:1000 dilution. As loading control, Tubulin (Thermo Scientific) was used at a 1:5000 dilution. Immunoreactive bands were
20 visualized with ECL Plus (Amersham).

Example 27. Knock-down of miR-221/222 by the 7-mer SEQ ID #3225 LNA-antimiR reduces colony formation of PC3 cells

25 A hallmark of cellular transformation is the ability for tumour cells to grow in an anchorage-independent way in semisolid medium. We have therefore performed soft agar assay which is a phenotypic assay that is relevant for cancer, given that it measures the decrease of tumour cells. We transfected SEQ ID #3225 (perfect match) and SEQ ID #3231 (scrambled) into PC3 cells, and after 24 hours plated cells in soft agar. Colonies were counted after 12 days. We show in Figure 26 that inhibition of miR-221 and miR-222 by SEQ ID #3225 can reduce the
30 amount of colonies growing in soft agar compared to the scrambled control LNA-antimiR, indicating decrease of tumour cells.

Conclusion: The 7-mer (SEQ ID #3225) targeting the miR-221/222 family reduces the number of colonies in soft agar, indicating proliferation arrest of PC3 cells.

Materials and Methods:

35 Cell line: The human prostate carcinoma PC3 cell line was purchased from ECACC (#90112714). PC3 cells were cultured in DMEM medium, supplemented with 10% fetal bovine serum, 2 mM Glutamax and 25 ug/ml Gentamicin.

Transfection: 250.000 cells were seeded per well in a 6-well plate the day before transfection in order to receive 50% confluency the next day. On the day of transfection, PC3 cells were transfected with 25 nM of different LNA oligonucleotides with Lipofectamine2000.

Clonogenic growth in soft agar: 2.5x10³ PC3 cells were seeded in 0.35% agar on the top of a base layer containing 0.5% agar. Cells were plated 24 hours after transfection. Plates were incubated in at 37°C, 5%CO₂ in a humidified incubator for 12 days and stained with 0.005% crystal violet for 1 h, after which cells were counted. The assay was performed in triplicate.

Example 28: Assessment of let-7 antagonism by 6-9-mer LNA-antimiRs in Huh-7 cells transfected with let-7a precursor miRNA, and a luciferase sensor assay.

In order to assess the efficiency of fully LNA-modified 6-9-mer oligonucleotides in targeting and antagonizing the let-7 family of miRNAs, a luciferase sensor construct was made, containing some 800 bp of the HMGA2 3'UTR. The sequence cloned into the vector contains four out of seven functional let-7 binding sites (sites 2-5), as previously demonstrated by Mayr et al.

(Science, 2007) and Lee and Dutta (Genes Dev, 2007). In order to monitor let-7 inhibition, the hepatocellular carcinoma cell line Huh-7 (with low to non-existing levels of endogenous let-7) was transfected with the luciferase sensor construct, with let-7a precursor miRNA, and with the 6-9 mer let-7 antagonists SEQ ID #3232, -3233, -3227, -3234, -3235; see Figure 27) at increasing concentrations. The 6-9-mer LNA-antimiRs were compared with SEQ ID #3226, a 15-mer against let-7a as a positive control. After 24 hours, luciferase activity was measured.

Results: As seen in Figure 28, the fully LNA-modified 8- and 9-mer LNA-antimiRs (SEQ ID #3227, SEQ ID #3234, and SEQ ID #3235) show similar potencies in de-repressing the let-7 targets in the luciferase sensor assay, as the positive control 15-mer SEQ ID #3226. Full target de-repression for these highly potent compounds is achieved already at 1-5 nM, whereas the 7-mer SEQ ID #3233 needs to be present at slightly higher concentrations (10 nM) to generate the same effect. However, the 6-mer SEQ ID #3232 shows no effect even at as high concentrations as 50 nM. The de-repression of luciferase activity by the 7-9- and the 15-mer LNA-antimiRs is dose-dependent, which is particularly clear in the case of the slightly less potent SEQ ID #3233.

Conclusion: To conclude, the 8-9-mer LNA-antimiRs (SEQ ID #3227, SEQ ID #3234, and SEQ ID #3235) show equal antagonist potencies in inhibition of let-7a *in vitro* compared to the 15-mer LNA-antimiR SEQ ID #3226 targeting let-7a. A potent effect, albeit at slightly higher concentrations is also seen for the 7-mer SEQ ID #3233, whereas a 6-mer has no effect at tested concentrations.

Materials and Methods:

Cell line: The hepatocellular carcinoma cell line Huh-7 was a kind gift from R. Bartinschlager (Dept Mol Virology, University of Heidelberg). Huh-7 cells were cultured in DMEM medium,

supplemented with 10% fetal bovine serum, 2 mM Glutamax, 1x NEAA and 25 ug/ml Gentamicin.

Transfection: 8,000 cells were seeded per well in a 96-well plate the day before transfection in order to receive 60-80% confluency the next day. On the day of transfection, Huh-7 cells in each well were transfected with 20 ng HMGA2 3'UTR/psiCHECK2 plasmid, let-7a precursor miRNA (Dharmacon; 10 nM end-concentration), LNA-antimiRs SEQ ID #3232, -3233, -3227, -3234, -3235, -3226; 0-50 nM end concentrations) together with 0.17 μ l Lipofectamine2000 (Invitrogen) according to manufacturer's instructions. After 24 hours, cells were harvested for luciferase measurements.

Luciferase assay: Growth media was discarded and 30 μ l 1x Passive Lysis Buffer (Promega) was added to each well. After 15-30 minutes of incubation on an orbital shaker, renilla and firefly luciferase measurements were performed according to manufacturer's instructions (Promega).

Example 29: Assessment of entire let-7 family antagonism by 8-, and 15-mer LNA-antimiRs in Huh-7 cells transfected with a luciferase sensor assay.

In order to assess the efficiency of a fully LNA-modified 8-mer oligonucleotide in antagonizing the entire let-7 family of miRNAs, the same luciferase sensor construct as described in the previous example was used. Again, Huh-7 cells (with low to non-existing levels of endogenous let-7) were transfected with the sensor construct, with one of the family-representative let-7a, let-7d, let-7e, or let-7i precursors, and with the antagonist SEQ ID #3227 at increasing concentrations. The 8-mer LNA-antimiR was compared to SEQ ID #3226, a 15-mer against let-7a as a positive and potent control. After 24 hours, luciferase activity was measured.

Results: As seen in Figure 29 the fully LNA-modified 8-mer LNA-antimiRs (SEQ ID #3227) show similar potencies in de-repressing the various let-7 targets in the luciferase sensor assay, as the positive control 15-mer SEQ ID #3226. Nearly full target de-repression for the 8-mer is achieved already at 0.5-1 nM, except in the case with let-7e premiR (Fig. 29C), to which only 7 out of 8 nucleotides of SEQ ID #3227 hybridizes to the target. However, despite the terminal mismatch in this case, SEQ ID #3227 generates full target de-repression at 5 nM. The positive control 15-mer shows potent antagonism of all precursors and gives nearly full de-repression at 0.5 nM. The de-repression of luciferase activity by both the 8- and the 15-mer LNA-antimiRs is clearly dose-dependent, as seen in all four panels (Fig 29A-D).

Conclusion: To conclude, the 8-mer LNA-antimiR (SEQ ID #3227), is a potent antagonist against four representative let-7 family members *in vitro*, and thus likely against the entire family. Compared to a 15-mer positive control antagonist, SEQ ID #3226, the 8-mer is equally potent for three of four targets, and slightly less potent for the fourth target, let-7e, explained by a terminal mismatch in this case.

Materials and Methods:

Cell line: The hepatocellular carcinoma cell line Huh-7 was a kind gift from R. Bartinschlager (Dept Mol Virology, University of Heidelberg). Huh-7 cells were cultured in DMEM medium, supplemented with 10% fetal bovine serum, 2 mM Glutamax, 1x NEAA and 25 ug/ml

5 Gentamicin.

Transfection: 8,000 cells were seeded per well in a 96-well plate the day before transfection in order to receive 60-80% confluency the next day. On the day of transfection, Huh-7 cells in each well were transfected with 20 ng HMGA2 3'UTR/psiCHECK2 plasmid, with let-7a, -7d, -7e, or -7i precursor miRNA (Dharmacon; 10 nM end-concentration), and with LNA-antimiRs SEQ
10 ID #3227 and SEQ ID #3226; 0-50 nM end concentrations) together with 0.17 μ l Lipofectamine2000 (Invitrogen) according to manufacturer's instructions. After 24 hours, cells were harvested for luciferase measurements.

Luciferase assay: Growth medium was discarded and 30 μ l 1x Passive Lysis Buffer (Promega) was added to each well. After 15-30 minutes of incubation on an orbital shaker, renilla and
15 firefly luciferase measurements were performed according to manufacturer's instructions (Promega).

Example 30. Assessment of endogenous let-7 antagonism by SEQ ID #3227, an 8-mer LNA-antimiRs, in HeLa cells transfected with a luciferase sensor assay.

20 In order to determine the efficiency of a fully LNA-modified 8-mer oligonucleotide in targeting and antagonizing endogenous let-7, the same luciferase sensor construct as described in previous two examples, was co-transfected with SEQ ID #3227 into the cervical cancer cell line HeLa (that expresses moderate to high levels of let-7 as determined by Q-PCR; data not shown). Empty psiCHECK-2 vector was included as a negative control.

25 **Results:** As seen in Figure 30, the fully LNA-modified 8-mer LNA-antimiR SEQ ID #3227 shows potent antagonism of endogenous let-7, and gives full target de-repression at concentrations of 5-10 nM. The de-repression of luciferase activity is dose-dependent, starting around 1 nM and reaching a plateau at approximately 10 nM.

Conclusion: *To conclude*, the 8-mer LNA-antimiR (SEQ ID #3227), is a potent antagonist
30 against also endogenous let-7 *in vitro*, and thus provides definite evidence that entire miRNA families can be successfully targeted by short and fully LNA-modified antagonists.

Materials and Methods:

Cell line: The cervical cancer cell line HeLa was purchased from ATCC (#CCL-2™). HeLa cells were cultured in Eagle's MEM medium, supplemented with 10% fetal bovine serum, 2 mM
35 Glutamax, 1x NEAA and 25 ug/ml Gentamicin.

Transfection: 8,000 cells were seeded per well in a 96-well plate the day before transfection in order to receive 50-70% confluency the next day. On the day of transfection, HeLa cells in each

well were co-transfected with 20 ng HMGA2 3'UTR/psiCHECK2 plasmid or psiCHECK-2 (empty vector), and with LNA-antimiR SEQ ID #3227 (0-50 nM, end concentrations) together with 0.17 µl Lipofectamine2000 (Invitrogen) according to manufacturer's instructions. After 24 hours, cells were harvested for luciferase measurements.

- 5 ***Luciferase assay:*** Growth media was discarded and 30 µl 1x Passive Lysis Buffer (Promega) was added to each well. After 15-30 minutes of incubation on an orbital shaker, renilla and firefly luciferase measurements were performed according to manufacturer's instructions (Promega).

10 **Example 31. Assessment of miR-21 antagonism by an 8-mer LNA-antimiR-21 (#3205) versus an 8-mer (#3219) scrambled control LNA in the human colon carcinoma cell line HCT116.**

We have previously shown in this application, that an 8-mer LNA-antimiR that is fully LNA-modified and phosphorothiolated effectively antagonizes miR-21 in the human cervix carcinoma cell line HeLa, the human breast carcinoma cell line MCF-7, the human prostate cancer cell line PC3 and human hepatocellular carcinoma HepG2 cell line. We extended this screening approach to the human colon carcinoma cell line HCT116. To assess the efficiency of the 8-mer LNA-antimiR oligonucleotide against miR-21, luciferase reporter constructs were generated in which a perfect match target site for the mature miR-21 was cloned into the 3'UTR of the Renilla
15 luciferase gene. In order to monitor miR-21 inhibition, HCT116 cells were transfected with the luciferase constructs together with the miR-21 antagonist #3205 (8-mer) and for comparison of specificity with the 8-mer LNA scrambled control (#3219). After 24 hours, luciferase activity was measured.

Results: The luciferase reporter experiments showed a dose-dependent de-repression of the
25 luciferase miR-21 reporter activity with the 8-mer LNA-antimiR against miR-21 (#3205) and complete de-repression was obtained at 5 nM (Figure 31). When comparing the specificity of the 8-mer perfect match and the 8-mer scrambled control, the scrambled control LNA-antimiR (#3219) did not show any de-repression at all, demonstrating high specificity of the LNA-antimiR compound against miR-21.

30 **Conclusion:** The 8-mer (#3205) is potent in targeting miR-21 and antagonism of miR-21 by #3205 is specific.

Materials and Methods:

Cell line: The human colon carcinoma HCT116 cell line was purchased from ATCC (CCL-247). HCT116 cells were cultured in RPMI medium, supplemented with 10% fetal bovine serum, and
35 25 µg/ml Gentamicin.

Transfection: 110.000 cells were seeded per well in a 12-well plate and transfection was performed. HCT116 cells were transfected with 0.3 µg miR-21 luciferase sensor plasmid or empty psiCHECK2 vector together with 1.2 µl Lipofectamine2000 (Invitrogen) according to the manufacturer's instructions. Transfected were also varying concentrations of LNA-antimiR and control oligonucleotides. After 24 hours, cells were harvested for luciferase measurements.

Luciferase assay: The cells were washed with PBS and 250 µl 1 x Passive Lysis Buffer (Promega) was added to the wells. The plates were placed on a shaker for 30 min., after which the cell lysates were transferred to eppendorf tubes. The cell lysate was centrifugated for 10 min at 2.500 rpm after which 50 µl were transferred to a 96 well plate and luciferase measurements were performed according to the manufacturer's instructions (Promega).

Example 32. Knock-down of miR-21 by the 8-mer #3205 LNA-antimiR reduces colony formation of PC3 cells.

A hallmark of cellular transformation is the ability for tumour cells to grow in an anchorage-independent way in semisolid medium. We therefore performed soft agar assay which is a phenotypic assay that is relevant for cancer, given that it measures the decrease of tumour cells. We transfected #3205 (perfect match LNA-antimiR-21) and #3219 (LNA scrambled control) into PC3 cells, and after 24 hours plated cells in soft agar. Colonies were counted after 12 days. We show in Figure 32 that inhibition of miR-21 by #3205 can reduce the amount of colonies growing in soft agar compared to the scrambled control LNA treated or untreated control (transfected, but with no LNA), demonstrating decrease of tumour cells.

Conclusion: The 8-mer (#3205) targeting the miR-21 family reduces the number of colonies in soft agar, demonstrating proliferation arrest of PC3 cells.

Materials and Methods:

Cell line: The human prostate carcinoma PC3 cell line was purchased from ECACC (#90112714). PC3 cells were cultured in DMEM medium, supplemented with 10% fetal bovine serum, 2 mM Glutamax and 25 ug/ml Gentamicin.

Transfection: 250.000 cells were seeded per well in a 6-well plate the day before transfection in order to receive 50% confluency the next day. On the day of transfection, PC3 cells were transfected with 25 nM of different LNA oligonucleotides with Lipofectamine2000.

Clonogenic growth in soft agar: 2.5×10^3 PC3 cells were seeded in 0.35% agar on the top of a base layer containing 0.5% agar. Cells were plated 24 hours after transfection. Plates were incubated in at 37°C, 5% CO₂ in a humified incubator for 12 days and stained with 0.005% crystal violet for 1 h, after which cells were counted. The assay was performed in triplicate.

Example 33. Silencing of miR-21 by the 8-mer #3205 LNA-antimiR reduces colony

formation of HepG2 cells. miR-21 is overexpressed in the human hepatocellular carcinoma cell line HepG2 and we have previously shown that we are able to regulate the luciferase activity of a miR-21 sensor plasmid with #3205 in these cells. HepG2 cells were transfected with #3205 and #3219 (scrambled 8-mer), and after 24 hours plated into soft agar. Colonies were counted after 17 days with a microscope.

Results: We show in Figure 33 that inhibition of miR-21 by #3205 can reduce the amount of colonies growing in soft agar, showing that proliferation arrest has occurred. In addition, our scrambled 8-mer control, #3219, had no significant effect on the number of colonies.

Conclusion: The 8-mer (#3205) targeting the miR-21 reduces the number of colonies in soft agar, indicating proliferation arrest of HepG2 cells.

Materials and Methods:

Cell line: The human hepatocytic HepG2 cell line was purchased from ECACC (#85011430). HepG2 cells were cultured in EMEM medium, supplemented with 10% fetal bovine serum, 2 mM Glutamax and 25 ug/ml Gentamicin.

Transfection: 650.000 cells were seeded per well in a 6-well plate and reverse transfection was performed. HepG2 cells were transfected with 0.6 µg miR-21 luciferase sensor plasmid or empty psiCHECK2 vector together with 2,55 µl Lipofectamine2000 (Invitrogen) according to the manufacturer's instructions. Transfected were also LNA-antimiR and control oligonucleotides as varying concentrations. After 24 hours, the cells were harvested for luciferase measurements.

Clonogenic growth in soft agar: 2.0×10^3 HepG2 cells were seeded in 0.35% agar on the top of a base layer containing 0.5% agar. Cells were plated 24 hours after transfection. Plates were incubated in at 37°C, 5% CO₂ in a humidified incubator for 17 days and stained with 0.005% crystal violet for 1 h, after which cells were counted. The assay was performed in triplicate.

Example 34. Silencing of miR-21 by the 8-mer #3205 LNA-antimiR inhibits cell migration in PC3 cells.

Cell migration can be monitored by performing a wound healing assay (=scratch assay) where a "scratch" is made in a cell monolayer, and images are captured at the beginning and at regular intervals during cell migration. By comparing the images, quantification of the migration rate of the cells can be determined. This was done in the human prostate cancer cell line PC3. Cells were seeded, and on day 3 the cells were transfected, and the next day, when 100% confluency was reached, a scratch (=wound) was made. When the scratch was made, pictures were taken in order to document the initial wound. Afterwards the area of the wound closure is measured at different time points with the free software program Image J. As shown in Figure 34A, PC3 cells had been treated with 25 nM #3205 (perfect match, miR-21), the control #3219 or left untransfected. Pictures were taken after 24 hours, and the area was calculated for the wound

closure at respective time-point. The wound closure for the untransfected cells and for the control, #3219, was faster as compared to our LNA-antimiR against miR-21, #3205, indicating that #3205 inhibits miR-21 and prevents the cells from migrating (Figure 34B).

Conclusion: The 8-mer (#3205) targeting miR-21 inhibits the cell migration of PC3 cells compared to untransfected and control transfected cells.

Materials and Methods:

Cell line: The human prostate carcinoma PC3 cell line was purchased from ECACC (#90112714). PC3 cells were cultured in DMEM medium, supplemented with 10% fetal bovine serum, 2 mM Glutamax and 25 ug/ml Gentamicin.

Scratch assay: 150.000 cells were seeded per well in a 6-well plate three days before transfection in order to receive 100% confluency the next day. At 24 hours after transfection, a scratch was made in the cell monolayer with a 200 µl tip. Pictures were taken at 0 h and after 24 hours by using a digital camera coupled to a microscope. The software program Image J was used to determine wound closure.

Example 35. Length assessment of fully LNA-substituted LNA-antimiRs antagonizing miR-155.

We have previously shown a length assessment for miR-21 regarding fully LNA-substituted LNA-antimiRs, and showed that the most potent LNA-antimiRs are 7-, 8- or 9 nt in length. The same experiment was repeated with miR-155. A perfect match target site for miR-155 was cloned into the 3'UTR of the luciferase gene in the reporter plasmid psiCHECK2 and transfected into the mouse RAW macrophage cell line together with fully LNA-substituted LNA-antimiRs of different lengths. Because the endogenous levels of miR-155 are low in the RAW cell line, the cells were treated with 100 ng/ml LPS for 24 hours in order to induce miR-155 accumulation.

After 24 hours, luciferase analysis was performed.

Results: As shown in Figure 35, the most potent LNA-antimiRs are #3207(8 nt) and #3241 (9 nt), reaching almost a 80% de-repression at only 0.25 nM LNA concentration. The 6-mer (#3244) shows no significant de-repression. Increasing the length to 12-mer to 14-mer (#3242 and #3243) decreased the potency as shown by less efficient de-repression of the miR-155 reporter.

Conclusion:The most potent fully LNA-substituted LNA-antimiRs targeting miR-155 were an 8- and 9-mer (#3207and #3241).

Materials and Methods:

Cell line: The mouse macrophage RAW 264.7 cell line was purchased from ATCC (TIB-71).

RAW cells were cultured in DMEM medium, supplemented with 10% fetal bovine serum, 4 mM Glutamax and 25 ug/ml Gentamicin.

Transfection: 500.000 cells were seeded per well in a 6-well plate the day before transfection in order to receive 50% confluency the next day. On the day of transfection, RAW 264.7 cells were transfected with 0.3 ug miR-155 perfect match/psiCHECK2 or empty psiCHECK2 vector together with 10 µl Lipofectamine2000 (Invitrogen) according to the manufacturer's instructions.

5 Transfected was also varying concentrations of LNA-antimiRs. In order to induce miR-155 accumulation, LPS (100 ng/ml) was added to the RAW cells after the 4 hour incubation with the transfection complexes. After another 24 hours, cells were harvested for luciferase measurements.

Luciferase assay: The cells were washed with PBS and harvested with cell scraper, after which 10 cells were spinned for 5 min at 2.500 rpm. The supernatant was discarded and 50 µl 1 x Passive Lysis Buffer (Promega) was added to the cell pellet, after which cells were put on ice for 30 min. The lysed cells were spinned at 10.000 rpm for 30 min after which 20 µl were transferred to a 96-well plate and luciferase measurements were performed according to the manufacturer's instructions (Promega).

15

Example 36. Plasma protein binding for the fully LNA-substituted 8-mer #3205 targeting miR-21 (LNA-antimiR-21).

The plasma proteins are not saturated with #3205 at the plasma concentrations in the experiment shown in Figure 36A. In a wide range of #3205 concentrations in the plasma the 20 protein binding is around 95% of the #3205 LNA-antimiR-21 in Figure 36B. At #3205 concentrations 50.1 µM (174 µg/mL) the binding capacity of plasma proteins for FAM-labeled #3205 has not been saturated.

Materials and Methods: Mouse plasma (100 µL) was spiked with FAM-labeled #3205 to 0.167, 1.67, 5.01, 10.02, 16.7, 25.05 and 50.1 µM concentrations. The solutions were incubated 25 at 37°C for 30 minutes. The solutions were transferred to a Microcon Ultracel YM-30 filter (regenerated cellulose 30.000 MWCO). The filters were spun for 20 minutes at 2000g and at room temperature in a microcentrifuge. The filtrate was diluted 5, 10 and 20 times and 100µL samples were transferred to a microtiter plate (Polystyrene Black NUNC-237108). The fluorescence was detected using a FLUOstar Optima™ elisa reader with excitation 458 nm and 30 emission 520 nm. The amount of unbound FAM-labeled #3205 was calculated from a standard curve derived from filtrated plasma spiked with FAM-labeled #3205 at 12 different (0.45 – 1000 nM) concentrations. The numbers were corrected with the recovery number established from filtration experiments with #3205 concentrations 0.167, 1.67, 5.01, 10.02, 16.7, 25.05 and 50.1 µM in filtrated plasma. The recovery of FAM-labeled #3205 was 86%.

35

Example 37. Quantitative whole body autoradiography study in female pigmented mice after single intravenous administration of ³⁵S-labelled #3205 LNA-antimiR-21.

In order to determine the biodistribution of a short fully LNA-modified LNA-antimiR (#3205, 8-mer) a whole body tissue distribution of radioactively labeled compound was done in mice. ³⁵S-

5 labelled #3205 was dosed to mice with a single intravenous administration and mice were sacrificed at different time-points, ranging from 5 min to 21 days.

Table 6(i). Individual tissue concentrations (μg #3205/g tissue) after a single intravenous administration of ³⁵S- labelled #3205 in female pigmented mice. The figures are mean values of three measurements for each tissue and ratio. The coefficient of variation (CV) is generally
10 about 10%.

Tissue	Max. Conc. of oligo μg #3205/g tissue	Time of max conc. hours	T $\frac{1}{2}$ hours
Adrenal gl.	13,6	0,083	374
Bile	4	1	
Bone marrow	7,2	0,083	411
Brain	0,4	0,083	
Brown fat	8,8	0,083	
Gastric muc.	10,1	0,083	
Heart blood	26,2	0,083	10,3
Kidney ctx.	58,7	24	104
Liver	11,8	0,083	588
	10,7	24	
Lung	13,2	0,083	289
Lymph node	5	0,083	262
	2,4	48	
Lymph	18,8	4	
	20,8	168	
Myocardium	8,1	0,083	662
Ovary	13	0,083	198
Pancreas	5	0,083	
Pituitary gl.	6,7	0,083	
Salivary gl.	8,6	0,083	405
	5,5	168	
skel. Muscle	4,8	0,083	
Skin pig.	5,4	0,25	
Spleen	9,8	0,083	564
Thymus	3,8	0,083	185
Thyroid gl.	10,9	0,083	592
Urine	328,9	0,083	
Uterus	9,6	0,25	177
Uvea of the eye	13,6	0,083	
LOQ	0,045	0,083	
	0,033	24	
	0,03	168	

Table 6(ii) Tissue to liver ratios after single intravenous administration of ³⁵S- labelled #3205 in female pigmented mice.

³⁵ S-#3205									
Animal no	10	11	12	13	14	15	16	17	18
Surv. Time (h)	0,083	0,25	1h	4h	24h	48h	96h	168	504
Organ									
Adrenal gl	liver	liver	liver	liver	liver	liver	liver	liver	liver
Bile	1,15	1,08	0,52	0,27	0,24	0,26	0,23	0,18	0,17
Bone marrow	0,03	0,11	0,55	0,10	0,03	0,07	0,04	0,03	0,04

Brain	0,61	0,81	0,55	0,45	0,40	0,48	0,43	0,42	0,34
Brown fat	0,03	0,03	0,01	0,00	0,00	0,00	0,00	0,00	0,00
Gastric muc	0,75	0,57	0,29	0,12	0,07	0,12	0,08	0,10	0,07
Heart blood	0,86	0,71	0,31	0,22	0,10	0,21	0,15	0,16	0,12
Kidney ctx	2,23	1,91	0,74	0,11	0,01	0,00	0,00	0,00	0,00
Liver	2,87	3,94	6,45	6,95	5,51	6,68	3,92	2,24	0,40
Lung	1,00	1,00	1,00	1,00	1,00	1,00	1,00	1,00	1,00
Lymph node	1,12	0,97	0,63	0,09	0,04	0,04	0,03	0,02	0,02
Lymph	0,43	0,30	0,25	0,19	0,11	0,32	0,20	0,17	0,12
Myocardium	0,82	1,09	1,78	2,78	1,03	2,05	1,62	3,17	1,89
Ovary	0,69	0,63	0,30	0,13	0,10	0,15	0,09	0,11	0,12
Pancreas	1,10	1,40	0,61	0,31	0,27	0,28	0,21	0,21	0,08
Pituitary gland	0,42	0,37	0,22	0,18	0,12	0,17	0,12	0,15	0,11
Salivary gland	0,57	0,54	0,28	0,11	0,15	0,16	0,12	0,10	0,08
Skel. muscle	0,73	0,81	0,38	0,25	0,25	0,42	0,23	0,85	0,24
Skin, pigm.	0,40	0,28	0,14	0,04	0,02	0,04	0,03	0,03	0,03
Spleen	0,34	0,69	0,65	0,36	0,20	0,26	0,20	0,19	0,13
Thymus	0,83	0,86	0,44	0,32	0,24	0,34	0,35	0,29	0,31
Thyroid gland	0,32	0,31	0,14	0,07	0,09	0,08	0,05	0,04	0,02
Urine	0,9	1,2	0,43	0,28	0,25	0,34	0,19	0,26	0,25
Uterus	27,96	39,48	9,90	5,44	0,24	0,39	0,12	0,15	0,03
Uvea of the eye	0,56	1,23	0,65	0,30	0,30	0,07	0,27	0,16	0,08

Conclusions: #3205 shows blood clearance of radioactivity with elimination half-lives of 8-10 hours. High levels of radioactivity were registered in the kidney cortex, lymph, liver, bone marrow, spleen, ovary and uterus. The highest level of radioactivity was registered in the kidney cortex showing five times higher levels than that of the liver for #3205. A strong retention of radioactivity was noticed in the kidney cortex, lymph, liver, bone marrow and spleen for #3205 LNA-antimiR-21.

Materials and Methods:

Dose administration: All mice were weighed before administration. Nine female mice were given 10 mg/kg of ³⁵S-#3205 intravenously in a tail vein. The volume given to each animal was 10 mL/kg of the test formulation. The specific activity 75.7 µCi/mg. Individual mice were killed 5 min, 15 min, 1 hour, 4 hours, 24 hours, 2 days, 4 days, 7 days and 21 days after administration of #3205. Whole body autoradiography: The mice were anaesthetized by sevoflurane, and then immediately immersed in heptane, cooled with dry ice to -80°C, ABR-SOP-0130. The frozen carcasses were embedded in a gel of aqueous carboxymethyl cellulose (CMC), frozen in ethanol, cooled with dry ice (-80°C) and sectioned sagittally for whole body autoradiography, according to the standard method, ABR-SOP-0131. From each animal 20 µm sections were cut at different levels with a cryomicrotome (Leica CM 3600™) at a temperature of about -20°C. The obtained sections were caught on tape (Minnesota Mining and Manufacturing Co., No. 810) and

numbered consecutively with radioactive ink. After being freeze-dried at -20°C for about 24 hours, selected sections were covered with a thin layer of mylar foil, and put on imaging plates (Fuji, Japan). Exposure took place in light tight cassettes in a lead shielding box at -20°C , to protect the image plates from environmental radiation. After exposure the imaging plates were scanned at a pixel size of $50\ \mu\text{m}$ and analyzed by radioluminography using a bioimaging analysis system (Bas 2500, Fuji, Japan), and described in ABR-SOP-0214. A water-soluble standard test solution of ^{35}S radioactivity was mixed with whole blood and used for production of a calibration scale, ABR-SOP-0251. However, the different blood standards were dissolved in $500\ \mu\text{L}$ Soluene-35. $4.5\ \text{mL}$ Ultima Gold was then added to the dissolved samples. As ^{35}S and ^{14}C have very similar energy spectra, a standard ^{14}C -programme (Packard 2200CA) was used when the radioactivity for the different blood samples was settled.

Pharmacokinetic calculations: The ^{35}S radioactivity measured in whole blood and tissues was expressed as nCi/g tissue and recalculated to nmol equiv/g tissue for the pharmacokinetic evaluation. The pharmacokinetic parameters C_{max} , $t_{1/2}$ and AUC were determined for the whole blood and tissues by non-compartmental analysis using WinNonlin Professional (Pharsight Corporation, Mountain View, CA, USA). After intravenous administration, the concentration was extrapolated back to zero and expressed as (C_0). The elimination rate constant λ was estimated by linear regression analysis of the terminal slope of the logarithmic plasma concentration-time curve. The elimination half-life, $t_{1/2}$, was calculated using the equation, $t_{1/2} = \ln 2/\lambda$. The last three time-points above LOQ were used in the elimination half-life calculations, if not stated otherwise.

Example 38. Assessment of let-7 inhibition *in vivo* by an 8-mer LNA-antimiR, as determined through Ras protein quantification in mouse lung and kidney

In order to investigate the possibility to antagonize the abundantly expressed let-7 family *in vivo*, mice were intravenously (i.v.) injected with an 8-mer LNA-antimiR antagonist or with saline. To measure treatment effect, proteins were isolated from lungs and kidneys. Because the Ras family of proteins (N-Ras, K-Ras, and H-Ras), in particular N-Ras and K-Ras, has previously been shown to be regulated (repressed) by the let-7 family by Johnson et al. (Cell, 2005), the aim was to analyze whether these let-7 targets could be de-repressed *in vivo*.

Results: As seen in Figure 37, the 8-mer LNA-antimiR potently de-repressed Ras protein levels in the kidneys of treated mice, normalized against saline controls. The up-regulation in this organ was more than 3-fold, showing a clear *in vivo* effect. In the lungs, however, only a minimal (1.2-fold) Ras de-repression was observed (Fig 1B), suggesting that insufficient amounts of LNA-antimiR has entered this organ in order to inhibit its massive amounts of let-7, as previously described by Johnson et al. (Cancer Research, 2007).

Conclusion: The 8-mer LNA-antimiR shows a clear effect in regulating target let-7 miRNA *in vivo*, as evaluated based on Ras protein levels in treated vs. control mice. Whereas the effect seems to be smaller in lungs, Ras levels in the kidney show a substantial up-regulation upon antimiRs-treatment.

5 **Materials and Methods:** Animals and dosing: C57BL/6 female mice were treated with 10 mg/kg LNA-antimiR or saline for three consecutive days (0, 1, and 2) and sacrificed on day 4. Tissue samples from lungs and kidneys were snapfrozen and stored at -80°C until further processing.

10 Western blot analysis: Lung and kidney proteins from saline and LNA-antimiR-treated mice were separated on NuPAGE™ Bis Tris 4-12% (Invitrogen), using 100 µg per sample. The proteins were transferred to a nitrocellulose membrane using iBlot (Invitrogen) according to the manufacturer's instructions. Blocking, antibody dilution and detection was performed according to the manufacturer's specifications. For Ras detection, a primary rabbit-anti Ras antibody (SC-3339, Santa Cruz Biotechnology) and a secondary HRP-conjugated swine-anti-rabbit antibody
15 (P0399, Dako) was used, and for tubulin detection, a primary tubulin alpha (MS-581-P1, Neomarkers) and a secondary HRP-conjugated goat-anti-mouse antibody (P0447, Dako) was used.

Example 40. *In vivo* efficacy assessment of the 8-mer LNA-antimiR (#3205) in targeting miR-21, as determined by Pcd4 protein up-regulation in mouse kidney.

20 We have shown that an 8-mer LNA-antimiR that is fully LNA-modified antagonizes miR-21 and has the ability to regulate the protein levels of the miR-21 target Pcd4 *in vitro*. We therefore injected the LNA-antimiR into mice to determine the effects of the LNA-antimiR *in vivo*. The mice received 25 mg/kg of #3205 by i.v. injection every other day for 14 days (a total of 5 doses). The mice were sacrificed on day 14, the kidney was removed, and protein was isolated.

25 In order to determine target regulation, Western blot analysis was performed.

Results: As shown in Figure 37, treating mice with #3205 showed significantly increased Pcd4 protein levels as compared to the saline control. While the normalized Pcd4 versus Gapdh ratio was consistent in both saline samples, the protein up-regulation in the two LNA-antimiR-treated (#32059 mice were measured to 3.3- and 6.3-fold, respectively, demonstrating
30 an *in vivo* pharmacological effect of the #3205 8-mer LNA-antimiR.

Conclusion: The fully LNA-modified 8-mer LNA-antimiR #3205 antagonizes miR-21 *in vivo*, as demonstrated through its ability to de-repress (up-regulate) mouse kidney levels of Pcd4, a validated miR-21 target.

Materials and Methods:

35 Animals and dosing: C57BL/6 female mice with average of 20 g body weight at first dosing were used in all experiments and received regular chow diet (Altromin no 1324, Brogaarden, Gentofte, Denmark). Substances were formulated in physiological saline (0.9% NaCl). The

animals were dozed with LNA-antimiR or saline (0.9% NaCl), receiving an injection of 25 mg/kg every other day for 14 days, a total of 5 doses. Animals were sacrificed on day 14.

Western blot analysis: 80 µg kidney tissue from saline or LNA-treated mice was separated on NuPAGE Bis Tris 4-12% (Invitrogen). The proteins were transferred to a nitrocellulose
5 membrane using iBlot (Invitrogen) according to the manufacturer's instructions. The membrane was incubated with Pdc4 antibody (Bethyl Laboratories), followed by HRP-conjugated swine-anti-rabbit antibody (Dako). As equal loading control, GAPDH (Abcam) was used, followed by HRP-conjugated swine-anti-mouse antibody. The membranes were visualized by chemiluminescence (ECL, Amersham).

microRNA	MicroRNASequence	SEQ	9-mer	SEQ	8-mer	SEQ	7-mer	SEQ
		ID NO		ID NO		ID NO		ID NO
ebv-miR-BART1-3p	UAGCACCGCUAUCCACUAUGUC	40	AGCGGTGCT	977	GCGGTGCT	1914	CGGTGCT	2851
ebv-miR-BART1-5p	UCUUAGUGGAAGUGACGUGCUGUG	41	TCCACTAAG	978	CCACTAAG	1915	CACTAAG	2852
ebv-miR-BART10	UACAUAAACCAUGGAGUUGGCUGU	42	TGGTTATGT	979	GGTTATGT	1916	GTTATGT	2853
ebv-miR-BART10*	GCCACCUCUUUGGUUCUGUACA	43	AAGAGGTGG	980	AGAGGTGG	1917	GAGGTGG	2854
ebv-miR-BART11-3p	ACGCACACCAGGCGACUGCC	44	TGGTGTGCG	981	GGTGTGCG	1918	GTGTGCG	2855
ebv-miR-BART11-5p	UCAGACAGUUUGGUGCGCUAGUUG	45	AACTGTCTG	982	ACTGTCTG	1919	CTGTCTG	2856
ebv-miR-BART12	UCCUGUGGUGUUUGGUGUGUU	46	CACCACAGG	983	ACCACAGG	1920	CCACAGG	2857
ebv-miR-BART13	UGUAACUUGCCAGGACGGCUGA	47	GCAAGTTAC	984	CAAGTTAC	1921	AAGTTAC	2858
ebv-miR-BART13*	AACCGGCUCGUGGCUCGUACAG	48	CGAGCCGGT	985	GAGCCGGT	1922	AGCCGGT	2859
ebv-miR-BART14	UAAAUGCUCGAGUAGUAGGGAU	49	GCAGCATTT	986	CAGCATTT	1923	AGCATTT	2860
ebv-miR-BART14*	UACCCUACGUCGCCGAUUACA	50	GCGTAGGGT	987	CGTAGGGT	1924	GTAGGGT	2861
ebv-miR-BART15	GUCAGUGUUUUGUUCCUUGA	51	AACCACTGA	988	ACCACTGA	1925	CCACTGA	2862
ebv-miR-BART16	UUAGAUAGAGUGGUGUGUCUCU	52	CTCTATCTA	989	TCTATCTA	1926	CTATCTA	2863
ebv-miR-BART17-3p	UGUAUGCCUGGUGUCCCUUAGU	53	CAGGCATAC	990	AGGCATAC	1927	GCATAC	2864
ebv-miR-BART17-5p	UAAGAGGACGACGCAUACAAG	54	CGTCTCTTT	991	GCTCTCTTT	1928	TCTCTTT	2865
ebv-miR-BART18-3p	UAUCGGAAGUUUGGGUUCGUC	55	ACTTCCGAT	992	CTTCCGAT	1929	TCCGAT	2866
ebv-miR-BART18-5p	UCAAGUUCGCACUCCUAUACA	56	GCGAAGTTG	993	CGAAGTTG	1930	GAAAGTTG	2867
ebv-miR-BART19-3p	UUUUUUUGCUUGGAAUGCU	57	GCAACAAA	994	CAACAAA	1931	AAACAAA	2868
ebv-miR-BART19-5p	ACAUUCCCCGAAACAUGACAUG	58	CGGGGAATG	995	GGGGAATG	1932	GGGAATG	2869
ebv-miR-BART2-3p	AAGGAGCGAUUUGGAGAAAUAAA	59	ATCGTCTCT	996	TCGTCTCT	1933	CGTCTCT	2870
ebv-miR-BART2-5p	UAUUUCUGCAUUCGCCCUUGC	60	GCAGAAAAT	997	CAGAAAAT	1934	AGAAAAT	2871
ebv-miR-BART20-3p	CAUGAAGGCACAGCCUGUACC	61	TGCCCTTCAT	998	GCCTTCAT	1935	CCTTCAT	2872
ebv-miR-BART20-5p	UAGCAGGCAUGUCUUAUACC	62	ATGCCTGCT	999	TGCCTGCT	1936	GCCTGCT	2873
ebv-miR-BART3	CGCACACUAGUCACCAGGUGU	63	TAGTGGTGC	1000	AGTGGTGC	1937	GTGGTGC	2874
ebv-miR-BART3*	ACCUGUGUAGUGUUGUGCU	64	AACACTAGG	1001	AACTAGG	1938	CACTAGG	2875
ebv-miR-BART4	GACCUGAUGCUGCGGUGUGCU	65	GCATCAGGT	1002	CATCAGGT	1939	ATCAGGT	2876
ebv-miR-BART5	CAAGGUGAAUAGCUGCCCAUCG	66	ATTCACCTT	1003	TTCACCTT	1940	TCACCTT	2877
ebv-miR-BART6-3p	CGGGGAUCGGACUAGCCUAGA	67	CCGATCCCC	1004	CGATCCCC	1941	GATCCCC	2878
ebv-miR-BART6-5p	UAAGGUUGGUCCAAUCCAUAGG	68	ACCAACCTT	1005	CCAACCTT	1942	CAACCTT	2879
ebv-miR-BART7	CAUCAUAGUCCAGUCCAGGG	69	GACTATGAT	1006	ACTATGAT	1943	CTATGAT	2880
ebv-miR-BART7*	CCUGGACCUAGACUAUGAAACA	70	AAGTCCAG	1007	AGTCCAG	1944	GTCCAG	2881
ebv-miR-BART8	UACGGUUCCUAGAUUGUACAG	71	GGAAACCGT	1008	GAAACCGT	1945	AAACCGT	2882
ebv-miR-BART8*	GUCACAAUCUAGGGGUCGUGA	72	AGATTGTGA	1009	GATTGTGA	1946	ATTGTGA	2883
ebv-miR-BART9	UAACACUUCUAGGGUCCGUAGU	73	TGAAGTGT	1010	GAAGTGT	1947	AAGTGT	2884
ebv-miR-BART9*	UACUGGACCCUGAAUUGGAAAC	74	GGGTCCAGT	1011	GGTCCAGT	1948	GTCCAGT	2885
ebv-miR-BHRF1-1	UAACCUGAUCAGCCCCGGAGUU	75	GATCAGGTT	1012	ATCAGGTT	1949	TCAGGTT	2886
ebv-miR-BHRF1-2	UAUCUUUUGCGGCAGAAUUGA	76	GCAAAAGAT	1013	CAAAAGAT	1950	AAAAGAT	2887
ebv-miR-BHRF1-2*	AAAUUCUGUUGCAGCAGAUAGC	77	AACAGAATT	1014	ACAGAATT	1951	CAGAATT	2888
ebv-miR-BHRF1-3	UAACGGGAAGUGUGUAGCACA	78	CTTCCGTT	1015	TCCCGTT	1952	TCCCGTT	2889
hcmv-miR-UL112	AAGUGACGGUGAGAUCCAGGCU	79	ACCGTCACT	1016	CCGTCACT	1953	CGTCACT	2890
hcmv-miR-UL148D	UCGUCCUCCCUUCUUCACCG	80	GGGAGGACG	1017	GGAGGACG	1954	GAGGACG	2891
hcmv-miR-UL22A	UAACUAGCCUCCUGUGAGA	81	AGGCTAGTT	1018	GGCTAGTT	1955	GCTAGTT	2892
hcmv-miR-UL22A*	UCACCAGAAUGCUAGUUUGUAG	82	ATTCTGGTG	1019	TTCTGGTG	1956	TCTGGTG	2893
hcmv-miR-UL36	UCGUUGAAGACACCGGAAAGA	83	TCTCAACG	1020	CTCAACG	1957	TCAACG	2894
hcmv-miR-UL36*	UUUCCAGGUGUUUCAACGUGC	84	CACCTGGAA	1021	ACCTGGAA	1958	CCTGGAA	2895
hcmv-miR-UL70-3p	GGGGAUGGGGUGGCGCGCGG	85	GCCCATCCC	1022	CCCATCCC	1959	CCATCCC	2896
hcmv-miR-UL70-5p	UGCGUCUCGGCCUCGUCCAGA	86	CCGAGACGC	1023	CGAGACGC	1960	GAGACGC	2897
hcmv-miR-US25-1	AACCGCUCAGUGGUCGCGGACC	87	CTGAGCGGT	1024	TGAGCGGT	1961	GAGCGGT	2898
hcmv-miR-US25-1*	UCCGAACGCUAGGUCGGUUCUC	88	AGCGTTCGG	1025	GCGTTCGG	1962	CGTTCGG	2899
hcmv-miR-US25-2-3p	AUCCACUUGGAGAGCUCCGCGG	89	CCAAGTGA	1026	CAAGTGA	1963	AAGTGA	2900

hcmv-miR-US25-2-5p	AGCGGUCUGUUCAGGUGGAUGA	90	ACAGACCGC	1027	CAGACCGC	1964	AGACCGC	2901
hcmv-miR-US33-3p	UCACGGUCCGAGCACAUCCA	91	CGGACCGTG	1028	GGACCGTG	1965	GACCGTG	2902
hcmv-miR-US33-5p	GAUUGUGCCCGGACCGUGGGCG	92	GGGCACAAT	1029	GGCACAAT	1966	GCACAAT	2903
hcmv-miR-US4	CGACAUGGACGUGCAGGGGGAU	93	GTCCATGTC	1030	TCCATGTC	1967	CCATGTC	2904
hcmv-miR-US5-1	UGACAAGCCUGACGAGAGCGU	94	AGGCTTGTC	1031	GGCTTGTC	1968	GCTTGTC	2905
hcmv-miR-US5-2	UUAUGAUAGGUGUGACGAUGUC	95	CCTATCATA	1032	CTATCATA	1969	TATCATA	2906
hsa-let-7a	UGAGGUAGUAGGUUGUAUAGUU	96	TACTACCTC	1033	ACTACCTC	1970	CTACCTC	2907
hsa-let-7a*	CUAUACAAUCUACUGUCUUUC	97	GATTGTATA	1034	ATTGTATA	1971	TTGTATA	2908
hsa-let-7b	UGAGGUAGUAGGUUGUGUGUU	98	TACTACCTC	1035	ACTACCTC	1972	CTACCTC	2909
hsa-let-7b*	CUAUACAACCUACUGCCUCCCC	99	GGTTGTATA	1036	GTTGTATA	1973	TTGTATA	2910
hsa-let-7c	UGAGGUAGUAGGUUGUAUGUU	100	TACTACCTC	1037	ACTACCTC	1974	CTACCTC	2911
hsa-let-7c*	UAGAGUUAACCCUGGGAGUUA	101	TGTAACCTC	1038	GTAACCTC	1975	TAACCTC	2912
hsa-let-7d	AGAGGUAGUAGGUUGCAUAGUU	102	TACTACCTC	1039	ACTACCTC	1976	CTACCTC	2913
hsa-let-7d*	CUAUACGACCGUCUGCCUUCU	103	GGTCGTATA	1040	GTCGTATA	1977	TCGTATA	2914
hsa-let-7e	UGAGGUAGGAGGUUGUAUAGUU	104	TCCTACCTC	1041	CCTACCTC	1978	CTACCTC	2915
hsa-let-7e*	CUAUACGGCCUCCUAGCUUCC	105	GGCCGTATA	1042	GCCGTATA	1979	CCGTATA	2916
hsa-let-7f	UGAGGUAGUAGAUUGUAUAGUU	106	TACTACCTC	1043	ACTACCTC	1980	CTACCTC	2917
hsa-let-7f-1*	CUAUACAAUCUUAUGCCUCCCC	107	GATTGTATA	1044	ATTGTATA	1981	TTGTATA	2918
hsa-let-7f-2*	CUAUACAGUCUACUGUCUUCC	108	GACTGTATA	1045	ACTGTATA	1982	CTGTATA	2919
hsa-let-7g	UGAGGUAGUAGUUUGUACAGUU	109	TACTACCTC	1046	ACTACCTC	1983	CTACCTC	2920
hsa-let-7g*	CUGUACAGCCACUGCCUUGC	110	GCCTGTACA	1047	CCTGTACA	1984	CTGTACA	2921
hsa-let-7i	UGAGGUAGUAGUUUGUCUGUU	111	TACTACCTC	1048	ACTACCTC	1985	CTACCTC	2922
hsa-let-7i*	CUGCGCAAGCUACUGCCUUGC	112	GCTTGCACA	1049	CTTGCACA	1986	TTGCACA	2923
hsa-miR-1	UGGAAUGUAAAGAAGUAUGUAU	113	TTACATTCC	1050	TACATTCC	1987	ACATTCC	2924
hsa-miR-100	AACCCGUAUAUCCGAACUUGUG	114	TCTACGGGT	1051	CTACGGGT	1988	TACGGGT	2925
hsa-miR-100*	CAAGCUUGUAUCUAUAGGUAUG	115	TACAAGCTT	1052	ACAAGCTT	1989	CAAGCTT	2926
hsa-miR-101	UACAGUACUGUGAUAACUGAA	116	CAGTACTGT	1053	AGTACTGT	1990	GTACTGT	2927
hsa-miR-101*	CAGUUAUCACAGUGCUGAUGCU	117	GTGATAACT	1054	TGATAACT	1991	GATAACT	2928
hsa-miR-103	AGCAGCAUUGUACAGGGCUAUGA	118	CAATGCTGC	1055	AATGCTGC	1992	ATGCTGC	2929
hsa-miR-103-as	UCAUAGCCCUGUACAAUGCUGCU	119	AGGGCTATG	1056	GGGCTATG	1993	GGCTATG	2930
hsa-miR-105	UCAAAUGCUCAGACUCCUGUGGU	120	GAGCATTTG	1057	AGCATTTG	1994	GCATTTG	2931
hsa-miR-105*	ACGGAUGUUUGAGCAUGGCUA	121	AAACATCCG	1058	AACATCCG	1995	ACATCCG	2932
hsa-miR-106a	AAAAGUGCUUACAGUGCAGGUAG	122	AAGCACTTT	1059	AGCACTTT	1996	GCACTTT	2933
hsa-miR-106a*	CUGCAAUGUAAGCACUUCUAC	123	TACATTGCA	1060	ACATTGCA	1997	CATTGCA	2934
hsa-miR-106b	UAAAGUGCUGACAGUGCAGAU	124	CAGCACTTT	1061	AGCACTTT	1998	GCACTTT	2935
hsa-miR-106b*	CCGCACUGUGGUACUUGCUGC	125	CACAGTGCG	1062	ACAGTGCG	1999	CAGTGCG	2936
hsa-miR-107	AGCAGCAUUGUACAGGGCUAUCA	126	CAATGCTGC	1063	AATGCTGC	2000	ATGCTGC	2937
hsa-miR-10a	UACCCUGUAGAUCGAAUUGUG	127	CTACAGGGT	1064	TACAGGGT	2001	ACAGGGT	2938
hsa-miR-10a*	CAAAUUCGUAUCUAGGGAAUA	128	TACGAATTT	1065	ACGAATTT	2002	CGAATTT	2939
hsa-miR-10b	UACCCUGUAGAACCGAAUUGUG	129	CTACAGGGT	1066	TACAGGGT	2003	ACAGGGT	2940
hsa-miR-10b*	ACAGAUCGUAUCUAGGGAAU	130	TCGAATCTG	1067	CGAATCTG	2004	GAATCTG	2941
hsa-miR-1178	UUGCUCACUGUUCUCCUAG	131	CAGTGAGCA	1068	AGTGAGCA	2005	GTGAGCA	2942
hsa-miR-1179	AAGCAUUCUUCUAGGUUGG	132	AAGAATGCT	1069	AGAATGCT	2006	GAATGCT	2943
hsa-miR-1180	UUUCCGGCUCGCGUGGGUGUGU	133	GAGCCGGAA	1070	AGCCGGAA	2007	GCCGGAA	2944
hsa-miR-1181	CCGUCGCCGCCACCCGAGCCG	134	GCGCGCAGC	1071	CGCGCAGC	2008	GGCGCAGC	2945
hsa-miR-1182	GAGGGUCUUGGGAGGGAUGUGAC	135	CAAGACCCT	1072	AAGACCCT	2009	AGACCCT	2946
hsa-miR-1183	CACUGUAGGUGAUGGUGAGAGUGGCA	136	ACCTACAGT	1073	CCTACAGT	2010	CTACAGT	2947
hsa-miR-1184	CCUGCAGCGACUUGAUGGCUUCC	137	TCGCTGCAG	1074	CGCTGCAG	2011	GCTGCAG	2948
hsa-miR-1185	AGAGGAUACCCUUGUAUGUU	138	GGTATCCTC	1075	GTATCCTC	2012	TATCCTC	2949
hsa-miR-1197	UAGGACACAUGGUCUACUUCU	139	ATGTGTCTC	1076	TGTGTCTC	2013	GTGTCTC	2950
hsa-miR-1200	CUCCUGAGCCAUUCUGAGCCUC	140	GGCTCAGGA	1077	GCTCAGGA	2014	CTCAGGA	2951
hsa-miR-1201	AGCCUGAUUAAACACAUGCUCUGA	141	TAATCAGGC	1078	AATCAGGC	2015	ATCAGGC	2952
hsa-miR-1202	GUGCCAGCUGCAGUGGGGAG	142	CAGCTGGCA	1079	AGCTGGCA	2016	GCTGGCA	2953
hsa-miR-1203	CCCGGAGCCAGGAUGCAGCUC	143	TGGCTCCGG	1080	GGCTCCGG	2017	GCTCCGG	2954

hsa-miR-1204	UCGUGGCCUGGUCUCAUUAU	144	CAGGCCACG	1081	AGGCCACG	2018	GGCCACG	2955
hsa-miR-1205	UCUGCAGGGUUGCUUUGAG	145	ACCCTGCAG	1082	CCCTGCAG	2019	CCTGCAG	2956
hsa-miR-1206	UGUUC AUGUAGAUGUUUAAGC	146	TACATGAAC	1083	ACATGAAC	2020	CATGAAC	2957
hsa-miR-1207-3p	UCAGCUGGCCUCAUUAUC	147	GGCCAGCTG	1084	GCCAGCTG	2021	CCAGCTG	2958
hsa-miR-1207-5p	UGGCAGGGAGCUGGGAGGGG	148	CTCCCTGCC	1085	TCCTGCC	2022	CCCTGCC	2959
hsa-miR-1208	UCACUGUUCAGACAGGCGGA	149	TGAACAGTG	1086	GAACAGTG	2023	AACAGTG	2960
hsa-miR-122	UGGAGUGUGACAAUGGUGUUUG	150	TCACACTCC	1087	CACACTCC	2024	ACACTCC	2961
hsa-miR-122*	AACGCCAUUAUCACACUAAAUA	151	TAATGGCGT	1088	AATGGCGT	2025	ATGGCGT	2962
hsa-miR-1224-3p	CCCCACCUCUCUCUCUCAG	152	GGAGGTGGG	1089	GAGGTGGG	2026	AGGTGGG	2963
hsa-miR-1224-5p	GUGAGGACUCGGGAGGUGG	153	GAGTCTCA	1090	AGTCTCA	2027	GTCCTCA	2964
hsa-miR-1225-3p	UGAGCCCCUGGCCGCCCCAG	154	CAGGGGCTC	1091	AGGGGCTC	2028	GGGGCTC	2965
hsa-miR-1225-5p	GUGGGUACGGCCAGUGGGGGG	155	CCGTACCCA	1092	CGTACCCA	2029	GTACCCA	2966
hsa-miR-1226	UCACCAGCCUCUGUUCUCCUAG	156	GGGCTGGTG	1093	GGCTGGTG	2030	GCTGGTG	2967
hsa-miR-1226*	GUGAGGGCAUGCAGGCCUGGAUGGGG	157	ATGCCCTCA	1094	TGCCCTCA	2031	GCCCTCA	2968
hsa-miR-1227	CGUGCCACCCUUUCCCCAG	158	GGGTGGCAC	1095	GGTGGCAC	2032	GTGGCAC	2969
hsa-miR-1228	UCACACCUGCCUCGCCCCCC	159	GCAGGTGTG	1096	CAGGTGTG	2033	AGGTGTG	2970
hsa-miR-1228*	GUGGGCGGGGCAGGUGUGUG	160	CCCCGCCCA	1097	CCCGCCCA	2034	CCGCCCA	2971
hsa-miR-1229	CUCUCACCACUGCCUCCACAG	161	GTGGTGAGA	1098	TGGTGAGA	2035	GGTGAGA	2972
hsa-miR-1231	GUGUCUGGGCGGACAGCUGC	162	GCCAGACA	1099	CCAGACA	2036	CCAGACA	2973
hsa-miR-1233	UGAGCCUGUCCUCCGCAG	163	ACAGGGCTC	1100	CAGGGCTC	2037	AGGGCTC	2974
hsa-miR-1234	UCGGCCUGACCACCCACCCAC	164	GTCAGGCCG	1101	TCAGGCCG	2038	CAGGCCG	2975
hsa-miR-1236	CCUCUCCCUUGUCUCUCCAG	165	GGGAAGAG	1102	GGGAAGAG	2039	GGAAGAG	2976
hsa-miR-1237	UCCUUCUGCUCGUCUCCCCAG	166	AGCAGAAGG	1103	GCAGAAGG	2040	CAGAAGG	2977
hsa-miR-1238	CUUCCUCGUCUGUCUGCCCC	167	GACGAGGAA	1104	ACGAGGAA	2041	CGAGGAA	2978
hsa-miR-124	UAAGGCACGCGGUGAAUGCC	168	GCGTGCCTT	1105	CGTGCCTT	2042	GTGCCTT	2979
hsa-miR-124*	CGUGUUCACAGCGGACCUUGAU	169	TGTAACAC	1106	GTAAACAC	2043	TAAACAC	2980
hsa-miR-1243	AACUGGAUCAUUAUAGGAGUG	170	TGATCCAGT	1107	GATCCAGT	2044	ATCCAGT	2981
hsa-miR-1244	AAGUAGUUGGUUGUAUGAGAUGGUU	171	CCAATACT	1108	CAATACT	2045	AATACT	2982
hsa-miR-1245	AAGUGAUCUAAAGGCCUACAU	172	TAGATCACT	1109	AGATCACT	2046	GATCACT	2983
hsa-miR-1246	AAUGGAUUUUUGGAGCAGG	173	AAAATCCAT	1110	AAATCCAT	2047	AATCCAT	2984
hsa-miR-1247	ACCCGUCCCGUUCGUCCCCGGA	174	CGGGACGGG	1111	GGGACGGG	2048	GGGACGGG	2985
hsa-miR-1248	ACCUUCUUGUAUAAGCACUGUCUAAA	175	ACAAGAAGG	1112	CAAGAAGG	2049	AAGAAGG	2986
hsa-miR-1249	ACGCCUUCUCCCCUUCUUCA	176	GGAAGGGCG	1113	GAAGGGCG	2050	AAGGGCG	2987
hsa-miR-1250	ACGGUGCUGGAUGUGCCUUU	177	CCAGCACCG	1114	CAGCACCG	2051	AGCACCG	2988
hsa-miR-1251	ACUCUAGCUGCCAAGGCGCU	178	CAGCTAGAG	1115	AGCTAGAG	2052	GCTAGAG	2989
hsa-miR-1252	AGAAGGAAUUGAAUUCUUUA	179	ATTCCTTC	1116	TTCTTC	2053	TTCCTTC	2990
hsa-miR-1253	AGAGAAGAAGAUAGCCUGCA	180	CTTCTTCTC	1117	TTCTTCTC	2054	TCTTCTC	2991
hsa-miR-1254	AGCCUGGAAGCUGGAGCCUGCAGU	181	CTCCAGGC	1118	TTCCAGGC	2055	TCCAGGC	2992
hsa-miR-1255a	AGGAUGAGCAAAGAAAGUAGAUU	182	TGCTCATCC	1119	GCTCATCC	2056	TCATCC	2993
hsa-miR-1255b	CGGAUGAGCAAAGAAAGUGGUU	183	TGCTCATCC	1120	GCTCATCC	2057	TCATCC	2994
hsa-miR-1256	AGGCAUUGACUUCUCACUAGCU	184	GTCAATGCC	1121	TCAATGCC	2058	CAATGCC	2995
hsa-miR-1257	AGUGAUGAUGGGUUCUGACC	185	ATCATTAC	1122	TCATTAC	2059	CATTAC	2996
hsa-miR-1258	AGUUAGGAUUAGGUCUGGAA	186	AATCCTAAC	1123	ATCCTAAC	2060	TCCTAAC	2997
hsa-miR-1259	AUAUAUGAUGACUUAGCUUUU	187	CATCATATA	1124	ATCATATA	2061	TCATATA	2998
hsa-miR-125a-3p	ACAGGUGAGGUUCUUGGGAGCC	188	CCTCACCTG	1125	CTCACCTG	2062	TCACCTG	2999
hsa-miR-125a-5p	UCCUGAGACCCUUUAACCUUGA	189	GTCTCAGGG	1126	TCTCAGGG	2063	CTCAGGG	3000
hsa-miR-125b	UCCUGAGACCCUUAACCUUGA	190	GTCTCAGGG	1127	TCTCAGGG	2064	CTCAGGG	3001
hsa-miR-125b-1*	ACGGGUUAGGCUCUUGGGAGCU	191	CCTAACCCG	1128	CTAACCCG	2065	TAACCCG	3002
hsa-miR-125b-2*	UCACAAGUCAGGCUCUUGGGAC	192	TGACTTGTG	1129	GACTTGTG	2066	ACTTGTG	3003
hsa-miR-126	UCGUACCGUGAGUAAUUAUGCG	193	CACGGTACG	1130	ACGGTACG	2067	CGGTACG	3004
hsa-miR-126*	CAUUAUUAUUUGGUACGCG	194	AGTAATAAT	1131	GTAATAAT	2068	TAATAAT	3005
hsa-miR-1260	AUCCCACCUCUGCCACCA	195	GAGGTGGGA	1132	AGGTGGGA	2069	GGTGGGA	3006
hsa-miR-1261	AUGGAUAAGGCUUUGGCUU	196	CCTTATCCA	1133	CTTATCCA	2070	TTATCCA	3007
hsa-miR-1262	AUGGGUGAAUUGUAGAAGGAU	197	ATTCACCCA	1134	TTACACCCA	2071	TCACCCA	3008
hsa-miR-1263	AUGGUACCCUGGCAUACUGAGU	198	AGGGTACCA	1135	GGGTACCA	2072	GGTACCA	3009

hsa-miR-1264	CAAGUCUUUUUAGCACCUGUU	199	ATAAGACTT	1136	TAAGACTT	2073	AAGACTT	3010
hsa-miR-1265	CAGGAUGUGGUCAAGUGUUGUU	200	CCACATCCT	1137	CACATCCT	2074	ACATCCT	3011
hsa-miR-1266	CCUCAGGGCUGUAGAACAGGGCU	201	AGCCCTGAG	1138	GCCCTGAG	2075	CCCTGAG	3012
hsa-miR-1267	CCUGUUGAAGUGUAAUCCCA	202	CTCAACAG	1139	TCAACAG	2076	TCAACAG	3013
hsa-miR-1268	CGGGCUGGUGGUGGGGG	203	ACCACGCC	1140	CCACGCC	2077	CACGCC	3014
hsa-miR-1269	CUGGACUGAGCCGUGCUACUGG	204	CTCAGTCCA	1141	TCAGTCCA	2078	CAGTCCA	3015
hsa-miR-127-3p	UCGGAUCCGUCUGAGCUUGGCU	205	ACGGATCCG	1142	CGGATCCG	2079	GGATCCG	3016
hsa-miR-127-5p	CUGAAGCUCAGAGGGCUCUGAU	206	TGAGCTTCA	1143	GAGCTTCA	2080	AGCTTCA	3017
hsa-miR-1270	CUGGAGAUUGGAAGACUGUGU	207	ATATCTCCA	1144	TATCTCCA	2081	ATCTCCA	3018
hsa-miR-1271	CUUGGCACCUAGCAAGCACUCA	208	AGGTGCCAA	1145	GGTGCCAA	2082	GTGCCAA	3019
hsa-miR-1272	GAUGAUGAUGGCAGCAAUUCUGAAA	209	CATCATCAT	1146	ATCATCAT	2083	TCATCAT	3020
hsa-miR-1273	GGGCGACAAAGCAAGACUCUUUCU	210	TTGTGCGCC	1147	TTGTGCGCC	2084	TGTGCGCC	3021
hsa-miR-1274a	GUCCUGUUCAGGCGCCA	211	GAACAGGGA	1148	AACAGGGA	2085	ACAGGGA	3022
hsa-miR-1274b	UCCUGUUCGGGCGCCA	212	CGAACAGGG	1149	GAACAGGG	2086	AACAGGG	3023
hsa-miR-1275	GUGGGGAGAGGCUGUC	213	TCCTCCCA	1150	CTCCCA	2087	TCCCA	3024
hsa-miR-1276	UAAAGACCCUGGAGACA	214	GGCTCTTT	1151	GGCTCTTT	2088	GCTCTTT	3025
hsa-miR-1277	UACGUAGAUUAUAUGUAUUU	215	TATCTACGT	1152	ATCTACGT	2089	TCTACGT	3026
hsa-miR-1278	UAGUACUGUGCAUAUCAUCUAU	216	CACAGTACT	1153	ACAGTACT	2090	CAGTACT	3027
hsa-miR-1279	UCAUAUUGCUUCUUUCU	217	AGCAATATG	1154	GCAATATG	2091	CAATATG	3028
hsa-miR-128	UCACAGUGAACGGUCUCUUU	218	TCACTGTG	1155	TCACTGTG	2092	CACTGTG	3029
hsa-miR-1280	UCCACCGCUGCCACCC	219	AGCGGTGGG	1156	GCGGTGGG	2093	CGGTGGG	3030
hsa-miR-1281	UCGCCUCCUCCUCUCCC	220	GAGGAGCG	1157	AGGAGCG	2094	GGAGCG	3031
hsa-miR-1282	UCGUUUGCCUUUUUCUGCUU	221	AGGCAAACG	1158	GGCAAACG	2095	GCAAACG	3032
hsa-miR-1283	UCUACAAAGGAAAGCGUUUCU	222	CCTTTGTAG	1159	CTTTGTAG	2096	TTTGTAG	3033
hsa-miR-1284	UCUAUACAGACCCUGGCUUUC	223	CTGTATAG	1160	CTGTATAG	2097	TGTATAG	3034
hsa-miR-1285	UCUGGGCAACAAGUGAGACCU	224	GTGCCCAG	1161	TGCCCAG	2098	TGCCCAG	3035
hsa-miR-1286	UGCAGGACCAAGAUGAGCCCU	225	TGGTCTGC	1162	GGTCTGC	2099	GTCCTGC	3036
hsa-miR-1287	UGCUGGAUCAGUGGUUCGAGUC	226	TGATCCAGC	1163	GATCCAGC	2100	ATCCAGC	3037
hsa-miR-1288	UGGACUGCCUGAUCUGGAGA	227	GGCAGTCC	1164	GGCAGTCC	2101	GCAGTCC	3038
hsa-miR-1289	UGGAGUCCAGGAAUCGCAUUUU	228	CTGGACTCC	1165	TGGACTCC	2102	GACTCC	3039
hsa-miR-129*	AAGCCUUACCCAAAAGUAU	229	GTAAGGGCT	1166	TAAGGGCT	2103	AAGGGCT	3040
hsa-miR-129-3p	AAGCCUUACCCAAAAGCAU	230	GTAAGGGCT	1167	TAAGGGCT	2104	AAGGGCT	3041
hsa-miR-129-5p	CUUUUUGCGGUCUGGGCUUGC	231	CGCAAAAA	1168	CGCAAAAA	2105	GCAAAAA	3042
hsa-miR-1290	UGGAUUUUUGGAUCAGGGA	232	CAAAAATCC	1169	AAAATCC	2106	AAAATCC	3043
hsa-miR-1291	UGGCCUGACUGAAGACCAGCAGU	233	GTCAGGGCC	1170	TCAGGGCC	2107	CAGGGCC	3044
hsa-miR-1292	UGGGAACGGGUUCCGGCAGACGUG	234	CCGTTCCC	1171	CCGTTCCC	2108	CGTTCCC	3045
hsa-miR-1293	UGGGUGGUCUGGAGAUUUGUGC	235	AGACCACCC	1172	GACCACCC	2109	ACCACCC	3046
hsa-miR-1294	UGUGAGGUUGGCAUUGUUGUCU	236	CAACCTCAC	1173	AACCTCAC	2110	ACCTCAC	3047
hsa-miR-1295	UUAGGCCGAGAUUCUGGGUGA	237	TGCGCCTA	1174	GCGCCTA	2111	CGCCTA	3048
hsa-miR-1296	UUAGGCCCGGCUCCAUUCUCC	238	AGGGCCCTA	1175	GGCCCTA	2112	GGCCCTA	3049
hsa-miR-1297	UUCAAGUAAUUCAGGUG	239	ATTAATTGA	1176	TTAATTGA	2113	TACTTGA	3050
hsa-miR-1298	UUCAUUCGGCUGUCCAGAUGUA	240	GCCGAATGA	1177	CCGAATGA	2114	CGAATGA	3051
hsa-miR-1299	UUCUGGAAUUCUGUGAGGGA	241	AATTCCAGA	1178	ATTCCAGA	2115	TTCCAGA	3052
hsa-miR-1300	UUGAGAAGGAGGUCUGCUG	242	TCCTTCTCA	1179	CCTTCTCA	2116	CTTCTCA	3053
hsa-miR-1301	UUGCAGCUGCCUGGGAGUGACUUC	243	GCAGCTGCA	1180	CAGCTGCA	2117	AGCTGCA	3054
hsa-miR-1302	UUGGGACAUAUCUUAUGCUAAA	244	TATGTCCCA	1181	ATGTCCCA	2118	TGTCCCA	3055
hsa-miR-1303	UUUAGAGACGGGUCUUGCUCU	245	GTCTCTAA	1182	TCTCTAA	2119	TCTCTAA	3056
hsa-miR-1304	UUUGAGGCUACAGUGAGAUGUG	246	TAGCCTCAA	1183	AGCCTCAA	2120	GCCTCAA	3057
hsa-miR-1305	UUUCAAUCUCUAAUGGGAGAGA	247	GAGTTGAAA	1184	AGTTGAAA	2121	GTTGAAA	3058
hsa-miR-1306	ACGUUGGCUCUGGUGGUG	248	GAGCCAACG	1185	AGCCAACG	2122	GCCAACG	3059
hsa-miR-1307	ACUCGGCUGGGCUCGGUCGUG	249	CACGCCGAG	1186	ACGCCGAG	2123	CGCCGAG	3060
hsa-miR-1308	GCAUGGGUGGUUCAGUGG	250	CCACCCATG	1187	CACCCATG	2124	ACCCATG	3061
hsa-miR-130a	CAGUGCAAUGUAAAAGGGCAU	251	CATTGCACT	1188	ATTGCACT	2125	TTGCACT	3062
hsa-miR-130a*	UUCACAUUGUGCUACUGUCUGC	252	ACAATGTGA	1189	CAATGTGA	2126	AATGTGA	3063
hsa-miR-130b	CAGUGCAAUGAUGAAAGGGCAU	253	CATTGCACT	1190	ATTGCACT	2127	TTGCACT	3064

hsa-miR-130b*	ACUCUUUCCUGUUGCACUAC	254	GGGAAAGAG	1191	GGAAAGAG	2128	GAAAGAG	3065
hsa-miR-132	UAACAGUCUACAGCCAUGGUCG	255	TAGACTGTT	1192	AGACTGTT	2129	GACTGTT	3066
hsa-miR-132*	ACCGUGGCUUUCGAUUGUUACU	256	AAGCCACGG	1193	AGCCACGG	2130	GCCACGG	3067
hsa-miR-1321	CAGGGAGGUGAAUGUGAU	257	CACCTCCCT	1194	ACCTCCCT	2131	CCTCCCT	3068
hsa-miR-1322	GAUGAUGCUGCUGAUGCUG	258	CAGCATCAT	1195	AGCATCAT	2132	GCATCAT	3069
hsa-miR-1323	UCAAAACUGAGGGCAUUUUCU	259	TCAGTTTTG	1196	CAGTTTTG	2133	AGTTTTG	3070
hsa-miR-1324	CCAGACAGAAUUCUAUGCACUUUC	260	TTCTGTCTG	1197	TCTGTCTG	2134	CTGTCTG	3071
hsa-miR-133a	UUUGGUCCCUUCAACCAGCUG	261	GGGACCAA	1198	GGACCAA	2135	GGACCAA	3072
hsa-miR-133b	UUUGGUCCCUUCAACCAGCUA	262	GGGACCAA	1199	GGACCAA	2136	GGACCAA	3073
hsa-miR-134	UGUGACUGGUUAGACCAGAGGGG	263	ACCAGTCAC	1200	CCAGTCAC	2137	CAGTCAC	3074
hsa-miR-135a	UAUGGCUUUUUAUCCUAUGUGA	264	AAAAGCCAT	1201	AAAGCCAT	2138	AAGCCAT	3075
hsa-miR-135a*	UAUAGGGAUUGGAGCCGUGGCG	265	AATCCCTAT	1202	ATCCCTAT	2139	TCCCTAT	3076
hsa-miR-135b	UAUGGCUUUUAUCCUAUGUGA	266	AAAAGCCAT	1203	AAAGCCAT	2140	AAGCCAT	3077
hsa-miR-135b*	AUGUAGGGCUAAAAGCCAUGGG	267	AGCCCTACA	1204	GCCCTACA	2141	CCCTACA	3078
hsa-miR-136	ACUCCAUUUGUUUGAUGAUGGA	268	CAAATGGAG	1205	AAATGGAG	2142	AATGGAG	3079
hsa-miR-136*	CAUCAUCGUCUCAAUAGAGUCU	269	GACGATGAT	1206	ACGATGAT	2143	CGATGAT	3080
hsa-miR-137	UUUUUGCUUUAAGAAUACGCGUAG	270	TAAGCAATA	1207	AAGCAATA	2144	AGCAATA	3081
hsa-miR-138	AGCUGGUGUUGUGAAUCAGGCCG	271	AACACCAGC	1208	ACACCAGC	2145	CACCAGC	3082
hsa-miR-138-1*	GCUACUUCACAACACCAGGGCC	272	GTGAAGTAG	1209	TGAAGTAG	2146	GAAGTAG	3083
hsa-miR-138-2*	GCUAUUUCACGACACCAGGGUU	273	GTGAAATAG	1210	TGAAATAG	2147	GAAATAG	3084
hsa-miR-139-3p	GGAGACGCGGCCUGUUGGAGU	274	CGCGTCTC	1211	CGGTCTC	2148	GCGTCTC	3085
hsa-miR-139-5p	UCUACAGUGCAGGUGUCUCCAG	275	GCACTGTAG	1212	CACTGTAG	2149	ACTGTAG	3086
hsa-miR-140-3p	UACCACAGGGUAGAACCACGG	276	CCCTGTGGT	1213	CCTGTGGT	2150	CTGTGGT	3087
hsa-miR-140-5p	CAGUGGUUUUACCCUAUGGUAG	277	AAAACCACT	1214	AAACCACT	2151	AACCACT	3088
hsa-miR-141	UAACACUGUCUGGUAAGAUGG	278	GACAGTGT	1215	ACAGTGT	2152	CAGTGT	3089
hsa-miR-141*	CAUCUCCAGUACAGUGUUGGA	279	CTGGAAGAT	1216	TGGAAGAT	2153	GGAAGAT	3090
hsa-miR-142-3p	UGUAGUGUUUCCUACUUUAUGGA	280	AAACTACT	1217	AACACTAC	2154	AACTACT	3091
hsa-miR-142-5p	CAUAAAGUAGAAAGCACUACU	281	CTACTTTAT	1218	TACTTTAT	2155	ACTTTAT	3092
hsa-miR-143	UGAGAUGAAGCACUGUAGCUC	282	CTTCATCTC	1219	TTCATCTC	2156	TCATCTC	3093
hsa-miR-143*	GGUGCAGUGCUGCAUCUCUGGU	283	GCACTGCAC	1220	CACTGCAC	2157	ACTGCAC	3094
hsa-miR-144	UACAGUAUAGAUGAUGUACU	284	CTATACTGT	1221	TATACTGT	2158	ATACTGT	3095
hsa-miR-144*	GGAUUAUCAUCAUUAUCUGUAAG	285	GATGATATC	1222	ATGATATC	2159	TGATATC	3096
hsa-miR-145	GUCCAGUUUCCAGGAAUCCCU	286	AAAAGTGA	1223	AAAGTGA	2160	AAGTGA	3097
hsa-miR-145*	GGAUUCCUGGAAAUACUGUUCU	287	CCAGGAATC	1224	CAGGAATC	2161	AGGAATC	3098
hsa-miR-1468	CUCCGUUUGCCUGUUCGUCUG	288	GCAAACGGA	1225	CAAACGGA	2162	AAACGGA	3099
hsa-miR-1469	CUCGGCGGGGCGGGGCUCC	289	CCGCGCCGA	1226	CGCGCCGA	2163	GCGCCGA	3100
hsa-miR-146a	UGAGAACUGAAUCCAUGGGUU	290	TCAGTTCTC	1227	CAGTTCTC	2164	AGTTCTC	3101
hsa-miR-146a*	CCUCUGAAAUCAGUUCUUCAG	291	ATTTTCAGAG	1228	TTTCAGAG	2165	TTCAGAG	3102
hsa-miR-146b-3p	UGCCUGUGGACUCAGUUCUGG	292	CCACAGGGC	1229	CACAGGGC	2166	ACAGGGC	3103
hsa-miR-146b-5p	UGAGAACUGAAUCCAUGGCU	293	TCAGTTCTC	1230	CAGTTCTC	2167	AGTTCTC	3104
hsa-miR-147	GUGUGUGGAAAUGCUUCUGC	294	TCCACACA	1231	TCCACACA	2168	CCACACA	3105
hsa-miR-1470	GCCUCCGCCCCGUCACCCCG	295	GGCGGAGGG	1232	GCGGAGGG	2169	CGGAGGG	3106
hsa-miR-1471	GCCCGCGUGUGAGCCAGGUGU	296	ACACGCGGG	1233	CACGCGGG	2170	ACGCGGG	3107
hsa-miR-147b	GUGUGCGGAAAUGCUUCGCUA	297	TTCCGCACA	1234	TCCGCACA	2171	CCGCACA	3108
hsa-miR-148a	UCAGUGCACUACAGAACUUUGU	298	AGTGCACCTG	1235	GTGCACCTG	2172	TGCACCTG	3109
hsa-miR-148a*	AAAGUUCUGAGACACUCCGACU	299	TCAGAACTT	1236	CAGAACTT	2173	AGAACTT	3110
hsa-miR-148b	UCAGUGCAUCACAGAACUUUGU	300	GATGCACCTG	1237	ATGCACCTG	2174	TGCACCTG	3111
hsa-miR-148b*	AAGUUCUGUUAUACACUCAGGC	301	AACAGAACT	1238	ACAGAACT	2175	CAGAACT	3112
hsa-miR-149	UCUGGCUCGUGUCUUCACUCCC	302	CGGAGCCAG	1239	GGAGCCAG	2176	GAGCCAG	3113
hsa-miR-149*	AGGGAGGGACGGGGGUGUGC	303	GTCCCTCCC	1240	TCCCTCCC	2177	CCCTCCC	3114
hsa-miR-150	UCUCCAAACCCUUGUACCAGUG	304	GGTTGGGAG	1241	GTTGGGAG	2178	TGGGAG	3115
hsa-miR-150*	CUGGUACAGGCCUGGGGGACAG	305	CCTGTACCA	1242	CTGTACCA	2179	TGTACCA	3116
hsa-miR-151-3p	CUAGACUGAAGCUCCUUGAGG	306	TTCACTCTA	1243	TCACTCTA	2180	CACTCTA	3117
hsa-miR-151-5p	UCGAGGAGCUCACAGUCUAGU	307	AGCTCCTCG	1244	GCTCCTCG	2181	CTCCTCG	3118
hsa-miR-152	UCAGUGCAUGACAGAACUUGG	308	CATGCACCTG	1245	ATGCACCTG	2182	TGCACCTG	3119

hsa-miR-153	UUGCAUAGUCACAAAAGUGAUC	309	GACTATGCA	1246	ACTATGCA	2183	CTATGCA	3120
hsa-miR-1537	AAAACCGUCUAGUUACAGUUGU	310	AGACGGTTT	1247	GACGGTTT	2184	ACGGTTT	3121
hsa-miR-1538	CGGCCCGGGUCGUCGUGUCCU	311	GCCCGGGCC	1248	CCCGGGCC	2185	CCGGGCC	3122
hsa-miR-1539	UCCUGCGCGUCCAGAUGCC	312	ACGCGCAGG	1249	CGCGCAGG	2186	GCGCAGG	3123
hsa-miR-154	UAGGUUAUCGUGUUGCCUUCG	313	GGATAACCT	1250	GATAACCT	2187	ATAACCT	3124
hsa-miR-154*	AAUCAUACACGGUUGACCUAUU	314	GTGTATGAT	1251	TGTATGAT	2188	GTATGAT	3125
hsa-miR-155	UUAUUGCUAAUCGUGAUAGGGU	315	TTAGCATT	1252	TAGCATT	2189	AGCATT	3126
hsa-miR-155*	CUCCUACAUUUAGCAUUAACA	316	TATGTAGGA	1253	ATGTAGGA	2190	TGTAGGA	3127
hsa-miR-15a	UAGCAGCACAUAAUGGUUUGUG	317	TGTGCTGCT	1254	GTGCTGCT	2191	TGCTGCT	3128
hsa-miR-15a*	CAGGCCAUUUGUGUGCCUCA	318	ATATGGCCT	1255	TATGGCCT	2192	ATGGCCT	3129
hsa-miR-15b	UAGCAGCACAUUGGUUUACA	319	TGTGCTGCT	1256	GTGCTGCT	2193	TGCTGCT	3130
hsa-miR-15b*	CGAAUCAUUUUGUGUCUCUA	320	TAATGATTC	1257	AATGATTC	2194	ATGATTC	3131
hsa-miR-16	UAGCAGCACGUAUUUUGGCG	321	CGTGTGCT	1258	GTGCTGCT	2195	TGCTGCT	3132
hsa-miR-16-1*	CCAGUAUUACUGUGUCUGUGA	322	TTAATACTG	1259	TAATACTG	2196	AATACTG	3133
hsa-miR-16-2*	CCAAUUAUACUGUGUCUUUA	323	GTAATATTG	1260	TAATATTG	2197	AATATTG	3134
hsa-miR-17	CAAAGUCUACAGUGCAGGUAG	324	AAGCACTTT	1261	AGCACTTT	2198	GCACTTT	3135
hsa-miR-17*	ACUGCAGUGAAGGCACUUGUAG	325	TCCTGCAG	1262	CACTGCAG	2199	ACTGCAG	3136
hsa-miR-181a	AACAUUCAACGUCUGCGUGAGU	326	TTGAATGT	1263	TTGAATGT	2200	TGAATGT	3137
hsa-miR-181a*	ACCAUCGACCGUUGAUUGUACC	327	GGTCGATGG	1264	GTCGATGG	2201	TCGATGG	3138
hsa-miR-181a-2*	ACCACUGACCGUUGACUGUACC	328	GGTCAGTGG	1265	GTCAGTGG	2202	TCAGTGG	3139
hsa-miR-181b	AACAUAUUGCUGUCGGUGGGU	329	AATGAATGT	1266	ATGAATGT	2203	TGAATGT	3140
hsa-miR-181c	AACAUAUACCGUCUGCGUGAGU	330	GTTGAATGT	1267	TTGAATGT	2204	TGAATGT	3141
hsa-miR-181c*	AACCAUCGACCGUUGAGUGGAC	331	GTCGATGGT	1268	TCGATGGT	2205	CGATGGT	3142
hsa-miR-181d	AACAUAUUGUUGUCGGUGGGU	332	AATGAATGT	1269	ATGAATGT	2206	TGAATGT	3143
hsa-miR-182	UUUGCAAUGGUGAAGACUCACACU	333	CATTGCCAA	1270	ATTGCCAA	2207	TGCCAA	3144
hsa-miR-182*	UGGUUCUAGACUUGCCAACUA	334	TCTAGAACC	1271	CTAGAACC	2208	TAGAACC	3145
hsa-miR-1825	UCCAGUGCCCUCCUCUCC	335	GGCACTGG	1272	GCACTGG	2209	GCACTGG	3146
hsa-miR-1826	AUUGAUCUAGACACUUGCAACGAAU	336	GATGATCAA	1273	ATGATCAA	2210	TGATCAA	3147
hsa-miR-1827	UGAGGCAGUAGAUUGAAU	337	TACTGCCTC	1274	ACTGCCTC	2211	CTGCCTC	3148
hsa-miR-183	UAUGGCACUGGUGAUAUUCACU	338	CAGTGCCAT	1275	AGTGCCAT	2212	GTGCCAT	3149
hsa-miR-183*	GUGAAUUACCGAAGGCCAUAA	339	GGTAATTCA	1276	GTAATTCA	2213	TAATTCA	3150
hsa-miR-184	UGGACGGAGAACUGAUAGGGU	340	TCTCCGTCC	1277	CTCCGTCC	2214	TCCGTCC	3151
hsa-miR-185	UGGAGAGAAAGGCAGUUCUGA	341	TTCTCTCC	1278	TTCTCTCC	2215	TCTCTCC	3152
hsa-miR-185*	AGGGGCGGCUUCCUCUGGUC	342	GCCAGCCCC	1279	CCAGCCCC	2216	CAGCCCC	3153
hsa-miR-186	CAAAGAAUUCUCCUUUGGGCU	343	GAATCTTT	1280	AATCTTT	2217	ATCTTT	3154
hsa-miR-186*	GCCCAAAGGUGAAUUUUUGGG	344	ACCTTTGGG	1281	CCTTTGGG	2218	CTTTGGG	3155
hsa-miR-187	UCGUGUCUUGUGUUGCAGCCGG	345	CAAGACACG	1282	AAGACACG	2219	AGACACG	3156
hsa-miR-187*	GGCUACAACACAGGACCCGGGC	346	TGTTGTAGC	1283	GTTGTAGC	2220	TGTAGC	3157
hsa-miR-188-3p	CUCCACAUGCAGGGUUUGCA	347	CATGTGGGA	1284	ATGTGGGA	2221	TGTGGGA	3158
hsa-miR-188-5p	CAUCCUUGCAUGGUGGAGGG	348	GCAAGGGAT	1285	CAAGGGAT	2222	AAGGGAT	3159
hsa-miR-18a	UAAGGUGCAUCUAGUGCAGAUAG	349	ATGCACCTT	1286	TGCACCTT	2223	GCACCTT	3160
hsa-miR-18a*	ACUGCCCUAAGUCUCCUUCUGG	350	TTAGGGCAG	1287	TAGGGCAG	2224	AGGGCAG	3161
hsa-miR-18b	UAAGGUGCAUCUAGUGCAGUAG	351	ATGCACCTT	1288	TGCACCTT	2225	GCACCTT	3162
hsa-miR-18b*	UGCCCUAAAUGCCCUUCUGGC	352	ATTTAGGGC	1289	TTTAGGGC	2226	TTAGGGC	3163
hsa-miR-190	UGAUAUGUUUGAUUAUUAGGU	353	AAACATATC	1290	AACATATC	2227	ACATATC	3164
hsa-miR-1908	CGGCGGGGACGGCGAUUGGUC	354	GTCCCGCC	1291	TCCCGCC	2228	CCCGCC	3165
hsa-miR-1909	CGCAGGGGCGGGUGUCACCG	355	GGCCCTGC	1292	GCCCTGC	2229	CCCTGC	3166
hsa-miR-1909*	UGAGUGCCGGUGCCUGCCUG	356	CCGGCACTC	1293	CGGCACTC	2230	GCGACTC	3167
hsa-miR-190b	UGAUAUGUUUGAUUUUGGGU	357	AAACATATC	1294	AACATATC	2231	ACATATC	3168
hsa-miR-191	CAACGGAAUCCAAAAGCAGCUG	358	GATTCGGTT	1295	ATTCCGTT	2232	TTCGGTT	3169
hsa-miR-191*	GCUGCGCUUGGAUUUCGUCCCC	359	CAAGCGCAG	1296	AAGCGCAG	2233	AGCGCAG	3170
hsa-miR-1910	CCAGUCCUGUGCCUGCCGCCU	360	ACAGGACTG	1297	CAGGACTG	2234	AGGACTG	3171
hsa-miR-1911	UGAGUACCGCAUGUCUGUUGGG	361	GCGGTACTC	1298	CGGTACTC	2235	GGTACTC	3172
hsa-miR-1911*	CACCAGGAUUGUGGUCUCC	362	ATGCCTGGT	1299	TGCCTGGT	2236	GCCTGGT	3173
hsa-miR-1912	UACCCAGAGCAUGCAGUGUGAA	363	GCTCTGGGT	1300	CTCTGGGT	2237	TCTGGGT	3174

hsa-miR-1913	UCUGCCCCCUCGCGUCUGCCA	364	AGGGGGCAG	1301	GGGGGCAG	2238	GGGGCAG	3175
hsa-miR-1914	CCCUGUGCCC GCCCACUUCUG	365	GGGCACAGG	1302	GGCACAGG	2239	GCACAGG	3176
hsa-miR-1914*	GGAGGGGUC CCGCACUGGGAGG	366	GGACCCCTC	1303	GACCCCTC	2240	ACCCCTC	3177
hsa-miR-1915	CCCCAGGGGACGCGGCGGG	367	CGCCCTGGG	1304	GCCCTGGG	2241	CCCTGGG	3178
hsa-miR-1915*	ACCUUGCCUUGCUGCCCGGGCC	368	AAGGCAAGG	1305	AGGCAAGG	2242	GGCAAGG	3179
hsa-miR-192	CUGACCUAUGAAUUGACAGCC	369	CATAGGTCA	1306	ATAGGTCA	2243	TAGGTCA	3180
hsa-miR-192*	CUGCCA AUUCAUAGGUCACAG	370	GAATTGGCA	1307	AATTGGCA	2244	ATTGGCA	3181
hsa-miR-193a-3p	AACUGGCCUACA AAGUCCAGU	371	TAGGCCAGT	1308	AGGCCAGT	2245	GGCCAGT	3182
hsa-miR-193a-5p	UGGGUCUUUGCGGGCGAGAUGA	372	CAAAGACCC	1309	AAAGACCC	2246	AAGACCC	3183
hsa-miR-193b	AACUGGCCUACA AAGUCCCGCU	373	AGGGCCAGT	1310	GGGCCAGT	2247	GGCCAGT	3184
hsa-miR-193b*	CGGGUUUUUGAGGGCGAGAUGA	374	CAAACCC	1311	AAAACCC	2248	AAACCC	3185
hsa-miR-194	UGUAACAGCAACUCCAUGUGGA	375	TGCTGT TAC	1312	GCTGT TAC	2249	CTGT TAC	3186
hsa-miR-194*	CCAGUGGGGCGUCGUUAUCUG	376	GCCCCACTG	1313	CCCCACTG	2250	CCCACTG	3187
hsa-miR-195	UAGCAGCACAGAAUAUUGGC	377	TGTGCTGCT	1314	GTGCTGCT	2251	TGTGCTGCT	3188
hsa-miR-195*	CCAAUAUUGCUGUGCUGCUCC	378	CCAATATTG	1315	CAATATTG	2252	AATATTG	3189
hsa-miR-196a	UAGGUAGUUUAUGUUGUUGGG	379	AAACTACCT	1316	AACTACCT	2253	ACTACCT	3190
hsa-miR-196a*	CGGCAACAAGAAACUGCCUGAG	380	CTTGT T GCC	1317	TGT T GCC	2254	TGT T GCC	3191
hsa-miR-196b	UAGGUAGUUUCUGUUGUUGGG	381	AAACTACCT	1318	AACTACCT	2255	ACTACCT	3192
hsa-miR-197	UUCACCACCUUCUCCACCCAGC	382	AGGTGGTGA	1319	GGTGGTGA	2256	GTGGTGA	3193
hsa-miR-198	GGUCCAGAGGGGAGAUAGGUUC	383	CCTCTGGAC	1320	CTCTGGAC	2257	TCTGGAC	3194
hsa-miR-199a-5p	CCCAGUGUUCAGACUACCGUUC	384	GAACACTGG	1321	AACACTGG	2258	AACTGG	3195
hsa-miR-199b-3p	ACAGUAGUCUGCACAUGGUUA	385	AGACTACTG	1322	GACTACTG	2259	ACTACTG	3196
hsa-miR-199b-5p	CCCAGUGUUUAGACUAUCGUUC	386	AAACTACTG	1323	AACACTGG	2260	AACTGG	3197
hsa-miR-19a	UGUGCAAUCUAUGCAAACUGA	387	GATTTGCAC	1324	ATTTGCAC	2261	TTTGCAC	3198
hsa-miR-19a*	AGUUUUGCAUAGUUGCACUACA	388	ATGCAAAAC	1325	TGCAAAAC	2262	GCAAAAC	3199
hsa-miR-19b	UGUGCAAUCAUGCAAACUGA	389	GATTTGCAC	1326	ATTTGCAC	2263	TTTGCAC	3200
hsa-miR-19b-1*	AGUUUUGCAGGUUUGCAUCCAGC	390	CTGCAAAAC	1327	TGCAAAAC	2264	GCAAAAC	3201
hsa-miR-19b-2*	AGUUUUGCAGGUUUGCAUUUCA	391	CTGCAAAAC	1328	TGCAAAAC	2265	GCAAAAC	3202
hsa-miR-200a	UAACACUGUCUGGUUACGAUGU	392	GACAGTGTT	1329	ACAGTGTT	2266	CAGTGTT	3203
hsa-miR-200a*	CAUCUUACCGACAGUGCUGGA	393	CGGTAAGAT	1330	GGTAAGAT	2267	GTAAGAT	3204
hsa-miR-200b	UAAUACUGCCUGGUAAUGAUGA	394	GGCAGTATT	1331	GCAGTATT	2268	CAGTATT	3205
hsa-miR-200b*	CAUCUUACUGGGCAGCAUUGGA	395	CAGTAAGAT	1332	AGTAAGAT	2269	GTAAGAT	3206
hsa-miR-200c	UAAUACUGCCGGUAAUGAUGGA	396	GGCAGTATT	1333	GCAGTATT	2270	CAGTATT	3207
hsa-miR-200c*	CGUCUUACCCAGCAGUUGUUGG	397	GGGTAAGAC	1334	GGTAAGAC	2271	GTAAGAC	3208
hsa-miR-202	AGAGGUUAUAGGGCAUGGGAA	398	CTATACCTC	1335	TATACCTC	2272	ATACCTC	3209
hsa-miR-202*	UUCCUAUGCAUAUACUUCUUUG	399	TGCATAGGA	1336	GCATAGGA	2273	CATAGGA	3210
hsa-miR-203	GUGAAAUGUUUAGGACCACUAG	400	AACATTTCA	1337	ACATTTCA	2274	CATTTCA	3211
hsa-miR-204	UUCUUUUGUCAUCCUAUGCCU	401	ACAAAGGGA	1338	CAAAGGGA	2275	AAAGGGA	3212
hsa-miR-205	UCCUUAUCCACCGGAGUCUG	402	GAATGAAGG	1339	AATGAAGG	2276	ATGAAGG	3213
hsa-miR-206	UGGAUGUAAGGAAGUGUGGG	403	TTACATTCC	1340	TACATTCC	2277	ACATTCC	3214
hsa-miR-208a	AUAAGACGAGCAAAAAGCUUGU	404	CTCGTCTTA	1341	TCGTCTTA	2278	CGTCTTA	3215
hsa-miR-208b	AUAAGACGAACAAAAGGUUUUGU	405	TTCGTCTTA	1342	TCGTCTTA	2279	CGTCTTA	3216
hsa-miR-20a	UAAAGUGCUUAUAGUGCAGGUAG	406	AAGCACTTT	1343	AGCACTTT	2280	GCACTTT	3217
hsa-miR-20a*	ACUGCAUUAUGAGCACUUAAG	407	ATAATGCAG	1344	TAATGCAG	2281	AATGCAG	3218
hsa-miR-20b	CAAAGUCUCAUAGUGCAGGUAG	408	GAGCACTTT	1345	AGCACTTT	2282	GCACTTT	3219
hsa-miR-20b*	ACUGUAGUAUGGGCACUCCAG	409	ATACTACAG	1346	TACTACAG	2283	ACTACAG	3220
hsa-miR-21	UAGCUUAUCAGACUGAUGUUGA	410	TGATAAGCT	1347	GATAAGCT	2284	ATAAGCT	3221
hsa-miR-21*	CAACACCAGUCGAUGGGCUGU	411	ACTGGTGTT	1348	CTGGTGTT	2285	TGGTGTT	3222
hsa-miR-210	CUGUGCGUGUGACAGCGGCUGA	412	ACACGCACA	1349	CACGCACA	2286	ACGCACA	3223
hsa-miR-211	UUCUUUUGUCAUCCUUCGCCU	413	ACAAAGGGA	1350	CAAAGGGA	2287	AAAGGGA	3224
hsa-miR-212	UAACAGUCUCCAGUCACGGCC	414	GAGACTGTT	1351	AGACTGTT	2288	GACTGTT	3225
hsa-miR-214	ACAGCAGGCACAGACAGGCAGU	415	TGCCTGCTG	1352	GCCTGCTG	2289	CCTGCTG	3226
hsa-miR-214*	UGCCUGUCUACACUUGCUGUGC	416	TAGACAGGC	1353	AGACAGGC	2290	GACAGGC	3227
hsa-miR-215	AUGACCUAUGAAUUGACAGAC	417	CATAGGTCA	1354	ATAGGTCA	2291	TAGGTCA	3228
hsa-miR-216a	UAAUCUCAGUGGCACUGUGA	418	GCTGAGATT	1355	CTGAGATT	2292	TGAGATT	3229

hsa-miR-216b	AAAUCUCUGCAGGCAAUGUGA	419	GCAGAGATT	1356	CAGAGATT	2293	AGAGATT	3230
hsa-miR-217	UACUGCAUCAGGAACUGAUUGGA	420	TGATGCAGT	1357	GATGCAGT	2294	ATGCAGT	3231
hsa-miR-218	UUGUGCUUGAUCUAACCAUGU	421	TCAAGCACA	1358	CAAGCACA	2295	AAGCACA	3232
hsa-miR-218-1*	AUGGUUCCGUCAAGCACCAUGG	422	ACGGAACCA	1359	CGGAACCA	2296	GGAACCA	3233
hsa-miR-218-2*	CAUGGUUCUGUCAAGCACCGCG	423	CAGAACCAT	1360	AGAACCAT	2297	GAACCAT	3234
hsa-miR-219-1-3p	AGAGUUGAGUCUGGACGUCCCG	424	ACTCAACTC	1361	CTCAACTC	2298	TCAACTC	3235
hsa-miR-219-2-3p	AGAAUUGUGGUCUGACAUCUGU	425	CCACAATTC	1362	CACAATTC	2299	ACAATTC	3236
hsa-miR-219-5p	UGAUUGUCCAAACGCAAUUCU	426	TGGACAATC	1363	GGACAATC	2300	GACAATC	3237
hsa-miR-22	AAGCUGCCAGUUGAAGAACUGU	427	CTGGCAGCT	1364	TGGCAGCT	2301	GGCAGCT	3238
hsa-miR-22*	AGUUCUUCAGUGGCAAGCUUUA	428	CTGAAGAAC	1365	TGAAGAAC	2302	GAAGAAC	3239
hsa-miR-220a	CCACACCGUACUGACACUUU	429	TACGGTGTG	1366	ACGGTGTG	2303	CGGTGTG	3240
hsa-miR-220b	CCACCACCGUGUCUGACACUU	430	ACGGTGTG	1367	CGGTGTG	2304	GGTGTG	3241
hsa-miR-220c	ACACAGGGCUGUUGUGAAGACU	431	AGCCCTGTG	1368	GCCCTGTG	2305	CCCTGTG	3242
hsa-miR-221	AGCUACAUUGUCUGUGGGUUUC	432	CAATGTAGC	1369	AATGTAGC	2306	ATGTAGC	3243
hsa-miR-221*	ACCGGCAUACAAUGUAGAUUU	433	TATGCCAGG	1370	ATGCCAGG	2307	TGCCAGG	3244
hsa-miR-222	AGCUACAUCUGGCUACUGGGU	434	AGATGTAGC	1371	GATGTAGC	2308	ATGTAGC	3245
hsa-miR-222*	CUCAGUAGCCAGUGUAGAUCU	435	GGCTACTGA	1372	GCTACTGA	2309	CTACTGA	3246
hsa-miR-223	UGUCAGUUUGUCAAAUACCCCA	436	CAAATGAC	1373	AAATGAC	2310	AAATGAC	3247
hsa-miR-223*	CGUGUAUUUGACAAGCUGAGUU	437	CAAATACAC	1374	AAATACAC	2311	AATACAC	3248
hsa-miR-224	CAAGUCACUAGUGGUUCCGUU	438	TAGTGACTT	1375	AGTGACTT	2312	GTGACTT	3249
hsa-miR-23a	AUCACAUUGCCAGGGAUUUCC	439	GCAATGTGA	1376	CAATGTGA	2313	AATGTGA	3250
hsa-miR-23a*	GGGUUCCUGGGGAUGGGAUUU	440	CAGGAACCC	1377	AGGAACCC	2314	GAACCC	3251
hsa-miR-23b	AUCACAUUGCCAGGGAUUACC	441	GCAATGTGA	1378	CAATGTGA	2315	AATGTGA	3252
hsa-miR-23b*	UGGGUCCUGGCAUGCUGAUUU	442	CAGGAACCC	1379	AGGAACCC	2316	GAACCC	3253
hsa-miR-24	UGGCUCAGUUCAGCAGGAACAG	443	AACTGAGCC	1380	ACTGAGCC	2317	CTGAGCC	3254
hsa-miR-24-1*	UGCCUACUGAGCUGAUACAGU	444	TCAGTAGGC	1381	CAGTAGGC	2318	AGTAGGC	3255
hsa-miR-24-2*	UGCCUACUGAGCUGAAACACAG	445	TCAGTAGGC	1382	CAGTAGGC	2319	AGTAGGC	3256
hsa-miR-25	CAUUGCACUUGUCUGGUCUGA	446	AAGTGCAAT	1383	AGTGCAAT	2320	GTGCAAT	3257
hsa-miR-25*	AGGCGGAGACUUGGGCAAUUG	447	GTCTCCGCC	1384	TCTCCGCC	2321	CTCCGCC	3258
hsa-miR-26a	UUCAAGUAAUCCAGGAUAGGCU	448	ATTACTTGA	1385	TACTTGA	2322	TACTTGA	3259
hsa-miR-26a-1*	CCUAUUCUUGGUUACUUGCACG	449	CAAGAATAG	1386	AAGAATAG	2323	AGAATAG	3260
hsa-miR-26a-2*	CCUAUUCUUGAUUACUUGUUUC	450	CAAGAATAG	1387	AAGAATAG	2324	AGAATAG	3261
hsa-miR-26b	UUCAAGUAAUUCAGGAUAGGU	451	ATTACTTGA	1388	TACTTGA	2325	TACTTGA	3262
hsa-miR-26b*	CCUGUUCUCCAUAUACUUGGCUC	452	GGAGAACAG	1389	GAGAACAG	2326	AGAACAG	3263
hsa-miR-27a	UUCACAGUGGCUAAGUUCGCG	453	CCACTGTGA	1390	CACTGTGA	2327	ACTGTGA	3264
hsa-miR-27a*	AGGGCUUAGCUGCUUGUGAGCA	454	GCTAAGCCC	1391	CTAAGCCC	2328	TAAGCCC	3265
hsa-miR-27b	UUCACAGUGGCUAAGUUCUGC	455	CCACTGTGA	1392	CACTGTGA	2329	ACTGTGA	3266
hsa-miR-27b*	AGAGCUUAGCUGAUUGGUGAAC	456	GCTAAGCTC	1393	CTAAGCTC	2330	TAAGCTC	3267
hsa-miR-28-3p	CACUAGAUUGAGCUCUGGA	457	CAATCTAGT	1394	AATCTAGT	2331	ATCTAGT	3268
hsa-miR-28-5p	AAGGAGCUCACAGUCUAUUGAG	458	TGAGCTCCT	1395	GAGCTCCT	2332	AGCTCCT	3269
hsa-miR-296-3p	GAGGUUUGGGUGGAGGCUCUCC	459	CCAACCCT	1396	CAACCCT	2333	CAACCCT	3270
hsa-miR-296-5p	AGGGCCCCCUCAAUCCUGU	460	GGGGGCC	1397	GGGGGCC	2334	GGGGGCC	3271
hsa-miR-297	AUGUAUGUGCAUGUGCAUG	461	ACACATACA	1398	CACATACA	2335	ACATACA	3272
hsa-miR-298	AGCAGAAGCAGGGAGGUUCUCCA	462	TGCTTCTGC	1399	GCTTCTGC	2336	CTTCTGC	3273
hsa-miR-299-3p	UAUGUGGGAUGGUAAAACGCUU	463	ATCCACAT	1400	TCCACAT	2337	CCACAT	3274
hsa-miR-299-5p	UGGUUACCGUCCACAUAACU	464	CGGTAACCC	1401	GGTAACCC	2338	GTAACCC	3275
hsa-miR-29a	UAGCACCAUCUGAAUCCGUUA	465	GATGGTGCT	1402	ATGGTGCT	2339	TGGTGCT	3276
hsa-miR-29a*	ACUGAUUUCUUUGGUGUUCAG	466	AGAAATCAG	1403	GAAATCAG	2340	AAATCAG	3277
hsa-miR-29b	UAGCACCAUUGAAUCCAGUGUU	467	AATGGTGCT	1404	ATGGTGCT	2341	TGGTGCT	3278
hsa-miR-29b-1*	GCUGGUUUCAUUGGUGGUUAGA	468	TGAAACCAG	1405	GAAACCAG	2342	AAACCAG	3279
hsa-miR-29b-2*	CUGGUUUCACAUUGGUGGUUAG	469	GTGAAACCA	1406	TGAAACCA	2343	GAAACCA	3280
hsa-miR-29c	UAGCACCAUUGAAUCCGUUA	470	AATGGTGCT	1407	ATGGTGCT	2344	TGGTGCT	3281
hsa-miR-29c*	UGACCGAUUUCUCCUGGUGUUC	471	AAATCGGTC	1408	AATCGGTC	2345	ATCGGTC	3282
hsa-miR-300	UAUACAAGGCAGACUCUCUCU	472	CCCTTGAT	1409	CCTTGAT	2346	CTTGAT	3283
hsa-miR-301a	CAGUGCAUAGUAUUGUCAAAAGC	473	TATTGCACT	1410	ATTGCACT	2347	TTGCACT	3284

hsa-miR-301b	CAGUGCAAUGAUUUGUCAAAAGC	474	CATTGCACT	1411	ATTGCACT	2348	TGCACT	3285
hsa-miR-302a	UAAGUGCUUCAUGUUUUGGUGA	475	GAAGCACTT	1412	AAGCACTT	2349	AGCACTT	3286
hsa-miR-302a*	ACUUAACUGUGGAUGUACUUGCU	476	ACGTTTAAAG	1413	CGTTTAAAG	2350	GTTTAAAG	3287
hsa-miR-302b	UAAGUGCUUCAUGUUUUGAGUAG	477	GAAGCACTT	1414	AAGCACTT	2351	AGCACTT	3288
hsa-miR-302b*	ACUUUAACAUGGAAGUGCUUUC	478	ATGTTAAAG	1415	TGTTAAAG	2352	GTTAAAG	3289
hsa-miR-302c	UAAGUGCUUCAUGUUUCAGUGG	479	GAAGCACTT	1416	AAGCACTT	2353	AGCACTT	3290
hsa-miR-302c*	UUUAACAUGGGGUACCUGCUG	480	CCATGTTAA	1417	CATGTTAA	2354	ATGTTAA	3291
hsa-miR-302d	UAAGUGCUUCAUGUUUGAGUGU	481	GAAGCACTT	1418	AAGCACTT	2355	AGCACTT	3292
hsa-miR-302d*	ACUUUAACAUGGAGGCACUUGC	482	ATGTTAAAG	1419	TGTTAAAG	2356	GTTAAAG	3293
hsa-miR-302e	UAAGUGCUUCAUGCUU	483	GAAGCACTT	1420	AAGCACTT	2357	AGCACTT	3294
hsa-miR-302f	UAAUUGCUUCAUGUUU	484	GAAGCAATT	1421	AAGCAATT	2358	AGCAATT	3295
hsa-miR-30a	UGUAAACAUCUCGACUGGAAG	485	GATGTTTAC	1422	ATGTTTAC	2359	TGTTTAC	3296
hsa-miR-30a*	CUUUCAGUCGGAUGUUUGCAGC	486	CGACTGAAA	1423	GACTGAAA	2360	ACTGAAA	3297
hsa-miR-30b	UGUAAACAUCUACACUCAGCU	487	GATGTTTAC	1424	ATGTTTAC	2361	TGTTTAC	3298
hsa-miR-30b*	CUGGGAGGUGGAUGUUUACUUC	488	CACCTCCCA	1425	ACCTCCCA	2362	CCTCCCA	3299
hsa-miR-30c	UGUAAACAUCUACACUCAGC	489	GATGTTTAC	1426	ATGTTTAC	2363	TGTTTAC	3300
hsa-miR-30c-1*	CUGGGAGAGGUGUUUACUUC	490	CCTCTCCCA	1427	CTCTCCCA	2364	TCTCCCA	3301
hsa-miR-30c-2*	CUGGGAGAAGCGUUUACUCU	491	CTTCTCCCA	1428	TTCTCCCA	2365	TCTCCCA	3302
hsa-miR-30d	UGUAAACAUCGACUGGAAG	492	GATGTTTAC	1429	ATGTTTAC	2366	TGTTTAC	3303
hsa-miR-30d*	CUUUCAGUCAGAUUUUGCUGC	493	TGACTGAAA	1430	GACTGAAA	2367	ACTGAAA	3304
hsa-miR-30e	UGUAAACAUCUUGACUGGAAG	494	GATGTTTAC	1431	ATGTTTAC	2368	TGTTTAC	3305
hsa-miR-30e*	CUUUCAGUCGGAUGUUUACAGC	495	CGACTGAAA	1432	GACTGAAA	2369	ACTGAAA	3306
hsa-miR-31	AGGCAAGAUGCUGGCAUAGCU	496	CATCTTGCC	1433	ATCTTGCC	2370	TCTTGCC	3307
hsa-miR-31*	UGCUAUGCCAACAUAUUGCCAUC	497	TGGCATAGC	1434	GGCATAGC	2371	GCATAGC	3308
hsa-miR-32	UAUUGCACAUUACUAAGUUGCA	498	ATGTGCAAT	1435	TGTGCAAT	2372	GTGCAAT	3309
hsa-miR-32*	CAAUUUAGUGUGUGAUUUU	499	CACTAAATT	1436	ACTAAATT	2373	CTAAATT	3310
hsa-miR-320a	AAAAGCUGGGUUGAGAGGGCGA	500	CCCAGCTTT	1437	CCAGCTTT	2374	CAGCTTT	3311
hsa-miR-320b	AAAAGCUGGGUUGAGAGGGCAA	501	CCCAGCTTT	1438	CCAGCTTT	2375	CAGCTTT	3312
hsa-miR-320c	AAAAGCUGGGUUGAGAGGGU	502	CCCAGCTTT	1439	CCAGCTTT	2376	CAGCTTT	3313
hsa-miR-320d	AAAAGCUGGGUUGAGAGGA	503	CCCAGCTTT	1440	CCAGCTTT	2377	CAGCTTT	3314
hsa-miR-323-3p	CACAUACACGGUCGACCUCU	504	GTGTAATGT	1441	TGTAATGT	2378	GTAATGT	3315
hsa-miR-323-5p	AGGUGGUCCGUGGCGGUUCGC	505	CGGACCACC	1442	GGACCACC	2379	GACCACC	3316
hsa-miR-324-3p	ACUGCCCCAGGUGCUGCUGG	506	CTGGGCGAG	1443	TGGGCGAG	2380	GGGCGAG	3317
hsa-miR-324-5p	CGCAUCCCCUAGGGCAUUGGUGU	507	AGGGGATGC	1444	GGGGATGC	2381	GGGATGC	3318
hsa-miR-325	CCUAGUAGGUGUCCAGUAAGUGU	508	ACCTACTAG	1445	CCTACTAG	2382	CTACTAG	3319
hsa-miR-326	CCUCUGGGCCUUCUCCAG	509	GGCCAGAG	1446	GCCAGAG	2383	CCAGAG	3320
hsa-miR-328	CUGGCCUCUCUGCCUUCUGU	510	AGAGGGCCA	1447	GAGGGCCA	2384	AGGGCCA	3321
hsa-miR-329	AACACACCGUUAACCUCUUU	511	CAGGTGTGT	1448	AGGTGTGT	2385	GGTGTGT	3322
hsa-miR-330-3p	GCAAAGCACACGGCCUGCAGAGA	512	TGTGCTTTG	1449	GTGCTTTG	2386	TGCTTTG	3323
hsa-miR-330-5p	UCUCUGGGCCUGUCUUAGGC	513	GGCCAGAG	1450	GCCAGAG	2387	CCAGAG	3324
hsa-miR-331-3p	GCCCCUGGGCUAUCCUAGAA	514	GCCCAGGGG	1451	CCCAGGGG	2388	CCAGGGG	3325
hsa-miR-331-5p	CUAGGUAUGGUCCAGGGAUCC	515	CCATACCTA	1452	CATACCTA	2389	ATACCTA	3326
hsa-miR-335	UCAAGAGCAAUACGAAAAAUGU	516	TTGCTCTTG	1453	TGCTCTTG	2390	GCTCTTG	3327
hsa-miR-335*	UUUUUCAUUAUUGCUCCUGACC	517	TAATGAAAA	1454	AATGAAAA	2391	ATGAAAA	3328
hsa-miR-337-3p	CUCCUAUAGAUGCCUUUCUUC	518	CATATAGGA	1455	ATATAGGA	2392	TATAGGA	3329
hsa-miR-337-5p	GAACGGCUUCAACAGAGUU	519	GAAGCCGTT	1456	AAGCCGTT	2393	AGCCGTT	3330
hsa-miR-338-3p	UCCAGCAUCAGUAUUUUGUUG	520	TGATGCTGG	1457	GATGCTGG	2394	ATGCTGG	3331
hsa-miR-338-5p	AACAUAUCCUGGUGCUGAGUG	521	GGATATTGT	1458	GATATTGT	2395	ATATTGT	3332
hsa-miR-339-3p	UGAGCGCCUCGACGACAGAGCCG	522	GAGGCGCTC	1459	AGGCGCTC	2396	GGCGCTC	3333
hsa-miR-339-5p	UCCUGUCCUCCAGGAGCUCACG	523	AGGACAGGG	1460	GGACAGGG	2397	GACAGGG	3334
hsa-miR-33a	GUGCAUUGUAGUUGCAUUGCA	524	TACAATGCA	1461	ACAATGCA	2398	CAATGCA	3335
hsa-miR-33a*	CAAUGUUUCCACAGUGCAUCAC	525	GAAACATT	1462	GAAACATT	2399	AAACATT	3336
hsa-miR-33b	GUGCAUUGCUGUUGCAUUGC	526	AGCAATGCA	1463	GCAATGCA	2400	CAATGCA	3337
hsa-miR-33b*	CAGUGCCUCGCGAGUGCAGCCC	527	CGAGGCACT	1464	GAGGCACT	2401	AGGCACT	3338
hsa-miR-340	UUUAUAAAGCAAUGAGACUGAUU	528	TGCTTTATA	1465	GCTTTATA	2402	CTTTATA	3339

hsa-miR-340*	UCCGUCUCAGUUAUUUAUAGC	529	CTGAGACGG	1466	TGAGACGG	2403	GAGACGG	3340
hsa-miR-342-3p	UCUCACACAGAAAUCGCACCCGU	530	CTGTGTGAG	1467	TGTGTGAG	2404	GTGTGAG	3341
hsa-miR-342-5p	AGGGGUGCUAUCUGUGAUUGA	531	TAGCACCCC	1468	AGCACCCC	2405	GCACCCC	3342
hsa-miR-345	GCUGACUCCUAGUCCAGGGCUC	532	AGGAGTCAG	1469	GGAGTCAG	2406	GAGTCAG	3343
hsa-miR-346	UGUCUGCCCGCAUGCCUGCCUCU	533	CGGGCAGAC	1470	GGCAGAC	2407	GGCAGAC	3344
hsa-miR-34a	UGGCAGUGUCUAGCUGGUUGU	534	GACACTGCC	1471	ACACTGCC	2408	CACTGCC	3345
hsa-miR-34a*	CAAUCAGCAAGUAUACUGCCCU	535	TTGCTGATT	1472	TGCTGATT	2409	GCTGATT	3346
hsa-miR-34b	CAAUCACUAACUCCACUGCCAU	536	TTAGTGATT	1473	TAGTGATT	2410	AGTGATT	3347
hsa-miR-34b*	UAGGCAGUGUCAUUAGCUGAUUG	537	ACACTGCCT	1474	CACTGCCT	2411	ACTGCCT	3348
hsa-miR-34c-3p	AAUCACUAACCACACGGCCAGG	538	GTTAGTGAT	1475	TTAGTGAT	2412	TAGTGAT	3349
hsa-miR-34c-5p	AGGCAGUGUAGUUAGCUGAUUGC	539	TACACTGCC	1476	ACACTGCC	2413	CACTGCC	3350
hsa-miR-361-3p	UCCCCAGGUGUAUUCUGAUUU	540	ACCTGGGGG	1477	CCTGGGGG	2414	CTGGGGG	3351
hsa-miR-361-5p	UUAUCAGAAUCCAGGGGUAC	541	ATTCTGATA	1478	TTCTGATA	2415	TCTGATA	3352
hsa-miR-362-3p	AACACACCUAUUCAAGGAUUC	542	TAGGTGTGT	1479	AGGTGTGT	2416	GGTGTGT	3353
hsa-miR-362-5p	AAUCCUUGGAACCUAGGUGAGU	543	TCCAAGGAT	1480	CCAAGGAT	2417	CAAGGAT	3354
hsa-miR-363	AAUUGCACGGUAUCCAUCUGUA	544	CCGTGCAAT	1481	CGTGCAAT	2418	GTGCAAT	3355
hsa-miR-363*	CGGGUGGAUCAGAUCAAUUU	545	GATCCACCC	1482	ATCCACCC	2419	TCCACCC	3356
hsa-miR-365	UAAUGCCCCUAAAAUCCUUU	546	AGGGGCATT	1483	GGGCATT	2420	GGGCATT	3357
hsa-miR-367	AAUUGCACUUUAGCAAUGGUGA	547	AAGTGCAAT	1484	AGTGCAAT	2421	GTGCAAT	3358
hsa-miR-367*	ACUGUUGCUAUAUAGCAACUCU	548	TAGCAACAG	1485	AGCAACAG	2422	GCAACAG	3359
hsa-miR-369-3p	AAUAAUACAUGGUUGAUUUU	549	ATGTATTAT	1486	TGTATTAT	2423	GTATTAT	3360
hsa-miR-369-5p	AGAUCGACCGUUAUUAUUCGC	550	CGGTCGATC	1487	GGTCGATC	2424	GTCGATC	3361
hsa-miR-370	GCCUGCUGGGUGGAACCUUGU	551	CCCAGCAGG	1488	CCAGCAGG	2425	CAGCAGG	3362
hsa-miR-371-3p	AAGUGCCGCCAUUUUUGAGUGU	552	GGCGGCACT	1489	GCGGCACT	2426	CGGCACT	3363
hsa-miR-371-5p	ACUCAAACUGUGGGGGCACU	553	CAGTTTGAG	1490	AGTTTGAG	2427	GTTTGAG	3364
hsa-miR-372	AAAGUGCUGCGACAUUUGAGCGU	554	GCAGCACTT	1491	CAGCACTT	2428	AGCACTT	3365
hsa-miR-373	GAAGUGCUUCGAUUUUGGGUGU	555	GAAGCACTT	1492	AAGCACTT	2429	AGCACTT	3366
hsa-miR-373*	ACUCAAAAUGGGGGCGUUUCC	556	CATTTTGAG	1493	ATTTTGAG	2430	TTTTGAG	3367
hsa-miR-374a	UUUAUAUACAACCUGAUUAGUG	557	TGATTATA	1494	GTATTATA	2431	TATTATA	3368
hsa-miR-374a*	CUUAUCAGAUUGUAUUGUAAU	558	ATCTGATAA	1495	TCTGATAA	2432	CTGATAA	3369
hsa-miR-374b	AUAUAUACAACCUGCUAAGUG	559	TGATTATA	1496	GTATTATA	2433	TATTATA	3370
hsa-miR-374b*	CUUAGCAGGUUGUAUUAUCAU	560	ACCTGCTAA	1497	CCTGCTAA	2434	CTGCTAA	3371
hsa-miR-375	UUUGUUCGUUCGGCUCGCGUGA	561	AACGAACAA	1498	ACGAACAA	2435	CGAACAA	3372
hsa-miR-376a	AUCAUAGAGGAAAUCCACGU	562	CCTCTATGA	1499	CTCTATGA	2436	TCTATGA	3373
hsa-miR-376a*	GUAGAUUCUCCUUCUAUGAGUA	563	GAGAATCTA	1500	AGAATCTA	2437	GAATCTA	3374
hsa-miR-376b	AUCAUAGAGGAAAUCCAUUGU	564	CCTCTATGA	1501	CTCTATGA	2438	TCTATGA	3375
hsa-miR-376c	AACAUAGAGGAAAUCCACGU	565	CCTCTATGT	1502	CTCTATGT	2439	TCTATGT	3376
hsa-miR-377	AUCACAAAAGGCAACUUUGU	566	TTTGTGTGA	1503	TTGTGTGA	2440	TGTGTGA	3377
hsa-miR-377*	AGAGGUUGCCUUGGUGAAUUC	567	GGCAACCTC	1504	GCAACCTC	2441	CAACCTC	3378
hsa-miR-378	ACUGGACUUGGAGUCAGAAGG	568	CAAGTCCAG	1505	AAGTCCAG	2442	AGTCCAG	3379
hsa-miR-378*	CUCCUGACUCCAGGUCCUGUGU	569	GAGTCAGGA	1506	AGTCAGGA	2443	GTCAGGA	3380
hsa-miR-379	UGGUAGACUAUGGAACGUAGG	570	TAGTCTACC	1507	AGTCTACC	2444	GCTCTACC	3381
hsa-miR-379*	UAUGUAACAUGGUCCACUAACU	571	ATGTTACAT	1508	TGTTACAT	2445	GTTACAT	3382
hsa-miR-380	UAUGUAAUUGGUCCACAUCUU	572	ATATTACAT	1509	TATTACAT	2446	ATTACAT	3383
hsa-miR-380*	UGGUUGACCAUAGAACAUGCGC	573	TGGTCAACC	1510	GGTCAACC	2447	GTCACACC	3384
hsa-miR-381	UAUACAAGGGCAAGCUCUCUGU	574	CCCTTGAT	1511	CCTTGAT	2448	CTTGAT	3385
hsa-miR-382	GAAGUUGUUCGUGGUGGAUUCG	575	GAACAACCTT	1512	AACAACCTT	2449	ACAACCTT	3386
hsa-miR-383	AGAUCAGAAGGUGAUUGGGCU	576	CTTCTGATC	1513	TTCTGATC	2450	TCTGATC	3387
hsa-miR-384	AUCCUAGAAAUUGUUAUA	577	TTCTAGGAA	1514	TCTAGGAA	2451	CTAGGAA	3388
hsa-miR-409-3p	GAAUGUUGCUCGGUGAACCCCU	578	AGCAACATT	1515	GCAACATT	2452	CAACATT	3389
hsa-miR-409-5p	AGGUUACCCGAGCAACUUUGCAU	579	CGGGTAACC	1516	GGGTAACC	2453	GGTAACC	3390
hsa-miR-410	AAUAUAACACAGAUGGCCUGU	580	GTGTTATAT	1517	TGTATAT	2454	GTTATAT	3391
hsa-miR-411	UAGUAGACCGUAGCGUACG	581	CGGTCTACT	1518	GGTCTACT	2455	GCTCTACT	3392
hsa-miR-411*	UAUGUAACACGGUCCACUAACC	582	GTGTTACAT	1519	TGTTACAT	2456	GTTACAT	3393
hsa-miR-412	ACUUCACCGUCCACUAGCCGU	583	CAGGTGAAG	1520	AGGTGAAG	2457	GGTGAAG	3394

hsa-miR-421	AUCAACAGACAUUAAUUGGGCGC	584	GTCTGTTGA	1521	TCTGTTGA	2458	CTGTTGA	3395
hsa-miR-422a	ACUGGACUUGGGUCAGAAGGC	585	TAAGTCCAG	1522	AAGTCCAG	2459	AGTCCAG	3396
hsa-miR-423-3p	AGCUCGGUCUGAGGCCCCUCAGU	586	AGACCGAGC	1523	GACCGAGC	2460	ACCGAGC	3397
hsa-miR-423-5p	UGAGGGGCGAGAGCGGAGACUUU	587	CTGCCCTC	1524	TGCCCTC	2461	GCCCTC	3398
hsa-miR-424	CAGCAGCAAUUC AUGUUUGAA	588	ATTGCTGCT	1525	TTGCTGCT	2462	TGCTGCT	3399
hsa-miR-424*	CAAACGUGAGGCGUGCUAU	589	TCAGTTTT	1526	CACGTTTT	2463	ACGTTTT	3400
hsa-miR-425	AAUGACACGAUCACUCCCGUUGA	590	TCGTGTCAT	1527	CGTGTGTCAT	2464	GTGTGTCAT	3401
hsa-miR-425*	AUCGGGAAUGUCGUGUCCGCC	591	CATTCCCGA	1528	ATTCCCGA	2465	TTCCCGA	3402
hsa-miR-429	UAAUACUGUCUGGUAACCGU	592	GACAGTATT	1529	ACAGTATT	2466	CAGTATT	3403
hsa-miR-431	UGUCUUGCAGGCCGUC AUGCA	593	CTGCAAGAC	1530	TGCAAGAC	2467	GCAAGAC	3404
hsa-miR-431*	CAGGUCGUCUUGCAGGGCUUCU	594	AGACGACCT	1531	GACGACCT	2468	ACGACCT	3405
hsa-miR-432	UCUUGGAGUAGGUCAUUGGGUGG	595	TACTCCAAG	1532	ACTCCAAG	2469	CTCCAAG	3406
hsa-miR-432*	CUGGAUGGCUCUCCAUGUCU	596	AGCCATCCA	1533	GCCATCCA	2470	CCATCCA	3407
hsa-miR-433	AUCAUGAUGGGCUCUCGGUGU	597	CCATCATGA	1534	CATCATGA	2471	ATCATGA	3408
hsa-miR-448	UUGCAUAGUAGGAUGUCCCAU	598	ACATATGCA	1535	CATATGCA	2472	ATATGCA	3409
hsa-miR-449a	UGGCAGUGUAUUGUUAGCUGGU	599	TACTACTGCC	1536	ACTACTGCC	2473	CACTGCC	3410
hsa-miR-449b	AGGCAGUGUAUUGUUAGCUGGC	600	TACTACTGCC	1537	ACTACTGCC	2474	CACTGCC	3411
hsa-miR-450a	UUUUGCGAUGUGUCCUAAUUAU	601	CATCGCAA	1538	ATCGCAA	2475	TCGCAA	3412
hsa-miR-450b-3p	UUGGGAUCAUUUGCAUCCAUA	602	ATGATCCCA	1539	TGATCCCA	2476	GATCCCA	3413
hsa-miR-450b-5p	UUUUGCAAUAUGUCCUGAAUA	603	TATTGCAA	1540	ATTGCAA	2477	TTGCAA	3414
hsa-miR-451	AAACCGUUACCAUUCUGAGUU	604	GTAACGGTT	1541	TAACGGTT	2478	AACGGTT	3415
hsa-miR-452	AACUGUUUGCAGAGGAACUGA	605	GCAAACAGT	1542	CAAACAGT	2479	AAACAGT	3416
hsa-miR-452*	CUCAUCUGCAAAGAAGUAAGUG	606	TGCAGATGA	1543	GCAGATGA	2480	CAGATGA	3417
hsa-miR-453	AGGUUGUCCGUGGUGAGUUCGCA	607	CGGACAACC	1544	GGACAACC	2481	GACAACC	3418
hsa-miR-454	UAGUGCAAUAUUGCUUAUAGGGU	608	TATTGCACT	1545	ATTGCACT	2482	TTGCACT	3419
hsa-miR-454*	ACCCUAUCAUAUUGUCUCUGC	609	TTGATAGGG	1546	TGATAGGG	2483	GATAGGG	3420
hsa-miR-455-3p	GCAGUCCAUGGGCAUAUACAC	610	CATGGACTG	1547	ATGGACTG	2484	TGGACTG	3421
hsa-miR-455-5p	UAUGUGCCUUGGACUACAUCG	611	AAGGCACAT	1548	AGGCACAT	2485	GGCACAT	3422
hsa-miR-483-3p	UCACUCCUCUCCUCCCGUCU	612	AGAGGAGTG	1549	GAGGAGTG	2486	AGGAGTG	3423
hsa-miR-483-5p	AAGACGGGAGGAAGAAGGGAG	613	CTCCGTCT	1550	TCCGTCT	2487	CCGTCT	3424
hsa-miR-484	UCAGGCUCAGUCCUCCCGAU	614	CTGAGCCTG	1551	TGAGCCTG	2488	GAGCCTG	3425
hsa-miR-485-3p	GUCAUACACGGUCUCCUCUCU	615	CGTGTATGA	1552	GTGTATGA	2489	TGTATGA	3426
hsa-miR-485-5p	AGAGGCGGCCGUGAUGAAUUC	616	GCCAGCCTC	1553	CCAGCCTC	2490	CAGCCTC	3427
hsa-miR-486-3p	CGGGGCGAGCUCAGUACAGGAU	617	AGCTGCCCC	1554	GCTGCCCC	2491	CTGCCCC	3428
hsa-miR-486-5p	UCCUGUACUGAGCUGCCCGAG	618	CAGTACAGG	1555	AGTACAGG	2492	GTACAGG	3429
hsa-miR-487a	AAUCAUACAGGGACAUCAGUU	619	CTGTATGAT	1556	TGTATGAT	2493	GTATGAT	3430
hsa-miR-487b	AAUCGUACAGGGUCAUCCACUU	620	CTGTACGAT	1557	TGTACGAT	2494	GTACGAT	3431
hsa-miR-488	UUGAAAGGCUAUUUCUUGGUC	621	AGCCTTTCA	1558	GCCTTTCA	2495	CCTTTCA	3432
hsa-miR-488*	CCCAGAUAAUGGCACUCUCAA	622	ATTATCTGG	1559	TTATCTGG	2496	TATCTGG	3433
hsa-miR-489	GUGACAUCACAUUACGGCAGC	623	GTGATGTCA	1560	TGATGTCA	2497	GATGTCA	3434
hsa-miR-490-3p	CAACCGGAGGACUCCAUGCUG	624	CTCAGGTT	1561	TCCAGGTT	2498	CCAGGTT	3435
hsa-miR-490-5p	CCAUGGAUCUCCAGGUGGGU	625	AGATCCATG	1562	GATCCATG	2499	ATCCATG	3436
hsa-miR-491-3p	CUUAUGCAAGAUCCUUCUAC	626	CTTGATAA	1563	TTGATAA	2500	TGATAA	3437
hsa-miR-491-5p	AGUGGGGAACCUUCCAUGAGG	627	GTCCCCAC	1564	TTCCCCAC	2501	TCCCCAC	3438
hsa-miR-492	AGGACUGCGGGACAAGAUUCUU	628	CGCAGGTCC	1565	GCAGGTCC	2502	CAGGTCC	3439
hsa-miR-493	UGAAGGUCUACUGUGGCCAGG	629	TAGACCTTC	1566	AGACCTTC	2503	GACCTTC	3440
hsa-miR-493*	UUGUACAUGGUAGGCUUUCUU	630	CCATGTACA	1567	CATGTACA	2504	ATGTACA	3441
hsa-miR-494	UGAAACAUAACCGGAAACCUC	631	GTATGTTTC	1568	TATGTTTC	2505	ATGTTTC	3442
hsa-miR-495	AAACAACAUGGGCACUUCUU	632	ATGTTTGTT	1569	TGTTTGTT	2506	GTTTGTT	3443
hsa-miR-496	UGAGUAUUACAUGGCCAAUCUC	633	GTAATACTC	1570	TAATACTC	2507	AATACTC	3444
hsa-miR-497	CAGCAGCACACUGUGGUUGU	634	TGTGCTGCT	1571	GTGCTGCT	2508	TGCTGCT	3445
hsa-miR-497*	CAAACCACACUGUGGUUAGA	635	GTGGGTTT	1572	TGGGTTT	2509	GTGGTTT	3446
hsa-miR-498	UUUCAAGCCAGGGGCGUUUUC	636	TGGCTTGAA	1573	GGCTTGAA	2510	GCTTGAA	3447
hsa-miR-499-3p	AACAUCACAGCAAGUCUGUGCU	637	CTGTGATGT	1574	TGTGATGT	2511	GTGATGT	3448
hsa-miR-499-5p	UUAAGACUUGCAGUGAUGUUU	638	CAAGTCTTA	1575	AAGTCTTA	2512	AGTCTTA	3449

hsa-miR-500	UAAUCCUUGCUACCCUGGGUGAGA	639	GCAAGGATT	1576	CAAGGATT	2513	AAGGATT	3450
hsa-miR-500*	AUGCACCUGGCAAGGAUUCUG	640	CCAGGTGCA	1577	CAGGTGCA	2514	AGGTGCA	3451
hsa-miR-501-3p	AAUGCACCCGGCAAGGAUUCU	641	CGGGTGCAT	1578	GGGTGCAT	2515	GGTGCAT	3452
hsa-miR-501-5p	AAUCCUUUGUCCUGGGUGAGA	642	ACAAAGGAT	1579	CAAAGGAT	2516	AAAGGAT	3453
hsa-miR-502-3p	AAUGCACCUGGCAAGGAUUCA	643	CAGGTGCAT	1580	AGGTGCAT	2517	GGTGCAT	3454
hsa-miR-502-5p	AUCCUUGCUAUCUGGGUGCUA	644	TAGCAAGGA	1581	AGCAAGGA	2518	GCAAGGA	3455
hsa-miR-503	UAGCAGCGGGAACAGUUCUGCAG	645	CCCCTGCT	1582	CCCTGCT	2519	CGCTGCT	3456
hsa-miR-504	AGACCCUGGUCUGCACUCUAUC	646	ACCAGGGTC	1583	CCAGGGTC	2520	CAGGGTC	3457
hsa-miR-505	CGUCAACACUUGCUGGUUCCU	647	AGTGTGAC	1584	GTGTGAC	2521	TGTGAC	3458
hsa-miR-505*	GGGAGCCAGGAAGUAUUGAUGU	648	CCTGGCTCC	1585	CTGGCTCC	2522	TGGCTCC	3459
hsa-miR-506	UAAGGCACCCUUCUGAGUAGA	649	GGTGCCTT	1586	GGTGCCTT	2523	GTGCCTT	3460
hsa-miR-507	UUUUGCACCUUUUGGAGUGAA	650	AGGTGCAA	1587	GGTGCAA	2524	GTGCAA	3461
hsa-miR-508-3p	UGAUUGUAGCCUUUUGGAGUAGA	651	GCTACAATC	1588	CTACAATC	2525	TACAATC	3462
hsa-miR-508-5p	UACUCCAGAGGGCUCACUCAUG	652	CTCTGGAGT	1589	TCTGGAGT	2526	CTGGAGT	3463
hsa-miR-509-3-5p	UACUGCAGACGUGGCAAUCAUG	653	GTCTGCAGT	1590	TCTGCAGT	2527	CTGCAGT	3464
hsa-miR-509-3p	UGAUUGGUACGUCUGGGUAG	654	GTACCAATC	1591	TACCAATC	2528	ACCAATC	3465
hsa-miR-509-5p	UACUGCAGACAGUGGCAAUCA	655	GTCTGCAGT	1592	TCTGCAGT	2529	CTGCAGT	3466
hsa-miR-510	UACUCAGGAGAGUGGCAAUCAC	656	CTCCTGAGT	1593	TCCTGAGT	2530	CCTGAGT	3467
hsa-miR-511	GUGUCUUUUGCUCUGCAGUCA	657	CAAAGACA	1594	AAAAGACA	2531	AAAGACA	3468
hsa-miR-512-3p	AAGUCUGUCAUAGCUGAGGUC	658	GACGACT	1595	ACGACT	2532	CAGACT	3469
hsa-miR-512-5p	CACUCAGCCUUGAGGGCACUUUC	659	AGGCTGAGT	1596	GGCTGAGT	2533	GCTGAGT	3470
hsa-miR-513a-3p	UAAAUUUCACCUUUCUGAGAAGG	660	GTGAAATTT	1597	TGAAATTT	2534	GAAATTT	3471
hsa-miR-513a-5p	UUCACAGGGAGGUGUCAU	661	TCCCTGTGA	1598	CCCTGTGA	2535	CCTGTGA	3472
hsa-miR-513b	UUCACAAGGAGGUGUCAUUUAU	662	TCCTTGTGA	1599	CCTTGTGA	2536	CTTGTGA	3473
hsa-miR-513c	UUCUCAAGGAGGUGUCUUUAU	663	TCCTTGAGA	1600	CCTTGAGA	2537	CTTGAGA	3474
hsa-miR-514	AUUGACACUUCUGUGAGUAGA	664	AAGTGTCAA	1601	AGTGTCAA	2538	GTGTCAA	3475
hsa-miR-515-3p	GAGUGCCUUCUUUGGAGCGUU	665	GAAGGCACT	1602	AAGGCACT	2539	AGGCACT	3476
hsa-miR-515-5p	UUCUCCAAAAGAAAGCACUUUCUG	666	TTTGGAGA	1603	TTTGGAGA	2540	TTGGAGA	3477
hsa-miR-516a-3p	UGCUUCCUUUCAGAGGGU	667	AAAGGAAGC	1604	AAGGAAGC	2541	AGGAAGC	3478
hsa-miR-516a-5p	UUCUCGAGGAAAGAAGCACUUUC	668	TCCTCGAGA	1605	CCTCGAGA	2542	CTCGAGA	3479
hsa-miR-516b	AUCUGGAGGUAAGAAGCACUUU	669	ACCTCCAGA	1606	CCTCCAGA	2543	CTCCAGA	3480
hsa-miR-517*	CCUCUAGAUGGAAGCACUGUCU	670	CATCTAGAG	1607	ATCTAGAG	2544	TCTAGAG	3481
hsa-miR-517a	AUCGUGCAUCCUUUAGAGUGU	671	GATGCACGA	1608	ATGCACGA	2545	TGCACGA	3482
hsa-miR-517b	UCGUGCAUCCUUUAGAGUGUU	672	GGATGCACG	1609	GATGCACG	2546	ATGCACG	3483
hsa-miR-517c	AUCGUGCAUCCUUUAGAGUGU	673	GATGCACGA	1610	ATGCACGA	2547	TGCACGA	3484
hsa-miR-518a-3p	GAAAGCGCUUCCUUUGCUGGA	674	AAGCGCTTT	1611	AGCGCTTT	2548	GCGCTTT	3485
hsa-miR-518b	CAAAGCGCUCCUUUAGAGGU	675	GAGCGCTTT	1612	AGCGCTTT	2549	GCGCTTT	3486
hsa-miR-518c	CAAAGCGCUUCUUUAGAGUGU	676	AAGCGCTTT	1613	AGCGCTTT	2550	GCGCTTT	3487
hsa-miR-518c*	UCUCUGGAGGGAAGCACUUUCUG	677	CCTCCAGAG	1614	CTCCAGAG	2551	TCCAGAG	3488
hsa-miR-518d-3p	CAAAGCGCUUCCUUUGGAGC	678	AAGCGCTTT	1615	AGCGCTTT	2552	GCGCTTT	3489
hsa-miR-518d-5p	CUCUAGAGGGAAGCACUUUCUG	679	CCCTCTAGA	1616	CCTCTAGA	2553	CTCTAGA	3490
hsa-miR-518e	AAAGCGCUUCCUUUCAGAGUG	680	GAAGCGCTT	1617	AAGCGCTT	2554	AGCGCTT	3491
hsa-miR-518f	GAAAGCGCUUCUUUAGAGG	681	AAGCGCTTT	1618	AGCGCTTT	2555	GCGCTTT	3492
hsa-miR-518f*	CUCUAGAGGGAAGCACUUUCUC	682	CCCTCTAGA	1619	CCTCTAGA	2556	CTCTAGA	3493
hsa-miR-519a	AAAGUGCAUCCUUUAGAGUGU	683	GATGCACTT	1620	ATGCACTT	2557	TGCACTT	3494
hsa-miR-519a*	CUCUAGAGGGAAGCGCUUUCUG	684	CCCTCTAGA	1621	CCTCTAGA	2558	CTCTAGA	3495
hsa-miR-519b-3p	AAAGUGCAUCCUUUAGAGGUU	685	GATGCACTT	1622	ATGCACTT	2559	TGCACTT	3496
hsa-miR-519c-3p	AAAGUGCAUCCUUUAGAGGAU	686	GATGCACTT	1623	ATGCACTT	2560	TGCACTT	3497
hsa-miR-519d	CAAAGUGCCUCCUUUAGAGUG	687	AGGCACTTT	1624	GGCACTTT	2561	GCACTTT	3498
hsa-miR-519e	AAGUGCCUCCUUUAGAGUGUU	688	GGAGGCACT	1625	GAGGCACT	2562	AGGCACT	3499
hsa-miR-519e*	UUCUCCAAAAGGGAGCACUUUC	689	TTTGGAGA	1626	TTTGGAGA	2563	TTGGAGA	3500
hsa-miR-520a-3p	AAAGUGCUUCCUUUGGACUGU	690	GAAGCACTT	1627	AAGCACTT	2564	AGCACTT	3501
hsa-miR-520a-5p	CUCCAGAGGGAAGUACUUUCU	691	CCCTCTGGA	1628	CCTCTGGA	2565	CTCTGGA	3502
hsa-miR-520b	AAAGUGCUUCCUUUAGAGGG	692	GAAGCACTT	1629	AAGCACTT	2566	AGCACTT	3503
hsa-miR-520c-3p	AAAGUGCUUCCUUUAGAGGGU	693	GAAGCACTT	1630	AAGCACTT	2567	AGCACTT	3504

hsa-miR-520d-3p	AAAGUGCUUCUCUUUGGUGGGU	694	GAAGCACTT	1631	AAGCACTT	2568	AGCACTT	3505
hsa-miR-520d-5p	CUACAAAGGGAAGCCCUUUC	695	CCTTTGTGA	1632	CCTTTGTGA	2569	CTTTGTGA	3506
hsa-miR-520e	AAAGUGCUUCUUUUUAGAGGG	696	GAAGCACTT	1633	AAGCACTT	2570	AGCACTT	3507
hsa-miR-520f	AAGUGCUUCUUUUUAGAGGGU	697	GGAAGCACT	1634	GAAGCACT	2571	AAGCACT	3508
hsa-miR-520g	ACAAAGUGCUUCCUUUAGAGUGU	698	AGCACTTTG	1635	GCACTTTG	2572	CACTTTG	3509
hsa-miR-520h	ACAAAGUGCUUCCUUUAGAGU	699	AGCACTTTG	1636	GCACTTTG	2573	CACTTTG	3510
hsa-miR-521	AACGCACUCCUUUAGAGUGU	700	GAAGTGCGT	1637	AAGTGCGT	2574	AGTGCGT	3511
hsa-miR-522	AAAAUGGUUCCUUUAGAGUGU	701	GAACCATTT	1638	AACCATTT	2575	ACCATTT	3512
hsa-miR-523	GAACGCGCUCCCUUAGAGGGU	702	AAGCGCGTT	1639	AGCGCGTT	2576	GCGCGTT	3513
hsa-miR-524-3p	GAAGGCGCUCCUUUGGAGU	703	AAGCGCCTT	1640	AGCGCCTT	2577	GCGCCTT	3514
hsa-miR-524-5p	CUACAAAGGGAAGCACUUUCUC	704	CCTTTGTGA	1641	CCTTTGTGA	2578	CTTTGTGA	3515
hsa-miR-525-3p	GAAGGCGCUCCUUUAGAGCG	705	AAGCGCCTT	1642	AGCGCCTT	2579	GCGCCTT	3516
hsa-miR-525-5p	CUCCAGAGGGAUGCACUUUCU	706	CCCTCTGGA	1643	CCTCTGGA	2580	CTCTGGA	3517
hsa-miR-526b	CUCUUGAGGGAAGCACUUUCUGU	707	CCCTCAAGA	1644	CCTCAAGA	2581	CTCAAGA	3518
hsa-miR-526b*	GAAAGUGCUUCUUUUUAGAGGC	708	AAGCACTTT	1645	AGCACTTT	2582	GCACCTTT	3519
hsa-miR-527	CUGCAAAGGGAAGCCCUUUC	709	CCTTTGTGA	1646	CCTTTGTGA	2583	CTTTGTGA	3520
hsa-miR-532-3p	CCUCCACACCCAAGGCUUGCA	710	GTGTGGGAG	1647	TGTGGGAG	2584	GTGGGAG	3521
hsa-miR-532-5p	CAUGCCUUGAGUGUAGGACCGU	711	TCAAGGCAT	1648	CAAGGCAT	2585	AAGGCAT	3522
hsa-miR-539	GGAGAAAUAUCCUUGGUGUGU	712	TAATTTCTC	1649	AATTTCTC	2586	ATTTCTC	3523
hsa-miR-541	UGGUGGGCACAGAAUCUGGACU	713	GTGCCACC	1650	TGCCACC	2587	GCCACC	3524
hsa-miR-541*	AAAGGAUUCUGCUGUCGGUCCACU	714	AGAATCCTT	1651	GAATCCTT	2588	AATCCTT	3525
hsa-miR-542-3p	UGUGACAGAUUGAUACUGAAA	715	ATCTGTAC	1652	TCTGTAC	2589	CTGTAC	3526
hsa-miR-542-5p	UCGGGAUCAUCAUGUCACGAGA	716	TGATCCCG	1653	GATCCCG	2590	ATCCCG	3527
hsa-miR-543	AAACAUCGCGGUGCACUUCUU	717	GCGAATGTT	1654	CGAATGTT	2591	GAATGTT	3528
hsa-miR-544	AUUCUGCAUUUUUAGCAAGUUC	718	AATGCAGAA	1655	ATGCAGAA	2592	TGCAGAA	3529
hsa-miR-545	UCAGCAAACAUAUUUUGUGUGC	719	TGTTTGCTG	1656	GTTTGCTG	2593	TTTGCTG	3530
hsa-miR-545*	UCAGUAAAUGUUUAUUGAUGA	720	CATTTACTG	1657	ATTTACTG	2594	TTTACTG	3531
hsa-miR-548a-3p	CAAAACUGGCAAUUACUUUUGC	721	GCCAGTTTT	1658	CCAGTTTT	2595	CAGTTTT	3532
hsa-miR-548a-5p	AAAAGUAAUUGCGAGUUUACC	722	AATTACTTT	1659	ATTACTTT	2596	TTACTTT	3533
hsa-miR-548b-3p	CAAGAACCUCAGUUGCUUUUGU	723	GAGGTTCTT	1660	AGTTCTT	2597	GGTTCTT	3534
hsa-miR-548b-5p	AAAAGUAAUUGUGGUUUUGGCC	724	AATTACTTT	1661	ATTACTTT	2598	TTACTTT	3535
hsa-miR-548c-3p	CAAAAUCUCAUUUACUUUUGC	725	GAGATTTTT	1662	AGATTTTT	2599	GATTTTT	3536
hsa-miR-548c-5p	AAAAGUAAUUGCGGUUUUGGCC	726	AATTACTTT	1663	ATTACTTT	2600	TTACTTT	3537
hsa-miR-548d-3p	CAAAAACCACAGUUUCUUUUGC	727	GTGGTTTTT	1664	TGGTTTTT	2601	GGTTTTT	3538
hsa-miR-548d-5p	AAAAGUAAUUGUGGUUUUGGCC	728	AATTACTTT	1665	ATTACTTT	2602	TTACTTT	3539
hsa-miR-548e	AAAAACUGAGACUACUUUUGCA	729	CTCAGTTTT	1666	TCAGTTTT	2603	CAGTTTT	3540
hsa-miR-548f	AAAAACUGUAAUUACUUUU	730	TACAGTTTT	1667	ACAGTTTT	2604	CAGTTTT	3541
hsa-miR-548g	AAAACUGUAAUUACUUUUGUAC	731	TTACAGTTT	1668	TACAGTTT	2605	ACAGTTT	3542
hsa-miR-548h	AAAAGUAAUUGCGGUUUUUGUC	732	GATTACTTT	1669	ATTACTTT	2606	TTACTTT	3543
hsa-miR-548i	AAAAGUAAUUGCGGAUUUUGCC	733	AATTACTTT	1670	ATTACTTT	2607	TTACTTT	3544
hsa-miR-548j	AAAAGUAAUUGCGGCUUUUGGU	734	AATTACTTT	1671	ATTACTTT	2608	TTACTTT	3545
hsa-miR-548k	AAAAGUACUUGCGGAUUUUGCU	735	AAGTACTTT	1672	AGTACTTT	2609	GACTTTT	3546
hsa-miR-548l	AAAAGUAAUUGCGGGUUUUGUC	736	AAACTACTT	1673	AATACTTT	2610	ATACTTT	3547
hsa-miR-548m	CAAAGUAAUUGUGGUUUUUG	737	AATACCTTT	1674	ATACCTTT	2611	TACCTTT	3548
hsa-miR-548n	CAAAGUAAUUGUGGAUUUUGU	738	ATTACTTTT	1675	TTACTTTT	2612	TACTTTT	3549
hsa-miR-548o	CCAAAACUGCAGUACUUUUGC	739	GCAGTTTTG	1676	CAGTTTTG	2613	AGTTTTG	3550
hsa-miR-548p	UAGCAAAAACUGCAGUUACUUU	740	GTTTTTGCT	1677	TTTTTGCT	2614	TTTTGCT	3551
hsa-miR-549	UGACAACUAUGGAUGAGCUCU	741	ATAGTTGTC	1678	TAGTTGTC	2615	AGTTGTC	3552
hsa-miR-550	AGUGCCUGAGGGAGUAAGAGCCC	742	CTCAGGCAC	1679	TCAGGCAC	2616	CAGGCAC	3553
hsa-miR-550*	UGUCUUACUCCUCAGGCACAU	743	GAGTAAGAC	1680	AGTAAGAC	2617	GTAAGAC	3554
hsa-miR-551a	GCGACCACUCUUGGUUUCCA	744	AGTGGGTCG	1681	GTGGGTCG	2618	TGGGTCG	3555
hsa-miR-551b	GCGACCCAUAUCUUGGUUUACAG	745	TATGGGTCG	1682	ATGGGTCG	2619	TGGGTCG	3556
hsa-miR-551b*	GAAAUCAAGCUGGGUGAGACC	746	GCTTGATTT	1683	CTTGATTT	2620	TTGATTT	3557
hsa-miR-552	AACAGGUGACUGGUUAGACAA	747	GTCACCTGT	1684	TCACCTGT	2621	CACCTGT	3558
hsa-miR-553	AAAACGGUGAGAUUUUGUUUU	748	TCACCGTTT	1685	CACCGTTT	2622	ACCGTTT	3559

hsa-miR-554	GCUAGUCCUGACUCAGCCAGU	749	CAGGACTAG	1686	AGGACTAG	2623	GGACTAG	3560
hsa-miR-555	AGGGUAAAGCUAACCUCUGAU	750	AGCTTACCC	1687	GCTTACCC	2624	CTTACCC	3561
hsa-miR-556-3p	AUAUUACCAUAGCUCAUCUUU	751	ATGGTAATA	1688	TGGAATA	2625	GGTAATA	3562
hsa-miR-556-5p	GAUGAGCUCAUUGUAAUAUGAG	752	TGAGCTCAT	1689	GAGCTCAT	2626	AGCTCAT	3563
hsa-miR-557	GUUUGCACGGGUGGGCCUUGUCU	753	CCGTGCAAA	1690	CGTGCAAA	2627	GTGCAAA	3564
hsa-miR-558	UGAGCUGCUGUACCAAAU	754	CAGCAGCTC	1691	AGCAGCTC	2628	GCAGCTC	3565
hsa-miR-559	UAAAGUAAAUAUGCACCAAAA	755	ATTTACTTT	1692	TTTACTTT	2629	TTACTTT	3566
hsa-miR-561	CAAAGUUUAAGAUCUUGAAGU	756	TTAACTTT	1693	TAACTTT	2630	AACTTT	3567
hsa-miR-562	AAAGUAGCUGUACCAUUUGC	757	CAGCTACTT	1694	AGCTACTT	2631	GCTACTT	3568
hsa-miR-563	AGGUUGACAUCGUUUUCCC	758	ATGTCAACC	1695	TGTCAACC	2632	GTCAACC	3569
hsa-miR-564	AGGCACGGUGUCAGCAGGC	759	CACCGTGCC	1696	ACCGTGCC	2633	CCGTGCC	3570
hsa-miR-566	GGGCCCUGUGAUCCCAAC	760	ACAGGCGCC	1697	CAGGCGCC	2634	AGGCGCC	3571
hsa-miR-567	AGUAUGUUCUCCAGGACAGAAC	761	AGAACATAC	1698	GAACATAC	2635	AACATAC	3572
hsa-miR-568	AUGUAUAAAUGUAUACACAC	762	ATTTATACA	1699	TTTATACA	2636	TTATACA	3573
hsa-miR-569	AGUUAUGAAUCCUGGAAAGU	763	TCATTAAC	1700	TCATTAAC	2637	CATTAAC	3574
hsa-miR-570	CGAAAACAGCAAUACCUUUGC	764	GCTGTTTTC	1701	CTGTTTTC	2638	TGTTTTC	3575
hsa-miR-571	UGAGUUGGCCAUCUGAGUGAG	765	GGCCAATC	1702	GCCAATC	2639	CCAATC	3576
hsa-miR-572	GUCCGCUCGGCGGUGGCCCA	766	CCGAGCGGA	1703	CGAGCGGA	2640	GAGCGGA	3577
hsa-miR-573	CUGAAGUGAUGUGUACUGAUCAG	767	ATCACTTCA	1704	TCACTTCA	2641	CACTTCA	3578
hsa-miR-574-3p	CACGCUCAUGCACACCCACA	768	CATGAGCGT	1705	ATGAGCGT	2642	TGAGCGT	3579
hsa-miR-574-5p	UGAGUGUGUGUGUGAGUGUGU	769	CACACTC	1706	ACACTC	2643	CACACTC	3580
hsa-miR-575	GAGCCAGUUGGACAGGAGC	770	CAACTGGCT	1707	AACTGGCT	2644	ACTGGCT	3581
hsa-miR-576-3p	AAGAUGUGGAAAAUUGGAAUC	771	TCCACATCT	1708	CCACATCT	2645	CACATCT	3582
hsa-miR-576-5p	AUUCUAAUUCUCCACGUCUUU	772	AAATTAGAA	1709	AATTAGAA	2646	ATTAGAA	3583
hsa-miR-577	UAGUAUAAAUAUUGGUACCUG	773	ATTTATCT	1710	TTTATCT	2647	TTTATCT	3584
hsa-miR-578	CUUCUUGUCUCUAGGAUUGU	774	GCACAAGAA	1711	CACAAGAA	2648	ACAAGAA	3585
hsa-miR-579	UUCAUUGGUUAUAAACCGCAUU	775	ACCAATGA	1712	CCAATGA	2649	CAATGA	3586
hsa-miR-580	UUGAGAAUGAUGAAUCAUAGG	776	TCATTCTCA	1713	CATTCTCA	2650	ATTCTCA	3587
hsa-miR-581	UCUUGUGUUCUCUAGAUAGU	777	GAACACAAG	1714	AACACAAG	2651	ACACAAG	3588
hsa-miR-582-3p	UAACUGGUUGAACAACUGAACC	778	CAACCAGTT	1715	AACCAGTT	2652	ACCAGTT	3589
hsa-miR-582-5p	UUACAGUUGUUAACAGUUACU	779	ACAACGTGA	1716	CAACTGTA	2653	AACGTGA	3590
hsa-miR-583	CAAAGAGGAAGGUCCAUUAC	780	TCCTCTTT	1717	TCCTCTTT	2654	CCTCTTT	3591
hsa-miR-584	UUAUGGUUUGCCUGGACUGAG	781	CAAACATA	1718	AAACATA	2655	AACATA	3592
hsa-miR-585	UGGGCGUAUCUGUAUGCUA	782	GATACGCC	1719	ATACGCC	2656	TACGCC	3593
hsa-miR-586	UAUGCAUUGUAUUUUAGGUCC	783	ACAATGCAT	1720	CAATGCAT	2657	AATGCAT	3594
hsa-miR-587	UUUCCAUAGGUGAUGAGUCAC	784	CCTATGGAA	1721	CTATGGAA	2658	TATGGAA	3595
hsa-miR-588	UUGGCCACAAUGGGUAGAAC	785	TTGTGGCCA	1722	TGTGGCCA	2659	GTGGCCA	3596
hsa-miR-589	UGAGAACCACGUCGUCUGAG	786	GTGGTTCTC	1723	TGGTTCTC	2660	GGTTCTC	3597
hsa-miR-589*	UCAGAACAAGUCCGGUCCAGA	787	TTGTTCTG	1724	TTGTTCTG	2661	TGTTCTG	3598
hsa-miR-590-3p	UAAUUUAUGUAUAAGCUAGU	788	CATAAAATT	1725	ATAAAATT	2662	TAAAATT	3599
hsa-miR-590-5p	GAGCUUAUUCUAAAAGUCAG	789	GAATAAGCT	1726	AATAAGCT	2663	ATAAGCT	3600
hsa-miR-591	AGACCAUGGGUUCUCAUGU	790	CCCATGGTC	1727	CCATGGTC	2664	CATGGTC	3601
hsa-miR-592	UUGUGUCAUAUGCGAUGAUGU	791	ATGACACA	1728	TTGACACA	2665	TGACACA	3602
hsa-miR-593	UGUCUCUGCUGGGUUUCU	792	AGCAGAGAC	1729	GCAGAGAC	2666	CAGAGAC	3603
hsa-miR-593*	AGGCACCAGCCAGGCAUUGCUCAGC	793	GCTGGTGCC	1730	CTGGTGCC	2667	TGGTGCC	3604
hsa-miR-595	GAAGUGGCCGUGGUGUCU	794	GGCACACTT	1731	GCACACTT	2668	CACACTT	3605
hsa-miR-596	AAGCCUGCCCAGCUCUCCGGG	795	GGCAGGCT	1732	GGCAGGCT	2669	GCAGGCT	3606
hsa-miR-597	UGUGUCACUCGAUGACCACUGU	796	GAGTGACAC	1733	AGTGACAC	2670	GTGACAC	3607
hsa-miR-598	UACGUCAUCGUUGUCAUCGUCA	797	CGATGACGT	1734	GATGACGT	2671	ATGACGT	3608
hsa-miR-599	GUUGUGUCAGUUUAUCAAAC	798	CTGACACAA	1735	TGACACAA	2672	GACACAA	3609
hsa-miR-600	ACUUCACAGACAAGAGCCUUGCUC	799	GTCTGTAAG	1736	TCTGTAAG	2673	CTGTAAG	3610
hsa-miR-601	UGGUCUAGGAUUGUUGGAGGAG	800	TCCTAGACC	1737	CCTAGACC	2674	CTAGACC	3611
hsa-miR-602	GACACGGGCGACAGCUGCGGCC	801	CGCCCGTGT	1738	GCCCGTGT	2675	CCCGTGT	3612
hsa-miR-603	CACACACUGCAAUACUUUUGC	802	GCAGTGTGT	1739	CAGTGTGT	2676	AGTGTGT	3613
hsa-miR-604	AGGCUGCGAAUUCAGGAC	803	TCCGAGCC	1740	CCGAGCC	2677	CGAGCC	3614

hsa-miR-605	UAAAUCCCAUGGUGCCUUCUCCU	804	ATGGGATT	1741	TGGGATT	2678	GGGATT	3615
hsa-miR-606	AAACUACUGAAAUAAGAU	805	TCAGTAGT	1742	CAGTAGT	2679	AGTAGT	3616
hsa-miR-607	GUUCAAAUCCAGAUUAUAAC	806	GGATTGAA	1743	GATTGAA	2680	ATTGAA	3617
hsa-miR-608	AGGGUGGUGUUGGACAGCUCCGU	807	CACCACCC	1744	ACCACCC	2681	CCACCC	3618
hsa-miR-609	AGGGUGUUUCUCUCAUCUCU	808	GAAACACCC	1745	AAACACCC	2682	AACACCC	3619
hsa-miR-610	UGAGCUAAAUGUGUGCUGGGA	809	ATTTAGCTC	1746	TTTAGCTC	2683	TTAGCTC	3620
hsa-miR-611	GCGAGGACCCUCGGGUCUGAC	810	GGTCTCG	1747	GGTCTCG	2684	GTCCTCG	3621
hsa-miR-612	GCUGGGCAGGGCUUCGAGCUCCU	811	CCTGCCAG	1748	CTGCCAG	2685	TGCCAG	3622
hsa-miR-613	AGGAAUGUCCUUCUUGCC	812	GAACATTCC	1749	AACATTCC	2686	ACATTCC	3623
hsa-miR-614	GAACGCCUGUUCUUGCCAGGUGG	813	ACAGGCGTT	1750	CAGGCGTT	2687	AGGCGTT	3624
hsa-miR-615-3p	UCCGAGCCUGGUCUCCUCUU	814	CAGGCTCGG	1751	AGGCTCGG	2688	GGCTCGG	3625
hsa-miR-615-5p	GGGGUCCCGGUGCUGGAUC	815	GGGACCCC	1752	GGGACCCC	2689	GGACCCC	3626
hsa-miR-616	AGUCAUUGGAGGGUUUGAGCAG	816	TCCAATGAC	1753	CCAATGAC	2690	CAATGAC	3627
hsa-miR-616*	ACUCAAAACCCUUCAGUGACUU	817	GGTTTGTAG	1754	GTTTGTAG	2691	TTTGTAG	3628
hsa-miR-617	AGACUCCCAUUGAAGGUGGC	818	TGGGAAGTC	1755	GGGAAGTC	2692	GGAAGTC	3629
hsa-miR-618	AAACUCUACUUGUCCUUCAGAGU	819	AGTAGAGT	1756	GTAGAGT	2693	TAGAGT	3630
hsa-miR-619	GACCGGACAUGUUUGUCCAGU	820	TGTCAGGT	1757	GTCAGGT	2694	TCCAGGT	3631
hsa-miR-620	AUGGAGAUAGAUUAGAAU	821	CTATCTCCA	1758	TATCTCCA	2695	ATCTCCA	3632
hsa-miR-621	GGCUAGCAACAGCGCUUACCU	822	GTTGCTAGC	1759	TTGCTAGC	2696	TGCTAGC	3633
hsa-miR-622	ACAGUCUGCUGAGGUUGGAGC	823	AGCAGACTG	1760	GCAGACTG	2697	CAGACTG	3634
hsa-miR-623	AUCCUUGCAGGGGUCUUGGGU	824	TGCAAGGGA	1761	GCAAGGGA	2698	CAAGGGA	3635
hsa-miR-624	CACAAGGUAUUGGUAUUACCU	825	ATACCTTGT	1762	TACCTTGT	2699	ACCTTGT	3636
hsa-miR-624*	UAGUACCAGUACCUUGUGUUCA	826	ACTGGTACT	1763	CTGGTACT	2700	TGGTACT	3637
hsa-miR-625	AGGGGAAAGUUCUAUAGUCC	827	CTTCCCCC	1764	TTCCCCC	2701	TTCCCCC	3638
hsa-miR-625*	GACUAUAGAACUUUCCCCUCA	828	TTCTATAGT	1765	TCTATAGT	2702	CTATAGT	3639
hsa-miR-626	AGCUGUCUGAAAUGUCUU	829	TCAGACAGC	1766	CAGACAGC	2703	AGACAGC	3640
hsa-miR-627	GUGAGUCUCUAAGAAAAGAGGA	830	AGAGACTCA	1767	GAGACTCA	2704	AGACTCA	3641
hsa-miR-628-3p	UCUAGUAAGAGUGGCAGUCGA	831	TCTTACTAG	1768	CTTACTAG	2705	TTACTAG	3642
hsa-miR-628-5p	AUGCUGACAUAUUUACUAGAGG	832	ATGTCAGCA	1769	GTCAGCA	2706	GTCAGCA	3643
hsa-miR-629	UGGGUUUACGUUGGGAGAACU	833	CGTAAACCC	1770	GTAACCC	2707	TAAACCC	3644
hsa-miR-629*	GUUCUCCCAACGUAAGCCCAGC	834	TTGGGAGAA	1771	TGGGAGAA	2708	GGGAGAA	3645
hsa-miR-630	AGUAUUCUGUACCAGGGAAGGU	835	ACAGAATAC	1772	CAGAATAC	2709	AGAATAC	3646
hsa-miR-631	AGACCUGGCCAGACCUCAGC	836	GGCCAGGTC	1773	GCCAGGTC	2710	CCAGGTC	3647
hsa-miR-632	GUGUCUGCUUCUGUGGGA	837	AAGCAGACA	1774	AGCAGACA	2711	GCAGACA	3648
hsa-miR-633	CUAUAGUAUCUACCACAAUAAA	838	ATACTATTA	1775	TACTATTA	2712	ACTATTA	3649
hsa-miR-634	AACCAGCACCCAAACUUUGGAC	839	GGTGCTGGT	1776	GTGCTGGT	2713	TGCTGGT	3650
hsa-miR-635	ACUUGGGCACUGAAACAUGUCC	840	GTGCCAAG	1777	TGCCAAG	2714	GCCAAG	3651
hsa-miR-636	UGUGCUUGCUCGUCGCCCGCA	841	AGCAAGCAC	1778	GCAAGCAC	2715	CAAGCAC	3652
hsa-miR-637	ACUGGGGCUUUCGGGUCUGCGU	842	AGCCCCAG	1779	GCCCCAG	2716	CCCCAG	3653
hsa-miR-638	AGGGAUCGCGGGCGGUGGCGCCU	843	CGGATCCC	1780	GCGATCCC	2717	CGATCCC	3654
hsa-miR-639	AUCGUCGCGGUGCGAGCGUGU	844	CGCAGCGA	1781	GCGAGCGA	2718	GCAGCGA	3655
hsa-miR-640	AUGAUCAGGAACCGGCCUCU	845	CCTGGATCA	1782	CTGGATCA	2719	TGGATCA	3656
hsa-miR-641	AAAGACAUAGGAUAGAGUCACCUC	846	CTATGTCTT	1783	TATGTCTT	2720	ATGTCTT	3657
hsa-miR-642	GUCCUCUCCAAAUGUGUCUUG	847	GGAGAGGGA	1784	GAGAGGGA	2721	AGAGGGA	3658
hsa-miR-643	ACUUGUAUGCUAGCUCAGGUAG	848	GCATACAAG	1785	CATACAAG	2722	ATACAAG	3659
hsa-miR-644	AGUGGGCUUUUUUAGAGC	849	AAGCCACAC	1786	AGCCACAC	2723	GCCACAC	3660
hsa-miR-645	UCUAGGCUGGUACUGCUGA	850	CCAGCCTAG	1787	CAGCCTAG	2724	AGCCTAG	3661
hsa-miR-646	AAGCAGCUGCCUCUGAGGC	851	GCAGCTGCT	1788	CAGCTGCT	2725	AGCTGCT	3662
hsa-miR-647	GUGGUCGACUCACUCCUUC	852	GTGCAGCCA	1789	TGCAGCCA	2726	GCAGCCA	3663
hsa-miR-648	AAGUGUCAGGGCACUGGU	853	CTGCACACT	1790	TGCACACT	2727	GCACACT	3664
hsa-miR-649	AAACCUUGUUGUUAAGAGUC	854	ACACAGGTT	1791	CACAGGTT	2728	ACAGGTT	3665
hsa-miR-650	AGGAGGCAGCGCUCUCAGGAC	855	GCTGCCTCC	1792	CTGCCTCC	2729	TGCCTCC	3666
hsa-miR-651	UUUAGGAUAAGCUUGACUUUUG	856	TTATCCTAA	1793	TATCCTAA	2730	ATCCTAA	3667
hsa-miR-652	AAUGGCGCCACUAGGGUUGUG	857	TGGCGCCAT	1794	GCGCCAT	2731	GCGCCAT	3668
hsa-miR-653	GUGUUGAAACAUCUCUACUG	858	GTTTCAACA	1795	TTTCAACA	2732	TCAACA	3669

hsa-miR-654-3p	UAUGUCUGCUGACCAUCACCUU	859	AGCAGACAT	1796	GCAGACAT	2733	CAGACAT	3670
hsa-miR-654-5p	UGGUGGGCCGAGAACAUUGUC	860	CGGCCACC	1797	GGCCACC	2734	GCCACC	3671
hsa-miR-655	AUAUAUCAUGGUUAACCUCUUU	861	CATGTATTA	1798	ATGTATTA	2735	TGTATTA	3672
hsa-miR-656	AAUAUUAUACAGUCAACCUCU	862	GTATAATAT	1799	TATAATAT	2736	ATAATAT	3673
hsa-miR-657	GGCAGGUUCACCCUCUCUAGG	863	AGAACCTGC	1800	GACCTGC	2737	AACCTGC	3674
hsa-miR-658	GGCGGAGGGAAGUAGGUCCGUUGU	864	TCCCTCCGC	1801	CCCTCCGC	2738	CCTCCGC	3675
hsa-miR-659	CUUGGUUCAGGGAGGUCCCA	865	CTGAACCAA	1802	TGAACCAA	2739	GAACCAA	3676
hsa-miR-660	UACCCAUGCAUAUCGGAGUUG	866	GCAATGGGT	1803	CAATGGGT	2740	AATGGGT	3677
hsa-miR-661	UGCCUGGGUCUCUGGCCUGCGCU	867	GACCCAGGC	1804	ACCCAGGC	2741	CCCAGGC	3678
hsa-miR-662	UCCCACGUUGUGGCCAGCAG	868	CAACGTGGG	1805	AACGTGGG	2742	ACGTGGG	3679
hsa-miR-663	AGGCGGGGCGCCGCGGACCGC	869	CGCCCGCC	1806	GCCCGCC	2743	CCCGCC	3680
hsa-miR-663b	GGUGGCCCGCGGUGCCUGAGG	870	CCGGCCAC	1807	CGGGCCAC	2744	GGCCAC	3681
hsa-miR-664	UAUUCAUUUAUCCCCAGCCUACA	871	TAAATGAAT	1808	AAATGAAT	2745	AATGAAT	3682
hsa-miR-664*	ACUGGCUAGGGAUAUUGGAU	872	CCTAGCCAG	1809	CTAGCCAG	2746	TAGCCAG	3683
hsa-miR-665	ACCAGGAGGUCAGGCCCCU	873	GCCTCCTGG	1810	CCTCCTGG	2747	CTCCTGG	3684
hsa-miR-668	UGUCACUCGGCUCGGCCACUAC	874	CGAGTGAC	1811	CGAGTGAC	2748	GAGTGAC	3685
hsa-miR-671-3p	UCCGUUUCUCAGGGCUCACC	875	GAGAACCGG	1812	AGAACCGG	2749	GAACCGG	3686
hsa-miR-671-5p	AGGAAGCCUCGGAGGGCUGGAG	876	AGGGCTTCC	1813	GGGCTTCC	2750	GGTTC	3687
hsa-miR-675	UGGUGCGGAGAGGGCCACAGUG	877	CTCCGCACC	1814	TCCGCACC	2751	CCGCACC	3688
hsa-miR-675b	CUGUAUGCCUCACCGCUCA	878	GGCATAACA	1815	GGCATAACA	2752	GCATAACA	3689
hsa-miR-7	UGGAAGACUAGUGAUUUUGUUGU	879	TAGTCTTCC	1816	AGTCTTCC	2753	GCTTCC	3690
hsa-miR-7-1*	CAACAAAUCACAGUCUGCCAU	880	TGATTGT	1817	GATTGT	2754	ATTGT	3691
hsa-miR-7-2*	CAACAAUCCAGUCUACCUAA	881	GGATTGT	1818	GATTGT	2755	ATTGT	3692
hsa-miR-708	AAGGAGCUUACAAUCUAGCUGGG	882	TAAGCTCCT	1819	AAGCTCCT	2756	AGCTCCT	3693
hsa-miR-708*	CAACUAGACUGUGAGCUUCUAG	883	AGTCTAGTT	1820	GTCTAGTT	2757	TCTAGTT	3694
hsa-miR-720	UCUCGUGGGGCCUCCA	884	CCCAGCGAG	1821	CCAGCGAG	2758	CAGCGAG	3695
hsa-miR-744	UGCGGGUCUAGGGCUAACAGCA	885	TAGCCCCGC	1822	AGCCCCGC	2759	GCCCCGC	3696
hsa-miR-744*	CUGUUGCCACUAACCUAACCU	886	GTGGCAACA	1823	TGGCAACA	2760	GGCAACA	3697
hsa-miR-758	UUUGUGACCUGGUCCACUAACC	887	AGGTCACAA	1824	GGTCACAA	2761	GTCACAA	3698
hsa-miR-760	CGGCUCUGGGUCUGGGGA	888	CCCAGAGCC	1825	CCAGAGCC	2762	CAGAGCC	3699
hsa-miR-765	UGGAGGAGAAGGAAGGUGAUG	889	TTCTCTTCC	1826	TCTCTTCC	2763	CTCTTCC	3700
hsa-miR-766	ACUCCAGCCCCACAGCCUCAGC	890	GGGCTGGAG	1827	GGCTGGAG	2764	GCTGGAG	3701
hsa-miR-767-3p	UCUGCUCAUACCCCAUGGUUUUCU	891	TATGAGCAG	1828	ATGAGCAG	2765	TGAGCAG	3702
hsa-miR-767-5p	UGCACCAUGGUUGUCUGAGCAUG	892	CCATGGTGC	1829	CATGGTGC	2766	ATGGTGC	3703
hsa-miR-769-3p	CUGGGAUCUCCGGGUCUUGGUU	893	GAGATCCCA	1830	AGATCCCA	2767	GATCCCA	3704
hsa-miR-769-5p	UGAGACCUCUGGGUUCUGAGCU	894	AGAGGTCTC	1831	GAGGTCTC	2768	AGGTCTC	3705
hsa-miR-770-5p	UCCAGUACCAGUGUCAGGGCCA	895	TGGTACTGG	1832	GGTACTGG	2769	GACTACTGG	3706
hsa-miR-802	CAGUAAACAAGAUUCAUCCUUGU	896	TTGTACT	1833	TGTACT	2770	TGTACT	3707
hsa-miR-873	GCAGGAACUUGUGAGUCUCU	897	AAGTTCCTG	1834	AGTTCCTG	2771	GTCCTG	3708
hsa-miR-874	CUGCCUGGCCGAGGACCGA	898	GCCAGGCA	1835	CCAGGCA	2772	CAGGCA	3709
hsa-miR-875-3p	CCUGGAAACACUGAGGUUGUG	899	TGTTCCAG	1836	GTTCCAG	2773	TTCCAG	3710
hsa-miR-875-5p	UAUACCUCAGUUUAUCAGGUG	900	CTGAGGTAT	1837	TGAGGTAT	2774	GAGGTAT	3711
hsa-miR-876-3p	UGGUGUUUACAAAGUAAUUC	901	TAAACCACC	1838	AAACCACC	2775	AACCACC	3712
hsa-miR-876-5p	UGGAUUUCUUGUGAAUCACCA	902	AAGAAATCC	1839	AGAAATCC	2776	GAAATCC	3713
hsa-miR-877	GUAGAGGAGAUGGCGCAGGG	903	TCTCTCTA	1840	CTCTCTA	2777	TCTCTA	3714
hsa-miR-877*	UCCUCUUCUCCUCCUCCAG	904	GAGAAGAGG	1841	AGAAGAGG	2778	GAAGAGG	3715
hsa-miR-885-3p	AGGCAGCGGGUGUAGUGGAUA	905	CCGCTGCC	1842	CCGCTGCC	2779	CGCTGCC	3716
hsa-miR-885-5p	UCCAUUACACUACCCUGCCUCU	906	GTGTAATGG	1843	TGTAATGG	2780	GTAATGG	3717
hsa-miR-886-3p	CGCGGGUGCUUACUGACCCU	907	AGCACCCGC	1844	GCACCCGC	2781	CACCCGC	3718
hsa-miR-886-5p	CGGGUCGGAGUAGUCAAGCGG	908	CTCCGACCC	1845	TCCGACCC	2782	CCGACCC	3719
hsa-miR-887	GUGAACGGGCGCAUCCCGAGG	909	GCCGTTCA	1846	CCGTTCA	2783	CGTTCA	3720
hsa-miR-888	UACUCAAAAAGCUGUCAGUCA	910	TTTTTGAGT	1847	TTTGAGT	2784	TTTGAGT	3721
hsa-miR-888*	GACUGACACCUUUGGGUGAA	911	GGTGCAGT	1848	GTGCAGT	2785	TGTCAGT	3722
hsa-miR-889	UUAAUAUCGGACAACCAUUGU	912	CCGATATTA	1849	CGATATTA	2786	GATATTA	3723
hsa-miR-890	UACUUGGAAAGGCAUCAGUUG	913	TTCCAAGT	1850	TCCAAGT	2787	TCCAAGT	3724

hsa-miR-891a	UGCAACGAACCUGAGCCACUGA	914	GTTTCGTTGC	1851	TTCGTTGC	2788	TCGTTGC	3725
hsa-miR-891b	UGCAACUUACCUGAGUCAUUGA	915	GTAAGTTGC	1852	TAAGTTGC	2789	AAGTTGC	3726
hsa-miR-892a	CACUGUGUCCUUUCUGCGUAG	916	GGACACAGT	1853	GACACAGT	2790	ACACAGT	3727
hsa-miR-892b	CACUGGCUCUUUCUGGGUAGA	917	GGAGCCAGT	1854	GAGCCAGT	2791	AGCCAGT	3728
hsa-miR-9	UCUUUGGUUAUCUAGCUGUAUGA	918	TAACCAAAG	1855	AACCAAAG	2792	ACCAAAG	3729
hsa-miR-9*	AUAAAGCUAGAUAAACCCAAAGU	919	CTAGCTTTA	1856	TAGCTTTA	2793	AGCTTTA	3730
hsa-miR-920	GGGAGCUGUGGAAGCAGUA	920	ACAGCTCCC	1857	CAGCTCCC	2794	AGCTCCC	3731
hsa-miR-921	CUAGUGAGGGACAGAACCAGGAUUC	921	CCCTACTA	1858	CCTACTA	2795	CTACTA	3732
hsa-miR-922	GCAGCAGAGAAUAGGACUACGUC	922	TCTCTGCTG	1859	CTCTGCTG	2796	TCTGCTG	3733
hsa-miR-923	GUCAGCGGAGGAAAAGAAACU	923	CTCCGCTGA	1860	TCCGCTGA	2797	CCGCTGA	3734
hsa-miR-924	AGAGUCUUGUGAUGUCUUGC	924	ACAAGACTC	1861	CAAGACTC	2798	AAGACTC	3735
hsa-miR-92a	UAUUGCACUUGUCCCGGCCUGU	925	AAGTGCAAT	1862	AGTGCAAT	2799	GTGCAAT	3736
hsa-miR-92a-1*	AGGUUGGGAUCGGUUGCAAUGCU	926	ATCCCAACC	1863	TCCCAACC	2800	CCCAACC	3737
hsa-miR-92a-2*	GGGUGGGGAUUUGUUGCAUUAC	927	ATCCCCACC	1864	TCCCCACC	2801	CCCCACC	3738
hsa-miR-92b	UAUUGCACUCGUCCCGGCCUCC	928	GAGTGCAAT	1865	AGTGCAAT	2802	GTGCAAT	3739
hsa-miR-92b*	AGGGACGGGACGCGGUCAGUG	929	TCCCGTCCC	1866	CCCGTCCC	2803	CCGTCCC	3740
hsa-miR-93	CAAAGUCGUGUUCGUGCAGGUAG	930	CAGCACTTT	1867	AGCACTTT	2804	GCACTTT	3741
hsa-miR-93*	ACUGCUGAGCUAGCACUUCCTCG	931	GCTCAGCAG	1868	CTCAGCAG	2805	TCAGCAG	3742
hsa-miR-933	UGUGCGCAGGGAGACCUCUCCC	932	CCTGCGCAC	1869	CTGCGCAC	2806	TGCGCAC	3743
hsa-miR-934	UGUCUACUACUGGAGACACUGG	933	GTAAGTAGAC	1870	TAGTAGAC	2807	AGTAGAC	3744
hsa-miR-935	CCAGUUACCGCUUCCGCUACCGC	934	CGGTAACGT	1871	GGTAACGT	2808	GTAACGT	3745
hsa-miR-936	ACAGUAGAGGGAGGAAUCGCAG	935	CCTTACTG	1872	CTTACTG	2809	TCTACTG	3746
hsa-miR-937	AUCCGCGCUCUGACUCUCUGCC	936	GAGCGCGGA	1873	AGCGCGGA	2810	GCGCGGA	3747
hsa-miR-938	UGCCCUAAAGGUGAACCCAGU	937	TTAAGGGC	1874	TTAAGGGC	2811	TAAGGGC	3748
hsa-miR-939	UGGGGAGCUGAGGCUCUGGGGGUG	938	CAGCTCCCC	1875	AGCTCCCC	2812	GCTCCCC	3749
hsa-miR-940	AAGGCAGGGCCCCCGCUCCCC	939	GCCCTGCCT	1876	CCCTGCCT	2813	CCTGCCT	3750
hsa-miR-941	CACCCGGCUGUGUGCAUUGUGC	940	CAGCCGGGT	1877	AGCCGGGT	2814	GCCGGGT	3751
hsa-miR-942	UCUUCUCUGUUUGGCCAUGUG	941	ACAGAGAAG	1878	CAGAGAAG	2815	AGAGAAG	3752
hsa-miR-943	CUGACUGUUGCCGUCCUCCAG	942	CAACAGTCA	1879	AACAGTCA	2816	ACAGTCA	3753
hsa-miR-944	AAAUAUUGUACAUCGGAUGAG	943	ACAATAATT	1880	CAATAATT	2817	AATAATT	3754
hsa-miR-95	UUCAACGGGUUUUUUUGAGCA	944	ACCGTTGA	1881	CCGTTGA	2818	CCGTTGA	3755
hsa-miR-96	UUUGGCACUAGCACAUUUUGCU	945	TAGTGCCAA	1882	AGTGCCAA	2819	GTGCCAA	3756
hsa-miR-96*	AAUCAUGUGCAGUGCCAAUAUG	946	GCACATGAT	1883	CACATGAT	2820	ACATGAT	3757
hsa-miR-98	UGAGGUAGUAAGUUGUAUUGUU	947	TACTACCTC	1884	ACTACCTC	2821	CTACCTC	3758
hsa-miR-99a	AACCCGUAGAUCGACUUCUGUG	948	TCTACGGGT	1885	CTACGGGT	2822	TACGGGT	3759
hsa-miR-99a*	CAAGCUCGCUUCUAUGGGUCUG	949	AGCGAGCTT	1886	GCGAGCTT	2823	CGAGCTT	3760
hsa-miR-99b	CACCCGUAGAACCACCUUGCG	950	TCTACGGGT	1887	CTACGGGT	2824	TACGGGT	3761
hsa-miR-99b*	CAAGCUCGUGUCUGGGUCCG	951	CACGAGCTT	1888	ACGAGCTT	2825	CGAGCTT	3762
hsv1-miR-H1	UGGAAGGACGGGAAGUGGAAG	952	CGTCTTCC	1889	GTCCTTCC	2826	TCCTTCC	3763
hsv1-miR-H2-3p	CCUGAGCCAGGGACGAGUGCGACU	953	CTGGCTCAG	1890	TGGCTCAG	2827	GGCTCAG	3764
hsv1-miR-H2-5p	UCGCACGCGCCCGGCACAGACU	954	GCGGTGCG	1891	CGGTGCG	2828	GCGTGCG	3765
hsv1-miR-H3	CUGGGACUGUGCGGUUGGGA	955	ACAGTCCCA	1892	CAGTCCCA	2829	AGTCCCA	3766
hsv1-miR-H4-3p	CUUGCCUGUCUACUCGCUAGU	956	GACAGGCAA	1893	ACAGGCAA	2830	CAGGCAA	3767
hsv1-miR-H4-5p	GGUAGAGUUUGACAGGCAAGCA	957	AAACTCTAC	1894	AACTCTAC	2831	ACTCTAC	3768
hsv1-miR-H5	GUCAGAGAUCCAAACCUCGCG	958	GATCTCTGA	1895	ATCTCTGA	2832	TCTCTGA	3769
hsv1-miR-H6	CACUCCCGUCCUCCAUCCC	959	ACGGGAAGT	1896	CGGGAAGT	2833	GGGAAGT	3770
kshv-miR-K12-1	AUUACAGGAACUGGGUGUAAGC	960	TTCTGTAA	1897	TCTGTAA	2834	CCTGTAA	3771
kshv-miR-K12-10a	UAGUGUUGUCCCCCGAGUGGC	961	GACAACACT	1898	ACAACACT	2835	CAACACT	3772
kshv-miR-K12-10b	UGGUGUUGUCCCCCGAGUGGC	962	GACAACACC	1899	ACAACACC	2836	CAACACC	3773
kshv-miR-K12-11	UUAAUGCUUAGCCUGUGUCCGA	963	TAAGCATTA	1900	AAGCATTA	2837	AGCATTA	3774
kshv-miR-K12-12	ACCAGGCCACCAUCCUCUCCG	964	GTGGCCTGG	1901	TGGCCTGG	2838	GGCCTGG	3775
kshv-miR-K12-2	AACUGUAGUCCGGGUCGAUCUG	965	GACTACAGT	1902	ACTACAGT	2839	CTACAGT	3776
kshv-miR-K12-3	UCACAUUCUGAGGACGGCAGCGA	966	CAGAATGTG	1903	AGAATGTG	2840	GAATGTG	3777
kshv-miR-K12-3*	UCGCGGUCACAGAAUGUGACA	967	GTGACCGCG	1904	TGACCGCG	2841	GACCGCG	3778
kshv-miR-K12-4-3p	UAGAAUACUGAGGCCUAGCUGA	968	CAGTATTCT	1905	AGTATTCT	2842	GTATTCT	3779

kshv-miR-K12-4-5p	AGCUAAACCGCAGUACUCUAGG	969	CGGTTTAGC	1906	GGTTTAGC	2843	GTTTAGC	3780
kshv-miR-K12-5	UAGGAUGCCUGGAACUUGCCGG	970	AGGCATCCT	1907	GGCATCCT	2844	GCATCCT	3781
kshv-miR-K12-6-3p	UGAUGGUUUUCGGGCUGUUGAG	971	AAAACCATC	1908	AAACCATC	2845	AACCATC	3782
kshv-miR-K12-6-5p	CCAGCAGCACCUAUCCAUCGG	972	GTGCTGCTG	1909	TGCTGCTG	2846	GCTGCTG	3783
kshv-miR-K12-7	UGAUCCCAUGUUGCUGGCGCU	973	CATGGGATC	1910	ATGGGATC	2847	TGGGATC	3784
kshv-miR-K12-8	UAGGCGCGACUGAGAGAGCAG	974	GTCGCGCCT	1911	TCGCGCCT	2848	CGCGCCT	3785
kshv-miR-K12-9	CUGGGUAUACGCAGCUGCGUAA	975	GTATACCCA	1912	TATACCCA	2849	ATACCCA	3786
kshv-miR-K12-9*	ACCCAGCUGCGUAAACCCCGCU	976	GCAGCTGGG	1913	CAGCTGGG	2850	AGCTGGG	3787

CLAIMS

1. An oligomer consisting of a contiguous sequence of 7, 8, 9 or 10 nucleotide units in length, for use in reducing the effective amount of a functional microRNA (miRNA) target in a cell or an organism, wherein all of the nucleotide units of the oligomer are locked nucleic acid (LNA) units, wherein all of the internucleoside linkages present between the nucleotide units of the contiguous nucleotide sequence are phosphorothioate internucleoside linkages, wherein the contiguous nucleotide sequence of the oligomer consists of a sequence which is complementary to a seed sequence of said microRNA, and wherein the oligomer is 100% complementary to the microRNA sequence.
2. The oligomer according to claim 1, wherein nucleotide units 1 – 6 of the oligomer as measured from the 3' end are complementary to the microRNA seed region.
3. The oligomer according to claim 1, wherein nucleotide units 1 – 7 of the oligomer as measured from the 3' end are complementary to the microRNA seed region.
4. The oligomer according to claim 1, wherein nucleotide units 2 – 7 of the oligomer as measured from the 3' end are complementary to the microRNA seed region.
5. The oligomer according to any one of claims 1-4, wherein the contiguous nucleotide sequence is complementary to a region of a microRNA (miRNA) sequence selected from the group consisting of miR-21, miR-155, miR-221, miR-222, and miR-122.
6. The oligomer according to any one of claims 1-4, wherein said miRNA is selected from the group consisting of miR-1, miR-10b, miR-29, miR-125b, miR-126, miR-

133, miR-141, miR-143, miR-200b, miR-206, miR-208, miR-302, miR-372, miR-373, miR-375, and miR-520c/e.

7. The oligomer according to any one of claims 1-4, wherein the contiguous
 5 nucleotide sequence is complementary to a region of a microRNA (miRNA) sequence present in a miR 17 - 92 cluster, wherein the miR 17 - 92 cluster comprises a microRNA selected from the group consisting of miR-17-5p, miR-20a/b, miR-93, miR-106a/b, miR-18a/b, miR-19a/b, miR-25, miR-92a, and miR-363.
- 10
8. The oligomer according to any one of claims 1-4, wherein the contiguous nucleotide sequence is complementary to a region of a mammalian, human or viral microRNA (miRNA) sequence selected from the group of ebv-miR-BART1-3p, ebv-miR-BART1-5p, ebv-miR-BART10, ebv-miR-BART10*, ebv-miR-BART11-3p, ebv-miR-BART11-5p, ebv-miR-BART12, ebv-miR-BART13, ebv-miR-BART13*, ebv-miR-BART14, ebv-miR-BART14*, ebv-miR-BART15, ebv-miR-BART16, ebv-miR-BART17-3p, ebv-miR-BART17-5p, ebv-miR-BART18-3p, ebv-miR-BART18-5p, ebv-miR-BART19-3p, ebv-miR-BART19-5p, ebv-miR-BART2-3p, ebv-miR-BART2-5p, ebv-miR-BART20-3p, ebv-miR-BART20-5p,
 15 ebv-miR-BART3, ebv-miR-BART3*, ebv-miR-BART4, ebv-miR-BART5, ebv-miR-BART6-3p, ebv-miR-BART6-5p, ebv-miR-BART7, ebv-miR-BART7*, ebv-miR-BART8, ebv-miR-BART8*, ebv-miR-BART9, ebv-miR-BART9*, ebv-miR-BHRF1-1, ebv-miR-BHRF1-2, ebv-miR-BHRF1-2*, ebv-miR-BHRF1-3, hcmv-miR-UL112, hcmv-miR-UL148D, hcmv-miR-UL22A, hcmv-miR-UL22A*, hcmv-miR-UL36, hcmv-miR-UL36*, hcmv-miR-UL70-3p, hcmv-miR-UL70-5p, hcmv-miR-US25-1, hcmv-miR-US25-1*, hcmv-miR-US25-2-3p, hcmv-miR-US25-2-5p, hcmv-miR-US33-3p, hcmv-miR-US33-5p, hcmv-miR-US4, hcmv-miR-US5-1, hcmv-miR-US5-2, hsa-let-7a, hsa-let-7a*, hsa-let-7b, hsa-let-7b*, hsa-let-7c, hsa-let-7c*, hsa-let-7d, hsa-let-7d*, hsa-let-7e, hsa-let-7e*, hsa-let-7f, hsa-let-7f-1*, hsa-let-
- 20
- 25

7f-2*, hsa-let-7g, hsa-let-7g*, hsa-let-7i, hsa-let-7i*, hsa-miR-1, hsa-miR-100,
 hsa-miR-100*, hsa-miR-101, hsa-miR-101*, hsa-miR-103, hsa-miR-103-as, hsa-
 miR-105, hsa-miR-105*, hsa-miR-106a, hsa-miR-106a*, hsa-miR-106b, hsa-miR-
 106b*, hsa-miR-107, hsa-miR-10a, hsa-miR-10a*, hsa-miR-10b, hsa-miR-10b*,
 5 hsa-miR-1178, hsa-miR-1179, hsa-miR-1180, hsa-miR-1181, hsa-miR-1182,
 hsa-miR-1183, hsa-miR-1184, hsa-miR-1185, hsa-miR-1197, hsa-miR-1200,
 hsa-miR-1201, hsa-miR-1202, hsa-miR-1203, hsa-miR-1204, hsa-miR-1205,
 hsa-miR-1206, hsa-miR-1207-3p, hsa-miR-1207-5p, hsa-miR-1208, hsa-miR-
 122, hsa-miR-122*, hsa-miR-1224-3p, hsa-miR-1224-5p, hsa-miR-1225-3p, hsa-
 10 miR-1225-5p, hsa-miR-1226, hsa-miR-1226*, hsa-miR-1227, hsa-miR-1228,
 hsa-miR-1228*, hsa-miR-1229, hsa-miR-1231, hsa-miR-1233, hsa-miR-1234,
 hsa-miR-1236, hsa-miR-1237, hsa-miR-1238, hsa-miR-124, hsa-miR-124*, hsa-
 miR-1243, hsa-miR-1244, hsa-miR-1245, hsa-miR-1246, hsa-miR-1247, hsa-
 miR-1248, hsa-miR-1249, hsa-miR-1250, hsa-miR-1251, hsa-miR-1252, hsa-
 15 miR-1253, hsa-miR-1254, hsa-miR-1255a, hsa-miR-1255b, hsa-miR-1256, hsa-
 miR-1257, hsa-miR-1258, hsa-miR-1259, hsa-miR-125a-3p, hsa-miR-125a-5p,
 hsa-miR-125b, hsa-miR-125b-1*, hsa-miR-125b-2*, hsa-miR-126, hsa-miR-126*,
 hsa-miR-1260, hsa-miR-1261, hsa-miR-1262, hsa-miR-1263, hsa-miR-1264,
 hsa-miR-1265, hsa-miR-1266, hsa-miR-1267, hsa-miR-1268, hsa-miR-1269,
 20 hsa-miR-127-3p, hsa-miR-127-5p, hsa-miR-1270, hsa-miR-1271, hsa-miR-1272,
 hsa-miR-1273, hsa-miR-1274a, hsa-miR-1274b, hsa-miR-1275, hsa-miR-1276,
 hsa-miR-1277, hsa-miR-1278, hsa-miR-1279, hsa-miR-128, hsa-miR-1280, hsa-
 miR-1281, hsa-miR-1282, hsa-miR-1283, hsa-miR-1284, hsa-miR-1285, hsa-
 miR-1286, hsa-miR-1287, hsa-miR-1288, hsa-miR-1289, hsa-miR-129*, hsa-
 25 miR-129-3p, hsa-miR-129-5p, hsa-miR-1290, hsa-miR-1291, hsa-miR-1292, hsa-
 miR-1293, hsa-miR-1294, hsa-miR-1295, hsa-miR-1296, hsa-miR-1297, hsa-
 miR-1298, hsa-miR-1299, hsa-miR-1300, hsa-miR-1301, hsa-miR-1302, hsa-
 miR-1303, hsa-miR-1304, hsa-miR-1305, hsa-miR-1306, hsa-miR-1307, hsa-
 miR-1308, hsa-miR-130a, hsa-miR-130a*, hsa-miR-130b, hsa-miR-130b*, hsa-

miR-132, hsa-miR-132*, hsa-miR-1321, hsa-miR-1322, hsa-miR-1323, hsa-miR-1324, hsa-miR-133a, hsa-miR-133b, hsa-miR-134, hsa-miR-135a, hsa-miR-135a*, hsa-miR-135b, hsa-miR-135b*, hsa-miR-136, hsa-miR-136*, hsa-miR-137, hsa-miR-138, hsa-miR-138-1*, hsa-miR-138-2*, hsa-miR-139-3p, hsa-miR-139-5p, hsa-miR-140-3p, hsa-miR-140-5p, hsa-miR-141, hsa-miR-141*, hsa-miR-142-3p, hsa-miR-142-5p, hsa-miR-143, hsa-miR-143*, hsa-miR-144, hsa-miR-144*, hsa-miR-145, hsa-miR-145*, hsa-miR-1468, hsa-miR-1469, hsa-miR-146a, hsa-miR-146a*, hsa-miR-146b-3p, hsa-miR-146b-5p, hsa-miR-147, hsa-miR-1470, hsa-miR-1471, hsa-miR-147b, hsa-miR-148a, hsa-miR-148a*, hsa-miR-148b, hsa-miR-148b*, hsa-miR-149, hsa-miR-149*, hsa-miR-150, hsa-miR-150*, hsa-miR-151-3p, hsa-miR-151-5p, hsa-miR-152, hsa-miR-153, hsa-miR-1537, hsa-miR-1538, hsa-miR-1539, hsa-miR-154, hsa-miR-154*, hsa-miR-155, hsa-miR-155*, hsa-miR-15a, hsa-miR-15a*, hsa-miR-15b, hsa-miR-15b*, hsa-miR-16, hsa-miR-16-1*, hsa-miR-16-2*, hsa-miR-17, hsa-miR-17*, hsa-miR-181a, hsa-miR-181a*, hsa-miR-181a-2*, hsa-miR-181b, hsa-miR-181c, hsa-miR-181c*, hsa-miR-181d, hsa-miR-182, hsa-miR-182*, hsa-miR-1825, hsa-miR-1826, hsa-miR-1827, hsa-miR-183, hsa-miR-183*, hsa-miR-184, hsa-miR-185, hsa-miR-185*, hsa-miR-186, hsa-miR-186*, hsa-miR-187, hsa-miR-187*, hsa-miR-188-3p, hsa-miR-188-5p, hsa-miR-18a, hsa-miR-18a*, hsa-miR-18b, hsa-miR-18b*, hsa-miR-190, hsa-miR-1908, hsa-miR-1909, hsa-miR-1909*, hsa-miR-190b, hsa-miR-191, hsa-miR-191*, hsa-miR-1910, hsa-miR-1911, hsa-miR-1911*, hsa-miR-1912, hsa-miR-1913, hsa-miR-1914, hsa-miR-1914*, hsa-miR-1915, hsa-miR-1915*, hsa-miR-192, hsa-miR-192*, hsa-miR-193a-3p, hsa-miR-193a-5p, hsa-miR-193b, hsa-miR-193b*, hsa-miR-194, hsa-miR-194*, hsa-miR-195, hsa-miR-195*, hsa-miR-196a, hsa-miR-196a*, hsa-miR-196b, hsa-miR-197, hsa-miR-198, hsa-miR-199a-5p, hsa-miR-199b-3p, hsa-miR-199b-5p, hsa-miR-19a, hsa-miR-19a*, hsa-miR-19b, hsa-miR-19b-1*, hsa-miR-19b-2*, hsa-miR-200a, hsa-miR-200a*, hsa-miR-200b, hsa-miR-200b*, hsa-miR-200c, hsa-miR-200c*, hsa-miR-202, hsa-miR-202*, hsa-miR-203, hsa-miR-204, hsa-miR-205,

hsa-miR-206, hsa-miR-208a, hsa-miR-208b, hsa-miR-20a, hsa-miR-20a*, hsa-
 miR-20b, hsa-miR-20b*, hsa-miR-21, hsa-miR-21*, hsa-miR-210, hsa-miR-211,
 hsa-miR-212, hsa-miR-214, hsa-miR-214*, hsa-miR-215, hsa-miR-216a, hsa-
 miR-216b, hsa-miR-217, hsa-miR-218, hsa-miR-218-1*, hsa-miR-218-2*, hsa-
 5 miR-219-1-3p, hsa-miR-219-2-3p, hsa-miR-219-5p, hsa-miR-22, hsa-miR-22*,
 hsa-miR-220a, hsa-miR-220b, hsa-miR-220c, hsa-miR-221, hsa-miR-221*, hsa-
 miR-222, hsa-miR-222*, hsa-miR-223, hsa-miR-223*, hsa-miR-224, hsa-miR-
 23a, hsa-miR-23a*, hsa-miR-23b, hsa-miR-23b*, hsa-miR-24, hsa-miR-24-1*,
 hsa-miR-24-2*, hsa-miR-25, hsa-miR-25*, hsa-miR-26a, hsa-miR-26a-1*, hsa-
 10 miR-26a-2*, hsa-miR-26b, hsa-miR-26b*, hsa-miR-27a, hsa-miR-27a*, hsa-miR-
 27b, hsa-miR-27b*, hsa-miR-28-3p, hsa-miR-28-5p, hsa-miR-296-3p, hsa-miR-
 296-5p, hsa-miR-297, hsa-miR-298, hsa-miR-299-3p, hsa-miR-299-5p, hsa-miR-
 29a, hsa-miR-29a*, hsa-miR-29b, hsa-miR-29b-1*, hsa-miR-29b-2*, hsa-miR-
 29c, hsa-miR-29c*, hsa-miR-300, hsa-miR-301a, hsa-miR-301b, hsa-miR-302a,
 15 hsa-miR-302a*, hsa-miR-302b, hsa-miR-302b*, hsa-miR-302c, hsa-miR-302c*,
 hsa-miR-302d, hsa-miR-302d*, hsa-miR-302e, hsa-miR-302f, hsa-miR-30a, hsa-
 miR-30a*, hsa-miR-30b, hsa-miR-30b*, hsa-miR-30c, hsa-miR-30c-1*, hsa-miR-
 30c-2*, hsa-miR-30d, hsa-miR-30d*, hsa-miR-30e, hsa-miR-30e*, hsa-miR-31,
 hsa-miR-31*, hsa-miR-32, hsa-miR-32*, hsa-miR-320a, hsa-miR-320b, hsa-miR-
 20 320c, hsa-miR-320d, hsa-miR-323-3p, hsa-miR-323-5p, hsa-miR-324-3p, hsa-
 miR-324-5p, hsa-miR-325, hsa-miR-326, hsa-miR-328, hsa-miR-329, hsa-miR-
 330-3p, hsa-miR-330-5p, hsa-miR-331-3p, hsa-miR-331-5p, hsa-miR-335, hsa-
 miR-335*, hsa-miR-337-3p, hsa-miR-337-5p, hsa-miR-338-3p, hsa-miR-338-5p,
 hsa-miR-339-3p, hsa-miR-339-5p, hsa-miR-33a, hsa-miR-33a*, hsa-miR-33b,
 25 hsa-miR-33b*, hsa-miR-340, hsa-miR-340*, hsa-miR-342-3p, hsa-miR-342-5p,
 hsa-miR-345, hsa-miR-346, hsa-miR-34a, hsa-miR-34a*, hsa-miR-34b, hsa-miR-
 34b*, hsa-miR-34c-3p, hsa-miR-34c-5p, hsa-miR-361-3p, hsa-miR-361-5p, hsa-
 miR-362-3p, hsa-miR-362-5p, hsa-miR-363, hsa-miR-363*, hsa-miR-365, hsa-
 miR-367, hsa-miR-367*, hsa-miR-369-3p, hsa-miR-369-5p, hsa-miR-370, hsa-

miR-371-3p, hsa-miR-371-5p, hsa-miR-372, hsa-miR-373, hsa-miR-373*, hsa-miR-374a, hsa-miR-374a*, hsa-miR-374b, hsa-miR-374b*, hsa-miR-375, hsa-miR-376a, hsa-miR-376a*, hsa-miR-376b, hsa-miR-376c, hsa-miR-377, hsa-miR-377*, hsa-miR-378, hsa-miR-378*, hsa-miR-379, hsa-miR-379*, hsa-miR-380, hsa-miR-380*, hsa-miR-381, hsa-miR-382, hsa-miR-383, hsa-miR-384, hsa-miR-409-3p, hsa-miR-409-5p, hsa-miR-410, hsa-miR-411, hsa-miR-411*, hsa-miR-412, hsa-miR-421, hsa-miR-422a, hsa-miR-423-3p, hsa-miR-423-5p, hsa-miR-424, hsa-miR-424*, hsa-miR-425, hsa-miR-425*, hsa-miR-429, hsa-miR-431, hsa-miR-431*, hsa-miR-432, hsa-miR-432*, hsa-miR-433, hsa-miR-448, hsa-miR-449a, hsa-miR-449b, hsa-miR-450a, hsa-miR-450b-3p, hsa-miR-450b-5p, hsa-miR-451, hsa-miR-452, hsa-miR-452*, hsa-miR-453, hsa-miR-454, hsa-miR-454*, hsa-miR-455-3p, hsa-miR-455-5p, hsa-miR-483-3p, hsa-miR-483-5p, hsa-miR-484, hsa-miR-485-3p, hsa-miR-485-5p, hsa-miR-486-3p, hsa-miR-486-5p, hsa-miR-487a, hsa-miR-487b, hsa-miR-488, hsa-miR-488*, hsa-miR-489, hsa-miR-490-3p, hsa-miR-490-5p, hsa-miR-491-3p, hsa-miR-491-5p, hsa-miR-492, hsa-miR-493, hsa-miR-493*, hsa-miR-494, hsa-miR-495, hsa-miR-496, hsa-miR-497, hsa-miR-497*, hsa-miR-498, hsa-miR-499-3p, hsa-miR-499-5p, hsa-miR-500, hsa-miR-500*, hsa-miR-501-3p, hsa-miR-501-5p, hsa-miR-502-3p, hsa-miR-502-5p, hsa-miR-503, hsa-miR-504, hsa-miR-505, hsa-miR-505*, hsa-miR-506, hsa-miR-507, hsa-miR-508-3p, hsa-miR-508-5p, hsa-miR-509-3-5p, hsa-miR-509-3p, hsa-miR-509-5p, hsa-miR-510, hsa-miR-511, hsa-miR-512-3p, hsa-miR-512-5p, hsa-miR-513a-3p, hsa-miR-513a-5p, hsa-miR-513b, hsa-miR-513c, hsa-miR-514, hsa-miR-515-3p, hsa-miR-515-5p, hsa-miR-516a-3p, hsa-miR-516a-5p, hsa-miR-516b, hsa-miR-517*, hsa-miR-517a, hsa-miR-517b, hsa-miR-517c, hsa-miR-518a-3p, hsa-miR-518b, hsa-miR-518c, hsa-miR-518c*, hsa-miR-518d-3p, hsa-miR-518d-5p, hsa-miR-518e, hsa-miR-518f, hsa-miR-518f*, hsa-miR-519a, hsa-miR-519a*, hsa-miR-519b-3p, hsa-miR-519c-3p, hsa-miR-519d, hsa-miR-519e, hsa-miR-519e*, hsa-miR-520a-3p, hsa-miR-520a-5p, hsa-miR-520b, hsa-miR-520c-3p, hsa-miR-520d-3p, hsa-miR-520d-5p, hsa-miR-

520e, hsa-miR-520f, hsa-miR-520g, hsa-miR-520h, hsa-miR-521, hsa-miR-522, hsa-miR-523, hsa-miR-524-3p, hsa-miR-524-5p, hsa-miR-525-3p, hsa-miR-525-5p, hsa-miR-526b, hsa-miR-526b*, hsa-miR-527, hsa-miR-532-3p, hsa-miR-532-5p, hsa-miR-539, hsa-miR-541, hsa-miR-541*, hsa-miR-542-3p, hsa-miR-542-5p, hsa-miR-543, hsa-miR-544, hsa-miR-545, hsa-miR-545*, hsa-miR-548a-3p, hsa-miR-548a-5p, hsa-miR-548b-3p, hsa-miR-548b-5p, hsa-miR-548c-3p, hsa-miR-548c-5p, hsa-miR-548d-3p, hsa-miR-548d-5p, hsa-miR-548e, hsa-miR-548f, hsa-miR-548g, hsa-miR-548h, hsa-miR-548i, hsa-miR-548j, hsa-miR-548k, hsa-miR-548l, hsa-miR-548m, hsa-miR-548n, hsa-miR-548o, hsa-miR-548p, hsa-miR-549, hsa-miR-550, hsa-miR-550*, hsa-miR-551a, hsa-miR-551b, hsa-miR-551b*, hsa-miR-552, hsa-miR-553, hsa-miR-554, hsa-miR-555, hsa-miR-556-3p, hsa-miR-556-5p, hsa-miR-557, hsa-miR-558, hsa-miR-559, hsa-miR-561, hsa-miR-562, hsa-miR-563, hsa-miR-564, hsa-miR-566, hsa-miR-567, hsa-miR-568, hsa-miR-569, hsa-miR-570, hsa-miR-571, hsa-miR-572, hsa-miR-573, hsa-miR-574-3p, hsa-miR-574-5p, hsa-miR-575, hsa-miR-576-3p, hsa-miR-576-5p, hsa-miR-577, hsa-miR-578, hsa-miR-579, hsa-miR-580, hsa-miR-581, hsa-miR-582-3p, hsa-miR-582-5p, hsa-miR-583, hsa-miR-584, hsa-miR-585, hsa-miR-586, hsa-miR-587, hsa-miR-588, hsa-miR-589, hsa-miR-589*, hsa-miR-590-3p, hsa-miR-590-5p, hsa-miR-591, hsa-miR-592, hsa-miR-593, hsa-miR-593*, hsa-miR-595, hsa-miR-596, hsa-miR-597, hsa-miR-598, hsa-miR-599, hsa-miR-600, hsa-miR-601, hsa-miR-602, hsa-miR-603, hsa-miR-604, hsa-miR-605, hsa-miR-606, hsa-miR-607, hsa-miR-608, hsa-miR-609, hsa-miR-610, hsa-miR-611, hsa-miR-612, hsa-miR-613, hsa-miR-614, hsa-miR-615-3p, hsa-miR-615-5p, hsa-miR-616, hsa-miR-616*, hsa-miR-617, hsa-miR-618, hsa-miR-619, hsa-miR-620, hsa-miR-621, hsa-miR-622, hsa-miR-623, hsa-miR-624, hsa-miR-624*, hsa-miR-625, hsa-miR-625*, hsa-miR-626, hsa-miR-627, hsa-miR-628-3p, hsa-miR-628-5p, hsa-miR-629, hsa-miR-629*, hsa-miR-630, hsa-miR-631, hsa-miR-632, hsa-miR-633, hsa-miR-634, hsa-miR-635, hsa-miR-636, hsa-miR-637, hsa-miR-638, hsa-miR-639, hsa-miR-640, hsa-miR-641, hsa-miR-642, hsa-miR-643, hsa-miR-644,

hsa-miR-645, hsa-miR-646, hsa-miR-647, hsa-miR-648, hsa-miR-649, hsa-miR-650, hsa-miR-651, hsa-miR-652, hsa-miR-653, hsa-miR-654-3p, hsa-miR-654-5p, hsa-miR-655, hsa-miR-656, hsa-miR-657, hsa-miR-658, hsa-miR-659, hsa-miR-660, hsa-miR-661, hsa-miR-662, hsa-miR-663, hsa-miR-663b, hsa-miR-664, hsa-miR-664*, hsa-miR-665, hsa-miR-668, hsa-miR-671-3p, hsa-miR-671-5p, hsa-miR-675, hsa-miR-675b, hsa-miR-7, hsa-miR-7-1*, hsa-miR-7-2*, hsa-miR-708, hsa-miR-708*, hsa-miR-720, hsa-miR-744, hsa-miR-744*, hsa-miR-758, hsa-miR-760, hsa-miR-765, hsa-miR-766, hsa-miR-767-3p, hsa-miR-767-5p, hsa-miR-769-3p, hsa-miR-769-5p, hsa-miR-770-5p, hsa-miR-802, hsa-miR-873, hsa-miR-874, hsa-miR-875-3p, hsa-miR-875-5p, hsa-miR-876-3p, hsa-miR-876-5p, hsa-miR-877, hsa-miR-877*, hsa-miR-885-3p, hsa-miR-885-5p, hsa-miR-886-3p, hsa-miR-886-5p, hsa-miR-887, hsa-miR-888, hsa-miR-888*, hsa-miR-889, hsa-miR-890, hsa-miR-891a, hsa-miR-891b, hsa-miR-892a, hsa-miR-892b, hsa-miR-9, hsa-miR-9*, hsa-miR-920, hsa-miR-921, hsa-miR-922, hsa-miR-923, hsa-miR-924, hsa-miR-92a, hsa-miR-92a-1*, hsa-miR-92a-2*, hsa-miR-92b, hsa-miR-92b*, hsa-miR-93, hsa-miR-93*, hsa-miR-933, hsa-miR-934, hsa-miR-935, hsa-miR-936, hsa-miR-937, hsa-miR-938, hsa-miR-939, hsa-miR-940, hsa-miR-941, hsa-miR-942, hsa-miR-943, hsa-miR-944, hsa-miR-95, hsa-miR-96, hsa-miR-96*, hsa-miR-98, hsa-miR-99a, hsa-miR-99a*, hsa-miR-99b, hsa-miR-99b*, hsv1-miR-H1, hsv1-miR-H2-3p, hsv1-miR-H2-5p, hsv1-miR-H3, hsv1-miR-H4-3p, hsv1-miR-H4-5p, hsv1-miR-H5, hsv1-miR-H6, kshv-miR-K12-1, kshv-miR-K12-10a, kshv-miR-K12-10b, kshv-miR-K12-11, kshv-miR-K12-12, kshv-miR-K12-2, kshv-miR-K12-3, kshv-miR-K12-3*, kshv-miR-K12-4-3p, kshv-miR-K12-4-5p, kshv-miR-K12-5, kshv-miR-K12-6-3p, kshv-miR-K12-6-5p, kshv-miR-K12-7, kshv-miR-K12-8, kshv-miR-K12-9, and kshv-miR-K12-9.

9. The oligomer according to any one of claims 1-5, wherein the contiguous nucleotide sequence of the oligomer is complementary to the sequence of at least two miRNA sequences.

10. The oligomer according to claim 6 or 7, wherein the contiguous nucleotide sequence of the oligomer is complementary to the sequence of at least two miRNA sequences.
- 5
11. The oligomer according to claim 8, wherein the contiguous nucleotide sequence of the oligomer is complementary to the sequence of at least two miRNA sequences.
- 10
12. The oligomer according to claim 9, wherein the contiguous nucleotide sequence of the oligomer comprises a single universal nucleotide.
13. The oligomer according to claim 10, wherein the contiguous nucleotide sequence of the oligomer comprises a single universal nucleotide.
- 15
14. The oligomer according to claim 11, wherein the contiguous nucleotide sequence of the oligomer comprises a single universal nucleotide.
- 20
15. The oligomer according to claim 9 or 12, wherein the contiguous nucleotide sequence of the oligomer consists of a sequence which is complementary to the sequence of at least two miRNA seed region sequences.
- 25
16. The oligomer according to claim 10 or 13, wherein the contiguous nucleotide sequence of the oligomer consists of a sequence which is complementary to the sequence of at least two miRNA seed region sequences.
17. The oligomer according to claim 11 or 14, wherein the contiguous nucleotide sequence of the oligomer consists of a sequence which is complementary to the sequence of at least two miRNA seed region sequences.

18. The oligomer according to any one of claims 9, 12, and 15, wherein the contiguous nucleotide sequence is complementary to a region of both miR-221 and miR-222.
- 5
19. The oligomer according to claim 18, wherein the contiguous nucleotide sequence consists of a sequence that is complementary to 5'GCUACAU3'.
20. The oligomer according to any one of claims 1-5, 8, 9, and 11, wherein the
10 contiguous nucleotide sequence is complementary to a region of hsa-miR-122.
21. The oligomer according to claim 20, wherein said oligomer has the sequence 5'-CACACTCC-3'.
- 15 22. The oligomer according to claim 20 or 21, for use in the treatment of a medical disorder or disease selected from the group consisting of: hepatitis C virus infection and hypercholesterolemia.
- 20 23. The oligomer according to any one of claims 1-5, 8, 9, and 11, wherein the contiguous nucleotide sequence is complementary to a region of hsa-miR-21.
24. The oligomer according to claim 23, wherein said oligomer has the sequence 5'-GATAAGCT-3'.
- 25 25. The oligomer according to any one of claims 1-5, 8, 9, and 11, wherein the contiguous nucleotide sequence is complementary to a region of hsa-miR-155.
26. The oligomer according to claim 25, wherein said oligomer has the sequence 5'-TAGCATT-3'.

27. A pharmaceutical composition comprising the oligomer according to any one of claims 1-26, and a pharmaceutically acceptable diluent, carrier, salt or adjuvant.
- 5 28. Use of the pharmaceutical composition according to claim 27 for the treatment of a disease or medical disorder associated with the presence or over-expression of the microRNA.
- 10 29. The use of the oligomer according to any one of claims 1-26, or the pharmaceutical composition according to claim 27 for inhibiting the microRNA in a cell which comprises said microRNA.
- 15 30. Use of the oligomer according to any one of claims 1-21 and 23-26, or the pharmaceutical composition according to claim 27 for reducing the amount, or effective amount, of the functional miRNA in the cell, wherein the oligomer or pharmaceutical composition is administered *in vitro* to the cell which is expressing said miRNA.
- 20 31. Use of the oligomer according to any one of claims 1-26, or the pharmaceutical composition according to claim 27 for de-repression of one or more mRNAs whose expression is repressed by the miRNA according to any one of claims 1-26 in a cell.
- 25 32. Use of the oligomer according to any one of claims 1-21 and 23-26, or the pharmaceutical composition according to claim 27 for de-repression of one or more mRNAs whose expression is repressed by the miRNA according to any one of claims 1-26 in a cell, wherein the oligomer or pharmaceutical composition is administered *in vitro* to the cell which expresses both said mRNA and said miRNA.

FIGURES

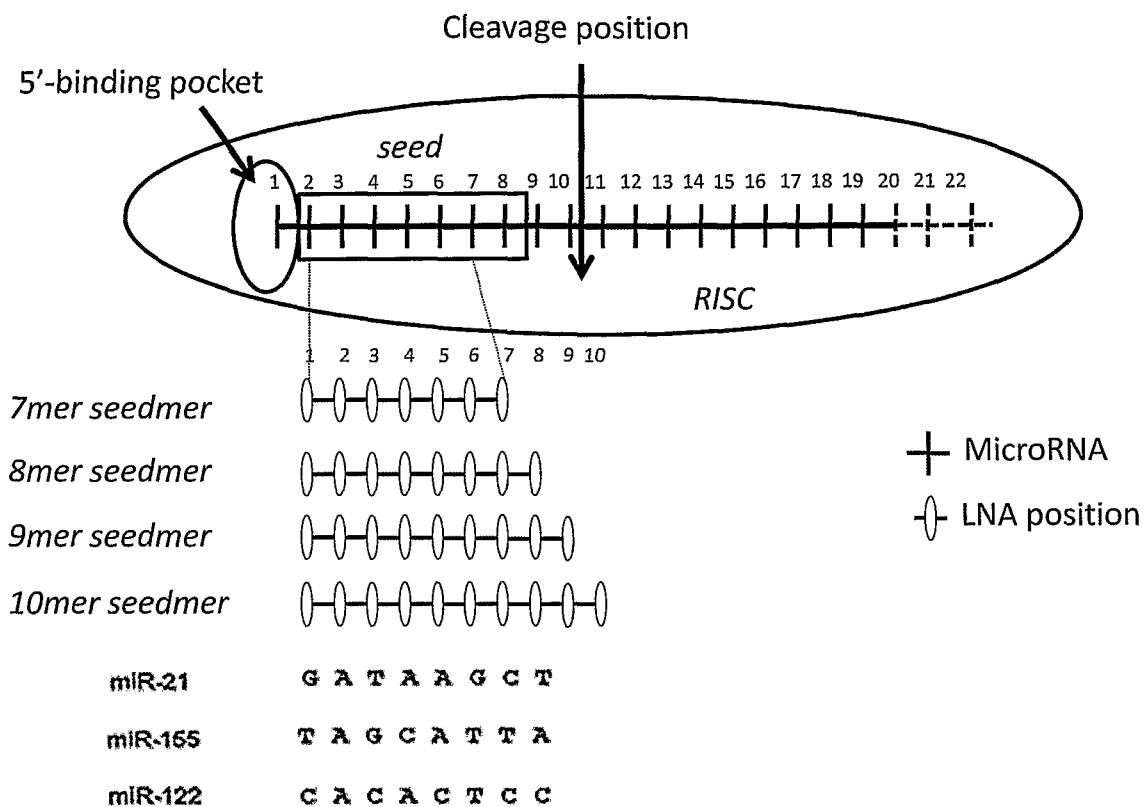

Figure 1

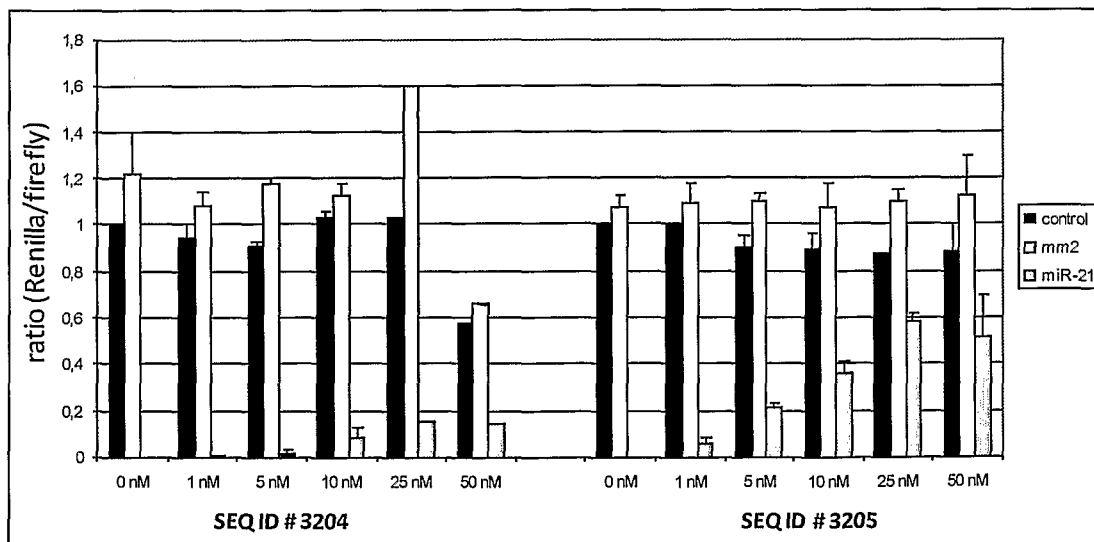

Figure 2

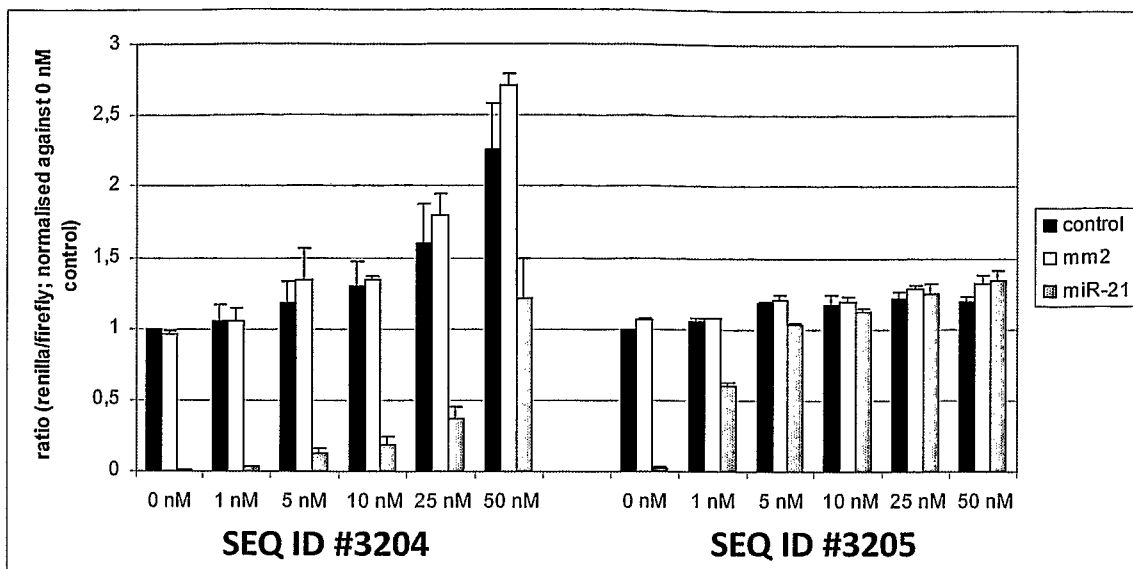

Figure 3

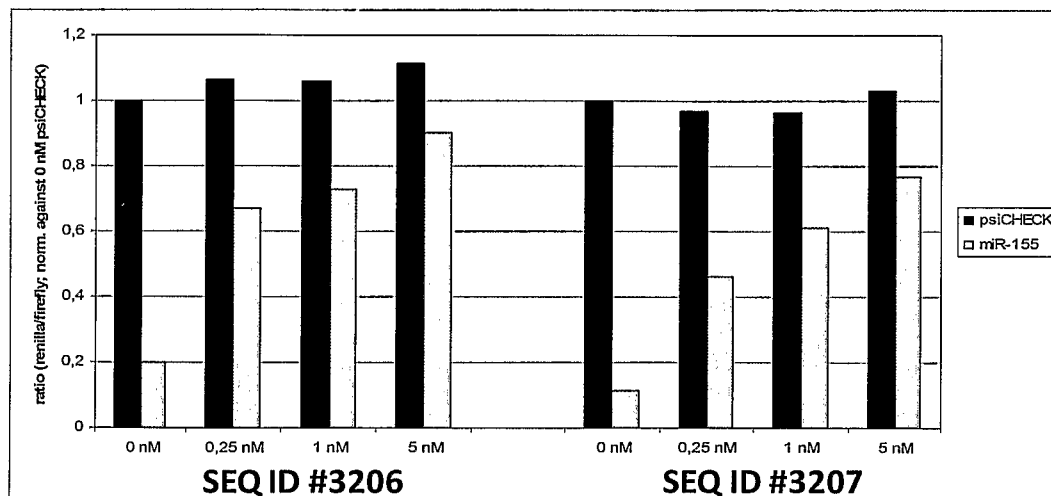

Figure 4

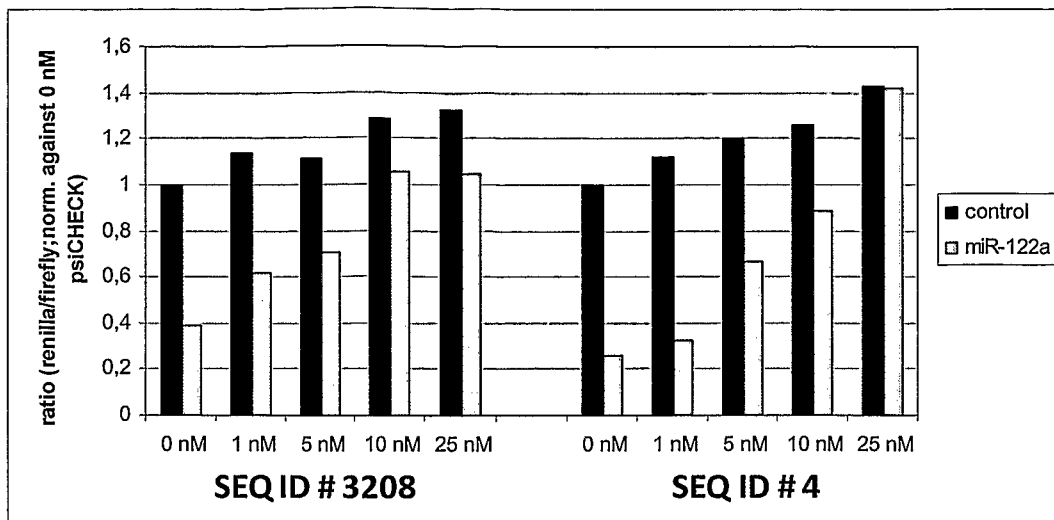

Figure 5

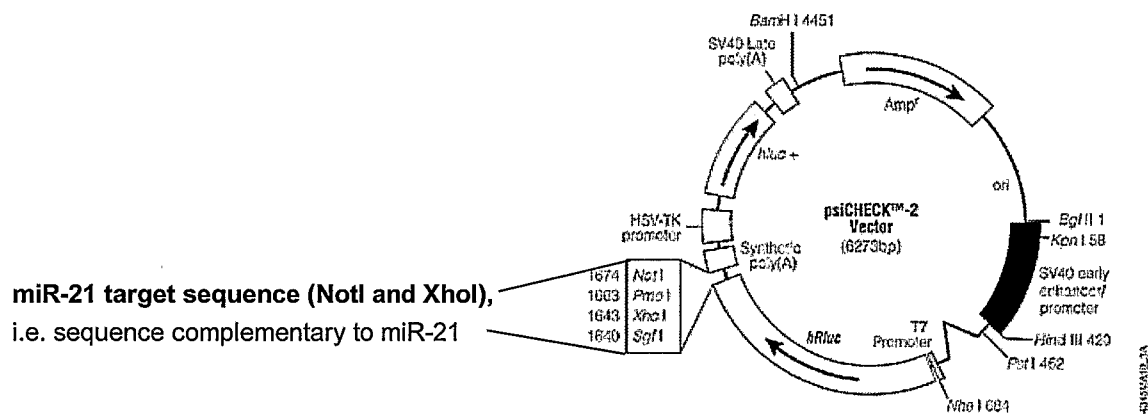

Figure 6

4/22

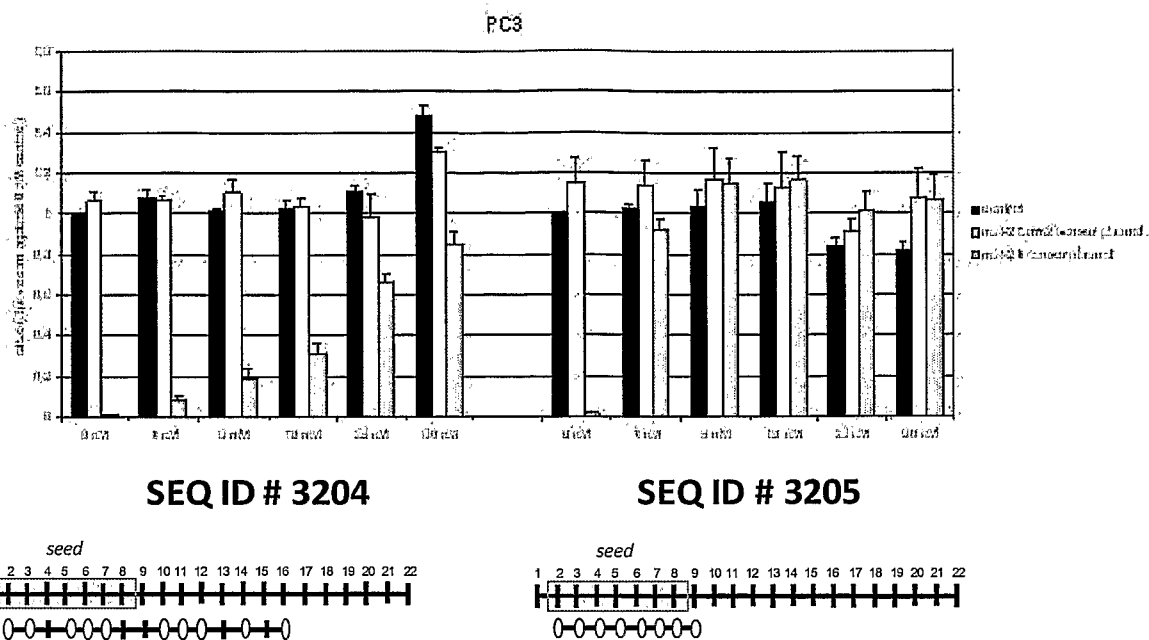

Figure 7

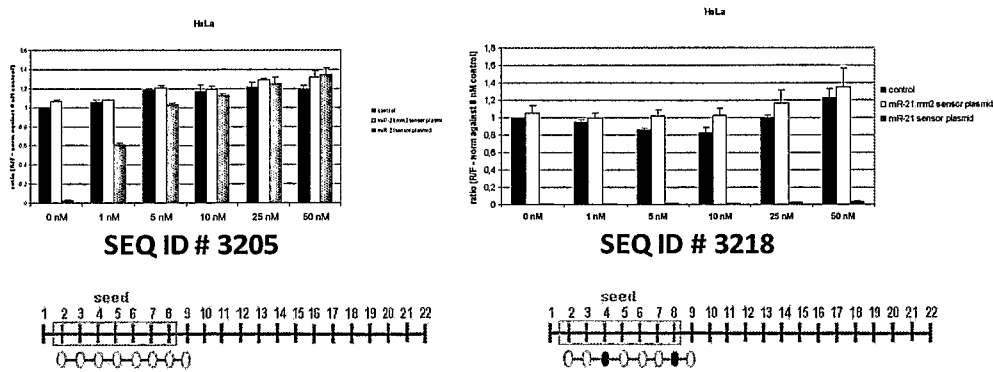

Figure 8

5/22

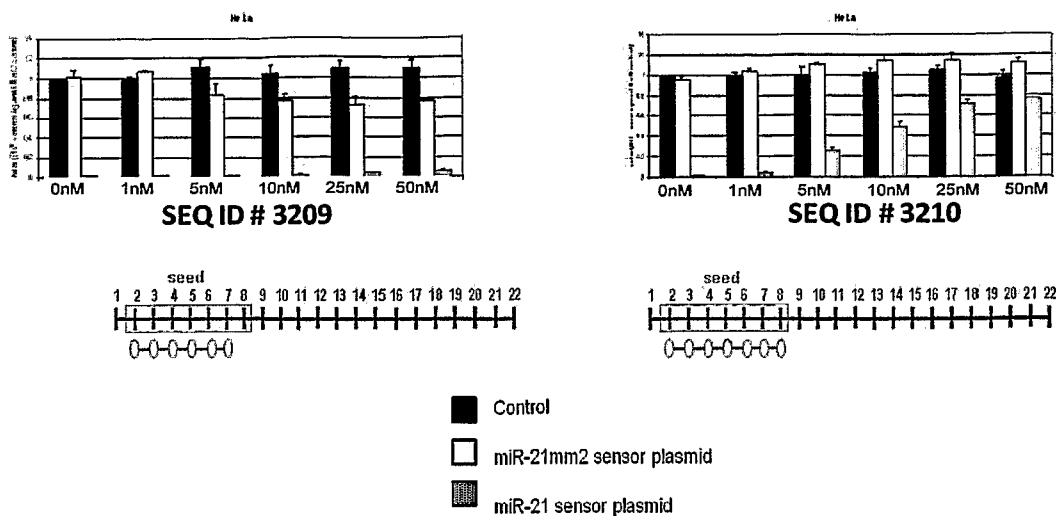

Figure 9

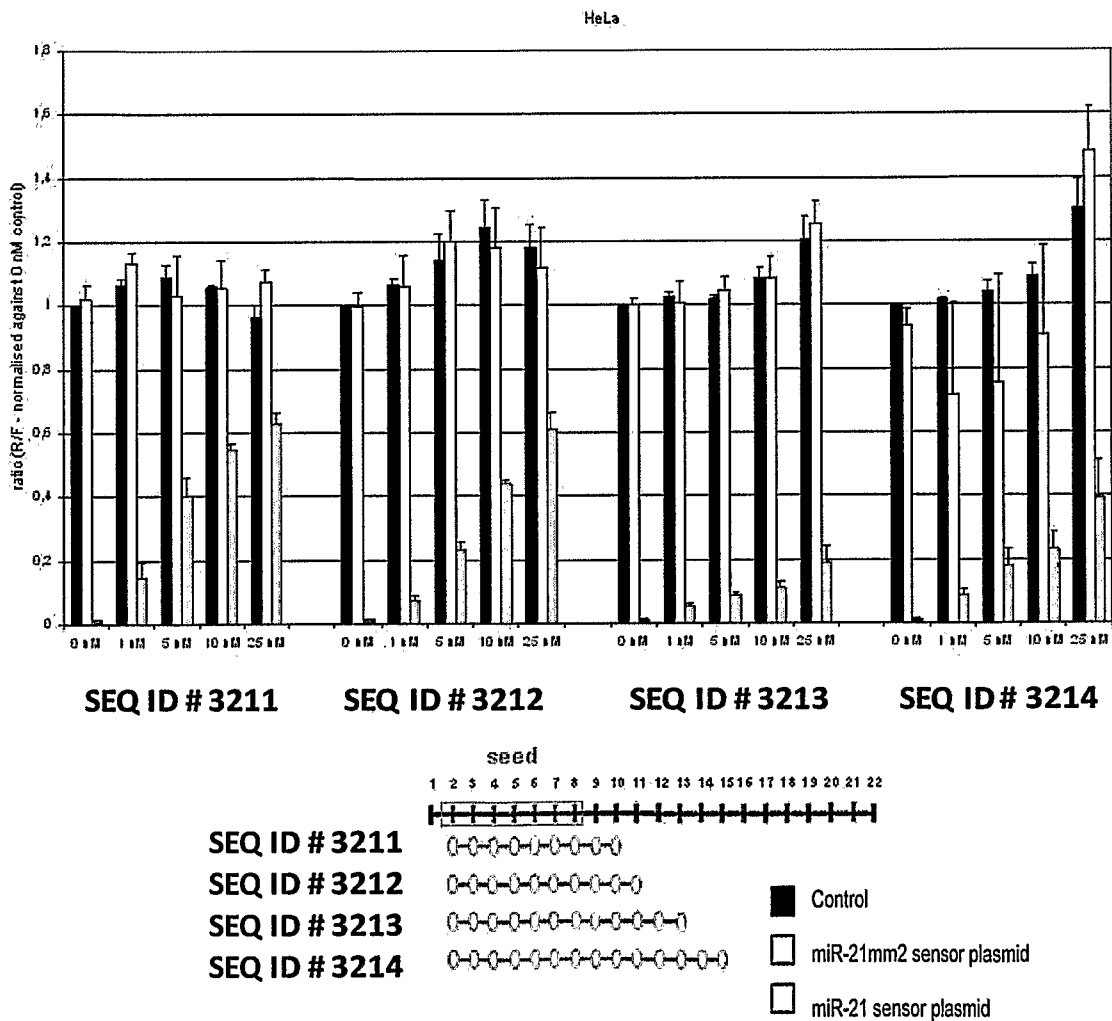

Figure 10

6/22

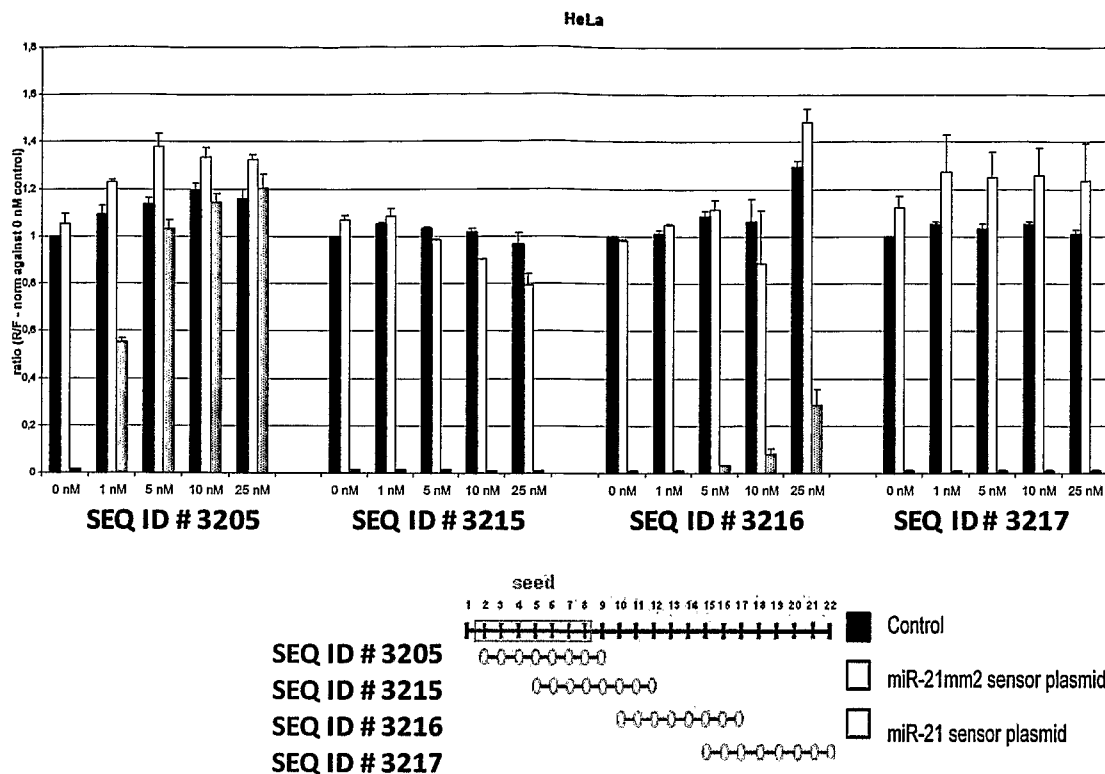

Figure 11

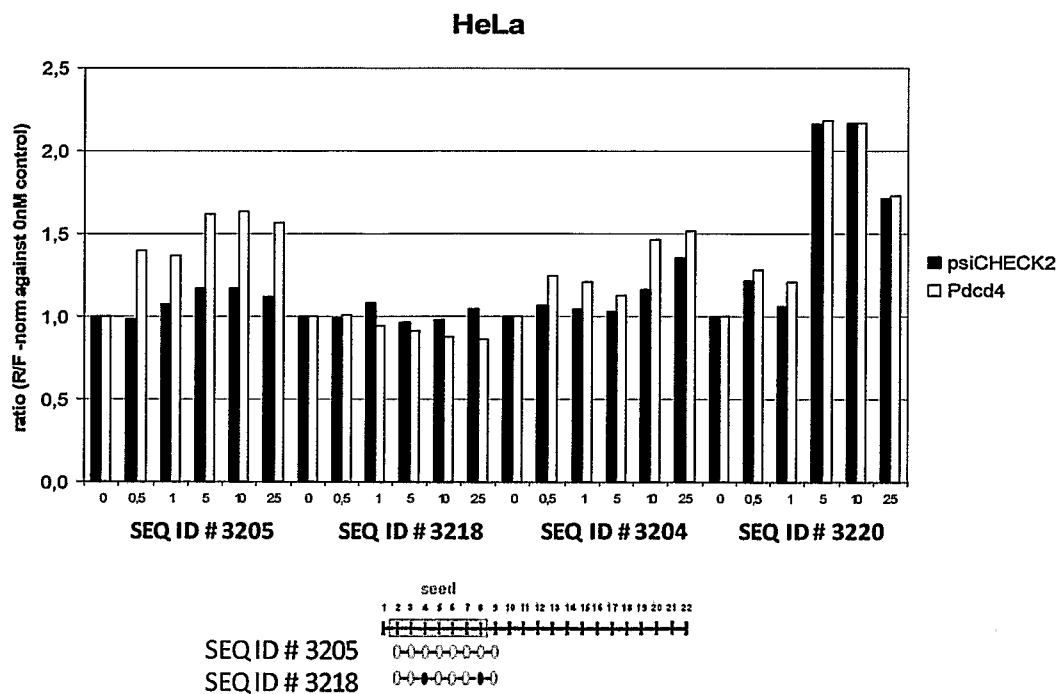

Figure 12

7/22

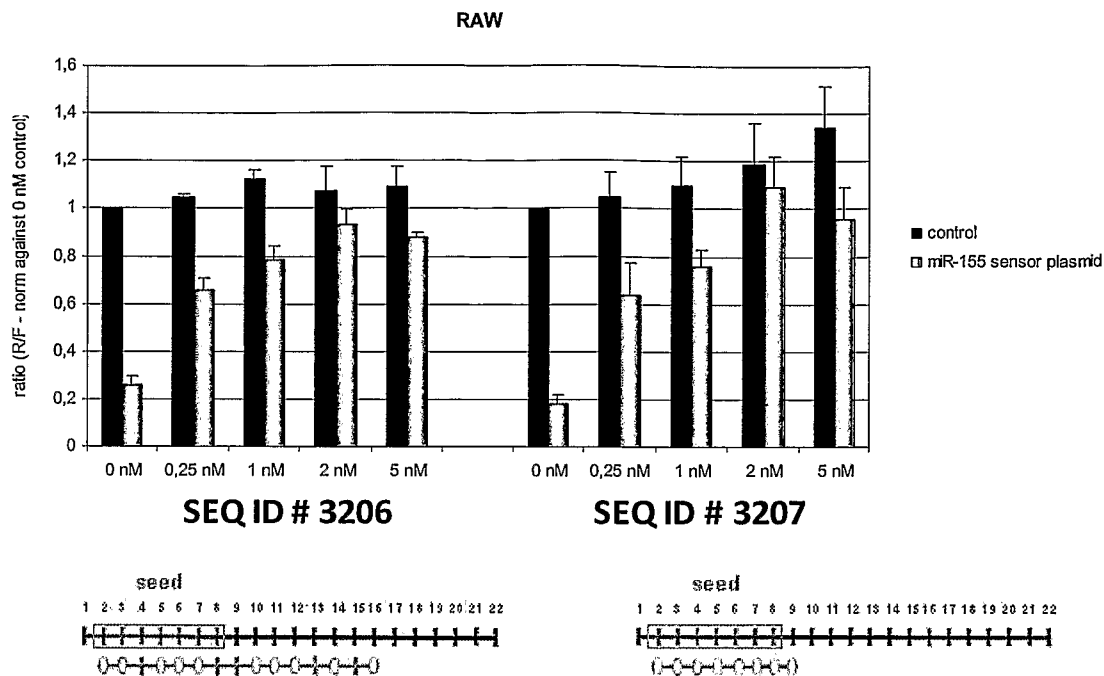

Figure 13

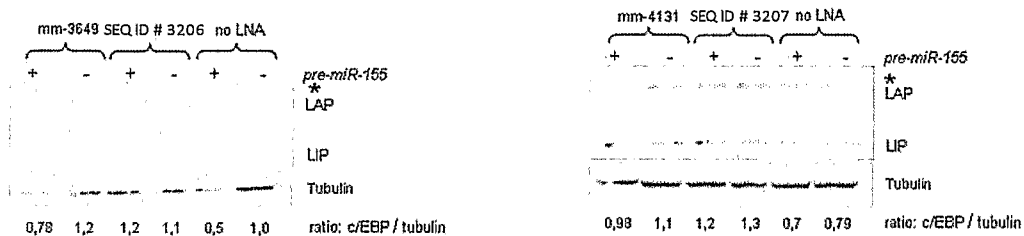

Figure 14

8/22

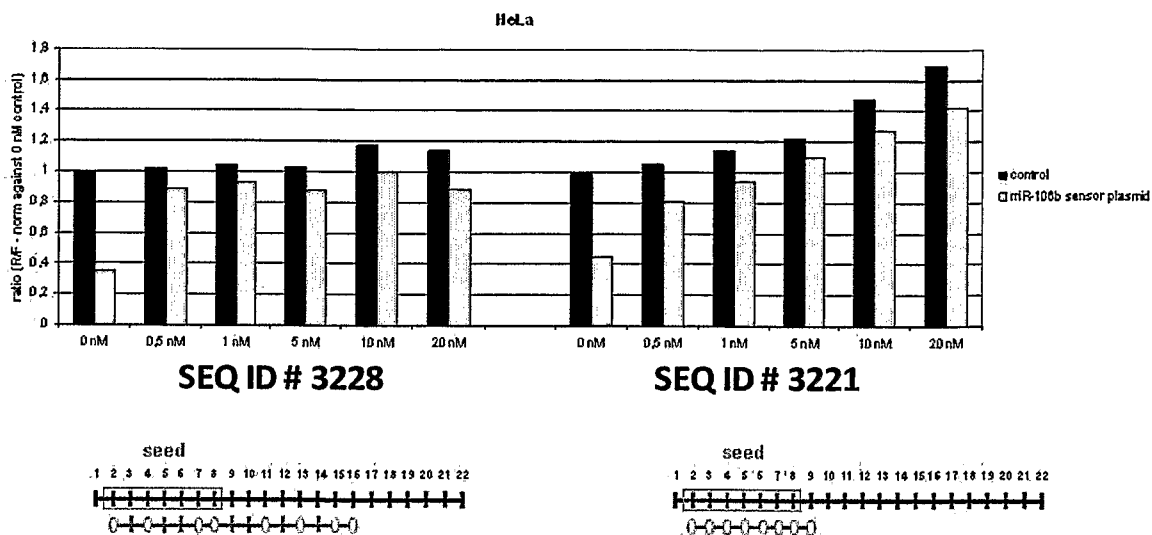

Figure 15

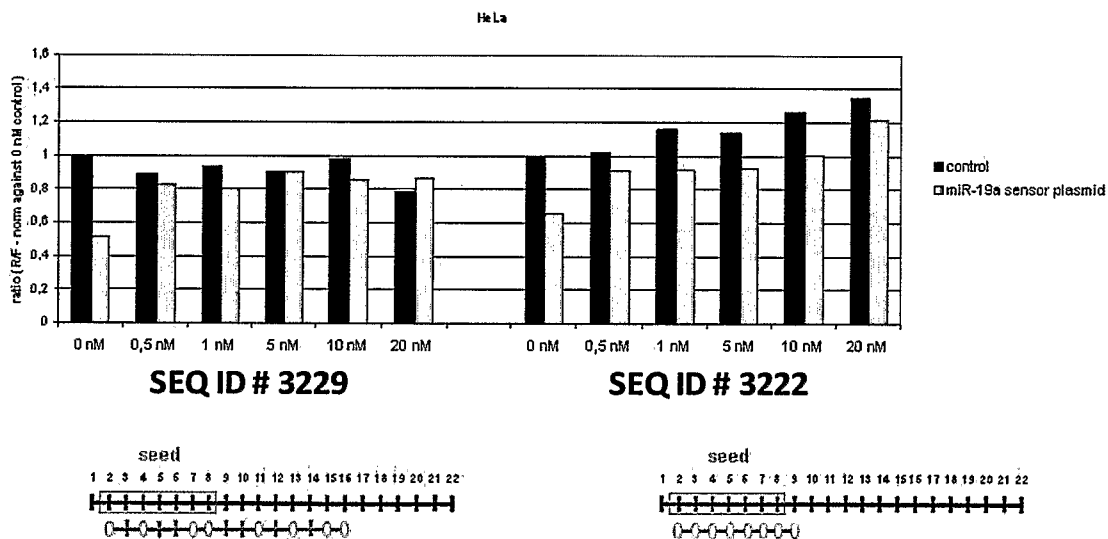

Figure 16

Seed - 7mer

<i>miR-221</i>	A	G	C	U	A	C	A	U	U	G	U	C	U	G	C	U	G	G	G	U	U	C	
<i>miR-222</i>	A	G	C	U	A	C	A	U	C	U	G	G	C	U	A	C	U	G	G	G	U	C	U

Figure 17

9/22

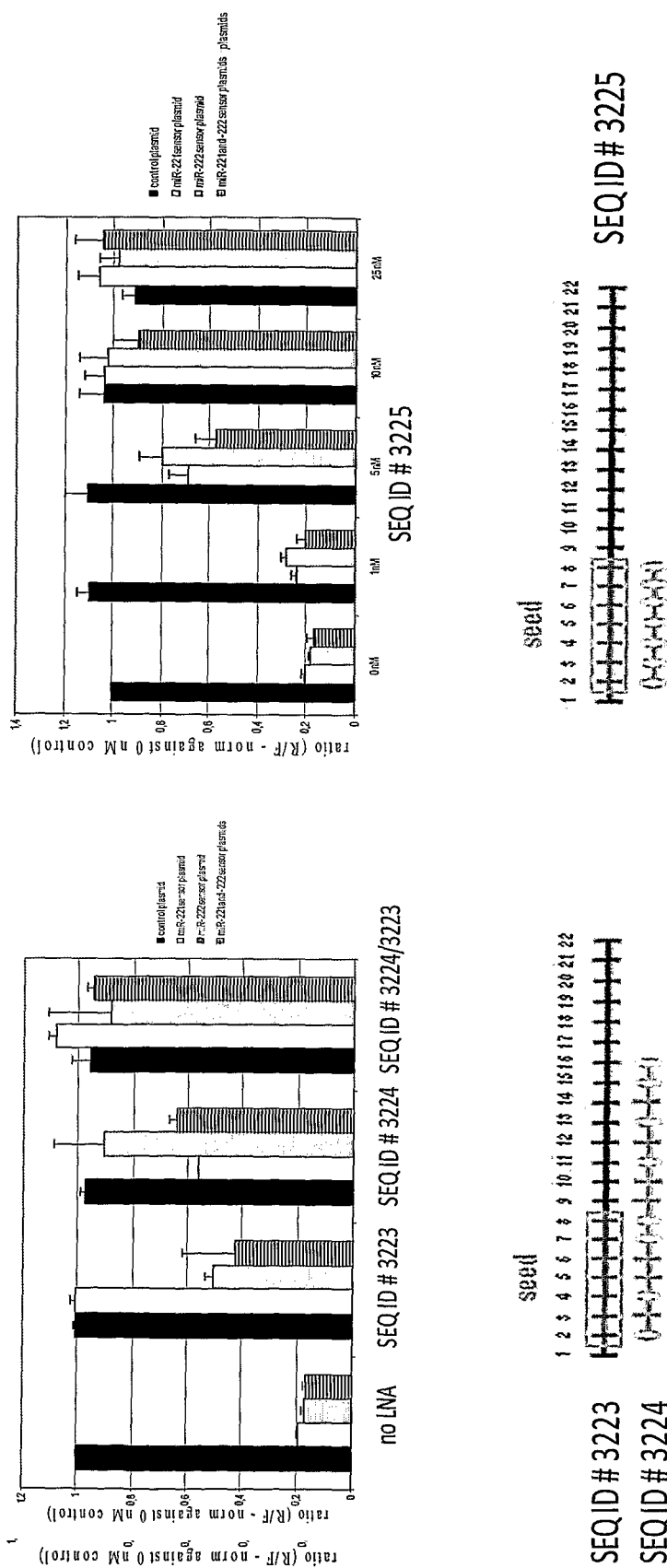

Figure 18

11/22

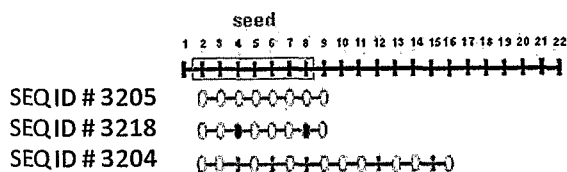
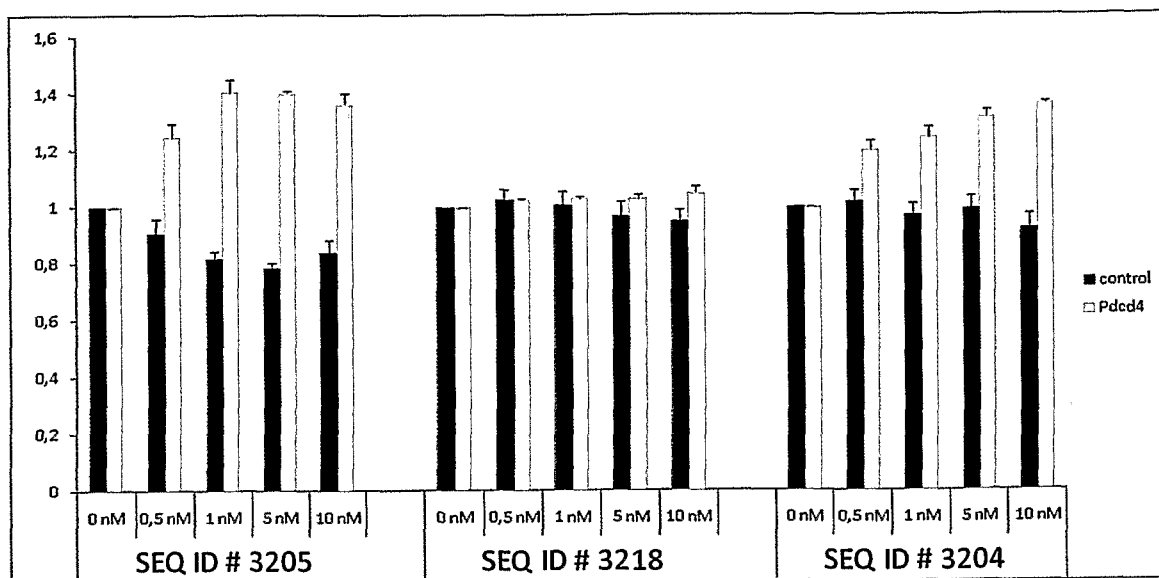
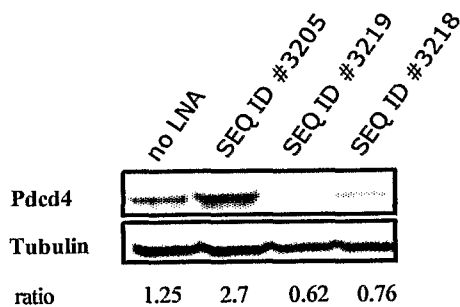

Figure 21



SEQ ID #3205 5'- GATAAGCT - 3'
 SEQ ID #3219 5'- CGTAATGA- 3'
 SEQ ID #3218 5'- GGTAAACT- 3'

Figure 22

12/22

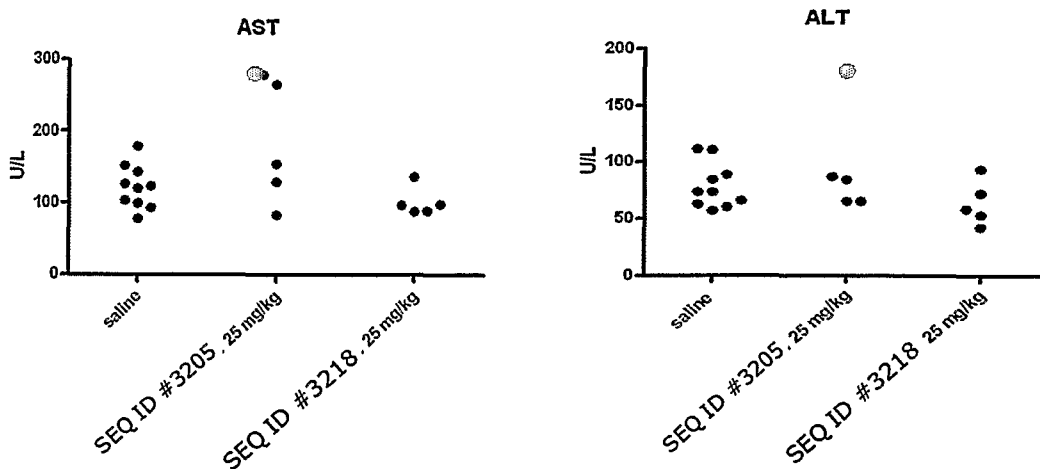

Figure 23

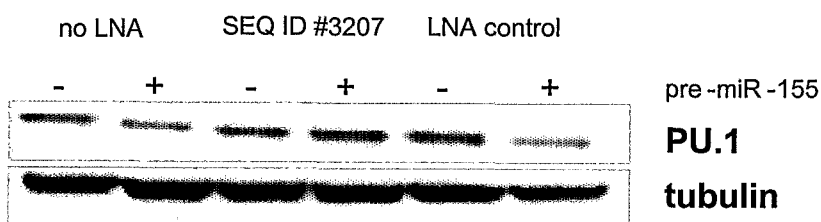
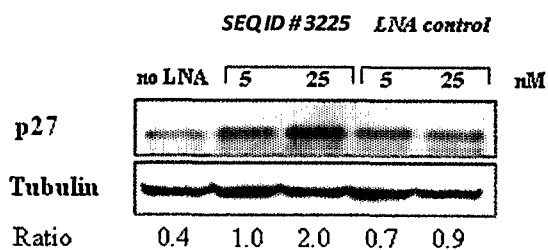

Figure 24



SEQ ID # 3225 5'- ATGTAGC -3'
 LNA control 5'- GTAGACT -3'

Figure 25

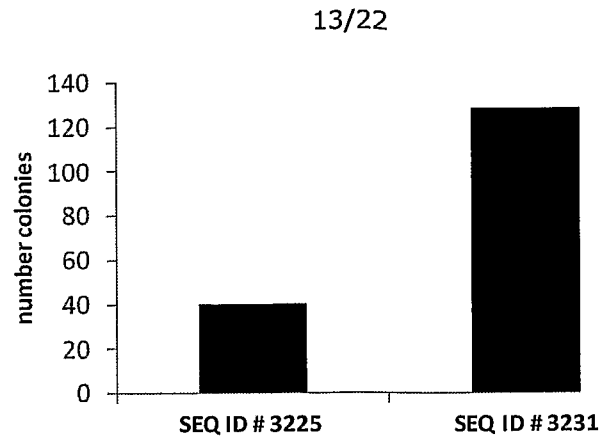

Figure 26

14/22

Name	Mature miRNA sequence	S (2-8)	ES (2-9)	NE (9-16)	Total (2-16)
let-7a	UGAGGUAGUAGGUUGU AUAGUU	N/A	N/A	N/A	N/A
let-7b	UGAGGUAGUAGGUUGU C UGGUU	0	0	0	0
let-7c	UGAGGUAGUAGGUUGU AU C GUU	0	0	0	0
let-7d	AGAGGUAGUAGGUUG C AUAGUU	0	0	1	1
let-7e	UGAGGUAG C AGGUUGU AUAGUU	0	1	0	1
let-7f	UGAGGUAGUAGAUUGU AUAGUU	0	0	1	1
let-7g	UGAGGUAGUAGUUGU A C AGUU	0	0	1	1
let-7i	UGAGGUAGUAGUUGU C UAGUU	0	0	1	1
miR-98	UGAGGUAGUAAGUUGU AU C GUU	0	0	1	1

Number	Compound	Sequence (5' to 3') ^a	Length (nt)	Complementary target(s)
1.	SEQ ID #3226	A-C-a-A-c-C-T-a-c-T-a-C-c-T-C	15	let-7a/b/c
2.	SEQ ID #3236	G-C-a-A-c-C-T-a-c-T-a-C-c-T-C	15	let-7d
3.	SEQ ID #3237	A-C-a-A-c-C-T-c-c-T-a-C-c-T-C	15	let-7e
4.	SEQ ID #3238	A-C-a-A-a-C-T-a-c-T-a-C-c-T-C	15	let-7g/i
5.	SEQ ID #3239	C-T-A-C-C-T-C	7	all members
6.	SEQ ID #3240	C-T-A-A-C-T-C	7	none
7.	SEQ ID #3227	A-C-T-A-C-C-T-C	8	all except let-7e
8.	SEQ ID #3232	T-A-C-C-T-C	6	all members
9.	SEQ ID #3234	T-N ₁ -C-T-A-C-C-T-C	9	all members ^b
10.	SEQ ID #3235	T-N ₂ -C-T-A-C-C-T-C	9	all members ^b

^aCapital and lower case letters denote LNA and DNA, respectively.

^bBoth 9-mers theoretically target all members since they contain 2 different universally hybridizing chemistries at their 2nd position.

Figure 27

15/22

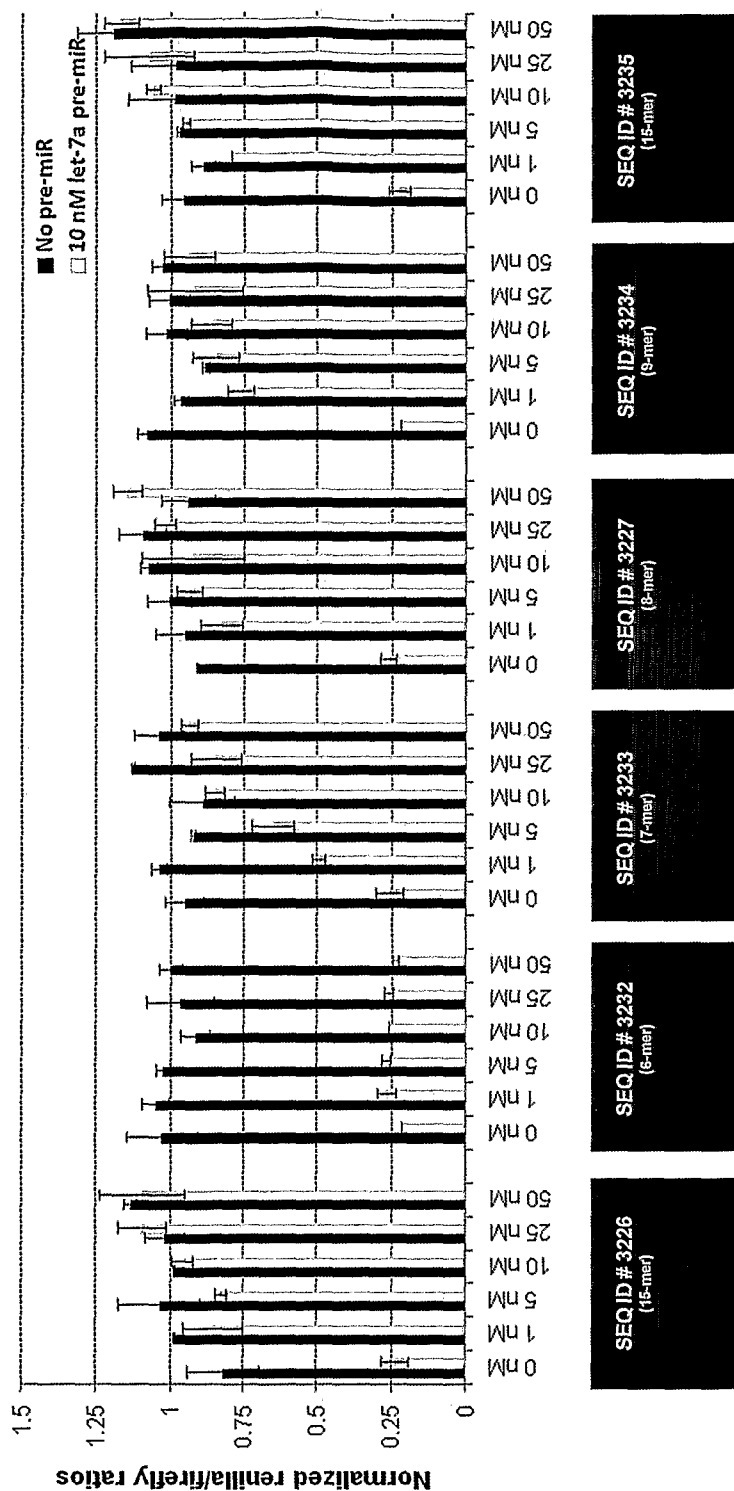

Figure 28

16/22

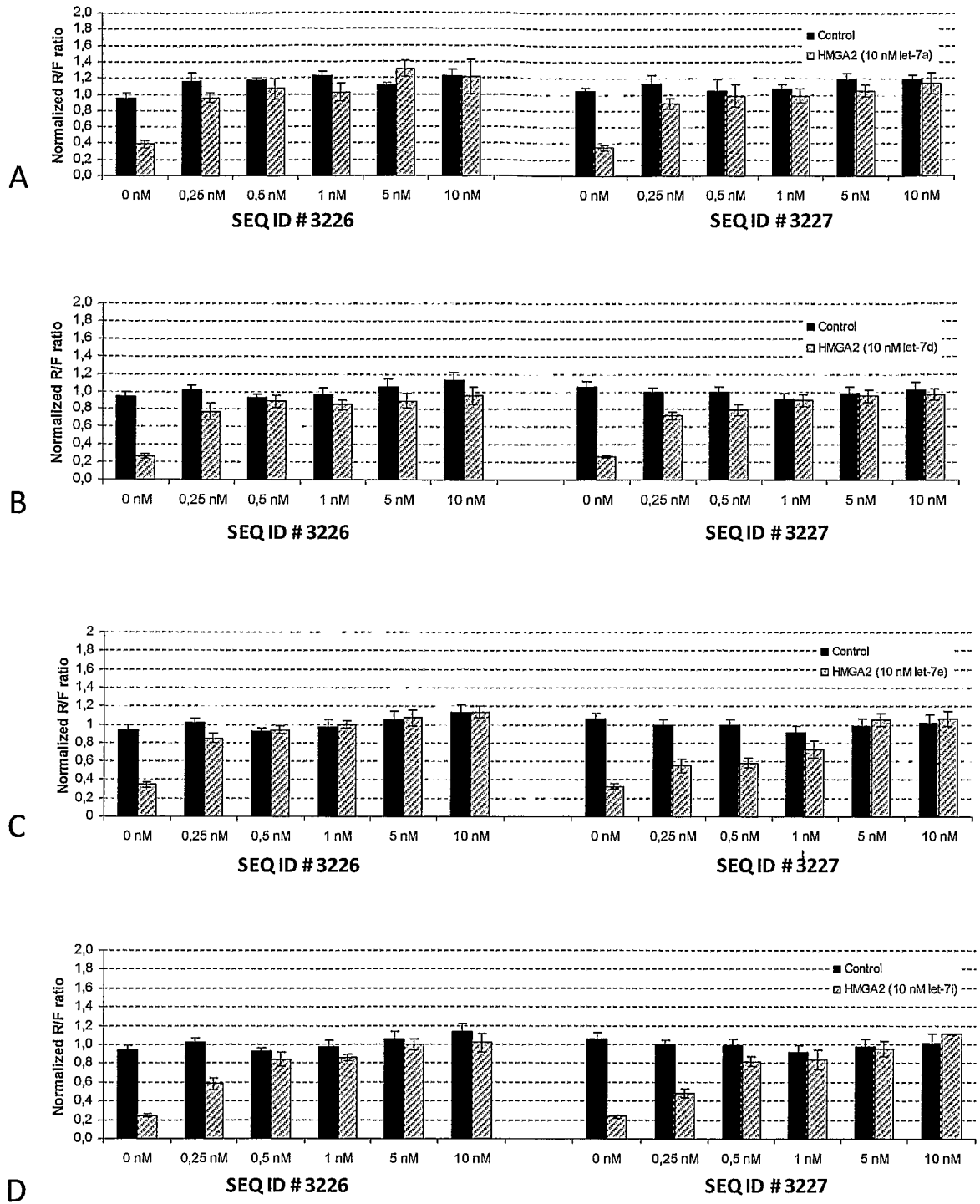

Figure 29

17/22

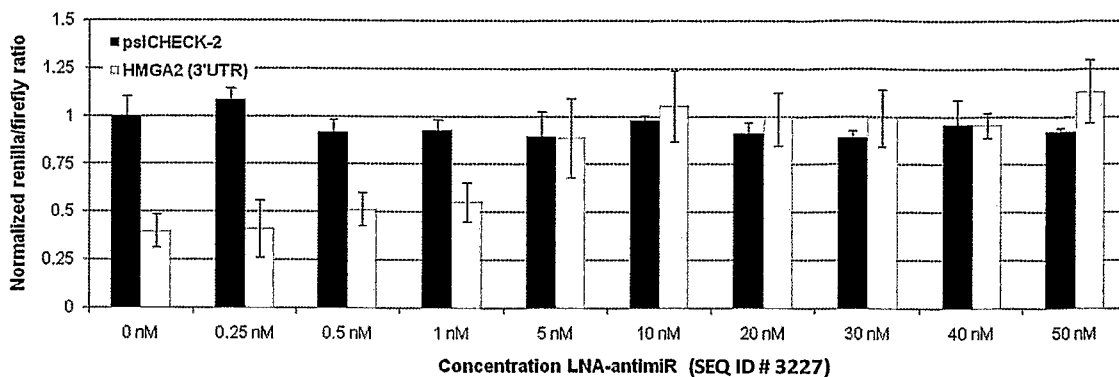

Figure 30

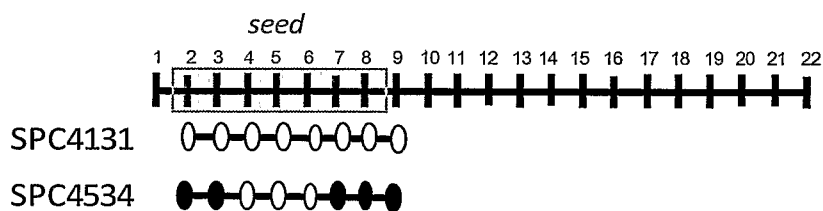
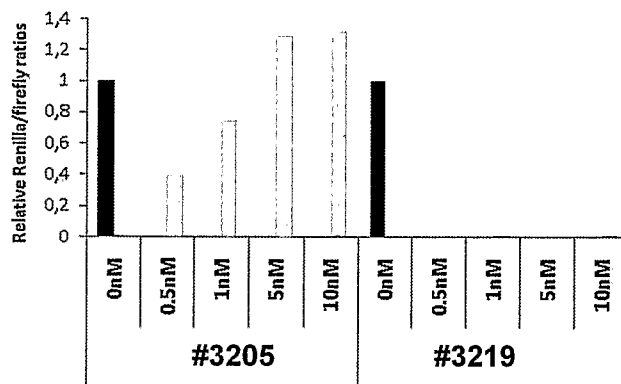

Figure 31.

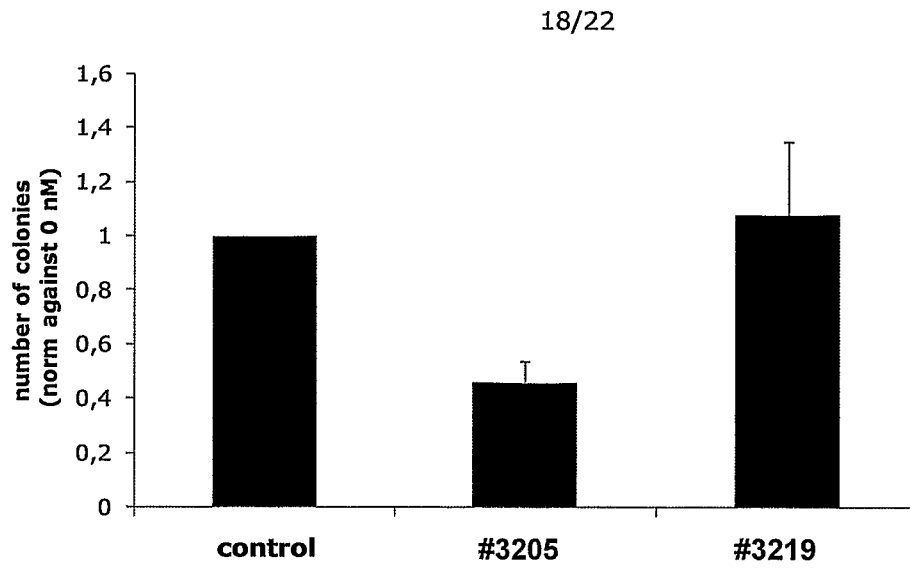

Figure 32.

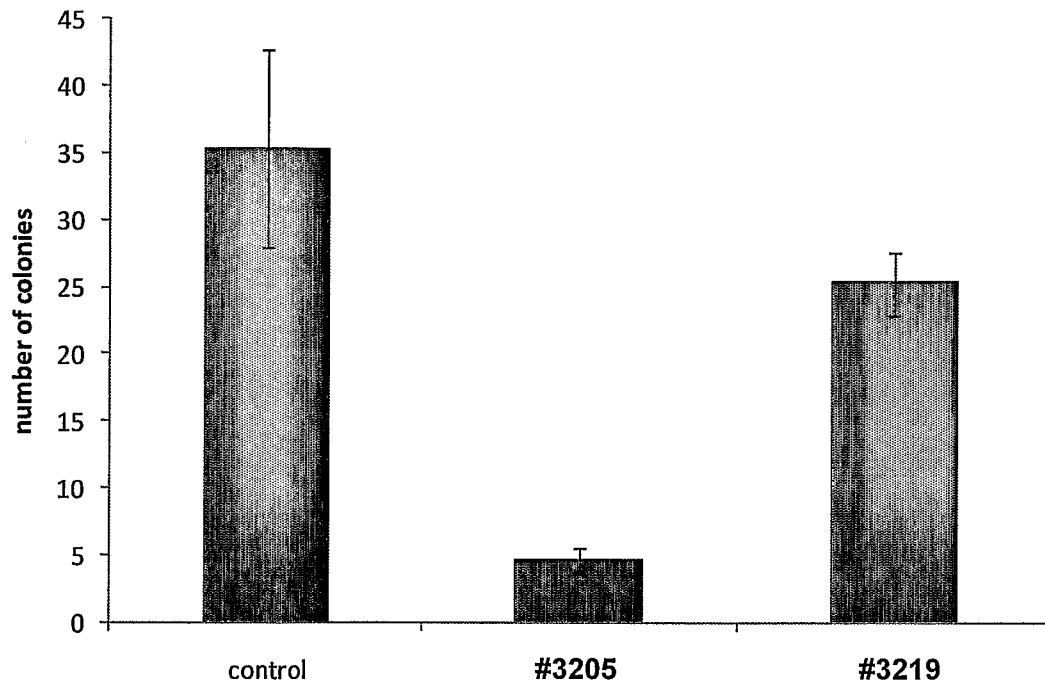
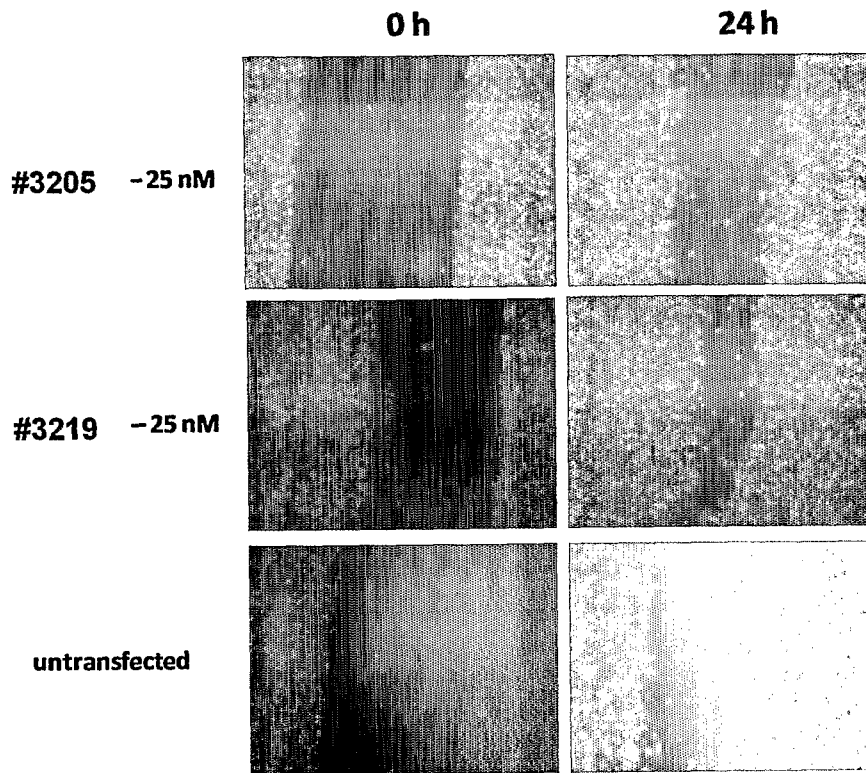
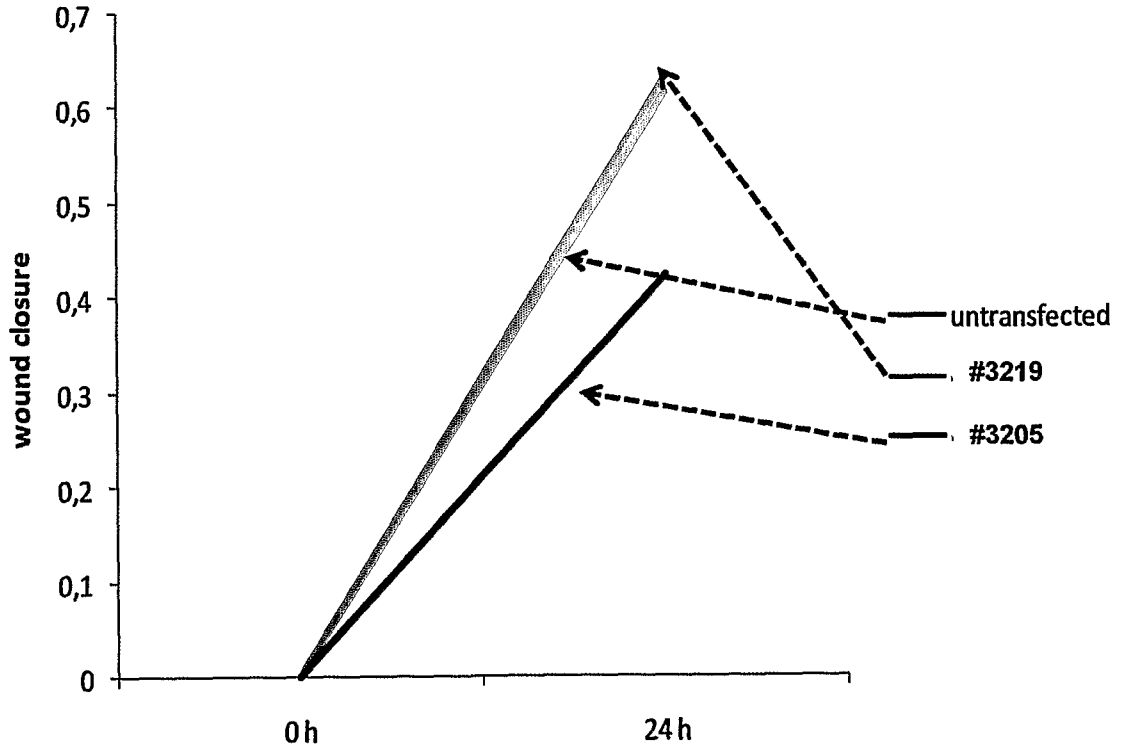

Figure 33.

19/22



(A)



(B)

Figure 34 A and B

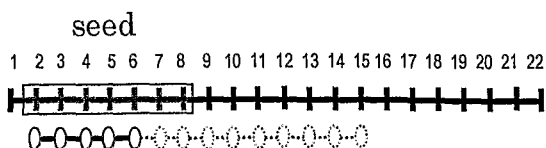
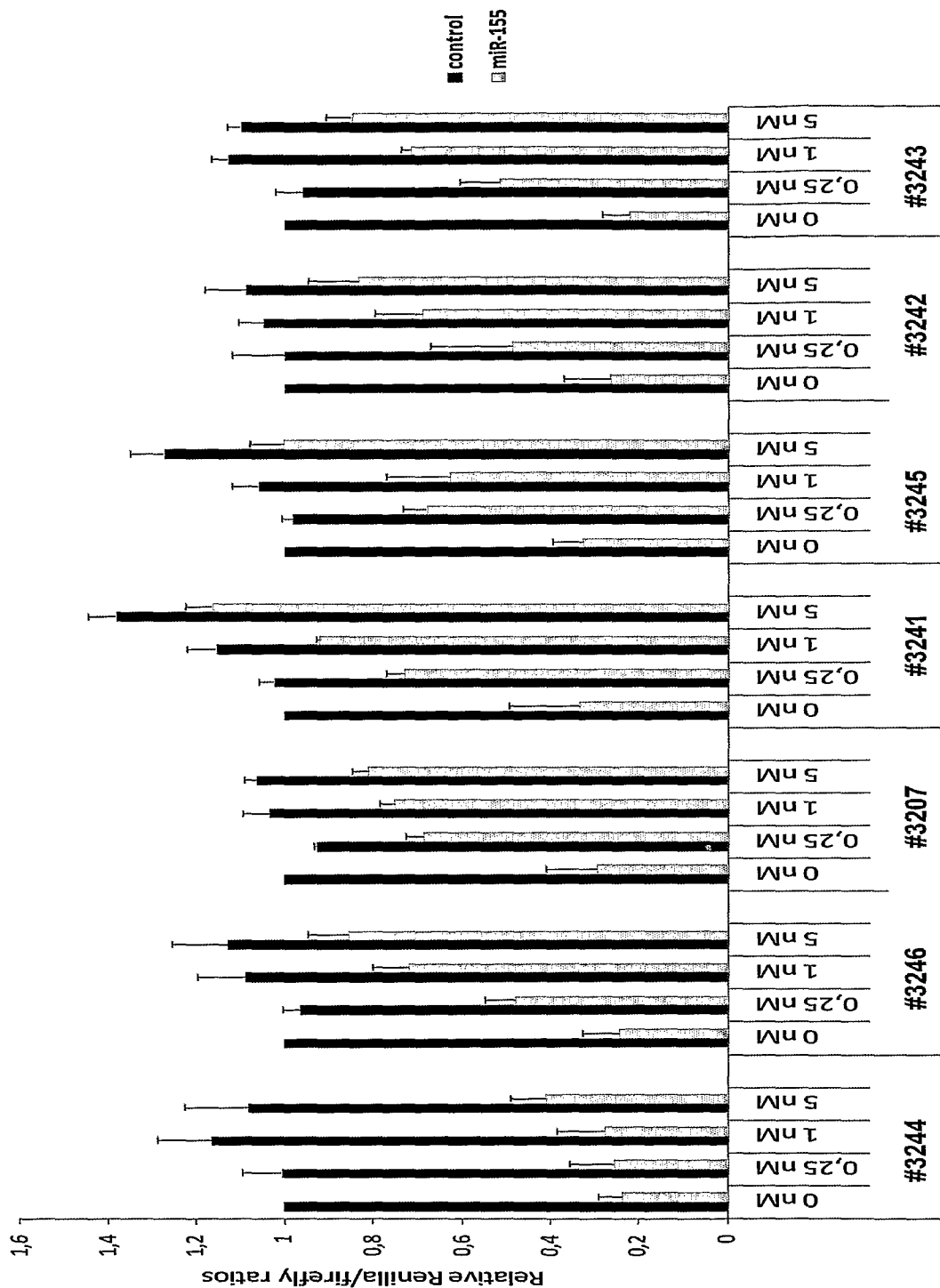
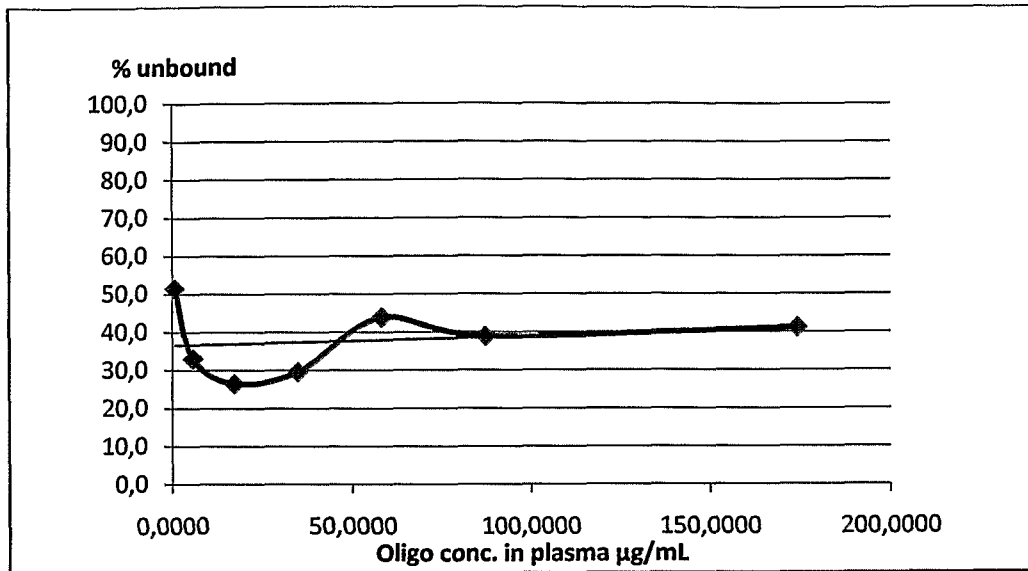
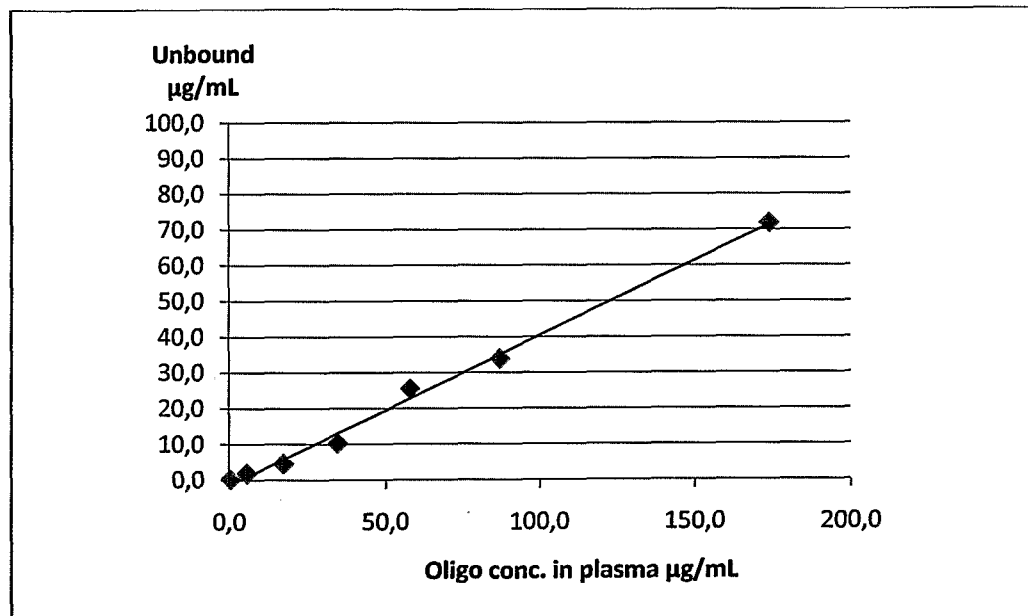

Figure 35.

21/22



A)



B)

Figure 36.

A

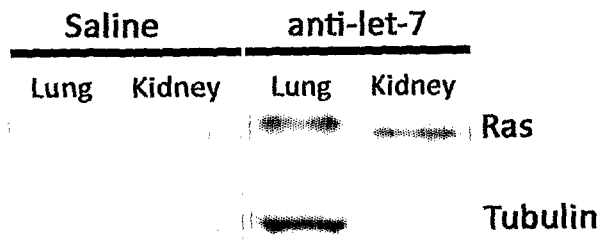

B

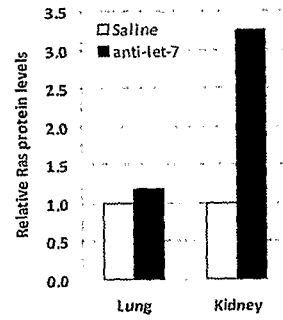

A

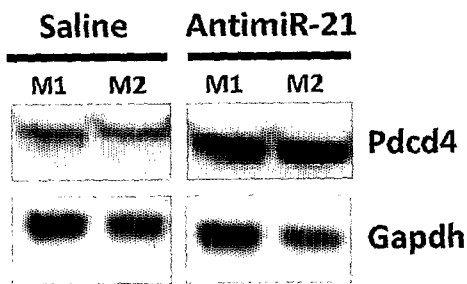

B

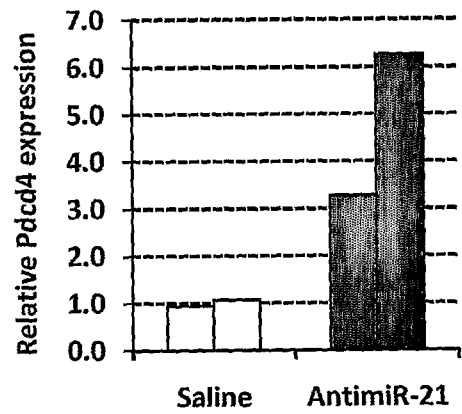

Figure 37.