



US0D1001408S

(12) **United States Design Patent**  
**Walter et al.**

(10) **Patent No.:** **US D1,001,408 S**

(45) **Date of Patent:** **\*\* Oct. 10, 2023**

- (54) **CART BASKET**
- (71) Applicant: **AMSA, Inc.**, Boulder, CO (US)
- (72) Inventors: **Ivor Michel Walter**, Boulder, CO (US);  
**Wilson Zeng**, Foshan (CN); **Brett Pardikes**, Boulder, CO (US)
- (73) Assignee: **AMSA, INC.**, Boulder, CO (US)
- (\*\*) Term: **15 Years**

- D365,904 S 1/1996 Adamson et al.
  - D367,348 S 2/1996 Basharat
  - 5,553,876 A 9/1996 Trubiano
  - 5,595,394 A 1/1997 Adamson
  - D465,313 S 11/2002 Le Marchand
  - 6,644,674 B2 11/2003 Simard
  - 6,832,768 B2 12/2004 Duchene et al.
  - 7,063,337 B2 6/2006 Russell et al.
- (Continued)

- (21) Appl. No.: **29/851,567**
- (22) Filed: **Aug. 30, 2022**

**Related U.S. Application Data**

- (62) Division of application No. 29/666,920, filed on Oct. 17, 2018.
- (51) **LOC (14) Cl.** ..... **12-02**
- (52) **U.S. Cl.**  
USPC ..... **D34/27**
- (58) **Field of Classification Search**  
USPC ..... D34/12, 17, 20-23, 26, 27; 280/33.993,  
280/33.994, 33.991, 33.992  
CPC .. B62B 3/005; B62B 5/00; B62B 3/02; B62B  
7/00; B62B 1/00  
See application file for complete search history.

**References Cited**

**U.S. PATENT DOCUMENTS**

- 2,764,419 A 9/1956 Enders
- 2,964,326 A 12/1960 Schray
- 3,885,806 A 5/1975 Trubiano
- D246,301 S 11/1977 Trubiano
- 4,125,270 A 11/1978 Trubiano
- 4,356,651 A 11/1982 Barlow
- 4,742,943 A 5/1988 Trubiano
- 5,149,114 A 9/1992 Lewandowski et al.
- D331,135 S 11/1992 Lewandowski et al.
- 5,385,357 A 1/1995 Trubiano
- 5,435,582 A 7/1995 Davidson

**OTHER PUBLICATIONS**

Applicant AMSA, Inc. DBA VersaCart Systems Brochure for ACE Spring Convention 2020. 4 pages.  
(Continued)

*Primary Examiner* — Gino Colan  
(74) *Attorney, Agent, or Firm* — POLSON  
INTELLECTUAL PROPERTY LAW, PC; Margaret  
Polson

(57) **CLAIM**

The ornamental design for a cart basket, as shown and described.

**DESCRIPTION**

FIG. 1 is a front side isometric view of our new design for a cart basket.  
FIG. 2 is a left side elevation view of FIG. 1.  
FIG. 3 is a right side elevation view of FIG. 1.  
FIG. 4 is a front elevation view of FIG. 1.  
FIG. 5 is a back elevation view of FIG. 1.  
FIG. 6 is a top plan view of FIG. 1.  
FIG. 7 is a bottom plan view of FIG. 1; and,  
FIG. 8 is a back side isometric view of FIG. 1.  
Contour is shown with grey scale shading, no difference in color, texture or material is claimed. The features shown in light grey in the drawing depict environmental subject matter and unclaimed borders only and form no part of the claimed design.

**1 Claim, 8 Drawing Sheets**



(56) **References Cited**

U.S. PATENT DOCUMENTS

7,168,711	B2	1/2007	Ondrasik	
D542,997	S	5/2007	Coderre	
7,322,582	B2	1/2008	Prather et al.	
D576,372	S	9/2008	Walter	
D577,172	S	9/2008	Coderre	
D580,619	S	11/2008	Walter	
D583,523	S	12/2008	Deal et al.	
D596,366	S *	7/2009	Giampavolo	D34/17
D605,823	S	12/2009	Walter	
D606,723	S	12/2009	Walter	
D608,971	S	1/2010	Tuncel	
D608,972	S	1/2010	Tuncel	
D615,723	S	5/2010	Walter	
D616,680	S *	6/2010	Snider	D6/513
D633,269	S	2/2011	Walter	
D638,602	S	5/2011	Walter	
D645,631	S	9/2011	Walter	
D742,088	S	10/2015	Walter	
D756,586	S	5/2016	Magnusson	
D770,716	S	11/2016	Giampavolo et al.	
D796,771	S *	9/2017	Bacallao	D34/27
D800,986	S	10/2017	Magnusson	
D802,869	S	11/2017	Sherman et al.	
D805,711	S	12/2017	Magnusson	
D806,341	S	12/2017	Magnusson	
D806,342	S	12/2017	Magnusson	
D822,304	S	7/2018	Walter	
D839,525	S	1/2019	Magnusson	
D878,000	S	3/2020	Walter et al.	
D917,203	S *	4/2021	Goodman	D6/566
2004/0201187	A1	10/2004	Ondrasik	
2006/0273536	A1	12/2006	Ondrasik	
2008/0265534	A1	10/2008	Ondrasik	
2009/0261545	A1	10/2009	Jones	

OTHER PUBLICATIONS

Applicant AMSA, Inc. DBA VersaCart Systems Brochure for Do It Best Spring Market 2020. 6 pages.  
 Applicant AMSA, Inc. DBA VersaCart Systems Brochure for Emery Jensen Spring Show 2020. 2 pages.  
 Applicant AMSA, Inc. DBA VersaCart Systems Brochure for Spring 2020 trade shows. 6 pages.  
 Applicant AMSA, Inc. DBA VersaCart Systems Brochure for Orgill Spring Market 2020. 6 pages.  
 Applicant AMSA, Inc. DBA VersaCart Systems True Value flyer Spring 2020. 6 pages.  
 Applicant AMSA, Inc. DBA VersaCart Systems Brochure for ACE Fall Show 2020. 4 pages.  
 Applicant AMSA, Inc. DBA VersaCart Systems Brochure for Emery Jensen Fall Show 2020. 4 pages.  
 Applicant AMSA, Inc. DBA VersaCart Systems Brochure for Orgill Fall Market 2020. 6 pages.  
 Applicant AMSA, Inc. DBA VersaCart Systems Brochure for Do It Best Fall Market 2020. 4 pages.  
 Applicant AMSA, Inc. DBA VersaCart Systems Brochure for UNFI 2020 National Sales Expo. 5 pages.  
 Applicant AMSA, Inc. DBA VersaCart Systems Brochure for ACE Spring Show 2021. 4 pages.  
 Applicant AMSA, Inc. DBA VersaCart Systems Brochure for Do It Best Spring Market 2021. 4 pages.  
 Applicant AMSA, Inc. DBA VersaCart Systems Hardware Flyer, Spring Deals 2021. 2 pages.  
 Applicant AMSA, Inc. DBA VersaCart Systems Brochure for Orgill Spring Market 2021. 4 pages.  
 Applicant AMSA, Inc. DBA VersaCart Systems True Value flyer Spring 2021. 4 pages.  
 Applicant AMSA, Inc. DBA VersaCart Systems Hardware Flyer, Fall 2021. 4 pages.  
 Applicant AMSA, Inc. DBA VersaCart Systems Brochure for Orgill Fall Market 2021. 6 pages.

Applicant AMSA, Inc. DBA VersaCart Systems Brochure for Do It Best Fall Market 2021. 6 pages.  
 Applicant AMSA, Inc. DBA VersaCart Systems Brochure for ACE RSC, Fall 2021. 1 page.  
 Applicant AMSA, Inc. DBA VersaCart Systems True Value RSC flyer, Fall 2021. 1 page.  
 Applicant AMSA, Inc. DBA VersaCart Systems Brochure for ACE Spring Show 2022. 6 pages.  
 Applicant AMSA, Inc. DBA VersaCart Systems Brochure for Do It Best Spring Market 2022. 6 pages.  
 Applicant AMSA, Inc. DBA VersaCart Systems Brochure for Orgill Spring Market 2022. 6 pages.  
 Applicant AMSA, Inc. DBA VersaCart Systems True Value flyer Spring 2022. 6 pages.  
 Applicant AMSA, Inc. DBA VersaCart Systems flyer Spring 2022. 6 pages.  
 Pending Design U.S. Appl. No. 29/815,105, filed Nov. 11, 2021, applicant AMSA, Inc.  
 Applicant AMSA, Inc. DBA VersaCart Systems Brochure for Do It Best Fall Market 2022. 6 pages.  
 Applicant AMSA, Inc. DBA VersaCart Systems Brochure for Orgill Fall Market 2022. 6 pages.  
 Applicant AMSA, Inc. DBA VersaCart Systems True Value flyer Fall 2022. 6 pages.  
 Applicant AMSA, Inc. DBA VersaCart Systems flyer Fall 2022. 6 pages.  
 Applicant AMSA, Inc. DBA VersaCart Systems Canadian Products Parade flyer Fall 2022. 4 pages.  
 InStore Product Model 5BB7—printout from website <https://instorecorp.com/assets/5bb7m-en-low.pdf>, accessed Nov. 28, 2022. 1 page.  
 NStore Product Model S4—[www.instorecorp.com](http://www.instorecorp.com). Date unknown. 1 page.  
 InStore Product Model S3—[www.instorecorp.com](http://www.instorecorp.com). Date unknown. 1 page.  
 Wanzl Tango Series Shopping Trolley—printout of website [https://www.wanzl.com/en\\_DE/products/shopping-trolleys/tango-series/](https://www.wanzl.com/en_DE/products/shopping-trolleys/tango-series/) captured Sep. 20, 2016. 6 pages.  
 Wanzl EL Series Shopping Trolley—printout of website [https://www.wanzl.com/en\\_DE/products/shopping-trolleys/el-series/](https://www.wanzl.com/en_DE/products/shopping-trolleys/el-series/) captured Sep. 20, 2016. 10 pages.  
 Applicant AMSA, Inc. DBA VersaCart Systems Brochure for Orgill Spring Dealer Market 2015. 6 pages.  
 Applicant AMSA, Inc. DBA VersaCart Systems Brochure for Orgill Fall Dealer Market 2015. 6 pages.  
 Applicant AMSA, Inc. DBA VersaCart Systems Brochure for Orgill Fall Market 2012. 4 pages.  
 Applicant AMSA, Inc. DBA VersaCart Systems Brochure for Orgill Spring Dealer Market 2014. 6 pages.  
 Applicant AMSA, Inc. DBA VersaCart Systems Brochure for Orgill Fall Dealer Market 2014. 6 pages.  
 Applicant AMSA, Inc. DBA VersaCart Systems Retail & Distribution Catalog 2008. 50 pages.  
 Applicant AMSA, Inc. DBA VersaCart Systems Brochure for ACE Spring Convention 2013. 4 pages.  
 Applicant AMSA, Inc. DBA VersaCart Systems Brochure for ACE Spring Convention 2014. 4 pages.  
 Applicant AMSA, Inc. DBA VersaCart Systems Brochure for ACE Spring Convention 2015. 4 pages.  
 Applicant AMSA, Inc. DBA VersaCart Systems Brochure for ACE Spring Convention 2016. 4 pages.  
 Applicant AMSA, Inc. DBA VersaCart Systems Brochure for ACE Spring Market 2012. 2 pages.  
 Applicant AMSA, Inc. DBA VersaCart Systems Brochure for ACE Spring Convention 2017. 4 pages.  
 Applicant AMSA, Inc. DBA VersaCart Systems Brochure for Do It Best Spring Market 2017. 6 pages.  
 Applicant AMSA, Inc. DBA VersaCart Systems Brochure for Orgill Spring Dealer Market 2016. 6 pages.  
 Applicant AMSA, Inc. DBA VersaCart Systems Brochure for True Value Spring Reunion 2017. 2 pages.  
 Applicant AMSA, Inc. DBA VersaCart Systems SuperValu Expo flyer Aug. 3, 2016. 2 pages.

(56)

**References Cited**

OTHER PUBLICATIONS

Applicant AMSA, Inc. DBA VersaCart Systems Unified Expo flyer Aug. 2016. 2 pages.  
Applicant AMSA, Inc. DBA VersaCart Systems True Value flyer Fall Reunion 2017. 2 pages.  
Applicant AMSA, Inc. DBA VersaCart Systems True Value flyer Fall Reunion 2016. 2 pages.  
Applicant AMSA, Inc. DBA VersaCart Systems Brochure for ACE Fall Convention 2016. 4 pages.  
Applicant AMSA, Inc. DBA VersaCart Systems Brochure for ACE Fall Convention 2017. 4 pages.  
Applicant AMSA, Inc. DBA VersaCart Systems Brochure for Do It Best Fall Market 2016. 6 pages.  
Applicant AMSA, Inc. DBA VersaCart Systems Brochure for Do It Best Fall Market 2017. 6 pages.  
Applicant AMSA, Inc. DBA VersaCart Systems Brochure for Orgill Fall Dealer Market Las Vegas 2016. 6 pages.  
Applicant AMSA, Inc. DBA VersaCart Systems Brochure for Orgill Fall Dealer Market Boston 2016. 6 pages.  
Applicant AMSA, Inc. DBA VersaCart Systems Brochure for Orgill Spring Dealer Market 2018. 6 pages.  
Applicant AMSA, Inc. DBA VersaCart Systems Brochure for Do It Best Spring Market 2018. 6 pages.  
Applicant AMSA, Inc. DBA VersaCart Systems True Value flyer Spring 2018. 6 pages.  
Applicant AMSA, Inc. DBA VersaCart Systems Brochure for ACE Spring Convention 2018. 4 pages.  
Applicant AMSA, Inc. DBA VersaCart Systems Brochure for Do It Best Fall Market 2018. 6 pages.

Applicant AMSA, Inc. DBA VersaCart Systems True Value flyer Fall 2018. 6 pages.  
Applicant AMSA, Inc. DBA VersaCart Systems Brochure for ACE Fall Convention 2018. 4 pages.  
Applicant AMSA, Inc. DBA VersaCart Systems Brochure for Orgill Fall Dealer Market 2018. 6 pages.  
Applicant AMSA, Inc. DBA VersaCart Systems Brochure for ACE Spring Convention 2019. 4 pages.  
Applicant AMSA, Inc. DBA VersaCart Systems Brochure for Do It Best Spring Market 2019. 6 pages.  
Applicant AMSA, Inc. DBA VersaCart Systems Material Handling Brochure 2019. 3 pages.  
Applicant AMSA, Inc. DBA VersaCart Systems Brochure for NGA Spring Show 2019. 2 pages.  
Applicant AMSA, Inc. DBA VersaCart Systems Brochure for Orgill Spring Market 2019. 6 pages.  
Applicant AMSA, Inc. DBA VersaCart Systems Shopping Baskets Brochure 2019. 3 pages.  
Applicant AMSA, Inc. DBA VersaCart Systems Shopping Carts Brochure 2019. 3 pages.  
Applicant AMSA, Inc. DBA VersaCart Systems True Value flyer Spring 2019. 6 pages.  
Applicant AMSA, Inc. DBA VersaCart Systems Brochure for ACE Fall Convention 2019. 4 pages.  
Applicant AMSA, Inc. DBA VersaCart Systems Brochure for Do It Best Fall Market 2019. 6 pages.  
Applicant AMSA, Inc. DBA VersaCart Systems Brochure for Orgill Fall Market 2019. 6 pages.  
Applicant AMSA, Inc. DBA VersaCart Systems True Value flyer Fall 2019. 6 pages.

\* cited by examiner



Fig. 1

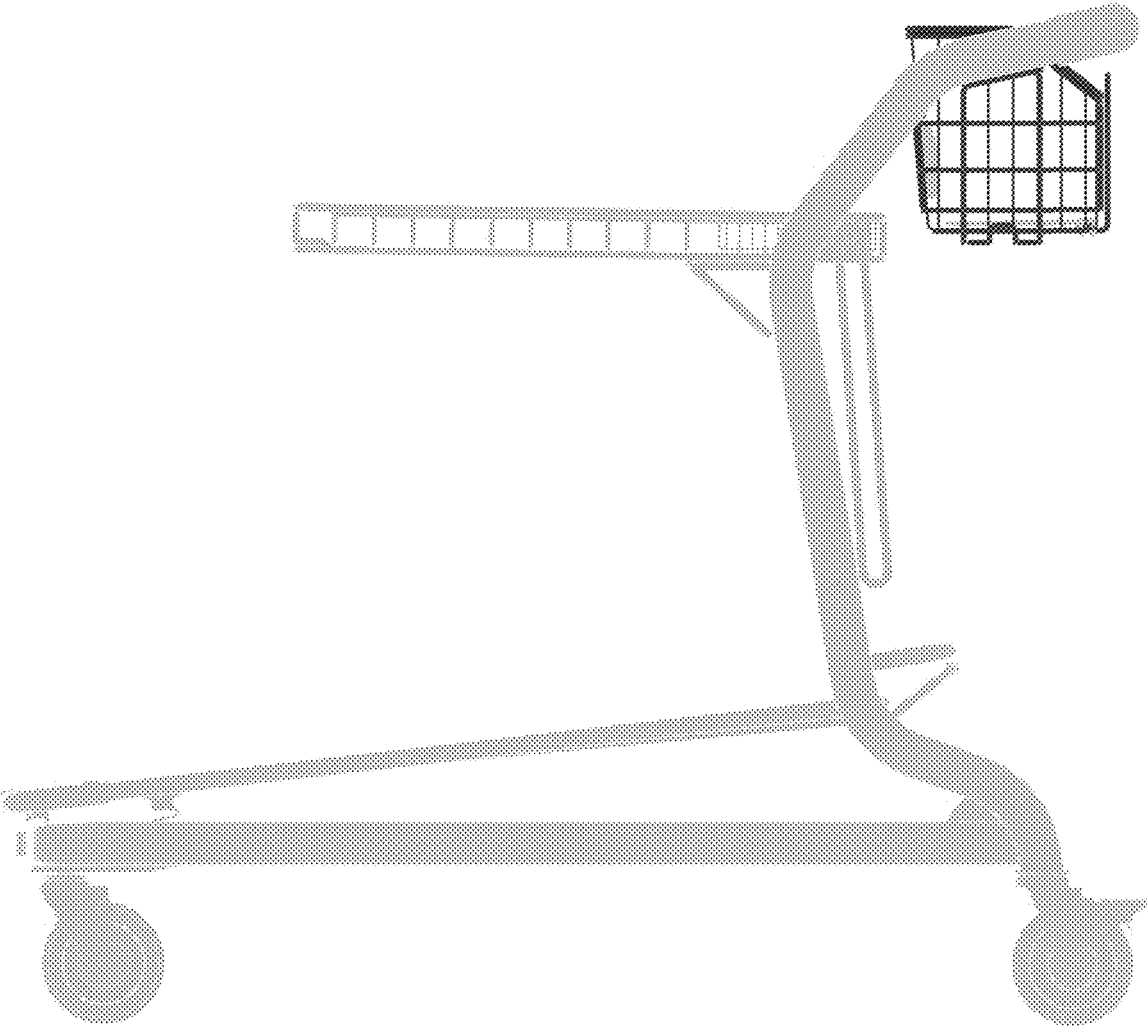

Fig. 2

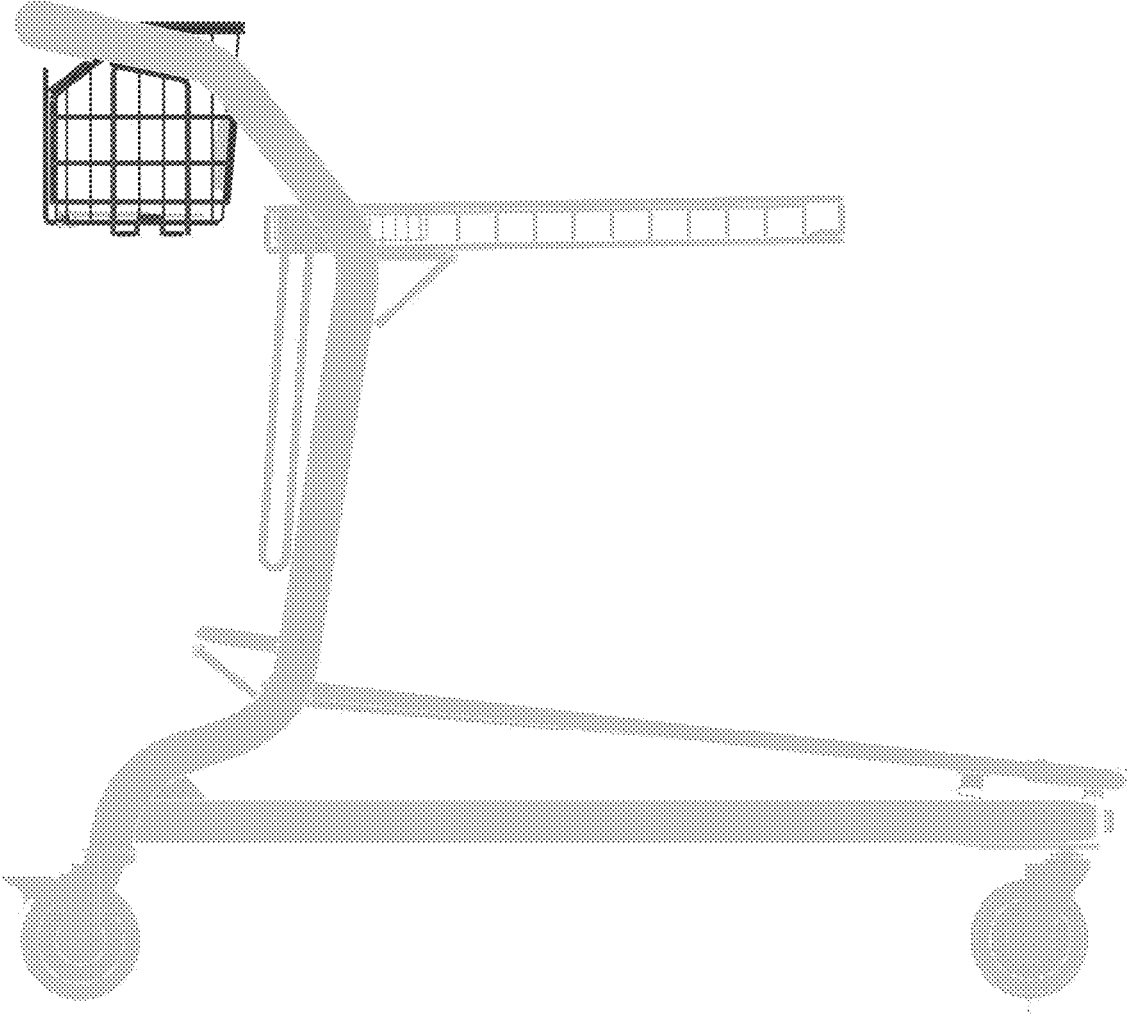

Fig. 3

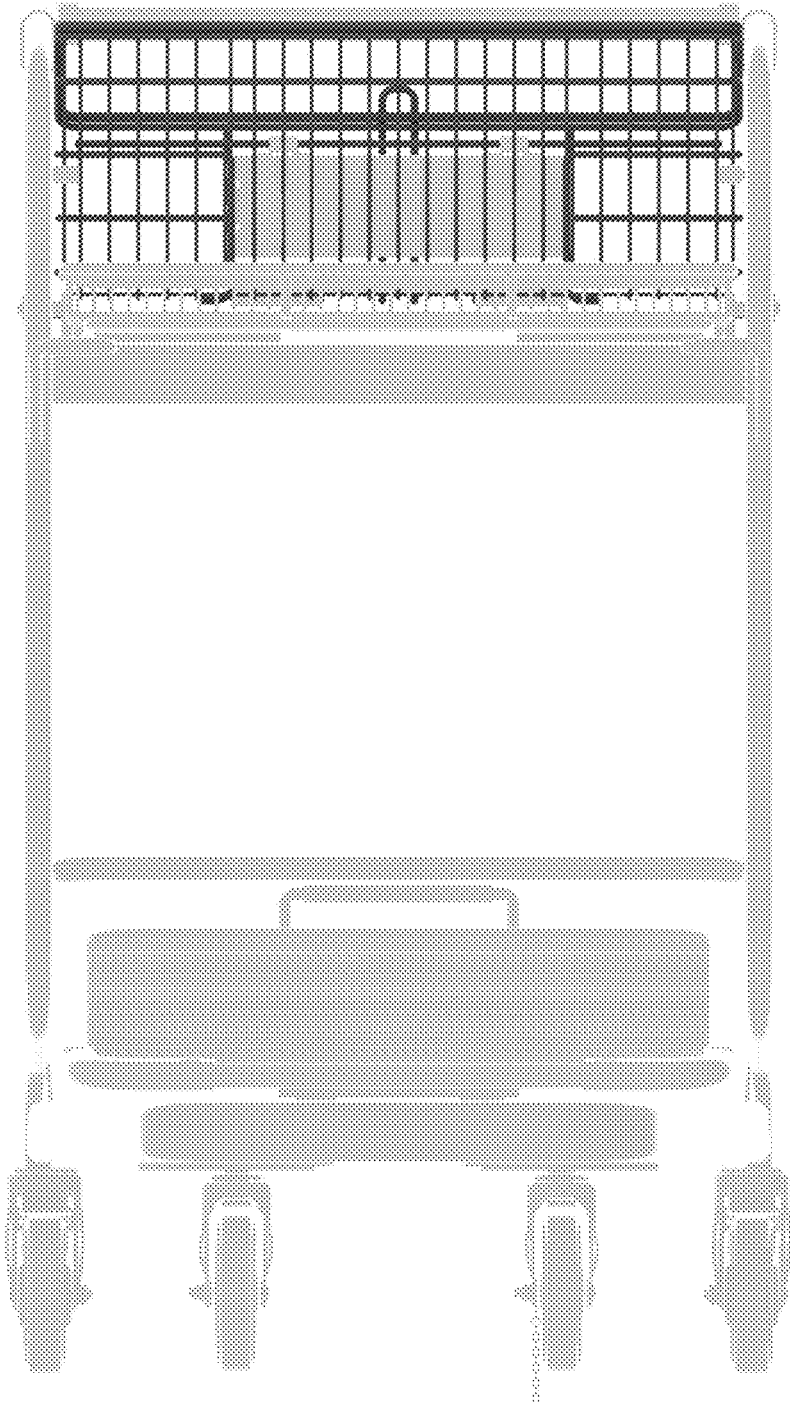

Fig. 4

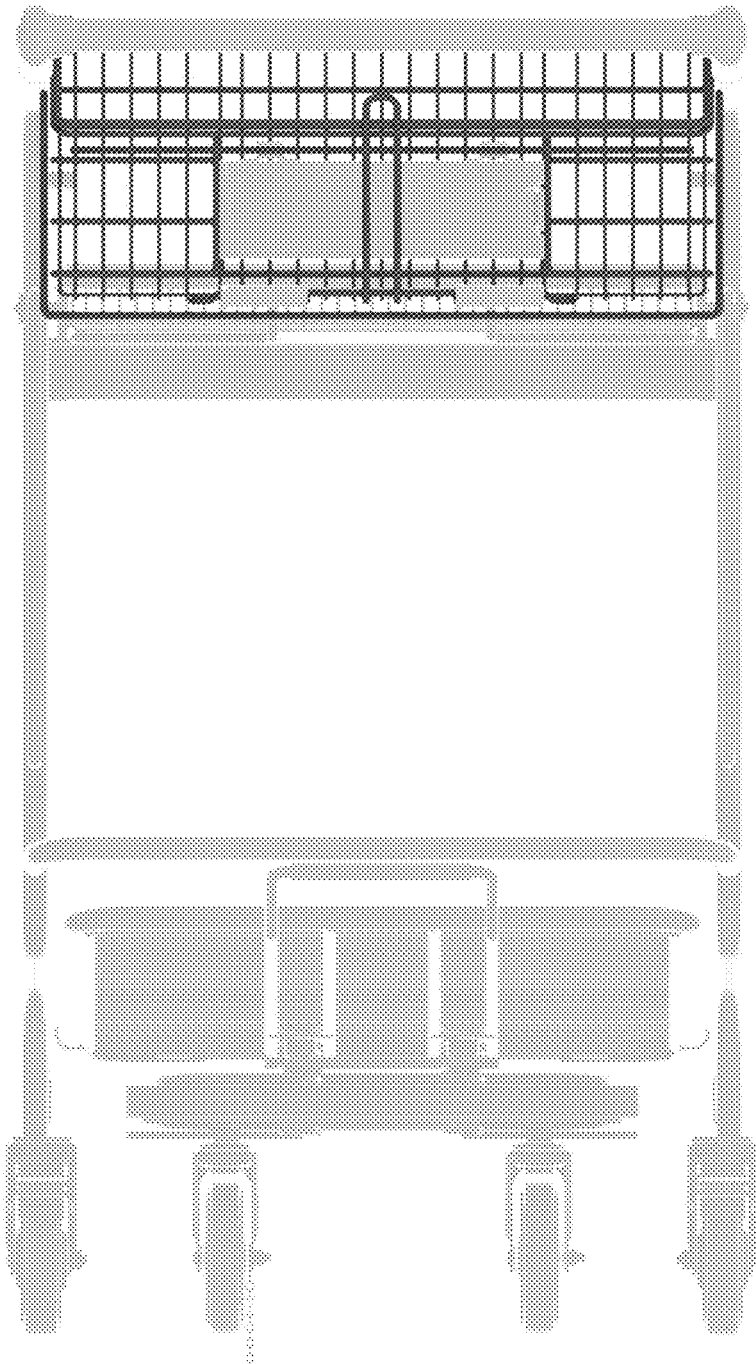

Fig. 5



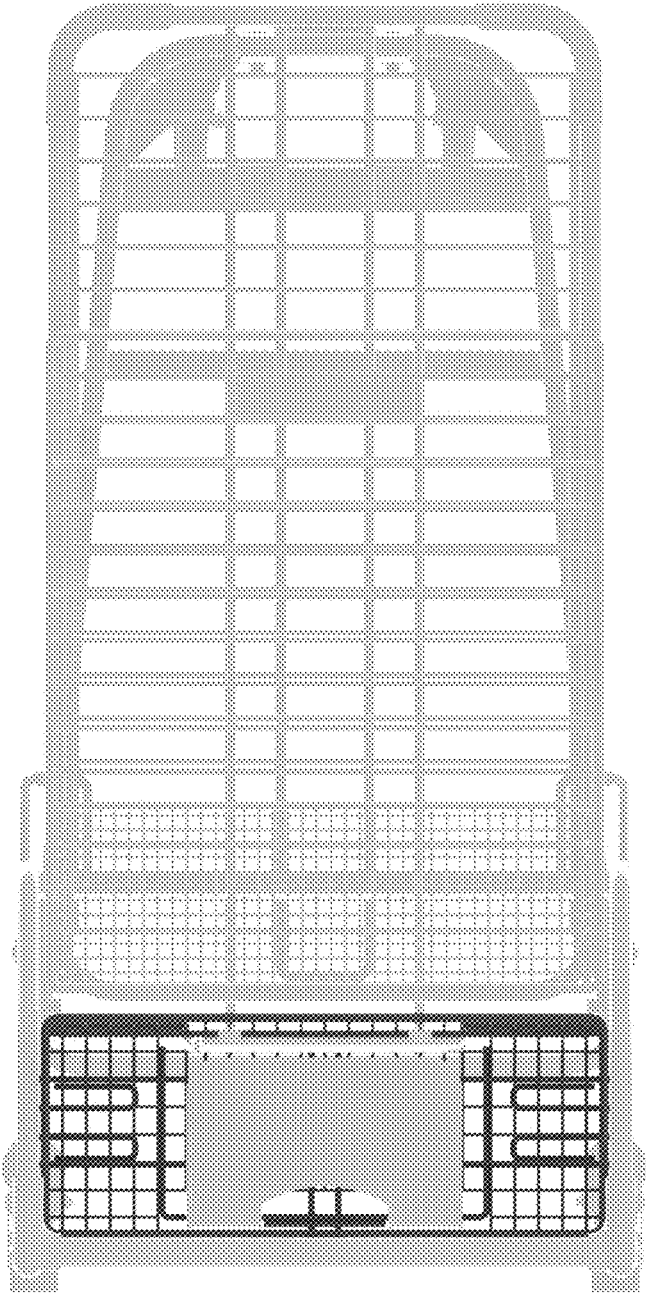

Fig. 6

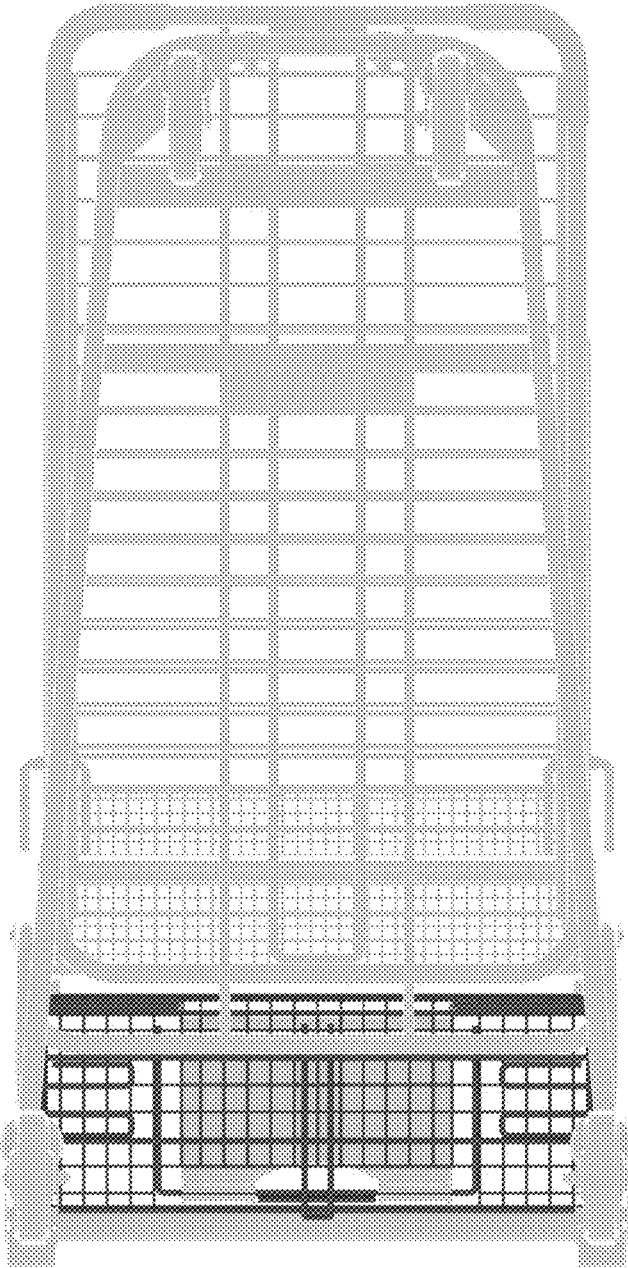

Fig. 7

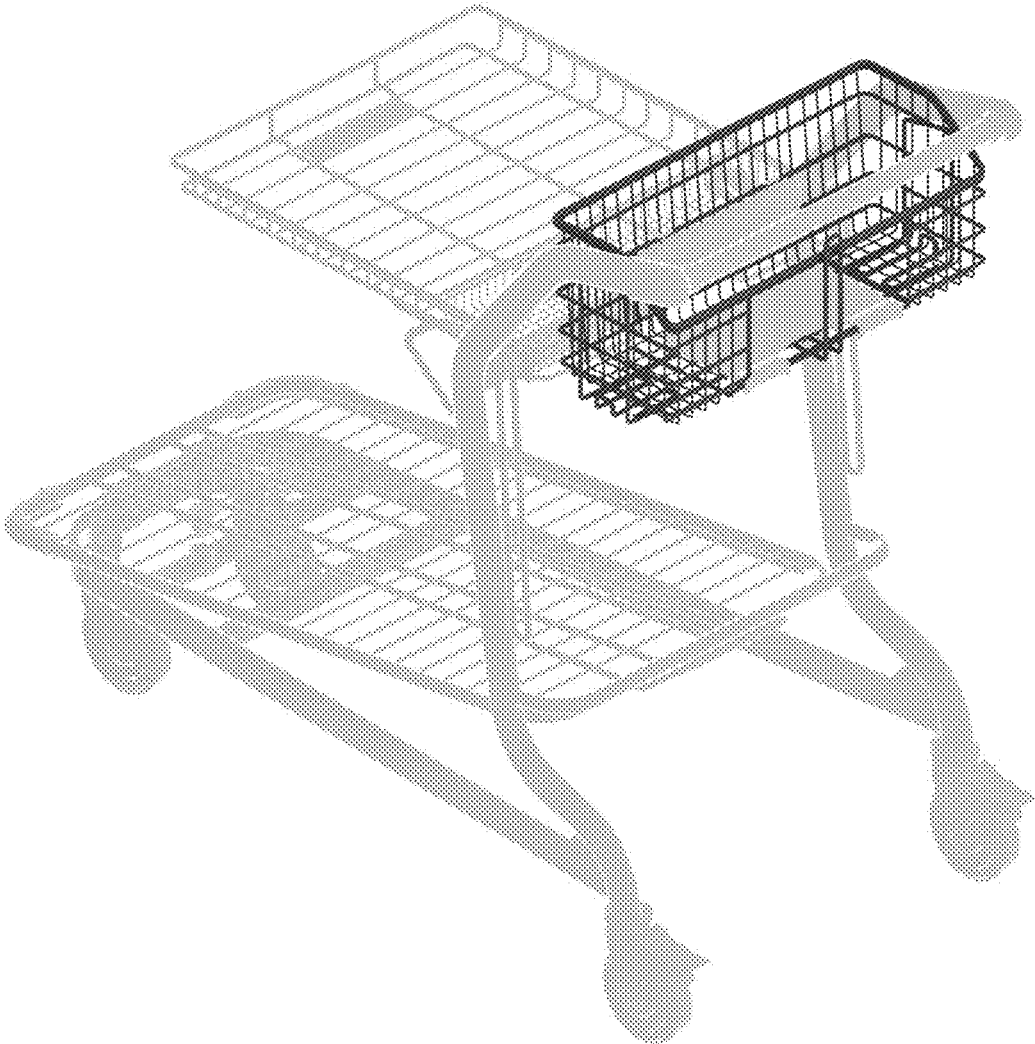

Fig. 8