



US0D1047858S

(12) **United States Design Patent**
Manzoni

(10) **Patent No.:** **US D1,047,858 S**

(45) **Date of Patent:** **** Oct. 22, 2024**

(54) **VEHICLE WHEEL RIM**

(71) Applicant: **FERRARI S.p.A.**, Modena (IT)

(72) Inventor: **Flavio Manzoni**, Modena (IT)

(73) Assignee: **FERRARI S.p.A.**, Modena (IT)

(**) Term: **15 Years**

(21) Appl. No.: **29/900,456**

(22) Filed: **Aug. 21, 2023**

Related U.S. Application Data

(62) Division of application No. 35/515,626, filed on Aug. 19, 2022 (U.S. filing date under 35 U.S.C. 384), and having an international filing date of Aug. 19, 2022, now Pat. No. Des. 1,010,534.

(30) **Foreign Application Priority Data**

Feb. 22, 2022 (WO) WIPO113944

(51) **LOC (14) Cl.** **12-16**

(52) **U.S. Cl.**
USPC **D12/209**

(58) **Field of Classification Search**

USPC D12/204-213, 501; D21/563, 779
CPC B60B 7/00; B60B 7/01; B60B 7/02; B60B 7/04; B60B 7/06; B60B 3/02; B60B 3/04; B60B 3/06; B60B 3/10; B60B 1/00; B60B 1/08; B60B 1/10; B60B 1/12; B60B 21/00

See application file for complete search history.

(56) **References Cited**

U.S. PATENT DOCUMENTS

D576,536 S * 9/2008 Aroney D12/209
D671,877 S * 12/2012 Roura D12/209

D684,516 S * 6/2013 Bennion D12/209
D700,565 S * 3/2014 Gonzalez D12/209
D751,016 S * 3/2016 Valencia Pollex D12/209
D769,164 S * 10/2016 Valencia Pollex D12/209
D781,765 S * 3/2017 Bjerke D12/209
D799,397 S * 10/2017 Le Vay D12/211
D826,130 S * 8/2018 Myrberg D12/209
D847,066 S * 4/2019 Bucher D12/209
D875,017 S * 2/2020 Valencia Pollex D12/209
D876,307 S * 2/2020 Setter D12/209
D914,570 S * 3/2021 Chan D12/209

OTHER PUBLICATIONS

Ferrari Portofino M, Published Sep. 16, 2020 [online], [retrieved on Jun. 17, 2024]. Retrieved from the Internet: <https://www.motor1.com/news/444253/2021-ferrari-portofino-m-reveal/> (Year: 2020).*

* cited by examiner

Primary Examiner — Mark A Goodwin

Assistant Examiner — Adam C Mager

(74) *Attorney, Agent, or Firm* — Cowan, Liebowitz & Latman, P.C.; Anastasia Zhadina

(57) **CLAIM**

The ornamental design for a vehicle wheel rim as shown and described.

DESCRIPTION

FIG. 1 is a front perspective view of the vehicle wheel rim showing my design;
FIG. 2 is a front elevation view thereof;
FIG. 3 is a left side view thereof;
FIG. 4 is a right side view thereof;
FIG. 5 is a top plan view thereof; and,
FIG. 6 is a bottom view thereof.

1 Claim, 6 Drawing Sheets

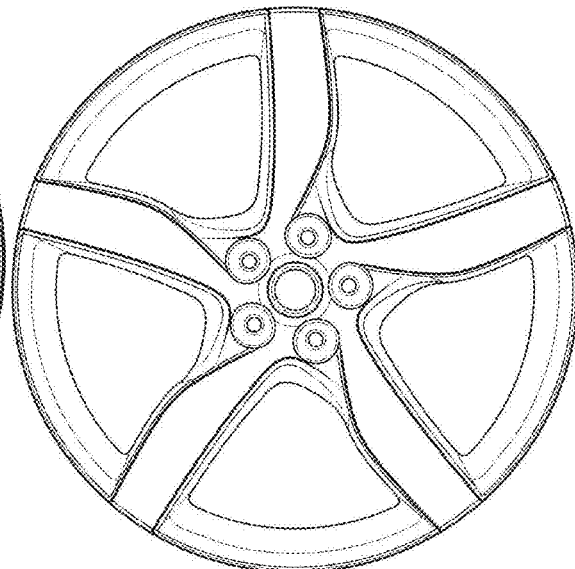
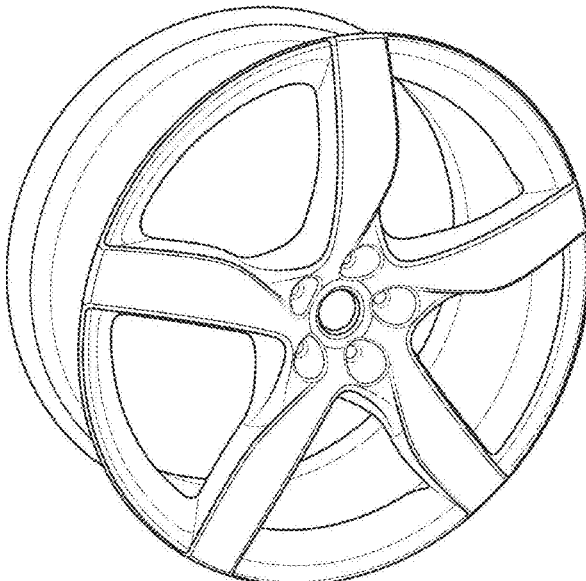

FIG. 1

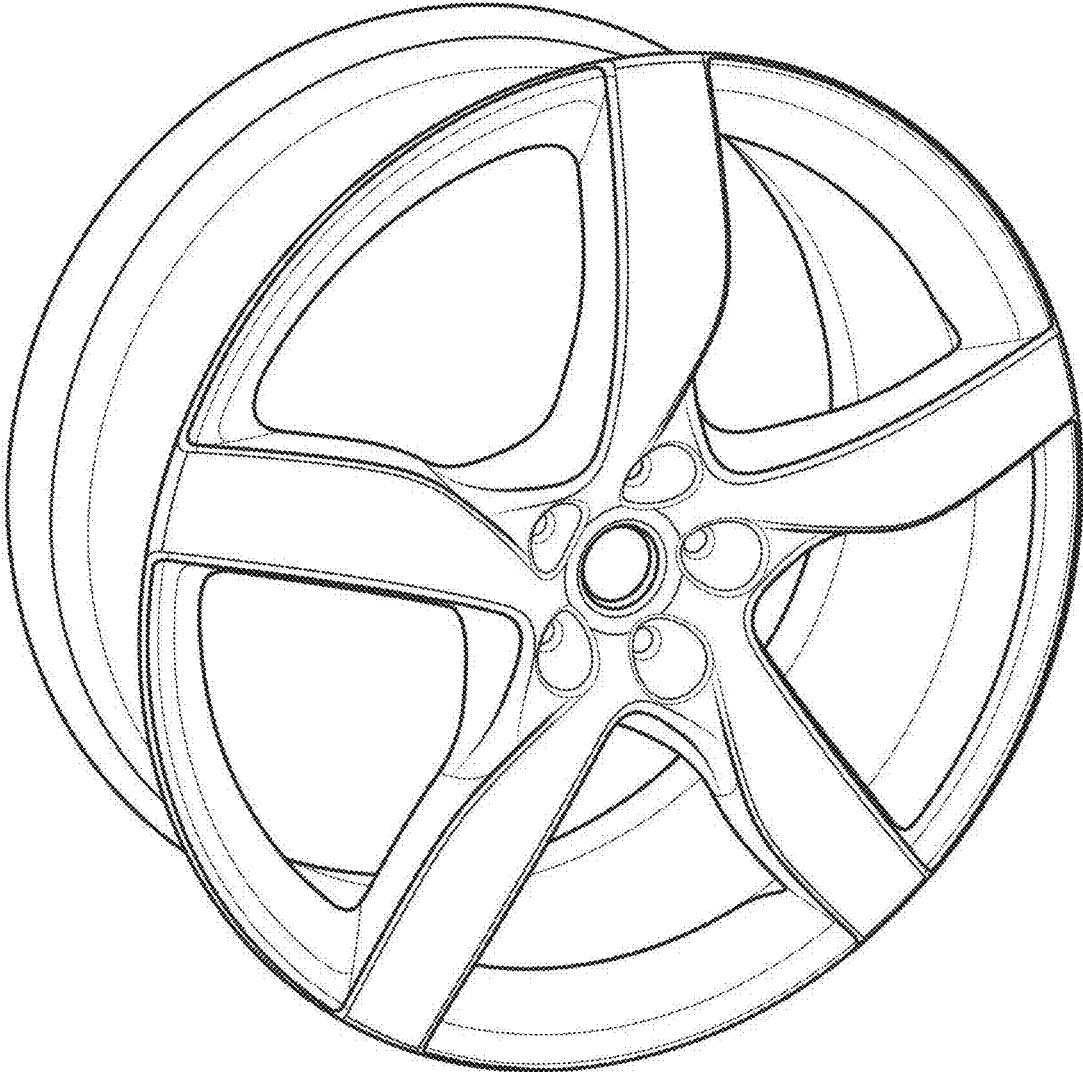

FIG. 2

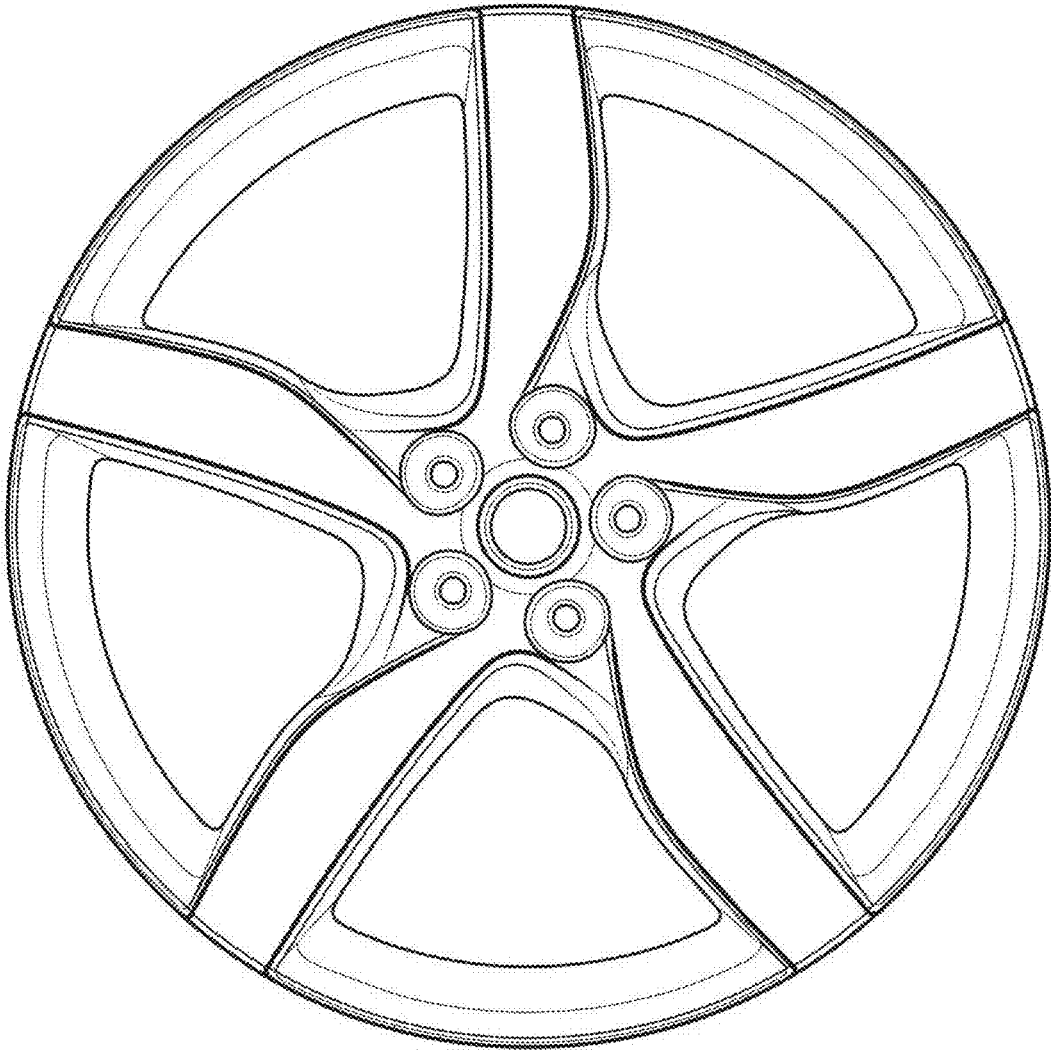

FIG. 3

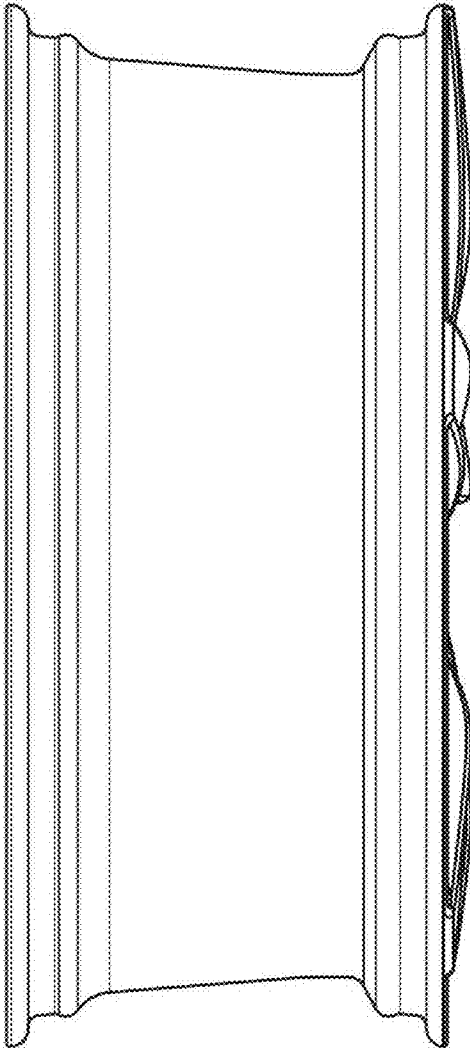

FIG. 4

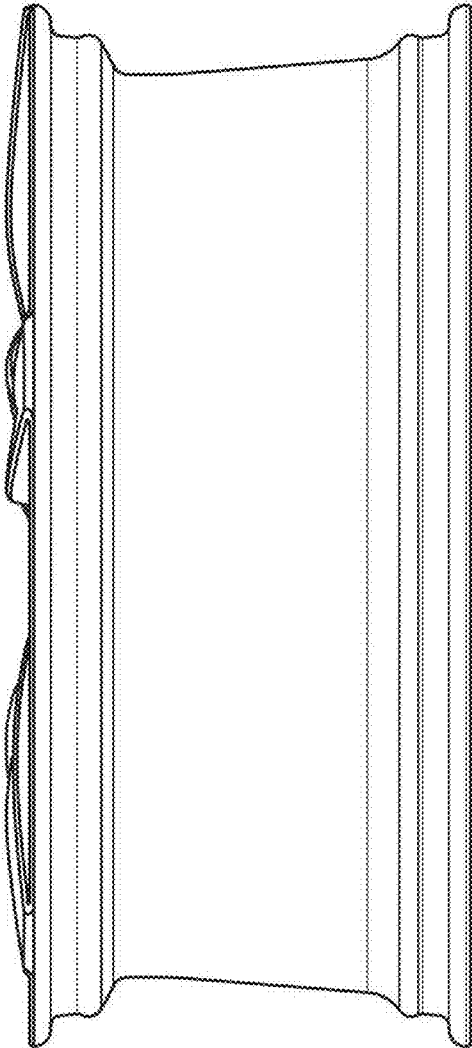

FIG. 5

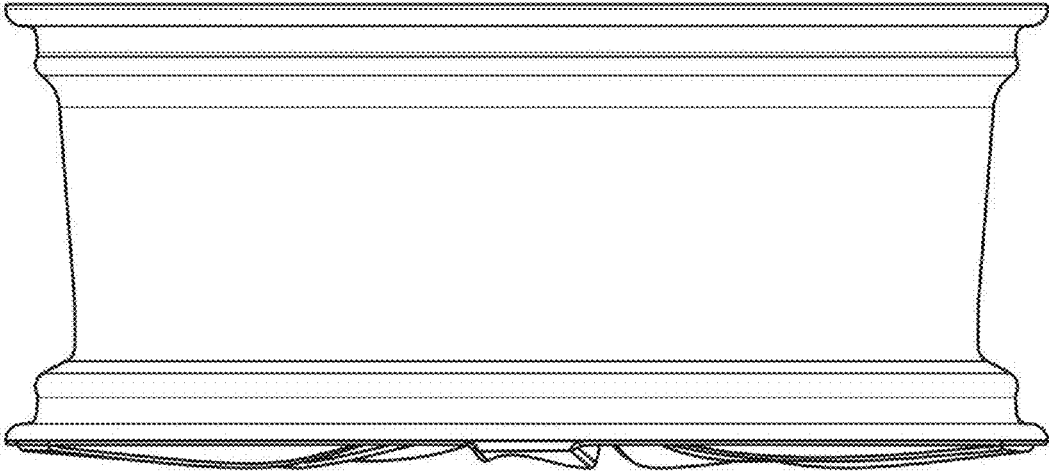

FIG. 6

