



US00D640067S

(12) **United States Design Patent**
Weimer et al.

(10) **Patent No.:** **US D640,067 S**

(45) **Date of Patent:** **** Jun. 21, 2011**

(54) **SEAT FRAME**

(75) Inventors: **Kent Weimer**, Columbia City, IN (US);
Douglas Garofalo, Chicago, IL (US);
Grant Gibson, Chicago, IL (US)

(73) Assignee: **Wabash Valley Manufacturing, inc.**,
Silver Lake, IN (US)

(**) Term: **14 Years**

(21) Appl. No.: **29/316,217**

(22) Filed: **Sep. 3, 2009**

(51) **LOC (9) Cl.** **06-01**

(52) **U.S. Cl.** **D6/379**

(58) **Field of Classification Search** D6/376,
D6/379-381, 360-361, 349, 500; 297/452.19,
297/446.2, 440.22-440.23, 448.1, 452.12,
297/452.18, 452.2, 452.21

See application file for complete search history.

(56) **References Cited**

U.S. PATENT DOCUMENTS

| | | | |
|-------------|-----------|-----------------|---------|
| D165,710 S | 1/1952 | Currie et al. | |
| D182,822 S | 5/1958 | Kempner, Jr. | |
| 2,917,108 A | 12/1959 | Moritz | |
| D190,744 S | 6/1961 | Guice | |
| D222,806 S | 1/1972 | Wise | |
| D228,162 S | 8/1973 | Fink | |
| 3,758,152 A | 9/1973 | Lake | |
| D231,963 S | 7/1974 | May | |
| 3,847,424 A | 11/1974 | Nielson | |
| 3,910,631 A | 10/1975 | Inaba | |
| D244,108 S | * 4/1977 | Bacon | D6/349 |
| 4,023,859 A | 5/1977 | Hagenson | |
| D261,968 S | 11/1981 | Caldwell | |
| D277,442 S | 2/1985 | Crowell | |
| D278,776 S | 5/1985 | Kime | |
| 4,522,443 A | 6/1985 | Van Blankenburg | |
| 4,674,795 A | * 6/1987 | Nelson | 297/239 |
| D294,782 S | 3/1988 | Balderi | |
| D298,987 S | * 12/1988 | Tiffany | D6/360 |

| | | | | | |
|-------------|---|---------|---------------|-------|--------|
| D324,786 S | * | 3/1992 | Saiger | | D6/379 |
| D325,304 S | | 4/1992 | Grosfillex | | |
| D327,778 S | | 7/1992 | Crawford | | |
| D327,779 S | | 7/1992 | Jensen et al. | | |
| D333,750 S | * | 3/1993 | Hess | | D6/500 |
| D345,261 S | | 3/1994 | Chen | | |
| D357,590 S | | 4/1995 | Noll | | |
| D360,536 S | | 7/1995 | Pelletier | | |
| 5,452,936 A | | 9/1995 | Koehring | | |
| D366,773 S | | 2/1996 | Yurk | | |
| D366,774 S | | 2/1996 | Frinier | | |
| D372,133 S | | 7/1996 | Slear | | |
| D376,937 S | | 12/1996 | Skalka | | |
| D380,105 S | * | 6/1997 | Diaz-Azcuy | | D6/381 |
| D380,313 S | | 7/1997 | Slear | | |

(Continued)

OTHER PUBLICATIONS

2008 "Plastisol" Coated Furniture Catalog, Wabash Valley Manufacturing, Inc.

(Continued)

Primary Examiner — Elizabeth Albert

Assistant Examiner — Kelley Donnelly

(74) *Attorney, Agent, or Firm* — E. Victor Indiano; Indiano Law Group

(57) **CLAIM**

The ornamental design for a seat frame, as shown and described.

DESCRIPTION

FIG. 1 is a perspective view of a seat frame showing our new design;

FIG. 2 is a left side view thereof;

FIG. 3 is a front view thereof;

FIG. 4 is a rear view thereof;

FIG. 5 is a right side view thereof;

FIG. 6 is a top view thereof; and,

FIG. 7 is a bottom view thereof.

1 Claim, 4 Drawing Sheets

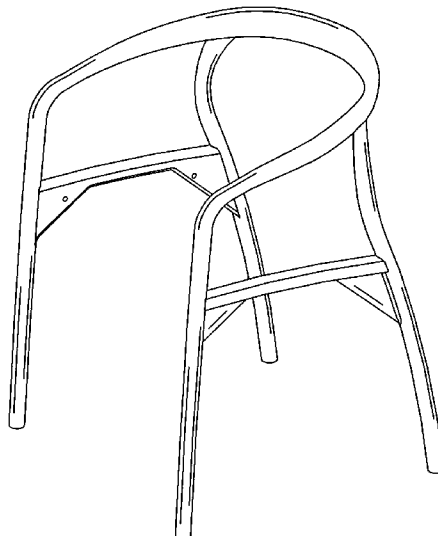

US D640,067 S

Page 2

U.S. PATENT DOCUMENTS

| | | | |
|----------------|---------|--------------------|------------|
| D381,826 S | 8/1997 | Lin | |
| D383,615 S | 9/1997 | Skalka | |
| D384,512 S | 10/1997 | Skalka | |
| D386,012 S | 11/1997 | Skalka | |
| D420,821 S * | 2/2000 | Barile et al. | D6/360 |
| D472,723 S * | 4/2003 | Haney et al. | D6/373 |
| D564,802 S | 11/2003 | Shilling et al. | |
| D483,304 S * | 12/2003 | Ford | D12/133 |
| D486,004 S * | 2/2004 | Haney et al. | D6/379 |
| D498,602 S * | 11/2004 | Goodman | D6/376 |
| D527,922 S | 9/2006 | Shilling et al. | |
| D530,119 S | 10/2006 | Franks et al. | |
| D547,979 S * | 8/2007 | Glass et al. | D6/500 |
| D554,397 S | 11/2007 | Franks et al. | |
| D571,581 S | 6/2008 | Weimer et al. | |
| D572,047 S | 7/2008 | Weimer et al. | |
| D572,048 S | 7/2008 | Weimer et al. | |
| D572,947 S | 7/2008 | Weimer et al. | |
| D574,639 S | 8/2008 | Weimer et al. | |
| D578,791 S | 10/2008 | Shilling et al. | |
| 7,621,600 B2 * | 11/2009 | Buchbinder | 297/452.19 |
| RE41,850 E * | 10/2010 | Figueroa | D6/372 |
| D624,763 S * | 10/2010 | Bassam et al. | D6/380 |
| D625,793 S * | 10/2010 | Pereira Del Arroyo | D23/309 |
| D633,606 S * | 3/2011 | Pereira Del Arroyo | D23/309 |
| D633,607 S * | 3/2011 | Pereira Del Arroyo | D23/309 |

OTHER PUBLICATIONS

Rhodes Bench and Model 1890 Park Bench, 2004 Sweets Catalog File, vol. 1.

* cited by examiner

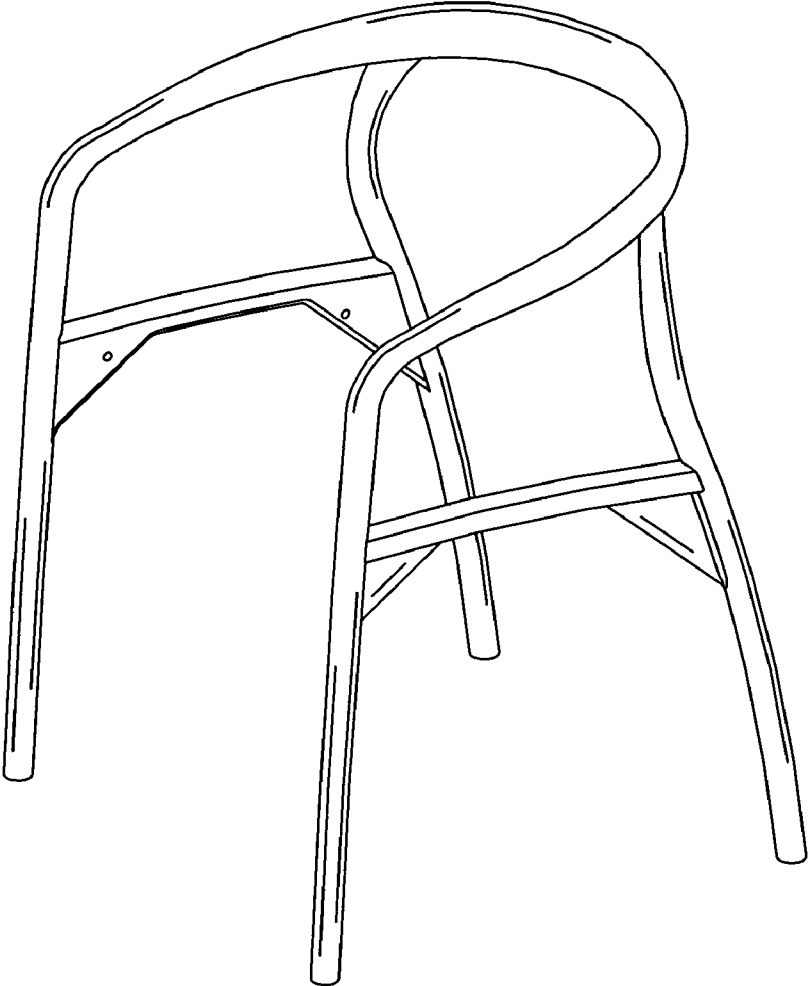

FIG. 1

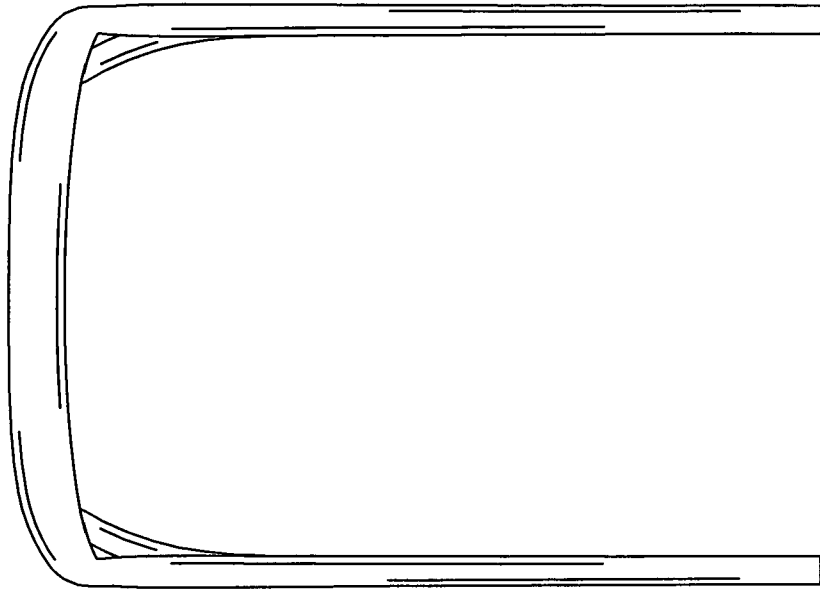

FIG. 3

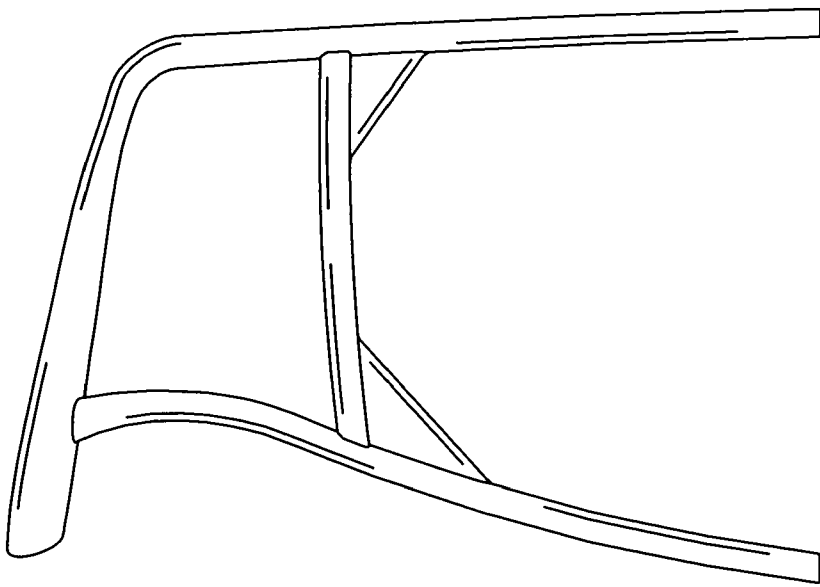

FIG. 2

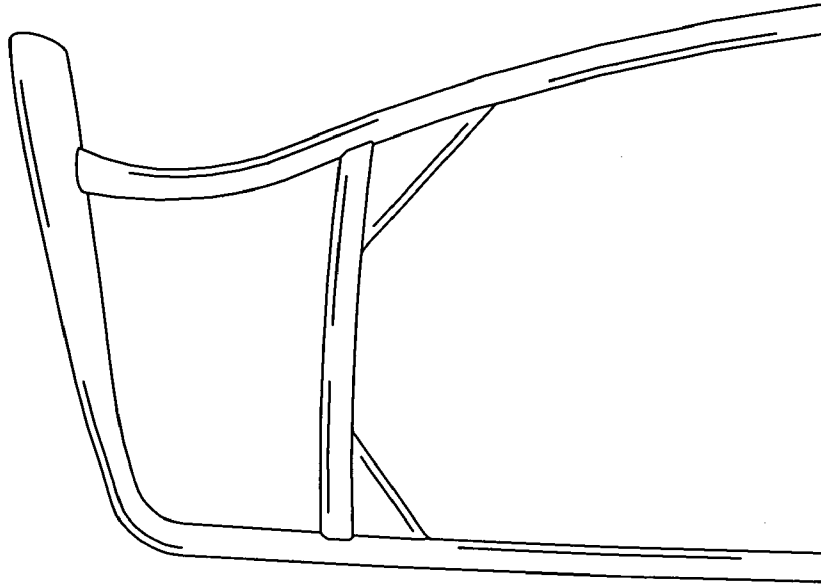

FIG. 5

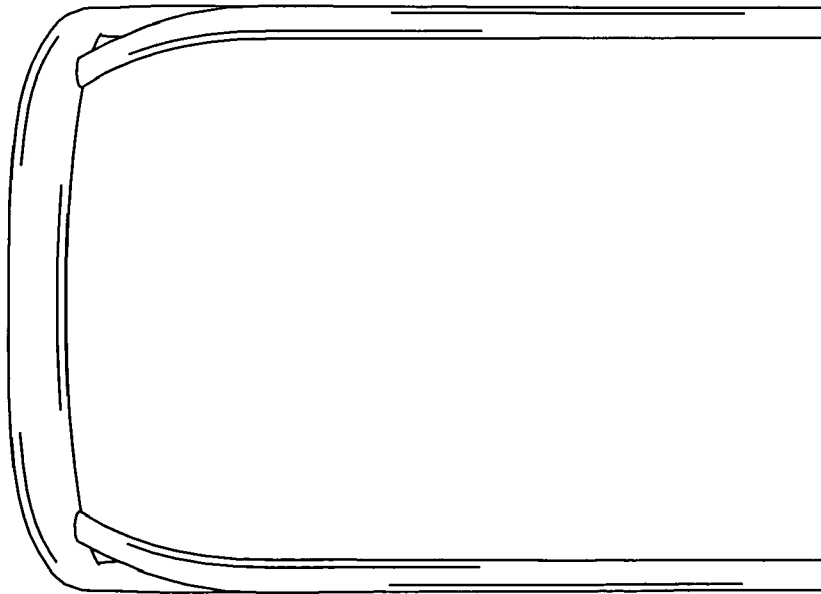

FIG. 4

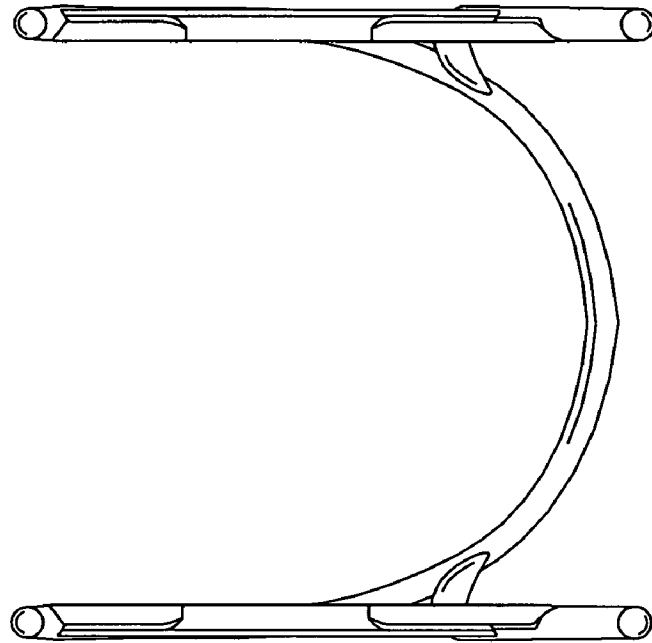

FIG. 7

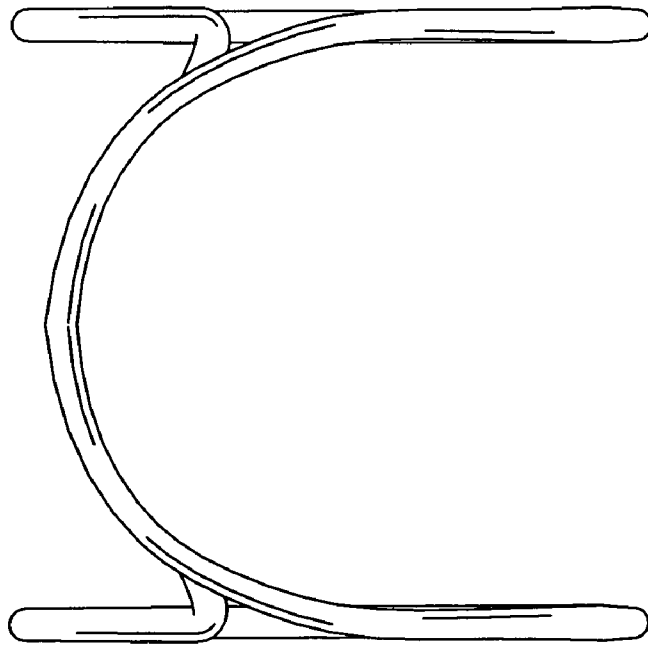

FIG. 6