

[54] **JAMB BRACKET**
 [75] Inventor: **Louis D. Huot**, Vadnais Heights, Minn.
 [73] Assignee: **Ideal Security Hardware Corporation**, St. Paul, Minn.
 [**] Term: **14 Years**
 [21] Appl. No.: **603,517**
 [22] Filed: **Apr. 24, 1984**
 [52] U.S. Cl. **D8/330; D8/349**
 [58] Field of Search **D8/349, 330, 373; 292/299; 248/300; 16/387, 389, 390, 391, 392, 66, 70, 52**

1,185,157	5/1916	Yates	16/392
1,565,524	12/1925	Summerall	292/275
1,675,980	7/1928	Lebherz	16/66
1,710,321	4/1929	Roedding	16/389
2,071,660	2/1937	Schulz et al.	16/66
2,260,898	10/1941	Hall	16/389
2,277,140	3/1942	O'Connell	16/389
2,497,288	2/1950	Bissell et al.	16/392
2,552,821	5/1951	Simpson	16/70
2,702,398	2/1955	Marcus	16/66
3,977,712	8/1976	Northrop	292/338
4,194,264	3/1980	Stoffregen	16/52
4,332,055	6/1982	Rudnick et al.	16/392

Primary Examiner—Wallace R. Burke
Assistant Examiner—Horace B. Fay
Attorney, Agent, or Firm—Merchant, Gould, Smith, Edell, Welter & Schmidt

[56] **References Cited**
U.S. PATENT DOCUMENTS

D. 100,587	7/1936	Spencer et al.	16/389 X
D. 204,187	3/1966	Schulz	D8/330
D. 249,225	9/1978	Moe	D8/07
D. 273,457	4/1984	Matsuo et al.	D8/330
D. 275,431	9/1984	Usab	D8/373
285,156	9/1883	Page	16/66
322,763	7/1885	Vincent	16/84
365,491	6/1887	Shaw	16/49
454,078	6/1891	Smith	16/49
715,175	12/1902	Sullivan	16/49
892,556	7/1908	Selleck	16/389
953,378	3/1910	Daggs	16/84

[57] **CLAIM**

The ornamental design for a jamb bracket, as shown and described.

DESCRIPTION

FIG. 1 is a left side, top and front perspective view of a jamb bracket showing my new design;
 FIG. 2 is a rear elevational view thereof;
 FIG. 3 is a top plan view thereof;
 FIG. 4 is a front elevational view thereof;
 FIG. 5 is a bottom plan view thereof;
 FIG. 6 is a right side elevational view thereof; and
 FIG. 7 is a left side elevational view thereof.

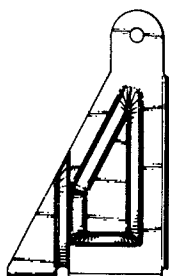
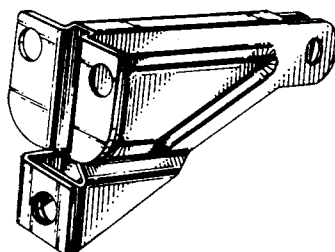

FIG. 1

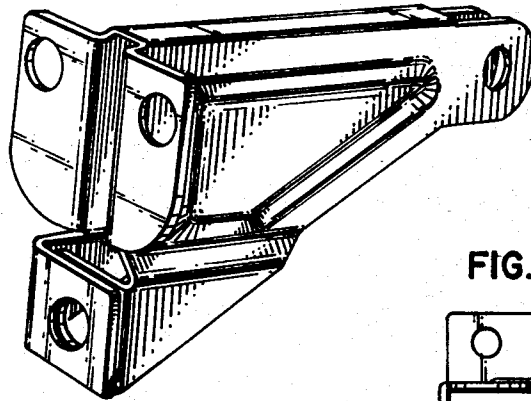

FIG. 6

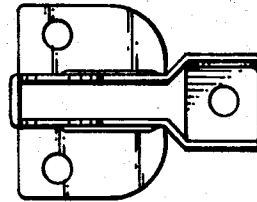

FIG. 3

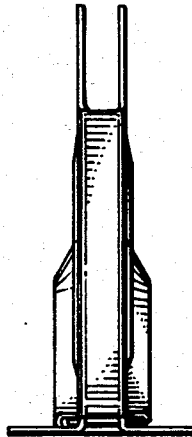

FIG. 2

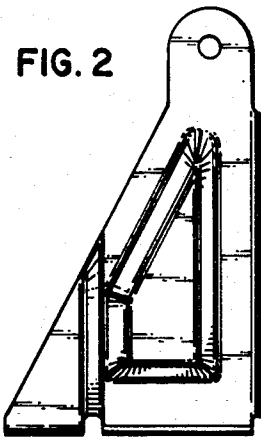

FIG. 4

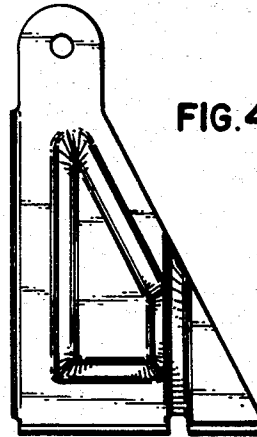

FIG. 5

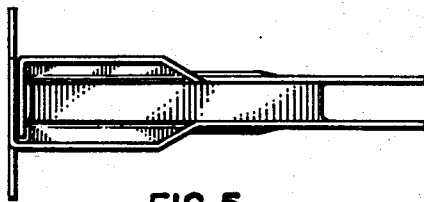

FIG. 7

