



- (51) International Patent Classification:
G06F 3/0488 (2013.01)
- (21) International Application Number:
PCT/US2014/049904
- (22) International Filing Date:
6 August 2014 (06.08.2014)
- (25) Filing Language: English
- (26) Publication Language: English
- (30) Priority Data:
13/964,034 9 August 2013 (09.08.2013) US
- (71) Applicant: MOTOROLA MOBILITY LLC [US/US];
600 North US Highway 45, Libertyville, Illinois 60048 (US).
- (72) Inventors: LOMBARDI, Michael J.; 57 Arcadia Lane,
Lake Zurich, Illinois 60047 (US). PATEL, Mitul R.; 420
Waterford Drive, Lake Zurich, Illinois 60047 (US).
PIERCE, Amber M.; 600 North U.S. Highway 45, Liber-
tyville, Illinois 60048 (US).

- (74) Agents: VALLEY, Cory M. et al.; 1150 18 Street, NW,
Suite 575, Washington, District of Columbia 20036 (US).
- (81) Designated States (unless otherwise indicated, for every
kind of national protection available): AE, AG, AL, AM,
AO, AT, AU, AZ, BA, BB, BG, BH, BN, BR, BW, BY,
BZ, CA, CH, CL, CN, CO, CR, CU, CZ, DE, DK, DM,
DO, DZ, EC, EE, EG, ES, FI, GB, GD, GE, GH, GM, GT,
HN, HR, HU, ID, IL, IN, IR, IS, JP, KE, KG, KN, KP, KR,
KZ, LA, LC, LK, LR, LS, LT, LU, LY, MA, MD, ME,
MG, MK, MN, MW, MX, MY, MZ, NA, NG, NI, NO, NZ,
OM, PA, PE, PG, PH, PL, PT, QA, RO, RS, RU, RW, SA,
SC, SD, SE, SG, SK, SL, SM, ST, SV, SY, TH, TJ, TM,
TN, TR, TT, TZ, UA, UG, US, UZ, VC, VN, ZA, ZM,
ZW.
- (84) Designated States (unless otherwise indicated, for every
kind of regional protection available): ARIPO (BW, GH,
GM, KE, LR, LS, MW, MZ, NA, RW, SD, SL, SZ, TZ,
UG, ZM, ZW), Eurasian (AM, AZ, BY, KG, KZ, RU, TJ,
TM), European (AL, AT, BE, BG, CH, CY, CZ, DE, DK,
EE, ES, FI, FR, GB, GR, HR, HU, IE, IS, IT, LT, LU, LV,
MC, MK, MT, NL, NO, PL, PT, RO, RS, SE, SI, SK, SM,

[Continued on next page]

(54) Title: METHOD AND APPARATUS FOR USER INTERACTION DATA STORAGE

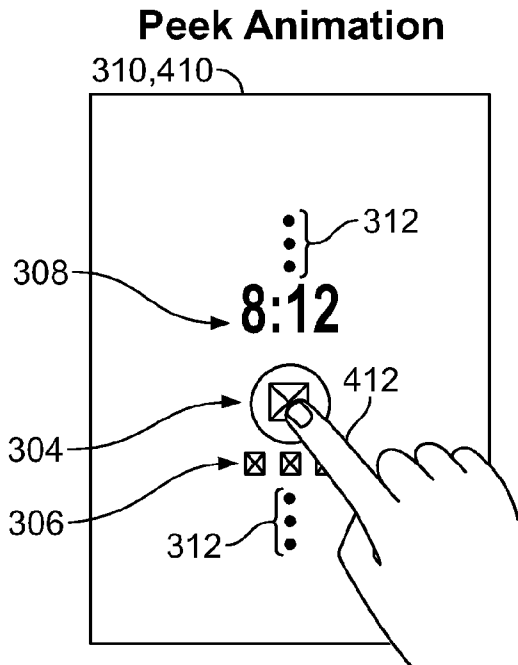

FIG. 4C

(57) Abstract: A method on an electronic device is described. A touch screen display of the electronic device is actively controlled in a higher-power mode of operation. Actively controlling the touch screen display in the higher-power mode is discontinued to enter a lower-power mode of operation. In the lower-power mode: at least one first control signal is provided to the touch screen display; in response to the at least one first control signal, a first portion of the touch screen display is activated and a first portion of a graphic is displayed on a first area of the touch screen display within the first portion; occurrence of a first user interaction that corresponds to the first portion of the graphic during the display of the first portion of the graphic is determined; and user interaction data is stored for the first portion of the graphic based on the first user interaction determination.

WO 2015/021127 A2

TR), OAPI (BF, BJ, CF, CG, CI, CM, GA, GN, GQ, GW, KM, ML, MR, NE, SN, TD, TG). **Published:**

— *without international search report and to be republished upon receipt of that report (Rule 48.2(g))*

METHOD AND APPARATUS FOR USER INTERACTION DATA STORAGE

CROSS REFERENCE TO RELATED APPLICATIONS

[0001] The present application is related to co-pending and commonly assigned U.S. Patent Application Serial No. 13/830452, filed on 14 March 2013 and U.S. Patent Application Serial No. 13/836987, filed on 15 March 2013, both of which claim priority to each of U.S. Provisional Patent Application No. 61/720,322, filed on 30 October 2012, and U.S. Provisional Patent Application No. 61/736,536, filed on 12 December 2012, and U.S. Provisional Patent Application No. 61/757,690, filed on 28 January 2013, the contents of all of which are hereby incorporated by reference herein.

TECHNICAL FIELD

[0002] The disclosure relates to user interaction with an electronic device.

BACKGROUND

[0003] The traditional "Notification LED" on an electronic device has lost its usefulness for users who often receive a constant stream of notifications. For such users, the notification LED blinks often and thus becomes "noise" that provides little in the way of useful information and, indeed, an always-blinking LED drowns out important notifications. Additionally, devices employing such notification LEDs foster an operational paradigm of "fidgeting" in which the user must constantly wake the device simply to view each notification. Such operation is both time consuming and cognitively draining. In view of such concerns, and others, it would be advantageous if one or more improved methods of providing notifications to users of electronic devices, and improved electronic devices configured to perform such methods, could be developed.

BRIEF DESCRIPTION OF THE DRAWINGS

[0004] These and/or other embodiments will become apparent and more readily appreciated from the following description of the embodiments, taken in conjunction with the accompanying drawings of which:

[0005] FIG. 1 is a perspective view of an example embodiment of an electronic device in accordance with the present disclosure;

[0006] FIG. 2 is a block diagram representing example components of the electronic device of FIG. 1;

[0007] FIGS. 3A, 3B, 3C, and 3D are four example views of a display screen of the electronic device of FIG. 1 during four different points of operation of a method for display;

[0008] FIGS. 4A, 4B, 4C, and 4D respectively show the example views of FIGS. 3A, 3B, 3C, and 3D of the display screen, respectively, in combination with illustrations of a user interacting with the display screen;

[0009] FIG. 5 is a flowchart illustrating one embodiment of a method for storing user interaction data and performing an action by the electronic device of FIG. 1;

[0010] FIGS. 6A, 6B, 6C, and 6D are four example views of a display screen of the electronic device of FIG. 1 during operation of the method of FIG. 5 illustrating a survey for user interaction;

[0011] FIGS. 7A, 7B, and 7C are three example views of a display screen of the electronic device of FIG. 1 during operation of the method of FIG. 5 illustrating available actions;

[0012] FIG. 8 is a diagram of one example of user interaction data stored by one or more of the electronic devices of FIG. 1;

[0013] FIG. 9 is a chart representing an example histogram for view time of a graphic.

DETAILED DESCRIPTION

[0014] A variety of enhancements can be provided to electronic devices so as to enable the electronic devices to better provide notifications to users, and to the methods of operation of electronic devices in providing notifications. Although mobile device displays and indeed the application processors of mobile devices are in a powered-down or "off" state much or most of the time (e.g., in a "sleep mode"), so as to save on power consumed by such devices, such an

"off" state of the display presents an opportunity for displaying the most relevant information at just the right time. Further, because a user's attention is a limited resource, in addition to showing the right information at the right time, displaying of notifications in this manner during the "off" state could also help reduce the amount of time it takes to access the most important notifications. By giving users the right amount of information at the right time, the users will be better informed to decide whether or not to pick up and actively use (unlock or turn "on") their device – or to simply dismiss such notifications without unlocking their device.

[0015] Accordingly, it is possible to allow for ongoing activation of a mobile device display, even while the mobile device application processor and display are technically in a powered-down or "off" state, by implementing Smart Partial OLED display technology and a sensor hub (or other auxiliary processing device) for controlling a display using such technology, rather than using the mobile device application processor, so as to achieve the displaying of notifications in a low-power (or lower-power) manner relative to normal "on" state operation of a display by way of the mobile device application processor. Embodiments operating in this manner can be considered as providing "always-on" operation insofar as, even though the mobile device (or at least the mobile device application processor) is powered-down or off, the display can still be activated to display notifications when appropriate. That is, touch inputs can be received, while the display is in a lower power state that is more akin to an "off" state in terms of power usage, insofar as the display is "on" only periodically or otherwise to a limited extent. Such operation can be advantageous both in terms of reducing the rate of battery depletion, as well as reducing the chance that portions of a display might be overly illuminated for too great of time in a manner that could damage the display.

[0016] In at least some embodiments, the display of the "right information at the right time" is achieved by leveraging the Smart Partial OLED display system to display an optimized set of notifications while the screen is "off", where optimization can be achieved for example by way of intelligent prioritization/ranking based on various information such as various inputs/behaviors, and improved notification management. In this manner, the most important contextually-relevant information reaches the user, and particularly can be provided to the user when the user has a need for that information (in such cases, there can also be integration with

personal assistant-type applications such as Google Now available from Google, Inc. of Mountain View, California).

[0017] Also, in at least some embodiments, the "always-on" operation provides users with a seamless or substantially seamless experience as the users utilize the device and the device transitions between the "screen off" state (lock screen) and the "on" state. In at least some example embodiments, the device comes alive while still in the "off" mode (e.g., where the application processor is still dormant) by showing incoming notifications as they occur, by providing "breathing" alerts on the screen without substantially draining the battery, and by coming alive when the device is picked up off of a surface such as a table. Also, in some example embodiments, the providing of notifications is entirely disabled by the device when the device recognizes a circumstance where the providing of notifications is inappropriate (e.g., when the device is face down, when the device is in a pocket, when it is nighttime, etc.).

[0018] Further, in at least some embodiments, the low-power operating capability of the OLED display during the "off" state of the device is further leveraged by operating the display in a manner by which important notifications are shown only on a small part of the screen. In some cases, not only does the display system display an optimized set of notifications while the screen is "off", without significantly impacting battery life, but also the system allows for a select set of user interactions during this state, which also avoid significant impact upon battery life. Also, in at least some cases, there can further be a continuous, cohesive experience between phone and watch operation. Also, at least some embodiments can provide a user-centric approach to security.

[0019] In addition to notifications to a user, advertisements to the user on mobile devices are also common. However, these advertisements are typically placed within applications or the operating systems and thus must be viewed when the user is actively using the mobile device. The advertisement must then compete for the user's attention with the applications or operating system. Because the user is more likely to direct their attention to the application than the advertisement, an advertiser that pays for the advertisement placement is less likely to pay a higher fee for the advertisement's placement. The use of an "always-on" operation for display of

graphics or advertisements along with user interaction during their display allows for more targeted advertising and information gathering.

[0020] The present disclosure is generally directed to a method and system for storing user interaction data. In particular, the disclosure is directed to storing user interaction data for advertisements on an electronic device.

[0021] The present disclosure describes a method of an electronic device. A touch screen display of the electronic device is actively controlled in a higher-power mode of operation. Actively controlling the touch screen display in the higher-power mode of operation is discontinued to enter a lower-power mode of operation. In the lower-power mode of operation, at least one first control signal is provided to the touch screen display. In the lower-power mode of operation and in response to the at least one first control signal, a first portion of the touch screen display is activated. In the lower-power mode of operation and in response to the at least one first control signal, a first portion of a graphic is displayed on a first area of the touch screen display that is within the first portion of the touch screen display. In the lower-power mode of operation, whether a first user interaction that corresponds to the first portion of the graphic has occurred during the display of the first portion of the graphic is determined. In the lower-power mode of operation, user interaction data is stored for the first portion of the graphic based on the first user interaction determination.

[0022] The present disclosure further describes an electronic device. The electronic device includes a receiver configured to receive wireless communication signals, at least one memory device, a touch screen display, at least one application processor configured to control the touch screen display in a higher-power mode of operation, and at least one processing device configured to control the touch screen display in a lower-power mode of operation. The at least one application processor is configured to receive and store a graphic in the at least one memory device in the higher-power mode of operation. The electronic device is configured to discontinue actively controlling the touch screen display in the higher-power mode of operation with the application processor to enter the lower-power mode of operation. The at least one processing device is configured to provide, in the lower-power mode of operation, at least one first control signal to the touch screen display. The touch screen display is configured to

activate, in the lower-power mode of operation and in response to the at least one first control signal, a first portion of the touch screen display. The touch screen display is configured to display, in the lower-power mode of operation and in response to the at least one first control signal, a first portion of the graphic on a first area of the touch screen display that is within the first portion of the touch screen display. The at least one processing device is configured to determine, in the lower-power mode of operation, whether a first touch input that corresponds to the first area has occurred during the display of the first portion of the graphic. The at least one processing device is configured to provide, in the lower-power mode of operation and in response to the first touch input, at least one second control signal to the touch screen display. The touch screen display is configured to activate, in the lower-power mode of operation and in response to the at least one second control signal, a second portion of the touch screen display. The touch screen display is configured to display, in the lower-power mode of operation and in response to the at least one second control signal, a second portion of the graphic on a second area of the touch screen display that is within the second portion of the touch screen display. The at least one processing device is configured to store, in the lower-power mode of operation, user interaction data for the graphic. The user interaction data includes at least one of a duration of the first touch input, a duration of the display of the second portion of the graphic, or an action indication that corresponds to the first touch input.

[0023] The present disclosure further describes another electronic device. The electronic device includes a touch screen display, an application processor configured to control the touch screen display in a higher-power mode of operation, a sensor hub configured to control the touch screen display in an lower-power mode of operation, and a non-transitory memory. The electronic device is configured to actively control the touch screen display in the higher-power mode of operation with the application processor. The electronic device is configured to discontinue actively controlling the touch screen display in the higher-power mode of operation with the application processor to enter the lower-power mode of operation. The sensor hub is configured to provide, in the lower-power mode of operation, at least one first control signal to the touch screen display. The touch screen display is configured to activate, in the lower-power mode of operation and in response to the at least one first control signal, a first portion of the touch screen display. The touch screen display is configured to display, in the lower-power mode of operation and in response to the at least one first control signal, a first portion of a

graphic on a first area of the touch screen display that is within the first portion of the touch screen display. The sensor hub is configured to determine, in the lower-power mode of operation, whether a first user interaction that corresponds to the first portion of the graphic has occurred during the display of the first portion of the graphic. The sensor hub is configured to store, in the lower-power mode of operation, user interaction data for the first portion of the graphic based on the first user interaction determination.

[0024] Turning to FIG. 1, there is illustrated a perspective view of an example electronic device 100. In the present embodiment, the electronic device 100 can be any type of device capable of providing touch screen interactive capabilities. Examples of the electronic device 100 include, but are not limited to, mobile devices, wireless devices, smart phones, tablet computing devices, personal digital assistants, personal navigation devices, touch screen input devices, touch or pen-based input devices, portable video or audio players, as well as any of a variety of other electronic devices. It is to be understood that the electronic device 100 may take the form of a variety of form factors, such as, but not limited to, bar, tablet, flip/clam, slider and rotator form factors.

[0025] In the present example embodiment shown in FIG. 1, the electronic device 100 has a housing 101 comprising a front surface 103 which includes a touch screen display (that is a visible display) 105 that, together with certain other features discussed below, constitutes a user interface. In the present example, the touch screen display 105 is a touch screen including a touch-sensitive surface that overlays a display surface forming part of (or that is positioned just underneath or inwardly of) the front surface 103. In the present embodiment, the touch screen display 105 (and particularly the display surface thereof) employs organic light-emitting diode (OLED) technology. Further, the user interface of the electronic device 100 as shown can also include one or more input keys 107. Examples of the input key or keys 107 include, but are not limited to, keys of an alpha or numeric (e.g., alphanumeric) keypad (or other keyboard), physical keys, touch-sensitive surfaces, mechanical surfaces, multipoint directional keys, and side buttons or keys. Further as shown, the electronic device 100 can also comprise a speaker 109 and microphone 111 for audio output and input, respectively, along the front surface 103 (or other outer surfaces of the device).

[0026] Notwithstanding the particular features shown in FIG. 1, in an alternate embodiment, the electronic device can include other features. For example, in place of the touch screen display, in an alternate embodiment the electronic device can employ a touch-sensitive surface supported by the housing 101 that does not overlay (or is not overlaid by) any type of display. Indeed, although FIG. 1 shows particularly example display and user interface features, it is to be understood that the electronic device 100 can include a variety of other combinations of display and user interface features depending upon the embodiment.

[0027] Additionally as shown in FIG. 1, the electronic device 100 includes one or more sensors 113, a number of which are shown to be positioned at or within an exterior boundary of the housing 101 (and can be supported on or within the housing 101). More particularly, as illustrated by FIG. 1, in the present embodiment the sensor or sensors 113 can be positioned at the front surface 103, another surface (such as one or more side surfaces 115) of the exterior boundary of the housing 101, or both. In the present embodiment, at least some of the sensors 113 (whether at the exterior boundary or within the exterior boundary, i.e., internal to the housing) are configured to detect one or more predetermined environmental conditions associated with an environment external or internal to the housing. Further examples of the sensors 113 are described below in reference to FIG. 2.

[0028] Referring to FIG. 2, there is shown a block diagram representing example components (e.g., internal components) 200 of the electronic device 100 of FIG. 1. In the present embodiment, the components 200 include one or more wireless transceivers 201, one or more processors 203, one or more memories 205, one or more output components 207, and one or more input components 209. As already noted above, the electronic device 100 includes a user interface, including the touch screen display 105 that comprises one or more of the output components 207 and one or more of the input components 209. Also as already discussed above, the electronic device 100 includes a plurality of the sensors 113, several of which are described in more detail below. In the present embodiment, the sensors 113 are in communication with (so as to provide sensor signals to or receive control signals from) a sensor hub 224.

[0029] Further, the components 200 include a device interface 215 to provide a direct connection to auxiliary components or accessories for additional or enhanced functionality. In

addition, the internal components 200 include a power source or supply 217, such as a portable battery, for providing power to the other internal components and allow portability of the electronic device 100. As shown, all of the components 200, and particularly the wireless transceivers 201, processors 203, memories 205, output components 207, input components 209, sensor hub 224, device interface 215, and power supply 217, are coupled directly or indirectly with one another by way of one or more internal communication link(s) 218 (e.g., an internal communications bus).

[0030] Further, in the present embodiment of FIG. 2, the wireless transceivers 201 particularly include a cellular transceiver 211 and a Wi-Fi transceiver 213. Although in the present embodiment the wireless transceivers 201 particularly include two of the wireless transceivers 211 and 213, the present disclosure is intended to encompass numerous embodiments in which any arbitrary number of (e.g., more than two) wireless transceivers employing any arbitrary number of (e.g., two or more) communication technologies are present. More particularly, in the present embodiment, the cellular transceiver 211 is configured to conduct cellular communications, such as 3G, 4G, 4G-LTE, vis-à-vis cell towers (not shown), albeit in other embodiments, the cellular transceiver 211 can be configured to utilize any of a variety of other cellular-based communication technologies such as analog communications (using AMPS), digital communications (using CDMA, TDMA, GSM, iDEN, GPRS, EDGE, etc.), or next generation communications (using UMTS, WCDMA, LTE, IEEE 802.16, etc.) or variants thereof.

[0031] By contrast, the Wi-Fi transceiver 213 is a wireless local area network (WLAN) transceiver configured to conduct Wi-Fi communications in accordance with the IEEE 802.11 (a, b, g, or n) standard with access points. In other embodiments, the Wi-Fi transceiver 213 can instead (or in addition) conduct other types of communications commonly understood as being encompassed within Wi-Fi communications such as some types of peer-to-peer (e.g., Wi-Fi Peer-to-Peer) communications. Further, in other embodiments, the Wi-Fi transceiver 213 can be replaced or supplemented with one or more other wireless transceivers configured for non-cellular wireless communications including, for example, wireless transceivers employing ad hoc communication technologies such as HomeRF (radio frequency), Home Node B (3G femtocell), Bluetooth, or other wireless communication technologies such as infrared technology. Although

in the present embodiment each of the wireless transceivers 201 serves as or includes both a respective transmitter and a respective receiver, it should be appreciated that the wireless transceivers are also intended to encompass one or more receiver(s) that are distinct from any transmitter(s), as well as one or more transmitter(s) that are distinct from any receiver(s). In one example embodiment encompassed herein, the wireless transceiver 201 includes at least one receiver that is a baseband receiver.

[0032] Exemplary operation of the wireless transceivers 201 in conjunction with others of the components 200 of the electronic device 100 can take a variety of forms and can include, for example, operation in which, upon reception of wireless signals (as provided, for example, by remote device(s)), the internal components detect communication signals and the transceivers 201 demodulate the communication signals to recover incoming information, such as voice or data, transmitted by the wireless signals. After receiving the incoming information from the transceivers 201, the processors 203 format the incoming information for the one or more output components 207. Likewise, for transmission of wireless signals, the processors 203 format outgoing information, which can but need not be activated by the input components 209, and convey the outgoing information to one or more of the wireless transceivers 201 for modulation so as to provide modulated communication signals to be transmitted. The wireless transceiver(s) 201 convey the modulated communication signals by way of wireless (as well as possibly wired) communication links to other devices (e.g., remote devices). The wireless transceivers 201 in one example allow the electronic device 100 to exchange messages with remote devices, for example, a remote network entity 214 of a cellular network or WLAN network. Examples of the remote network entity 214 include an application server, web server, database server, or other network entity accessible through the wireless transceivers 201 either directly or indirectly via one or more intermediate devices or networks (e.g., via a WLAN access point, the Internet, LTE network, or other network).

[0033] Depending upon the embodiment, the output and input components 207, 209 of the components 200 can include a variety of visual, audio, or mechanical outputs. For example, the output device(s) 207 can include one or more visual output devices such as a cathode ray tube, liquid crystal display, plasma display, video screen, incandescent light, fluorescent light, front or rear projection display, and light emitting diode indicator, one or more audio output devices such

as a speaker, alarm, or buzzer, or one or more mechanical output devices such as a vibrating mechanism or motion-based mechanism. Likewise, by example, the input device(s) 209 can include one or more visual input devices such as an optical sensor (for example, a camera lens and photosensor), one or more audio input devices such as a microphone, and one or more mechanical input devices such as a flip sensor, keyboard, keypad, selection button, navigation cluster, touch pad, capacitive sensor, motion sensor, and switch.

[0034] As noted, the user interface and particularly the touch screen display 105 of the electronic device 100 of FIG. 1 can be considered to constitute or include both one or more of the input components 209, particularly a touch-sensitive input component 219 shown in FIG. 2, and one or more of the output components 207. Further, it should be appreciated that the operations that can actuate one or more of the input devices 209 can include not only the physical pressing/activating of the touch screen display 105 or buttons or other actuators of the user interface or otherwise, but can also include, for example, opening the electronic device 100 (if it can take on open or closed positions), unlocking the electronic device 100, moving the electronic device to actuate a motion, moving the electronic device to actuate a location positioning system, and operating the electronic device.

[0035] In the present embodiment, one or more of the input components 209, such as one or more input components encompassed by the user interface such as the touch-sensitive component 219 shown in FIG. 1, can produce an input signal in response to detecting a predetermined gesture. In this regard, the touch-sensitive component 219 can be considered a gesture sensor and can be or include, for example, a touch-sensitive sensor having a touch-sensitive surface substantially parallel to the display. The touch-sensitive sensor can include at least one of a capacitive touch sensor, a resistive touch sensor, an acoustic sensor, an ultrasonic sensor, a proximity sensor, or an optical sensor.

[0036] As mentioned above, the components 200 also can include one or more of various types of the sensors 113. Although the sensors 113 are for the purposes of FIG. 2 shown to be distinct from the input devices 209, the sensors can also be considered as being encompassed among the input devices 209. In alternate embodiments, one or more of the input devices can be encompassed among the sensors, one or more of the sensors can be considered distinct from the

input devices, one or more of the input devices can be considered distinct from the sensors, or all of the sensors can be considered distinct from all of the input devices and vice-versa.

[0037] With respect to the sensors 113 particularly shown in FIG. 2, these particularly include various sensors 225 through 231 that are examples of sensors that can be included or utilized by the electronic device 100. As already noted, as shown in FIG.2, the various sensors 225-231 in the present embodiment can be controlled by the sensor hub 224, which can operate in response to or independent of the processor(s) 203. The various sensors 225 through 231 can include, but are not limited to, one or more power sensors 225, one or more temperature sensors 227, one or more pressure sensors 228, one or more moisture sensors 229, and one or more ambient noise sensors 231.

[0038] Further in regard to the present embodiment, and as discussed further below, it should be understood that the sensor hub 224, in addition to controlling the various sensors 225 through 231, also serves to control operation of the touch screen display 105 of the user interface (and the functionality that supports it) when the electronic device 100 and particularly the touch screen display is considered to be "off", including times at which the electronic device is operating in an intermediate mode or "breathing mode" of operation as described below. This is in contrast to times at which the electronic device 100 is awake or "on", during which times the touch screen display 105 of the user interface (and the functionality that supports it) is under the control of the processor(s) 203, which can be considered application processor(s). This manner of operation involving control by the sensor hub 224 at times when the electronic device is "off" is advantageous because the sensor hub consumes substantially less power than the processors 203 therefore operation under the control of the sensor hub can be provided with substantially less battery drain than operation under the processor(s) 203.

[0039] Although the various sensors 225 through 231 are shown in FIG. 2, in other embodiments one or more of numerous other types of sensors can also be included among the sensors 113 including, for example, one or more motion sensors, including for example one or more accelerometers or Gyro sensors (not shown), one or more light sensors, one or more proximity sensors (e.g., a light detecting sensor, an ultrasound transceiver or an infrared transceiver), one or more other touch sensors, one or more altitude sensors, one or more location

circuits/components that can include, for example, a Global Positioning System (GPS) receiver, a triangulation receiver, an accelerometer, a tilt sensor, a gyroscope, or any other information collecting device that can identify a current location or user-device interface (carry mode) of the electronic device 100.

[0040] With respect to the processor(s) 203, the processor(s) can include any one or more processing or control devices such as, for example, a microprocessor, microcomputer, application-specific integrated circuit, etc. The processors 203 can generate commands, for example, based on information received from the one or more input components 209. The processor(s) 203 can process the received information alone or in combination with other data, such as information stored in the memories 205. Thus, the memories 205 of the components 200 can be used by the processors 203 to store and retrieve data.

[0041] Further, the memories (or memory portions) 205 of the components 200 can encompass one or more memory devices of any of a variety of forms (e.g., read-only memory, random access memory, static random access memory, dynamic random access memory, etc.), and can be used by the processors 203 to store and retrieve data. In some embodiments, one or more of the memories 205 can be integrated with one or more of the processors 203 in a single device (e.g., a processing device including memory or processor-in-memory (PIM)), albeit such a single device will still typically have distinct portions/sections that perform the different processing and memory functions and that can be considered separate devices. The data that is stored by the memories 205 can include, but need not be limited to, operating systems, applications, and informational data.

[0042] Each operating system includes executable code that controls basic functions of the electronic device 100, such as interaction among the various components included among the components 200, communication with external devices or networks via the wireless transceivers 201 or the device interface 215, and storage and retrieval of applications and data, to and from the memories 205. Each application includes executable code that utilizes an operating system to provide more specific functionality, such as file system service and handling of protected and unprotected data stored in the memories 205. Such operating system or application information can include software update information (which can be understood to potentially encompass

updates to either application(s) or operating system(s) or both). As for informational data, this is non-executable code or information that can be referenced or manipulated by an operating system or application for performing functions of the electronic device 100.

[0043] It is to be understood that FIG. 2 is provided for illustrative purposes only and for illustrating components of an electronic device in accordance with various embodiments, and is not intended to be a complete schematic diagram of the various components required for an electronic device. Therefore, an electronic device can include various other components not shown in FIG. 2, or can include a combination of two or more components or a division of a particular component into two or more separate components, and still be within the scope of the disclosed embodiments.

[0044] The electronic device 100 in one embodiment is configured to proceed among different operational modes or states, mainly, a "fully awake" or "on" mode of operation during which the processors 203 are operating (that is, the application processors are up and running), an "off" mode of operation, and an "intermediate" mode of operation during which "breathing" and "peeking" processes occur or can occur. Although in the present embodiment the processors 203 are off or powered-down during the off mode and intermediate mode of operation (by contrast to operation in the fully awake mode, during which the processors 203 are up and running), as will be described further below it is still possible for the electronic device 100 to operate during one or both of the off mode and intermediate mode in manners that involve some display functionality by the touch screen display 105 (including potentially both outputting of information and receiving of inputs). Such operation of the touch screen display 105 during the intermediate mode or off mode is achieved by virtue of control functionality provided by the sensor hub 224.

[0045] It should further be appreciated that, generally speaking, operation in the fully awake mode is associated with a normal power mode of the processors 203 (application processors) or a substantially active mode of those processors. By contrast, the intermediate mode of operation and off mode of operation are associated with a low power (or even completed powered-off) mode of the processors 203 (application processors) or a substantially inactive mode of those processors. Given the above, the intermediate mode of operation can also be referred to as an

"Always on Display" mode (AoD mode), "sleep" mode (or the off mode potentially can also be encompassed generally within the "sleep" mode), or lower-power mode of operation, in contrast to the fully awake mode, which can be referred to as a "non-sleep" mode or higher-power mode of operation.

[0046] Additionally as will be described further below, in at least some embodiments disclosed herein, one or more notifications can be displayed by the electronic device 100 in a "non-sleep" mode such as the fully awake mode and also one or more notifications can be displayed by the electronic device in a "sleep" mode such as the intermediate or AoD mode (including submode portions thereof as described). In at least some such embodiments, the notifications provided in the fully awake mode or "non-sleep" mode are notifications received during operation in that mode, and that are displayed by way of activation of the entire, or substantially the entire, display screen (e.g., full screen information is displayed, where the full screen information includes data corresponding to substantially all pixels capable of being displayed by the display). Further in such embodiments, in contrast, the notifications provided in the intermediate mode or "sleep" mode are notifications received during operation in that mode, and that are displayed by way of activation of only a portion or portions of the display screen (particularly portion(s) that are substantially less than the entire display screen or display substantially less than the full screen information, that is, information corresponding to less or substantially less than all pixels capable of being displayed by the display).

[0047] Turning to FIGS. 3A, 3B, 3C, and 3D, respectively, first, second, third, and fourth example views of the touch screen display 105 of the electronic device 100 are shown that are intended to illustrate example operation of the touch screen display in displaying images or graphics for a user interaction. FIG. 3A particularly shows a blank image 300 that appears when the touch screen display 105 is completely off.

[0048] By contrast, FIG. 3B shows a breathing view image 302 that, rather than being blank, instead includes one or more image portions that are displayed by the touch screen display 105, and which in the present example particularly include an icon 304 that can constitute a hit area that can be touched by a user during operation in the intermediate mode, additional icons 306 that also can constitute an additional hit area (or areas), and a time display 308. The breathing

view image 302 does not remain consistently on at all times during operation in the intermediate mode, but rather periodically becomes visible and then disappears (at which times the touch screen display 105 again takes on the blank image 300 of FIG. 3A).

[0049] Next, with respect to FIG. 3C, a peek animation image 310 is illustrated. As shown, the peek animation image 310 also includes one or more image portions that are displayed by the touch screen display 105, and more particularly in this embodiment these one or more image portions include not only all of the image portions shown in FIG. 3B (namely, icon 304, icons 306 and time display 308) but also additionally include animation features 312, which in the present example include upper and lower (that is, above the time display 308 and below the icons 306) vertically-extending columns of three dots. As further discussed below, the animation features 312 particularly are displayed by the touch screen display 105 during transitioning between a time during the intermediate mode at which a touch can be received (e.g., a time at which the breathing view image 302 shown in FIG. 3B is displayed), and a time at which the peek view mode has been fully entered and a peek view image such as an example image shown in FIG. 3D is displayed.

[0050] Additionally, with respect FIG. 3D, the peek view image 314 shown therein is an example of an image that can be displayed by the touch screen display 105 once peek view mode has been entered. As shown, the peek view image 314 no longer includes the exact same arrangement of image portions shown in the peek animation view 310, albeit some of the image portions are the same in terms of their respective appearances. More particularly, the peek view image 314 in contrast to the peek animation image 310 no longer has the animation features 312 or time display 308, but continues to have an icon 305 identical in appearance to the icon 304 and icons 307 identical in appearance to the icons 306, except insofar as the icon 305 is now at a location that is moved upwards relative to the location of the icon 304 in the peek animation view (above the location of the uppermost dot of the upper column of dots of the animation features) and the icons 307 are now at a location that is moved vertically downward relative to their previous location in the peek animation view (below the location of the lowermost dot of the lower column of dots of the animation features).

[0051] Further, in the peek view image 314, one or more (in this example, three) text string lines 316 are also displayed, above the icon 305. The text string lines 316 can include message information or information corresponding to one or more past notifications received by the electronic device 100. The display of these text string lines thus allows the user to "peek" at the notifications that have been received (e.g., recently received) by the electronic device 100, and is therefore the feature of this manner of operation giving rise to the "peek view mode" terminology used herein.

[0052] Referring additionally to FIGS. 4A, 4B, 4C, and 4D, first, second, third, and fourth additional views 400, 402, 410, and 414, are shown, respectively. The first, second, third, and fourth views 400, 402, 410, and 414 respectively encompass the blank, breathing view, peek animation view, and peek view images 300, 302, 310, and 314 that are shown in FIGS. 3A, 3B, 3C, and 3D, respectively, but also show those images in combination with illustrations of a user — particularly a finger 412 of the user's hand — interacting with those images. Because it is envisioned that the finger 412 of the user has not yet approached the touch screen display in the case of the blank image 300 and breathing view image 302, the first additional view 400 of FIG. 4A merely again shows the blank image 300, and the second additional view 402 of FIG. 4B merely again shows the breathing view image 302. By contrast, with respect to the third additional view 410 of FIG. 4C, there it is envisioned that the user has already touched the touch screen display 105 with the user's finger 412 and this has given rise to display of the peek animation view 310. In particular, it should be noted that the finger 412 is touching on the icon 304, which constitutes one of the hit areas on the touch screen display 105 in this example. Further, it is because of (in response to) the user's finger 412 touching the hit area that animation features 312 are shown to have appeared.

[0053] Finally, at FIG. 4D, the fourth additional view 414 shows the peek view image 314 of FIG. 3D and also again shows the user's finger 412 to still be proximate to (touching) the touch screen display 105. As represented by arrows 415, while in the peek view mode of operation, the user can further provide a gesture (or gesture portion) so as to actuate the electronic device 100 to perform one of several different actions or transition to any of several different modes. In the present example, gestural activation of the electronic device 100 in this regard particularly is not accomplished until, in addition to originally touching one of the hit areas (again, in this example,

one of the icons 304 and 306) during the intermediate mode of operation, the user then further: (i) continues to continuously touch that hit area during the transitioning from the intermediate mode to the peek view mode (e.g., continues to touch one of the icons 304, 306 as the touch screen display transitions from the breathing view 302 to the peek animation view 310 and ultimately to the peek view 314); (ii) then manipulates the finger 412 to slide upward or downward (e.g., in accordance with either of the arrows 415 of FIG. 4D) until the finger reaches an appropriate one of the image portions of the peek view image corresponding to the hit area that was originally touched (e.g., reaches one of the icons 305, 307 as shown in the peek view 314), and (iii) then releases the hit area by removing the finger 412 from the touch screen display.

[0054] Turning to FIGS. 5, 6A, 6B, 6C, and 6D, a flowchart for a method 500 illustrates one embodiment of a method for storing data for a user interaction during a display session and performing an action by the electronic device 100 in response to the user interaction. Examples of user interaction by the user include viewing or providing a touch input to the touch screen display 105, pressing an input key 107, providing an audio or voice input for the microphone 111, or providing a gesture input (e.g., shaking the electronic device 100). The display session in one example represents a query to the user of the electronic device 100, such as a survey or other prompt for information. In another example, the display session represents a display of a graphic to the user of the electronic device 100, such as an advertisement or informational message. Other display sessions will be apparent to those skilled in the art. FIGS. 6A, 6B, 6C, and 6D are four example views of a display screen of the electronic device 100 during operation of the method shown in FIG. 5, illustrating a survey as a display session. The user interaction for the display session occurs, at least in part, during the intermediate or lower-power mode of operation of the electronic device 100. Accordingly, the user has fewer distractions (e.g., applications or the operating system) from the query or graphic. As described above, the processor 203 actively controls (502) the touch screen display 105 during the higher-power mode of operation.

[0055] The processor 203 optionally receives (504) display session information for at least one display session during the higher-power mode of operation. The display session information comprises at least one of a graphic (e.g., text, images, icons, animated image, video, or a combination thereof), portion of a graphic, action indication, action icon, keyword, trigger data,

or other information for a display session (e.g., a survey or advertisement). In this case, the processor 203 stores the display session information in the memory 205 for subsequent access by the sensor hub 224 or other components of the electronic device 100. In alternative implementations, the display session information is preconfigured within the electronic device 100 (e.g., during manufacture or initialization) or stored on a separate memory card (e.g., a solid state memory card) which is then loaded into the electronic device 100. The electronic device 100 in one implementation is configured to obtain updates for the display session information. The electronic device 100 in one example obtains the updates at predetermined times (e.g., 2:00 pm, 4:00 pm, etc.), predetermined intervals (e.g., every hour), or when other criteria are met, such as when the electronic device 100 is not in active use by the user or utilization of the electronic device 100 (e.g., utilization of the processor 203 or wireless transceivers 201) is below an activity threshold. In another example, the electronic device 100 obtains the updates upon the occurrence of an event or signal, such as receiving a push notification from the remote network entity 214. In yet another example, the electronic device 100 obtains updates upon a change in mode of operation for the electronic device 100, for example, upon entering the higher-power mode of operation. Other times, schedules, events, or signals to cause an update will be apparent to those skilled in the art. The electronic device 100 in one example obtains the updated display session information through the wireless transceivers 201. In another example, the electronic device 100 obtains the updated display session information by replacement of a memory card.

[0056] During the higher-power mode of operation, the processor 203 is configured to discontinue (506) actively controlling the touch screen display 105 to enter the lower-power mode of operation (e.g., the intermediate mode). Entry to the lower-power mode is based on a lack of user activity, a display timeout, or other criteria that may be used to trigger the electronic device 100 to “sleep,” as will be apparent to those skilled in the art. Referring to FIG. 6A, the touch screen display 105 is shown as a blank image 600 upon entering the lower-power mode of operation, analogous to the blank image 300.

[0057] During the lower-power mode of operation, the sensor hub 224 is configured to provide (508) at least one first control signal to the touch screen display 105. The sensor hub 224 provides the first control signal to cause the touch screen display 105 to activate and display a graphic or action icon for a selected display session, as described herein. In one example, the

sensor hub 224 provides the first control signal based on one or more sensor inputs from the sensors 113. For example, the sensor hub 224 is configured to provide the first control signal when the sensor inputs correspond to the user interacting with the electronic device 100. The electronic device 100 may have entered the intermediate mode when the user placed the electronic device 100 in a pocket, purse, phone case, or other compartment or when the user placed the electronic device 100 with the front surface 103 facing a table top (not shown) or other surface that obscures or covers the touch screen display 105. Alternatively, the user may have left the electronic device 100 on a table or desk where it has been sitting stationary for a period of time. The sensor hub 224 is thus configured to provide the first control signal upon an indication that the electronic device 100 has been moved after a period of being stationary or upon an indication that the touch screen display 105 of the electronic device 100 has changed to an uncovered state after a period of being in a covered state. For example, in response to an input from a proximity sensor, light sensor, accelerometer, or gyroscope of the sensors 113.

[0058] In response to the first control signal, the touch screen display 105 is configured to activate (510), during the lower-power mode of operation, a first portion of the touch screen display 105 (e.g., using the Smart Partial OLED display technology). The touch screen display 105 then displays (512), in the lower-power mode of operation and in response to the first control signal, a graphic or a first portion of a graphic on a first area of the touch screen display 105 that is within the first portion of the touch screen display 105. Referring to FIG. 6B, a breathing view image 602 (analogous to the breathing view image 302) is shown with a graphic 604 on the first area of the touch screen display 105. In this case, the display session is a survey that prompts the user of the electronic device 100 for their preference between soda or water by displaying the graphic 604 that indicates “Soda or Water?” While the graphic 604 is shown in a lower portion of the touch screen display 105, other portions of the touch screen display 105 may be activated for display. The portion of the touch screen display 105 activated for display may be different for each graphic or display session.

[0059] The sensor hub 224 selects a display session based on at least one of trigger data or keywords associated with the display session, a user profile associated with the electronic device 100, a location associated with the electronic device 100, proximity to a predetermined location (e.g., a restaurant, concert venue, sales kiosk), a time of day associated with the electronic device

100, or a selected action indication from a previous display session. As one example, a survey may be selected based on a user's location within or near a concert venue. Accordingly, the next time they look at the electronic device 100, the electronic device 100 provides a survey about which song a band at the concert venue should play first that night. They can respond to the question without waking their device. In other implementations, the electronic device 100 uses a preconfigured order of display sessions.

[0060] A display session in one example includes a preconfigured sequence of graphics, for example, a survey (e.g., as shown in FIGS. 6A, 6B, 6C, and 6D) which may include a preconfigured sequence of graphics (e.g., graphics 604, 608, 618) with corresponding hit areas. In another example, the display session information for a display session comprises a set of graphics from which the sensor hub 224 selects a graphic (e.g., the graphics 604, 608, 618) for display at various times during the display session. The sensor hub 224 in yet another example selects a set of graphics and action icons for the current display session from a set of available action icons. The sensor hub 224 in one example is configured to select graphics, action icons, or other information for display for a current display session from the display session information previously received (504) and stored in the memory 205. The sensor hub 224 selects the graphic, action icons, or information based on at least one of a user profile associated with the electronic device 100, a location associated with the current display session (e.g., where the electronic device 100 is currently located), proximity to a predetermined location (e.g., a shopping mall or restaurant), a time of day associated with the current display session, a selected action indication (described below) from a previous display session, a user interaction for the current display session, or other information stored by the electronic device 100 (e.g., the user's preferences or search history). In a further example, the sensor hub 224 selects a graphic or action icon based on trigger data associated with the display session or trigger data associated with the graphic or action icon. In one example, the sensor hub 224 selects a graphic that has not been previously viewed or interacted with by the user. In the case of a survey, the sensor hub 224 may select follow-up questions to previously answered surveys. For example, "Soda or Water?" may be followed with "Bottled water or Tap water?" for a subsequent display session if the user selects "Water" as described below.

[0061] The sensor hub 224 is configured to determine (514), in the lower-power mode of operation, whether a first user interaction has occurred that corresponds to the graphic 604 during the display of the graphic 604. As described above, the first user interaction may be a touch input (e.g., within the hit area), gesture input, audio input, key press, view, or combination thereof. The sensor hub 224 uses inputs provided by the sensors 113 to determine whether the first user interaction has occurred. The sensor hub 224 is configured to store (516), in the lower-power mode of operation, user interaction data for the graphic 604 based on the determination (514).

[0062] The graphic 604 in one example corresponds to one or more hit areas that can be touched by a user during operation in the lower-power mode of operation. For a touch input, the user interaction data in one example comprises at least one of a duration of the touch input or a location of the touch input on the touch screen display 105 (e.g., a hit area). The location may indicate one or more pixels of the touch screen display 105 that were touched, a region of the touch screen display 105 that was touched, or one or more pixels or regions of the graphic 604 that were touched. For a gesture input, the user interaction data in one example indicates a gesture type, such as a shake, rotation (e.g., between landscape and portrait orientations), or other movement. For an audio input, the user interaction data in one example indicates one or more keywords detected within the audio input. For a key press input, the user interaction data in one example indicates which input key 107 was pressed and may further indicate a duration of the key press (or a pattern of key presses).

[0063] For a view input, the sensor hub 224 determines whether the graphic 604 was viewed. The sensor hub 224 activates, in the lower-power mode of operation, a sensor 113 (e.g., an imager or front facing camera) of the electronic device 100. The sensor hub 224 determines, with the imager and in the lower-power mode of operation, whether a face of a user is detected. For example, the sensor hub 224 and the imager may determine whether a pair of eyes or other facial features are detected within a viewing distance of the touch screen display 105. The sensor hub 224 stores a view indication that indicates whether the face was detected as the user interaction data. The sensor hub 224 deactivates the imager after the face detection, expiration of a detection timer, or other deactivation criteria have been met.

[0064] The sensor hub 224 in one example is configured to wait for one or more user interactions after (or during) display of the graphic 604. The sensor hub 224 may further be configured to wait for a combination of user interactions, for example, providing a touch input while simultaneously viewing the touch screen display 105 or providing a touch input for a predetermined time (e.g., a first touch threshold). In this case, the sensor hub 224 may store user interaction data with an indication that the graphic 604 was not viewed if the duration of the touch input is below the threshold. Alternatively, the sensor hub 224 may omit storing the user interaction data if the threshold is not met.

[0065] After storing (516) the user interaction data, the sensor hub 224 may optionally end the method 500. For example, where the user interaction represents a display of an information message, the user interaction data may indicate that the information message was viewed (or not viewed) and the sensor hub 224 signals the touch screen display 105 to return to the blank image 600. Alternatively, the sensor hub 224 is configured to provide (518), in the lower-power mode of operation and in response to a first touch input (e.g., of the first user interaction), at least one second control signal to the touch screen display 105. In one example, the sensor hub 224 provides the second control signal after the first touch input has touched the graphic 604 for a duration that meets the first touch threshold. In another example, the sensor hub 224 provides the second control signal for display of a second graphic while the first touch input is substantially maintained such that removal of the touch input (e.g., the user removes their finger from the touch screen display 105) causes the second graphic to be cleared from the touch screen display 105.

[0066] In response to the second control signal and in the lower-power mode of operation, the touch screen display 105 activates (520) a second portion of the touch screen display 105 and displays (522) a second graphic on a second area of the touch screen display 105 that is within the second portion of the touch screen display 105. Optionally, the touch screen display 105 displays (522) a set of action icons, as described below with reference to FIG. 7. Referring to FIG. 6C, a peek view image 606 (analogous to the peek view image 314) is shown with a second graphic 608 on the second area of the touch screen display 105. In this case, the graphic 608 includes a depiction of a soda can and a water glass. In other display sessions, such as an advertisement, the second graphic is an expanded view of the first graphic. In alternative

implementations, the sensor hub 224 may provide an additional control signal to the touch screen display 105 in order to provide a peek animation image prior to display of the peek view image 606, as described above with reference to FIG. 3C.

[0067] After or during display of the graphic 608, the sensor hub 224 is configured to determine (524), in the lower-power mode of operation, whether a second touch input (e.g., a second user interaction) has occurred that corresponds to either the second area (e.g., the second graphic 608) or a third area of the touch screen display 105 that is distinct from the second area. Analogous to the first user interaction, the second user interaction may be a touch input (e.g., within a hit area), gesture input, audio input, key press, view, or combination thereof. The third area of the touch screen display 105 in one example comprises one or more portions of the touch screen display 105 outside of the graphic 608. In the present case of a user survey, the user may interact with the survey by sliding or swiping their finger up to the graphic 608 to “select” the depiction of the soda can or the depiction of the water glass (e.g., based on which hit area or pixels correspond to the touch input), or may slide their finger to the third area to indicate that they do not wish to answer the survey.

[0068] In response to the second touch input and in the lower-power mode, the sensor hub 224 selects (526) an action indication from a set of action indications for the display session and stores (528) the action indication with the user interaction data. The action indication in one example provides an indication of the user’s selection for the survey and the sensor hub 224 may optionally end the method 500. For example, where the display session represents a survey, the user interaction data may indicate that a selection was made (or dismissed) and the sensor hub 224 signals the touch screen display 105 to return to the blank image 600. While the user interaction data is shown as being stored in steps 516 and 528, in alternative implementations only a single step of storing is performed, for example, upon completion of the user interaction or selection of the action indication.

[0069] In alternative implementations, the action indication may indicate an action to be performed (530) by the electronic device 100, as described herein. In one example, a first action indication corresponds to a touch input in the second area and a second action indication corresponds to a touch input in the third area. As shown in the example of FIG. 6C, the graphic

608 corresponds to a first hit area 610 for the soda can (e.g., within a first partial region of the second portion of the touch screen display 105) and a second hit area 612 for the water glass (e.g., within a second partial region of the second portion of the touch screen display 105), while a third hit area 614 corresponds to the third area. In this case, the first hit area 610 corresponds to selection of the soda can, the second hit area 612 corresponds to selection of the water glass, and the third hit area 614 corresponds to a dismiss action indication (e.g., the user does not wish to answer the survey).

[0070] Referring to FIG. 6D, the action indication in one example corresponds to a display of an image 616 after a user selection for the survey (analogously to the peek view image 606). In the example shown, the image 616 comprises a graphic 618 that depicts a result for the survey. The result may be dynamically determined by the electronic device 100 or may be received with the graphic (504).

[0071] The graphics 604, 608, and 618 in one example comprise separate graphic elements. In alternative implementations, the graphics 604, 608, and 618 may be portions (e.g., primary and secondary portion) of a single graphic element to be displayed in a sequence. For example, a single graphic element may be sized to occupy a large portion of the touch screen display 105, but the entire graphic element is displayed or hidden in portions based on the user interaction. In alternative implementations, the graphics 604, 608, or 618 may include text, images, icons, animations, or a combination thereof.

[0072] After storage of the user interaction data, the electronic device 100 in one example sends the user interaction data to one or more remote network entities 214. For example, the remote network entity 214 may be an application server for an advertiser that places advertisement graphics on the electronic device 100. The advertiser may use the user interaction data to determine which advertisements are more effective than others at receiving user interactions. The electronic device 100 sends the user interaction data analogously to performing the update of the graphics (e.g., at predetermined times, predetermined intervals, upon the occurrence of an event or signal, or upon a change in mode of operation). Other times, schedules, events, or signals to trigger sending of the user interaction data will be apparent to

those skilled in the art. In some cases, sending of the user interaction data is a portion of the selected action.

[0073] Turning to FIGS. 7A, 7B, and 7C, three example views of a display screen of the electronic device of FIG. 1 during the method 500 are shown, illustrating available actions for a display session. As shown in FIG. 7A, a graphic 704 (analogous to graphic 604) comprises an advertisement for a coupon displayed (512) by the touch screen display 105. In response to a touch input as shown in FIG. 7B, the sensor hub 224 provides the second control signal to the touch screen display 105 for the display (522) of a graphic 706. The graphic 706 comprises a bar code that may be scanned by a bar code reader (not shown). In this case, the sensor hub 224 may wait for a user interaction (e.g., a touch input or audio input) before providing a control signal to the touch screen display 105 to dismiss or clear the touch screen display 105 before returning to the blank image 600. The sensor hub 224 may listen for an audio beep, such as a beep from a cash register that indicates the bar code has been scanned, before providing the control signal to clear the touch screen display 105. Thus, the bar code stays “pinned” to the touch screen display 105 until dismissed by the user.

[0074] In another implementation as shown in FIG. 7C, in response to the touch input, the sensor hub 224 provides the second control signal to the touch screen display 105 for the display (522) of a set of action icons 708, 710, and 712 for the display session. As described above, the sensor hub 224 in one example selects the action icons for display from the display session information. In one example, each action icon of the set of action icons corresponds to an action indication for an action that may be performed (530) by the electronic device 100. As shown in FIG. 7C, action icon 706 (“Drive”) corresponds to an action for obtaining driving directions, action icon 708 corresponds to an action for placing a call, and action icon 710 corresponds to an action for a social media platform.

[0075] As described above, the sensor hub 224 selects (526) the action indication from the set of action indications based on the user interaction (e.g., a touch input on a corresponding hit area). The electronic device 100 performs a selected action that corresponds to the selected action indication. In a first example, the sensor hub 224 performs the selected action in the lower-power mode of operation. In a second example, the electronic device 100 discontinues the

lower-power mode of operation to enter the higher-power mode of operation based on the selected action. The electronic device 100 (e.g., via the processor 203) performs the selected action in the higher-power mode of operation. In a third example, the selected action comprises multiple actions (or a compound action) that are performed partially in the lower-power mode of operation and partially in the higher-power mode of operation. In this case, actions for the lower-power mode may be performed by the sensor hub 224 during or after the display session, while the actions for the higher-power mode are performed by the processor 203 during the next higher-power mode. In one example, actions for several different display sessions may be queued for processor 203. The sensor hub 224 may discontinue the lower-power mode of operation to enter the higher-power mode of operation based on the selected action, or based upon another signal or event that wakes the electronic device 100.

[0076] In one example where the display session represents a user survey, a first graphic comprises a survey prompt for the user survey. In this case, at least one action indication of the set of action indications corresponds to a survey response indicator for the user survey (e.g., the user's selection for the survey). If the selected action indication corresponds to the survey response indicator, the sensor hub 224 stores, in the lower-power mode of operation, the survey response indicator. The processor 203 in this case sends, in the higher-power mode of operation, a survey response message based on the survey response indicator to a remote server, for example, to provide an advertiser with feedback for the survey.

[0077] The display session in another example represents an offer to the user of the electronic device 100. In this case, at least one action indication corresponds to a claim to the offer. For example, the sensor hub 224 stores an offer claim indicator to an offer account associated with a user of the electronic device 100.

[0078] In another example, the display session represents an event notification. The event notification allows a user to add a reminder to their calendar for an event. In this case, at least one action indication corresponds to a calendar entry indicator for the event notification. If the selected action indication corresponds to the calendar entry indicator, the sensor hub 224 stores the calendar entry indicator in the lower-power mode of operation. The processor 203 sends, in the higher-power mode of operation, a calendar entry message based on the calendar entry

indicator to a remote server for entry into a calendar associated with the electronic device (e.g., the user's calendar).

[0079] The display session in another example corresponds to a subscription notification. In this case, at least one action indication corresponds to a subscription request indicator. If the selected action indication corresponds to the subscription request indicator, the sensor hub 224 stores, in the lower-power mode of operation, the subscription request indicator. The processor 203 then sends, in the higher-power mode of operation, a subscription request message based on the subscription request indicator to an email distribution list associated with the subscription notification. The subscription request message comprises a user email address associated with the electronic device.

[0080] In another example, the display session comprises a social media survey that allows the user to "+1" or "like" a graphic or advertisement. In this case, at least one action indication corresponds to a social media response indicator for the social media survey. If the selected action indication corresponds to the social media response indicator, the sensor hub 224 stores, in the lower-power mode of operation, the social media response indicator. The processor 203 sends, in the higher-power mode of operation, a social media response message based on the social media response indicator to a remote server. The processor 203 in one example prompts the user to select one or more social media platforms to use for the social media response message.

[0081] Where the display session comprises an advertisement, in one example an action indication corresponds to a display of an animated graphic. As described above with respect to the bar code, the animated graphic may be pinned to the touch screen display 105 until dismissed by the user.

[0082] Another action indication may correspond to a uniform resource locator. In this case, performing the corresponding selected action comprises connecting to the uniform resource locator, such as opening a web page for an advertiser.

[0083] Yet another action indication may correspond to a navigation location. In this case, performing the selected action comprises performing a navigation lookup of the navigation

location. For example, the electronic device 100 opens a navigation application (e.g., Google Navigation) and directs the user to the navigation location. The navigation location in one example is an absolute location, such as an address or GPS coordinates. In another example, the navigation location is a relative location which instructs the navigation application to find, for example, a closest location for a restaurant.

[0084] Another action indication may correspond to a user application. In this case, performing the selected action comprises downloading or launching the user application.

[0085] Another example of an action indication corresponds to a telephone number. In this case, performing the selected action comprises placing a call to the telephone number. In a further example, the action indication may correspond to several telephone numbers and the sensor hub 224 selects one telephone based on a current time of day. This allows the call to be placed to an office during business hours or to a voicemail system after business hours. As described above, the sensor hub 224 may select action indications for a display session. In one example, the sensor hub 224 does not select an action indication for placing a call when the time of the display session is outside of the business hours for receiving the call.

[0086] Yet another example of an action indication corresponds to a sharing prompt. For example, the user may wish to share a graphic or advertisement with a friend. In this case, performing the selected action comprises determining a contact address for the sharing prompt, such as an email address or other contact information for the user's friend, and then sending a message based on the current display session to the contact address.

[0087] Another example of an action indication corresponds to a product purchase. In this case, performing the selected action comprises initiating the product purchase. For example, the processor 203 may confirm a purchase intent with the user of the electronic device 100. In a further example, the processor 203 uses billing details stored by the electronic device 100 (e.g., through Google Wallet) to initiate the purchase.

[0088] While several display sessions and action indications have been described separately, in alternative embodiments a plurality of display sessions may be combined into a single display session (e.g., with multiple user interactions). Additionally, multiple actions may be combined

and represented by a single action icon or action indication. A display session may use a single action icon or a plurality of action icons corresponding to action indications.

[0089] FIG. 8 is a diagram of one example of user interaction data stored by one or more remote network entities (e.g., the remote network entity 214). As described above, a display session may include multiple graphics, action icons, and associated information (e.g., time of day, location). The electronic device 100 is configured to store one or more portions of this information with the user interaction data and to send the user interaction data to the remote network entity 214. Referring to FIG. 8, a table 800 includes user interaction data from a plurality of electronic device 100 representing multiple users.

[0090] In the example shown by table 800, each row corresponds to a display session on a different electronic device 100 with a column indicating information for display sessions. A Primary Advertisement ID is shown to identify a first graphic of a display session and a Secondary Advertisement ID is shown to identify a second graphic of a display session. A set of action indications (“Action 1”, “Action 2”, and “Action 3”) show which action indications were selected and displayed for a particular display session. A User ID indicates an identity of a user of the electronic device 100 or an ID of the electronic device 100. A Device Model indicates a model name of the electronic device 100. The Time of Day indicates a time of day at which the display session was displayed by the electronic device 100. The Device Location indicates GPS coordinates of the electronic device 100 when the display session was displayed. The Wake Reason indicates an event which caused the sensor hub 224 to display the display session, for example, whether a proximity sensor indicates that the electronic device 100 has been removed from a pocket or an accelerometer indicates that the electronic device 100 has moved after a period of being stationary. A View Duration indicates a length of time that a graphic of the display session was viewed. An Action Taken indicates which action indicator was selected by the user, with a separate value (e.g., “0”) used to indicate that no action was taken. In alternative implementations, additional columns of user interaction data may be stored, or columns may be omitted.

[0091] FIG. 9 is a chart representing an example histogram 900 for view time of a graphic. A plurality of view times for graphics were analyzed and categorized based on a duration of the

view time and whether a view time was more likely to indicate that an action indication was selected by the user of the electronic device 100. View times 902 were found to be most likely to result in an action indication selection. Longer view durations suggest that a user was more interested in the display session, while shorter view durations suggest that a user was less interested or, for example, accidentally touched the touch screen display 105. In one example, a view duration threshold may be established to eliminate unintentional touches and graphic views from the data and thus avoid charging advertisers for unintended views. For example, this threshold may be set at 1.0 seconds.

[0092] The electronic device 100 or remote network entity 214 in one example selects different fee rates which may be charged to an advertiser based on a view duration for a display session of an advertisement. The electronic device 100 and user interaction data allow for recording of when a user touches an initial banner advertisement (e.g., the first graphic), when the user follows an advertisement (e.g., selects an action), and thus recording of a success rate for an advertisement. The electronic device 100 or remote network entity 214 in one example selects a fee for the advertisement based on the success rate for an advertisement. The electronic device 100 or remote network entity 214 in a further example selects the fee rate based on at least one of the trigger data for the display session, location, time, or other criteria. In one example for a view duration t , the fee rate is set as follows:

[0093] Example 1: If $t < 1.0$, charge \$0.00 and If $t \geq 1.0$, charge \$1.00.

[0094] As another example:

[0095] Example 2: If $t < 1.0$, charge \$0.00, if $1.0 \leq t \leq 3.0$, charge $(t-0.5)/2.5 * \$1.00$, and if $t > 3.0$, charge \$1.00.

[0096] It can be seen from the foregoing that a method and system for storing user interaction data from a low-power display session is advantageous. In view of the many possible embodiments to which the principles of the present discussion may be applied, it should be recognized that the embodiments described herein with respect to the drawing figures are meant to be illustrative only and should not be taken as limiting the scope of the claims. Therefore, the

techniques as described herein contemplate all such embodiments as may come within the scope of the following claims and equivalents thereof.

[0097] The apparatus described herein may include a processor, a memory for storing program data to be executed by the processor, a permanent storage such as a disk drive, a communications port for handling communications with external devices, and user interface devices, including a display, touch panel, keys, buttons, etc. When software modules are involved, these software modules may be stored as program instructions or computer readable code executable by the processor on a non-transitory computer-readable media such as magnetic storage media (e.g., magnetic tapes, hard disks, floppy disks), optical recording media (e.g., CD-ROMs, Digital Versatile Discs (DVDs), etc.), and solid state memory (e.g., random-access memory (RAM), read-only memory (ROM), static random-access memory (SRAM), electrically erasable programmable read-only memory (EEPROM), flash memory, thumb drives, etc.). The computer readable recording media may also be distributed over network coupled computer systems so that the computer readable code is stored and executed in a distributed fashion. This computer readable recording media may be read by the computer, stored in the memory, and executed by the processor.

[0098] The disclosed embodiments may be described in terms of functional block components and various processing steps. Such functional blocks may be realized by any number of hardware and/or software components configured to perform the specified functions. For example, the disclosed embodiments may employ various integrated circuit components, e.g., memory elements, processing elements, logic elements, look-up tables, and the like, which may carry out a variety of functions under the control of one or more microprocessors or other control devices. Similarly, where the elements of the disclosed embodiments are implemented using software programming or software elements, the disclosed embodiments may be implemented with any programming or scripting language such as C, C++, JAVA®, assembler, or the like, with the various algorithms being implemented with any combination of data structures, objects, processes, routines or other programming elements. Functional aspects may be implemented in algorithms that execute on one or more processors. Furthermore, the disclosed embodiments may employ any number of conventional techniques for electronics configuration, signal processing and/or control, data processing and the like. Finally, the steps of

all methods described herein may be performed in any suitable order unless otherwise indicated herein or otherwise clearly contradicted by context.

[0099] For the sake of brevity, conventional electronics, control systems, software development and other functional aspects of the systems (and components of the individual operating components of the systems) may not be described in detail. Furthermore, the connecting lines, or connectors shown in the various figures presented are intended to represent exemplary functional relationships and/or physical or logical couplings between the various elements. It should be noted that many alternative or additional functional relationships, physical connections or logical connections may be present in a practical device. The words “mechanism”, “element”, “unit”, “structure”, “means”, “device”, “controller”, and “construction” are used broadly and are not limited to mechanical or physical embodiments, but may include software routines in conjunction with processors, etc.

[0100] No item or component is essential to the practice of the disclosed embodiments unless the element is specifically described as “essential” or “critical”. It will also be recognized that the terms “comprises,” “comprising,” “includes,” “including,” “has,” and “having,” as used herein, are specifically intended to be read as open-ended terms of art. The use of the terms “a” and “an” and “the” and similar referents in the context of describing the disclosed embodiments (especially in the context of the following claims) are to be construed to cover both the singular and the plural, unless the context clearly indicates otherwise. In addition, it should be understood that although the terms “first,” “second,” etc. may be used herein to describe various elements, these elements should not be limited by these terms, which are only used to distinguish one element from another. Furthermore, recitation of ranges of values herein are merely intended to serve as a shorthand method of referring individually to each separate value falling within the range, unless otherwise indicated herein, and each separate value is incorporated into the specification as if it were individually recited herein.

[0101] The use of any and all examples, or exemplary language (e.g., “such as”) provided herein, is intended merely to better illuminate the disclosed embodiments and does not pose a limitation on the scope of the disclosed embodiments unless otherwise claimed. Numerous modifications and adaptations will be readily apparent to those of ordinary skill in this art.

CLAIMS

We claim:

1. A method of an electronic device, the method comprising:
 - actively controlling, in a higher-power mode of operation, a touch screen display of the electronic device;
 - discontinuing actively controlling the touch screen display in the higher-power mode of operation to enter a lower-power mode of operation;
 - providing, in the lower-power mode of operation, at least one first control signal to the touch screen display;
 - activating, in the lower-power mode of operation and in response to the at least one first control signal, a first portion of the touch screen display;
 - displaying, in the lower-power mode of operation and in response to the at least one first control signal, a first portion of a graphic on a first area of the touch screen display that is within the first portion of the touch screen display;
 - determining, in the lower-power mode of operation, whether a first user interaction that corresponds to the first portion of the graphic has occurred during the display of the first portion of the graphic;
 - storing, in the lower-power mode of operation, user interaction data for the first portion of the graphic based on the first user interaction determination.

2. The method of claim 1 wherein determining whether the first user interaction has occurred comprises determining that a first touch input has occurred that corresponds to the first area;

the method further comprising determining, in the lower-power mode of operation, a duration of the first touch input;

wherein storing the user interaction data comprises storing the duration of the first touch input for the first portion of the graphic.

3. The method of claim 2 wherein storing the user interaction data comprises storing an indication that the first portion of the graphic was not viewed if the duration of the first touch input is below a first touch threshold.

4. The method of claim 2 further comprising:

providing, in the lower-power mode of operation and in response to the first touch input, at least one second control signal to the touch screen display;

activating, in the lower-power mode of operation and in response to the at least one second control signal, a second portion of the touch screen display;

displaying, in the lower-power mode of operation and in response to the at least one second control signal, a second portion of the graphic on a second area of the touch screen display that is within the second portion of the touch screen display;

determining, in the lower-power mode of operation, whether a second touch input has occurred that corresponds to either the second area or a third area of the touch screen display that is distinct from the second area;

wherein storing the user interaction data further comprises storing an action indication that indicates whether the second touch input has occurred.

5. The method of claim 4 wherein displaying the second portion of the graphic comprises displaying the second portion of the graphic while the first touch input is substantially maintained based on the at least one first control signal;

the method further comprising determining, in the lower-power mode of operation, a duration of the display of the second portion of the graphic;

wherein storing the user interaction data further comprises storing the duration of the display of the second portion of the graphic.

6. The method of claim 5 wherein storing the user interaction data comprises storing an indication that the second portion of the graphic was not viewed if the duration of the display of the second portion of the graphic is below a display threshold.

7. The method of claim 4 wherein storing the action indication comprises storing a first action indication if the second touch input corresponds to the second area and storing a second action indication if the second touch input corresponds to the third area.

8. The method of claim 7 wherein storing the second action indication comprises storing a dismiss action indication.

9. The method of claim 4 wherein the second portion of the touch screen display comprises first and second partial regions, and wherein the second area includes a first hit area in the first partial region and a second hit area in the second partial region;

wherein storing the action indication comprises storing a first action indication if the second touch input corresponds to the first hit area and storing a second action indication if the second touch input corresponds to the second hit area.

10. The method of claim 4 wherein the first portion of the graphic is a primary portion of the graphic and the second portion of the graphic is a secondary portion of the graphic.

11. The method of claim 1 wherein providing the at least one first control signal comprises providing the at least one first control signal upon an indication that the electronic device has been moved after a period of being stationary or upon an indication that the touch screen display of the electronic device has changed to an uncovered state after a period of being in a covered state.

12. The method of claim 1 further comprising sending the user interaction data to a remote network entity.

13. The method of claim 1 wherein determining whether the first user interaction has occurred comprises:

activating, in the lower-power mode of operation, an imager of the electronic device; and

determining, with the imager and in the lower-power mode of operation, whether a face of a user is detected;

wherein storing the user interaction data comprises storing a view indication that indicates whether the face was detected.

14. An electronic device comprising:

a receiver configured to receive wireless communication signals;

at least one memory device;

a touch screen display;

at least one application processor configured to control the touch screen display in a higher-power mode of operation;

at least one processing device configured to control the touch screen display in a lower-power mode of operation;

wherein the at least one application processor is configured to receive and store a graphic in the at least one memory device in the higher-power mode of operation;

wherein the electronic device is configured to discontinue actively controlling the touch screen display in the higher-power mode of operation with the application processor to enter the lower-power mode of operation;

wherein the at least one processing device is configured to:

provide, in the lower-power mode of operation, at least one first control signal to the touch screen display;

wherein the touch screen display is configured to:

activate, in the lower-power mode of operation and in response to the at least one first control signal, a first portion of the touch screen display;

display, in the lower-power mode of operation and in response to the at least one first control signal, a first portion of the graphic on a first area of the touch screen display that is within the first portion of the touch screen display;

wherein the at least one processing device is configured to:

determine, in the lower-power mode of operation, whether a first touch input that corresponds to the first area has occurred during the display of the first portion of the graphic;

provide, in the lower-power mode of operation and in response to the first touch input, at least one second control signal to the touch screen display;

wherein the touch screen display is configured to:

activate, in the lower-power mode of operation and in response to the at least one second control signal, a second portion of the touch screen display;

display, in the lower-power mode of operation and in response to the at least one second control signal, a second portion of the graphic on a second area of the touch screen display that is within the second portion of the touch screen display; and

wherein the at least one processing device is configured to:

store, in the lower-power mode of operation, user interaction data for the graphic, wherein the user interaction data comprises at least one of a duration of the first touch input, a duration of the display of the second portion of the graphic, or an action indication that corresponds to the first touch input.

15. The electronic device of claim 14 wherein the at least one processing device is configured to:

select, in the lower-power mode of operation, a first action indication upon determination that the touch input has been modified from occurrence within the first area to occurrence within the second area;

select, in the lower-power mode of operation, a second action indication upon determination that the touch input has been modified from occurrence within the first area to occurrence within a third area of the touch screen display that is within the second partial region and distinct from the second area; and

store, in the lower-power mode of operation, the selected action indication.

16. The electronic device of claim 15 wherein the at least one application processor is configured to receive and store a plurality of graphics in the at least one memory device in the higher-power mode of operation;

wherein the at least one processing device is configured to:

select, in the lower-power mode of operation, the graphic from the plurality of graphics based on graphic selection criteria associated with the electronic device; and

store, in the lower-power mode of operation, the graphic selection criteria with the user interaction data for the graphic.

17. The electronic device of claim 16 wherein upon a trigger action during the lower-power mode of operation, the at least one processing device is configured to:

select, in the lower-power mode of operation, the graphic from the plurality of graphics;

provide, in the lower-power mode of operation, the at least one first control signal to the touch screen display;

wherein the graphic selection criteria comprises at least one of a trigger action type that indicates the trigger action, a time of the trigger action, or a date of the trigger action.

18. An electronic device comprising:

a touch screen display;

an application processor configured to control the touch screen display in a higher-power mode of operation;

a sensor hub configured to control the touch screen display in an lower-power mode of operation; and

a non-transitory memory;

wherein the electronic device is configured to actively control the touch screen display in the higher-power mode of operation with the application processor;

wherein the electronic device is configured to discontinue actively controlling the touch screen display in the higher-power mode of operation with the application processor to enter the lower-power mode of operation;

wherein the sensor hub is configured to provide, in the lower-power mode of operation, at least one first control signal to the touch screen display;

wherein the touch screen display is configured to activate, in the lower-power mode of operation and in response to the at least one first control signal, a first portion of the touch screen display;

wherein the touch screen display is configured to display, in the lower-power mode of operation and in response to the at least one first control signal, a first portion of an graphic on a first area of the touch screen display that is within the first portion of the touch screen display;

wherein the sensor hub is configured to determine, in the lower-power mode of operation, whether a first user interaction that corresponds to the first portion of the graphic has occurred during the display of the first portion of the graphic;

wherein the sensor hub is configured to store, in the lower-power mode of operation, user interaction data for the first portion of the graphic based on the first user interaction determination.

19. The electronic device of claim 18 wherein the sensor hub is configured to determine that a first touch input has occurred that corresponds to the first area;

wherein the sensor hub is configured to determine a duration of the first touch input;

wherein the sensor hub is configured to store the duration of the first touch input with the user interaction data;

wherein the sensor hub is configured to provide, in the lower-power mode of operation and in response to the first touch input, at least one second control signal to the touch screen display;

wherein the touch screen display is configured to activate, in the lower-power mode of operation and in response to the at least one second control signal, a second portion of the touch screen display;

wherein the touch screen display is configured to display, in the lower-power mode of operation and in response to the at least one second control signal, a second portion of the

graphic on a second area of the touch screen display that is within the second portion of the touch screen display;

wherein the sensor hub is configured to determine, in the lower-power mode of operation, whether a second touch input has occurred that corresponds to the second area or a third area of the touch screen display that is distinct from the second area;

wherein the sensor hub is configured to store, in the lower-power mode of operation, the user interaction data with an action indication that indicates whether the second touch input has occurred and in which area it occurred.

20. The electronic device of claim 18 wherein the application processor is configured to send the user interaction data to a remote network entity.

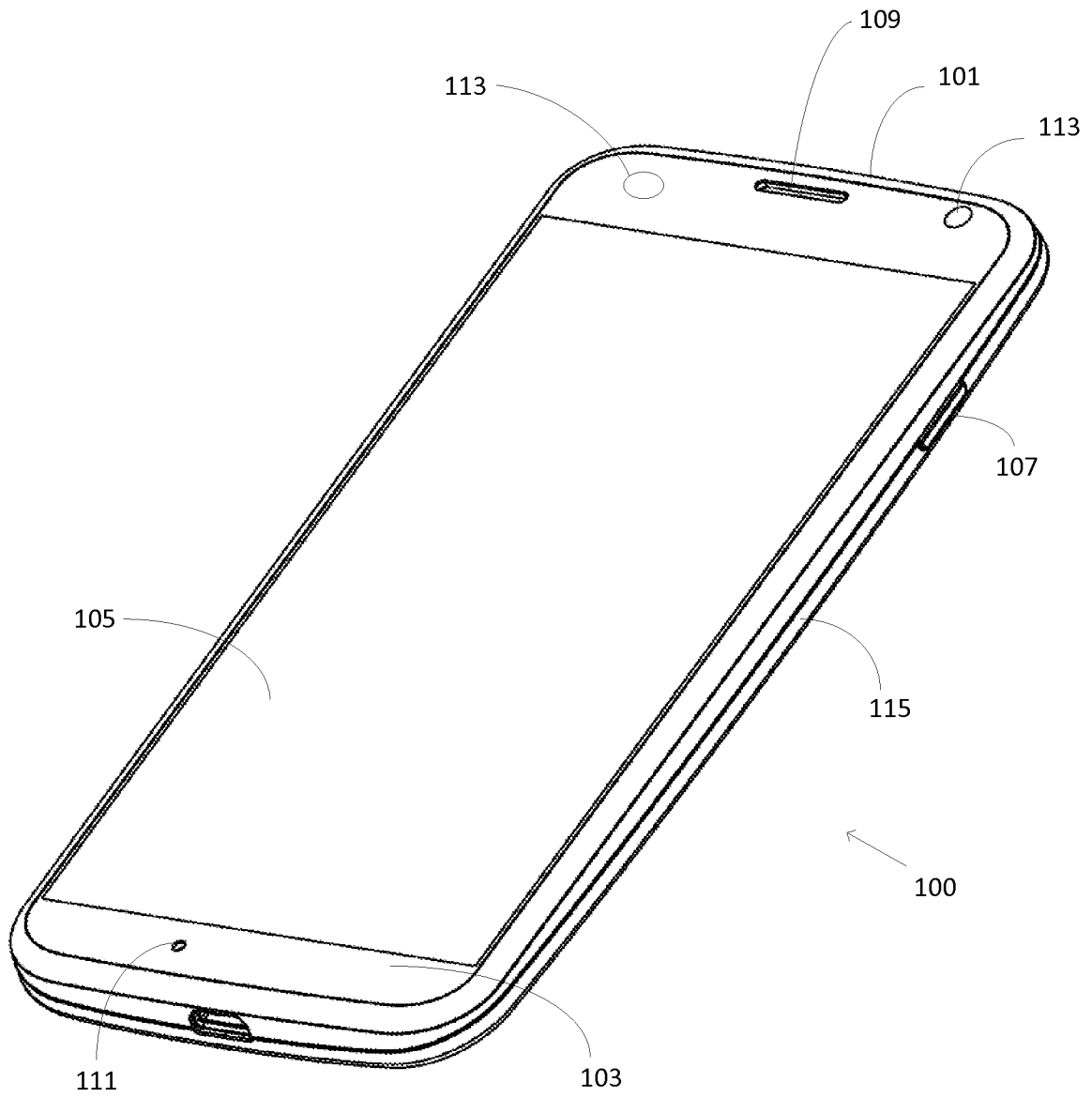

FIG. 1

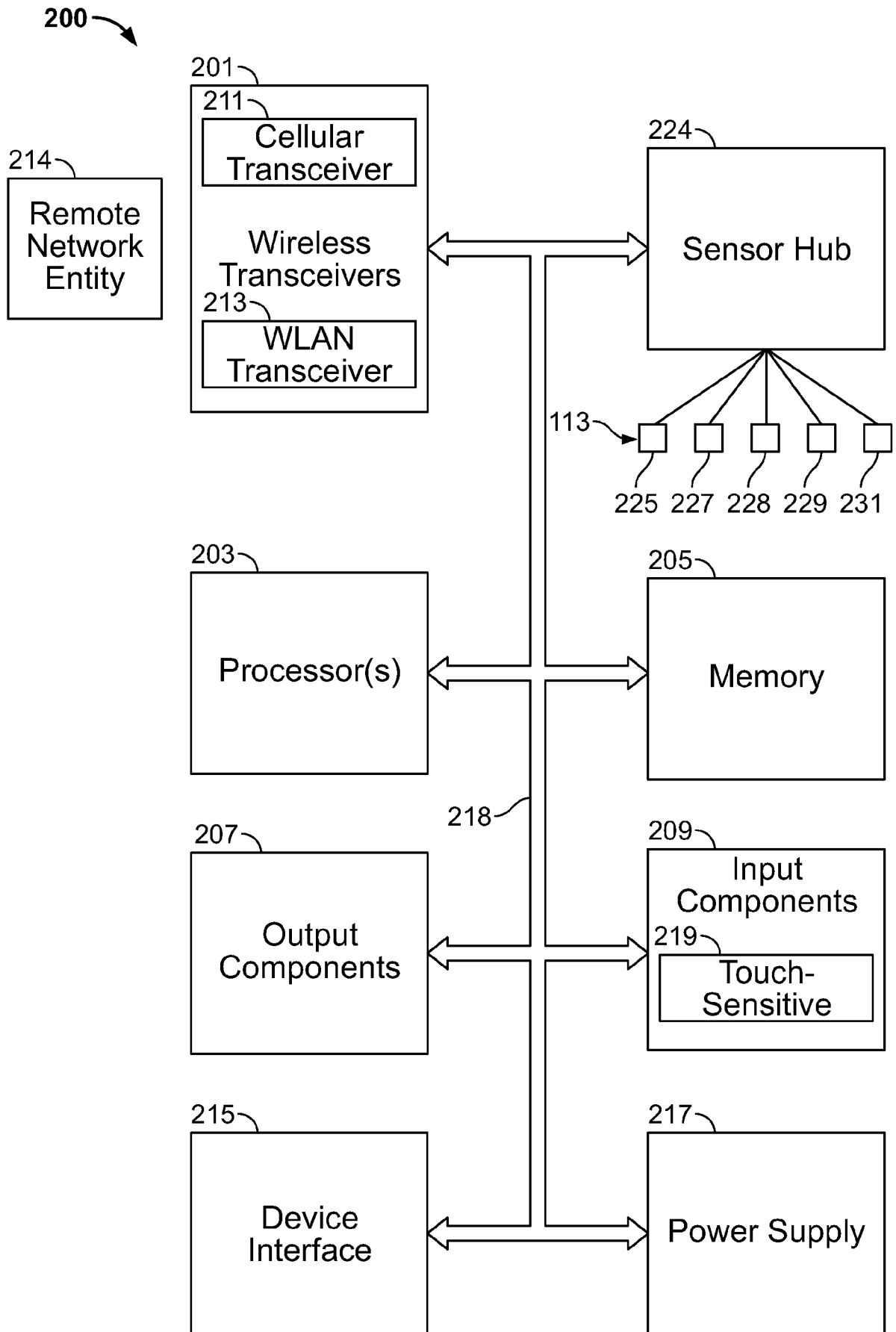

FIG. 2
SUBSTITUTE SHEET (RULE 26)

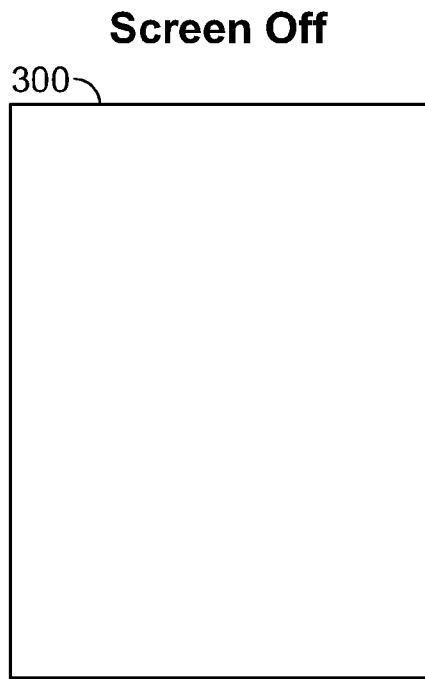

FIG. 3A

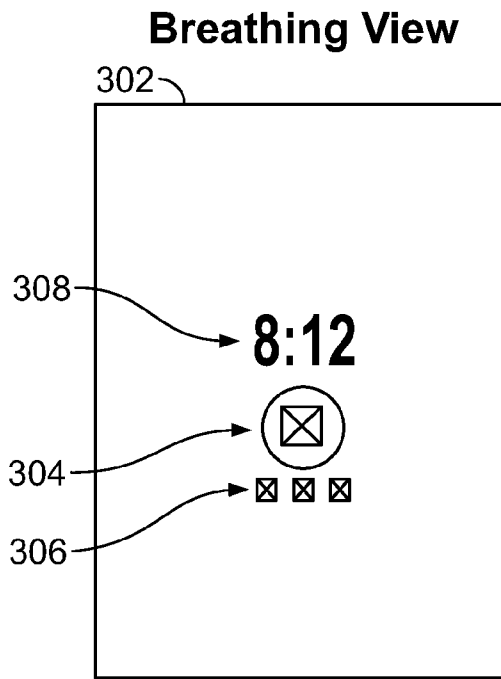

FIG. 3B

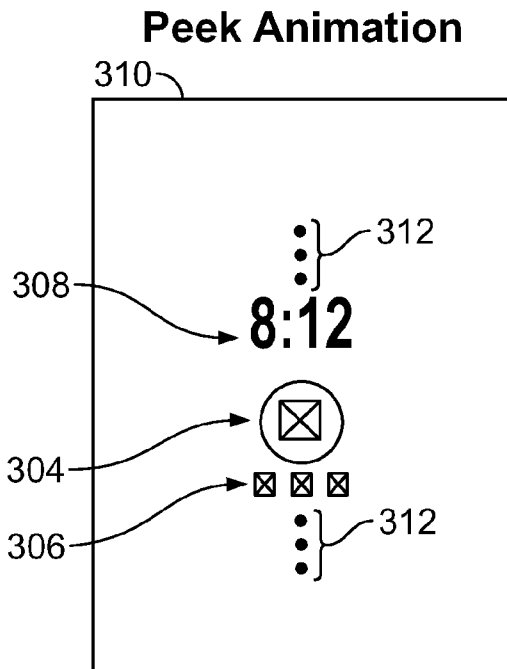

FIG. 3C

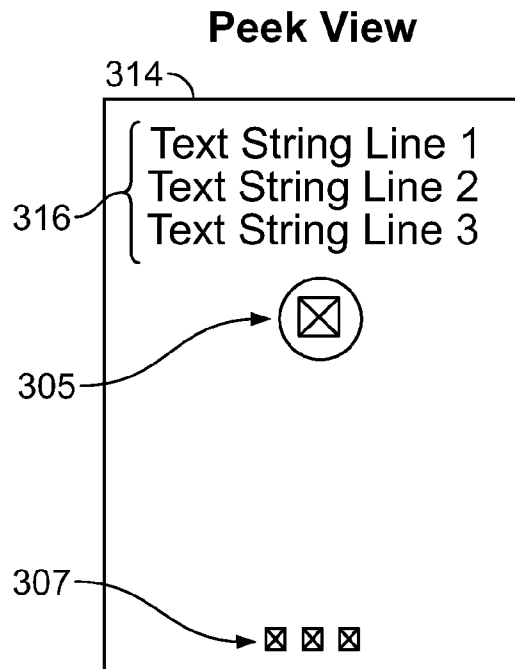

FIG. 3D

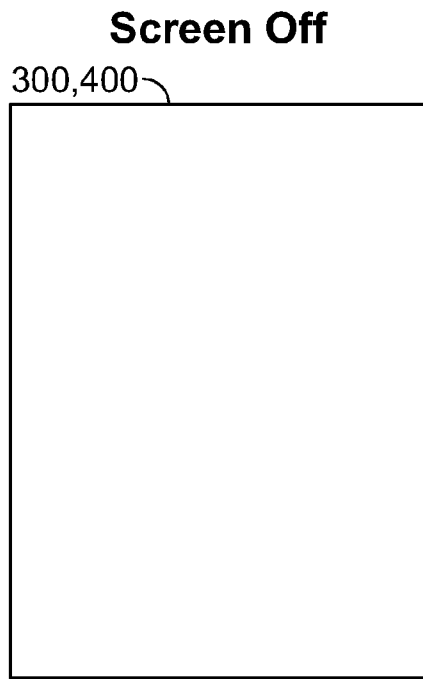

FIG. 4A

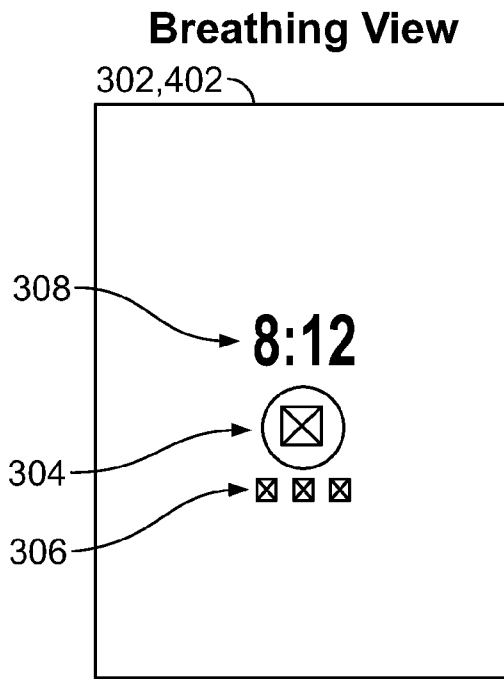

FIG. 4B

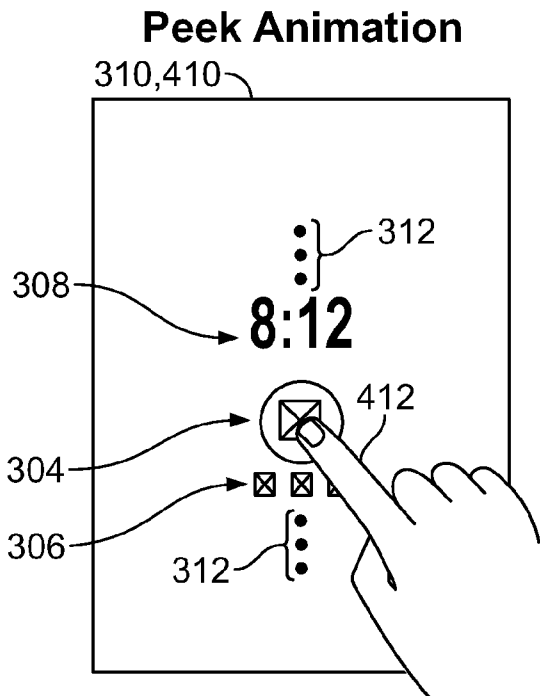

FIG. 4C

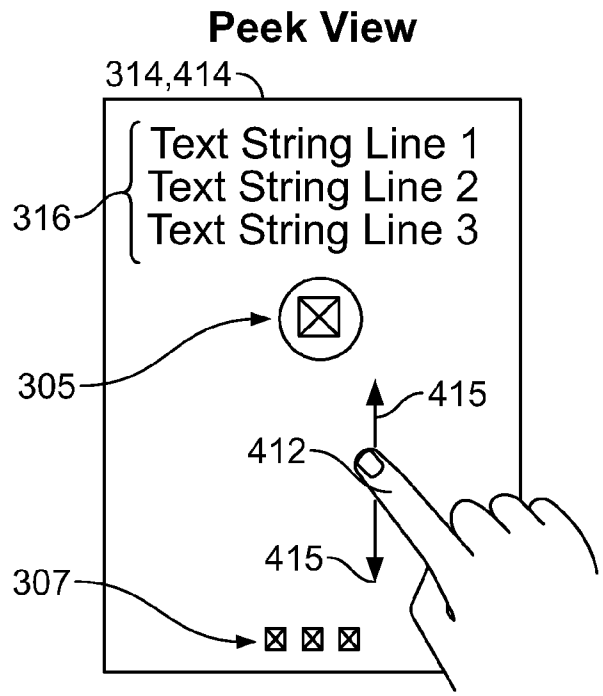

FIG. 4D

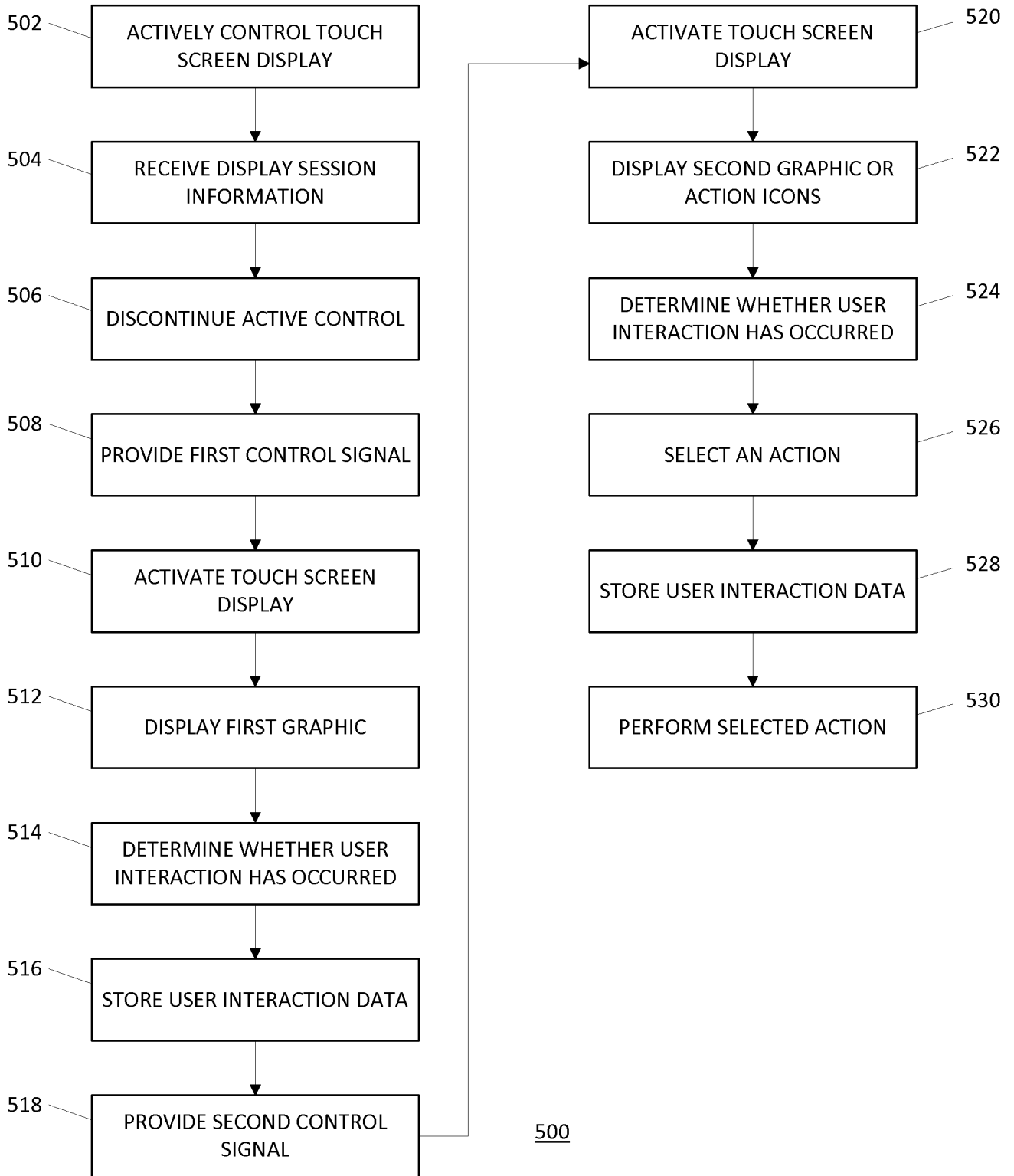

FIG. 5

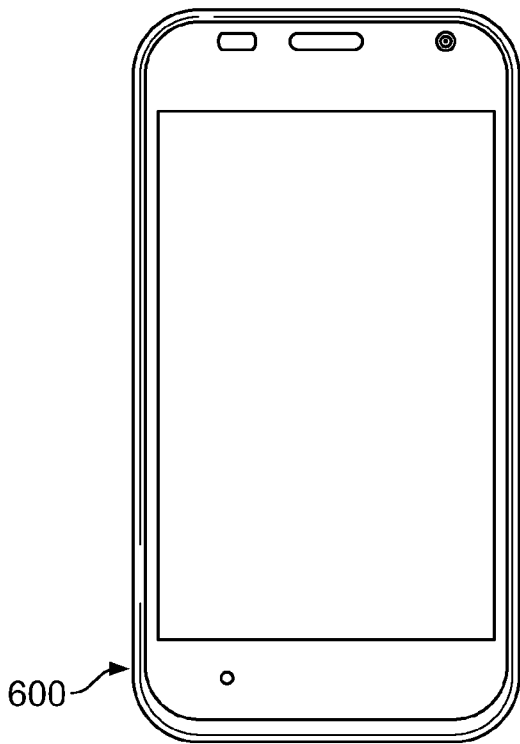

FIG. 6A

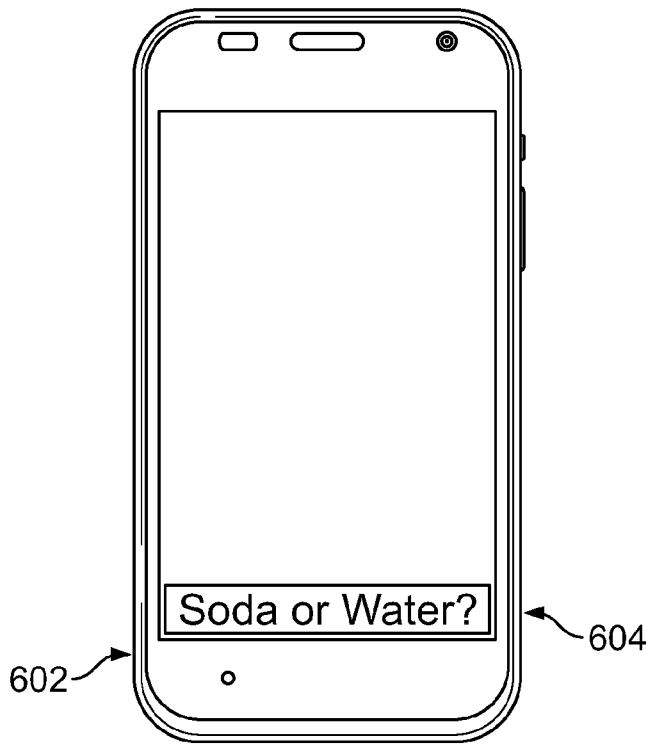

FIG. 6B

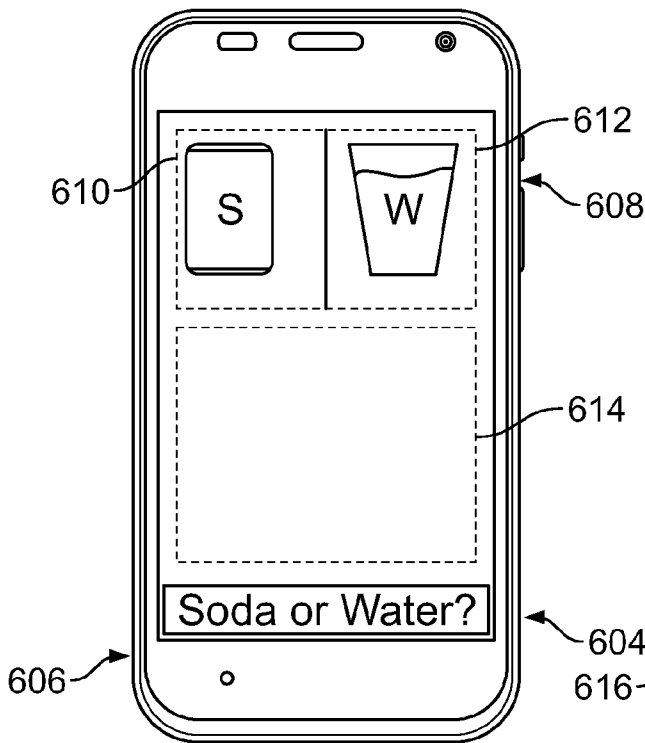

FIG. 6C

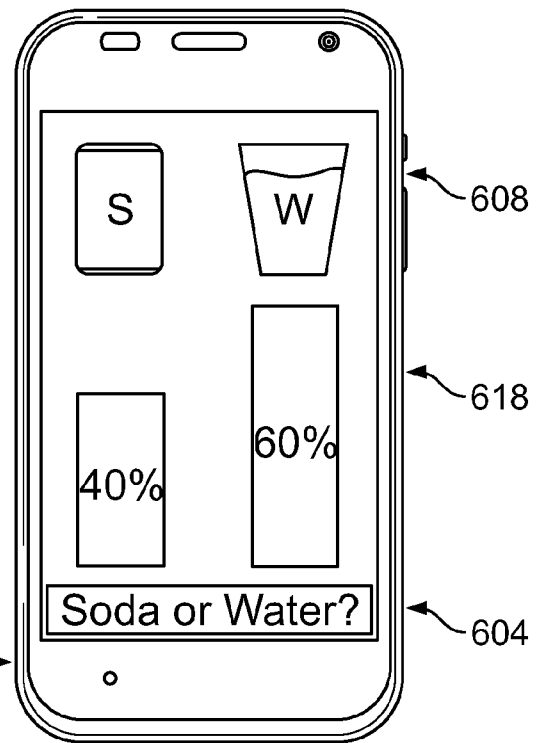

FIG. 6D

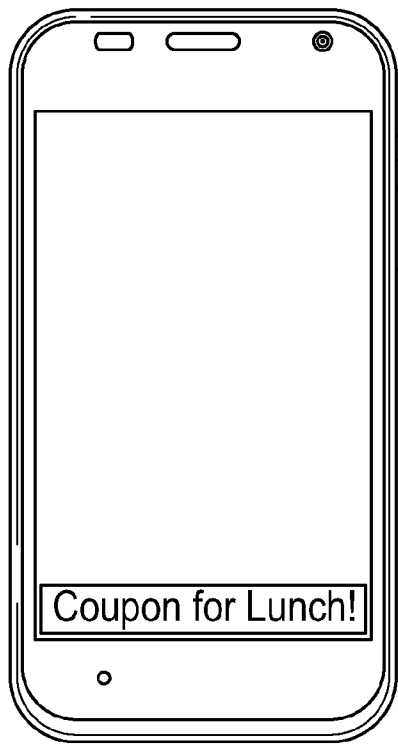

FIG. 7A

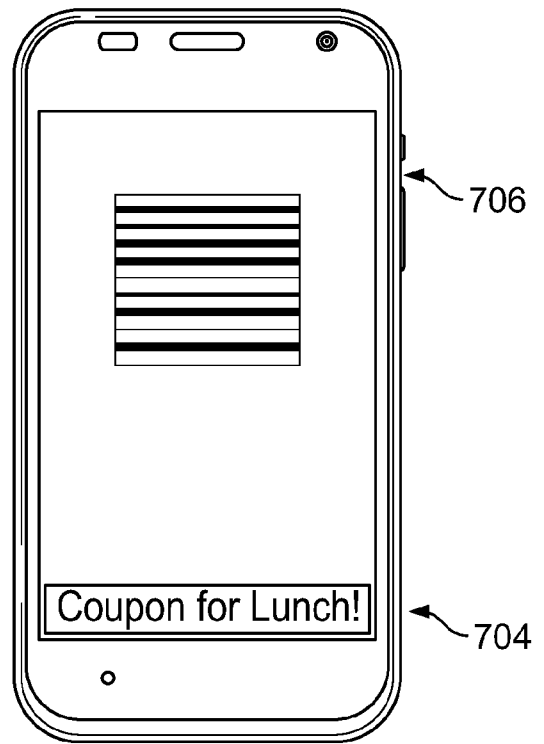

FIG. 7B

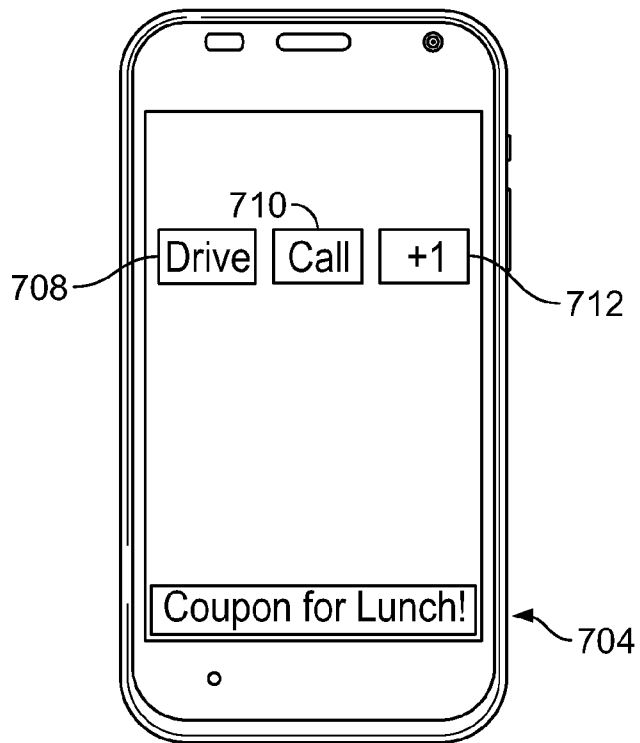

FIG. 7C

800

Primary Ad ID	Secondary Ad ID	Action 1	Action 2	Action 3	User ID	Device Model	Time of Day	Device Location	Wake Reason	View Duration	Action Taken
25729	1	Share	Join	Remind	2536	DVX	12:30	42 17 20 N, 87 59 45 W	Pocket	0	0
25729	1	Pin	Remind	+1	7245	DVX	14:22	42 17 20 N, 87 59 45 W	Pocket	0	0
25729	1	Pin	Remind	+1	1574	DVX	7:12	42 17 20 N, 87 59 45 W	Movement	2.2	3
25729	2	Call	Navigate	Share	3784	ELX	4:53	42 17 20 N, 87 59 45 W	Pocket	0	0
25729	2	Call	Navigate	Share	135	ELX	22:12	42 17 20 N, 87 59 45 W	Movement	2.9	1
25729	3	Web	Join	Navigate	9725	DVX	9:44	42 17 20 N, 87 59 45 W	Movement	1.5	2
25729	3	Join	Web	Call	2573	DVX	11:15	42 17 20 N, 87 59 45 W	Movement	2.3	2
25730	1	Web	-	-	4567	DVX	1:32	42 17 20 N, 87 59 45 W	Pocket	0	0
25730	1	Web	-	-	7653	ELX	8:19	42 17 20 N, 87 59 45 W	Movement	0	0
25730	1	Web	Download	-	8653	DVX	10:29	42 17 20 N, 87 59 45 W	Pocket	2.6	2
25730	1	Web	Download	-	5267	ELX	18:34	42 17 20 N, 87 59 45 W	Pocket	1.9	2
25730	1	Web	Download	Save	9764	DVX	16:54	42 17 20 N, 87 59 45 W	Movement	0	0
25730	4	Web	Download	Call	9760	DVX	0:54	42 17 20 N, 87 59 45 W	Movement	0	0

FIG. 8

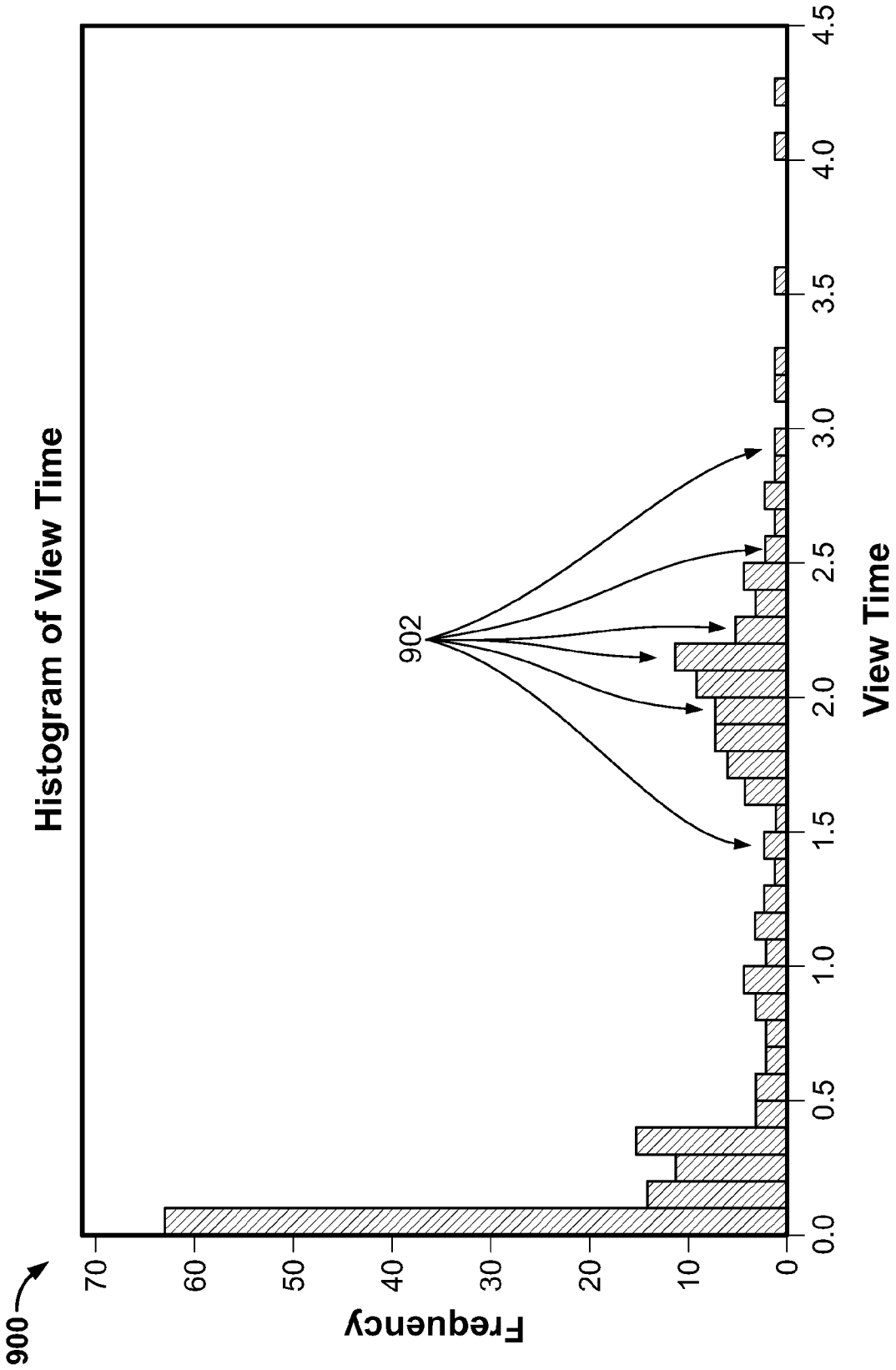

FIG. 9