



US00D892734S

(12) **United States Design Patent**
Cheung et al.

(10) **Patent No.:** **US D892,734 S**

(45) **Date of Patent:** **** Aug. 11, 2020**

(54) **CHARGING DOCK**

FOREIGN PATENT DOCUMENTS

(71) Applicant: **JUUL Labs, Inc.**, San Francisco, CA (US)

CN	101861691 A	10/2010
CN	202004499 U	10/2011
JP	2001165437 A	6/2001

(72) Inventors: **Brandon Cheung**, San Francisco, CA (US); **Claire O'Malley**, San Francisco, CA (US)

OTHER PUBLICATIONS

(73) Assignee: **JUUL Labs, Inc.**, San Francisco, CA (US)

Lotsberg, M. Juul Vapor E-Cig Unboxing, Set Up & First Impressions with Virginia Tobacco, Youtube, Published Oct. 11, 2017. Available at: <https://www.youtube.com/watch?v=vX9W7Vq-DBk>.

(**) Term: **15 Years**

(Continued)

(21) Appl. No.: **29/673,722**

Primary Examiner — Rosemary K Tarcza

Assistant Examiner — Christy M Nemeth

(22) Filed: **Dec. 17, 2018**

(74) *Attorney, Agent, or Firm* — Mintz Levin Cohn Ferris Glovsky and Popeo, P.C.

(51) **LOC (12) Cl.** **13-02**

(52) **U.S. Cl.**
USPC **D13/108**

(58) **Field of Classification Search**

USPC D13/103-110, 118, 119, 184, 199;
D14/251, 253, 432, 434
CPC Y02E 60/10; Y02E 60/12; Y02E 60/122;
Y02E 60/124; Y02E 60/50; H01M 2/02;
H01M 2/022; H01M 2/0202; H01M
2/0207; H01M 2/0212; H01M 2/1061;
H01M 2/1022; H01M 2/1055; H01M
2/1066; H01M 2/105; H01M 2/20; H01M
2/202; H01M 2/204; H01M 2/206; H01M
10/44; H01M 10/46; H01M 10/465;
H01M 10/482; H01M 2200/30; H01M
2250/30; H01M 2250/40; H02J 7/00;
H02J 7/0003; H02J 7/0011; H02J 7/0013;
H02J 7/0054; H02J 7/0055; H02J 7/0057;
H02J 2007/0062

See application file for complete search history.

(57) **CLAIM**

The ornamental design for a charging dock, as shown and described.

DESCRIPTION

FIG. 1 is a top, front, and left side perspective view of a charging dock of our design;
FIG. 2 is a bottom, rear, and left side perspective view thereof;
FIG. 3 is a top view thereof;
FIG. 4 is a bottom view thereof;
FIG. 5 is a right side view thereof;
FIG. 6 is a left side view thereof;
FIG. 7 is a rear view thereof; and,
FIG. 8 is a front view thereof.

The dashed broken lines illustrate portions of the charging dock that form no part of the claimed design.
FIGS. 1-8 of the charging dock are illustrated to show contrasting appearance. The gray-shaded area represents areas of the charging dock having a first appearance and the white areas in solid lines represent areas of the charging dock having a second appearance.

(56) **References Cited**

U.S. PATENT DOCUMENTS

969,076 A	8/1910 Pender
2,459,656 A	1/1949 Jack

(Continued)

1 Claim, 6 Drawing Sheets

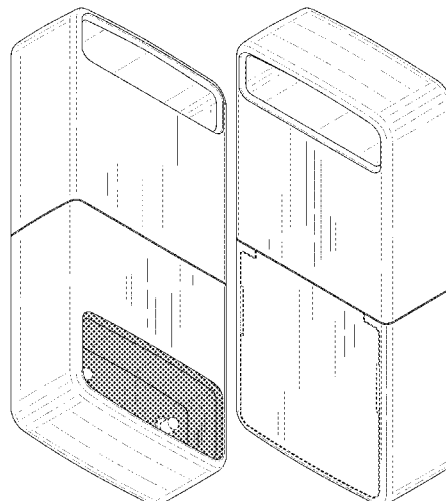

(56)

References Cited

U.S. PATENT DOCUMENTS

4,241,742 A 12/1980 Hilding
 D292,437 S 10/1987 Wind, III
 D327,248 S 6/1992 Hotsumi et al.
 D359,474 S 6/1995 Palatov
 D361,069 S 8/1995 Hellier et al.
 5,529,078 A 6/1996 Rehder et al.
 D375,936 S 11/1996 Palatov
 D458,409 S 6/2002 Najar et al.
 6,743,030 B2 6/2004 Lin et al.
 D500,302 S 12/2004 Deguchi
 D514,741 S 2/2006 Cohen Harel
 D521,445 S 5/2006 Liu
 D529,044 S 9/2006 Andre et al.
 D532,776 S 11/2006 Griffin
 D542,789 S 5/2007 Depay
 7,214,075 B2 5/2007 He et al.
 7,275,941 B1 10/2007 Bushby
 D557,209 S 12/2007 Ahlgren et al.
 D576,619 S 9/2008 Udagawa et al.
 D577,019 S 9/2008 Udagawa et al.
 D579,934 S 11/2008 Okamoto et al.
 D591,758 S 5/2009 Lee
 D607,403 S 1/2010 Hara et al.
 D609,638 S 2/2010 Biheller et al.
 D610,588 S 2/2010 Chen
 7,753,055 B2 7/2010 Bryman
 D624,012 S 9/2010 de Medeiros et al.
 D629,355 S 12/2010 Bodley et al.
 D631,055 S 1/2011 Gilbert et al.
 D631,883 S 2/2011 Maier
 D631,885 S 2/2011 Maier
 D633,436 S 3/2011 Griffin, Jr.
 D635,142 S 3/2011 Borislow
 7,905,236 B2 3/2011 Bryman et al.
 D638,430 S 5/2011 Lee et al.
 D639,303 S 6/2011 Ni et al.
 D647,907 S 11/2011 Perry et al.
 D648,707 S 11/2011 Akana et al.
 D648,726 S 11/2011 Behar et al.
 D655,708 S 3/2012 Frank
 D656,094 S * 3/2012 Wu D13/108
 D656,459 S 3/2012 Crawley
 D682,841 S 5/2013 Suetake et al.
 D683,899 S * 6/2013 Liu D13/108
 D686,987 S 7/2013 Vanstone et al.
 D687,042 S 7/2013 Yoneta et al.
 D692,615 S 10/2013 Verleur

D703,679 S 4/2014 Chen
 D704,634 S 5/2014 Eidelman et al.
 D707,688 S 6/2014 Wu
 D711,389 S 8/2014 Sun et al.
 D711,891 S 8/2014 Emami et al.
 D725,124 S 3/2015 Lin et al.
 9,032,968 B2 5/2015 Glasberg et al.
 D744,419 S 12/2015 Bowen et al.
 D747,265 S 1/2016 Marini
 D749,510 S 2/2016 Liu
 D773,989 S * 12/2016 Schiff D13/107
 D790,455 S * 6/2017 McGarry D13/107
 9,723,877 B2 8/2017 Wong et al.
 D806,021 S * 12/2017 Xu D13/107
 D813,803 S * 3/2018 Massar D13/108
 D813,806 S 3/2018 Ito et al.
 D815,593 S 4/2018 Alves et al.
 D816,606 S * 5/2018 Georgiades D13/108
 D821,972 S * 7/2018 Wei D13/108
 10,045,568 B2 8/2018 Monsees et al.
 10,058,124 B2 8/2018 Monsees et al.
 10,058,129 B2 8/2018 Monsees et al.
 D836,831 S 12/2018 Cividi
 D836,834 S 12/2018 Cividi
 D844,559 S * 4/2019 Mercer D13/107
 D853,325 S 7/2019 Xu
 D861,601 S * 10/2019 Lin D13/108
 2005/0029137 A1 2/2005 Wang
 2006/0288169 A1 12/2006 Steiner
 2007/0229025 A1 10/2007 Tsai et al.
 2010/0301032 A1 12/2010 Johnson
 2012/0018529 A1 1/2012 Gammon et al.
 2012/0188687 A1 7/2012 Yamamoto
 2014/0014124 A1 1/2014 Glasberg et al.
 2014/0021190 A1 1/2014 Sardar
 2015/0167976 A1 6/2015 Recio
 2015/0208729 A1 7/2015 Monsees et al.

OTHER PUBLICATIONS

Pierce, D. This Might Just Be the First Great E-Cig. {online} Wired, Published on Apr. 21, 2015. Available at: https://www.wired.com/2015/04/pax-juul-ecig/?mbid=social_twitter.
 Robinson, M. How a startup behind the iPhone of vaporizers' reinvented the e-cigarette and generated \$224 million in sales in a year. Business Insider, Published on Nov. 21, 2017. Available at: <https://www.businessinsider.com/juul-e-cigarette-one-million-units-sold-2017-11>.

* cited by examiner

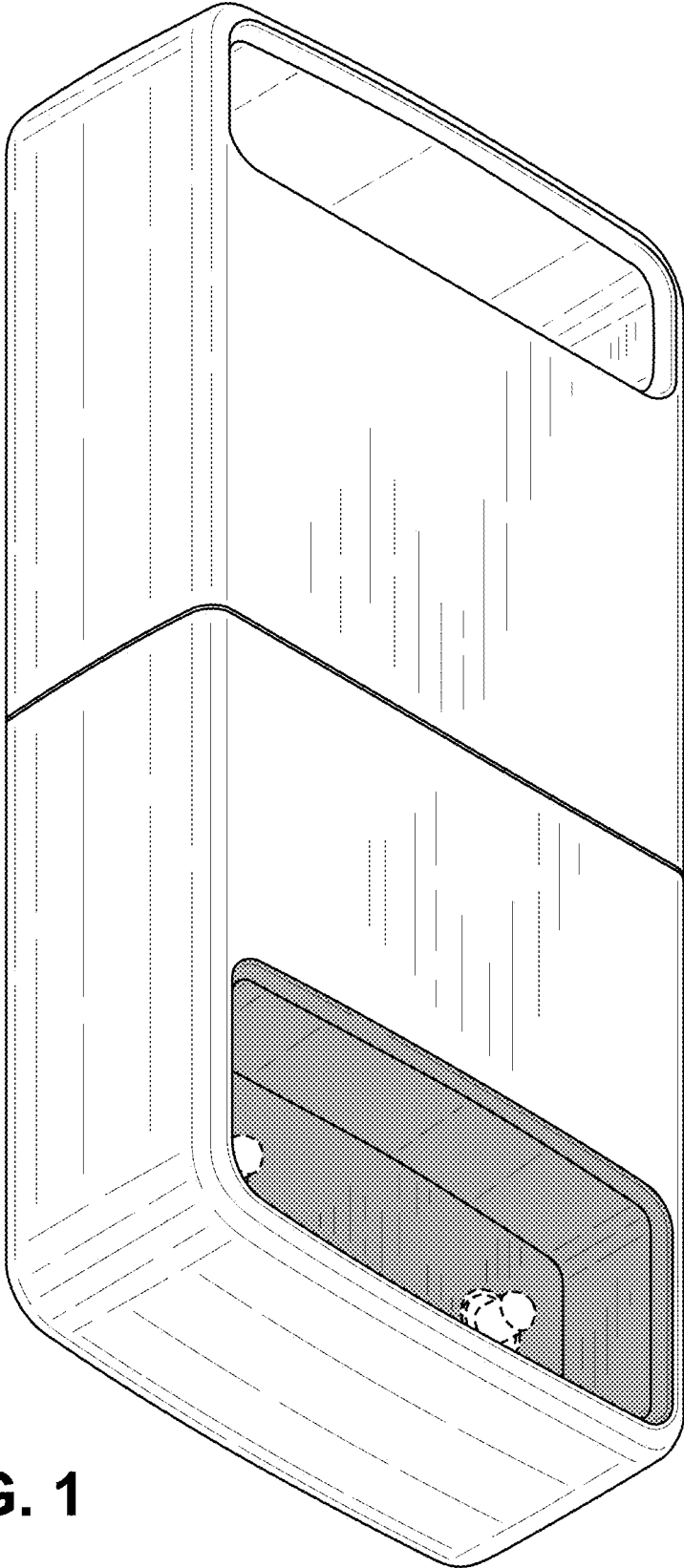

FIG. 1

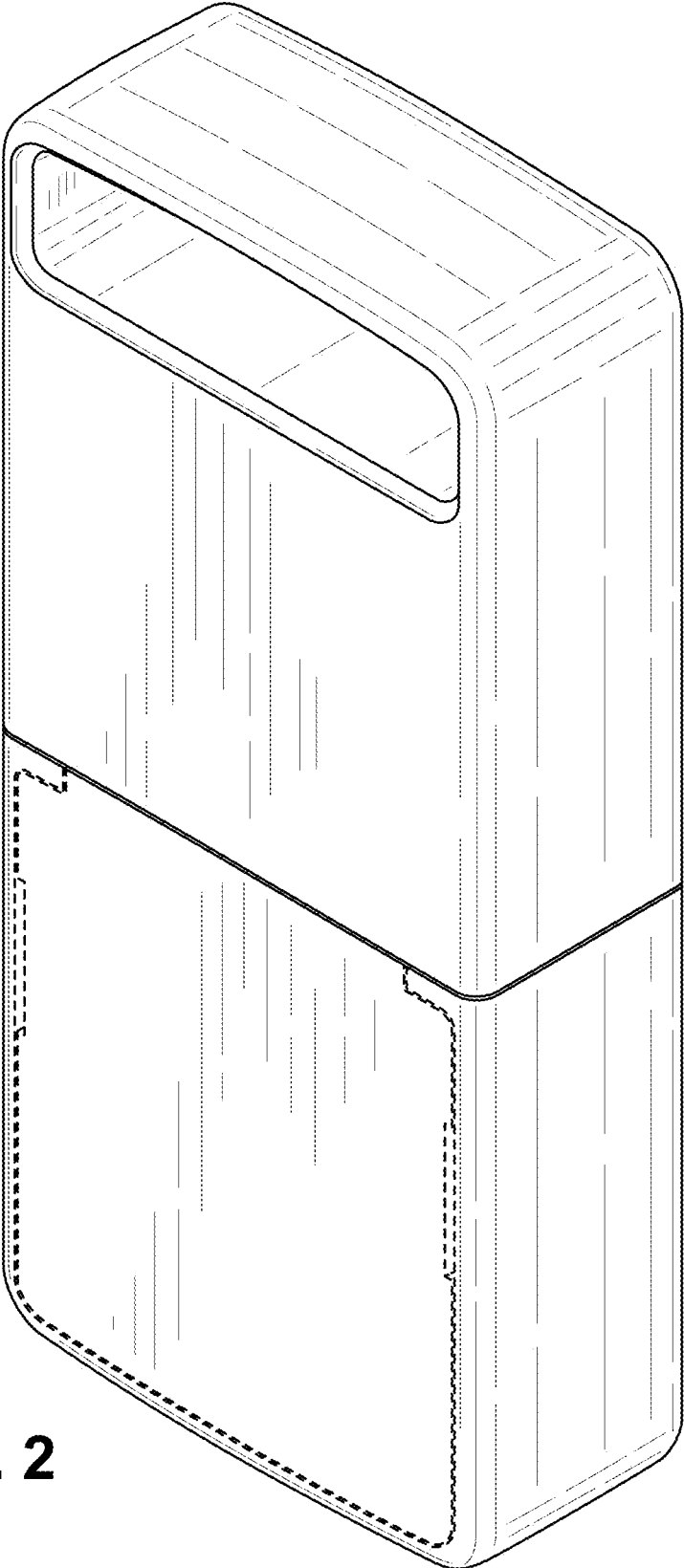

FIG. 2

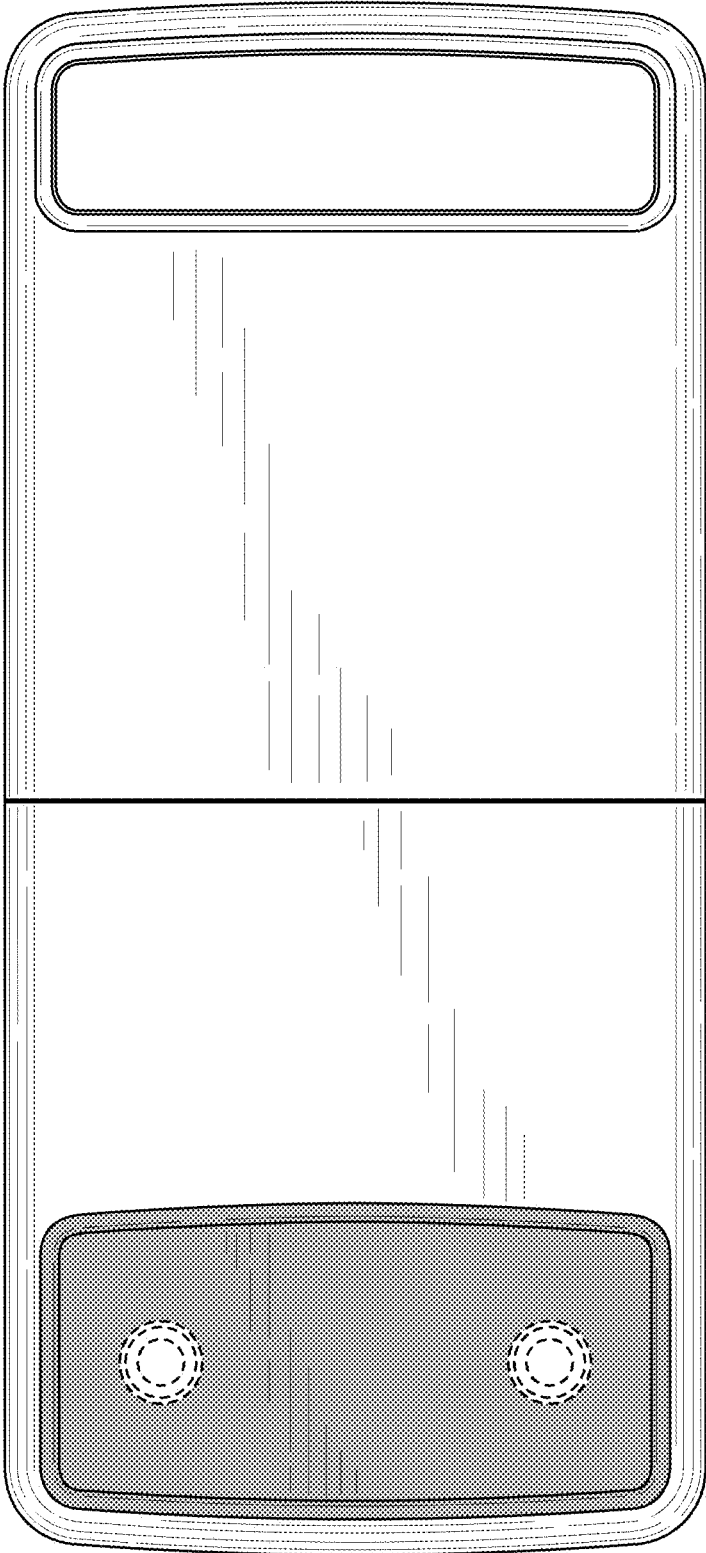

FIG. 3

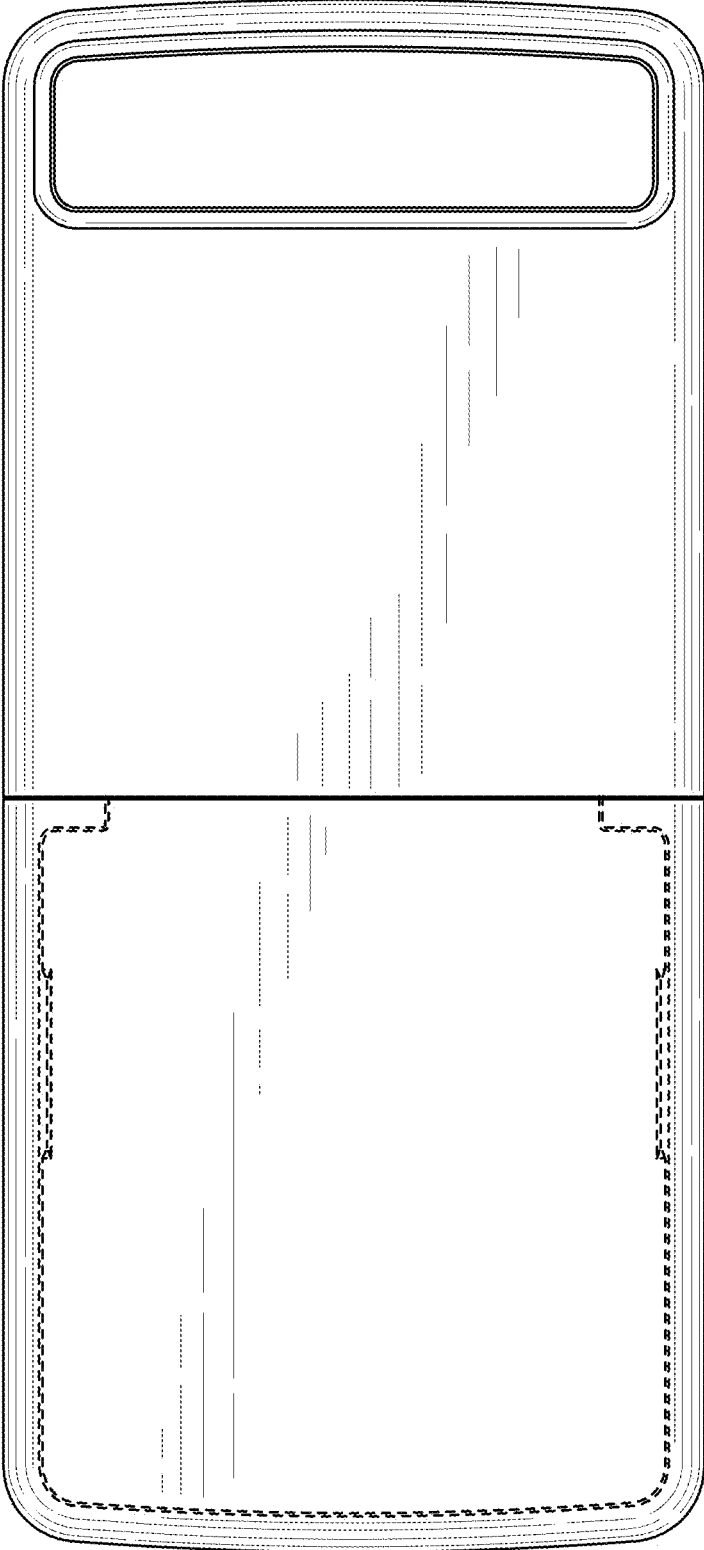

FIG. 4

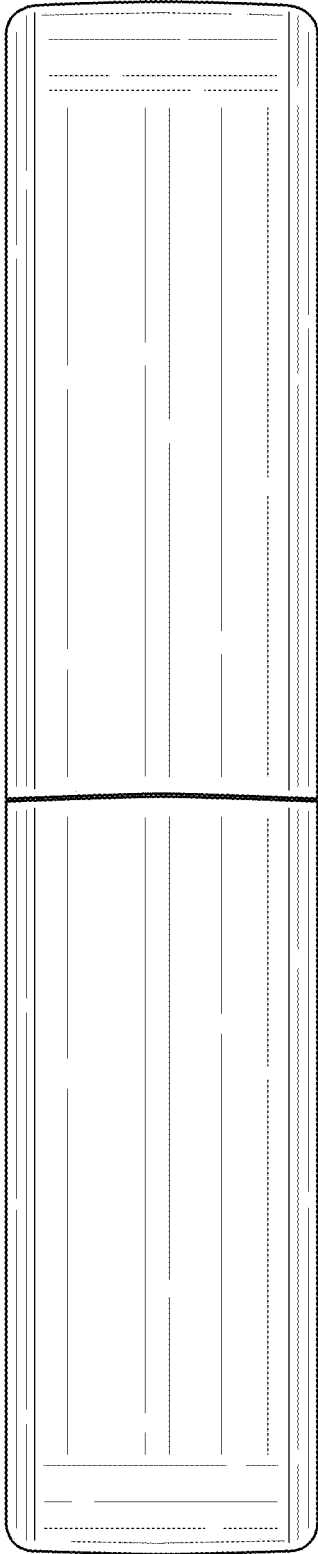

FIG. 5

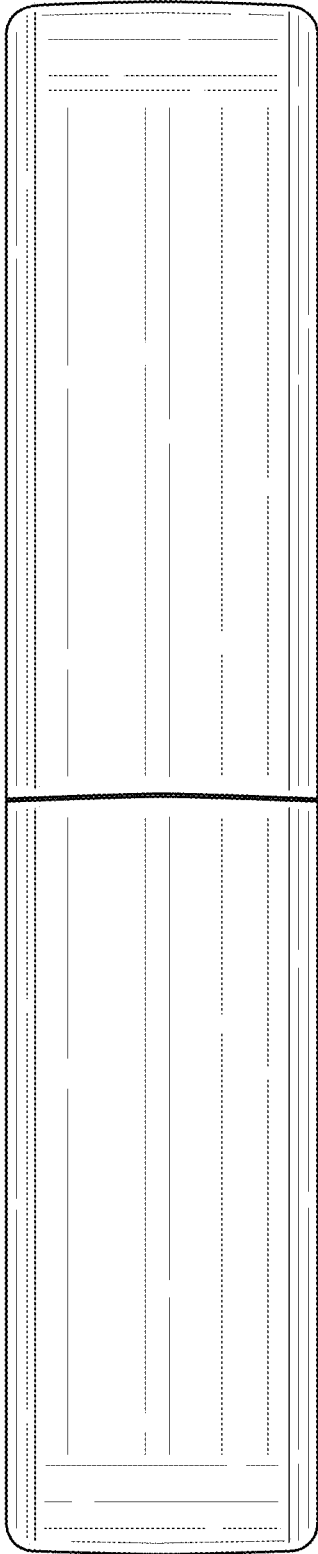

FIG. 6

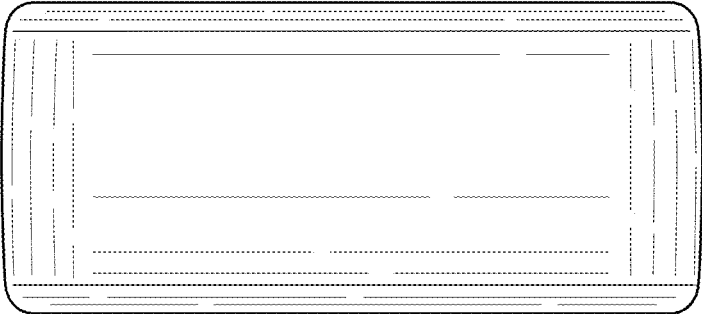

FIG. 7

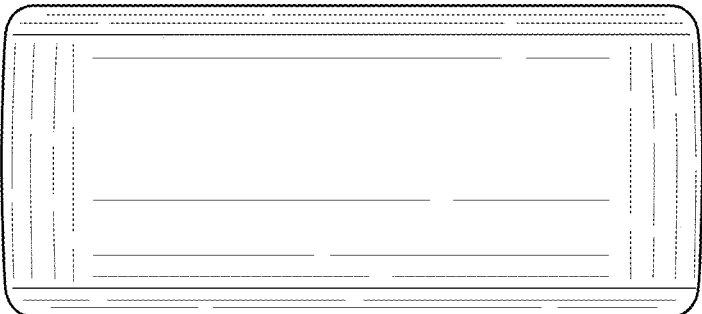

FIG. 8