



US00D398128S

United States Patent [19]

[11] Patent Number: **Des. 398,128**

Laivins et al.

[45] Date of Patent: ****Sep. 8, 1998**

[54] **CART BODY**

4,511,154	4/1985	Daloisio	280/47.26
4,635,956	1/1987	Morrisette	280/652
4,645,225	2/1987	Eubanks	280/47.31
4,740,008	4/1988	Johnson	280/475
4,889,360	12/1989	Haviovitz	280/655.1

[75] Inventors: **Glen A. Laivins; Kenneth T. Laivins**, both of Reynoldsburg; **Jon Mandell**, North Canton, all of Ohio

[73] Assignee: **Rubbermaid Incorporated**, Wooster, Ohio

[**] Term: **14 Years**

FOREIGN PATENT DOCUMENTS

2604377	12/1979	Australia .
8602326	4/1986	WIPO .
9418049	8/1994	WIPO .

[21] Appl. No.: **74,093**

OTHER PUBLICATIONS

[22] Filed: **Jul. 24, 1997**

Sell sheet, Cart; Kadco USA, P. O. Box 2307, Wilton, New York 12866. Published at least as early as 1988.

[51] **LOC (6) Cl.** **12-02**

Sell sheet, Cart, Lambert Corporation, 117 South Third Street, Ansonia, Ohio 45303. Published at least as early as 1988.

[52] **U.S. Cl.** **D34/27; D34/25**

Sell sheet, Cart, Garden Way, address unknown. Published at least as early as 1988.

[58] **Field of Search** D34/12-27; 280/47.12, 280/47.18, 47.23, 47.24, 47.28, 47.26, 652; 298/2, 5

Sell sheet, Cart, Cantico Manufacturing Co., 1101 Warson Road, St. Louis, Missouri 63132. Published at least as early as 1988.

[56] **References Cited**

Sell sheet, Cart; Dan's Saddlery Corp. 65 Mahan Street, West Babylon, New York 11704. Published at least as early as 1988.

U.S. PATENT DOCUMENTS

D. 175,069	7/1955	Gandola	D14/3
D. 309,812	8/1990	Wolters et al.	D34/26
D. 311,621	10/1990	Fuller	D34/18
D. 318,165	7/1991	Ayres	D34/26
D. 318,551	7/1991	Ayres	D34/24
D. 321,579	11/1991	Ayres	D34/26
D. 325,549	4/1992	Jarvis	D12/105
D. 327,350	6/1992	Brown et al.	D34/16
D. 349,797	8/1994	Daugherty	D34/16
D. 352,584	11/1994	Boyd	D34/16
D. 352,722	11/1994	Mandell et al.	D15/27
D. 355,515	2/1995	Spear et al.	D34/16
D. 356,411	3/1995	Gingras et al.	D34/16
D. 361,191	8/1995	Kowalski et al.	D34/27
D. 370,326	5/1996	Chapman et al.	D34/16
D. 373,748	9/1996	Fuller et al.	D12/105
2,102,684	12/1937	Dorward	280/51
3,479,048	11/1969	Carlson	280/47.23
3,578,806	5/1971	Tonelli	298/2
3,858,929	1/1975	Brescia	280/47.12
4,035,015	7/1977	Smith	296/28
4,261,596	4/1981	Douglas	280/652
4,335,897	6/1982	Muller, Jr.	280/47.18
4,417,765	11/1983	Wirsbinski	298/5

(List continued on next page.)

Primary Examiner—Kay H. Chin

Attorney, Agent, or Firm—Richard B. O'Planick

[57] CLAIM

The ornamental design for a cart body, as shown and described.

DESCRIPTION

FIG. 1 is a top left front perspective view of a cart body showing our new design;
FIG. 2 is a top plan view thereof;
FIG. 3 is a left side elevational view thereof; the right side elevational view being a mirror image;
FIG. 4 is a bottom plan view thereof;
FIG. 5 is a front elevational view thereof; and,
FIG. 6 is a rear elevational view thereof.

1 Claim, 5 Drawing Sheets

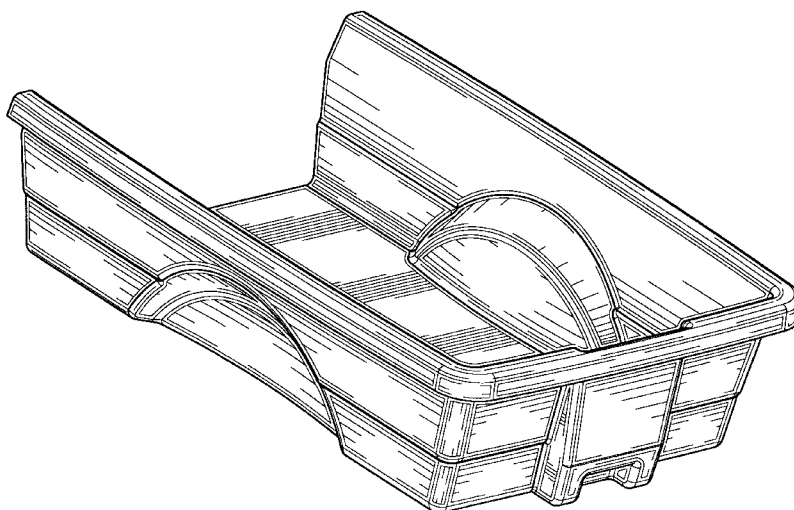

OTHER PUBLICATIONS

Sell sheet, Cart; Metal Products Co., P. O. Box 105, Cokato, Minnesota 55321. Published at least as early as 1988.

Sell sheet, Cart; Allegheny International Hardware Group, P. O. Box 3500, Shiremanstown, Pennsylvania 17011. Published at least as early as 1988.

Pp. 3 and 4, Carts; Kelley Manufacturing Co., 4800 Clinton Drive, Houston, Texas 77020. Published at least as early as 1988.

Catalog page, Carts; Sterling Handling Equipment Inc., 2300 West Florist Avenue, P. O. Box 09743, Milwaukee, Wisconsin 53209. Published at least as early as 1988.

Catalog page, Carts; Sterling Handling Equipment Inc., 2300 West Florist Avenue P. O. Box 09743, Milwaukee, Wisconsin 53209. Published at least as early as 1988.

Assembly instructions, Cart; Scenic Road Manufacturing, 3539 Scenic Road, Gordonville, Pennsylvania 17529. Published at least as early as Nov., 1992.

P. 46, Carts; Ames Lawn and Garden Tools, Catalog No. 21-990, Box 1774, Parkersburg, West Virginia 26101. Publication date May, 1986.

Sell sheet, Cart; Reese Products, Inc., P. O. Box 1706, 51671, State Route 19-N, Elkhart, Indiana 46515. Published at least as early as Jun., 1997.

Sell sheet, Cart; Plaschem supply & Consulting, 1415 Spar Avenue, Anchorage, Alaska 99501. Published at least as early as Jun., 1997.

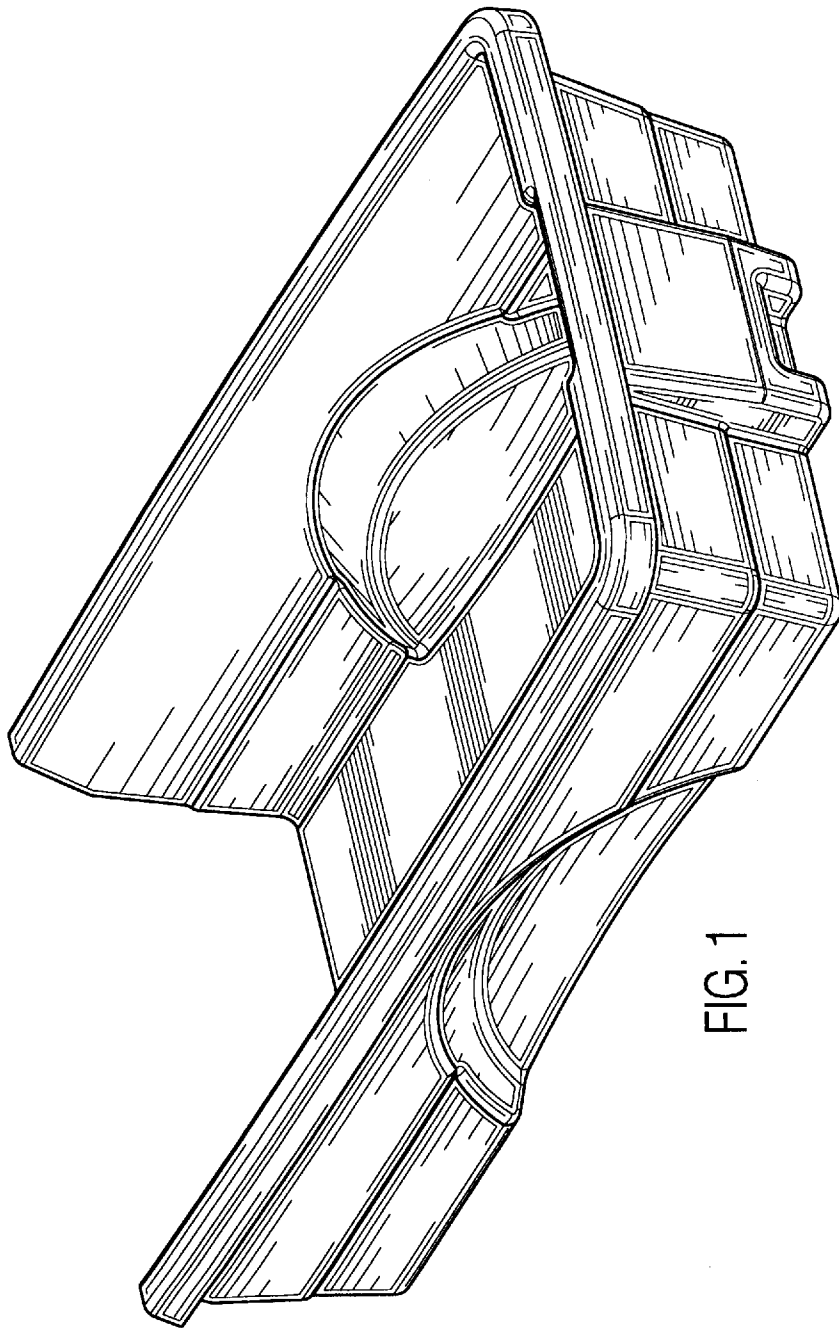

FIG. 1

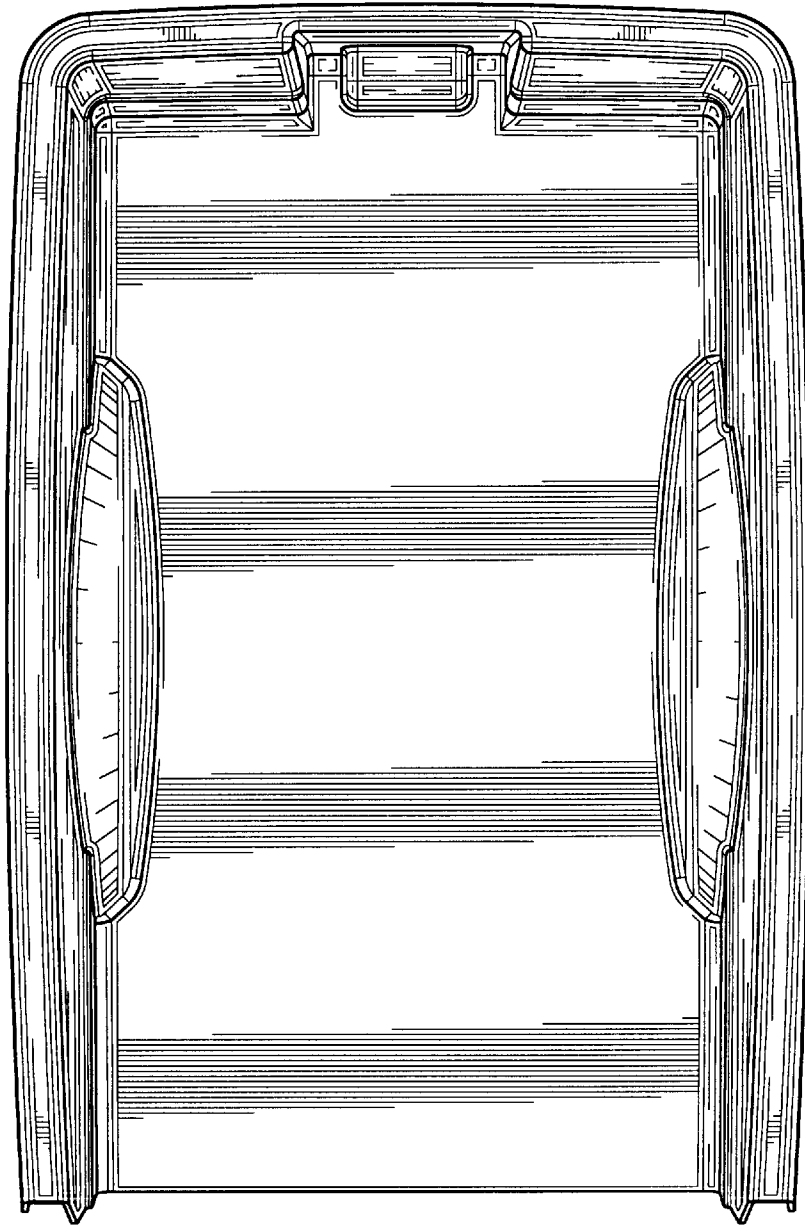

FIG. 2

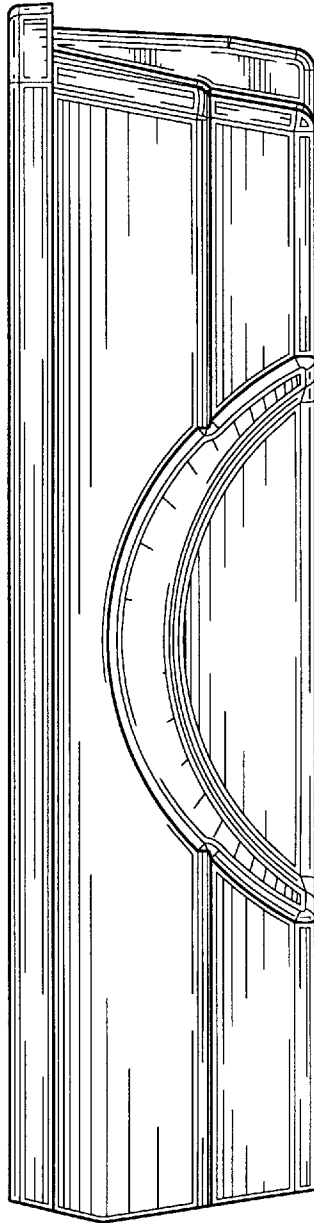

FIG. 3

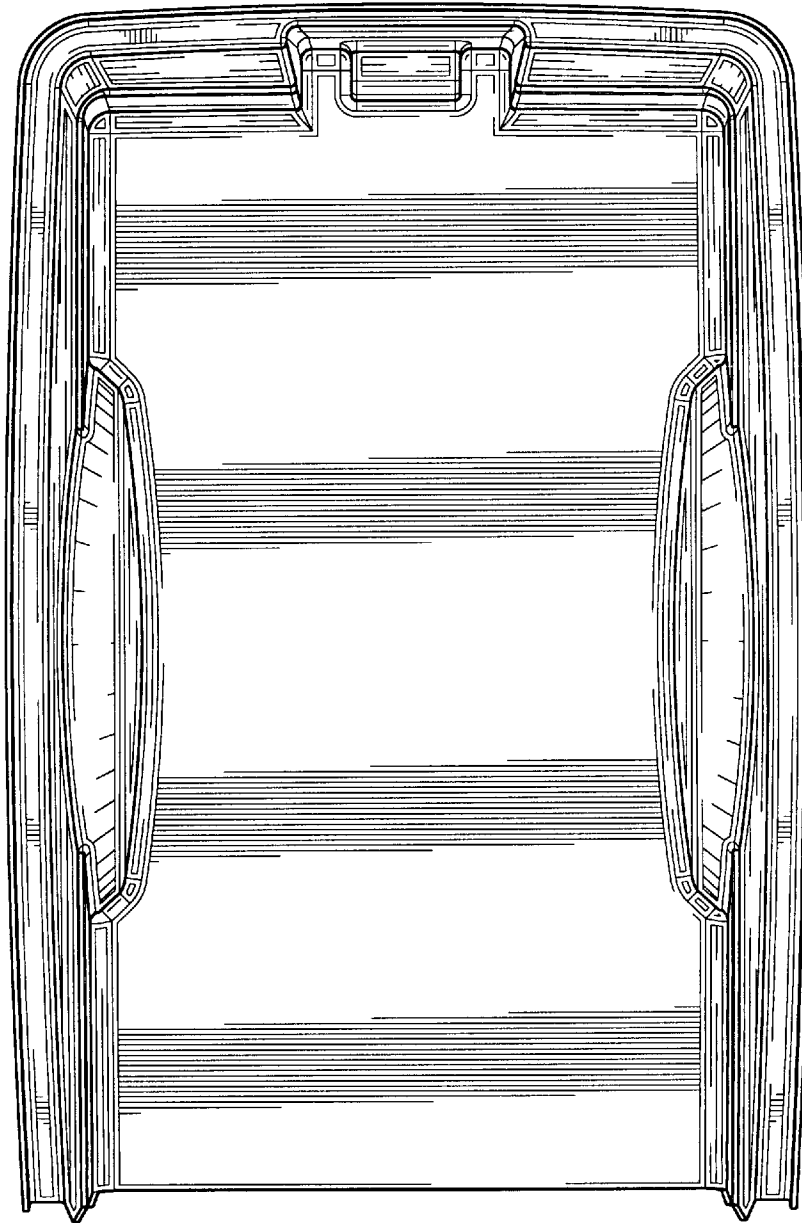

FIG. 4

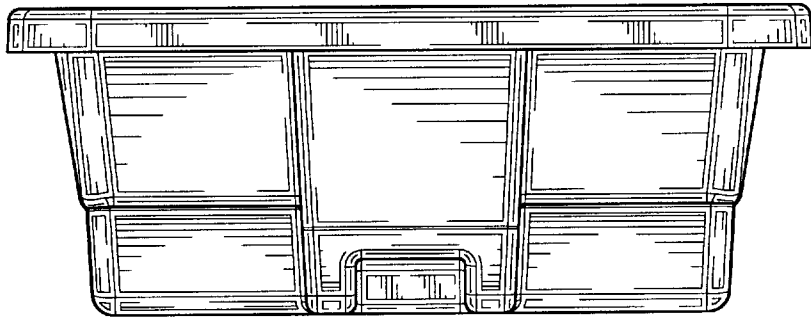

FIG. 5

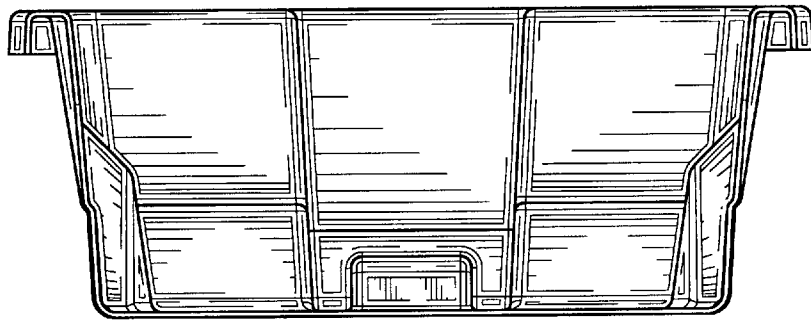

FIG. 6