



US00D927857S

(12) **United States Design Patent**
Qiu

(10) **Patent No.:** **US D927,857 S**

(45) **Date of Patent:** **** Aug. 17, 2021**

- (54) **SET OF MAKEUP BRUSHES**
- (71) Applicant: **Hanxiong Qiu**, Meizhou (CN)
- (72) Inventor: **Hanxiong Qiu**, Meizhou (CN)
- (**) Term: **15 Years**
- (21) Appl. No.: **29/767,133**

D819,979 S	6/2018	Nicoline et al.	
D831,975 S	10/2018	Nicoline	
D849,416 S *	5/2019	Choi	D4/128
D867,765 S *	11/2019	Joo	D4/128
D869,857 S	12/2019	Cordero et al.	
D888,437 S *	6/2020	Poletto	D4/128

* cited by examiner

Primary Examiner — Austin Murphy

- (22) Filed: **Jan. 20, 2021**
- (51) **LOC (13) Cl.** **04-99**
- (52) **U.S. Cl.**
USPC **D4/128**
- (58) **Field of Classification Search**
USPC D4/128, 129, 131, 136, 138, 108, 109,
D4/119; D32/35, 51; 15/104.5, 104.16,
15/104.2, 104.31, 104.32, 164, 165, 206;
D28/65; D7/682; 452/298, 458
CPC A46B 7/026; A46B 5/005; A46B 17/04;
A46B 2200/1046
See application file for complete search history.

(57) **CLAIM**

The ornamental design for a set of makeup brushes, as shown and described.

DESCRIPTION

FIG. 1 is a first perspective view of a set of makeup brushes showing my new design;
 FIG. 2 is a second perspective view thereof;
 FIG. 3 is a front view thereof;
 FIG. 4 is a back view thereof;
 FIG. 5 is a left side view thereof;
 FIG. 6 is a right side view thereof;
 FIG. 7 is a top view thereof;
 FIG. 8 is a bottom view thereof;
 FIG. 9 is a perspective view of another state of the set of makeup brushes thereof; and,
 FIG. 10 is a perspective view of further another state of the set of makeup brushes thereof.
 The broken lines shown in the drawings depict portions of the set of makeup brushes in which the design is embodied that form no part of the claimed design.

1 Claim, 10 Drawing Sheets

(56) **References Cited**

U.S. PATENT DOCUMENTS

D581,672 S *	12/2008	Dumler	D4/128
D590,601 S *	4/2009	Schrepf	D4/128
D604,513 S *	11/2009	Lemen	D4/128
D623,418 S *	9/2010	Martinez	D4/128
D725,913 S *	4/2015	Jacob	D4/128
D750,382 S *	3/2016	Jacob	D4/128
D782,200 S *	3/2017	Jacob	D4/128
D816,348 S *	5/2018	Corbellini	D4/133
D817,646 S *	5/2018	Corbellini	D4/133
D818,276 S *	5/2018	Corbellini	D4/133

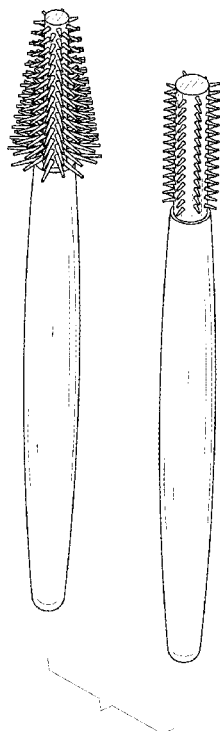

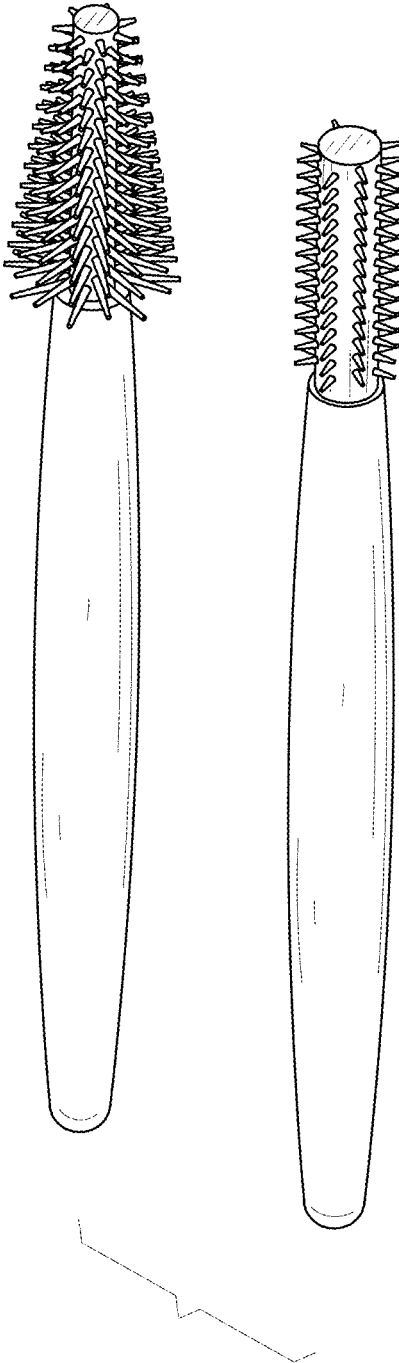

FIG. 1

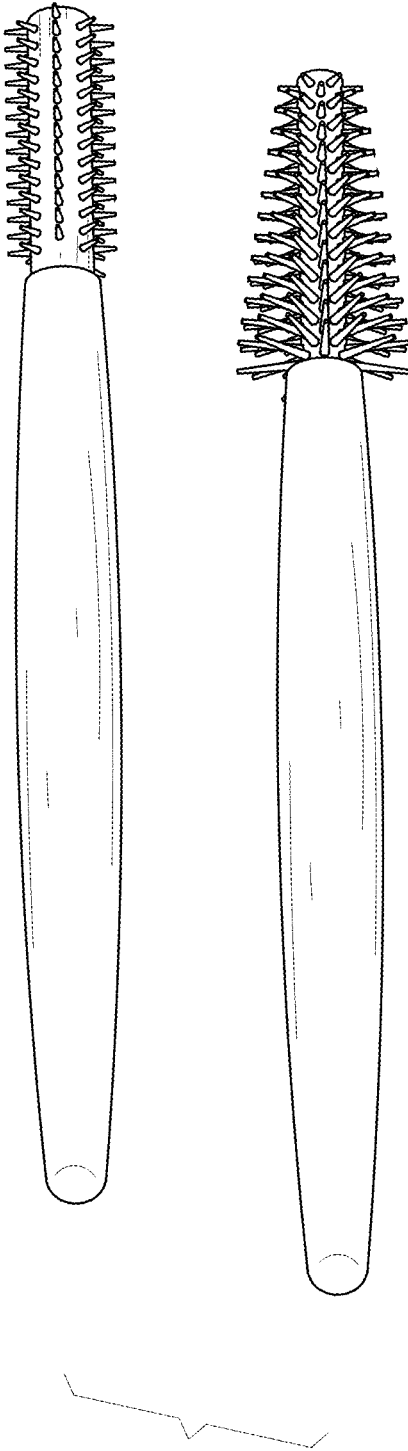

FIG. 2

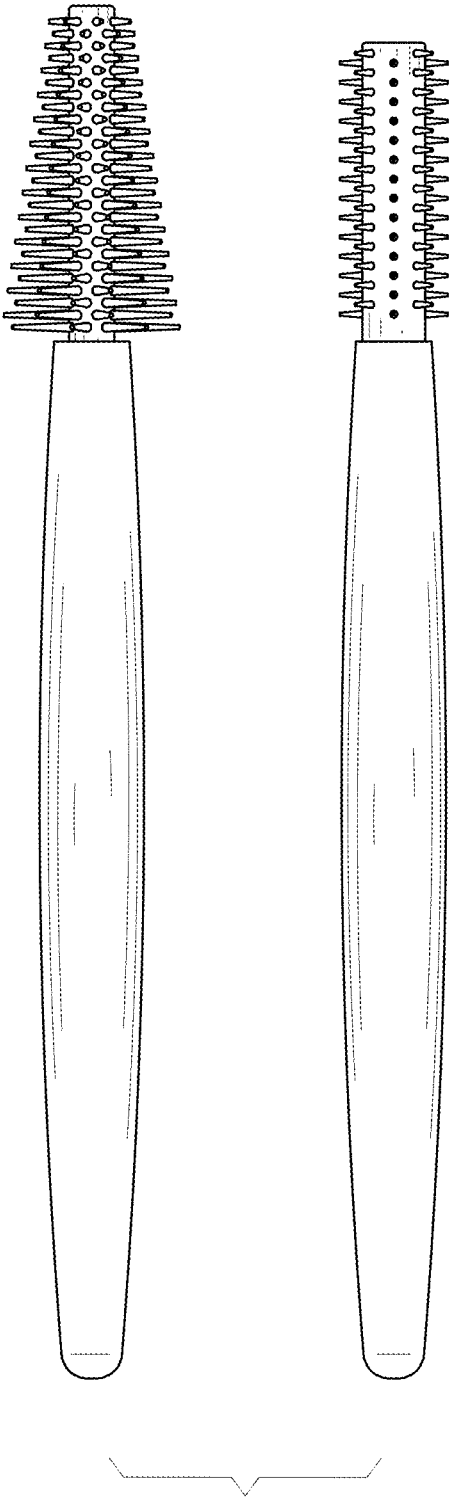

FIG. 3

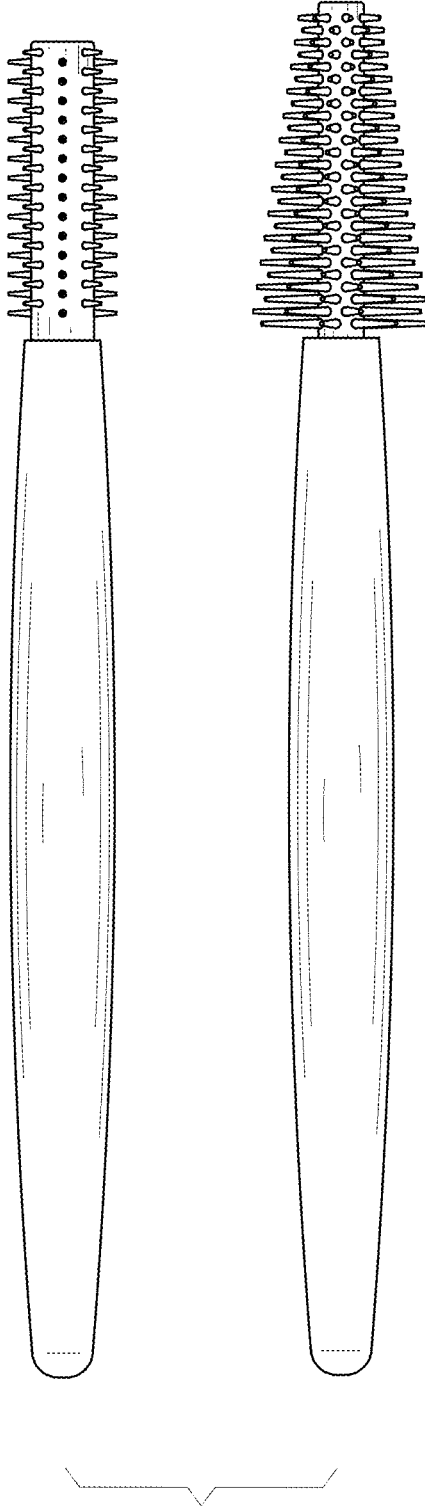

FIG. 4

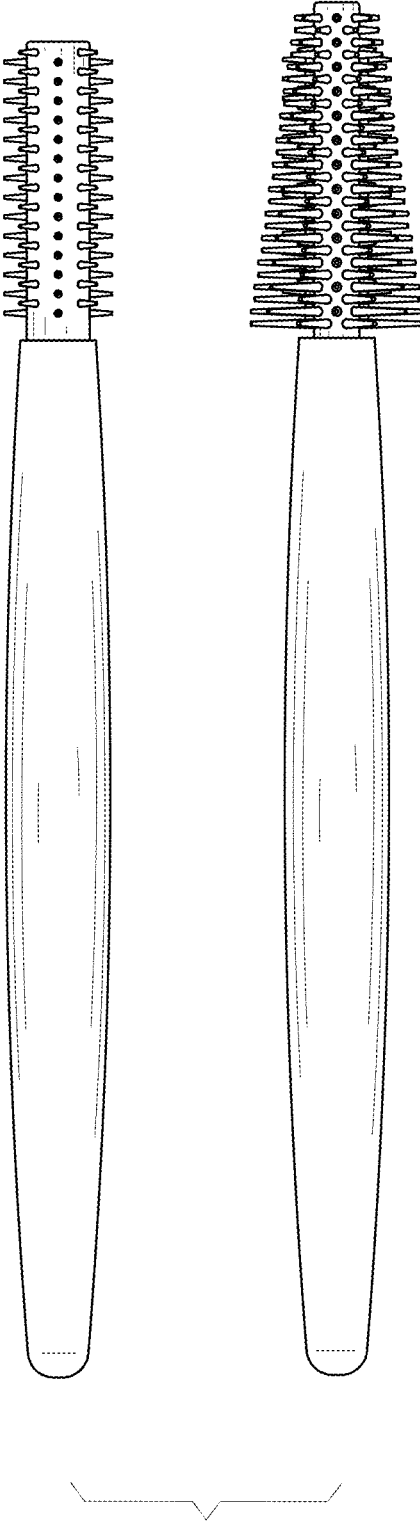

FIG. 5

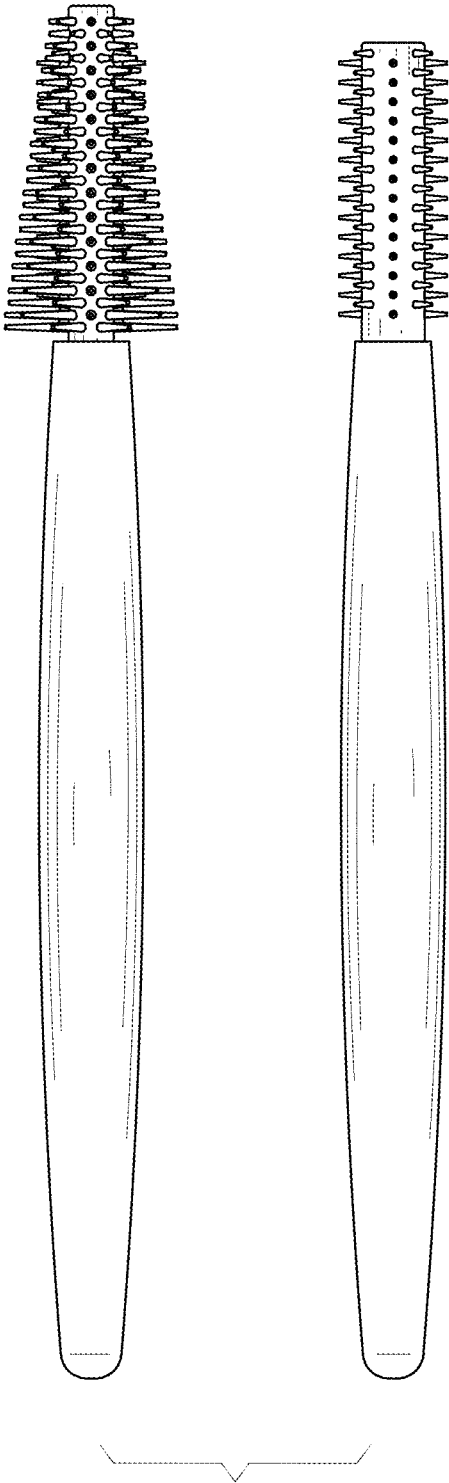

FIG. 6

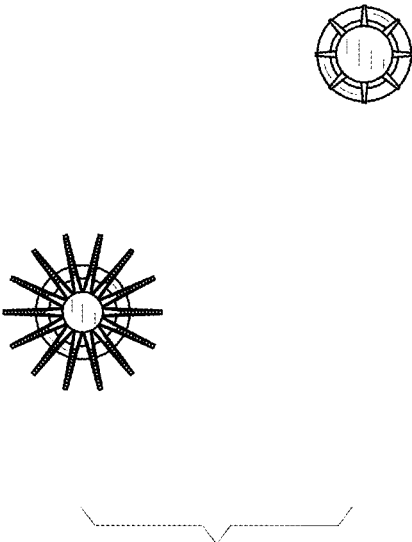

FIG. 7

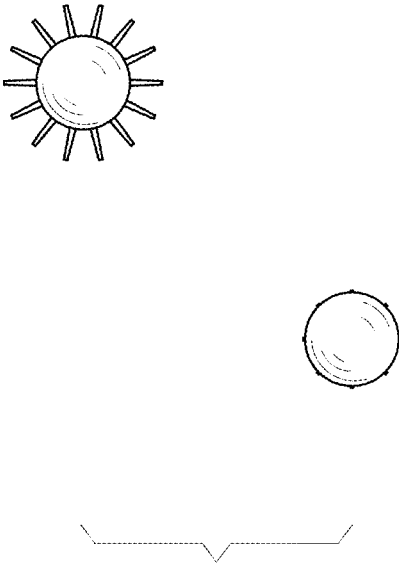

FIG. 8

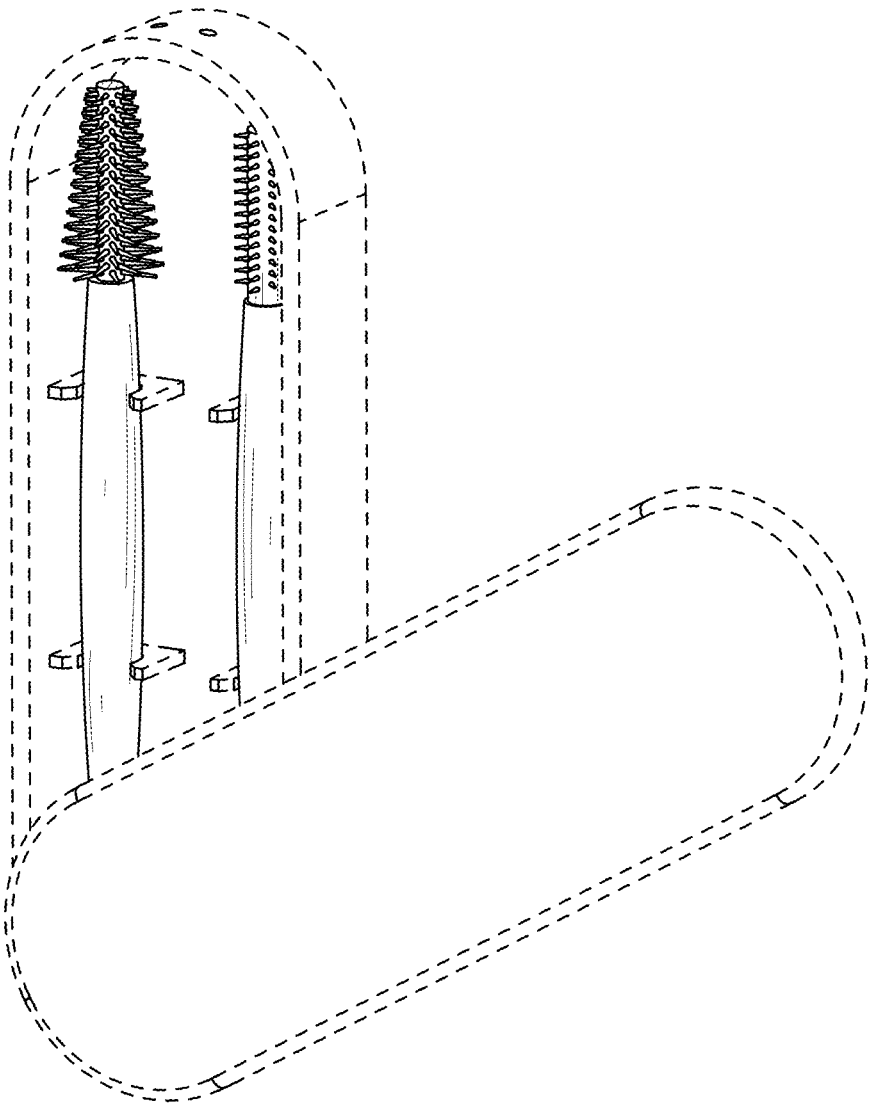

FIG. 9

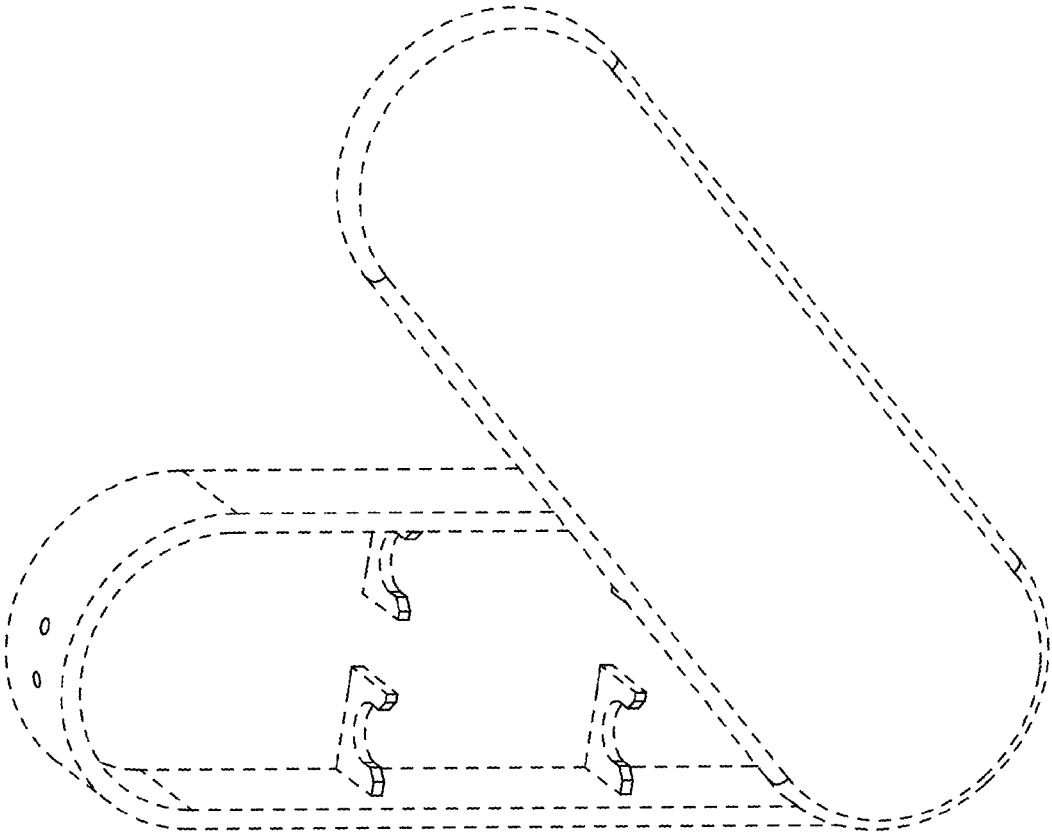

FIG. 10

