



US0D1050350S

(12) **United States Design Patent**  
**Xu**

(10) **Patent No.:** **US D1,050,350 S**

(45) **Date of Patent:** **\*\* Nov. 5, 2024**

(54) **SHOWER PANEL**

export/RWTM7IF2/pdf4/baefd4d5-0fe5-422c-83a3-633e509df7b0-202320.pdf) (Year: 2022).\*

(71) Applicant: **Kaiping Hideep Sanitary Ware Co., Ltd.**, Kaiping (CN)

(Continued)

(72) Inventor: **Jiancong Xu**, Kaiping (CN)

*Primary Examiner* — Jack Reickel

*Assistant Examiner* — Bobby W Jones, II

(73) Assignee: **Kaiping Hideep Sanitary Ware Co., Ltd.**

(74) *Attorney, Agent, or Firm* — Jose Cherson Weissbrot

(\*\*) Term: **15 Years**

(57) **CLAIM**

(21) Appl. No.: **29/851,227**

The ornamental design for a shower panel as shown and described.

(22) Filed: **Aug. 26, 2022**

(30) **Foreign Application Priority Data**

**DESCRIPTION**

May 23, 2022 (CN) ..... 202230306002.9

(51) **LOC (14) CL.** ..... **23-01**

(52) **U.S. CL.**  
USPC ..... **D23/213**

(58) **Field of Classification Search**  
USPC ..... D23/213, 214, 223, 226, 304  
CPC ..... E03C 1/0408; E03C 1/02; A47K 3/28  
See application file for complete search history.

FIG. 1 is a perspective view of a shower panel, showing the first embodiment of my new design;  
FIG. 2 is another perspective view thereof;  
FIG. 3 is a front elevational view thereof;  
FIG. 4 is a rear elevational view thereof;  
FIG. 5 is a partial enlarged view of FIG. 1;  
FIG. 6 is a partial enlarged view of FIG. 1;  
FIG. 7 is a perspective view of a shower panel, showing the second embodiment of my new design;  
FIG. 8 is another perspective view thereof;  
FIG. 9 is a front elevational view thereof;  
FIG. 10 is a rear elevational view thereof;  
FIG. 11 is a partial enlarged view of FIG. 7;  
FIG. 12 is a partial enlarged view of FIG. 7;  
FIG. 13 is a partial enlarged view of FIG. 7;  
FIG. 14 is a perspective view of a shower panel, showing the third embodiment of my new design;  
FIG. 15 is another perspective view thereof;  
FIG. 16 is a front elevational view thereof;  
FIG. 17 is a rear elevational view thereof;  
FIG. 18 is a partial enlarged view of FIG. 14;  
FIG. 19 is a partial enlarged view of FIG. 14; and  
FIG. 20 is a partial enlarged view of FIG. 14.  
The broken lines define the bounds of the enlargements and do not form part of the claimed design.

(56) **References Cited**

**U.S. PATENT DOCUMENTS**

D531,260 S *	10/2006	Luo	.....	D23/213
D540,427 S *	4/2007	Bouroullec	.....	D23/213
D540,923 S *	4/2007	Starck	.....	D23/304
D591,837 S *	5/2009	Zetsche	.....	D23/304
D612,010 S *	3/2010	Schoenherr	.....	D23/213
D694,358 S *	11/2013	Schoenherr	.....	D23/213
D750,201 S *	2/2016	Schoenherr	.....	D23/213
D757,894 S *	5/2016	Schoenherr	.....	D23/213
D757,895 S *	5/2016	Schoenherr	.....	D23/213

(Continued)

**OTHER PUBLICATIONS**

EU 009099690-0007 Shower panel, (Likui Zhou), published on Jul. 29, 2022. Retrieved from Orbit database (<https://www.orbit.com/>)

**1 Claim, 20 Drawing Sheets**

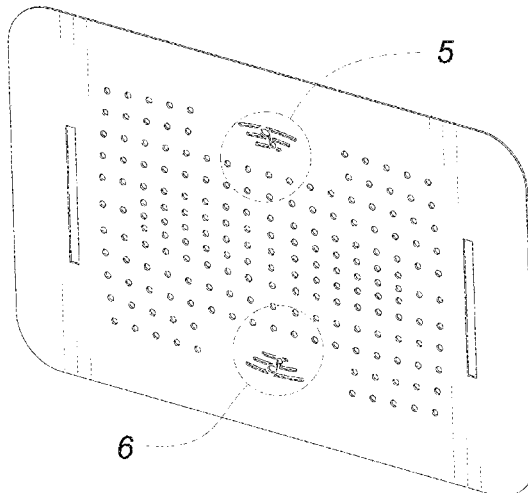

(56)

**References Cited**

U.S. PATENT DOCUMENTS

D765,819	S	*	9/2016	Schoenherr	.....	D23/213
D828,491	S	*	9/2018	Schoenherr	.....	D23/213
D849,191	S	*	5/2019	Cocks	.....	D23/213
D908,188	S	*	1/2021	Seum	.....	D23/213
D926,288	S	*	7/2021	Komatsu	.....	D23/223
D1,012,230	S	*	1/2024	Oesterle	.....	D23/213
D1,012,234	S	*	1/2024	Oesterle	.....	D23/213
D1,019,892	S	*	3/2024	Xu	.....	D23/213
2021/0308698	A1	*	10/2021	Kajuch	.....	B05B 12/16

OTHER PUBLICATIONS

6Reno Thermostatic All-In-One Kit with Rough in-Valve, earliest posted date unavailable, [online], [retrieved Apr. 8, 2024]. Retrieved from internet, <https://www.wayfair.com/home-improvement/pdp/smart-living-technology-thermostatic-ceiling-mounted-with-rough-in-valve-saqt1089.html> (Year: 2024).\*

\* cited by examiner

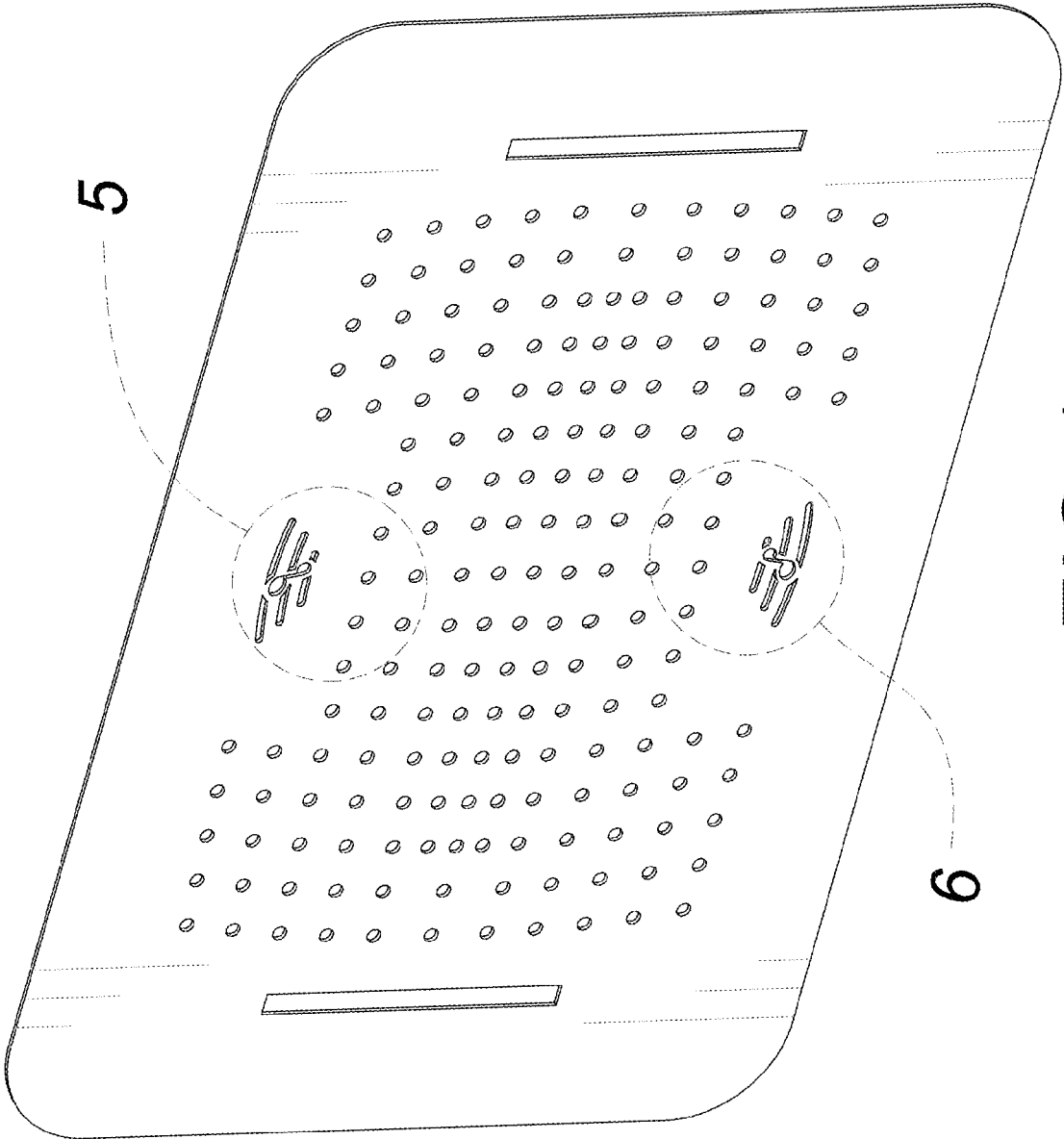

FIG. 1

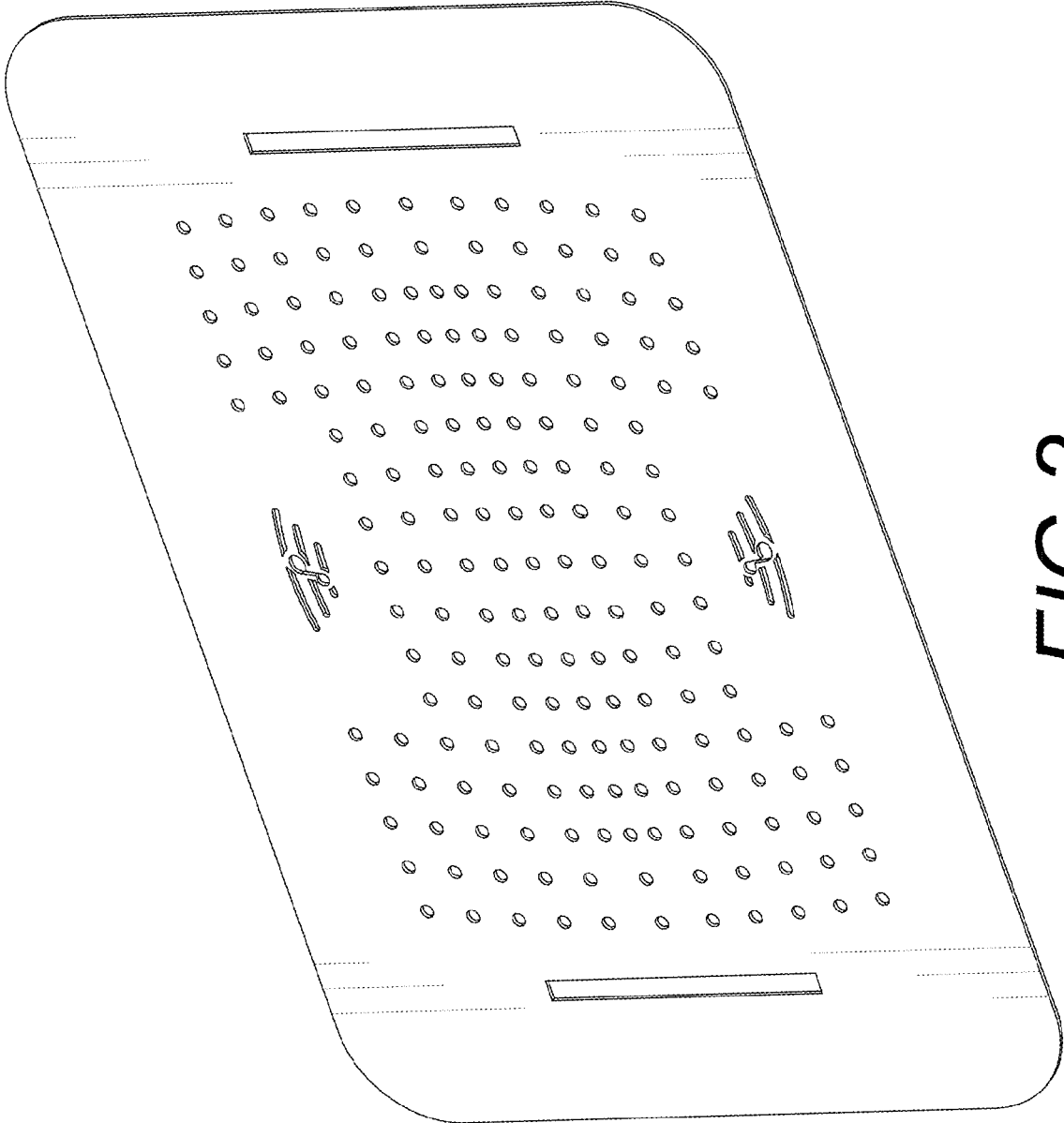

FIG. 2

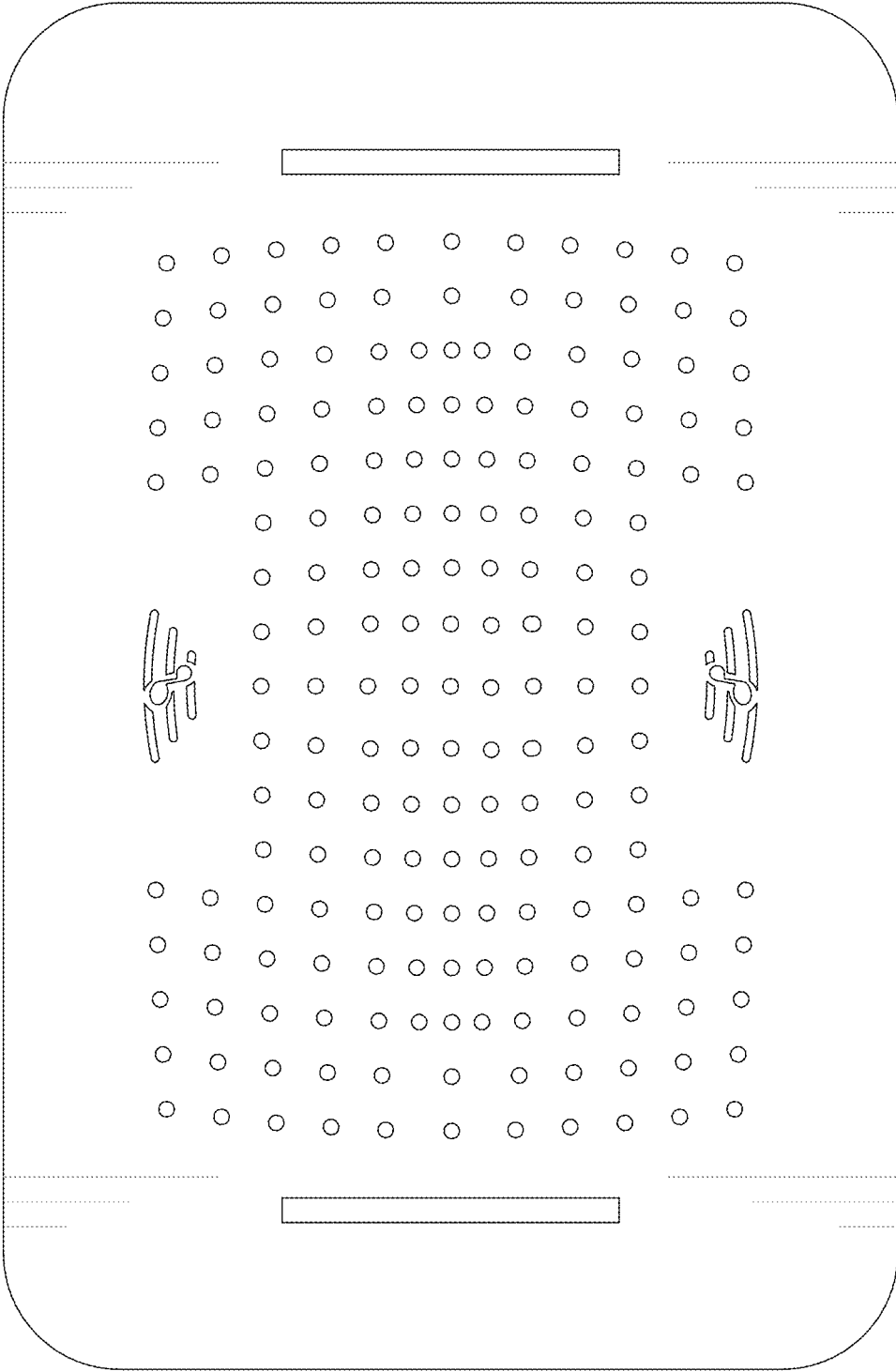

FIG. 3

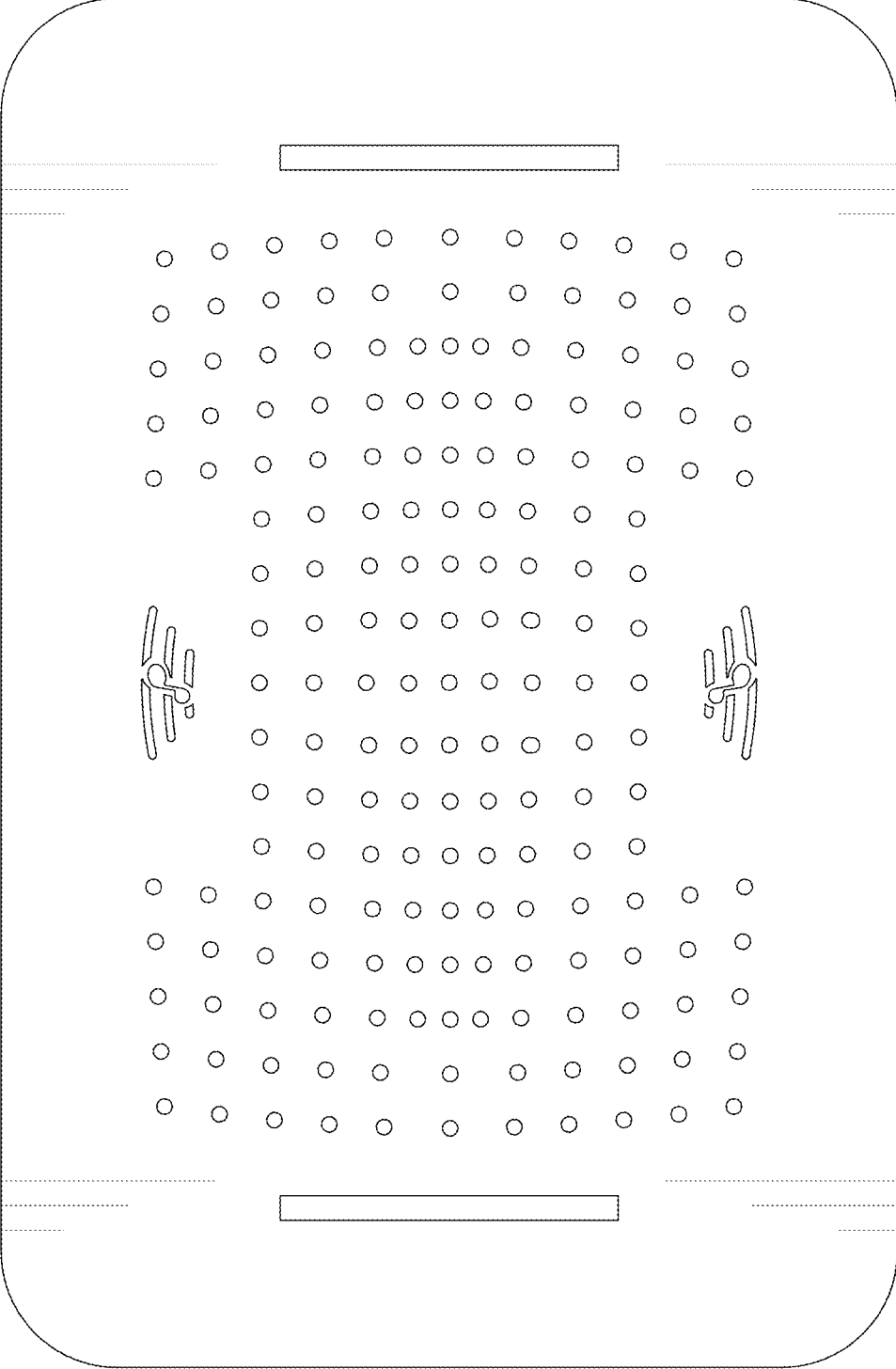
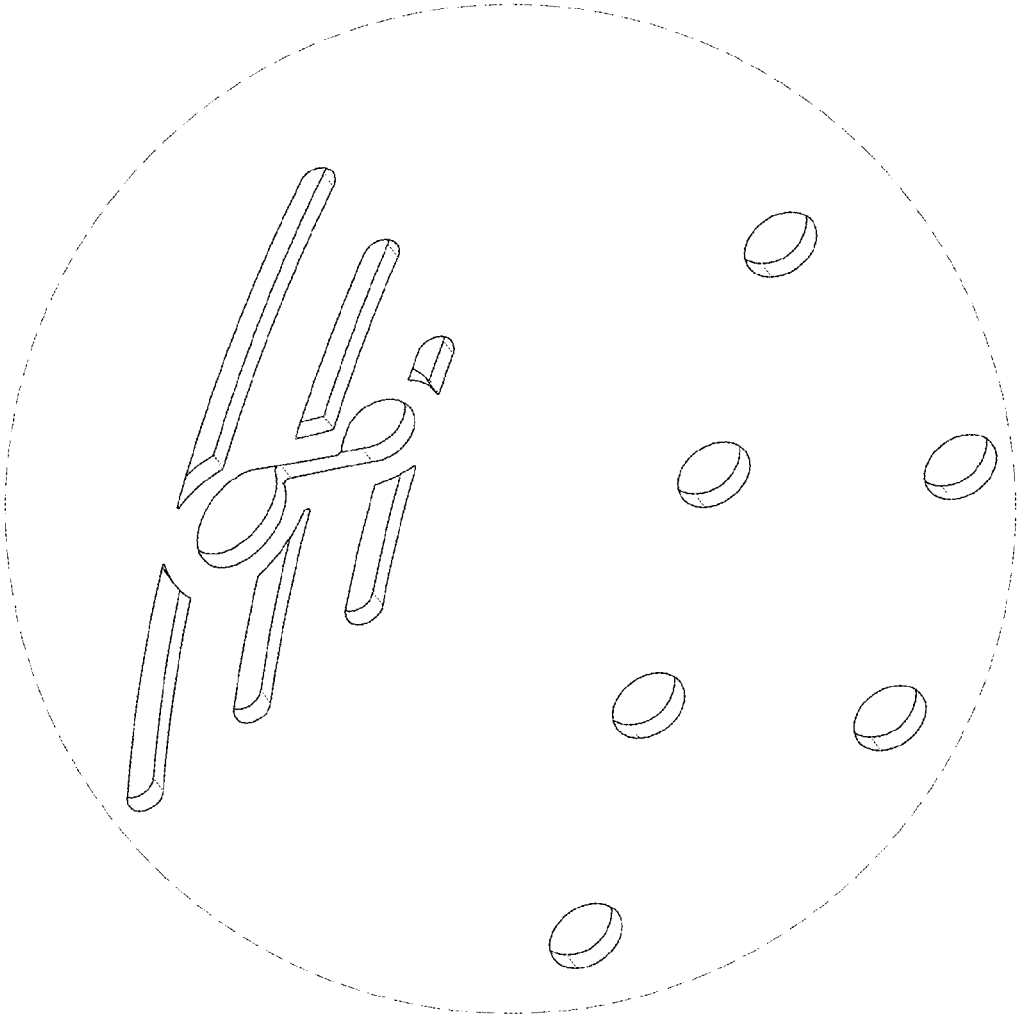
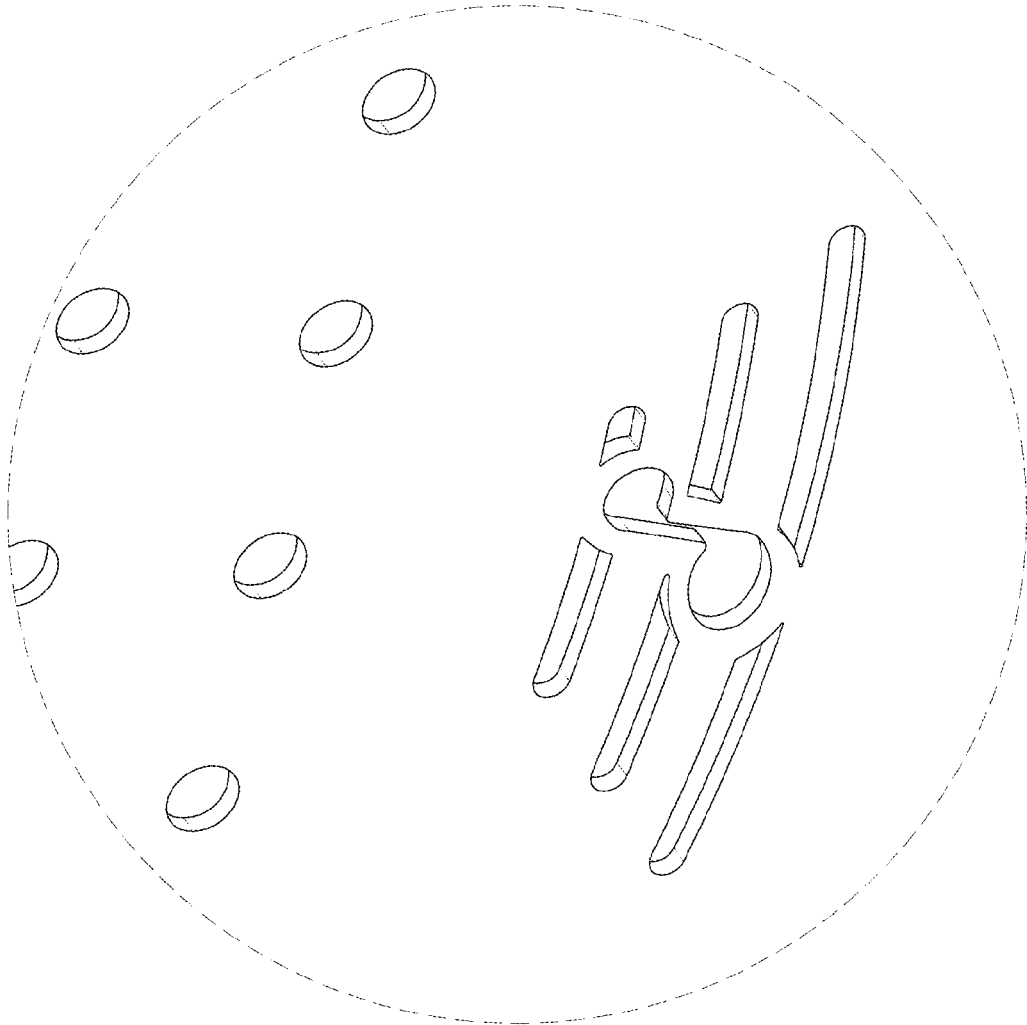

FIG. 4



**FIG. 5**



**FIG. 6**



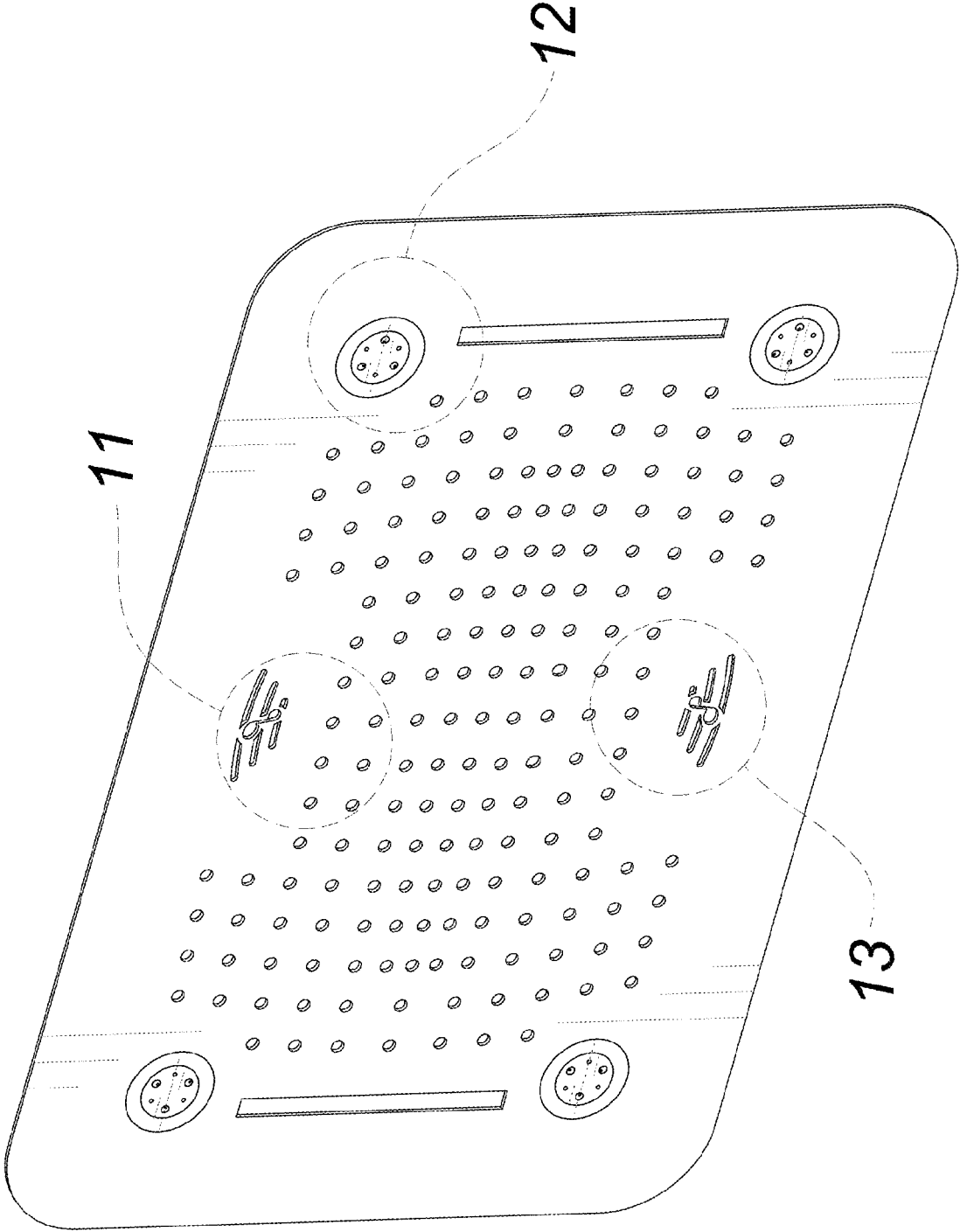

FIG. 7

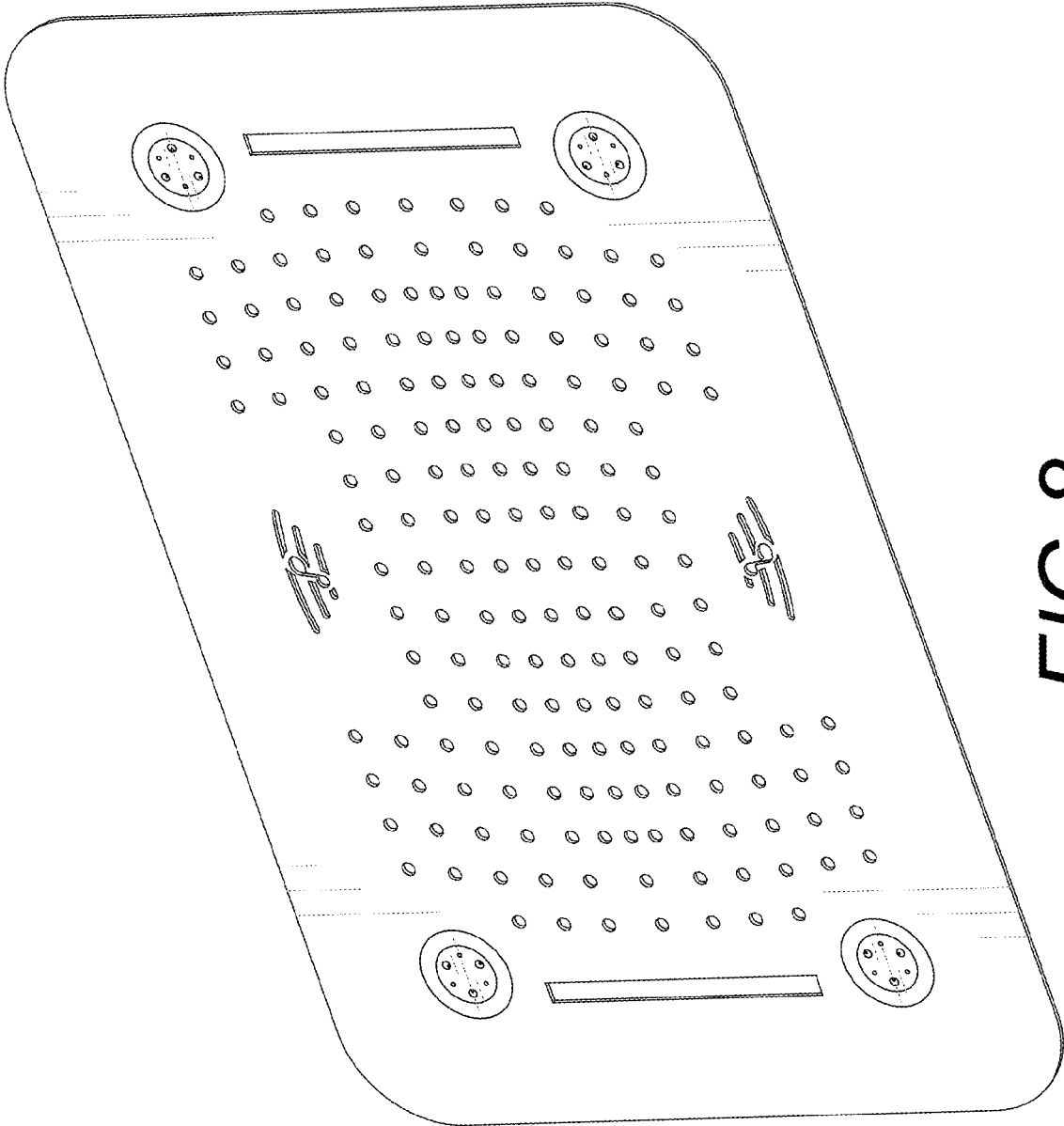

FIG. 8

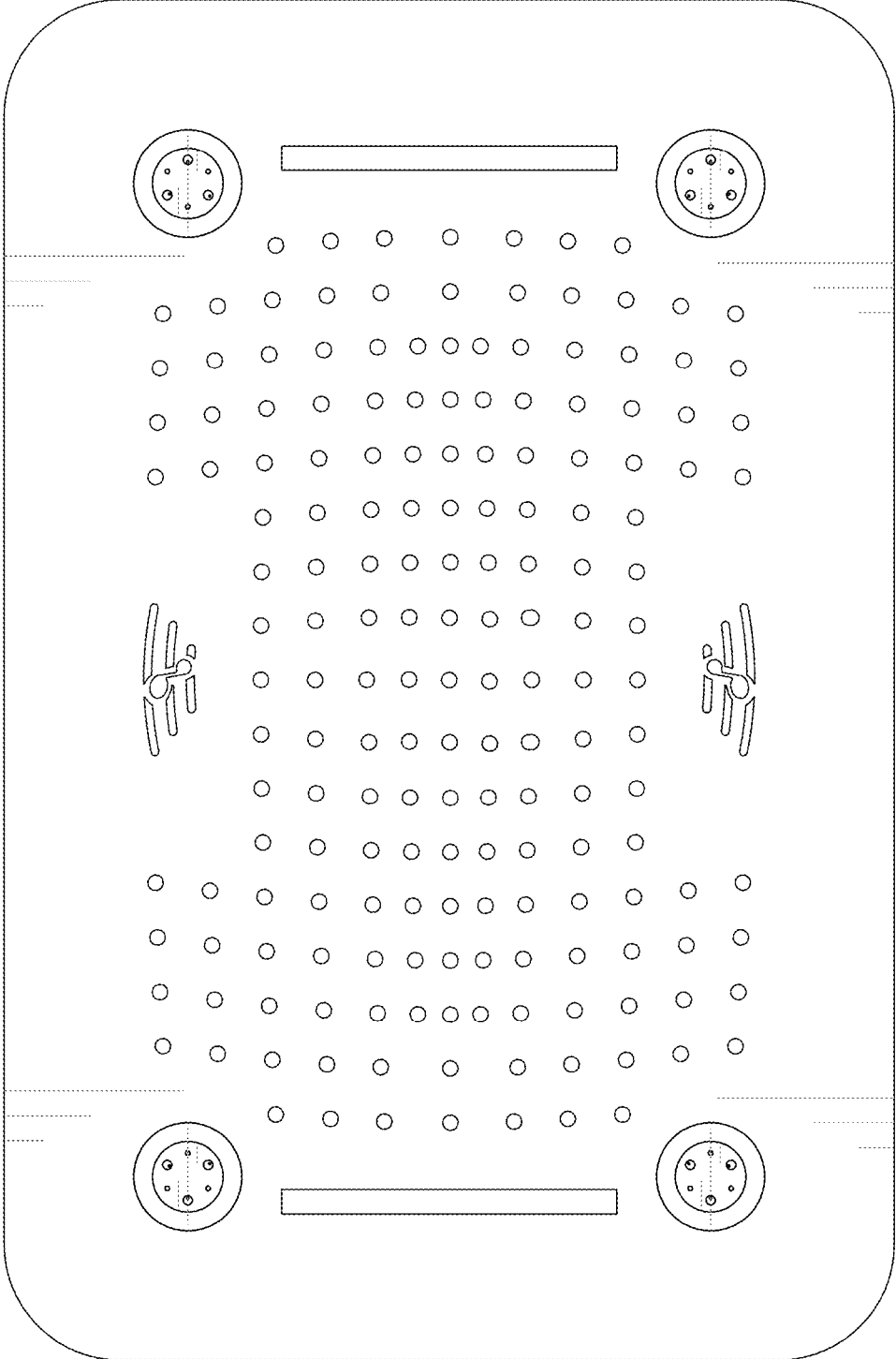

FIG. 9

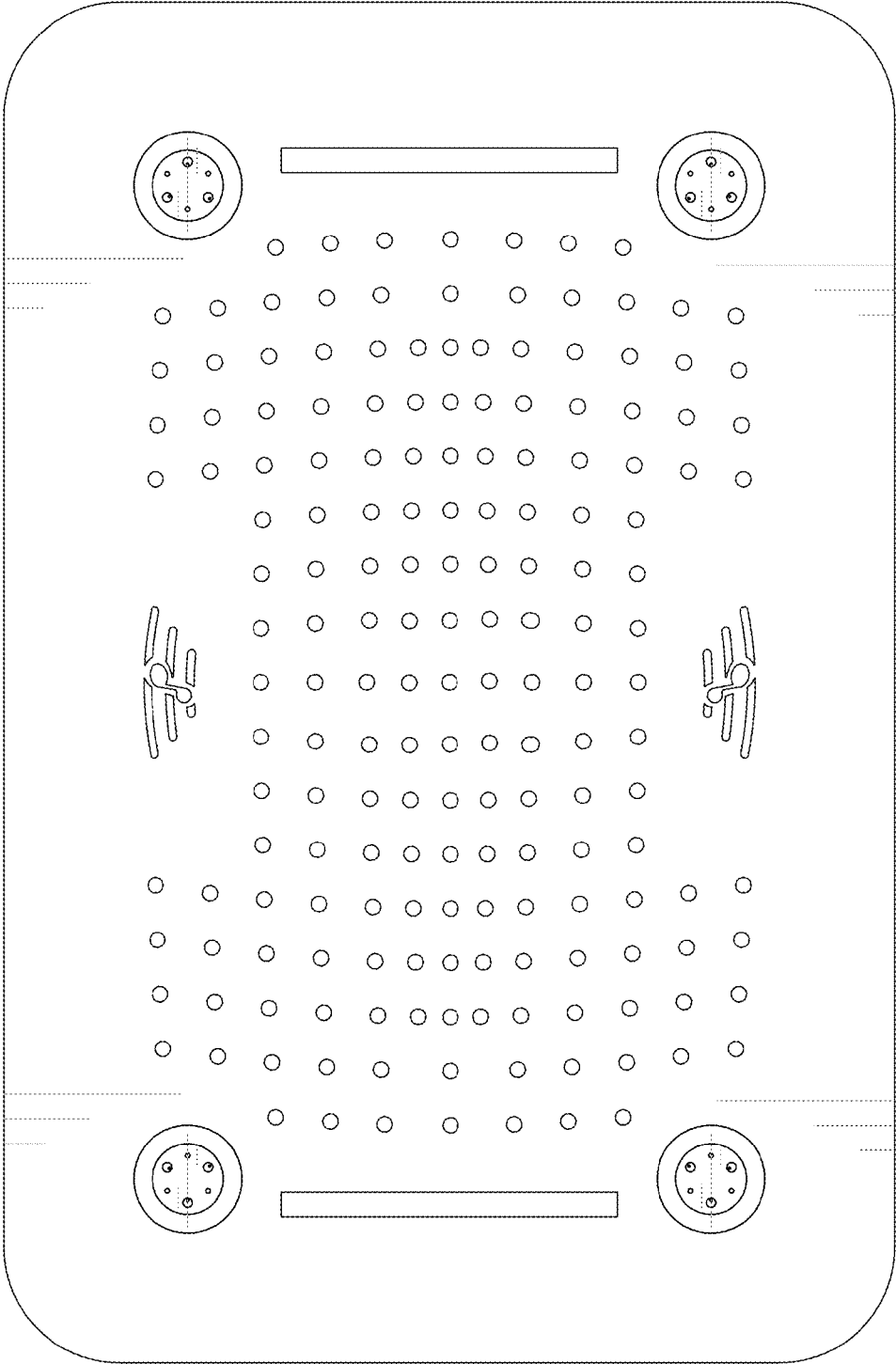
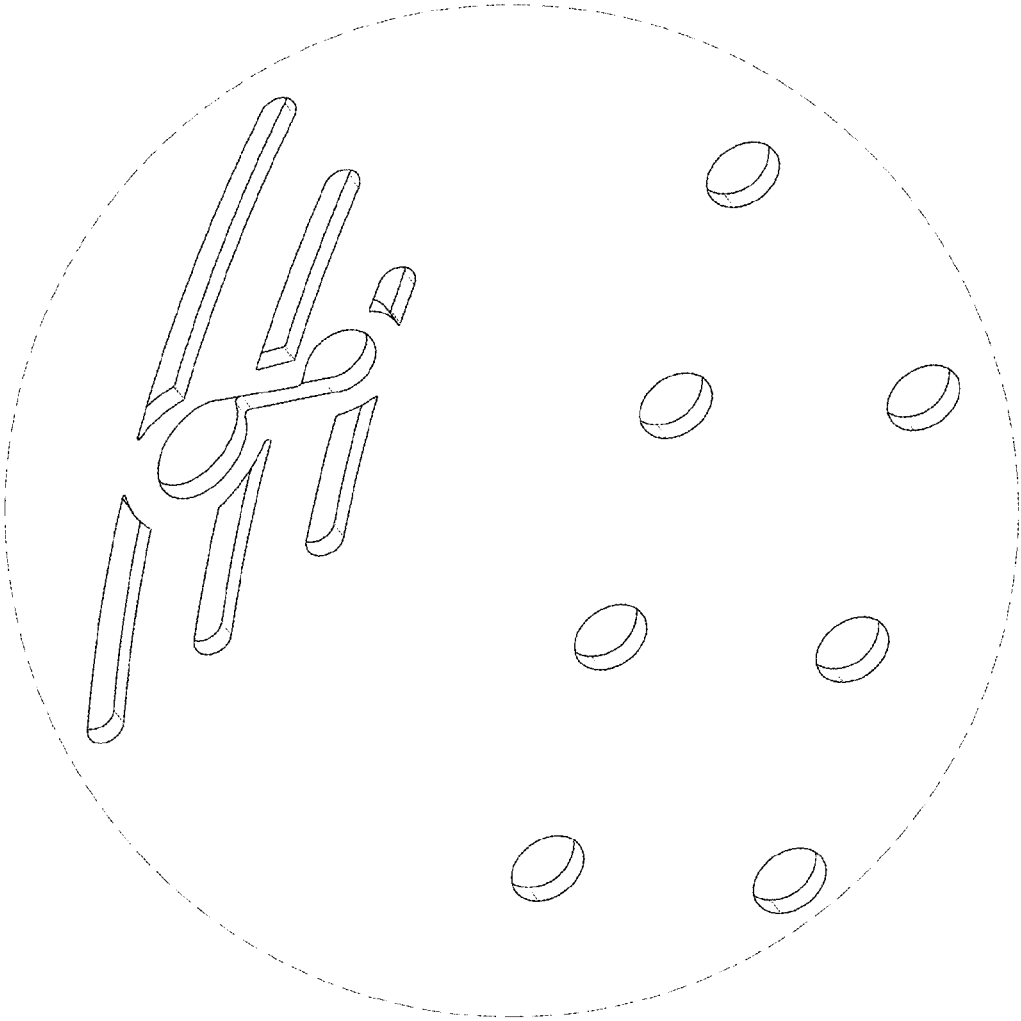

FIG. 10



**FIG.11**

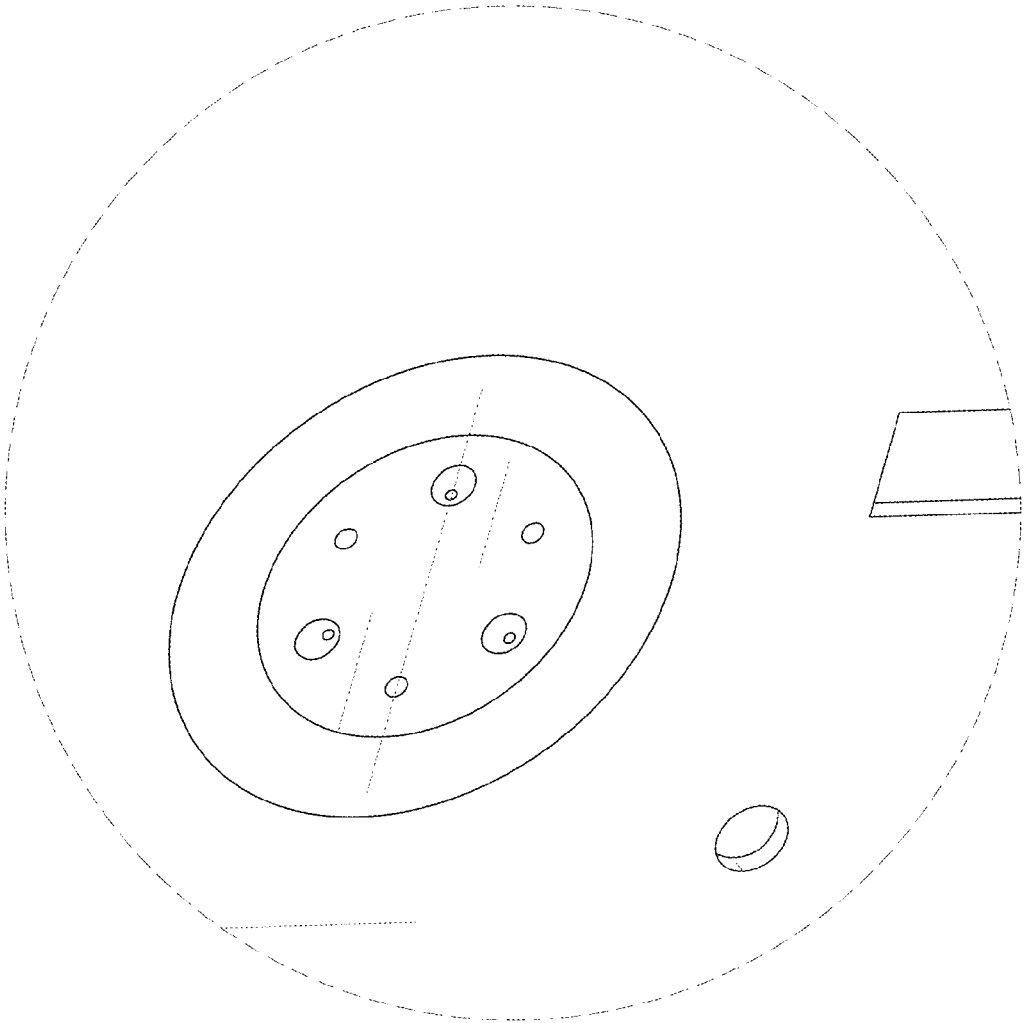
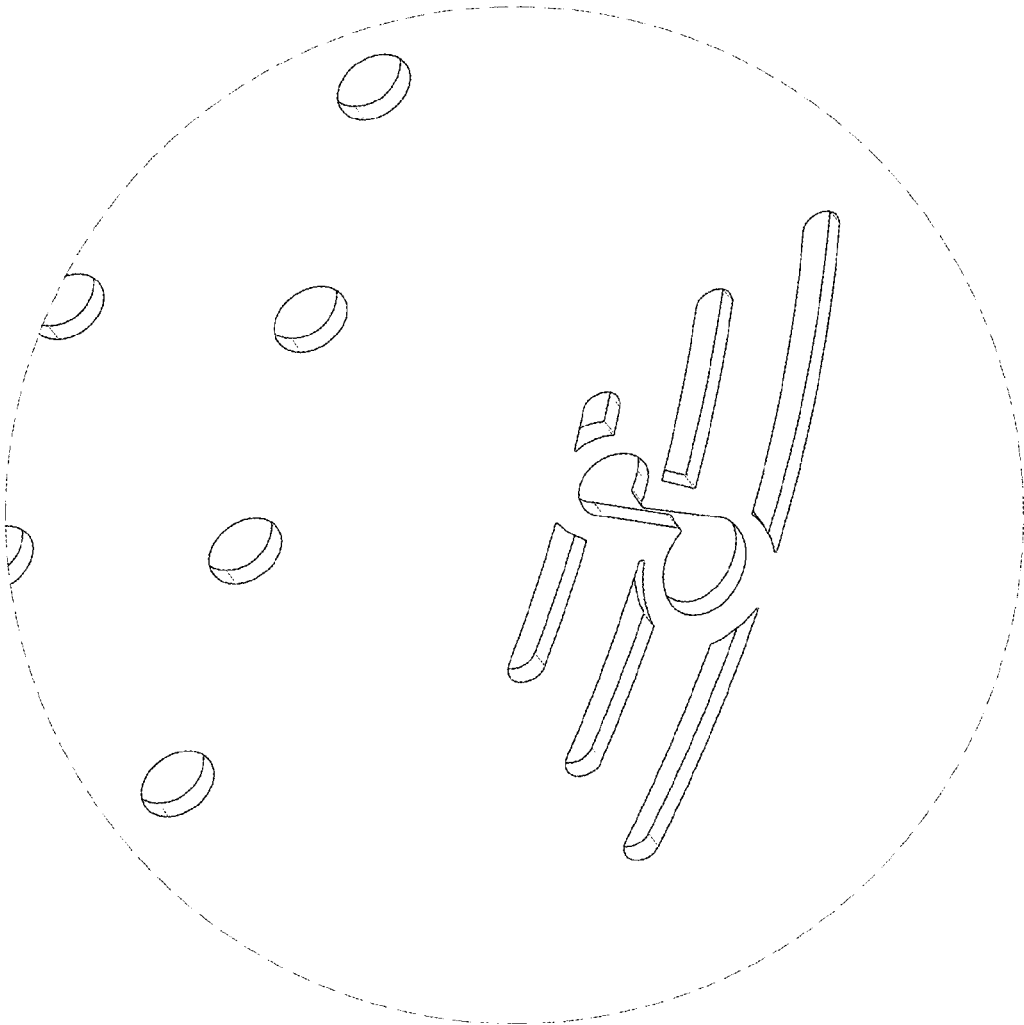

FIG.12



**FIG. 13**

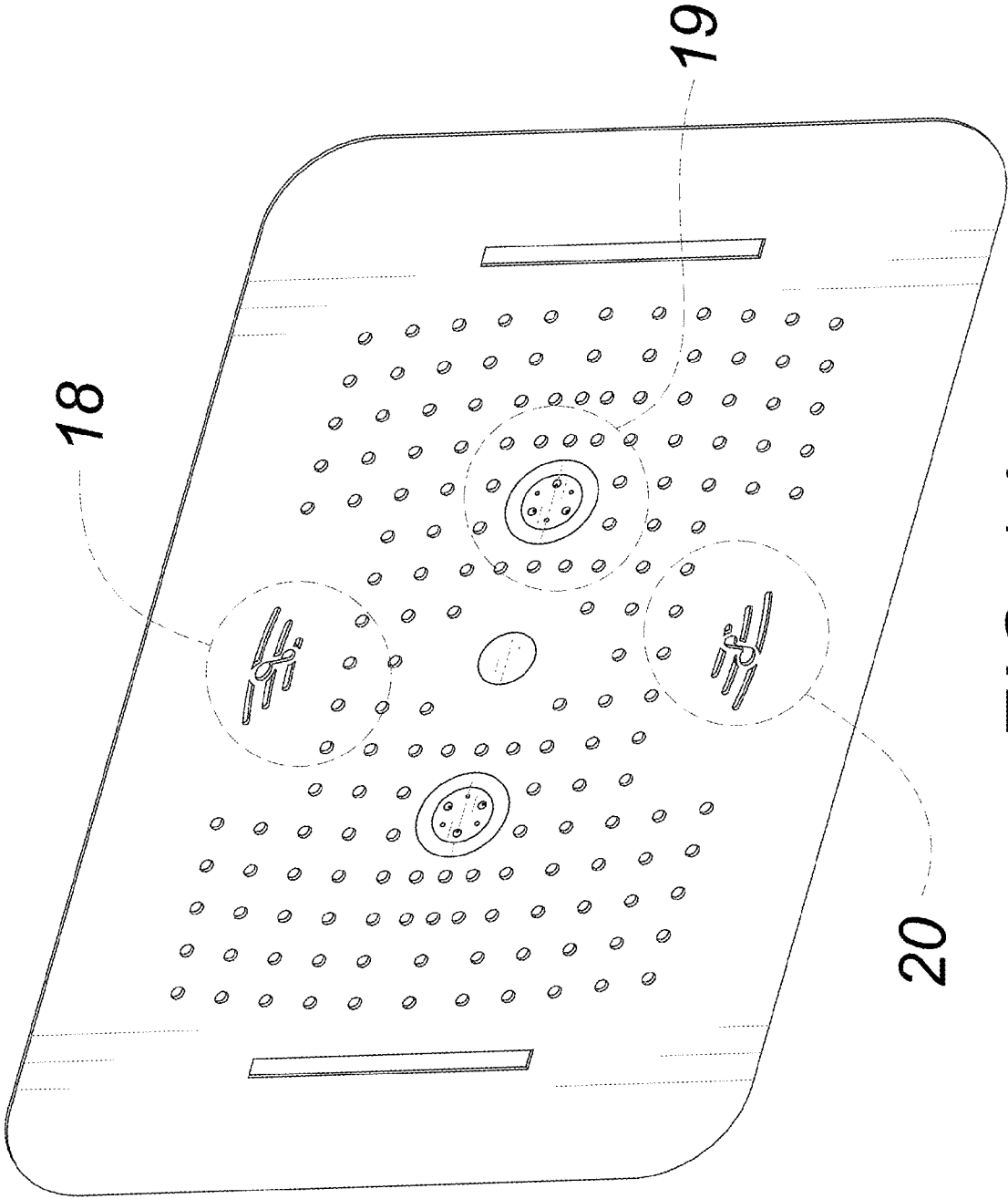

FIG. 14



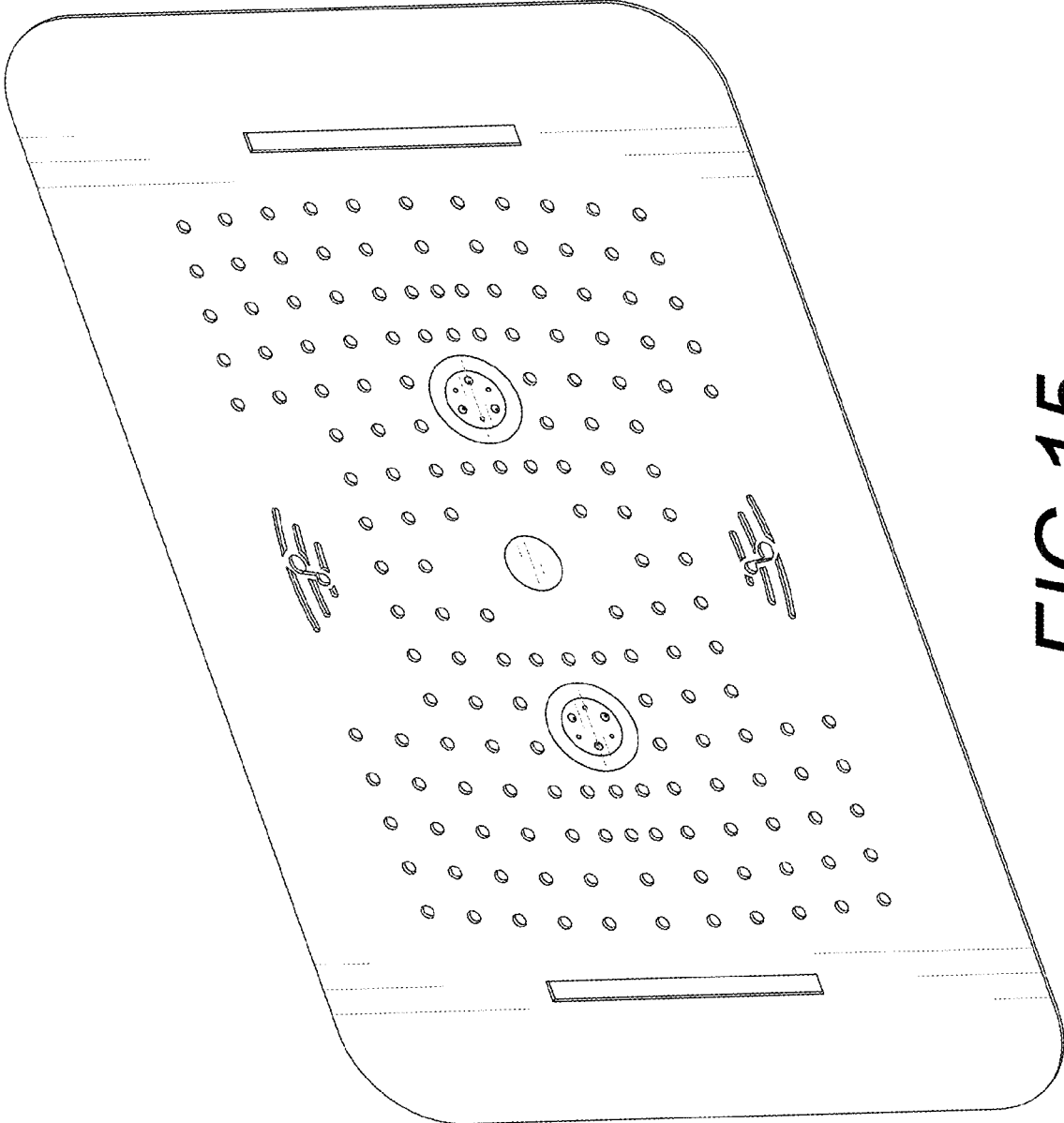

FIG. 15

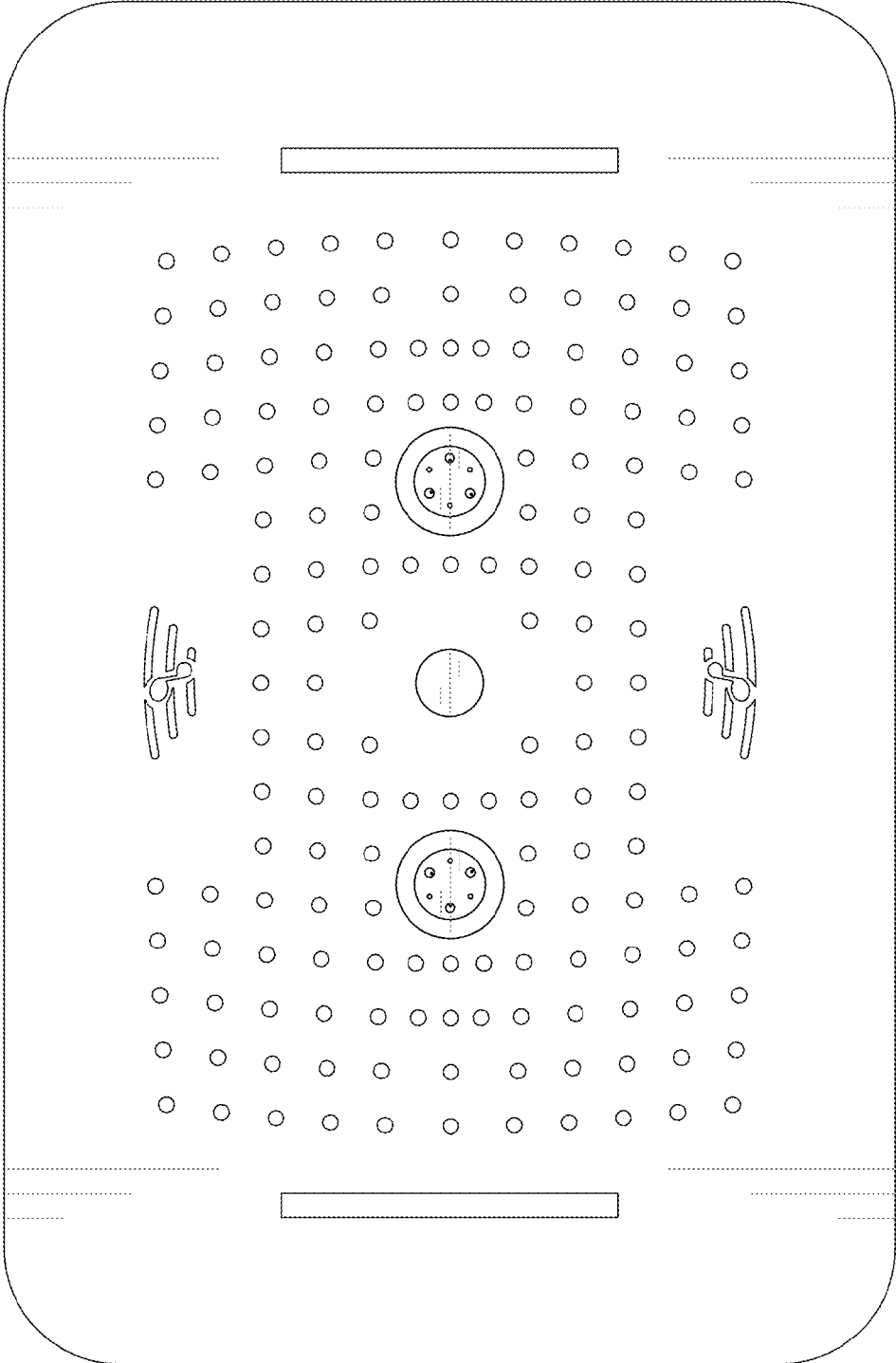

FIG. 16

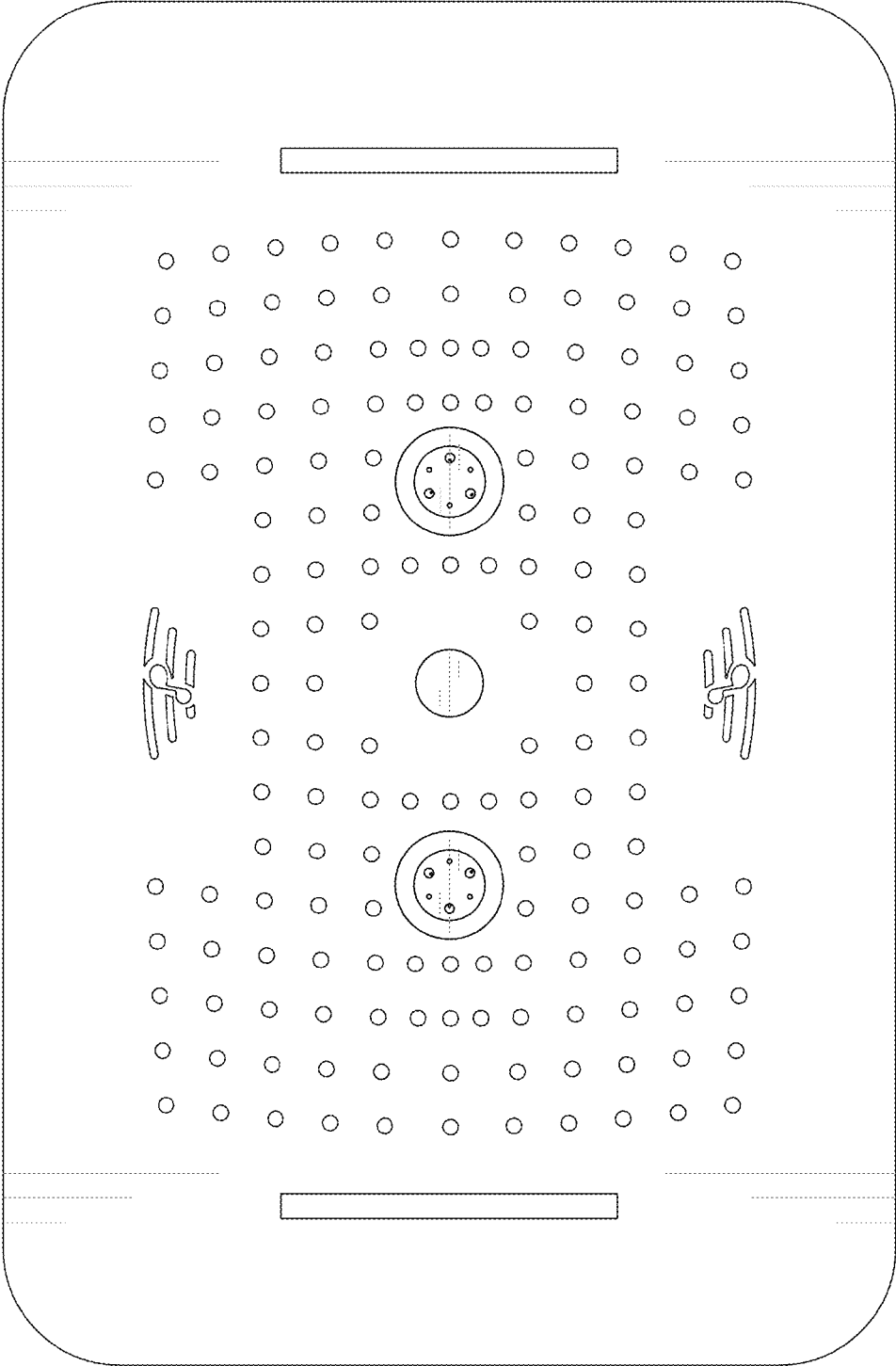
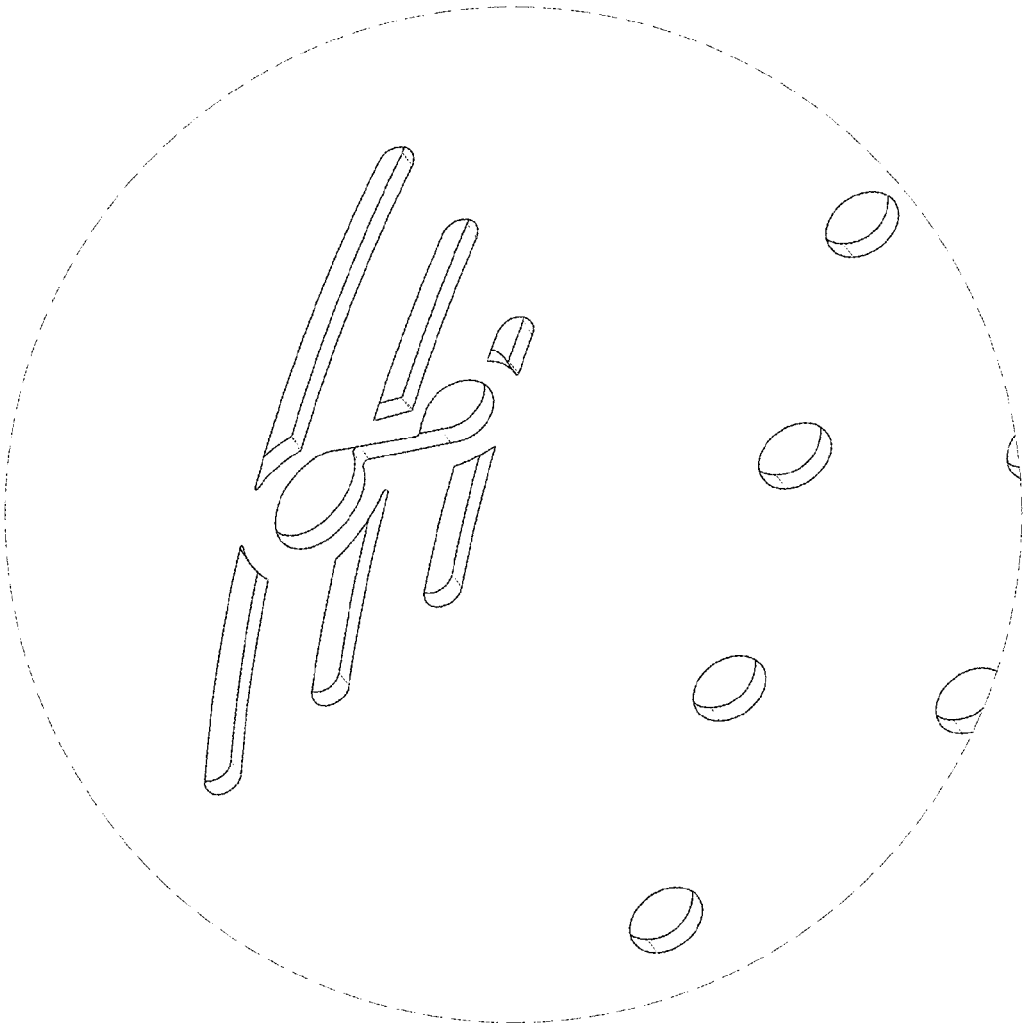
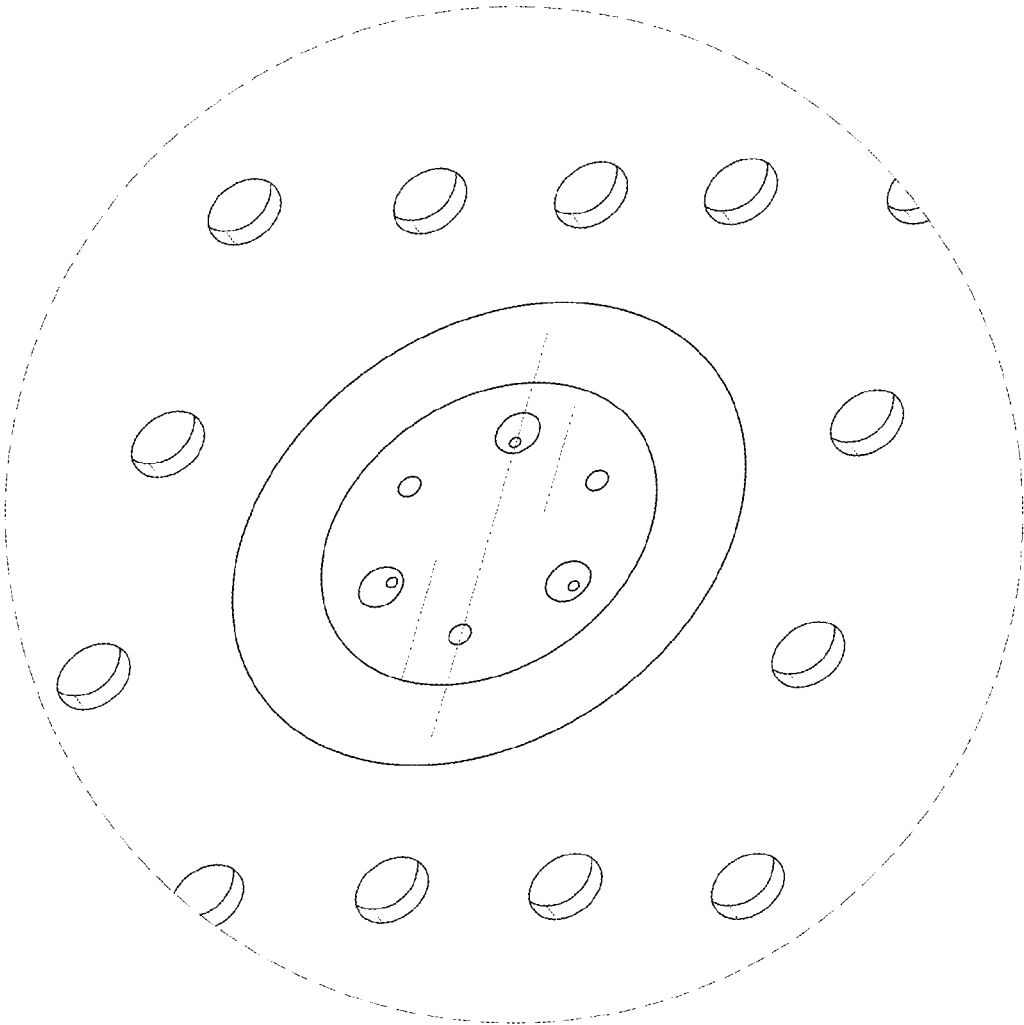

FIG. 17



**FIG. 18**



**FIG. 19**

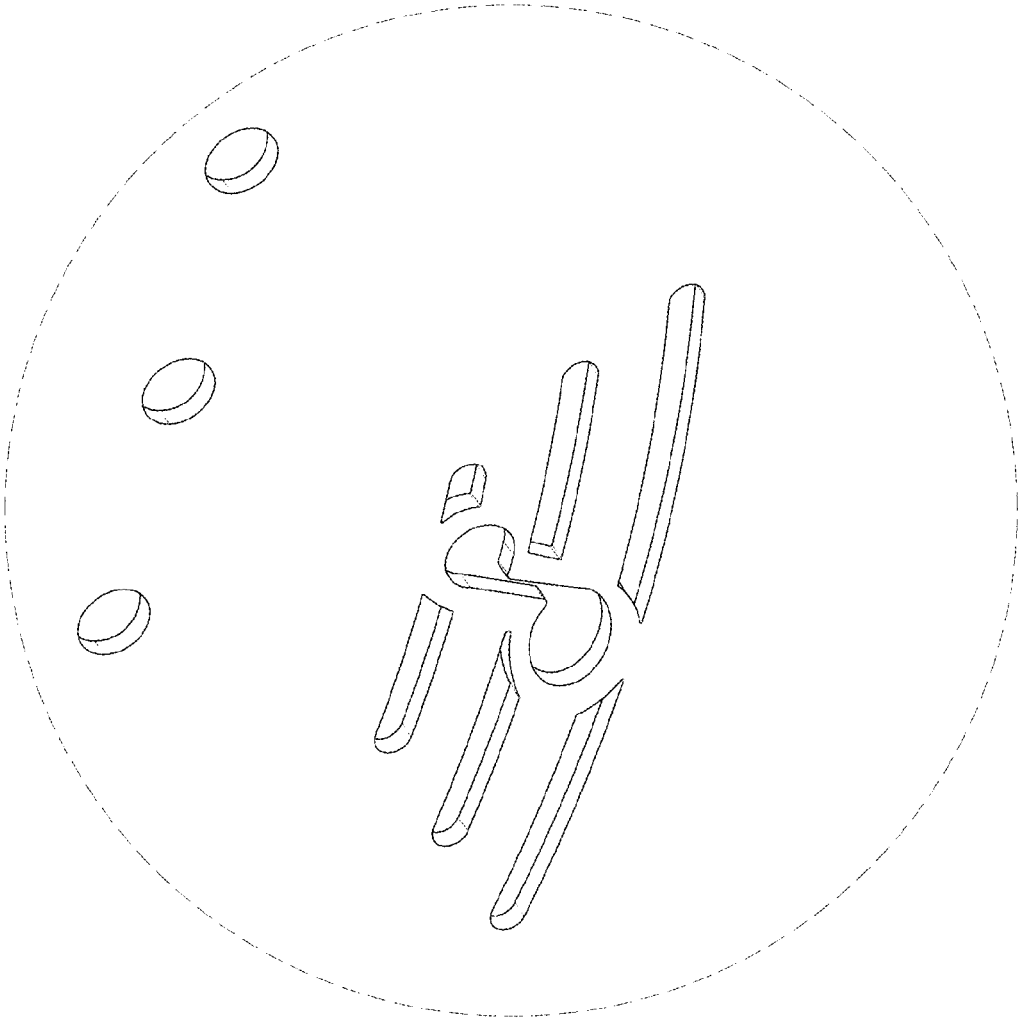

FIG. 20