



(12) **United States Design Patent**
Yoshie et al.

(10) **Patent No.:** **US D559,668 S**
(45) **Date of Patent:** **** Jan. 15, 2008**

(54) **CORD STOPPER**

(75) Inventors: **Kenichi Yoshie**, Kurobe (JP); **Shin Yonamine**, Tokyo (JP)

(73) Assignee: **YKK Corporation**, Tokyo (JP)

(**) Term: **14 Years**

(21) Appl. No.: **29/263,351**

(22) Filed: **Jul. 20, 2006**

(30) **Foreign Application Priority Data**

Jan. 27, 2006 (JP) 2006-001711

(51) **LOC (8) Cl.** **08-08**

(52) **U.S. Cl.** **D8/383**

(58) **Field of Classification Search** D8/383,
D8/395, 356, 394; 24/115 G, 136 R, 115 M;
D11/215, 212; D2/978

See application file for complete search history.

(56) **References Cited**

U.S. PATENT DOCUMENTS

- 4,622,723 A * 11/1986 Krauss 24/115 G
- 4,675,948 A * 6/1987 Bengtsson 24/115 G
- 4,839,946 A * 6/1989 Murai 24/115 G
- D310,166 S * 8/1990 Fildan D8/383
- D343,570 S * 1/1994 Meier D8/383
- 5,323,514 A * 6/1994 Masuda et al. 24/115 G
- D367,222 S * 2/1996 Ikeda D8/383
- D368,852 S * 4/1996 Ikeda D8/383
- D373,076 S * 8/1996 Ikeda D8/383
- 5,621,952 A * 4/1997 Frano 24/115 G
- 5,671,505 A * 9/1997 Anscher 24/115 G
- 5,737,808 A * 4/1998 Ikeda 24/115 G
- D399,045 S * 10/1998 Liston D2/978
- D402,190 S * 12/1998 Anscher D8/383
- D417,388 S * 12/1999 Kawahara D8/383
- 6,018,851 A * 2/2000 Anscher 24/115 G
- 6,038,746 A * 3/2000 Anscher et al. 24/115 G

- D430,484 S * 9/2000 Ikeda D8/383
- D439,148 S * 3/2001 Ishii D8/383
- D439,507 S * 3/2001 Ikeda D8/383
- D451,005 S * 11/2001 Murata D8/383
- 6,334,240 B1 * 1/2002 Li 24/115 G
- 6,339,865 B1 * 1/2002 Takahashi et al. 24/136 R
- D454,777 S * 3/2002 Yoshiguchi D8/383

(Continued)

FOREIGN PATENT DOCUMENTS

JP	1178422	7/2003
JP	1199632	3/2004
JP	1199945	3/2004

Primary Examiner—Holly H. Baynham

Assistant Examiner—Sheryl Friedman

(74) *Attorney, Agent, or Firm*—Everest Intellectual Property Law Group; Michael S. Leonard

(57) **CLAIM**

The ornamental design for a cord stopper, as shown and described.

DESCRIPTION

FIG. 1 is a front view of a cord stopper of the claimed design.

FIG. 2 is a rear view of the cord stopper of FIG. 1.

FIG. 3 is a plan view of the cord stopper of FIG. 1.

FIG. 4 is a base view of the cord stopper of FIG. 1.

FIG. 5 is a right side view of the cord stopper of FIG. 1.

FIG. 6 is a perspective view of the cord stopper of FIG. 1; and,

FIG. 7 is a perspective reference view of the cord stopper of FIG. 1, showing it in use.

The broken line showing of the cord is included for the purpose of illustrating environment and forms no part of the claimed design.

1 Claim, 3 Drawing Sheets

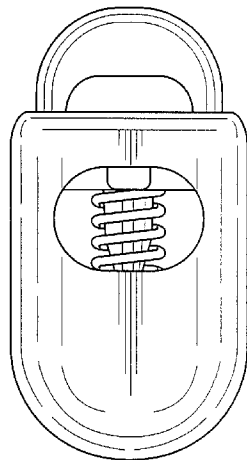

US D559,668 S

Page 2

U.S. PATENT DOCUMENTS

D465,408 S *	11/2002	Man et al.	D8/395	7,140,078 B2 *	11/2006	Watabe	24/115 G
D481,300 S *	10/2003	Nezu	D8/383	D540,662 S *	4/2007	Pontaoe	D8/383
D481,301 S *	10/2003	Nezu	D8/383	D543,445 S *	5/2007	Latal et al.	D8/383
D485,488 S *	1/2004	Tsukuda	D8/383	D548,578 S *	8/2007	Wu	D8/383
D497,540 S *	10/2004	Watabe et al.	D8/383	D549,087 S *	8/2007	Pontaoe et al.	D8/383

* cited by examiner

FIG. 1

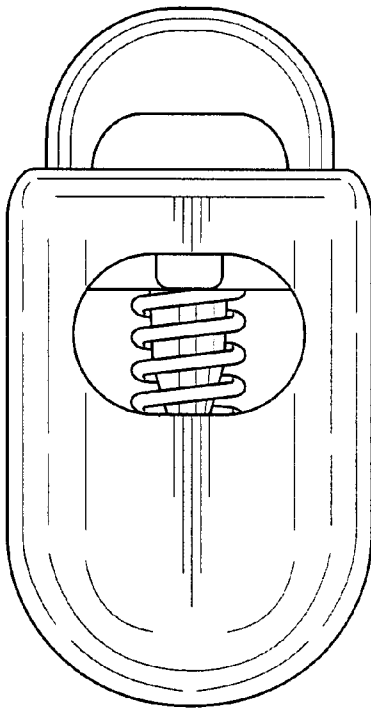

FIG. 2

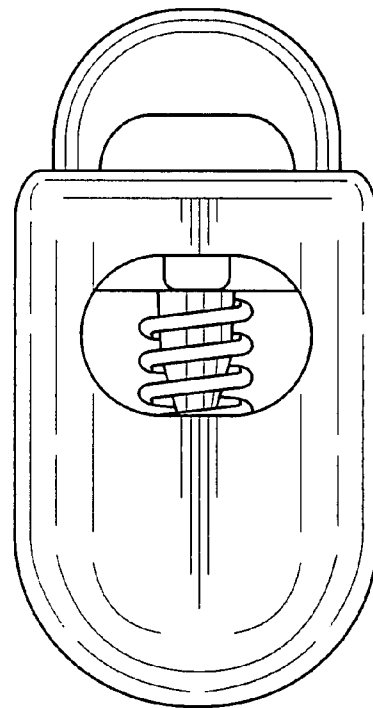

FIG. 3

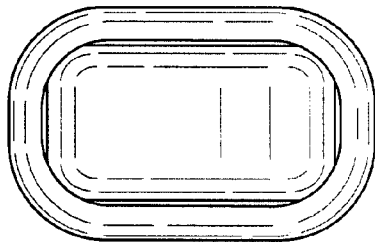

FIG. 4

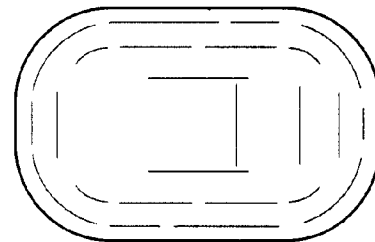

FIG. 5

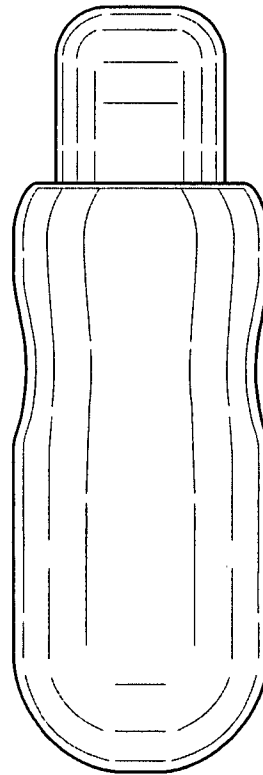

FIG. 6

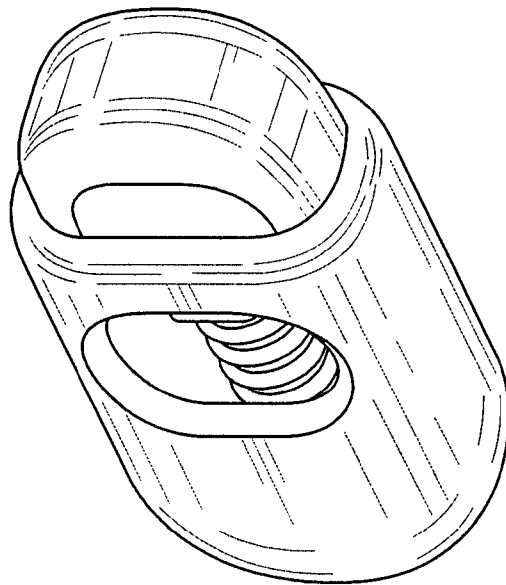

FIG. 7

