



(12) **United States Design Patent**
Watson et al.

(10) **Patent No.:** **US D903,968 S**
(45) **Date of Patent:** **** Dec. 1, 2020**

(54) **MACHINE FOR EARTH-MOVING,
MATERIAL HANDLING, LIFTING, AND/OR
CONSTRUCTION**

(71) Applicant: **J.C. BAMFORD EXCAVATORS
LIMITED**, Uttoxeter (GB)

(72) Inventors: **Ben Watson**, Uttoxeter (GB); **Louis
Gospel**, Uttoxeter (GB); **Steve
Newberry**, Uttoxeter (GB)

(73) Assignee: **J.C. BAMFORD EXCAVATORS
LIMITED**, Staffordshire (GB)

(**) Term: **15 Years**

(21) Appl. No.: **29/706,329**

(22) Filed: **Sep. 19, 2019**

(30) **Foreign Application Priority Data**

Mar. 26, 2019 (WO) DM/202419

(51) **LOC (12) Cl.** **12-05**

(52) **U.S. Cl.**
USPC **D34/34; D34/35; D15/28**

(58) **Field of Classification Search**
USPC D34/34, 35, 28, 33, 37; D15/28, 22-26;
296/190, 202; 37/341, 442; 414/529,
414/572, 718, 785, 607
(Continued)

(56) **References Cited**

U.S. PATENT DOCUMENTS

D231,975 S * 7/1974 Aiello et al. D34/34
D316,468 S * 4/1991 Sandrock D15/23
(Continued)

Primary Examiner — Mark A Goodwin

(74) *Attorney, Agent, or Firm* — Marshall, Gerstein &
Borun LLP

(57) **CLAIM**

The ornamental design for a machine for earth-moving,
material handling, lifting, and/or construction, as shown and
described.

DESCRIPTION

FIG. 1 is a top, front, and right-side isometric view a
machine for earth-moving, material handling, lifting, and/or
construction showing the new design.

FIG. 2 is an enlarged top, back, and right-side isometric view
of the part of the machine that bears the claimed design.

FIG. 3 is a top plan view of the part of the machine that
machine seen in FIG. 2.

FIG. 4 is a right-side elevation view of the part seen in FIG.
2.

FIG. 5 is a back elevation view of the part seen in FIG. 2.

FIG. 6 is a left-side elevation view of the part seen in FIG.
2.

FIG. 7 is a front elevation view of the part seen in FIG. 2.

FIG. 8 is a bottom plan view of the part seen in FIG. 2.

FIG. 9 is a rear elevation view of the machine for earth-
moving, material handling, lifting, and/or construction seen
in FIG. 1, showing a second embodiment of the design,
which a mirror image of the first embodiment that is borne
on a different part of the same machine.

FIG. 10 is an enlarged top, back, and left-side isometric view
of the part of the machine that bears the second embodiment
of the design.

FIG. 11 is a top plan view of the part seen in FIG. 10.

FIG. 12 is a rear elevation view of the part seen in FIG. 10.

FIG. 13 is a left-side elevation view of the part seen in FIG.
10.

FIG. 14 is a front elevation view of the part seen in FIG. 10.

FIG. 15 is a right-side elevation view of the part seen in FIG.
10; and,

FIG. 16 is a bottom plan view of the part seen in FIG. 10.

The broken lines in FIGS. 1, 6, 9, and 15 depict portions of
the machine for earth-moving, material handling, lifting,
and/or construction that form no part of the claimed design.

1 Claim, 8 Drawing Sheets

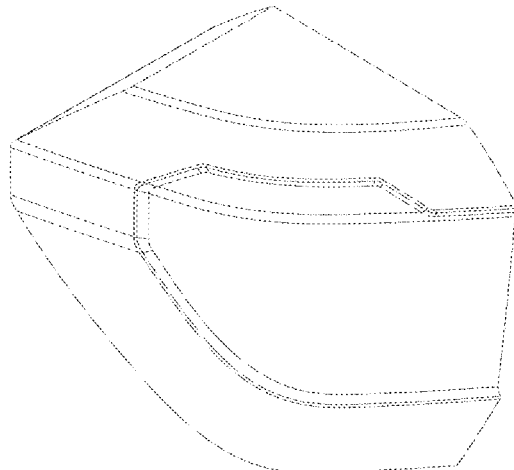

- (58) **Field of Classification Search**
 CPC B66F 9/0655; B66F 9/20; B66F 17/00
 See application file for complete search history.

(56) **References Cited**

U.S. PATENT DOCUMENTS

5,199,861	A	*	4/1993	Merlo	B66F 9/0655
						180/89.12
D366,489	S	*	1/1996	Brown	D15/22
D376,243	S	*	12/1996	Magni	D34/34
5,687,809	A	*	11/1997	Braud	B60K 5/04
						180/292
5,836,733	A	*	11/1998	Moses	B66F 9/0655
						414/685
D438,359	S	*	2/2001	Braud	D15/23
D460,085	S	*	7/2002	Crookes	D15/25
D461,831	S	*	8/2002	Laberheim	D15/25
D480,529	S	*	10/2003	Pini	D34/34
D609,721	S	*	2/2010	Schmidt	D15/23
D610,170	S	*	2/2010	Schmidt	D15/23
D634,757	S	*	3/2011	Mack	D15/10
D668,271	S	*	10/2012	Hutchinson	D15/33
D723,240	S	*	2/2015	Gonzales	D34/35
D756,057	S	*	5/2016	Nessler	D34/34
D855,659	S	*	8/2019	Kasaba	D15/23

* cited by examiner

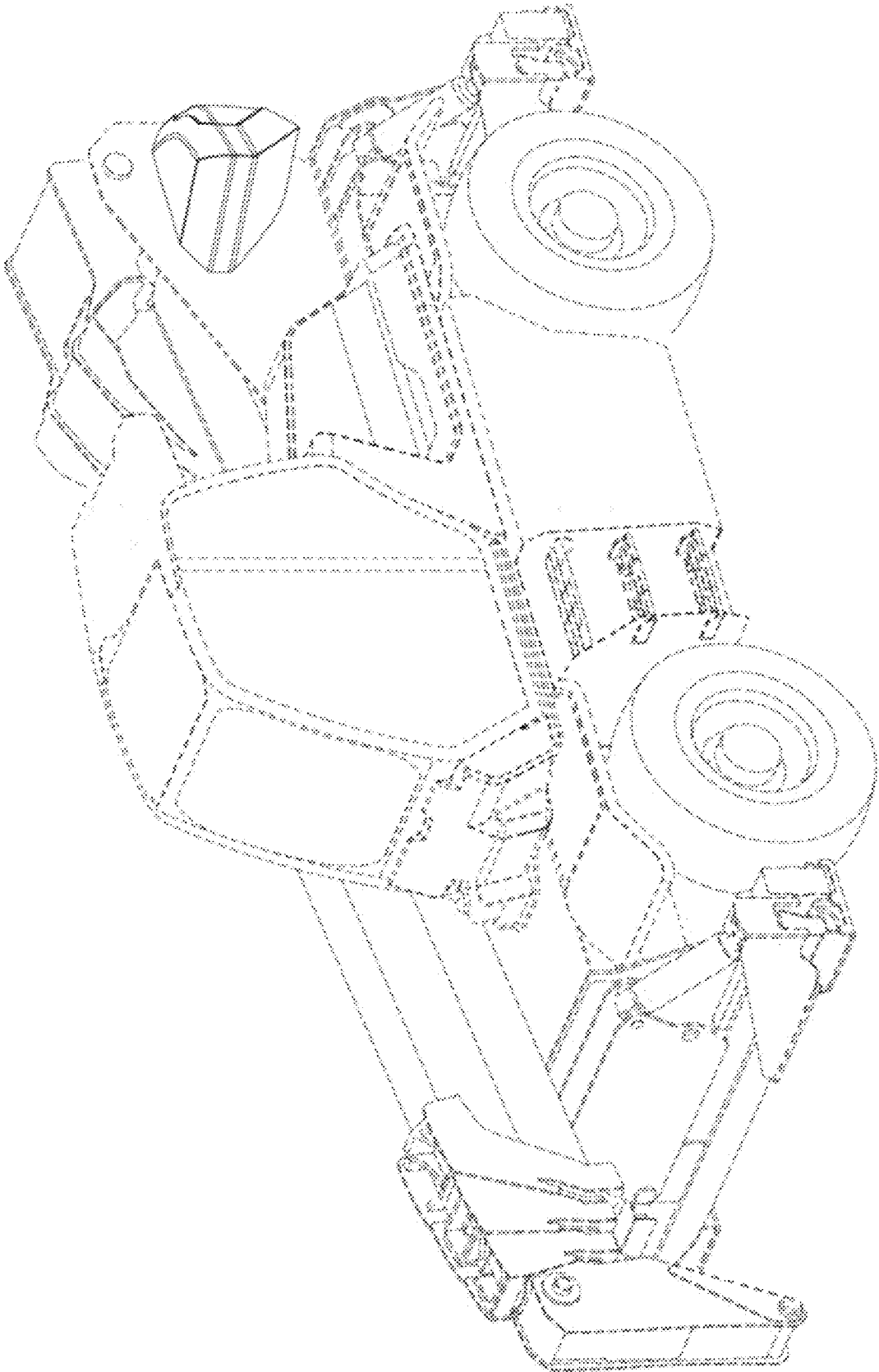

Fig. 1

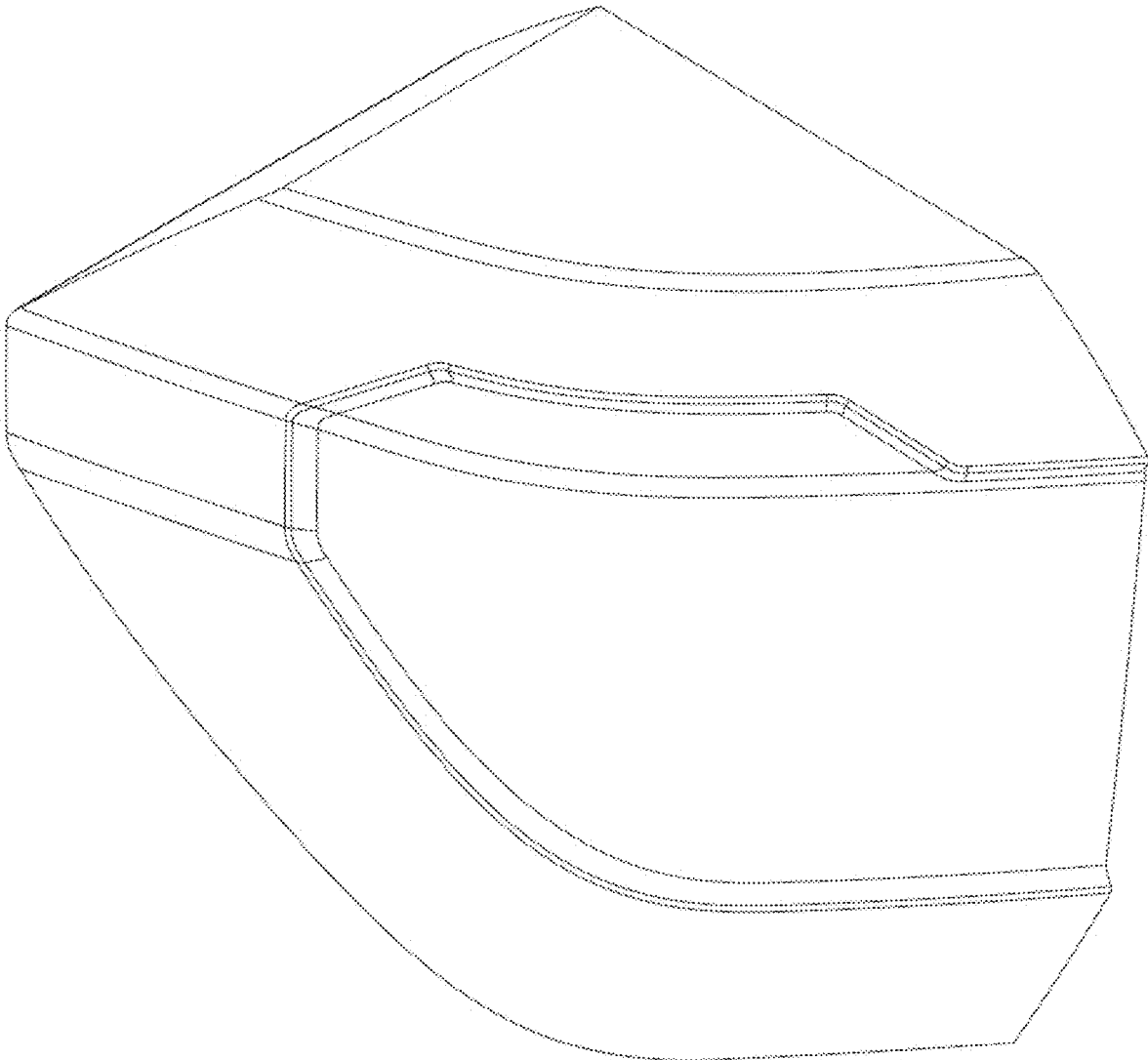

Fig. 2

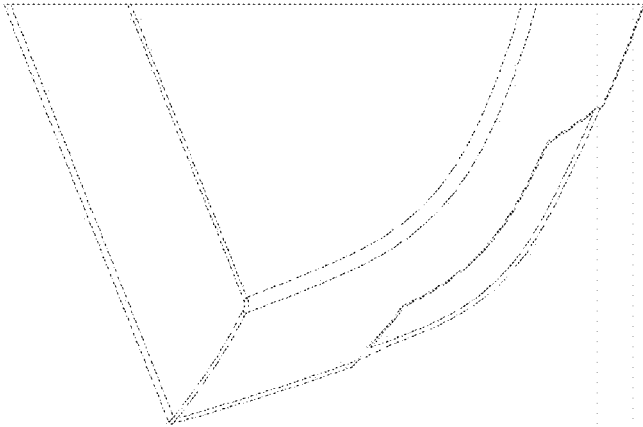

Fig. 3

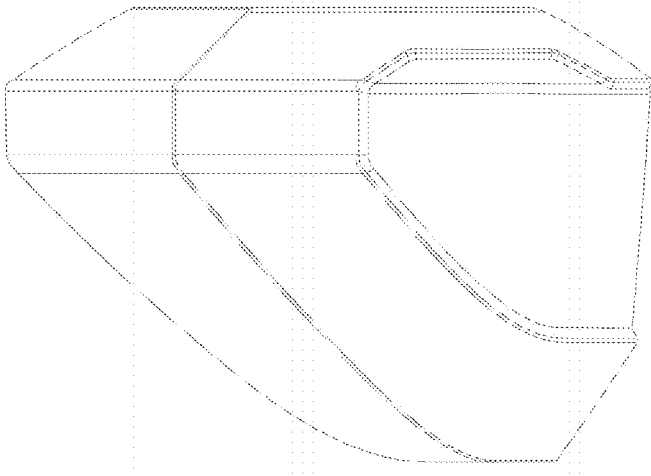

Fig. 4

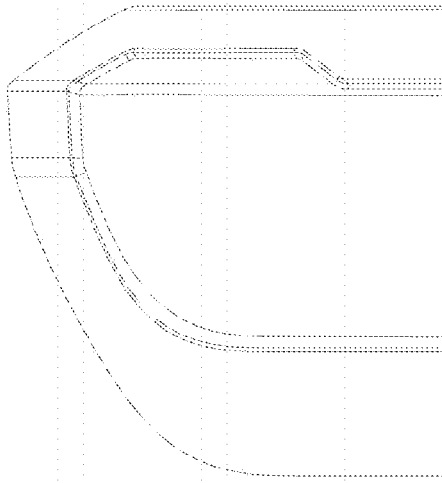

Fig. 5

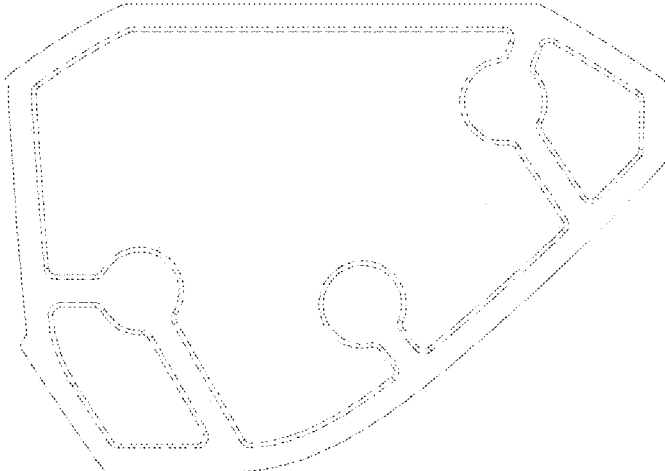

Fig. 6

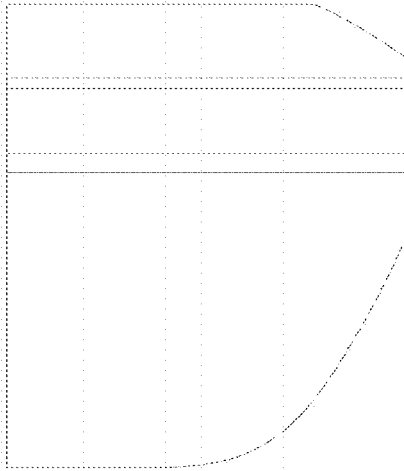

Fig. 7

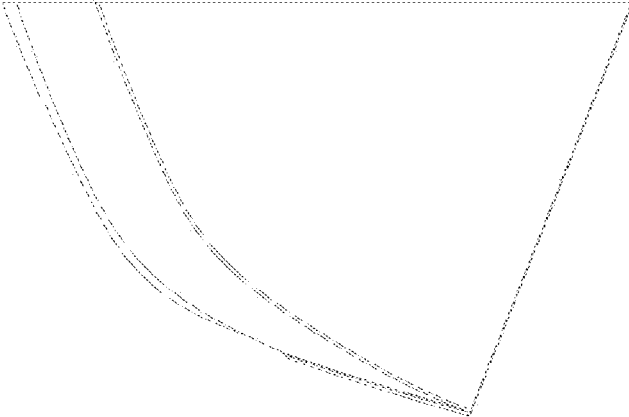

Fig. 8

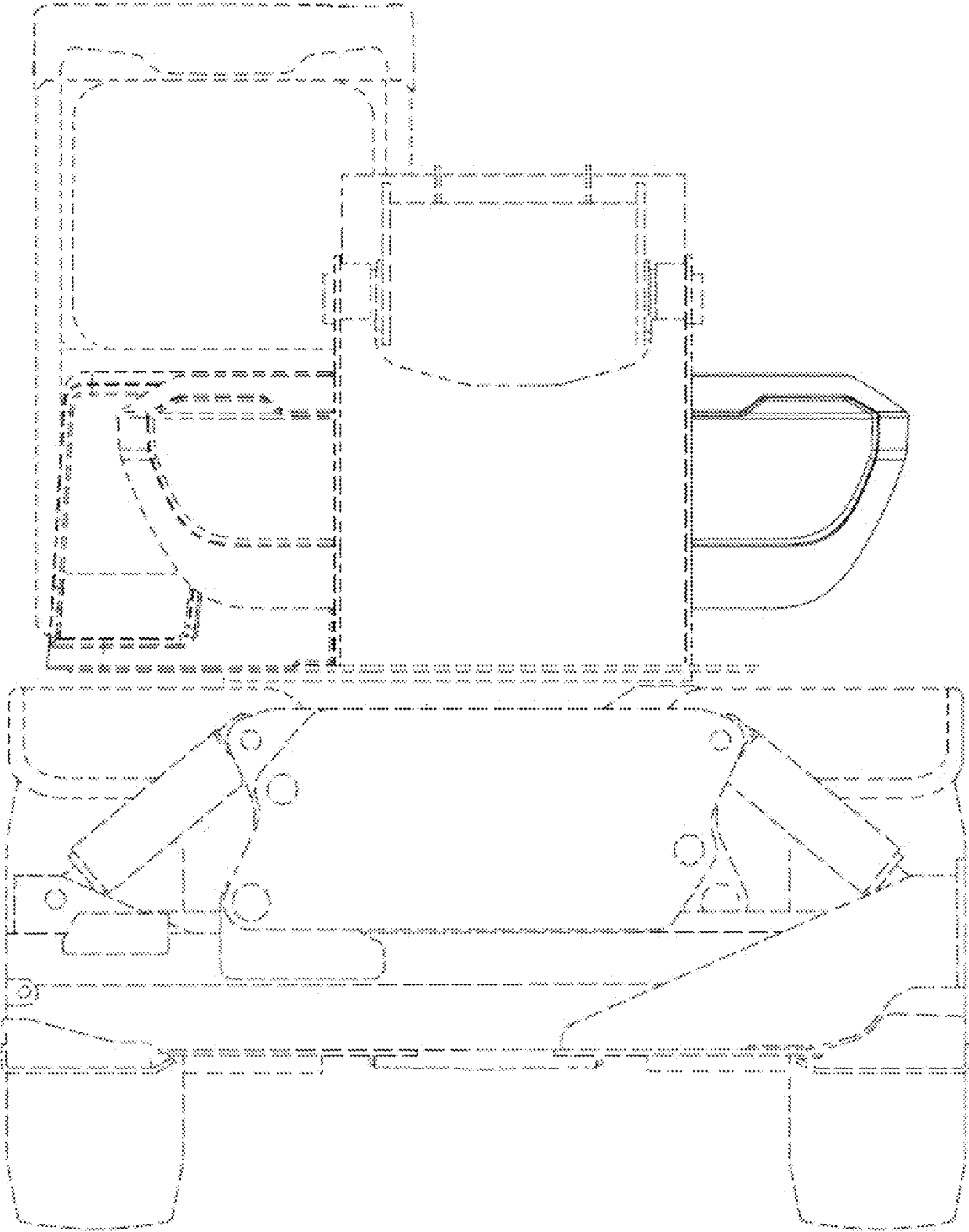

Fig. 9

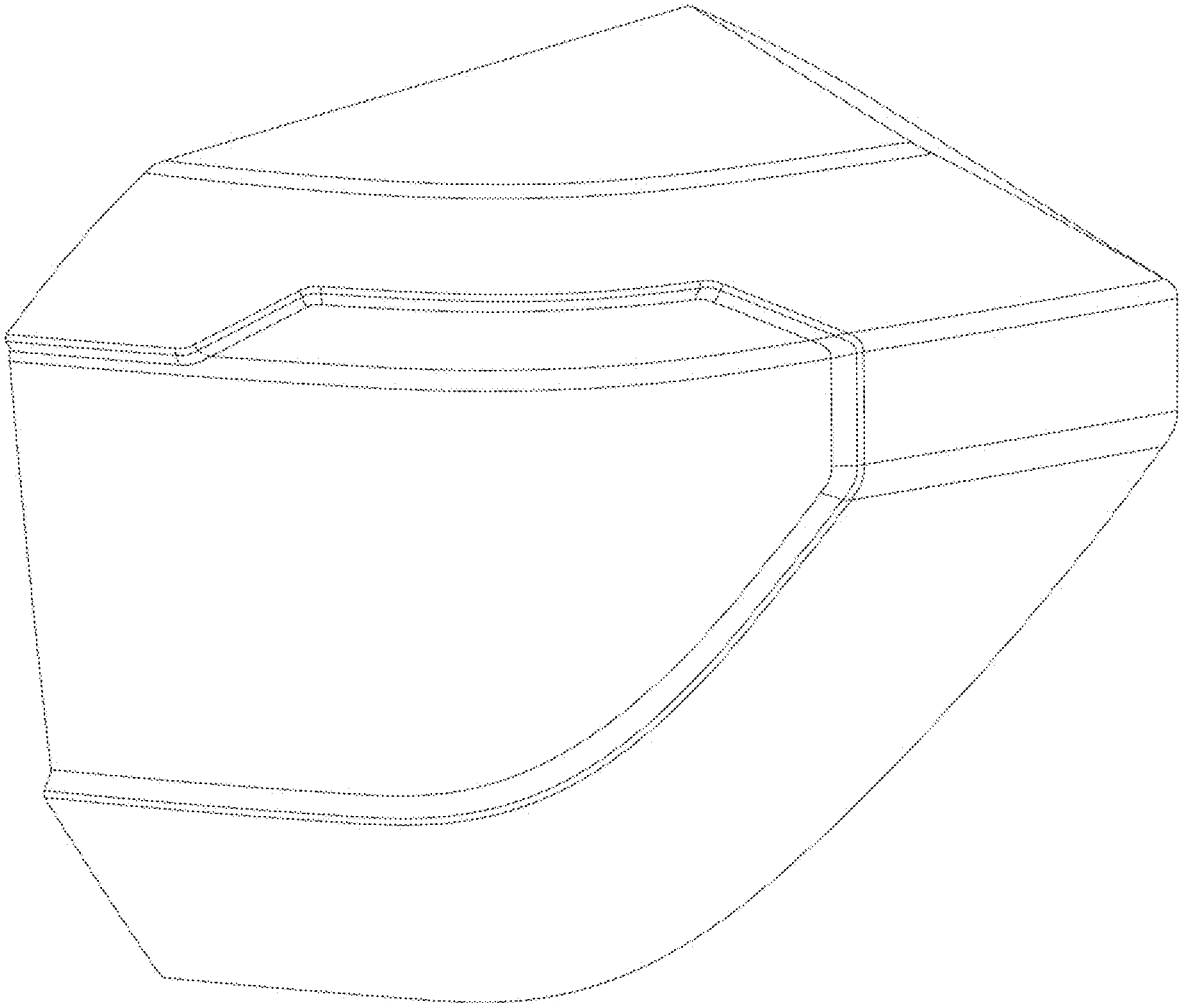

Fig. 10

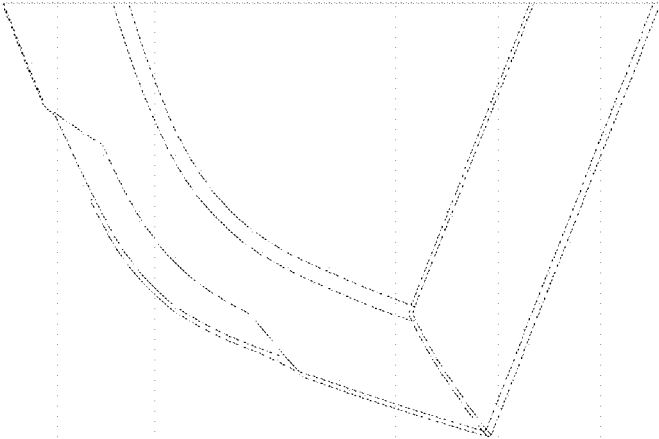

Fig. 11

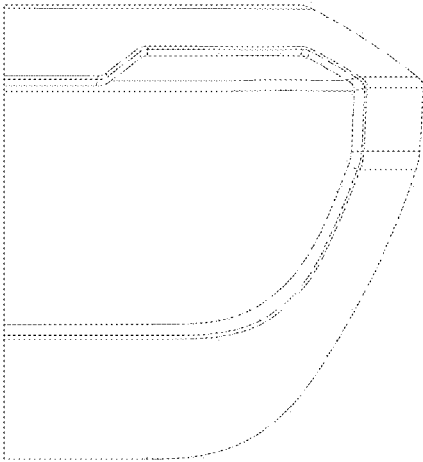

Fig. 12

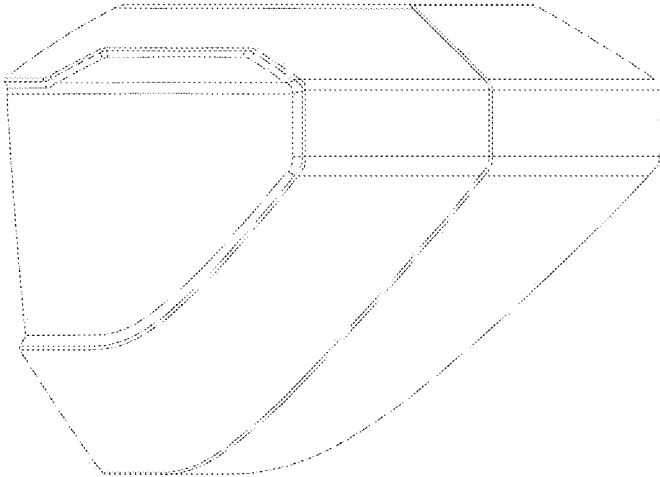

Fig. 13

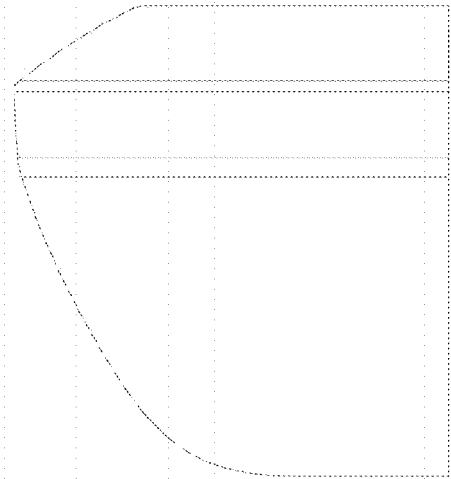

Fig. 14

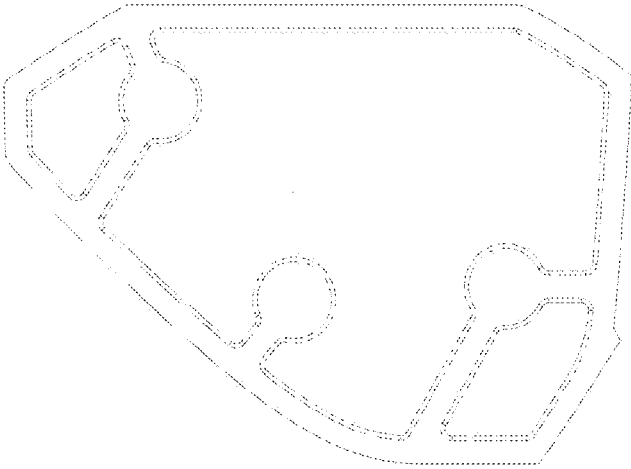

Fig. 15

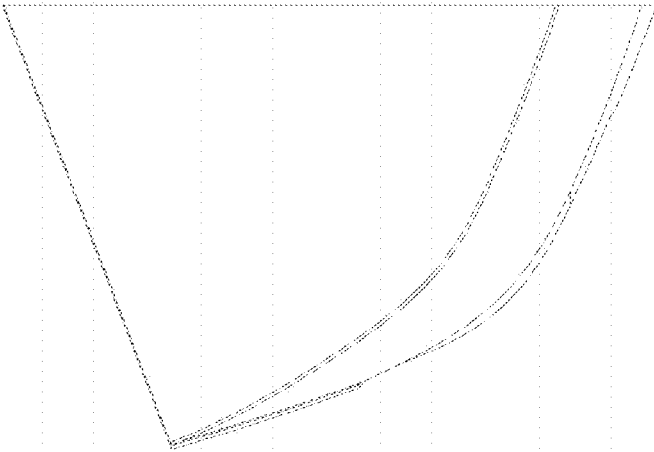

Fig. 16