

[54] WRISTWATCH

[75] Inventor: Giorgetto Giugiaro, Trofarello, Italy

[73] Assignee: Kabushiki Kaisha Hattori Seiko, Tokyo, Japan

[**] Term: 14 Years

[21] Appl. No.: 509,169

[22] Filed: Jun. 29, 1983

[30] Foreign Application Priority Data

Jan. 20, 1983 [JP] Japan 58-1955

[52] U.S. Cl. D10/39; D10/40 X; D10/30 X

[58] Field of Search D10/30-40, D10/122-128; 368/10, 101, 107-108, 110-113, 223, 228, 276-278, 280-282, 285

[56] References Cited

U.S. PATENT DOCUMENTS

- D. 267,784 2/1983 Heuer D10/30
- D. 267,785 2/1983 Heuer D10/30

D. 268,168 3/1983 Schneider D10/30

OTHER PUBLICATIONS

The Washington Post/Potomac/Dec. 10, 1972-p. 41-- Watch at upper-middle-left-with arrows.

European Jeweler-5/72-p. 90-Watch at bottom.

European Jeweler-10/79-p. 122-Watch at bottom right.

Suisses Textiles-#4/1949-p. 53-Watch at bottom-right.

Primary Examiner—Nelson C. Holtje

Attorney, Agent, or Firm—Robert E. Burns; Emmanuel J. Lobato; Bruce L. Adams

[57] CLAIM

The ornamental design for a wristwatch, substantially as shown and described.

DESCRIPTION

FIG. 1 is a front elevational view of a wristwatch showing my new design;

FIG. 2 is a left side elevational view thereof;

FIG. 3 is a right side elevational view thereof;

FIG. 4 is a rear elevational view thereof;

FIG. 5 is a top plan view thereof; and

FIG. 6 is a bottom plan view thereof.

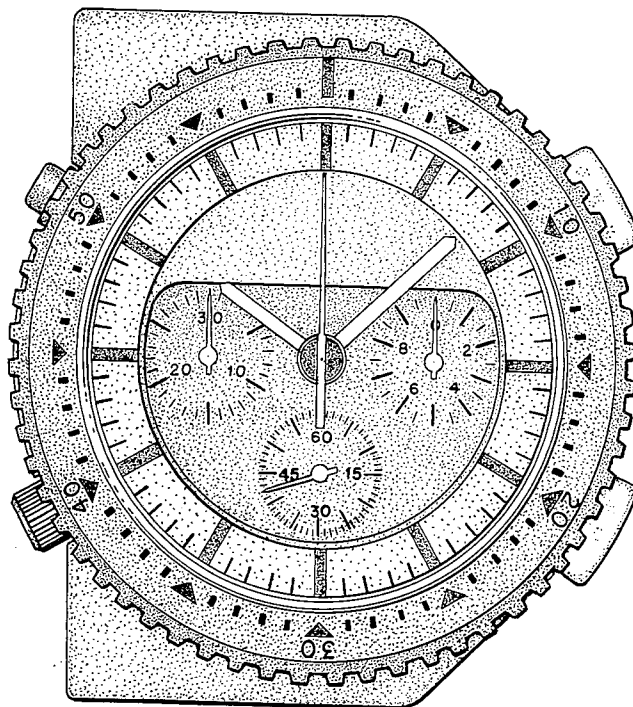

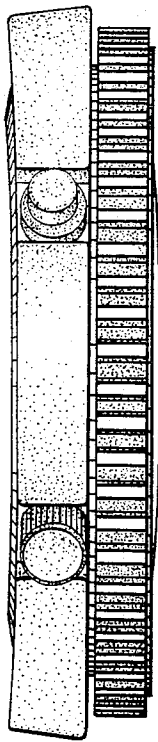

FIG. 2

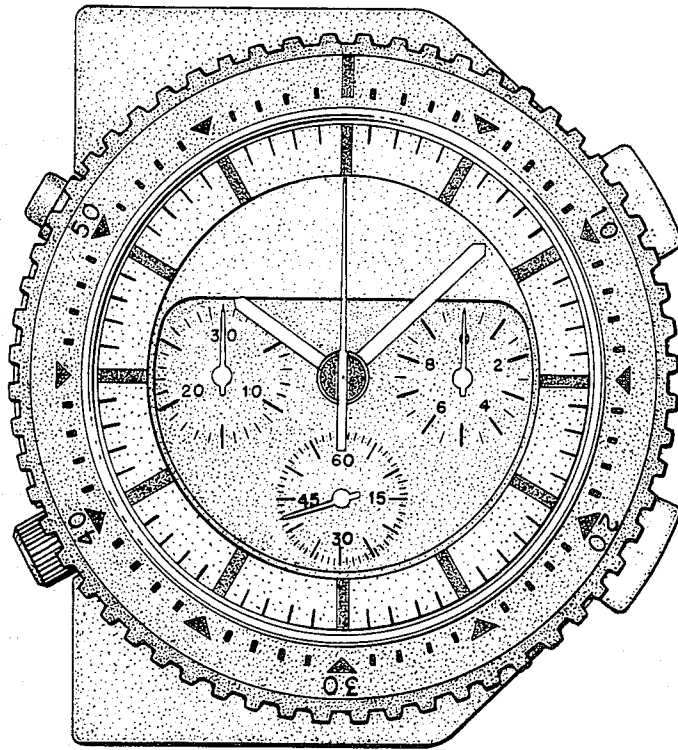

FIG. 1

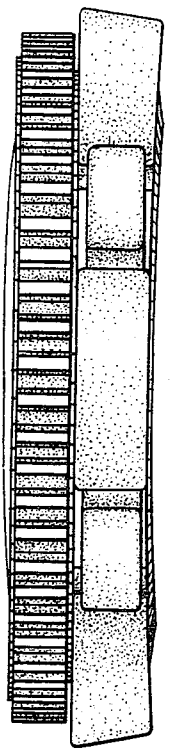

FIG. 3

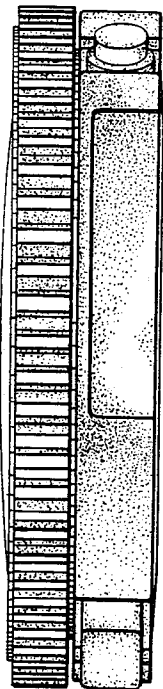

FIG. 5

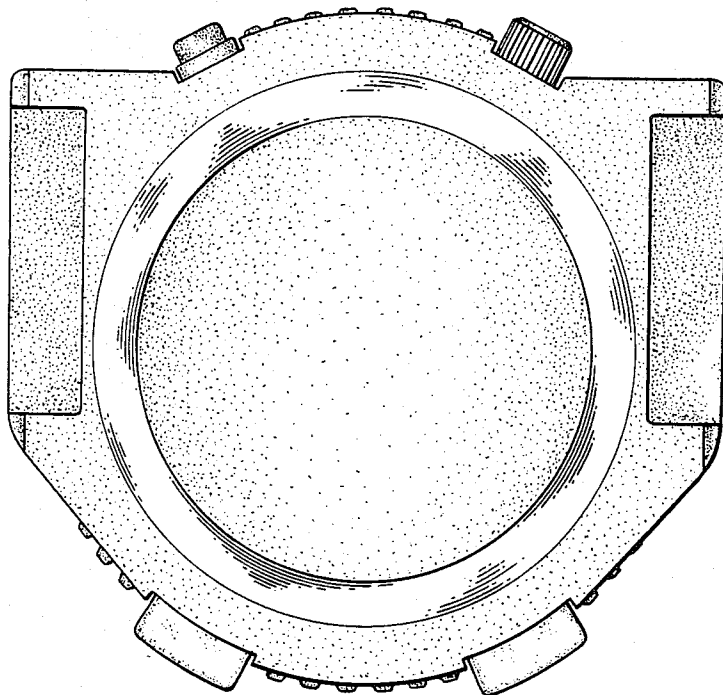

FIG. 4

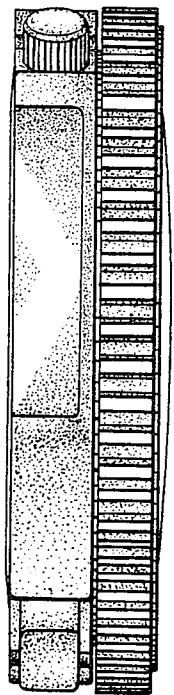

FIG. 6