



(86) Date de dépôt PCT/PCT Filing Date: 2012/02/03
 (87) Date publication PCT/PCT Publication Date: 2012/08/09
 (85) Entrée phase nationale/National Entry: 2013/07/26
 (86) N° demande PCT/PCT Application No.: EP 2012/000488
 (87) N° publication PCT/PCT Publication No.: 2012/104098
 (30) Priorités/Priorities: 2011/02/04 (US61/439,591);
 2011/02/07 (EP11153523.3)

(51) Cl.Int./Int.Cl. *B05D 3/14* (2006.01),
B41M 3/14 (2006.01), *B42D 15/00* (2006.01),
B42D 15/10 (2006.01)
 (71) Demandeur/Applicant:
 SICPA HOLDING SA, CH
 (72) Inventeurs/Inventors:
 DEGOTT, PIERRE, CH;
 DESPLAND, CLAUDE-ALAIN, CH;
 SCHMID, MATHIEU, CH;
 AMERASINGHE, CEDRIC, CH
 (74) Agent: OSLER, HOSKIN & HARCOURT LLP

(54) Titre : DISPOSITIF AFFICHANT UN EFFET DE MOUVEMENT VISUEL DYNAMIQUE ET SON PROCEDE DE PRODUCTION
 (54) Title: DEVICE DISPLAYING A DYNAMIC VISUAL MOTION EFFECT AND METHOD FOR PRODUCING SAME

Fig. 3

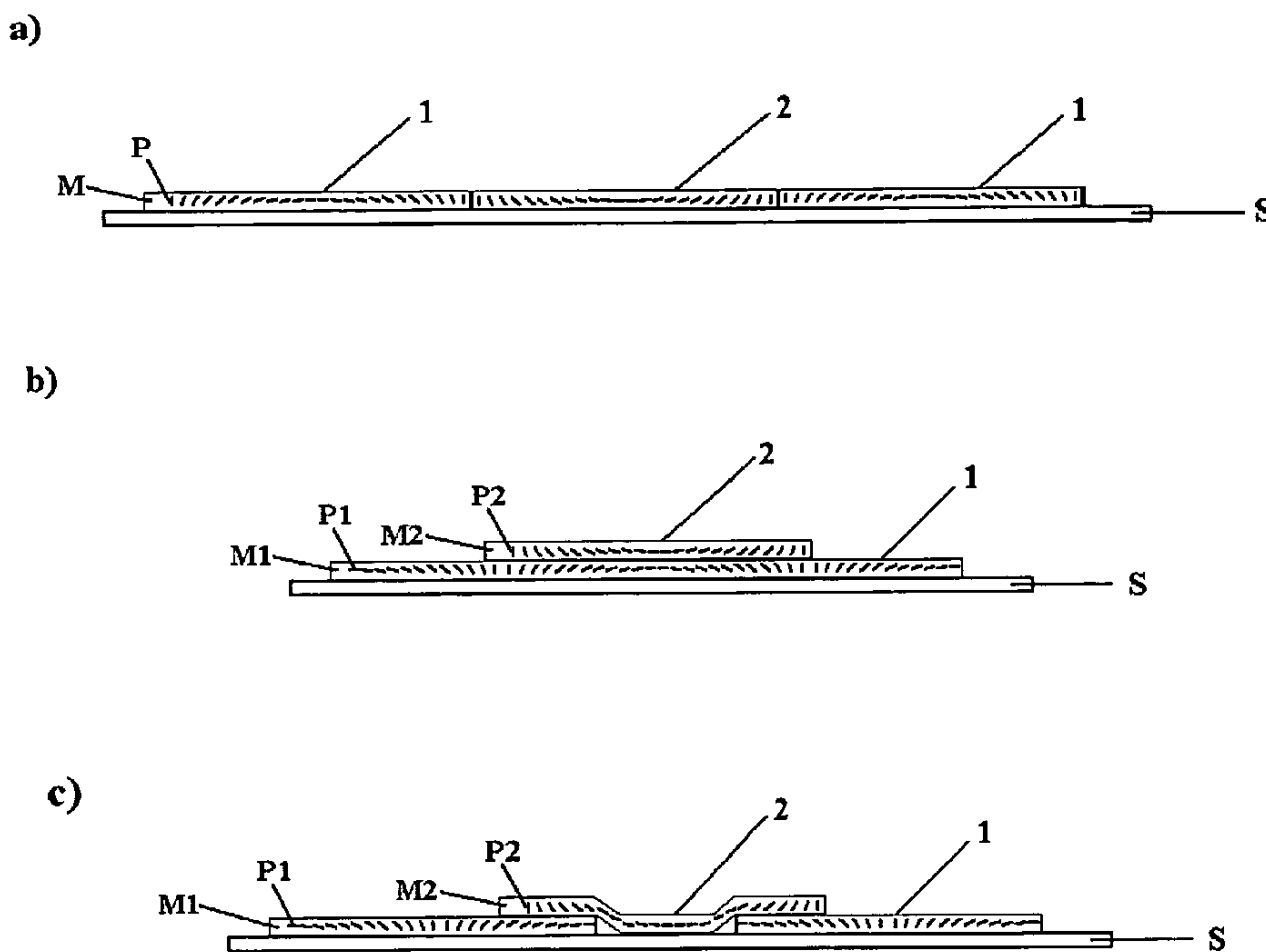

(57) **Abrégé/Abstract:**

Disclosed is a device for the counterfeit protection of a banknote, a document of value or an article. The device comprises a substrate (S), and on said substrate (S) a plurality of jointly visible zones of first (1) and of second (2) hardened coatings comprising



(57) **Abrégé(suite)/Abstract(continued):**

magnetically oriented pigment particles (P1, P2) in a transparent binder (M1, M2), said first (1) hardened coating having a pigment orientation imitating a first curved surface and said second (2) hardened coating having a pigment orientation imitating a second curved surface different from said first curved surface. The device is characterized in that, along a linear section through the device, at least one zone of said second (2) hardened coating is contiguously located between two zones of said first (1) hardened coating. The coatings can be aside each other, on top of each other, and/or on both sides of a transparent substrate so as to form a see-through feature. Disclosed are further a method for producing said device, the use of said device, as well as security documents carrying said device. The method comprises also consecutive selective hardening steps alternating with orienting steps.

(12) INTERNATIONAL APPLICATION PUBLISHED UNDER THE PATENT COOPERATION TREATY (PCT)

(19) World Intellectual Property
Organization
International Bureau(10) International Publication Number
WO 2012/104098 A1(43) International Publication Date
9 August 2012 (09.08.2012)

(51) International Patent Classification:

B05D 3/14 (2006.01) *B42D 15/00* (2006.01)
B41M 3/14 (2006.01) *B42D 15/10* (2006.01)

(21) International Application Number:

PCT/EP2012/000488

(22) International Filing Date:

3 February 2012 (03.02.2012)

(25) Filing Language:

English

(26) Publication Language:

English

(30) Priority Data:

61/439,591 4 February 2011 (04.02.2011) US
11153523.3 7 February 2011 (07.02.2011) EP

(71) Applicant (for all designated States except US): **SICPA HOLDING SA** [CH/CH]; Av. de Florissant 41, CH-1008 Prilly (CH).

(72) Inventors; and

(75) Inventors/Applicants (for US only): **DEGOTT, Pierre** [FR/CH]; Chemin des Falaises 15, CH-1023 Crissier (CH). **DESPLAND, Claude-Alain** [CH/CH]; Chemin de la Cure 8, CH-1008 Prilly (CH). **SCHMID, Mathieu** [CH/CH]; Rue du Vallon 10, CH-1005 Lausanne (CH). **AMERAS-INGHE, Cédric** [CH/CH]; La Palombe 1, CH-1031 Mex (CH).(74) Agent: **BUBLAK, Wolfgang**; Bardehle Pagenberg, Prinzregentenplatz 7, 81675 München (DE).

(81) Designated States (unless otherwise indicated, for every kind of national protection available): AE, AG, AL, AM, AO, AT, AU, AZ, BA, BB, BG, BH, BR, BW, BY, BZ, CA, CH, CL, CN, CO, CR, CU, CZ, DE, DK, DM, DO, DZ, EC, EE, EG, ES, FI, GB, GD, GE, GH, GM, GT, HN, HR, HU, ID, IL, IN, IS, JP, KE, KG, KM, KN, KP, KR, KZ, LA, LC, LK, LR, LS, LT, LU, LY, MA, MD, ME, MG, MK, MN, MW, MX, MY, MZ, NA, NG, NI, NO, NZ, OM, PE, PG, PH, PL, PT, QA, RO, RS, RU, RW, SC, SD, SE, SG, SK, SL, SM, ST, SV, SY, TH, TJ, TM, TN, TR, TT, TZ, UA, UG, US, UZ, VC, VN, ZA, ZM, ZW.

(84) Designated States (unless otherwise indicated, for every kind of regional protection available): ARIPO (BW, GH, GM, KE, LR, LS, MW, MZ, NA, RW, SD, SL, SZ, TZ, UG, ZM, ZW), Eurasian (AM, AZ, BY, KG, KZ, MD, RU, TJ, TM), European (AL, AT, BE, BG, CH, CY, CZ, DE, DK, EE, ES, FI, FR, GB, GR, HR, HU, IE, IS, IT, LT, LU, LV, MC, MK, MT, NL, NO, PL, PT, RO, RS, SE, SI, SK, SM, TR), OAPI (BF, BJ, CF, CG, CI, CM, GA, GN, GQ, GW, ML, MR, NE, SN, TD, TG).

Published:

— with international search report (Art. 21(3))

(54) Title: DEVICE DISPLAYING A DYNAMIC VISUAL MOTION EFFECT AND METHOD FOR PRODUCING SAME

Fig. 3

a)



b)

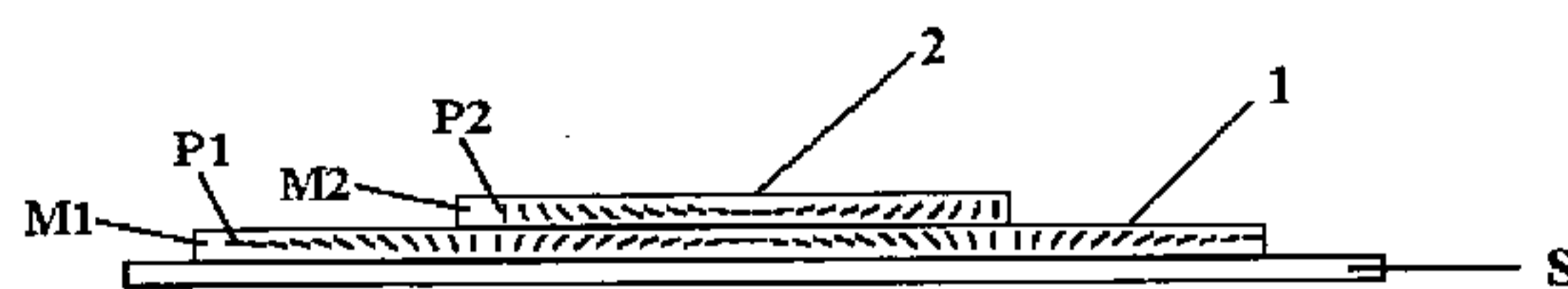

c)

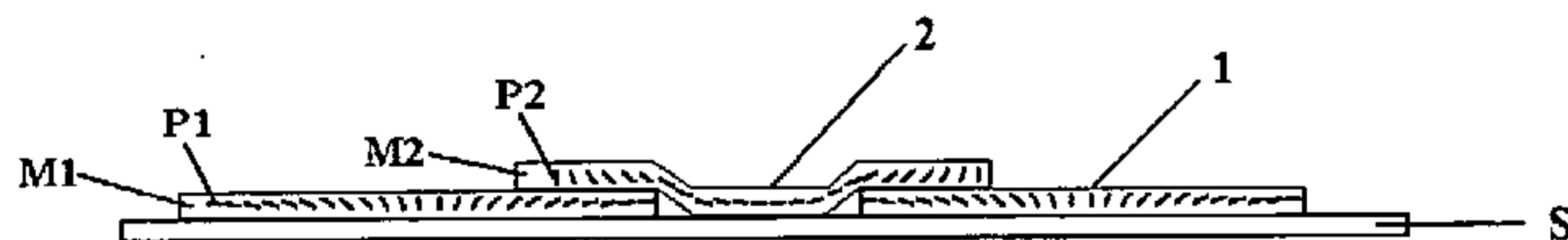

(57) Abstract: Disclosed is a device for the counterfeit protection of a banknote, a document of value or an article. The device comprises a substrate (S), and on said substrate (S) a plurality of jointly visible zones of first (1) and of second (2) hardened coatings comprising magnetically oriented pigment particles (P1, P2) in a transparent binder (M1, M2), said first (1) hardened coating having a pigment orientation imitating a first curved surface and said second (2) hardened coating having a pigment orientation imitating a second curved surface different from said first curved surface. The device is characterized in that, along a linear section through the device, at least one zone of said second (2) hardened coating is contiguously located between two zones of said first (1) hardened coating. The coatings can be aside each other, on top of each other, and/or on both sides of a transparent substrate so as to form a see-through feature. Disclosed are further a method for producing said device, the use of said device, as well as security documents carrying said device. The method comprises also consecutive selective hardening steps alternating with orienting steps.

Device displaying a dynamic visual motion effect and method for producing same

5

Field of invention

The present invention is in the field of devices for the protection of banknotes, documents of value, or articles in general. It concerns a printed image comprising oriented pigment particles. The image according to the invention shows a dynamic visual motion effect upon tilting, such that one part of the image appears to move in a different plane than the rest.

10

State of the art

Devices for the protection of documents, which display a visual motion effect upon tilting, have been disclosed in US 7,738,175 by Steenblik et al. Said devices comprise a lenticular array, embodied in a plastic foil or the like, which is associated with microprinted indicia on the document, e.g. through an affixing of the said foil to the document.

20

Other types of devices for the protection of documents, which display visual motion or “3-dimensional” optical effects, have been disclosed in US 2004/0051297 and in the corresponding international application WO 2004/007095, as well as in WO 2008/009569. These effects are based on surface coatings comprising oriented pigment particles, whose orientation changes gradually across the coated surface.

25

According to WO 2004/007095, a first visual effect, called “Flip-Flop” effect (**Fig. 1a**), is based on a pigment orientation imitating a positively (i.e. towards the observer) curved surface across the coating. The observer sees a specular reflection zone, which moves with the rotation sense of tilting.

30

According to WO 2004/007095, a second visual effect, called “Rolling Bar” effect (**Fig. 1b**), is based on a pigment orientation imitating a negatively (i.e. away from the observer) curved surface across the coating. The observer sees a specular reflection zone, which moves against the rotation sense of tilting.

US 2005/0106367, a continuation in part of US 2004/0051297, further discloses a “double rolling bar”. Upon tilting the document the two “rolling bars” seem to move against each other. Also disclosed is a “double-tilt” feature, wherein, upon tilting the document, a bright zone switches from one part of the document to another.

Description of the invention

Present inventors have found that, by an extension of the principle outlined in US 2005/0106367, by combining first and second coatings applied to a plurality of first and second contiguous zones on a substrate, wherein said first coating comprises oriented pigment particles whose orientations imitate a first curved surface, and said second coating comprises oriented pigment particles whose orientations imitate a second curved surface different from said first curved surface, a device showing a dynamic visual motion effect can be produced, wherein the image represented by said first zones and the image represented by said second zones appear to move in different planes in space upon tilting the substrate. The dynamic visual motion effect is some sort of optical illusion, simulating parallax, which is perceived upon changing the angle of view, and which is displayed by the said combination of first and second zones of coatings having said particular pigment orientations. The device is useful as a security element or security feature for the protection of banknotes, value documents, identity documents or, generally any article which requires authentication.

Herein, a “security element” or “security feature” shall designate an element on a banknote or another security document for the purpose of determining its authenticity and protecting it against counterfeits.

5 The device according to the invention comprises thus a substrate (S), and on said substrate (S) a plurality of jointly visible zones of first (1) and of second (2) hardened coatings comprising oriented pigment particles (P1, P2) in a transparent binder (M1, M2), said first (1) hardened coating having a pigment orientation imitating a first curved surface and said second (2) hardened coating having a pigment orientation imitating a second curved surface different from said first curved surface, and is characterized in that, along a linear section through the device, at least one zone of said second (2) hardened coating is contiguously located between two zones of said first (1) hardened coating.

15 Said zones of first (1) and of second (2) hardened coatings are herein to be understood as zones along a linear section through the device, along which the first, the second, and again the first, etc. coating visibly appear in a sequence. On the substrate, said first and said second hardened coatings may, on the other hand, be present as arbitrarily shaped areas, such as the intertwined “snail” structure shown in **Fig. 6b**, which comprises only each a single area of the first and of the second coating, but in which the intertwining produces a larger plurality of first and second zones in a sequence across a linear section. The effect of the invention is noteworthy achieved through the combined view of several alternating juxtaposed zones of the first and the second coating, regardless on whether these zones form united areas or not.

30 Said first and said second coatings may further be disposed either aside each other and/or on top of each other. “Aside each other” means that the material coatings are either contiguous or visually adjacent without substantial amounts of intermediate space between them. Minor amounts of intermediate space, such as a margin or a separation line, which do not

break up the “visual adjacency”, shall however still be comprised under “aside each other”.

5 The coatings are present in a hardened state, having the oriented particles fixed in their respective positions and orientations.

“Imitate a curved surface” means herein that the individual pigment particles, in particular pigment flakes, in the hardened flat coating layer have orientations which correspond to the tangential planes to the said curved surface at the respective projected locations of the particles onto the said curved surface. **Fig. 2a, 2b** illustrate for a negatively and a positively curved surface, respectively, how the pigment orientation in the coating imitates the respective curved surface.

15 “Jointly visible” means herein that the plurality of first and second zones is visible as a combination, producing thereby the effect of the invention.

“Contiguously located” means herein that the visible zones are either contiguous or visually adjacent, without substantial amounts of intermediate space between them. Minor amounts of intermediate space, such as a margin or a separation line, which do not break up the “visual adjacency”, shall however still be comprised under “contiguously located”.

25 “Transparent” in the context of the present description shall mean that the “transparent” item has at least one open spectral window in the 400 nm to 700 nm wavelength range, which allows a human observer to see through it.

30 A “magnet” in the context of the present description shall stand for a single magnet, which may be a multipole magnet, or for an assembly of single magnets forming a magnetization unit; the single magnets may herein be permanent magnets or electromagnets; a single magnet may further be statically fixed within a magnetization unit, or dynamically movable, e.g.

rotatable, with respect to the magnetization unit and to the coating whose pigment particles are to be magnetically oriented. Certain magnetic orientation patterns can noteworthy only be produced through a rotation or other relative movement of a magnet with respect to the coating whose pigment particles are to be magnetically oriented.

The delimitation between said first and said second zone needs not to be a straight line; said delimitation may in fact be of any form or shape. Said second zone can in particular be also any type of form or shape enclosed within said first zone, or vice versa.

In a particularly preferred embodiment of the device according to the present invention, along a linear section through the device, in addition to at least one zone of said second (2) hardened coating being contiguously located between two zones of said first (1) hardened coating, at least one of said two zones of said first (1) hardened coating is contiguously located within two zones of said second (2) hardened coating. A device which is defined by at least two first and two second zones in a sequence along said linear section through the device even better displays said dynamic effect of first and second planes in space. Even more preferably, to produce a perfect optical illusion of first and second planes in space, the device has, along a linear section, an alternating contiguous pattern of more than two zones of said first (1) and/or more than two zones of said second (2) hardened coatings.

Said first and said second curved surfaces in the device according to the present invention must be different from each other in at least one of the following properties: i) the sign of curvature, which may be positive, towards the observer, or negative, away from the observer; ii) the amount of curvature, which may be high or low; iii) the direction or axis of curvature; iv) the nature of curvature which may in particular be cylindrical, conical, elliptical, spherical or saddle-shaped.

The locations of the apices of the said curved surfaces may be chosen at convenience, e.g. if cylindrically curved surfaces of positive and negative curvature are represented by coating (1) and coating (2), respectively, the alternating zones may be aligned such as to make coincide all apices,
5 forming a “channel” of e.g. alternating positive and negative curvature. Alternatively, the zones may also be disposed such that the apices look in a traverse or oblique sense, such as to form an “undulated” structure. In particular, any spatial arrangement may be used.

10 In said combination of first and second curved surfaces, the respective curvatures must be sufficiently different from each other, such that a relative movement of the image in the zones of the first coating against the image in the contiguously located zones of the second coating, i.e. the dynamic motion effect, can be clearly observed upon tilting the device.

15 The substrate of the device according to the present invention may be chosen among all suitable substrate materials, particularly preferred is a paper substrate, an opaque or opacified polymer substrate, a transparent polymer substrate or a metallic substrate such as a metal or preferably a
20 metallized foil.

In case of a transparent substrate, said first (1) and said second (2) hardened coating may further be disposed on the *recto* and on the *verso* side, respectively, of the substrate.

25 Said first and/or said second hardened coating may further be present in the form of indicia selected from the group consisting of the simple geometric figures or patterns, the letters, the texts, the logos and the images. Examples of a simple geometric figure or pattern comprise a “fractured bar”
30 (Fig. 7) or a “checkered” pattern.

In a more sophisticated embodiment, said first and/or said second coatings are present in the form of indicia, such as a text or a logo or an image; e.g. a

second, fine-line coating representing second indicia can be applied over a first, coarse-line coating representing first indicia. Upon tilting the device, said first and second indicia appear to move relative to each other, such that they are visually perceived as belonging to different planes in space, resulting in a dynamic 3-dimensional depth effect through simulation of parallax.

The visual perception of the said first and the said second coating as belonging to different planes in space can be further enhanced through the choice of different colors and the use of different pigments in said first and second coatings.

The pigment particles in the individual coatings may in particular be oriented according to a one-dimensionally curved surface (e.g. a cylinder or conical surface) or according to a two-dimensionally curved surface (e.g. a spherical, elliptical, or saddle-shaped surface). In case of a two-dimensionally curved surface, the curvatures in the first and in the second dimension may noteworthy be different (e.g. an elliptically curved surface or a saddle-shaped surface). A two-dimensionally curved pigment orientation has the advantage that a dynamic 3-dimensional depth effect can be produced for viewing and tilting along all directions. For a one-dimensionally curved pigment orientation, the dynamic depth effect is restricted to a preferred viewing and tilting direction.

The orienting of the pigment particles is most easily performed through the application of correspondingly structured magnetic fields during or following the application of the coating composition containing them, as known from WO 2004/007095, WO 2005/002866, WO 2008/009569, or WO 2008/046702.

To this aim, the pigment particles must be magnetic, which means that they must comprise a permanent magnetic or a magnetizable, i.e. a hard-

magnetic or a soft-magnetic material of the ferromagnetic or ferrimagnetic type.

5 The oriented pigment particle in said first and/or said second hardened coating are preferably selected from the group comprising the flake-shaped vacuum-deposited magnetic thin-film interference pigment particles.

10 Preferred oriented pigment particles (P) in said first and/or said second hardened coating are optically variable magnetic pigment particles.

15 Most preferred pigments are the vacuum-deposited optically variable magnetic thin-film interference pigments, such as the optically variable magnetic pigment flakes of the type disclosed in US 4,838,648 and WO 02/073250.

20 The coating compositions (C1, C2) for embodying the present invention can be formulated according to WO 2007/131833. They are preferably formulated for and applied by a printing method chosen from the group of silkscreen printing, flexographic printing, and gravure printing.

25 After complete orientation of the pigment particles, the coating composition is hardened, thereby freezing the orientations and positions of the pigment particles in the transparent binder containing them. Most preferred is an instant hardening (curing) of the applied composition through radiation curing, i.e. UV-curing or electron beam curing. The term "UV-curing" shall herein also comprise curing by short-wave visible light in the violet, blue, and green range of the spectrum.

30 More than two different areas of coatings, comprising oriented pigment particles in a solid transparent binder wherein said pigment particles are oriented according to different curved surfaces, may be applied to the substrate; the device may noteworthy comprise a plurality of areas of coatings, aside each other and/or on top of each other, visible in different

regions of the coated surface, wherein said curved surfaces differ from each other in at least one of the following properties: i) the sign of curvature, which may be positive, towards the observer, or negative, away from the observer; ii) the amount of curvature, which may be high or low; iii) the
5 direction or axis of curvature; iv) the nature of curvature which may in particular be cylindrical, conical, elliptical, spherical or saddle-shaped.

In the case of transparent polymer substrates (as used for windows and security threads or stripes), interesting complementary effects can be
10 produced by applying said combination of first and second coatings either on a same side or else on different sides of the transparent substrate. Said first and said second coatings may furthermore overlap each other.

Of further interest is a combination of said first and second coatings with at
15 least one further coating, applied aside the others and/or on top of the others, comprising oriented pigment particles.

Said first coating may e.g. represent first fine-line indicia on a transparent substrate, which are visible from below through the substrate; said second
20 coating may e.g. represent a coarse-line background serving for both, viewing from below and viewing from above, and said further coating may, e.g. represent second fine-line indicia which are visible from above the substrate.

Said first and/or said second hardened coating may additionally comprise
25 at least one further additional color-shifting pigment selected from the group consisting of the vacuum-deposited optically variable thin-film interference pigments having an all-dielectric or a metal-dielectric interference design, the coated metal-core particles, the coated dielectric
30 particles, the cholesteric liquid crystal polymer pigments, the embossed holographic pigments, and the mixtures thereof.

Said first and/or said second hardened coating may further additionally comprise a dye and/or at least one further, non-color-shifting pigment, which may be selected from the group consisting of the metallic pigments, the subtractive color pigments, the additive color pigments, the non-color-shifting interference pigments, and the mixtures thereof.

The device according to the present invention may further comprise a combination of areas coated with a composition comprising optically variable pigment and areas coated with a composition not comprising optically variable pigment.

Disclosed is further a method for producing the device according to the present invention, the method comprising the step of applying to a substrate (S) a plurality of areas of first (C1) and of second (C2) coating compositions comprising pigment particles (P1, P2) in a transparent binder (M1, M2), orienting the pigment particles (P1) in said applied first (C1) coating composition such as to imitate a first curved surface, orienting the pigment particles (P2) in said applied second (C2) coating composition such as to imitate a second curved surface different from said first curved surface, and hardening said first and said second coating compositions to obtain first and second hardened coatings (1, 2) having the oriented particles fixed in their respective positions and orientations wherein said areas of first (C1) and of second (C2) coating compositions are applied such that, along a linear section through the device, at least one zone of said second (2) hardened coating is contiguously located between two zones of said first (1) hardened coating.

In a variant of the method, said zones of first (C1) and of second (C2) coating compositions are applied such that additionally at least one of said two zones of said first (1) hardened coating is contiguously located within two zones of said second (2) hardened coating.

Said first and said second curved surfaces are different from each other in at least one of the following properties: i) the sign of curvature, which may be positive, towards the observer, or negative, away from the observer; ii) the amount of curvature, which may be high or low; iii) the direction or axis of curvature; iv) the nature of curvature which may in particular be cylindrical, conical, elliptical, spherical or saddle-shaped.

Said substrate (S) is preferably selected from the group consisting of the paper substrates, the opaque or opacified polymer substrates, the transparent polymer substrates and the metallic substrates.

Said first and said second coatings are each preferably applied by a printing process chosen from silkscreen printing, flexographic printing and gravure printing, using coating compositions which are formulated such as to fit the chosen printing process.

In a particularly preferred embodiment, at least one of said first and second coatings comprises optically variable magnetic pigment of the type disclosed in US 4,838,648 and WO 02/073250. Using optically variable magnetic pigment allows for the incorporation of viewing-angle dependent color shifting properties as a supplementary security feature.

The coating composition is preferably formulated for and hardened by radiation curing, selected from UV-curing and electron-beam curing.

In a particular embodiment, said first and said second coating compositions (C1, C2) can be applied to the *recto* and to the *verso* side, respectively, of a transparent substrate (S).

Said pigment particles (P1, P2) in said first and said second coating compositions (C1, C2) are preferably magnetic pigment particles, comprising a permanent-magnetic or a magnetizable material of the ferromagnetic or ferrimagnetic type, and said orienting the pigment

particles (P₁, P₂) in said applied first and second coating compositions (C₁, C₂) is correspondingly performed by applying magnetic fields.

5 Said pigment particles (P₁, P₂) in said first and/or said second coating compositions (C₁, C₂) are preferably selected from the group comprising the flake-shaped vacuum-deposited magnetic thin-film interference pigment particles.

10 Most preferably, said pigment particles (P₁, P₂) in said first and/or said second coating compositions (C₁, C₂) are optically variable magnetic pigment particles.

The first hardened coating (1) can be produced, i.e. applied, oriented, and hardened, subsequent to the second hardened coating (2), or vice versa.
15 The subsequent production of the coatings (1, 2) has the advantage of allowing the coatings to be applied on top of each other. The steps of applying, orienting, and hardening a coating composition comprising pigment particles (P₁, P₂) in a transparent binder (M₁, M₂) may be repeated at will, to produce further coatings on said substrate (S) and/or
20 said coatings (1, 2).

In a particular embodiment of the method, the first hardened coating (1) and the second hardened coating (2) are produced in a single operation through the following sequence of steps

- 25 a) applying a coating composition (C), comprising magnetic or magnetizable pigment particles (P) onto a substrate (S);
- b) orienting said magnetic or magnetizable pigment particles (P) according to said first curved surface by applying a first magnetic field;
- 30 c) selectively hardening said applied coating composition (C) in first areas (A₁), hereby fixing the magnetic pigment particles (P) in their positions and orientations;

- d) orienting said magnetic or magnetizable pigment particles (P) in the unhardened part of the coating composition (C) according to said second curved surface by applying a second magnetic field;
- e) hardening said applied coating composition (C) in second areas (A2), hereby fixing the magnetic pigment particles (P) in their positions and orientations.

Producing the coatings (1, 2) in a single operation has the advantage of allowing printing with a single ink composition, to produce said zones in perfect register.

10

In a particular embodiment of the method, the magnetic pigment particles (P, P1) are oriented according to said first curved surface by applying a magnet a first time from the bottom of the substrate, and the magnetic pigment particles (P, P2) are oriented according to said second curved surface by applying a magnet a second time from the top of the substrate, or vice versa, as illustrated in Fig. 5.

15

The device according to the present invention can be used as a security element for the protection of security documents such as banknotes, value documents, passports, identity cards, banking cards, credit cards, access documents or access cards, transportation tickets or cards, tax banderoles, product labels, as well as for commercial goods.

20

Disclosed is also a security document such as a banknote, a value document, a passport, an identity card, a banking card, a credit card, an access document or access card, a transportation ticket or card, a tax banderole, a product label or a commercial good, carrying one or more devices according to the present invention.

25

The invention is now further explained with the help of illustrative figures and worked examples.

30

- Fig. 1a** schematically illustrates a pigment orientation of the prior art, producing a visual “Flip-Flop” effect;
- Fig. 1b** schematically illustrates a pigment orientation of the prior art, producing a visual “Rolling-Bar” effect;
- Fig. 2a, 2b** illustrate for a negatively and a positively curved surface, respectively, how the pigment flakes (1) in the coating layer (2) imitate the curved surface (3) by their orientation in the coating.
- Fig. 3a** schematically depicts a first embodiment of the device of the present invention, having a zone of a second hardened coating (2) contiguously located between two zones of a first hardened coating (1) on a substrate (S). The first and second coatings comprise oriented pigment particles (P) in a transparent binder (M).
- Fig. 3b** schematically depicts a second embodiment of the device of the present invention, having, on a substrate (S), a smaller area of a second hardened coating (2), comprising oriented pigment particles (P₂) in a transparent binder (M₂), applied over a larger area of a first hardened coating (1), comprising oriented pigment particles (P₁) in a transparent binder (M₁) such that said first (1) coating appears contiguously located between two zones of said second (2) coating.
- Fig 3c** schematically depicts a third embodiment of the device of the present invention, wherein said first (1) and said second (2) hardened coatings partially overlap each other.
- Fig. 4** schematically depicts a linear cross-section through a device of the present invention, having a “checkered” structure:

- 5
- 10
- 15
- a) a first embodiment having a plurality of first (1) and second (2) coatings contiguously located between each other on a substrate (S);
 - b) a second embodiment having a plurality of second coatings (2) printed over a first coating (1) on a substrate (S) such that said first (1) and second (2) coatings appear contiguously located between each other;
 - c) a third embodiment having a plurality of first coatings (1) applied to the *recto* side of a flat transparent substrate (S) and a plurality of second coatings (2) applied to the *verso* side of said flat transparent substrate (S) such that said first (1) and second (2) coatings appear contiguously located between each other;
 - d) a fourth embodiment, similar to the embodiment of Fig. 4c, wherein said first (1) and said second (2) coatings partially overlap each other.

20

25

Fig. 5 schematically illustrates the use of a same type of magnet or magnetic field to orient magnetically orientable pigment particles in first (1) and second (2) coatings according to first and second curved surfaces, respectively: (1) application from below the substrate/coating for producing a pigment orientation imitating a negatively curved surface, and (2) application from above the substrate/coating for producing a pigment orientation imitating a positively curved surface.

30

Fig. 6 shows a photographic picture of a device according to the present invention, **a)** in orthogonal (left image) and **b)** in oblique (tilted) view (right image). Upon tilting the device, the “snail” appears to float above the plane of the background.

Fig. 7 schematically depicts a “fractured bar” type device according to the present invention. A zone of a second coating imitating

a second curved surface is contiguously located between two zones of a first coating imitating a first curved surface. Upon tilting the device (up, down), said first and second zones appear to move in different planes in space with respect to each other.

5

a) shows a zone of positive cylindrical curvature located between two zones of negative cylindrical curvature, having their apices aligned such as to form an “undulated” structure;

10

b) shows a zone of negative cylindrical curvature located between two zones of positive cylindrical curvature, having their apices aligned such as to form a “channel” structure;

15

c) shows a zone of positive cylindrical curvature located between two zones of negative cylindrical curvature, having their apices aligned such as to form a “channel” structure

d) illustrates the pigment orientation in a device of the type of Fig. 7 c);

20

e) shows a further extension of the device of the type of Fig. 7a).

Fig. 8

25

schematically illustrates a further embodiment of the device of the present invention, wherein the first and the second coating appear in the form of indicia: a) background layer of negative curvature; b) second, overprinted layer of positive curvature (the hashed parts are printed); c) superposition of background and second layers; d) “double-rolling-bar” effect displayed by the superposition upon tilting: The bright zone of letter “A” moves with the rotational sense of tilting; the bright zone of letter “B” moves against the rotational sense of tilting.

30

Examples

The present invention is further described by reference to non-limiting examples and drawings.

5

Example 1

A first coating (1) is applied in the form of two square zones of 100 mm² each, printed 10 mm apart, as illustrated in **Fig. 7c**, on a sheet of cotton-based paper with a silkscreen UV-drying ink containing platelet-like magnetic optically variable pigment particles as described in example 2a of EP 2 024 451 B1. A magnetic field is used to orient said platelet-like magnetic particles in said two zones, while the ink is still wet. The magnetic field used to orient said particles is generated by a permanent magnet (Strontium ferrite, 10 mm x 10 mm x 40 mm) located 3 mm below the substrate, on the side of the substrate opposite said coating (1), with the axis of polarization of the magnet parallel to the substrate, and perpendicular to an imaginary line joining the centers of each one of said two zones, thus creating a negatively curved reflective surface according to the invention. Once oriented, said two zones reflect light in such a way that their visual aspect resembles two parts of a single shiny solid metallic cylinder. The ink in coating (1) is cured under UV illumination, permanently locking the orientation of the reflective colour-shifting flakes. A second coating (2) is applied to form a third zone of 100 mm² located in between said first two zones using the same ink composition. This second coating, while still wet on the substrate, is subjected to a magnetic field generated by said magnet, located 3 mm above the surface of the substrate, on the same side as the coating (2), thus creating a positively curved reflective surface according to the present invention. With the flake-like pigments oriented, said zone reflects light in such a way that it visually resembles the internal surface of a hollow metallic cylinder. Said second coating is cured under ultraviolet illumination, permanently locking the orientation of the reflective flakes. Example 1 shows a conspicuous visual effect characterized by a downward movement of the reflections emanating

10
15
20
25
30

from the two zones in coating 1 accompanied by a simultaneous upward movement of the reflection emanating from the single zone in coating 2, as the print is tilted backwards. Here tilting backwards means rotating the printed substrate about an axis located in the plane of the substrate, passing through all 3 printed zones, so that the top of the substrate moves away from the observer whilst the bottom of the substrate moves toward the observer.

Example 2

10 A first coating (1) is applied in the form of two square zones of 100 mm² each, printed 10 mm apart, as illustrated in **Fig. 7e**, on a sheet of transparent polymer substrate with a silkscreen UV-drying ink containing platelet-like magnetic optically variable pigment particles as described in example 3 of EP 2 024 451 B1. A magnetic field is used to orient said

15 platelet-like magnetic particles in said two zones, while the ink is still wet. The magnetic field used to orient said particles is generated by two permanent magnets (Strontium ferrite, 10 mm x 12 mm x 24 mm), 20 mm apart from each other, located 3 mm below the substrate, i.e. on the side of the substrate opposite the coating (1), with the axis of polarization of each

20 magnet parallel to the substrate, and parallel to an imaginary line joining the centers of each one of said two zones, thus creating negatively curved reflective surfaces according to the invention when observed from the side printed with coating (1). Hence, with the flake-like pigments oriented, each of said two zones reflects light in such a way that its visual aspect resembles

25 part of a shiny solid metallic cylinder. The ink in coating 1 is cured under UV irradiation, permanently locking the orientation of the reflective colour-shifting flakes. A second coating (2) is applied on the opposite side of the substrate relative to the first coating, to form a second set of two zones of 100 mm² located above and below one of said first two zones, as

30 depicted in **Fig. 7e**, using the same ink composition. This second coating, while still wet on the substrate, is subjected to a magnetic field generated by said set of two magnets, positioned 3 mm below the surface of the substrate, on the side opposite the coating (2), thus creating positively

curved reflective surfaces according to the present invention when observed from the side printed with coating (1). Once oriented, said zones reflect light in such a way that each zone visually resembles the internal surface of a hollow metallic cylinder. Said second coating (2) is cured under
5 ultraviolet irradiation, permanently locking the orientation of the reflective flakes. When observed from the side printed with coating (1), example 2 shows a conspicuous visual effect characterized by a downward movement of the reflections emanating from the two zones in coating (1) accompanied by a simultaneous upward movement of the reflection emanating from the
10 two zones in coating (2), as the print is tilted backwards. Here tilting backwards means rotating the printed substrate about an axis located in the plane of the substrate, passing through the center of the printed surface and perpendicular to the imaginary line connecting the center of the four printed zones, so that the top of the substrate moves away from the
15 observer whilst the bottom of the substrate moves toward the observer. When observed from the side printed with coating (2), the apparent motion of each bright reflection is reversed.

Example 3

20 Example three, shown in **Fig. 6**, comprises two areas printed with an ink composition containing orientable reflective flakes. A first coating (1) is applied in the form a solid circular area with a diameter of 29 mm, printed, on a sheet of cotton-based paper with a silkscreen UV-drying ink containing platelet-like magnetic optically variable pigment particles as described in
25 example 2a of EP 2 024 451 B1. A spatially periodic magnetic field is used to orient said platelet-like magnetic particles in said area, while the ink is still wet. The magnetic field used to orient said particles is generated by a flat multipolar magnetic device located 1.5 mm above the substrate, thus creating a positively curved reflective surface according to the invention.
30 With the constituent magnetic pigment thus oriented, said zone reflects light in such a way that it resembles the surface of a shiny corrugated iron sheet. The ink in coating (1) is cured under UV illumination, permanently locking the orientation of the reflective colour-shifting flakes. A second

coating (2) is applied using the same ink composition to cover an area located essentially within said first circular area, forming a broad spiral shape. Applying coating (2) in said shape has the effect of creating a plurality of zones within coating (1) and coating (2). Said second coating, while still wet on top of the cured coating (1), is subjected to a periodic magnetic field generated by said magnetic device, located 1.5 mm below the surface of the substrate, on the same side as coating (2), thus creating a negatively curved reflective surface according to the present invention. With the constituent magnetic pigment thus oriented, said second zone reflects light in such a way that it resembles the surface of a shiny corrugated iron sheet. Said second coating is cured under ultraviolet illumination, permanently locking the orientation of the reflective flakes. Example 3 shows a conspicuous visual effect characterized by a downward movement of the reflections emanating from all zones in coating (1) accompanied by a simultaneous upward movement of the reflection emanating from all zones in coating (2), as the print is tilted backwards.

Claims

1. Device comprising a substrate (S), and on said substrate (S) a plurality
5 of jointly visible zones of first (1) and of second (2) hardened coatings
comprising oriented pigment particles (P1, P2) in a transparent binder
(M1, M2), said first (1) hardened coating having a pigment orientation
imitating a first curved surface and said second (2) hardened coating
10 having a pigment orientation imitating a second curved surface
different from said first curved surface, **characterized in that**, along
a linear section through the device, at least one zone of said second (2)
hardened coating is contiguously located between two zones of said
first (1) hardened coating.
- 15 2. Device according to claim 1, wherein, along a linear section through the
device, additionally at least one of said two zones of said first (1)
hardened coating is contiguously located within two zones of said
second (2) hardened coating.
- 20 3. Device according to one of claims 1 or 2, wherein said first and said
second curved surfaces are different from each other in at least one of
the following properties: i) the sign of curvature, which may be positive,
towards the observer, or negative, away from the observer; ii) the
amount of curvature, which may be high or low; iii) the direction or
25 axis of curvature; iv) the nature of curvature which may in particular be
cylindrical, conical, elliptical, spherical or saddle-shaped.
4. Device according to one of claims 1 to 3, wherein said first and said
30 second coatings are disposed either aside each other and/or on top of
each other.
5. Device according to one of claims 1 to 4, wherein said substrate is
selected from the group consisting of the paper substrates, the opaque

or opacified polymer substrates, the transparent polymer substrates and the metallic substrates.

- 5 6. Device according to one of claims 1 to 5, wherein said first (1) and said second (2) hardened coatings are disposed on the *recto* and on the *verso* side, respectively, of a transparent substrate.
- 10 7. Device according to one of claims 1 to 6, comprising a combination of said first and said second coatings with at least one further coating, comprising oriented pigment particles.
- 15 8. Device according to one of claims 1 to 7, wherein said first and/or said second hardened coating is present in the form of indicia selected from the group consisting of the simple geometric figures or patterns, the letters, the texts, the logos and the images.
- 20 9. Device according to one of claims 1 to 8, wherein said oriented pigment particle in said first and/or said second hardened coating is a magnetic pigment particle, comprising a permanent-magnetic or a magnetizable material of the ferromagnetic or ferrimagnetic type.
- 25 10. Device according to one of claims 1 to 9, wherein said oriented pigment particle in said first and/or said second hardened coating is selected from the group comprising the flake-shaped vacuum-deposited magnetic thin-film interference pigment particles.
- 30 11. Device according to one of claims 1 to 10, wherein said oriented pigment particle (P) in said first and/or said second hardened coating is an optically variable magnetic pigment particle.
12. Device according to one of claims 1 to 11, wherein said first and/or said second hardened coating additionally comprises at least one further color-shifting pigment selected from the group consisting of the

vacuum-deposited optically variable thin-film interference pigments having an all-dielectric or a metal-dielectric interference design, the coated metal-core particles, the coated dielectric particles, the cholesteric liquid crystal polymer pigments, the embossed holographic pigments, and the mixtures thereof.

5

13. Device according to one of claims 1 to 12, wherein said first and/or said second hardened coating additionally comprises a dye and/or at least one further, non-color-shifting pigment.

10

14. Device according to one of claims 1 to 13, wherein the device comprises a combination of areas coated with a composition comprising optically variable pigment and areas coated with a composition not comprising optically variable pigment.

15

15. Method for producing the device of one of claims 1 to 14, **comprising the step of** applying to a substrate (S) a plurality of areas of first (C1) and of second (C2) coating compositions comprising pigment particles (P1, P2) in a transparent binder (M1, M2), orienting the pigment particles (P1) in said applied first (C1) coating composition such as to imitate a first curved surface, orienting the pigment particles (P2) in said applied second (C2) coating composition such as to imitate a second curved surface different from said first curved surface, and hardening said first and said second coating compositions to obtain first and second hardened coatings (1, 2) having the oriented particles fixed in their respective positions and orientations **wherein** said areas of first (C1) and of second (C2) coating compositions are applied such that, along a linear section through the device, at least one zone of said second (2) hardened coating is contiguously located between two zones of said first (1) hardened coating.

20

25

30

16. Method according to claim 15, wherein said areas of first (C1) and of second (C2) coating compositions are applied such that additionally at least one of said two zones of said first (1) hardened coating is contiguously located within two zones of said second (2) hardened coating.
17. Method according to one of claims 15 to 16, wherein said first and said second curved surfaces are different from each other in at least one of the following properties: i) the sign of curvature, which may be positive, towards the observer, or negative, away from the observer; ii) the amount of curvature, which may be high or low; iii) the direction or axis of curvature; iv) the nature of curvature which may in particular be cylindrical, conical, elliptical, spherical or saddle-shaped.
18. Method according to one of claims 15 to 17, wherein said substrate (S) is selected from the group consisting of the paper substrates, the opaque or opacified polymer substrates, the transparent polymer substrates and the metallic substrates.
19. Method according to one of claims 15 to 18, wherein said first and said second coatings are applied by a printing process chosen from silkscreen printing, flexographic printing and gravure printing, using a corresponding coating composition.
20. Method according to one of claims 15 to 19, wherein the coating composition is formulated for and hardened by radiation curing, selected from UV-curing and electron-beam curing.
21. Method according to one of claims 15 to 20, wherein said first and said second coating compositions (C1, C2) are applied to the *recto* and to the *verso* side, respectively, of a transparent substrate (S).

22. Method according to one of claims 15 to 21, wherein said pigment particles (P1, P2) in said first and said second coating compositions (C1, C2) are magnetic pigment particles, comprising a permanent-magnetic or a magnetizable material of the ferromagnetic or ferrimagnetic type, and wherein said orienting the pigment particles (P1, P2) in said applied first and second coating compositions (C1, C2) is performed by applying magnetic fields.
23. Method according to one of claims 15 to 22, wherein said pigment particles (P1, P2) in said first and/or said second coating compositions (C1, C2) are selected from the group comprising the flake-shaped vacuum-deposited magnetic thin-film interference pigment particles.
24. Method according to one of claims 15 to 23, wherein said pigment particles (P1, P2) in said first and/or said second coating compositions (C1, C2) are optically variable magnetic pigment particles.
25. Method according to one of claims 15 to 24, wherein the first hardened coating (1) is produced, i.e. applied, oriented, and hardened, subsequent to the second hardened coating (2), or vice versa.
26. Method according to one of claims 15 to 25, wherein said first and said second coatings are applied either aside each other and/or on top of each other.
27. Method according to one of claims 15 to 24, wherein the first hardened coating (1) and the second hardened coating (2) are produced in a single operation through the following sequence of steps
- a) applying a coating composition (C), comprising magnetic or magnetizable pigment particles (P) onto a substrate (S);
 - b) orienting said magnetic or magnetizable pigment particles (P) according to said first curved surface by applying a first magnetic field;

- c) selectively hardening said applied coating composition (C) in first areas (A1), hereby fixing the magnetic pigment particles (P) in their positions and orientations;
- d) orienting said magnetic or magnetizable pigment particles (P) in the unhardened part of the coating composition (C) according to said second curved surface by applying a second magnetic field;
- e) hardening said applied coating composition (C) in second areas (A2), hereby fixing the magnetic pigment particles (P) in their positions and orientations.
- 10
28. Method according to one of claims 15 to 27, wherein the steps of applying, orienting, and hardening a coating composition comprising pigment particles (P) in a transparent binder (M) are repeated to produce further coatings on said substrate (S) and/or said coatings (1, 15 2).
29. Method according to one of claims 15 to 28, wherein the magnetic pigment particles (P, P1) are oriented according to said first curved surface by applying a magnet from the bottom of the substrate, and the 20 magnetic pigment particles (P, P2) are oriented according to said second curved surface by applying a magnet from the top of the substrate, or vice versa.
30. Use of a device according to one of claims 1 to 14 for the protection of a 25 commercial good or of a security document selected from the group consisting of the banknotes, value documents, passports, identity cards, banking cards, credit cards, access documents or cards, transportation tickets or cards, tax banderoles, and product labels
- 30 31. Article selected from the commercial goods and the group of security document consisting of the banknotes, value documents, passports, identity cards, banking cards, credit cards, access documents or cards, transportation tickets or

cards, tax banderoles, and product labels, characterized in that the article carries one or more devices according to one of claims 1 to 14.

Figure 1a

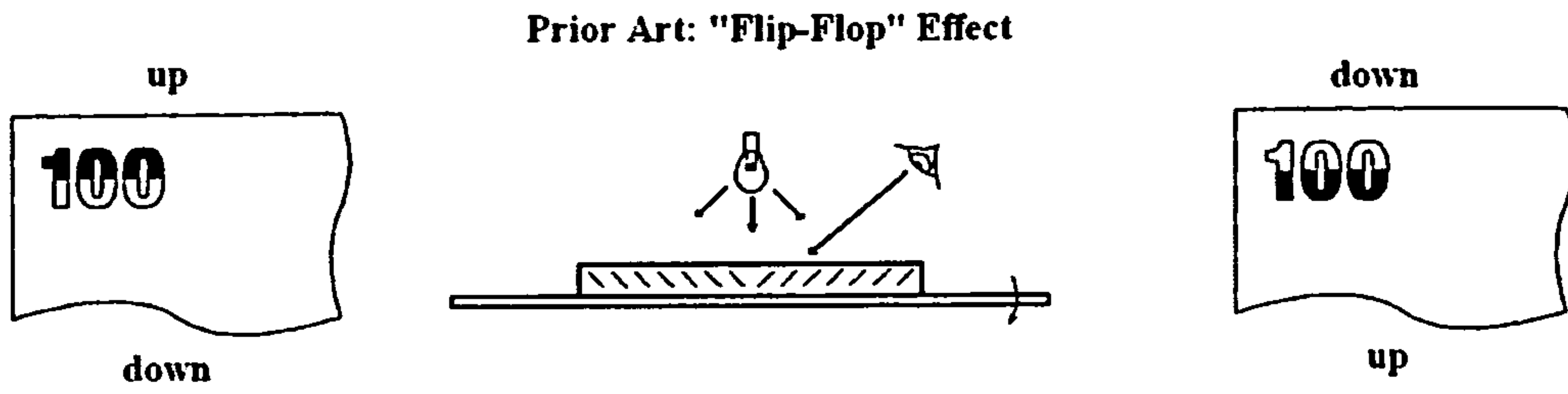

5 **Figure 1b**

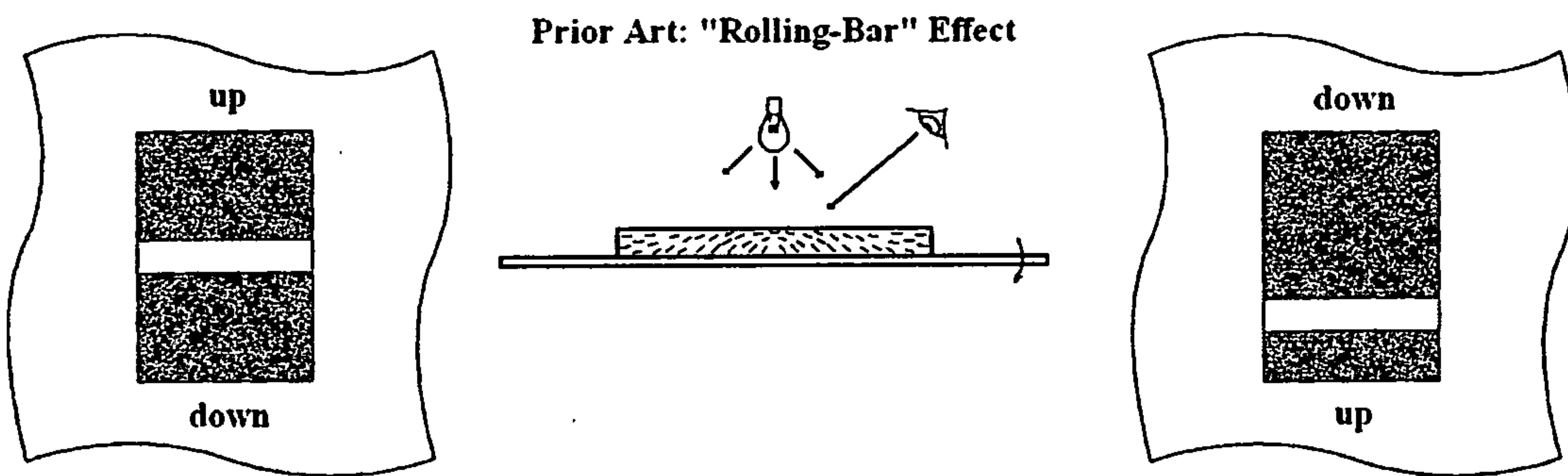

Figure 2a

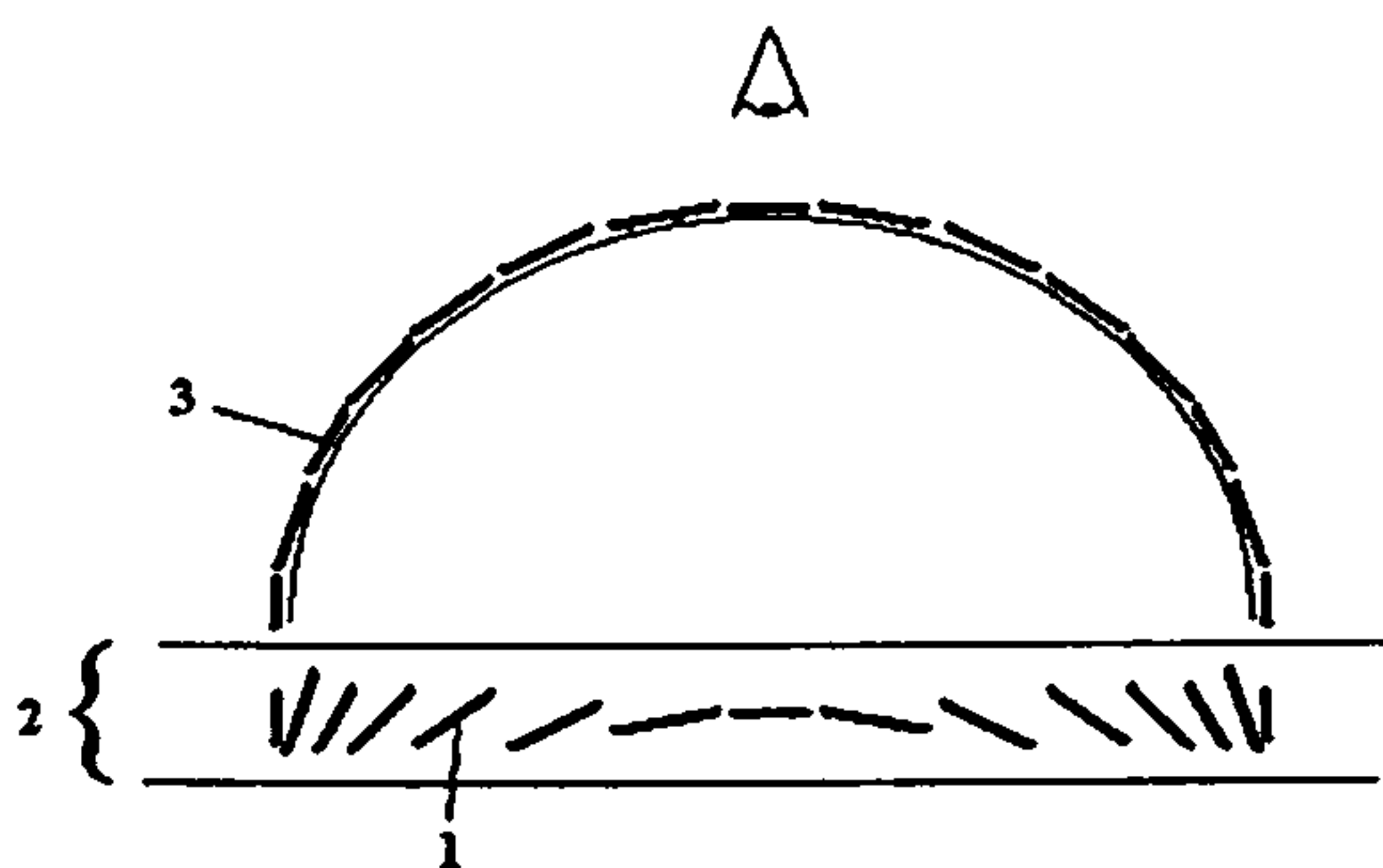

Figure 2b

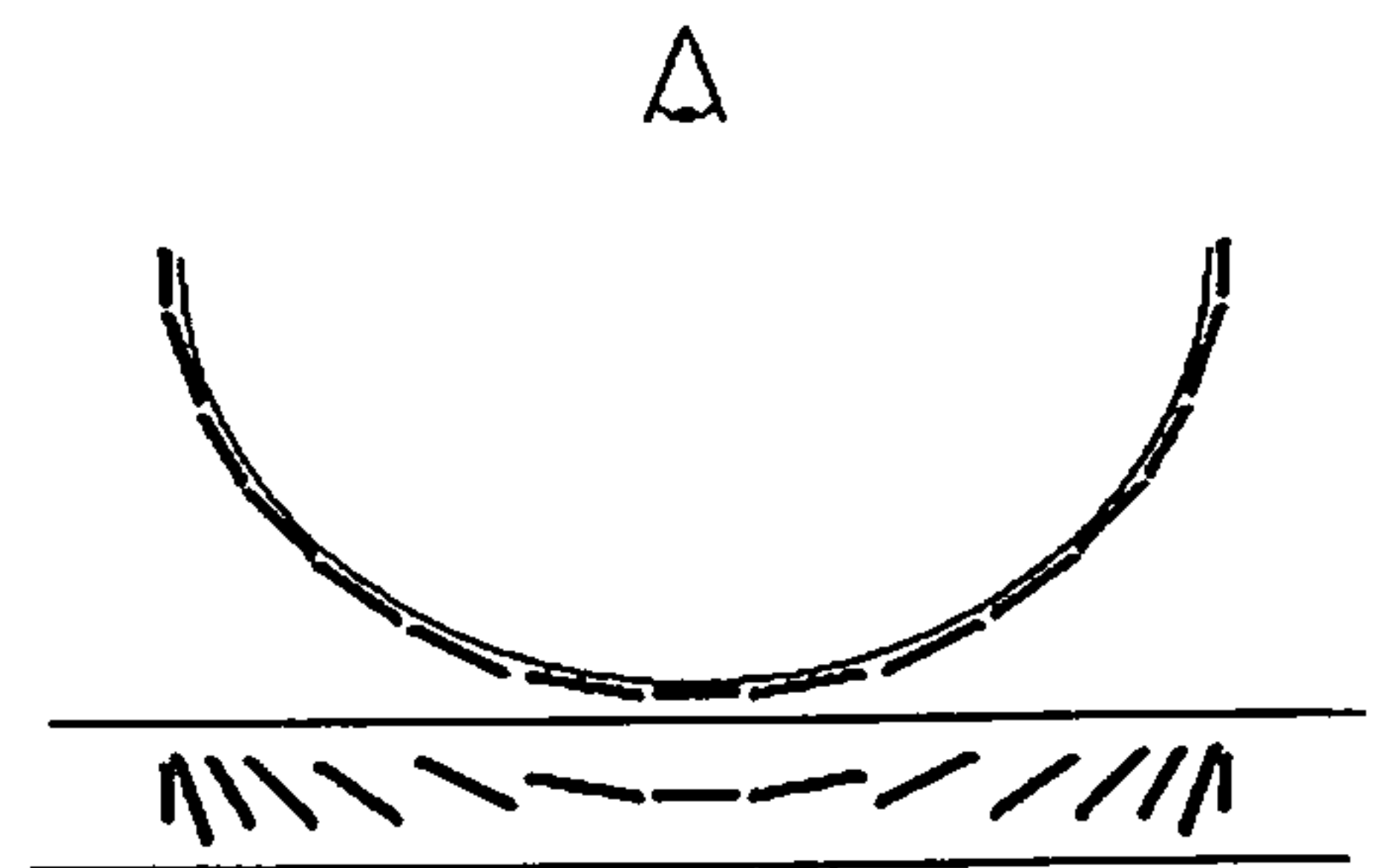

Fig. 4

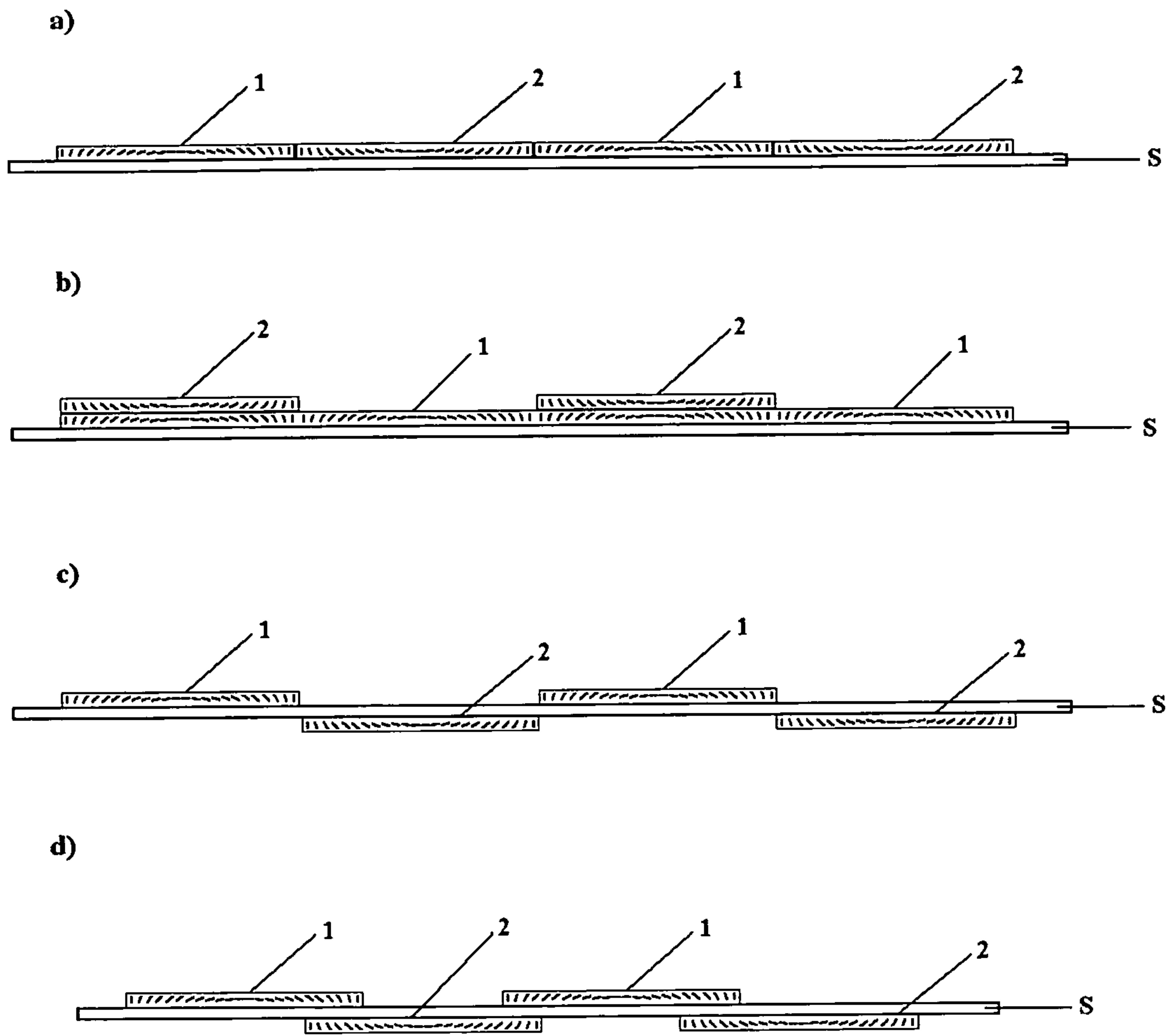

Fig. 5

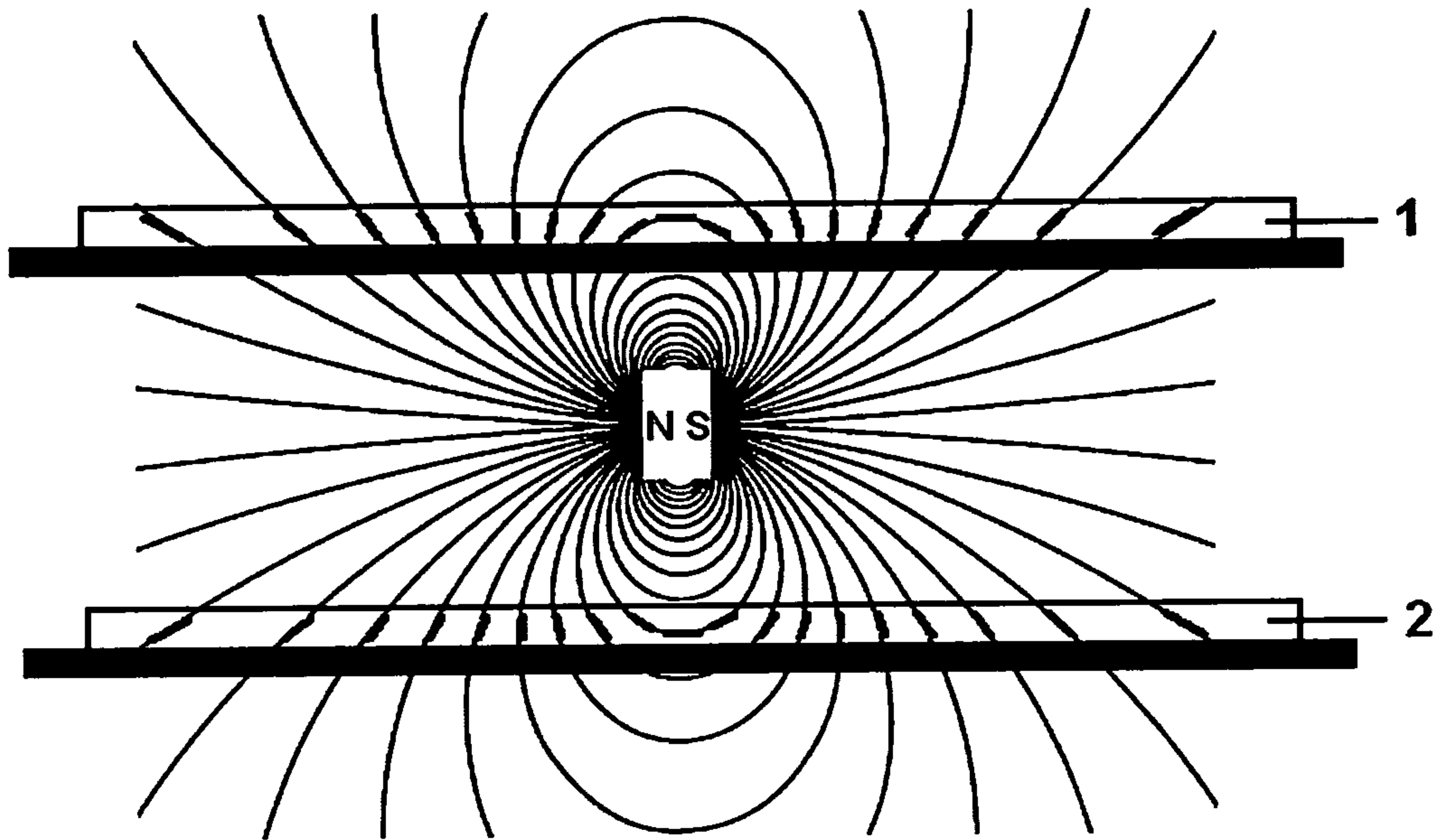

Figure 6

a)

b)

5

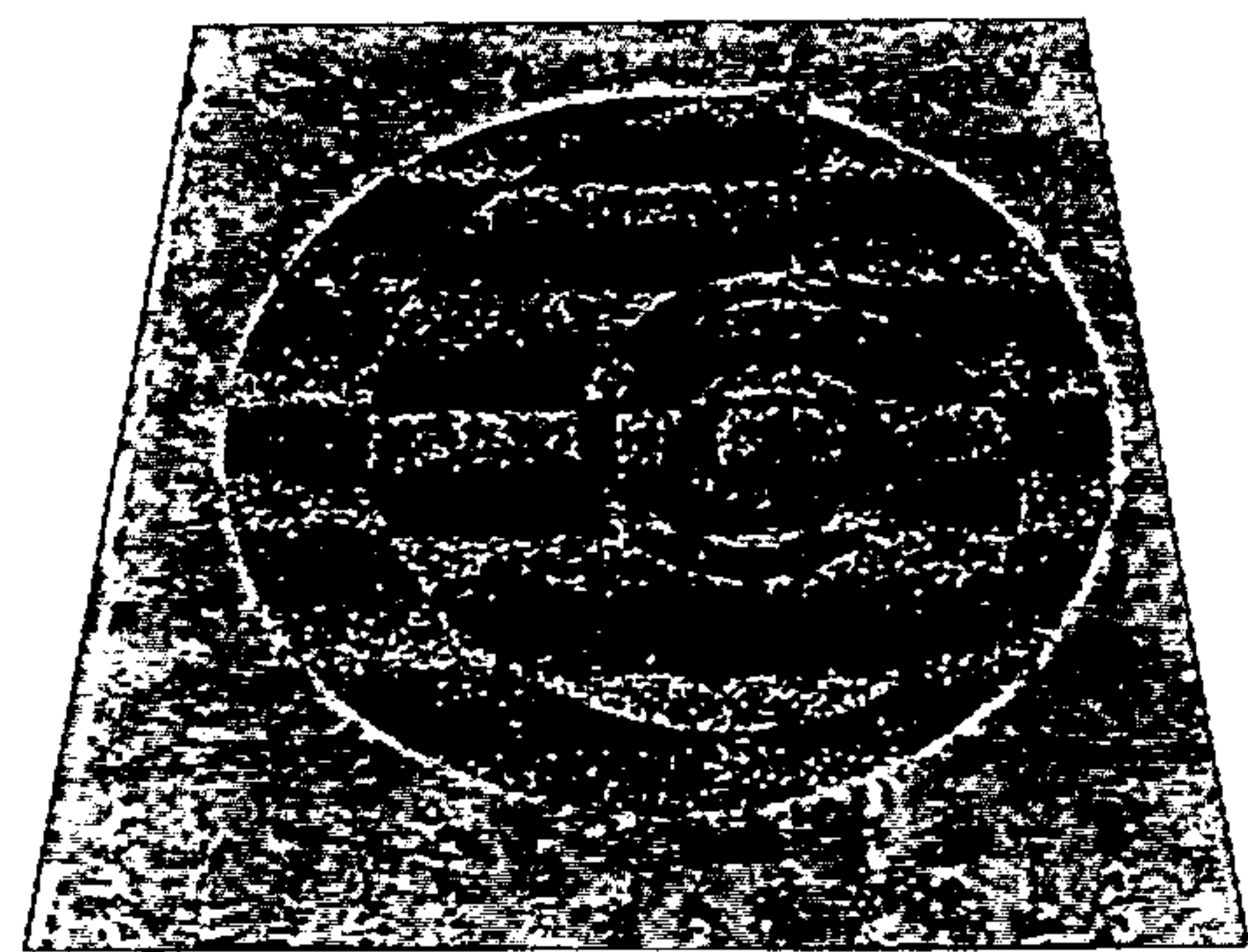
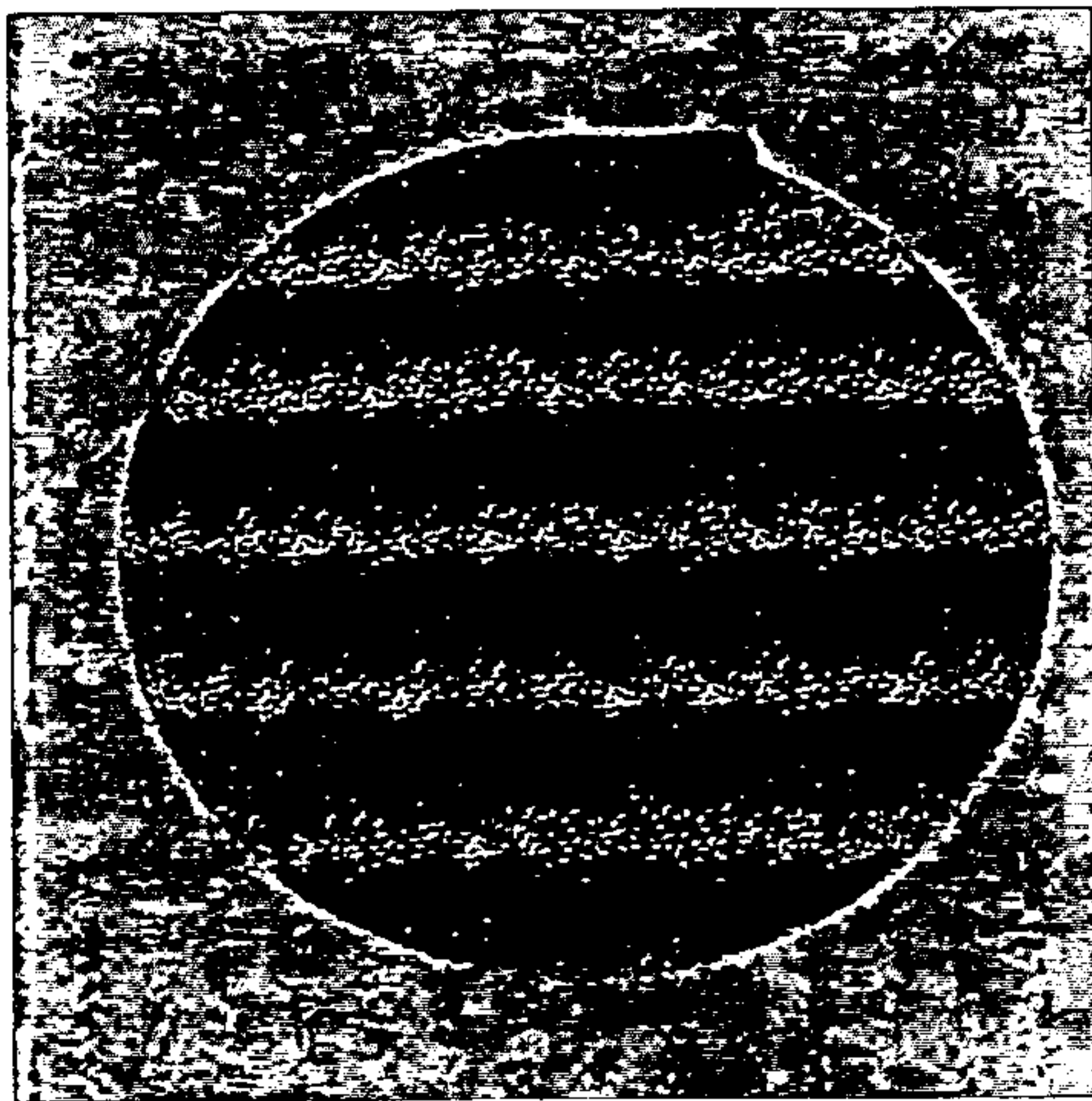
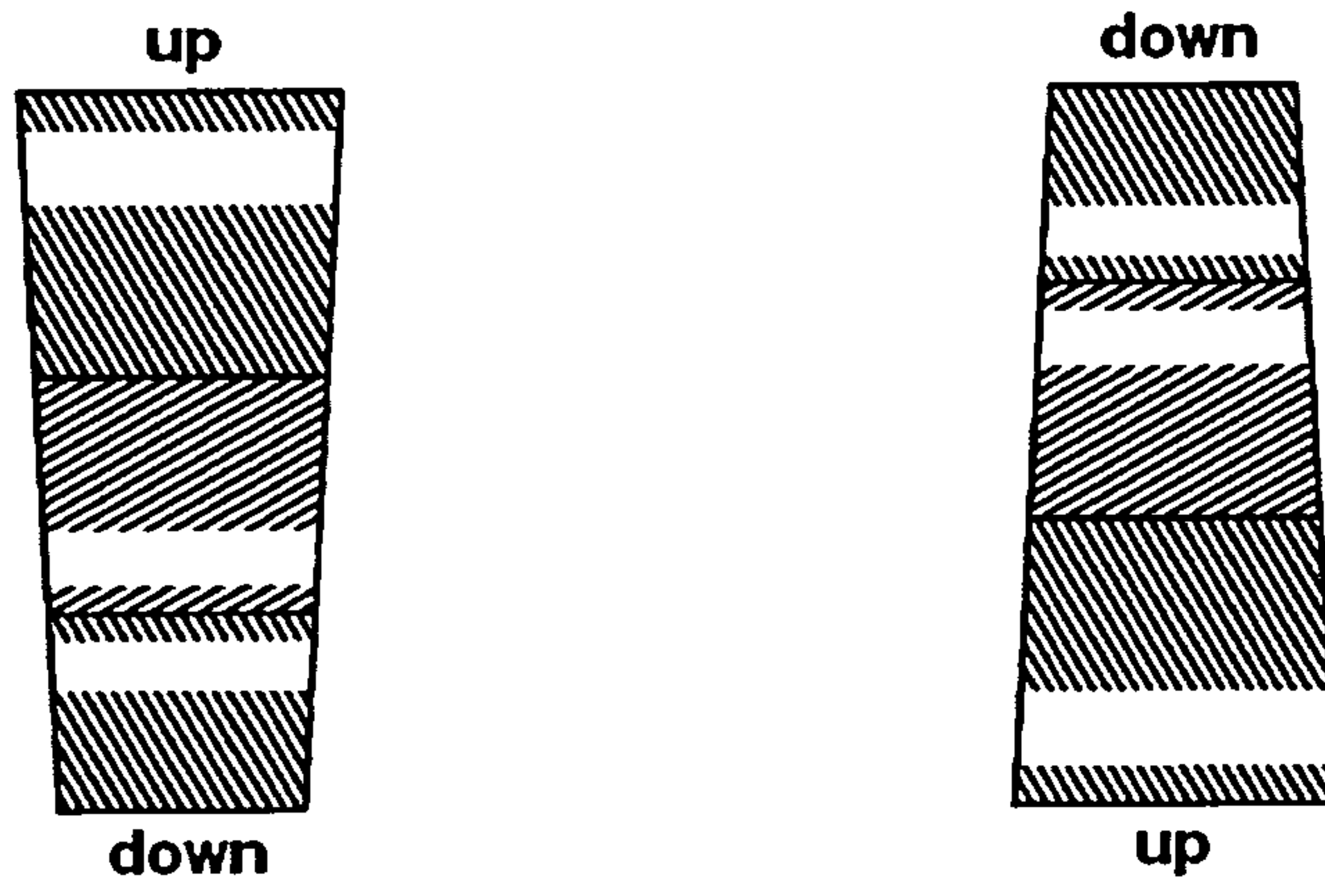
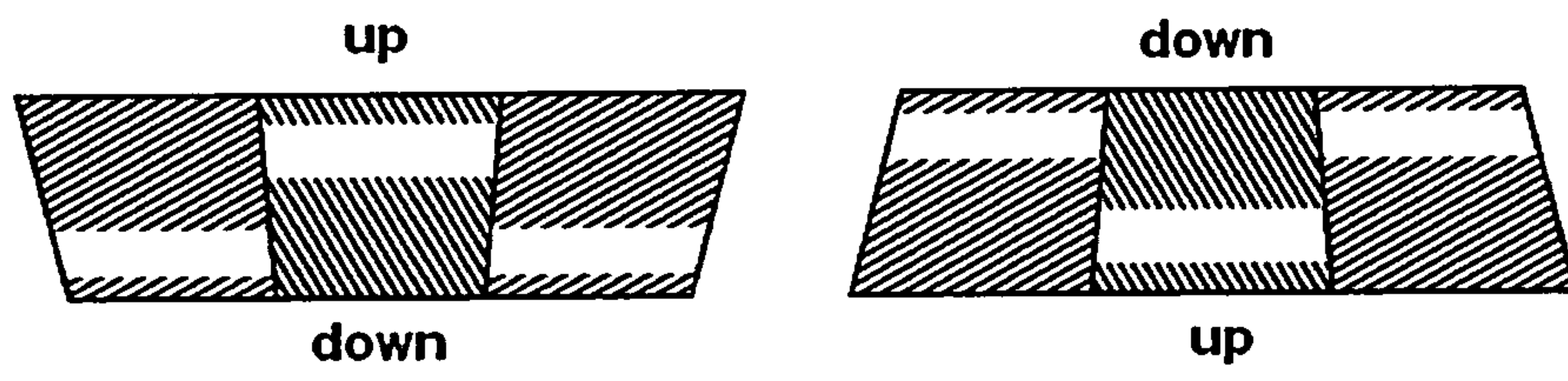

Fig. 7

a)



b)



5

c)

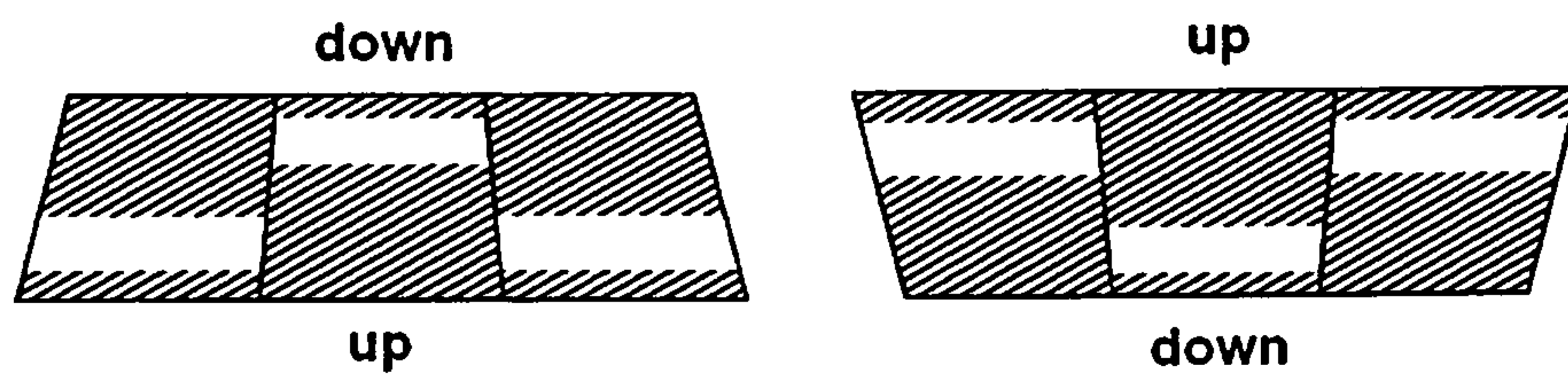

d)

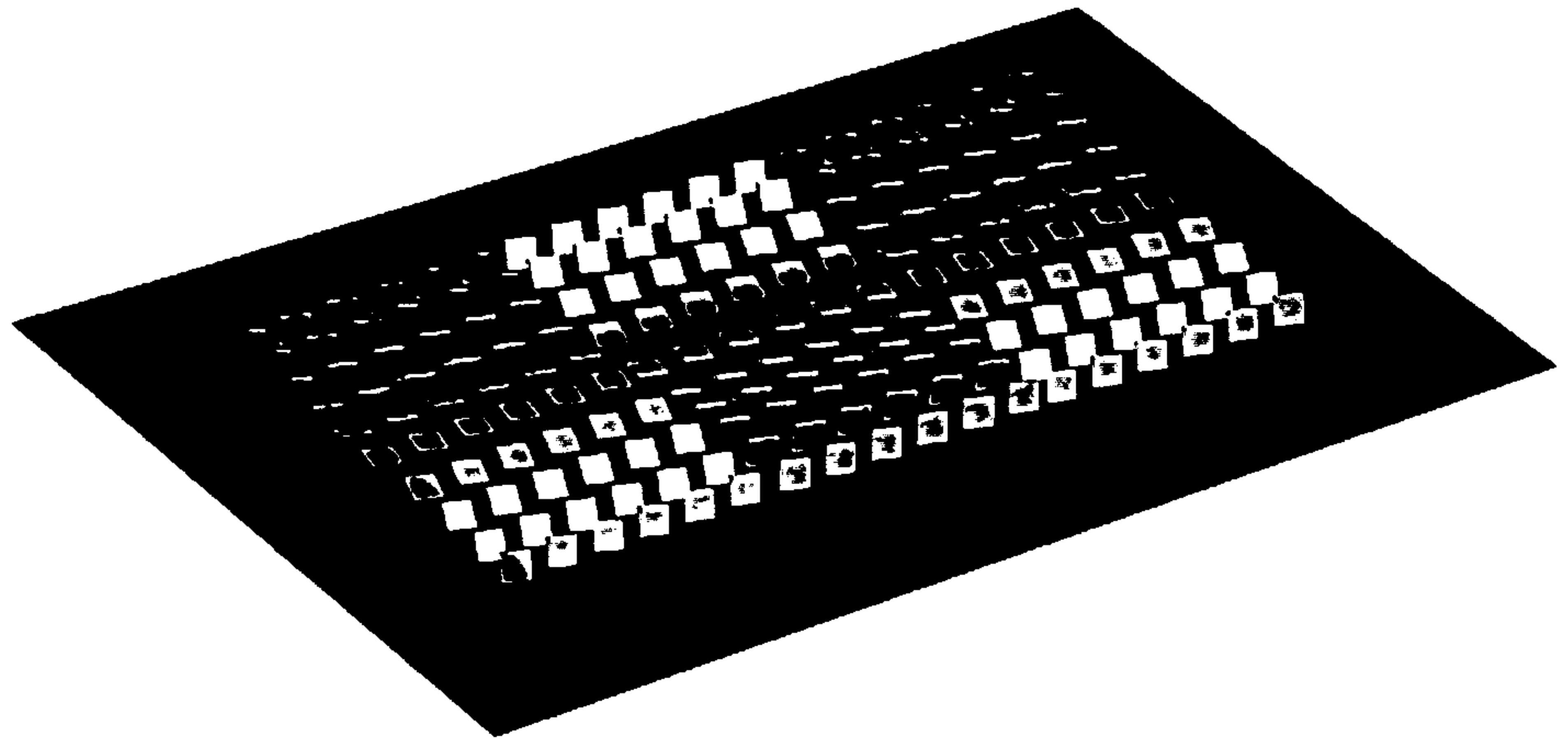

e)

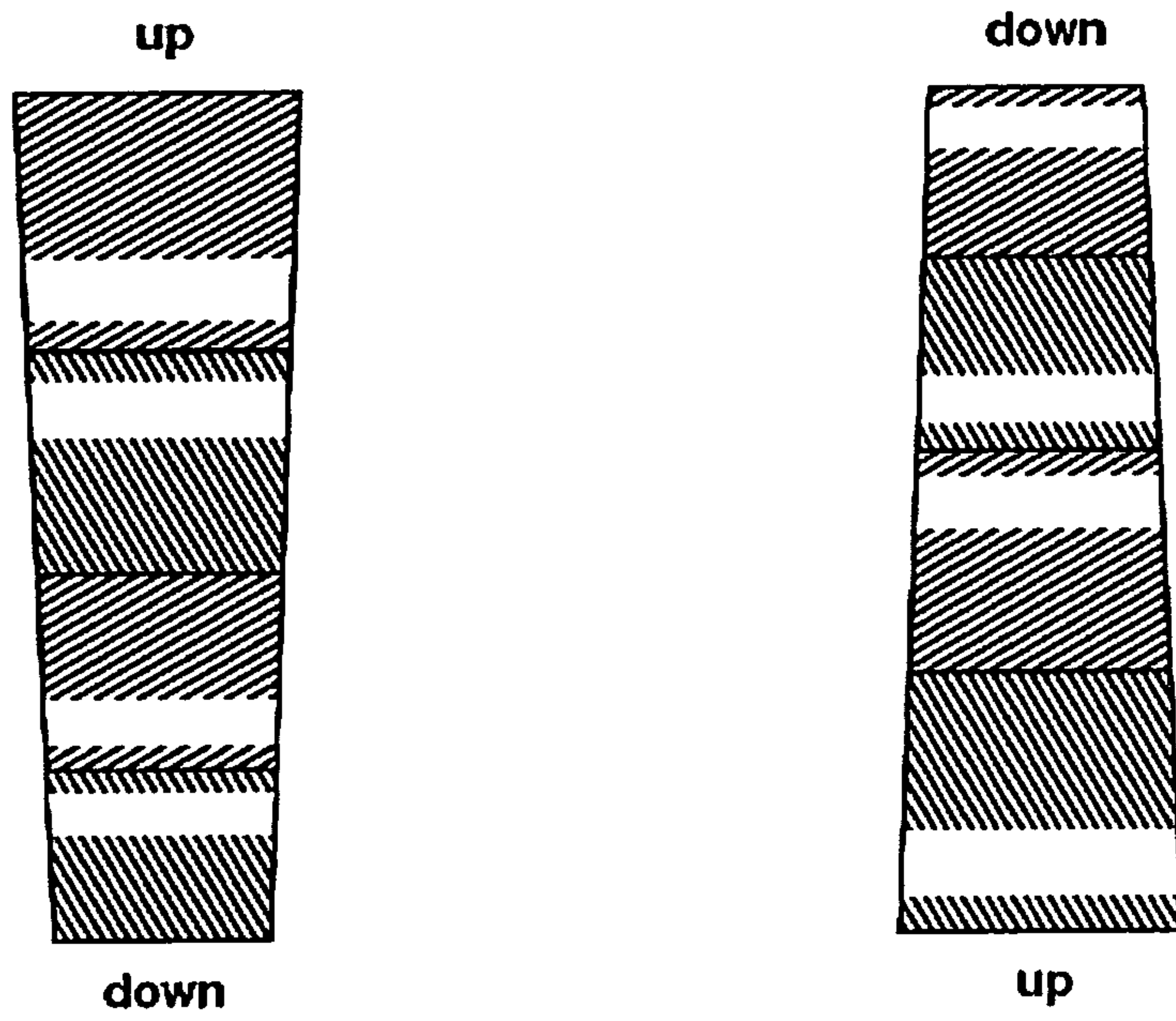

Fig. 8

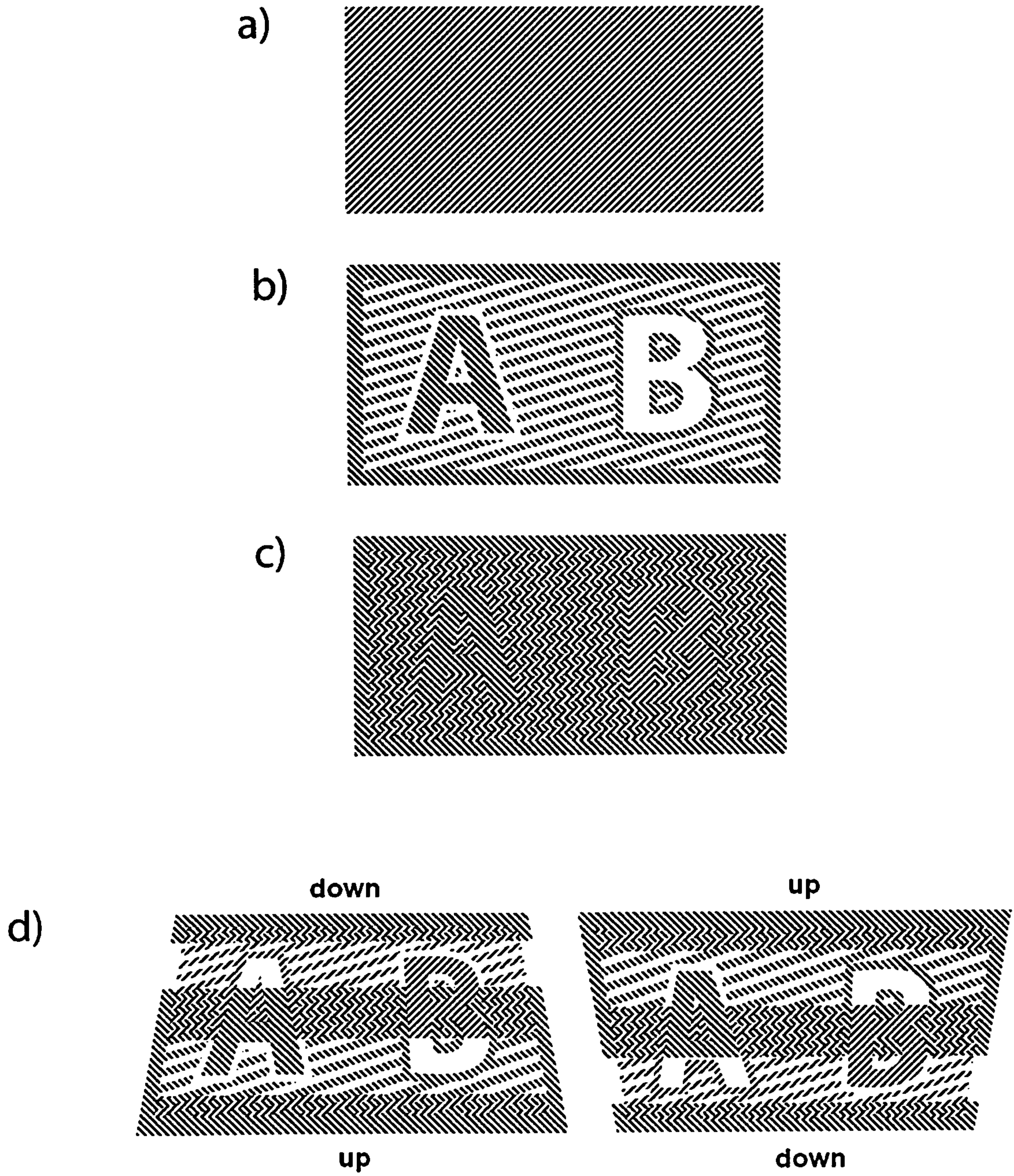
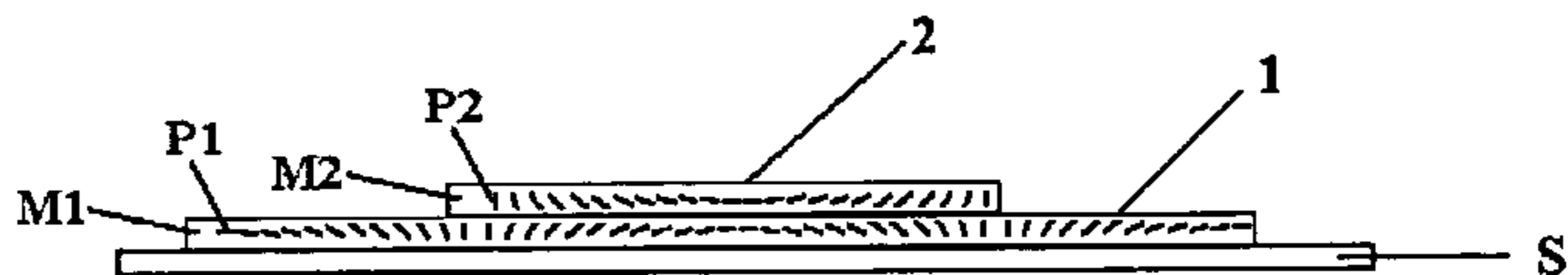

Fig. 3

a)



b)



c)

