



US0D1027792S

(12) **United States Design Patent**
Johnson

(10) **Patent No.:** **US D1,027,792 S**

(45) **Date of Patent:** **** May 21, 2024**

(54) **SPARE TIRE TOOL STORAGE ORGANIZER**

2012/0080434 A1* 4/2012 Chen B60K 15/0409
220/326

(71) Applicant: **Troy Johnson**, Rancho Cucamonga, CA
(US)

2012/0325814 A1* 12/2012 Crowley B60K 15/0406
220/212.5

(72) Inventor: **Troy Johnson**, Rancho Cucamonga, CA
(US)

2021/0371174 A1* 12/2021 Kaminski F17C 13/06

* cited by examiner

(**) Term: **15 Years**

Primary Examiner — Katrina A Betton

(21) Appl. No.: **29/743,554**

(57) **CLAIM**

The ornamental design for a spare tire tool storage organizer,
as shown and described.

(22) Filed: **Jul. 22, 2020**

DESCRIPTION

(51) **LOC (14) Cl.** **12-16**

FIG. 1 is an exploded top perspective view of a spare tire
tool storage organizer, showing my new design;

(52) **U.S. Cl.**

FIG. 2 is a bottom view thereof;

USPC **D12/400**

FIG. 3 is a front elevation view thereof;

(58) **Field of Classification Search**

USPC D12/400, 425, 416, 406

FIG. 4 is a left side elevation view, the right-side elevation
view being a mirror image thereof;

CPC B62D 43/00

See application file for complete search history.

FIG. 5 is a bottom sectional view taken along lines 5-5 from
FIG. 4 thereof;

(56) **References Cited**

U.S. PATENT DOCUMENTS

5,118,017	A	6/1992	Buck	
5,429,285	A	7/1995	Kim	
D377,470	S	1/1997	Santangelo	
D422,255	S *	4/2000	Gonzales	D12/197
D487,656	S	3/2004	Sturhan et al.	
D488,397	S *	4/2004	Morelock	D10/68
D500,275	S *	12/2004	Martinez	D12/197
7,036,697	B2	5/2006	Hwang et al.	
D594,395	S *	6/2009	Yoshii	D12/197
D678,174	S	3/2013	Wass et al.	
D806,544	S *	1/2018	Williams	D12/197
D816,005	S *	4/2018	Johns	D12/197
D906,811	S *	1/2021	Mandell	D9/453
D934,144	S *	10/2021	Chen	D12/197
D980,068	S *	3/2023	Meilhac	D9/452
D1,005,203	S *	11/2023	Zhang	D12/197

FIG. 6 is a bottom sectional view taken along lines 6-6 from
FIG. 4 thereof;

FIG. 7 is a bottom sectional view taken along lines 7-7 from
FIG. 4 thereof;

FIG. 8 is a bottom sectional view taken along lines 8-8 from
FIG. 4 thereof;

FIG. 9 is a bottom sectional view taken along lines 9-9 from
FIG. 4 thereof;

FIG. 10 is a top plan view thereof;

FIG. 11 is a left side sectional view taken along lines 11-11
from FIG. 10 thereof;

FIG. 12 is a rear elevation sectional view taken along lines
12-12 from FIG. 10 thereof;

FIG. 13 is a top perspective view thereof; and,

FIG. 14 is a bottom perspective view thereof.

1 Claim, 7 Drawing Sheets

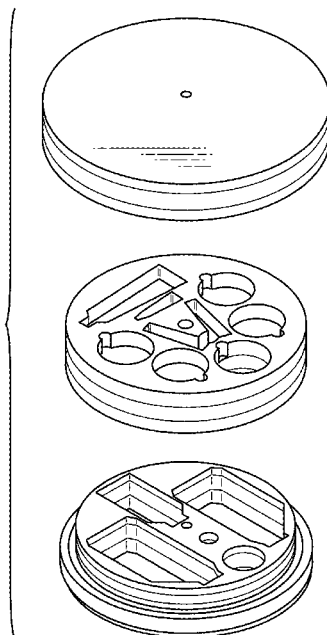

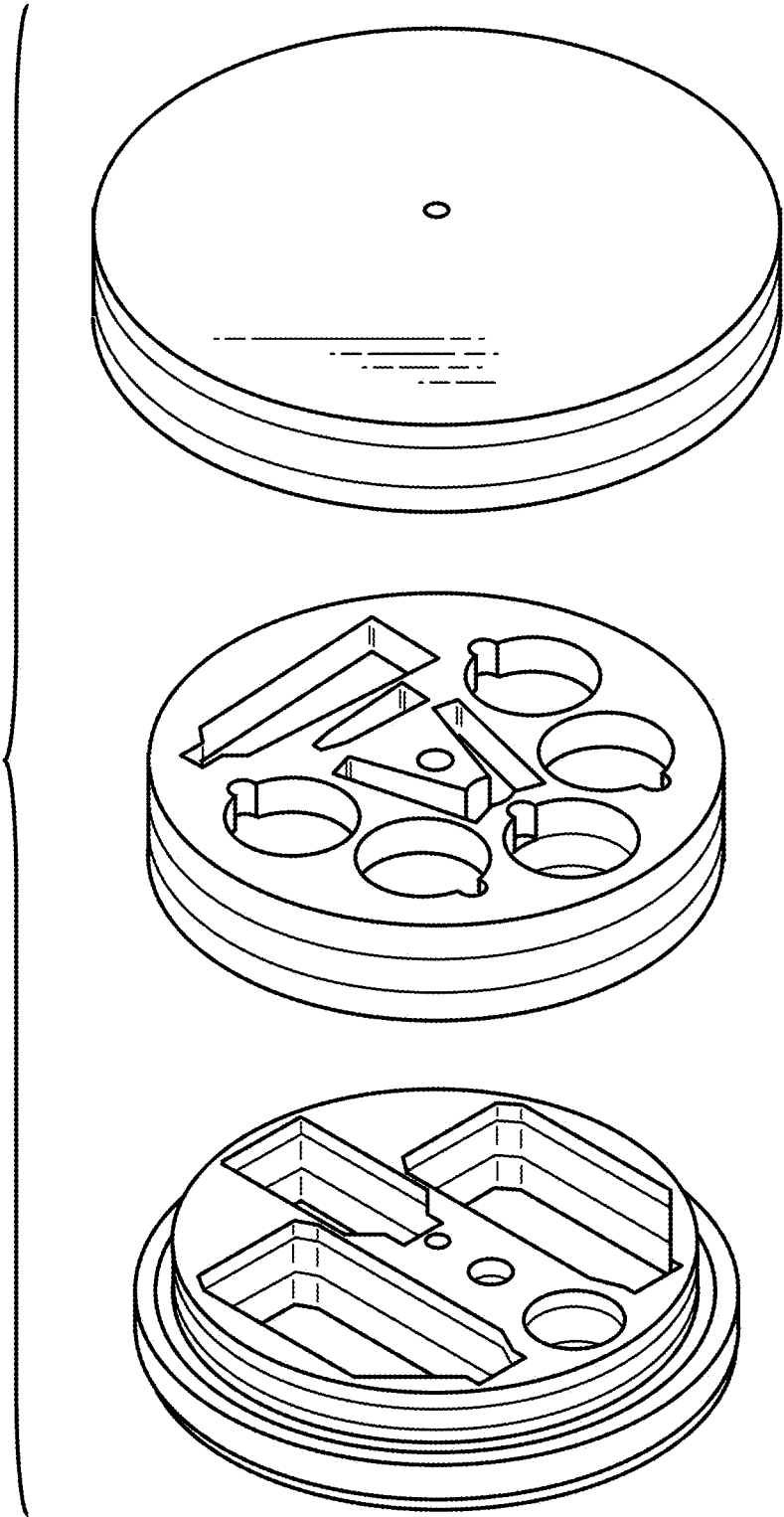

FIG. 1

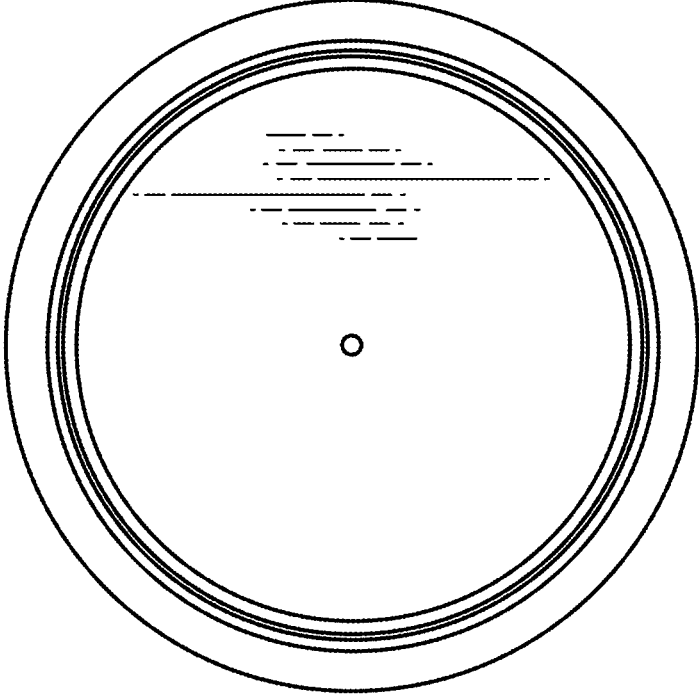

FIG. 2

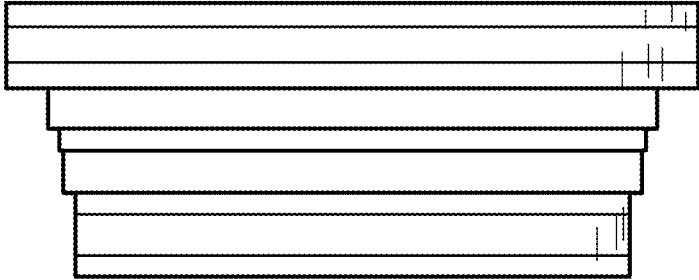

FIG. 3

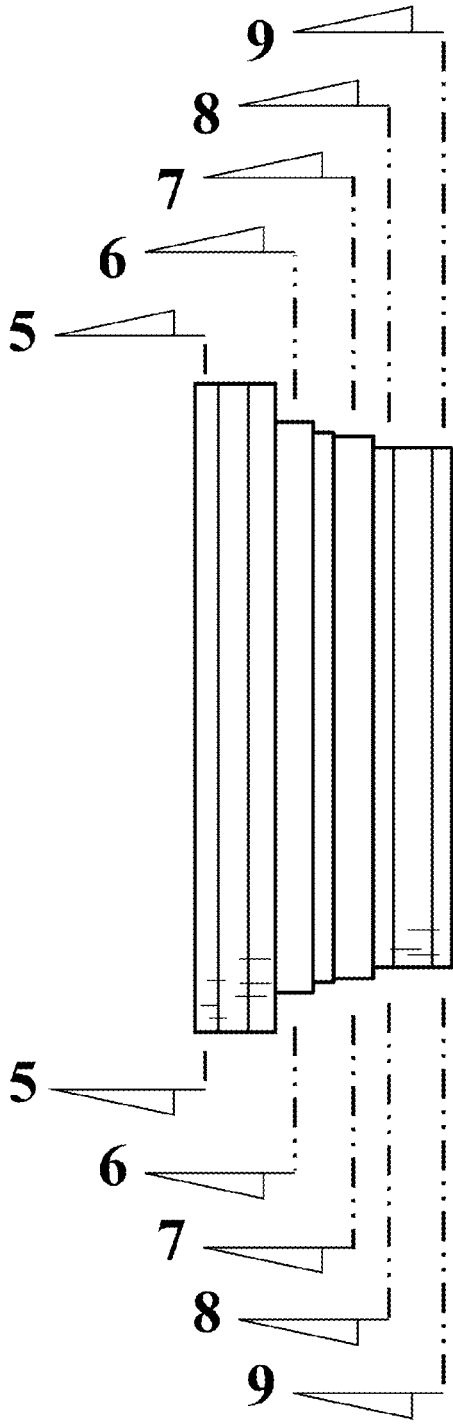

FIG. 4

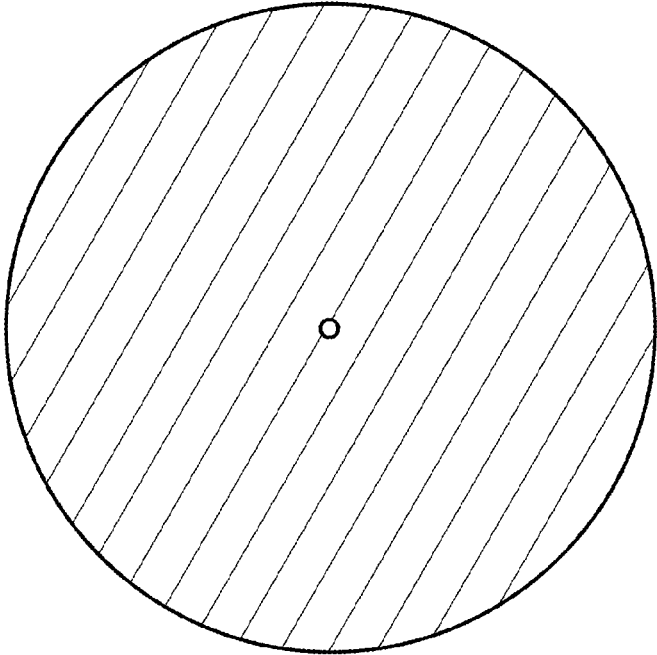

FIG. 5

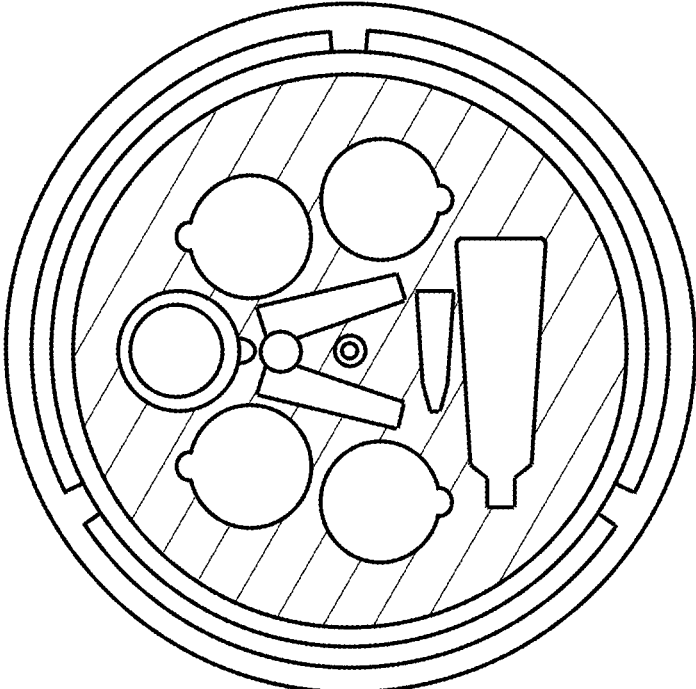

FIG. 6

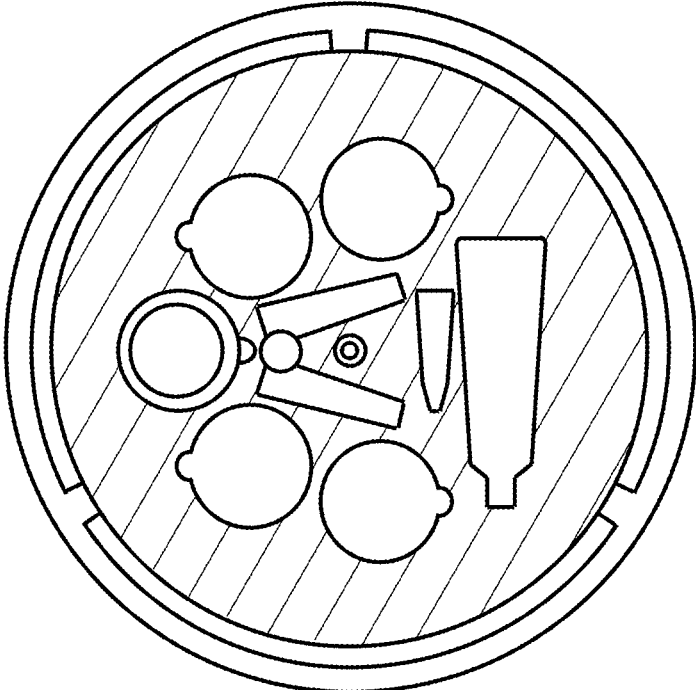

FIG. 7

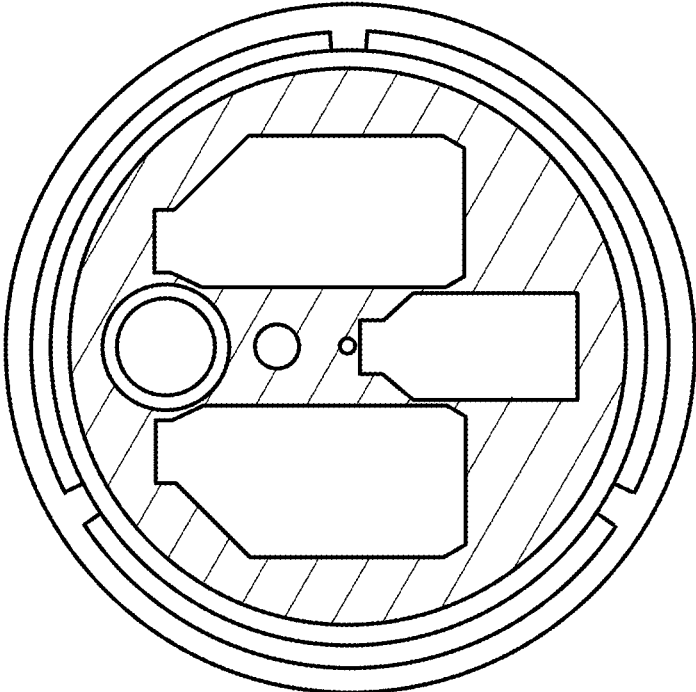

FIG. 8

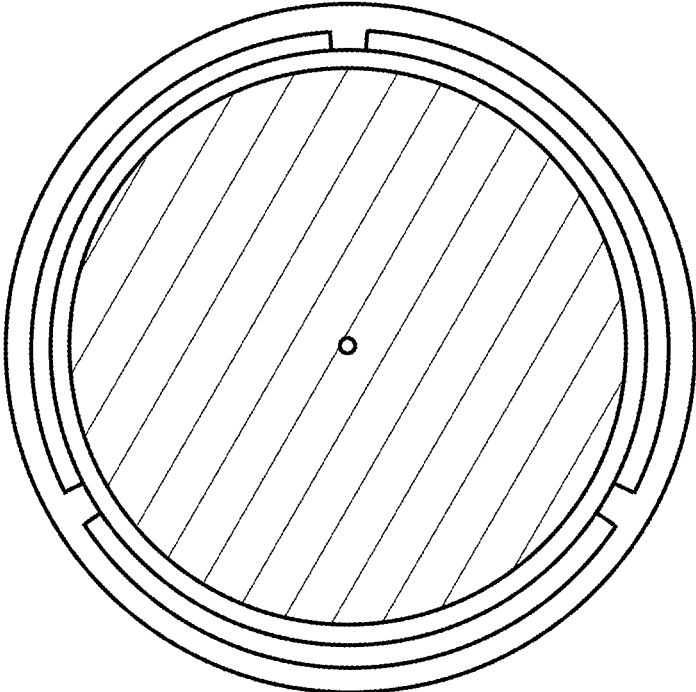

FIG. 9

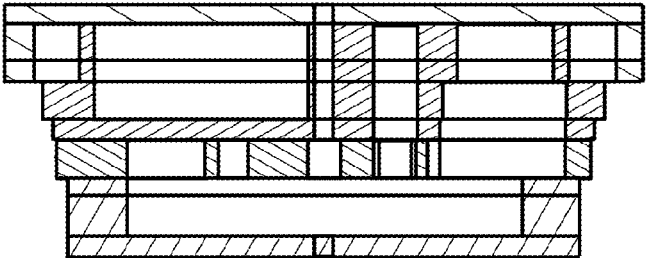
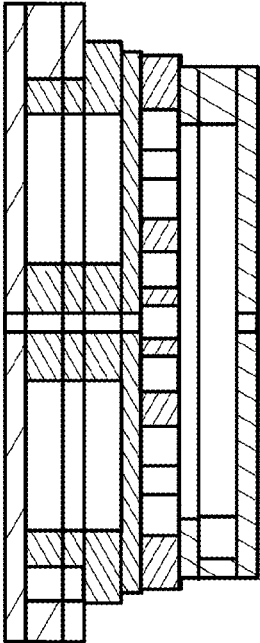
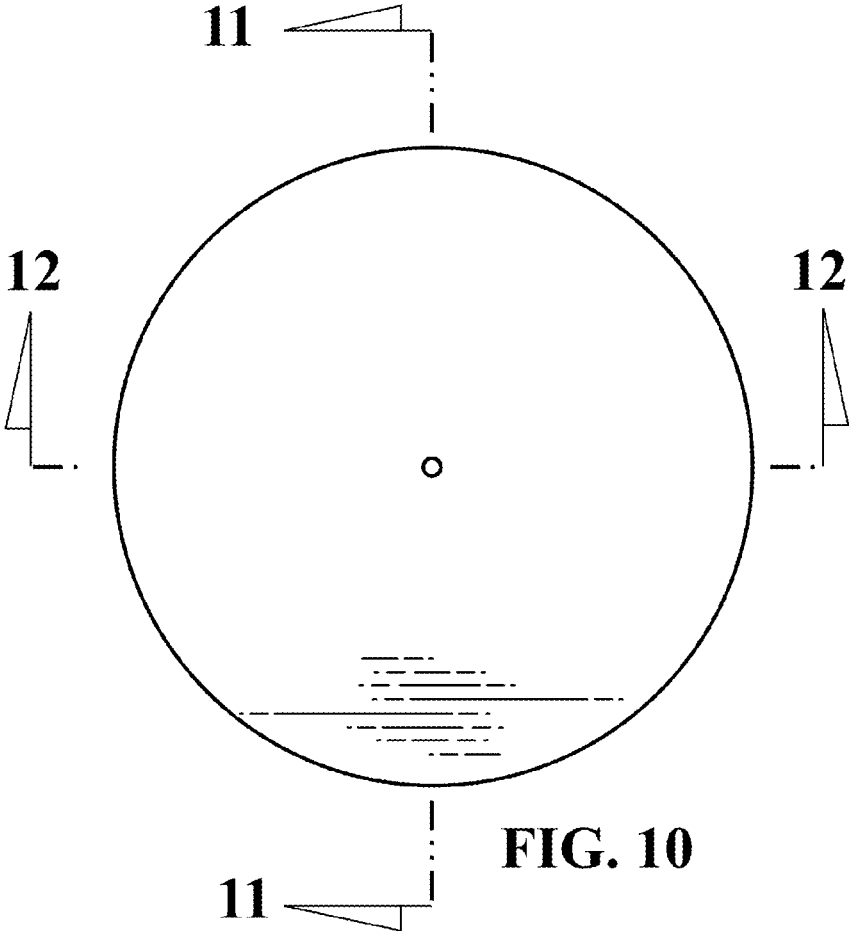

FIG. 12

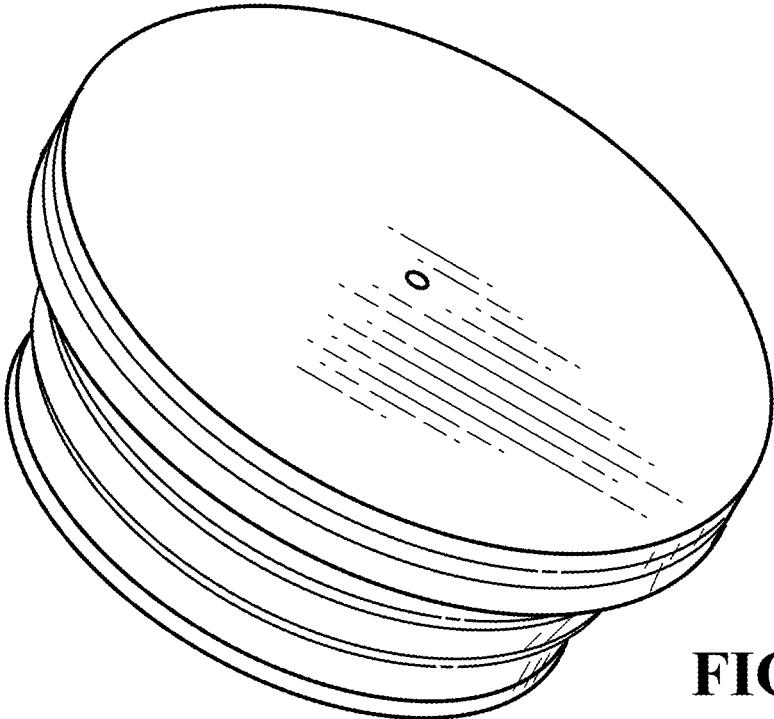

FIG. 13

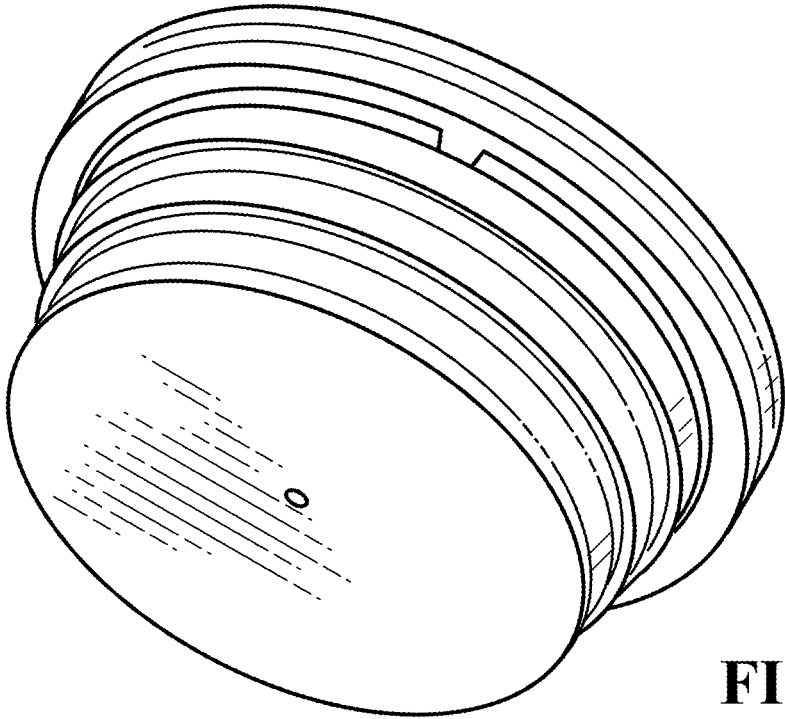

FIG. 14