



US00D904921S

(12) **United States Design Patent**  
**Chung et al.**

(10) **Patent No.:** **US D904,921 S**

(45) **Date of Patent:** **\*\* Dec. 15, 2020**

(54) **WRISTBAND FOR PORTABLE ELECTRONIC DEVICE**

FOREIGN PATENT DOCUMENTS

(71) Applicant: **Samsung Electronics Co., Ltd.**,  
Suwon-si (KR)

CN 201530337615.9 4/2016  
KR 30-2013-0047508 1/2015

(Continued)

(72) Inventors: **In-Sik Chung**, Suwon-si (KR); **Sanhui Oh**, Suwon-si (KR); **Kwang Ha Choi**, Suwon-si (KR); **Jae-Hyung Hong**, Suwon-si (KR)

OTHER PUBLICATIONS

General. "General Generic SIM/TF Bluetooth Sport Pedometer Wrist Watch A1G08 Smartwatch for Android Smartphone And Apple 5 5s 6 6 Plus (white)." [2019] www.jumia.com Apr. 22, 2019 <<https://www.jumia.com.ng/general-generic-simtf-bluetooth-sport-pedometer-wrist-watch-a1g08-smartwatch-for-android-smartphone-and-apple-5-5s-6-6-plus-white-30293392.html>>.

(Continued)

(73) Assignee: **Samsung Electronics Co., Ltd.**,  
Suwon-si (KR)

(\*\*) Term: **15 Years**

*Primary Examiner* — Llorelys Martinez

(21) Appl. No.: **29/688,426**

(74) *Attorney, Agent, or Firm* — NSIP Law

(22) Filed: **Apr. 22, 2019**

(30) **Foreign Application Priority Data**

Jan. 23, 2019 (KR) ..... 30-2019-0003444

(51) **LOC (12) Cl.** ..... **11-01**

(52) **U.S. Cl.**  
USPC ..... **D11/3; D11/87; D14/344**

(58) **Field of Classification Search**  
USPC ..... D11/1-3, 86, 87; D14/344; D24/167;  
D10/31, 32  
CPC ..... A44C 5/00; A44C 5/0007; A44C 5/0015;  
A44C 5/0023; A44C 5/003; A44C  
5/0053; A44C 5/14; A44C 5/16; A44C  
5/2052; A44C 5/2057; A44C 5/2071  
See application file for complete search history.

(57) **CLAIM**

We claim the ornamental design for a wristband for portable electronic device, as shown and described.

**DESCRIPTION**

FIG. 1 is a front perspective view of a wristband for portable electronic device showing our new design;  
FIG. 2 is a front view thereof;  
FIG. 3 is a rear view thereof;  
FIG. 4 is a left side view thereof;  
FIG. 5 is a right side view thereof;  
FIG. 6 is a top view thereof;  
FIG. 7 is a bottom view thereof;  
FIG. 8 is a rear perspective view thereof; and,  
FIG. 9 is a cross-sectional view thereof taken vertically through line 9-9 in FIG. 2.

The dash-dash broken lines in the drawing figures depict portions of the wristband for portable electronic device that form no part of the claimed design. The dot-dash broken lines in the drawing figures represent a boundary of the claimed design and form no part thereof.

(56) **References Cited**

U.S. PATENT DOCUMENTS

D152,417 S \* 1/1949 Glass ..... D11/3  
D727,197 S \* 4/2015 Akana ..... D11/3  
D747,997 S \* 1/2016 Akana ..... D11/3  
D756,822 S \* 5/2016 Akana ..... D10/32

(Continued)

**1 Claim, 9 Drawing Sheets**

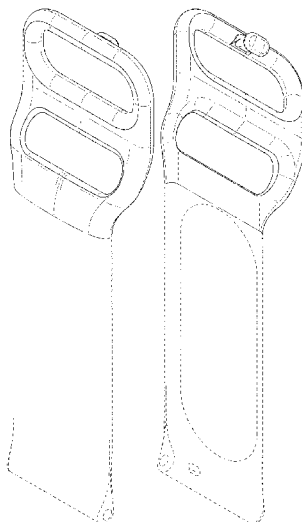

(56)

**References Cited**

## U.S. PATENT DOCUMENTS

D795,120 S \* 8/2017 Bayley ..... D11/3  
 D795,731 S \* 8/2017 Bayley ..... D11/3  
 D821,246 S \* 6/2018 Akana ..... D11/3  
 D824,273 S \* 7/2018 Akana ..... D11/3  
 D858,515 S \* 9/2019 Akana ..... D14/344  
 D875,728 S \* 2/2020 Wu ..... D14/344  
 D881,059 S \* 4/2020 Schowalter ..... D11/3  
 D881,060 S \* 4/2020 Wang ..... D11/3  
 D881,876 S \* 4/2020 Xiao ..... D14/344  
 D884,695 S \* 5/2020 Jones ..... D14/344  
 D894,179 S \* 8/2020 Chung ..... D14/344  
 2018/0017943 A1 \* 1/2018 Huang ..... A44C 5/0023  
 2020/0205530 A1 \* 7/2020 Hinds ..... A44C 5/14

## FOREIGN PATENT DOCUMENTS

KR 30-2018-0002969 11/2018  
 KR 30-2018-0003695 11/2018

## OTHER PUBLICATIONS

Bouchard, Anthony. "Nike's new sneaker-matching Apple Watch bands now available for purchase." [2017] www.idownloadblog.com Jun. 1, 2017 <<https://www.idownloadblog.com/2017/06/01/nikes-new-sneaker-matching-apple-watch-bands-are-available-for-purchase/>>.

Sylvito06. "Sony SmartWatch 3 SWR50—Montre intelligente—affichage 1.6"—4 Go—Wi-Fi, NFC, Bluetooth—45 g—noir Sony" [2019] www.fr.shopping.rakuten.com Apr. 22, 2019 <<https://fr.shopping.rakuten.com/offer/buy/440620604/sony-smartwatch-3-swr50-noir.html>>.

\* cited by examiner

FIG. 1

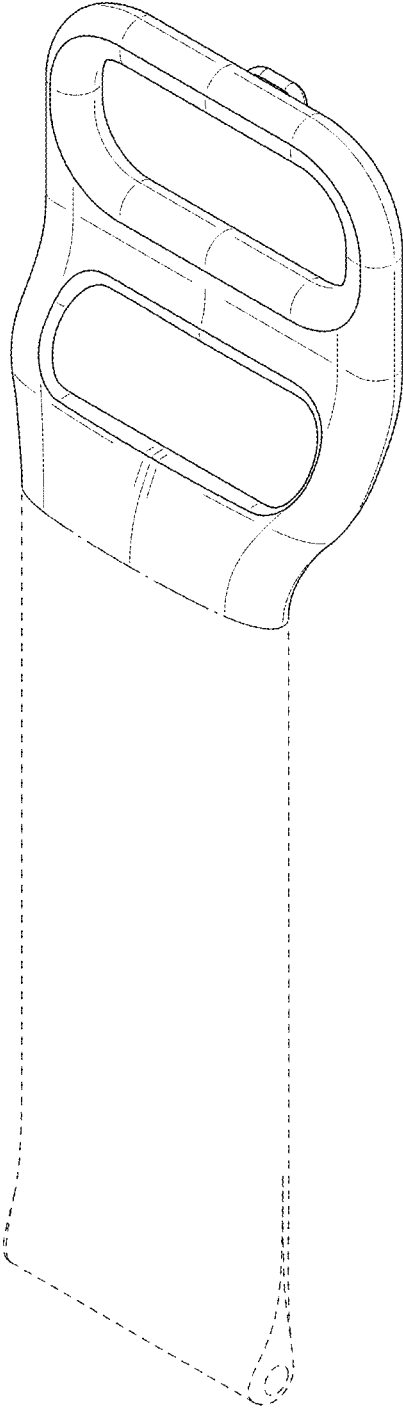

FIG. 2

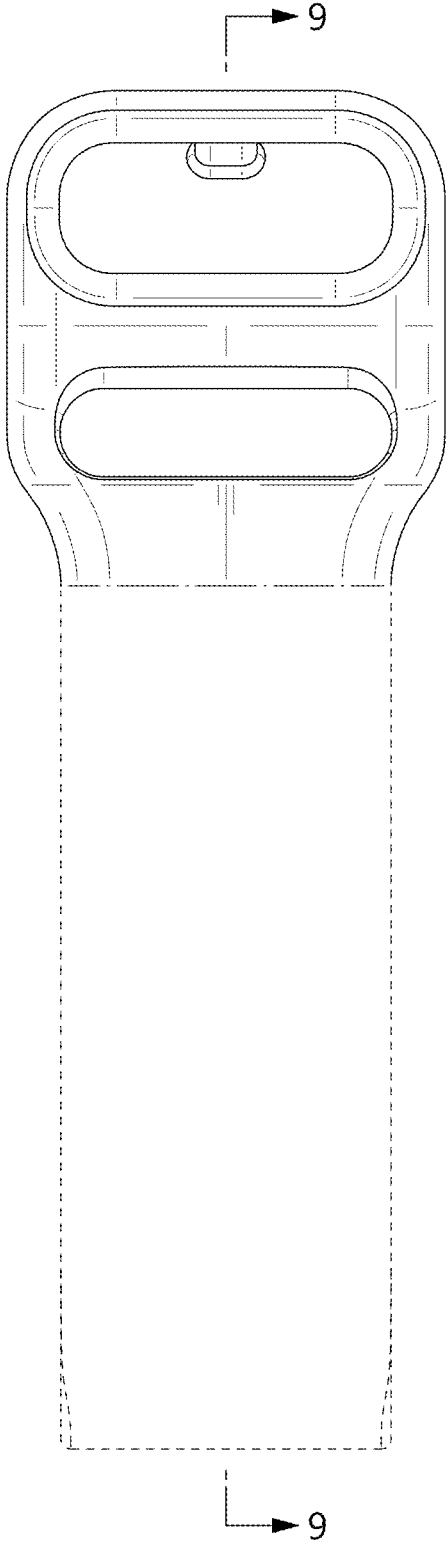

FIG. 3

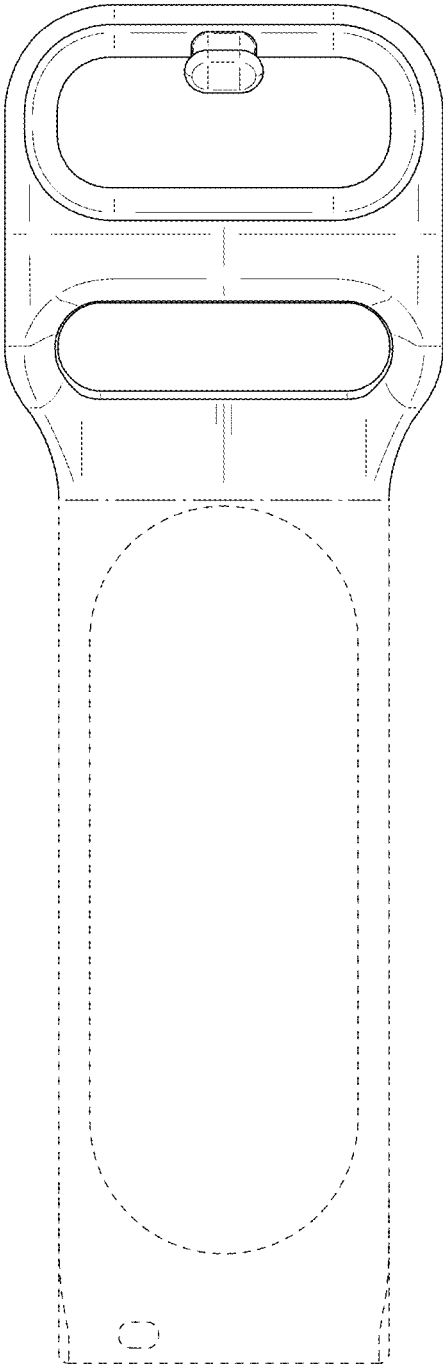

FIG. 4

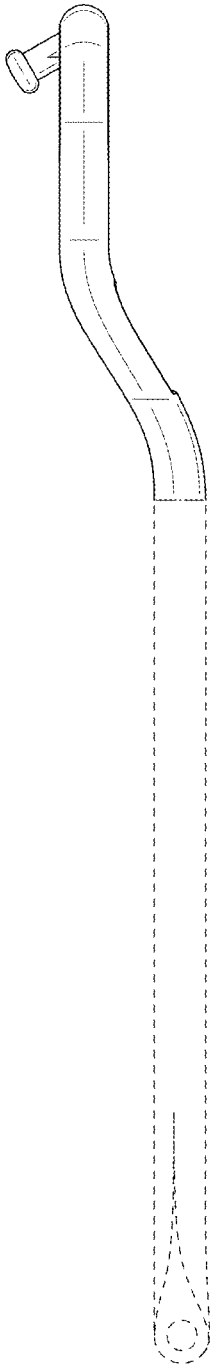

FIG. 5

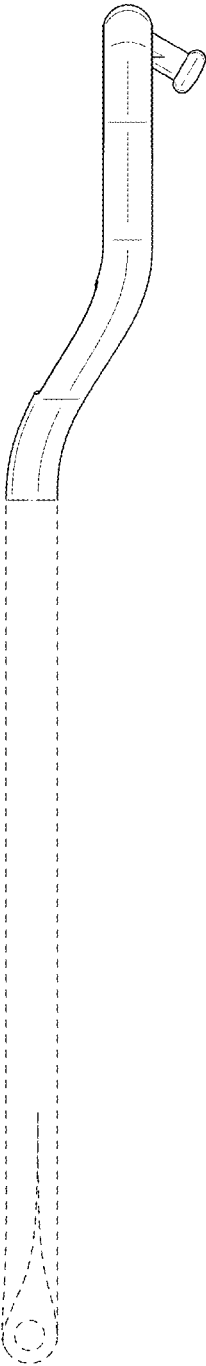

FIG. 6

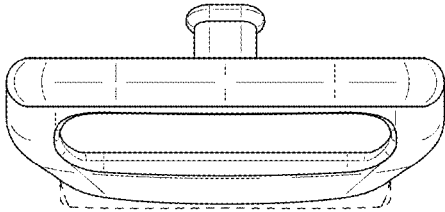



FIG. 7

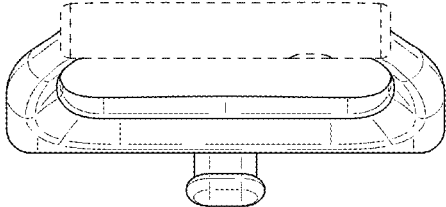

FIG. 8

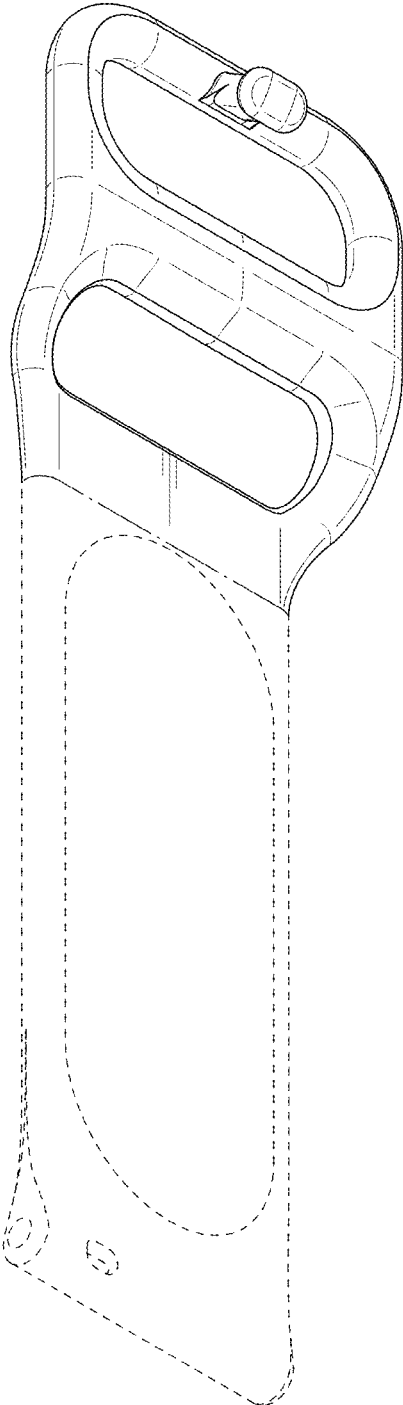

FIG. 9

