



US00D462294S

(12) **United States Design Patent** (10) **Patent No.:** **US D462,294 S**
Walsh (45) **Date of Patent:** **** Sep. 3, 2002**

(54) **VASE**
(75) Inventor: **Claire Walsh, Dungarvan (IE)**
(73) Assignee: **Waterford Wedgwood PLC, Waterford (IE)**
(**) Term: **14 Years**
(21) Appl. No.: **29/150,712**
(22) Filed: **Nov. 29, 2001**
(30) **Foreign Application Priority Data**
Jun. 1, 2001 (IE) 191/01
Jun. 1, 2001 (IE) 196/01

(51) **LOC (7) Cl.** **11-02**
(52) **U.S. Cl.** **D11/146; D11/143**
(58) **Field of Search** **D11/143, 144, D11/146, 147, 149, 152, 153, 154, 155; 47/41.01, 41.12, 41.13, 65.5, 66.6, 41.15; 206/423; 248/27.8; D7/509, 523**

(56) **References Cited**
U.S. PATENT DOCUMENTS
D40,562 S * 3/1910 Dawley D11/143
D77,556 S * 1/1929 Kopp D11/143
D119,618 S * 3/1940 Fuerst D11/143
2,996,208 A * 8/1961 Schroeder D7/523
D260,088 S * 8/1981 Murphy D11/146
D287,204 S * 12/1986 Bierlein et al. D7/523
D320,493 S * 10/1991 Fewell D11/155
D331,173 S * 11/1992 Durand D7/523
D365,041 S * 12/1995 Dollinger D11/146
D446,748 S * 8/2001 Hutton D11/146

* cited by examiner
Primary Examiner—Doris V. Coles
Assistant Examiner—Mimosa De
(74) *Attorney, Agent, or Firm*—Burns, Doane, Swecker & Mathis, L.L.P.

(57) **CLAIM**
The ornamental design for a vase, as shown and described.

DESCRIPTION
FIG. 1 is a perspective view of a vase showing a first embodiment of my new design;
FIG. 2 is a top plan view thereof;
FIG. 3 is a left side elevation view thereof, the right side view being a mirror image thereof;
FIG. 4 is front elevational view thereof, the rear view being a mirror image view thereof;
FIG. 5 is a bottom view thereof;
FIG. 6 is a perspective view of a vase showing a second embodiment of my new design;
FIG. 7 is a top plan view thereof;
FIG. 8 is a left side elevational view thereof, the right side view being a mirror image thereof;
FIG. 9 is front elevational view thereof, the rear view being a mirror image view thereof;
FIG. 10 is a bottom plan view thereof;
FIG. 11 is a perspective view of a vase showing a third embodiment of my new design;
FIG. 12 is a top plan view thereof;
FIG. 13 is a left side elevational view thereof, the right side view being a mirror image thereof;
FIG. 14 is front elevational view thereof, the rear view being a mirror image view thereof;
FIG. 15 is a bottom plan view thereof;
FIG. 16 is a perspective view of a vase showing a fourth embodiment of my new design;
FIG. 17 is a top plan view thereof;
FIG. 18 is a left side elevational view thereof, the right side view being a mirror image thereof;
FIG. 19 is front elevational view thereof, the rear view being a mirror image view thereof; and,
FIG. 20 is a bottom plan view thereof.

1 Claim, 12 Drawing Sheets

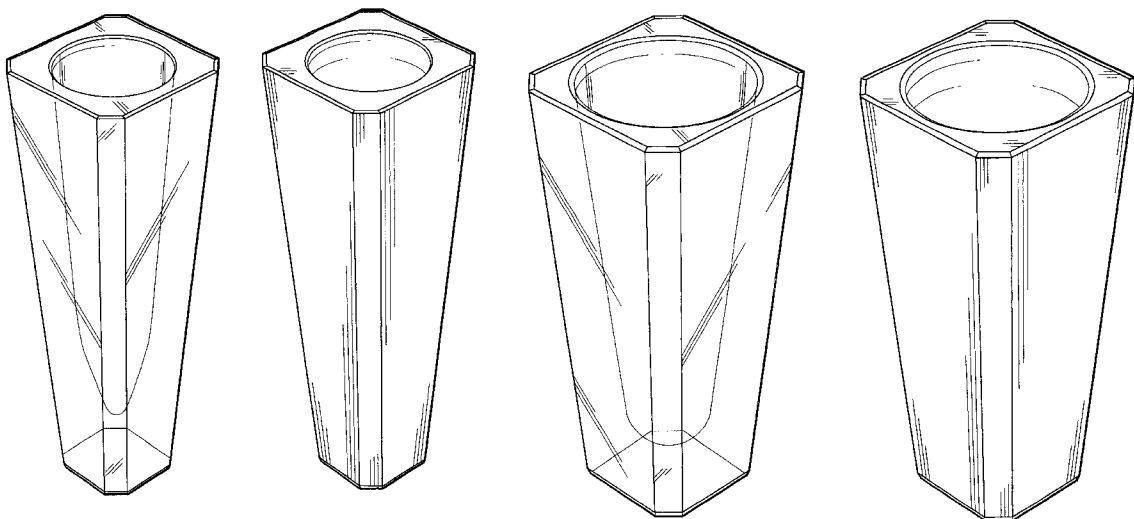

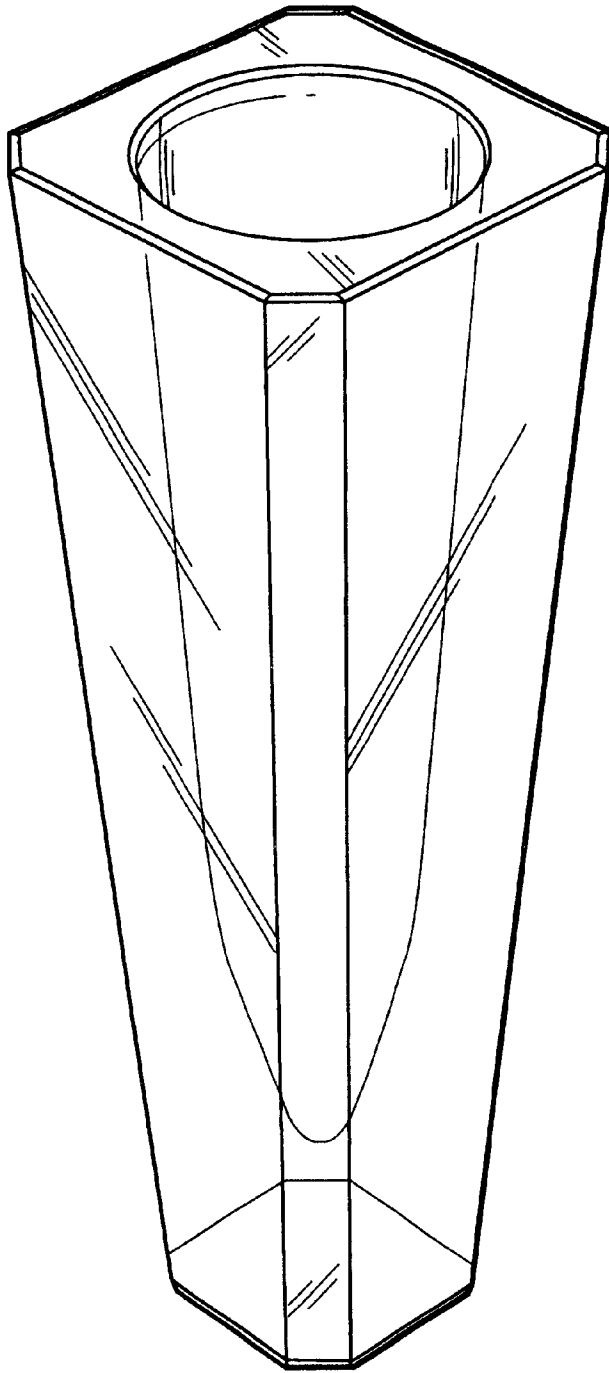

FIG. 1

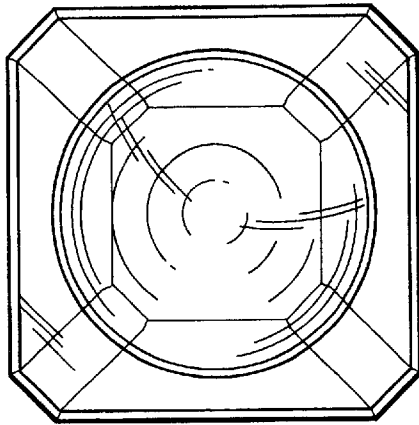

FIG. 2

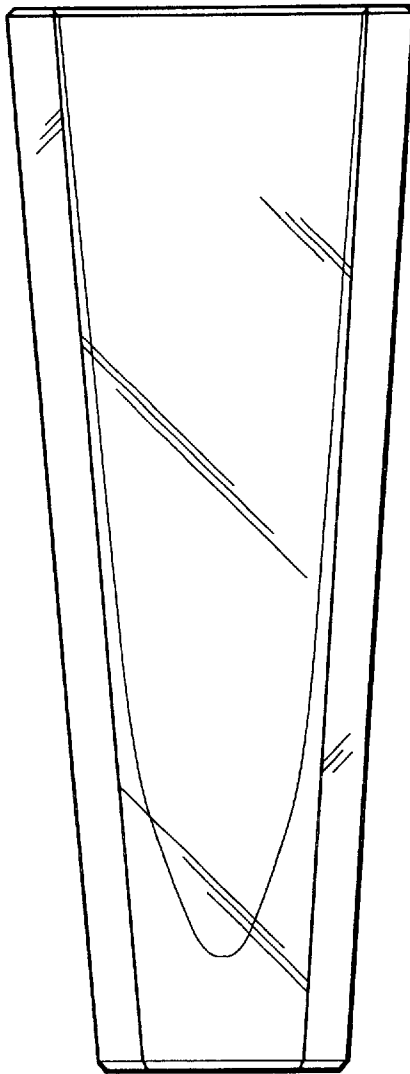

FIG. 3

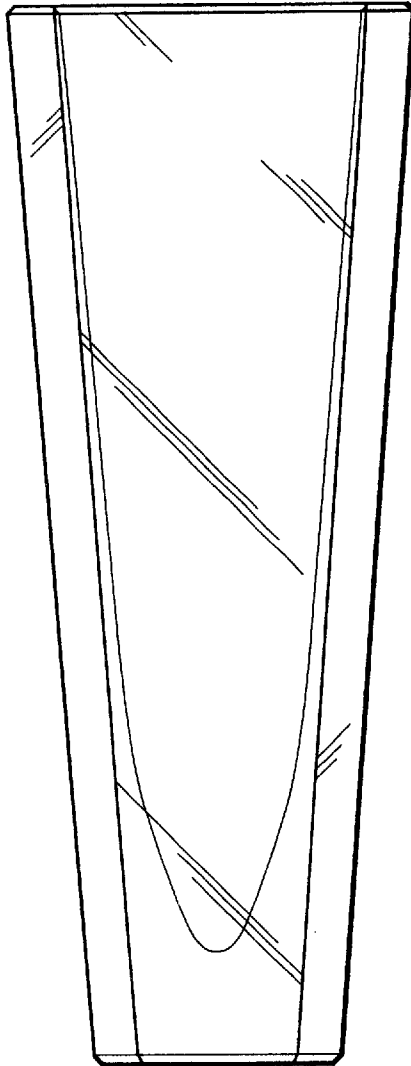

FIG. 4

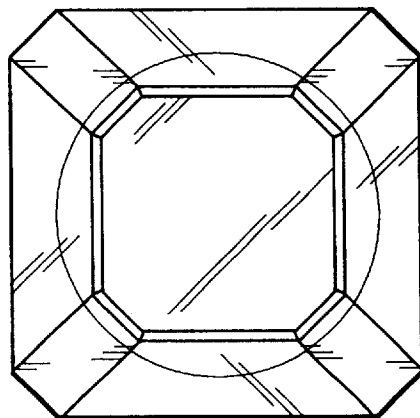

FIG. 5

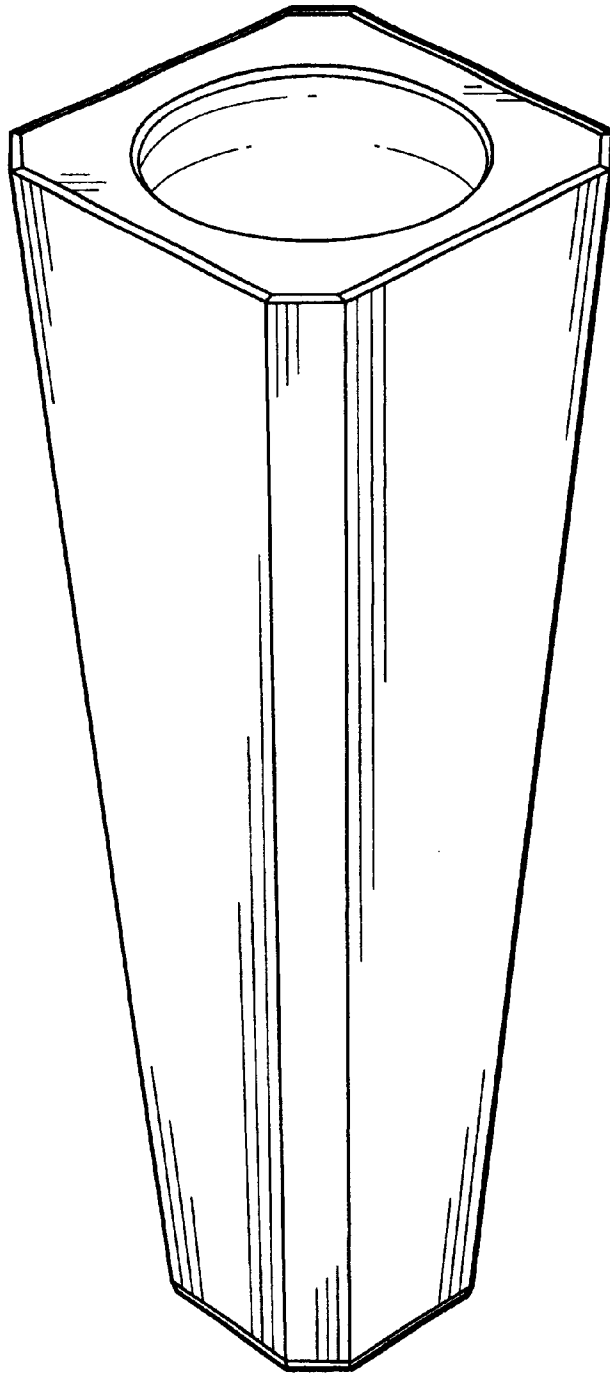

FIG. 6

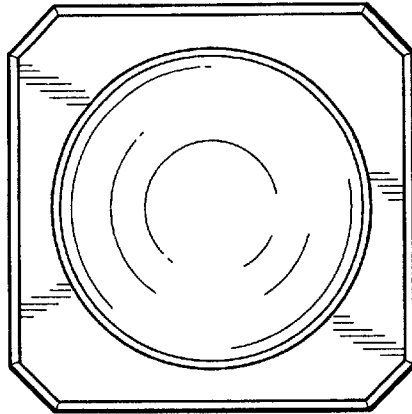

FIG. 7

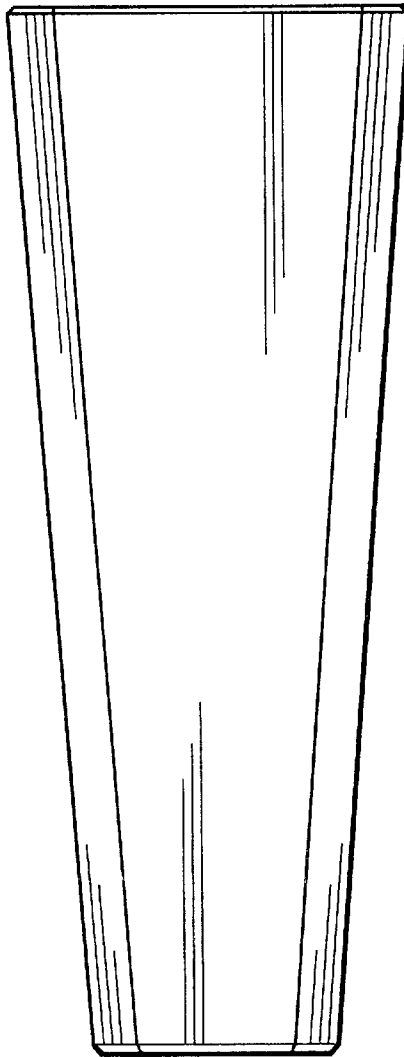

FIG. 8

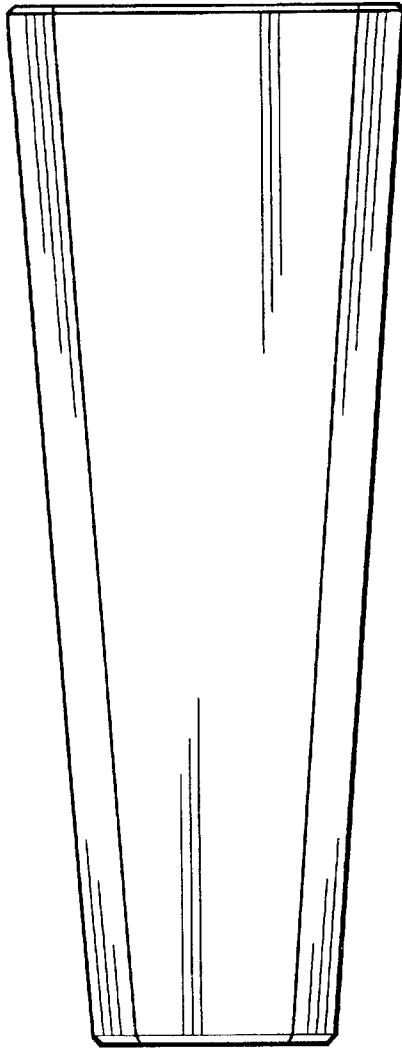

FIG. 9

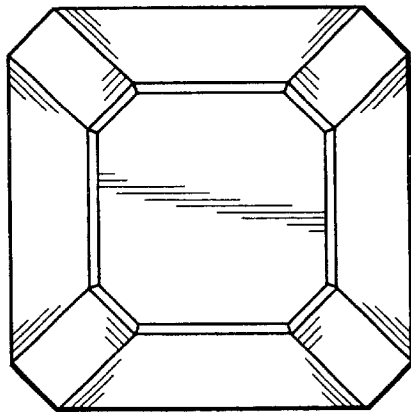

FIG. 10

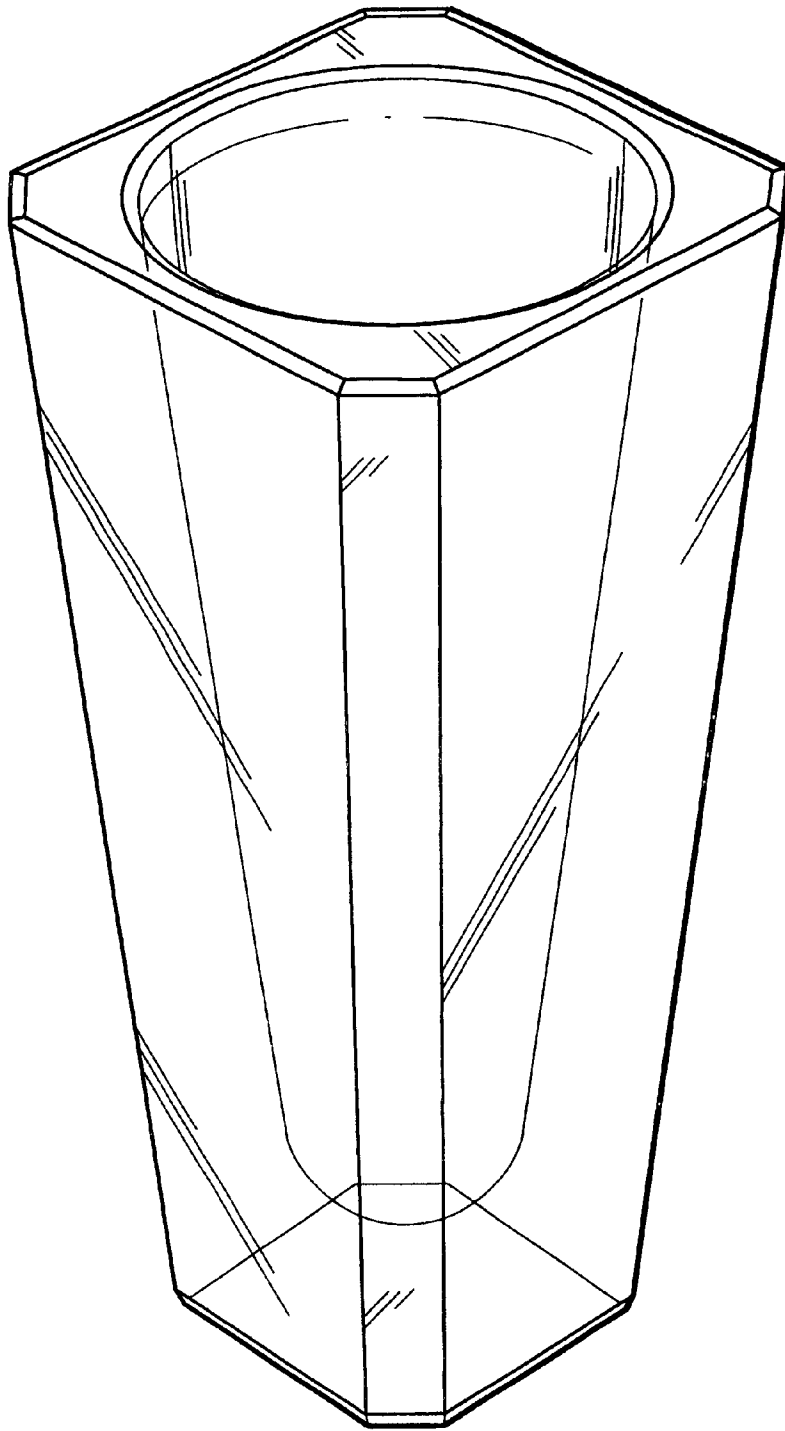

FIG. 11

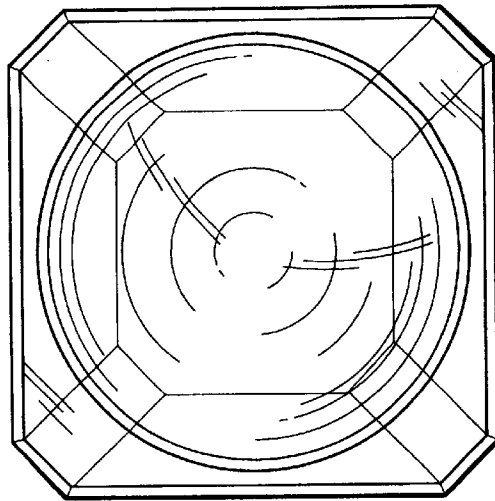

FIG. 12

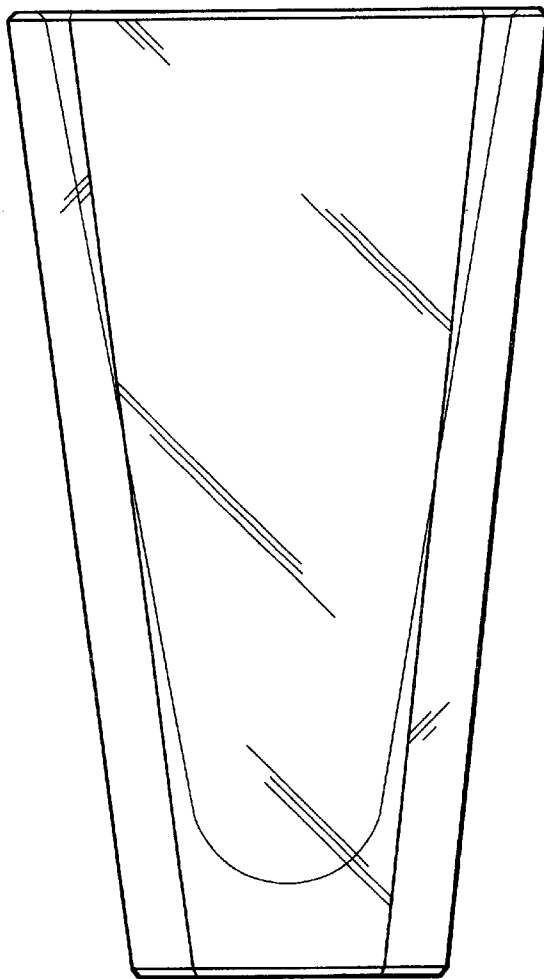

FIG. 13

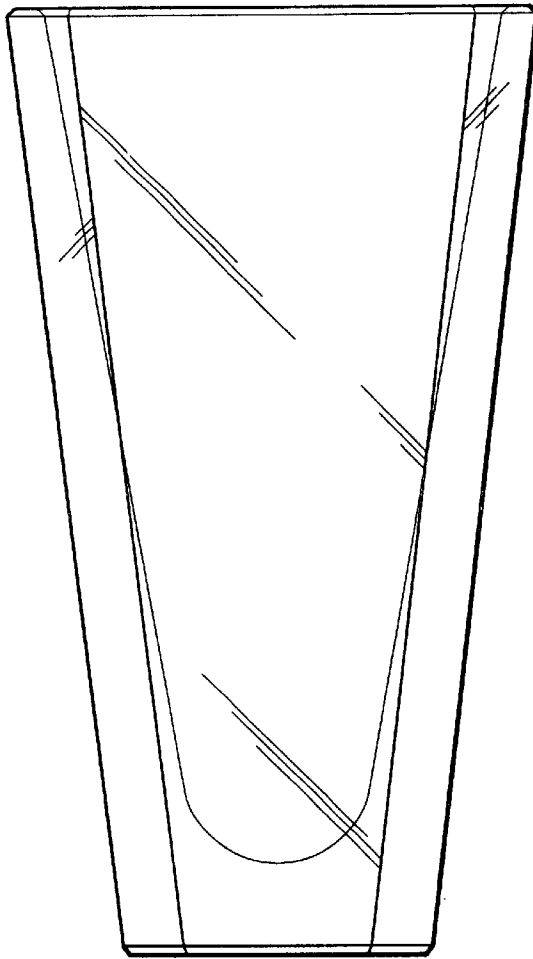

FIG. 14

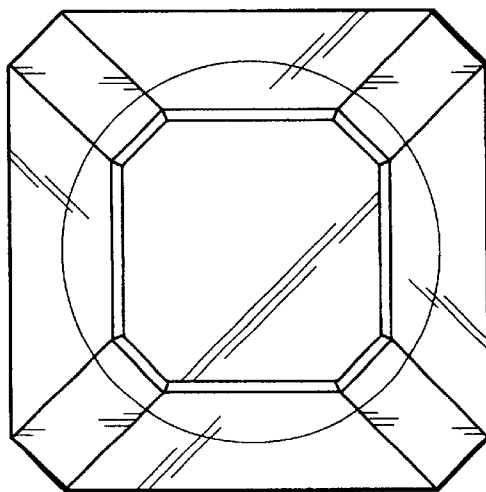

FIG. 15

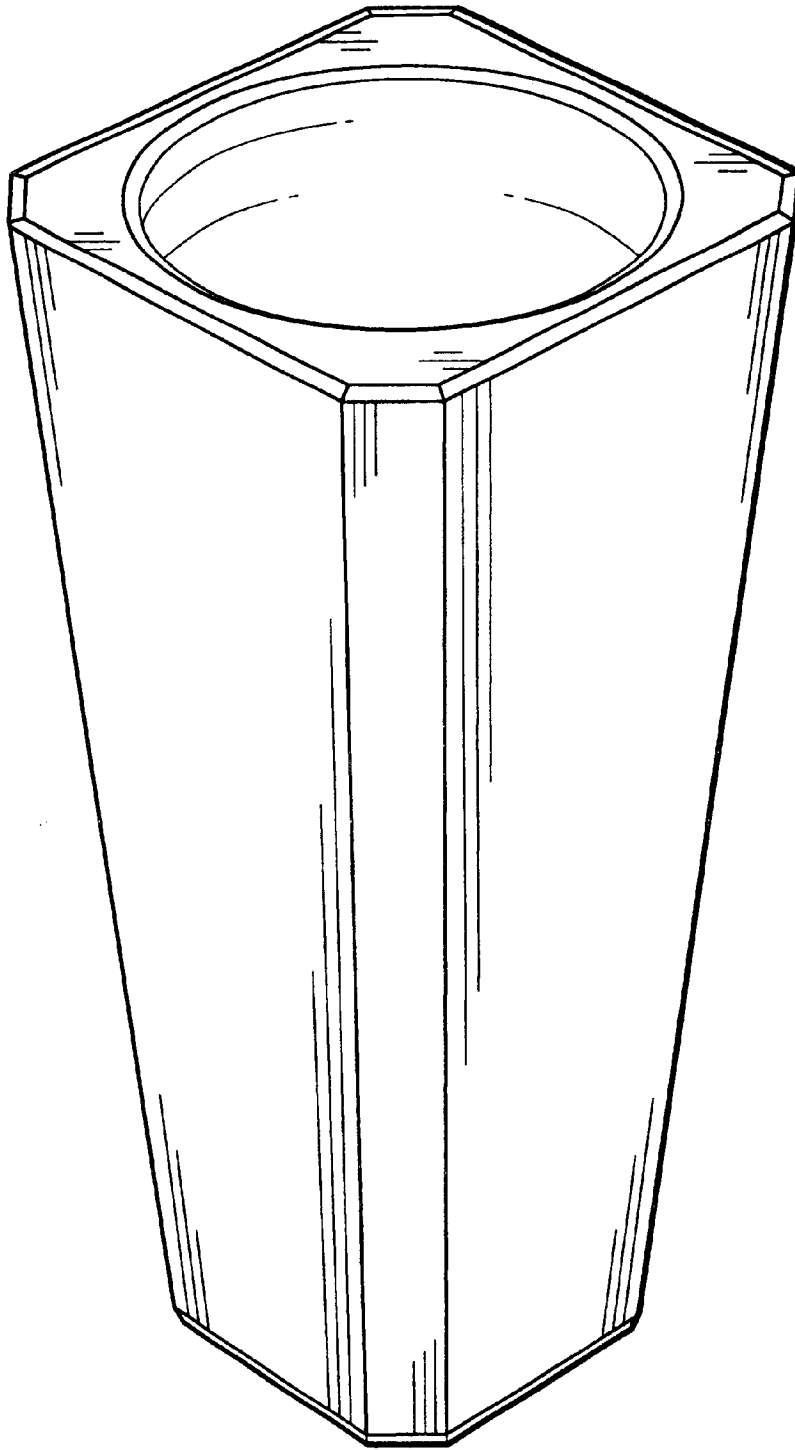

FIG. 16

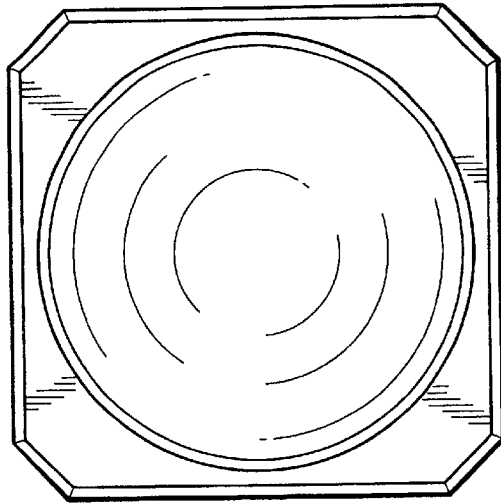

FIG. 17

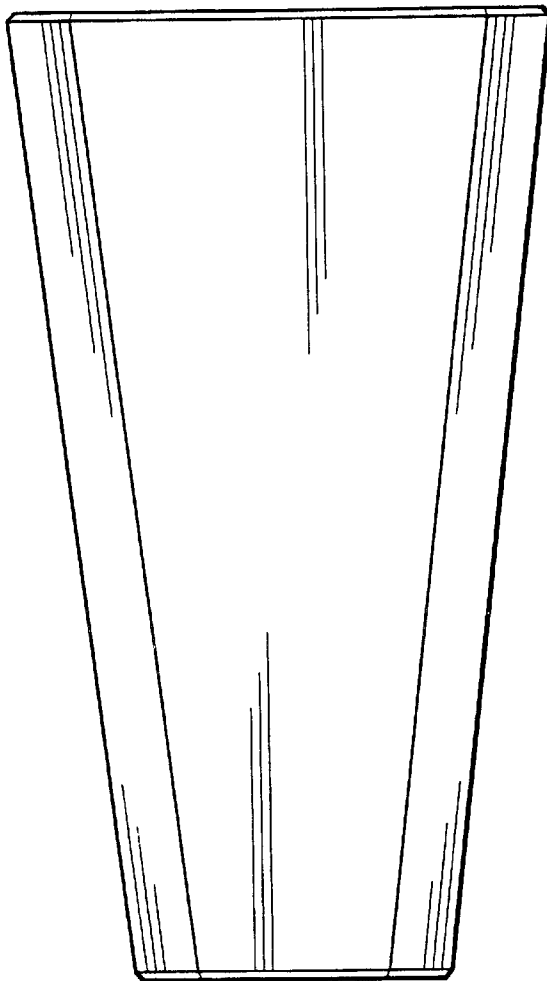

FIG. 18

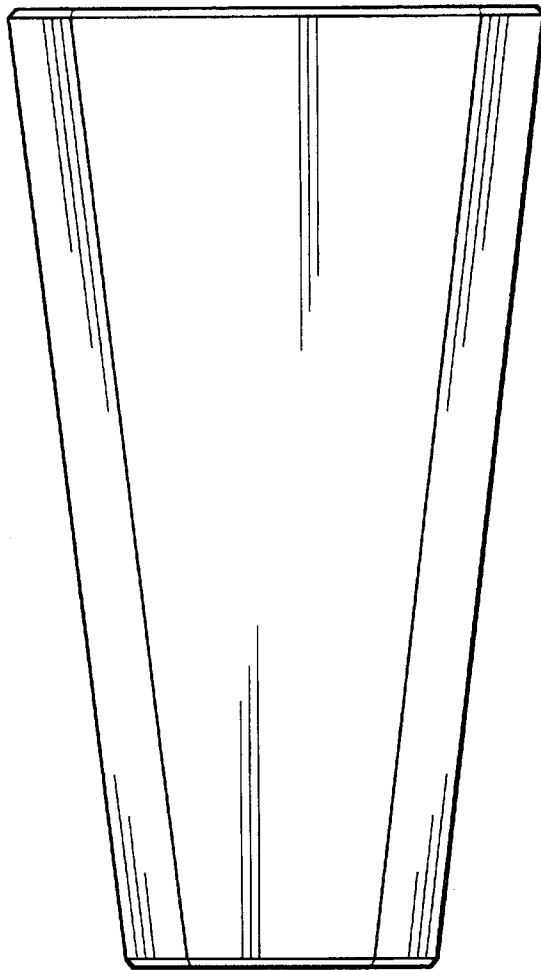

FIG. 19

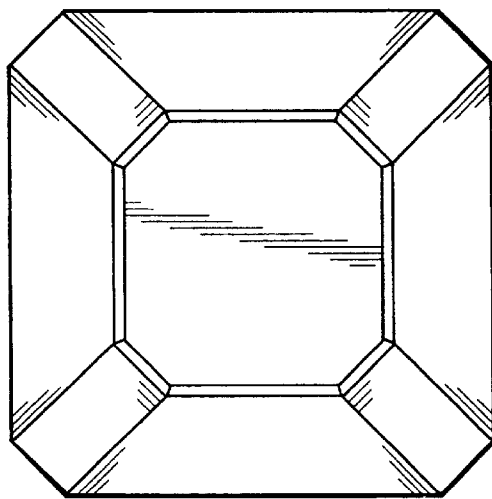

FIG. 20