



(12) **United States Design Patent**
Lindberg

(10) **Patent No.:** **US D1,028,264 S**
(45) **Date of Patent:** **** May 21, 2024**

- (54) **HAIR REMOVAL APPARATUS**
- (71) Applicant: **King’s Island Ventures SL**, Barcelona (ES)
- (72) Inventor: **Dennis Lindberg**, Barcelona (ES)
- (73) Assignee: **King’s Island Ventures SL**, Barcelona (ES)
- (**) Term: **15 Years**

2007/0239233 A1* 10/2007 Klein A61N 5/0616
607/90
2012/0022618 A1* 1/2012 Lum A61N 5/0603
607/90
2012/0197357 A1* 8/2012 Dewey A61N 5/0616
607/89

FOREIGN PATENT DOCUMENTS

EM 009069099-0001 * 7/2022
JP D1716716 * 6/2022

OTHER PUBLICATIONS

“Braun: IPL Long-lasting hair removal system.” Found online at amazon.com. Apr. 25, 2023. Reference dated Sep. 24, 2022. Retrieved from <https://www.amazon.com/Braun-Permanent-Removal-Cleared-Alternative/dp/B09WQRPYP/>.*

(Continued)

Primary Examiner — Kendra Leslie Hamilton
Assistant Examiner — Elizabeth S Struble
(74) *Attorney, Agent, or Firm* — Thomas Y. Kendrick;
Benjamin E. Kern; Kern Kendrick LLC

(57) **CLAIM**

The ornamental design for a hair removal apparatus, as shown and described.

DESCRIPTION

FIG. 1 is a top plan view of a hair removal apparatus; FIG. 2 is a bottom, front, left perspective view thereof; FIG. 3 is a front elevation view, shown enlarged for clarity of disclosure; FIG. 4 is a top, rear, left perspective view of the hair removal apparatus of FIG. 1; FIG. 5 is a bottom, rear, left perspective view thereof; FIG. 6 is a bottom plan view thereof; and, FIG. 7 is a left elevation view thereof. In the drawings, the equal-length broken lines depict portions of the hair removal apparatus that form no part of the claimed design.

1 Claim, 7 Drawing Sheets

- (21) Appl. No.: **29/826,079**
- (22) Filed: **Feb. 9, 2022**
- (51) **LOC (14) Cl.** **28-03**
- (52) **U.S. Cl.**
USPC **D28/44.1**
- (58) **Field of Classification Search**
USPC D24/107, 133, 188, 200, 206, 209, 210,
D24/211, 214, 215, 231; D28/9, 10, 44,
D28/44.1, 44.2, 99
CPC B26B 19/00; B26B 19/10; B26B 19/02;
B26B 19/04; B26B 19/38; B16B 19/12;
A61B 2018/0047; A45D 26/00; A45D
26/0004–0009; A45D 26/0057
See application file for complete search history.

(56) **References Cited**

U.S. PATENT DOCUMENTS

D787,083 S * 5/2017 Ely D24/209
D797,302 S * 9/2017 Vahlensieck D24/209
D905,335 S * 12/2020 Kling D28/44.1
D943,104 S * 2/2022 Dijkstra D24/209
D965,880 S * 10/2022 Zhou D28/44.1
D965,881 S * 10/2022 Zhou D28/44.1
D965,883 S * 10/2022 Wang D28/44.1
D965,884 S * 10/2022 Zhou D28/44.1
D967,526 S * 10/2022 Kling D28/44.1
D973,958 S * 12/2022 Liu D28/44.1

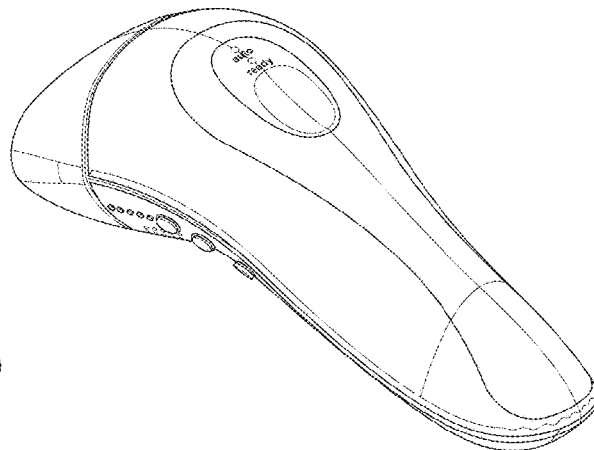
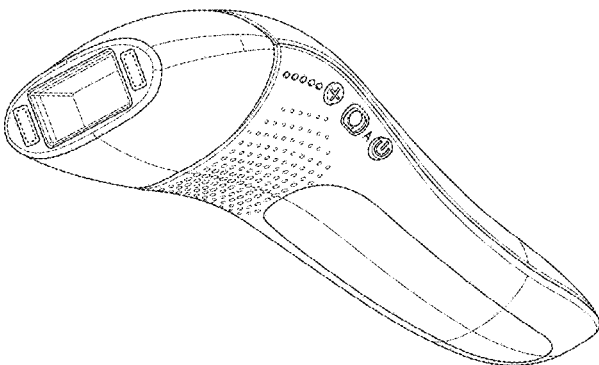

(56)

References Cited

OTHER PUBLICATIONS

“RoseSkinCo: OG IPL Hair Removal Handset.” Found online at roseskinco.com. Apr. 25, 2023. Reference dated Mar. 3, 2019. Retrieved from <https://roseskinco.com/products/ipl>.*

“Kasmotion: IPL Hair Removal.” Found online at amazon.com. Apr. 25, 2023. Reference dated Jun. 21, 2021. Retrieved from <https://www.amazon.com/Removal-Flashes-Painless-Remover-Professional/dp/B08P3F81N9>.*

“Amofaos: Laser Hair Removal.” Found online at amazon.com. Apr. 25, 2023. Reference dated Mar. 6, 2023. Retrieved from <https://www.amazon.com/Removal-remover-Flashes-Permanent-removal/dp/B0BXKKLFJ3>.*

* cited by examiner

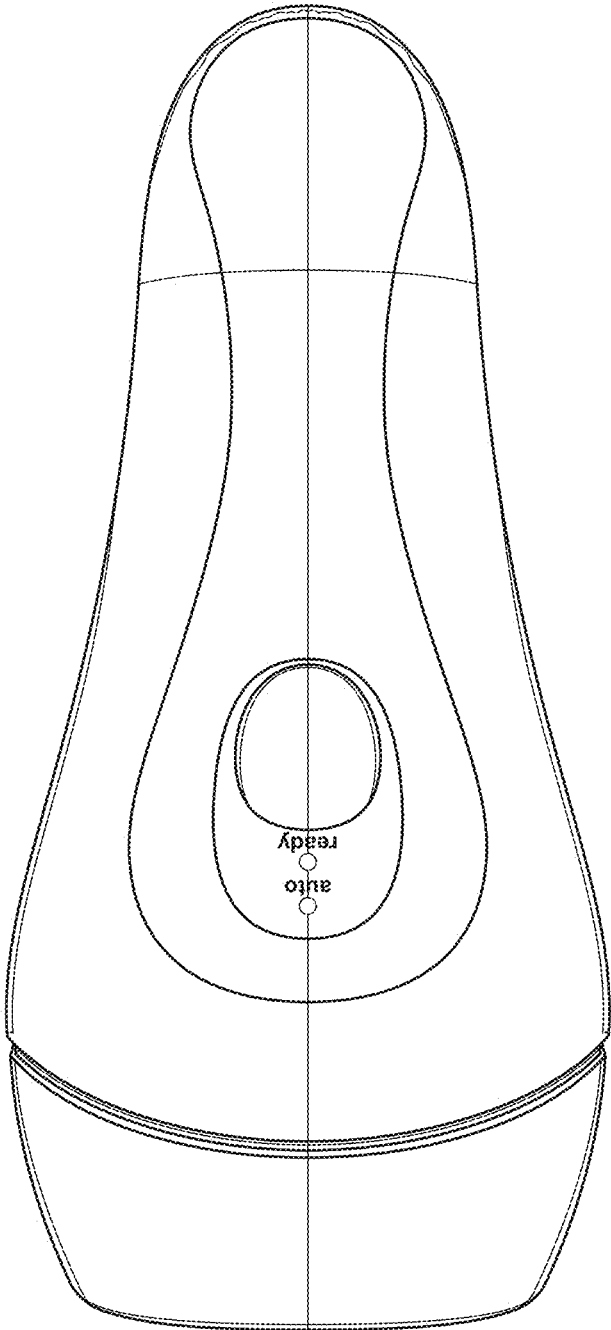

FIG. 1

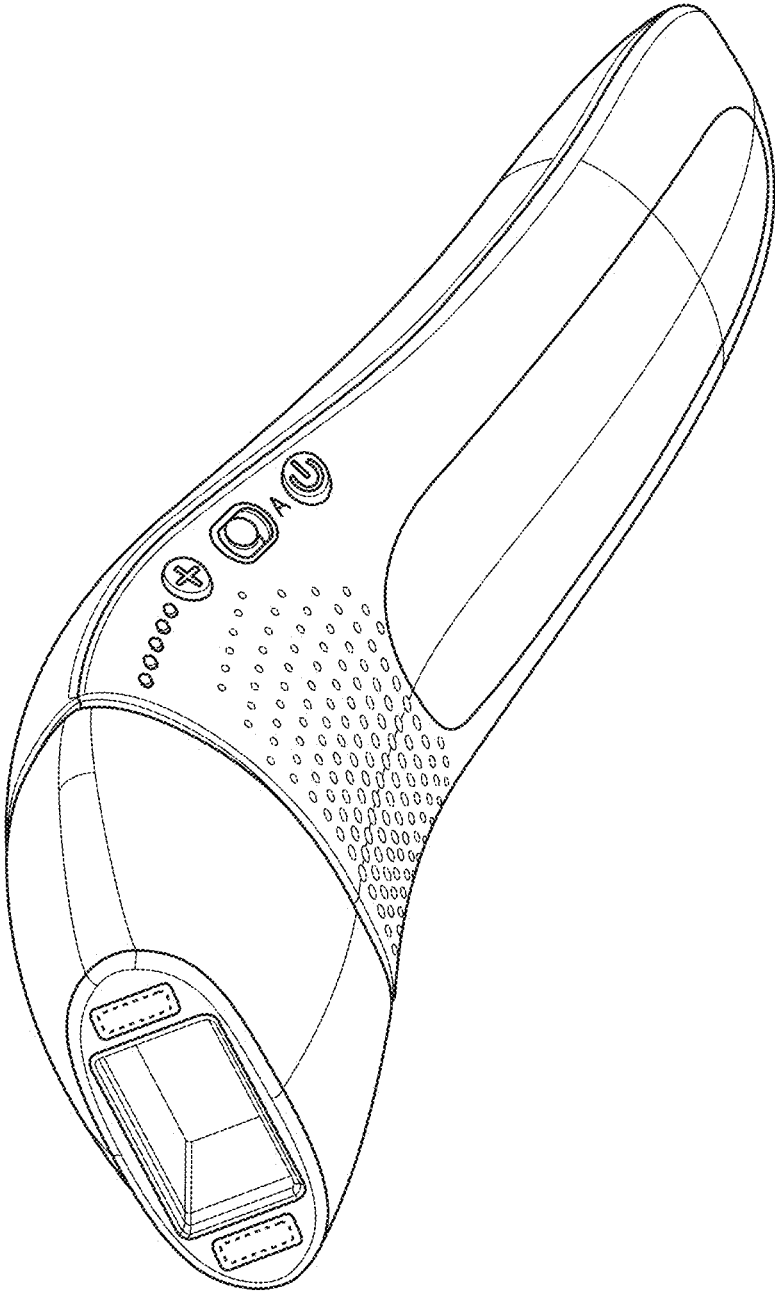

FIG. 2

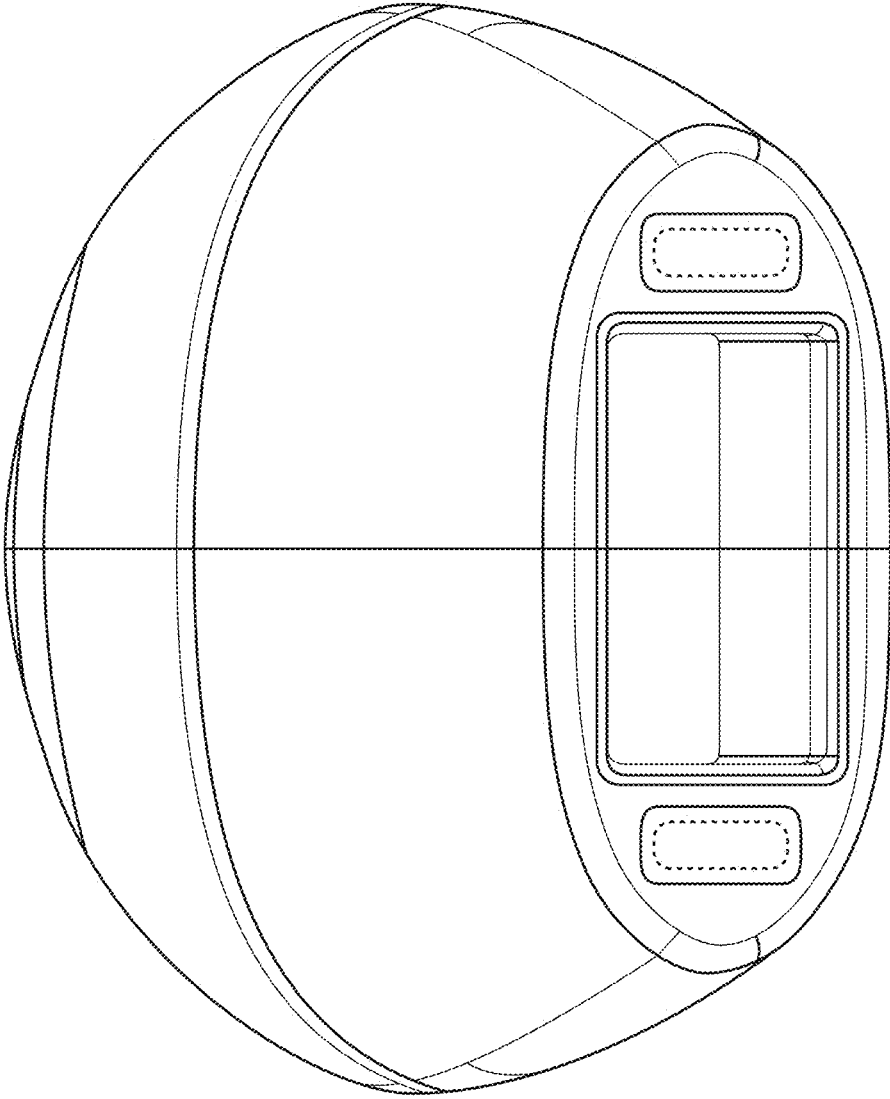

FIG. 3

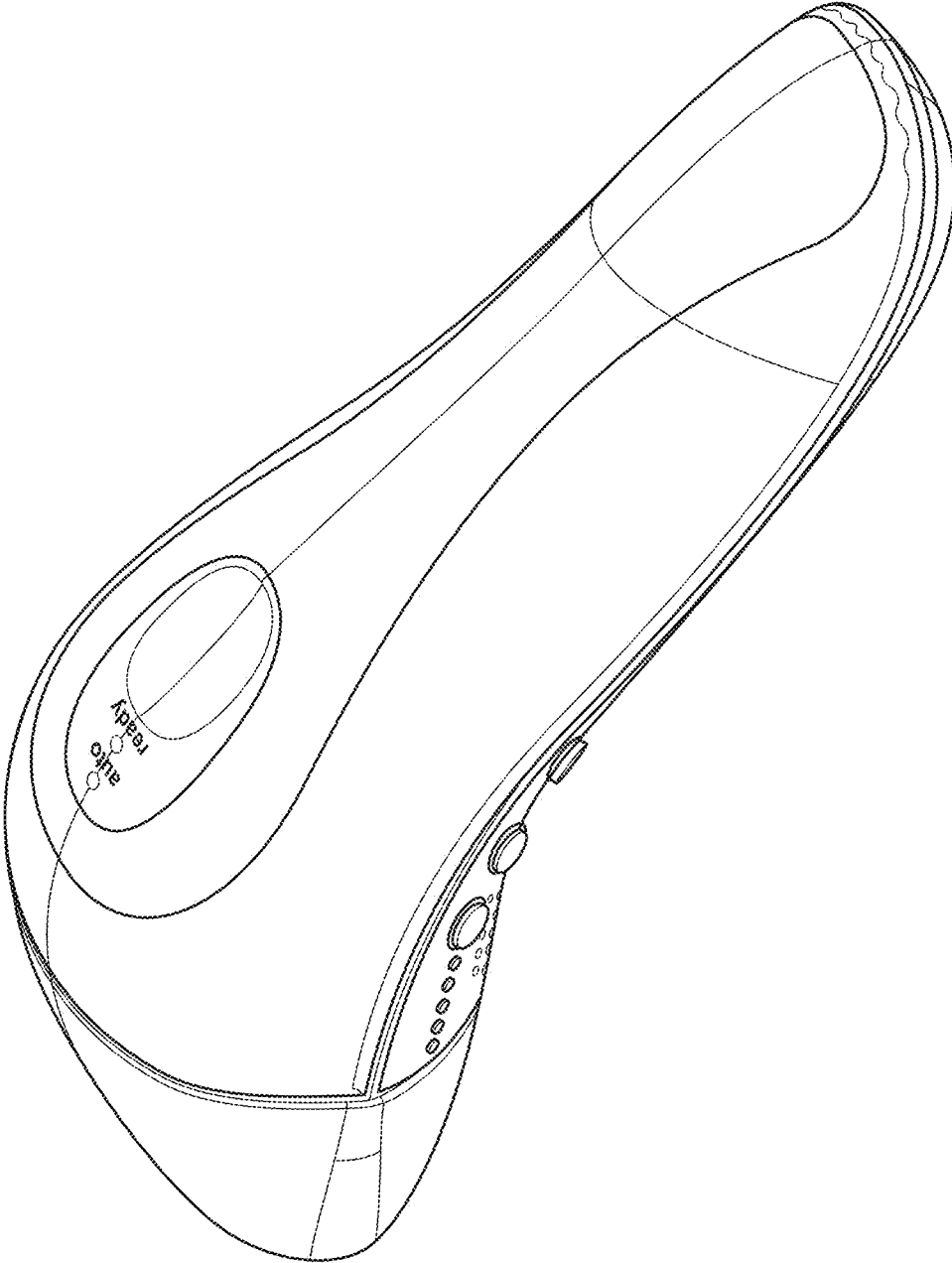

FIG. 4

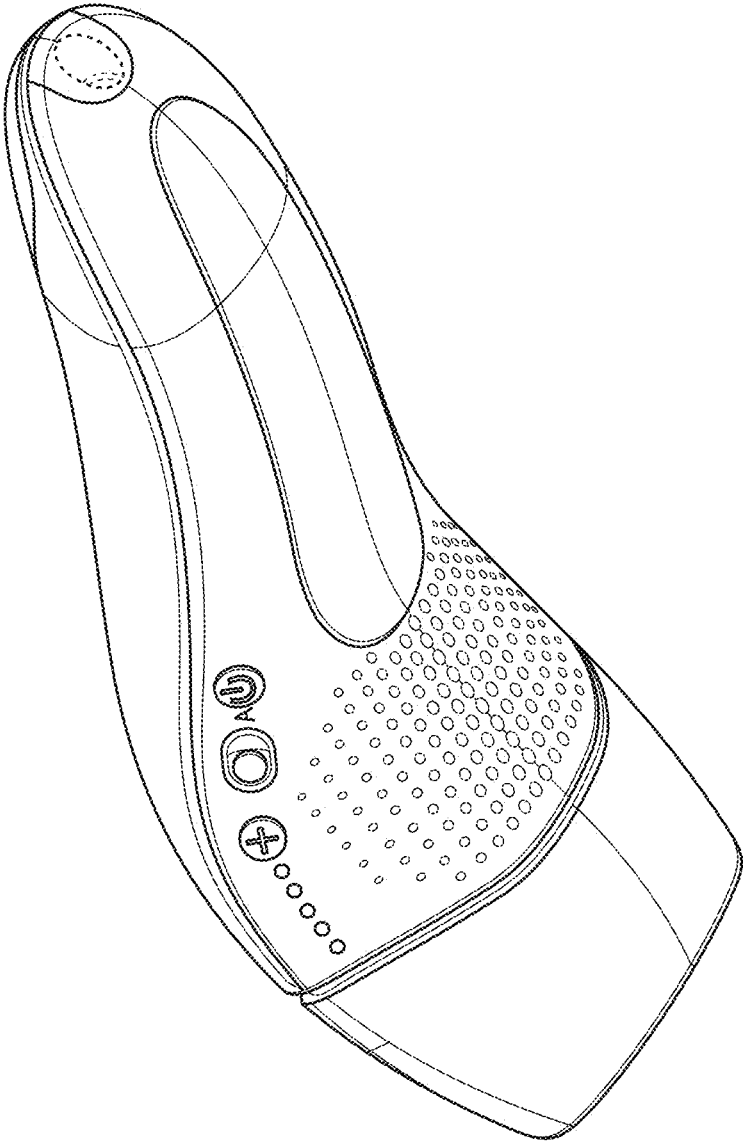

FIG. 5

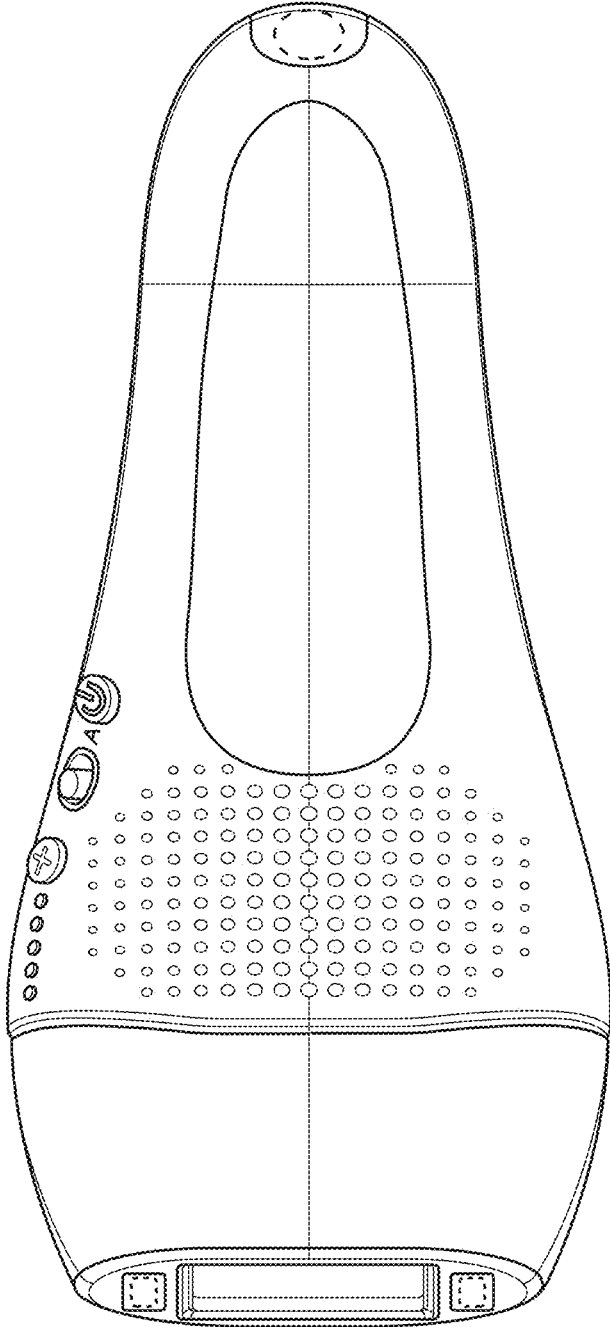

FIG. 6

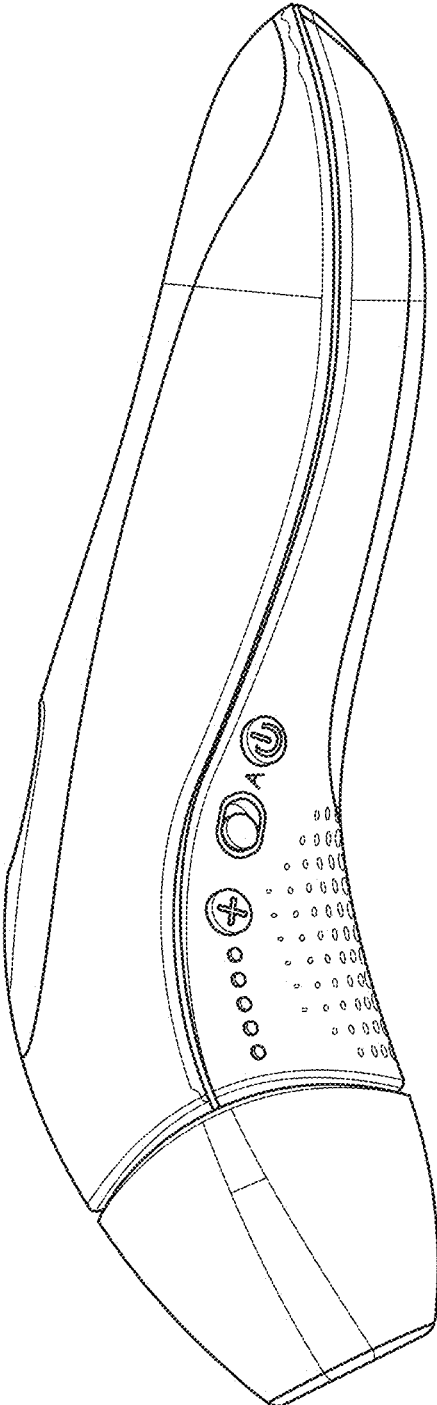

FIG. 7