



(12) **United States Design Patent**
Lotti

(10) **Patent No.:** **US D955,645 S**
(45) **Date of Patent:** **** *Jun. 21, 2022**

(54) **CASE FOR ARTIFICIAL LASH EXTENSIONS**

FOREIGN PATENT DOCUMENTS

- (71) Applicant: **Lashify, Inc.**, Los Angeles, CA (US)
- (72) Inventor: **Sahara Lotti**, Los Angeles, CA (US)
- (73) Assignee: **Lashify, Inc.**, North Hollywood, CA (US)

CN	102975141 A	3/2013
CN	303086463	1/2015

(Continued)

- (*) Notice: This patent is subject to a terminal disclaimer.
- (**) Term: **15 Years**

OTHER PUBLICATIONS

Yoyo Pill box, Alessi, amazon.com, published by Alessi on Nov. 20, 2018© 1996-2020 Amazon.com, online, site visited Aug. 6, 2020. Available at URL: <https://www.amazon.com/Alessi-Stainless-Steel-Michel-Bouquillon/dp/B07KKFQNQ6> (Year: 2018).*

(Continued)

- (21) Appl. No.: **29/722,325**
- (22) Filed: **Jan. 28, 2020**

Primary Examiner — Sandra Snapp
Assistant Examiner — Altaira J Swangin
 (74) *Attorney, Agent, or Firm* — Lowenstein Sandler LLP

Related U.S. Application Data

- (63) Continuation-in-part of application No. 29/670,676, filed on Nov. 19, 2018, which is a continuation of application No. 29/586,561, filed on Dec. 5, 2016, now Pat. No. Des. 867,668.

(57) **CLAIM**

An ornamental design for a case for artificial lash extensions, as shown and described.

- (51) **LOC (13) Cl.** **28-03**
- (52) **U.S. Cl.**
- USPC **D28/73**

DESCRIPTION

- (58) **Field of Classification Search**
 - USPC D28/73, 91; D32/40, 43; D9/418, 430, D9/435-436, 724-725, 741, 747, 756; 206/533, 769-770, 776-778, 781; D3/203.2-203.4; D7/553.1, 553.4-553.5, D7/553.8; 211/163
 - CPC A47G 29/08; A45D 44/00; A45D 33/26; A45D 33/28
- See application file for complete search history.

FIG. 1 is a front left perspective view of a case for artificial lash extensions in accordance with the present invention. FIG. 2 is a left side view thereof. FIG. 3 is a right side view thereof. FIG. 4 is a front view thereof. FIG. 5 is a rear view thereof. FIG. 6 is a top view thereof. FIG. 7 is a bottom view thereof; and, FIG. 8 is an exploded front left perspective view of the case for artificial lash extensions shown in FIG. 1. The broken lines consisting of evenly spaced dashed lines in the drawings illustrate portions of the case for artificial lash extensions which form no part of the claimed design. The shaded areas depict the scope of the claimed design.

(56) **References Cited**

U.S. PATENT DOCUMENTS

- | | | |
|-------------|---------|----------|
| 1,831,801 A | 11/1931 | Birk |
| D129,526 S | 9/1941 | Hanisch |
| 2,268,082 A | 12/1941 | Phillips |
- (Continued)

1 Claim, 5 Drawing Sheets

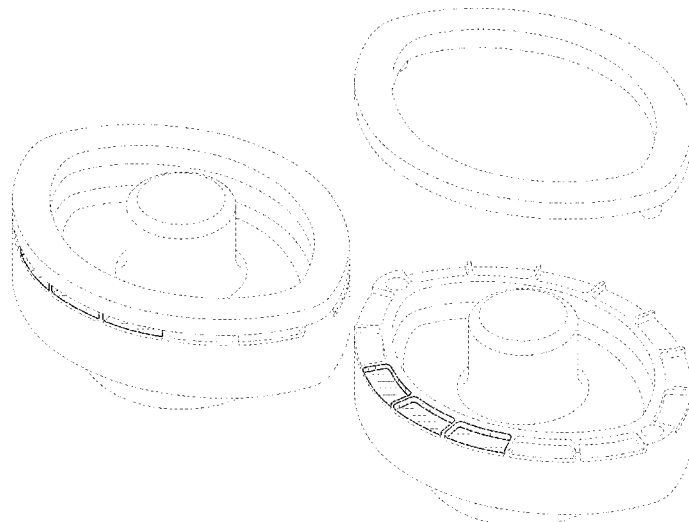

(56)

References Cited

U.S. PATENT DOCUMENTS

2,323,595	A	7/1943	Hanisch		D463,280	S	9/2002	Brozell	
2,392,694	A	1/1946	Rector		D463,744	S	10/2002	Brozell	
D155,559	S	2/1946	Tillmann		D464,565	S	10/2002	Weinstein et al.	
D154,227	S	6/1949	Alvizua		D464,877	S	10/2002	Weinstein et al.	
2,618,279	A	11/1952	Reiffert		6,471,515	B2	10/2002	Feuer	
3,016,059	A	1/1962	Hutton		D467,800	S	12/2002	Chen et al.	
3,343,552	A	9/1967	Steffen		6,530,379	B2	3/2003	Iosilevich	
3,454,015	A	7/1969	Udes		D472,675	S	4/2003	Lamagna	
3,478,754	A	11/1969	Martin, Jr.		D472,810	S	4/2003	Gelardi	
3,547,135	A	12/1970	Roos		D473,106	S	4/2003	Scherer	
3,557,653	A	1/1971	Kim		D475,616	S	6/2003	Lambrecht	
3,561,454	A	2/1971	Oconnell		D479,365	S	9/2003	Todeschini	
3,625,229	A	12/1971	Silson		D480,864	S	10/2003	Sayers et al.	
3,670,742	A	6/1972	Weaner		D481,946	S	11/2003	Nicholson	
3,645,281	A	9/1972	Seidler		D481,952	S	11/2003	Orsomando	
3,703,180	A	11/1972	Aylott		D482,495	S	11/2003	Jackel-Marken	
3,833,007	A	9/1974	Jacobs		D482,928	S	12/2003	Liu	
3,900,038	A	8/1975	Masters		D482,934	S	12/2003	Liu	
D240,769	S	7/1976	Bowman		D483,232	S	12/2003	Liu	
4,203,518	A	5/1980	Current		D483,909	S	12/2003	Todeschini	
D261,601	S	11/1981	Kettlestrings		D485,359	S	1/2004	McMichael et al.	
4,299,242	A	11/1981	Choe		D488,353	S	4/2004	Govrik et al.	
D270,551	S	* 9/1983	Thayer	D21/392	D488,618	S	4/2004	Wekstein	
D280,354	S	8/1985	Bakic		D490,932	S	6/2004	Mammone	
D281,259	S	* 11/1985	Hensley	D21/392	D491,336	S	6/2004	Cecere	
D281,825	S	12/1985	Bakic		D495,834	S	9/2004	Todeschini	
4,697,856	A	10/1987	Abraham		D496,759	S	9/2004	Rodriguez	
D298,070	S	10/1988	Ferrari		D501,580	S	2/2005	Sugawara	
D299,561	S	1/1989	Bakic		D506,573	S	6/2005	de Grandcourt	
D301,371	S	5/1989	Kaprelian		D507,678	S	7/2005	Lamagna	
D302,602	S	8/1989	Bakic		D509,942	S	9/2005	Connolly et al.	
D314,066	S	1/1991	Bakic		D512,913	S	12/2005	Gauthier	
D318,346	S	7/1991	Bakic		6,981,814	B2	1/2006	Geardino et al.	
5,033,626	A	7/1991	Platti		D515,242	S	2/2006	Cho	
D328,246	S	7/1992	Nottingham et al.		D516,247	S	2/2006	Merheje	
D342,671	S	* 12/1993	Elliott	D3/203.4	7,000,775	B2	2/2006	Gelardi et al.	
D343,340	S	1/1994	Frye, Jr. et al.		D522,376	S	6/2006	Hales	
D348,219	S	6/1994	Goldberg		D532,891	S	11/2006	Buthier et al.	
5,322,166	A	6/1994	Crowther		D533,650	S	12/2006	Ohta	
5,377,700	A	1/1995	Harris		D534,426	S	1/2007	Bakic	
D358,312	S	5/1995	Keenan		7,159,720	B2	* 1/2007	Pearson	B65D 83/04 206/533
D368,495	S	* 4/1996	Rypinski	D21/362	D537,208	S	2/2007	Shaljian	
D373,726	S	9/1996	Power		D540,112	S	4/2007	Nichols et al.	
5,571,543	A	11/1996	Song et al.		D543,662	S	5/2007	Bivona et al.	
D379,923	S	6/1997	De Baschmakoff		D543,815	S	6/2007	Metcalf	
D380,616	S	7/1997	Leslie et al.		D543,850	S	6/2007	Legros	
D382,198	S	8/1997	Mulhauser et al.		D544,148	S	6/2007	Bivona et al.	
D386,808	S	11/1997	Litton		D544,202	S	6/2007	Markfelder	
D387,483	S	12/1997	Sloan		D545,396	S	6/2007	Casey et al.	
D388,549	S	12/1997	Mouyiaris et al.		7,228,863	B2	6/2007	Dumler	
D397,040	S	* 8/1998	Bakic	D9/435	D546,002	S	7/2007	Bowen	
D403,922	S	1/1999	Terraccino		D547,940	S	8/2007	Sandy	
D404,531	S	1/1999	Bakic et al.		D561,045	S	2/2008	Lee	
5,896,996	A	4/1999	Chuang		D561,942	S	2/2008	Khubani	
D411,649	S	6/1999	Bakic		D563,157	S	3/2008	Bouveret et al.	
D418,018	S	* 12/1999	Winsted	D7/551.1	D563,616	S	3/2008	Lynde et al.	
D418,253	S	12/1999	Bakic		D563,728	S	* 3/2008	Welch, III	D7/500
6,003,467	A	* 12/1999	Shelton-Ferrell	G09F 11/23 116/308	D569,041	S	5/2008	Azoulay	
6,032,609	A	* 3/2000	Luoma	G09F 11/23 116/205	D569,553	S	5/2008	Cho	
D437,086	S	1/2001	Dickert		7,374,048	B2	5/2008	Mazurek	
6,182,839	B1	2/2001	Robbins		D571,543	S	6/2008	Sungadi	
D442,304	S	5/2001	Huang		D573,308	S	7/2008	Wittke-Kothe	
6,230,715	B1	5/2001	Cho		D575,904	S	8/2008	Iqbal	
D443,471	S	6/2001	Lillelund et al.		D579,059	S	10/2008	Chan	
6,174,321	B1	6/2001	Webb		D584,449	S	1/2009	Shaljian	
6,265,010	B1	7/2001	Franco		D587,529	S	* 3/2009	Pratt	D7/553.8
D448,927	S	10/2001	Vazquez		D588,746	S	3/2009	Ross	
D452,151	S	12/2001	Scott		D591,599	S	5/2009	Okin et al.	
D454,981	S	3/2002	Lamagna et al.		D592,923	S	5/2009	Konopka	
D456,077	S	4/2002	Etter et al.		D595,054	S	6/2009	Whitaker	
D456,097	S	4/2002	LaMagna et al.		D600,441	S	* 9/2009	Estrada	D3/203.3
D458,413	S	6/2002	Boilen		D602,354	S	10/2009	Dibnah et al.	
6,439,406	B1	8/2002	Duhon		D604,579	S	11/2009	Robinson et al.	
					D605,514	S	12/2009	Weber	
					D607,332	S	1/2010	Huntington et al.	
					D615,290	S	5/2010	Heffner	
					D617,187	S	6/2010	Murray	
					D617,943	S	6/2010	Bouix et al.	

US D955,645 S

(56)

References Cited

U.S. PATENT DOCUMENTS

7,748,391	B2	7/2010	Vance		D800,966	S	10/2017	Silva
D627,103	S	11/2010	Cho		D806,315	S	12/2017	Hardwick
D631,606	S *	1/2011	Chen	D28/73	D810,534	S	2/2018	Liu
7,896,192	B2 *	3/2011	Conley	G07F 17/0092 221/15	D811,872	S	3/2018	Wu
D638,733	S	5/2011	Sullivan		D814,107	S	3/2018	Lotti et al.
D639,196	S	6/2011	Sullivan		D817,132	S	5/2018	Vang
D640,005	S	6/2011	Lee et al.		9,993,373	B2	6/2018	Nassif et al.
D640,834	S	6/2011	Chen		D823,538	S	7/2018	Ruggaber
D647,799	S	11/2011	Dunwoody		D823,683	S	7/2018	Caldwell
D650,669	S	12/2011	Dunwoody		D825,333	S	8/2018	Ozamiz et al.
D650,670	S	12/2011	Dunwoody		D828,013	S	9/2018	Van Wijngaarden et al.
D651,082	S	12/2011	Dunwoody		D828,014	S *	9/2018	Van Wijngaarden D3/203.3
D657,496	S	4/2012	Flatt		D828,629	S	9/2018	Hussain
D659,330	S	5/2012	Davis		D829,381	S	9/2018	Kim
D661,185	S	6/2012	Battat		D830,170	S	10/2018	Holmes
D661,599	S	6/2012	Floyd et al.		D832,701	S	11/2018	Oates
8,205,761	B2 *	6/2012	Stull, Sr.	B65D 50/041 215/220	D832,702	S *	11/2018	Oates D9/447
D663,113	S *	7/2012	Simms	D3/203.3	D835,465	S	12/2018	Son et al.
D664,011	S	7/2012	Afonso		D836,432	S	12/2018	Riedel et al.
8,225,800	B2	7/2012	Byrne		10,149,528	B2	12/2018	Erickson et al.
D669,223	S	10/2012	Lee		D836,943	S	1/2019	Klieman
D670,030	S	10/2012	Nguyen		D837,653	S	1/2019	Meranus
D673,325	S	12/2012	Martines		10,264,837	B2	4/2019	Park
D679,590	S *	4/2013	Stull, Sr.	D9/452	D847,631	S	5/2019	Villbrandt
D679,591	S	4/2013	Stull, Sr. et al.		D847,632	S	5/2019	Villbrandt
D679,592	S	4/2013	Stull, Sr. et al.		D848,795	S	5/2019	Butler
D679,595	S *	4/2013	Stull, Sr.	D9/452	D850,715	S	6/2019	Lotti
D679,596	S *	4/2013	Stull, Sr.	D9/452	D852,412	S	6/2019	Grund et al.
D682,103	S *	5/2013	Jedlicka	D9/452	10,362,823	B1	7/2019	Hill et al.
D682,688	S	5/2013	Murray		D863,419	S	10/2019	Oguma et al.
D686,495	S	7/2013	Murray		D863,679	S	10/2019	Lotti
D690,419	S	9/2013	Porat		D867,664	S	11/2019	Lotti
8,567,640	B1 *	10/2013	Johnson-Lofton	A61J 7/0069 221/232	D867,668	S *	11/2019	Lotti D28/73
8,596,284	B2 *	12/2013	Byrne	A41G 5/02 132/201	10,479,566	B2 *	11/2019	Doyle B65D 47/265
D698,078	S	1/2014	Purizhansky et al.		D871,673	S	12/2019	Qureshi et al.
8,657,170	B2	2/2014	Martinez		10,532,861	B2 *	1/2020	Kimmel B65D 25/04
D700,799	S	3/2014	Ludeman et al.		D877,416	S *	3/2020	Lotti D28/73
8,701,685	B2	4/2014	Chipman		D890,430	S	7/2020	Lotti
D707,392	S	6/2014	Yu et al.		D895,201	S	9/2020	Lotti
D707,556	S	6/2014	Kawamura		D895,958	S	9/2020	Guo et al.
D709,129	S	7/2014	Moertl		D917,153	S	4/2021	Denei et al.
D711,227	S *	8/2014	Sheikh	D9/435	D918,475	S	5/2021	Hu
D713,217	S	9/2014	Micara-Sartori et al.		D920,400	S	5/2021	Saito
D714,494	S	9/2014	Vasquez et al.		D920,465	S	5/2021	Bould et al.
D716,498	S	10/2014	Wolff		D930,788	S	9/2021	Roth
D717,038	S	11/2014	Lee		D932,101	S	9/2021	Davis et al.
8,881,741	B1	11/2014	Mattson et al.		2002/0094507	A1	7/2002	Feuer
8,881,744	B2	11/2014	McKinstry		2003/0005941	A1	1/2003	Iosilevich
8,939,159	B2	1/2015	Yeo et al.		2003/0111467	A1	6/2003	Norman
9,004,299	B2	4/2015	Hardin		2003/0155317	A1 *	8/2003	McNeeley A47B 49/00 211/78
D738,579	S	9/2015	Owens et al.		2004/0011372	A1	1/2004	Park
D738,611	S	9/2015	Gupta		2005/0061341	A1	3/2005	Choe
D746,046	S	12/2015	Lee		2005/0166939	A1 *	8/2005	Stroud A45D 40/30 132/216
9,215,901	B1	12/2015	Schroeder		2006/0124658	A1	6/2006	Coe et al.
D751,904	S	3/2016	Landrum et al.		2006/0129187	A1	6/2006	Cho
D753,881	S	4/2016	Hussain et al.		2006/0142693	A1	6/2006	Kahen
9,314,085	B2	4/2016	Hatch		2007/0050207	A1	3/2007	Merszei
D755,577	S	5/2016	Segal		2007/0084749	A1	4/2007	Demelo et al.
D757,274	S	5/2016	Gelb et al.		2007/0227550	A1	10/2007	Merszei
D758,009	S	5/2016	Berkos		2007/0272264	A1	11/2007	Byrne
9,351,752	B2	5/2016	Slavin		2008/0196732	A1	8/2008	Merszei
D761,489	S	7/2016	Krakovszki		2009/0028625	A1	1/2009	Bonneyrat
D762,433	S	8/2016	Yang		2009/0217939	A1	9/2009	Rabe et al.
D764,688	S	8/2016	Robinson et al.		2009/0223534	A1	9/2009	Green
9,451,800	B2	9/2016	Dinh		2009/0266376	A1	10/2009	Beschta
9,504,285	B2	11/2016	Lin		2010/0170526	A1	7/2010	Nguyen
D775,270	S	12/2016	Moffat		2011/0121592	A1	5/2011	Cho
D783,899	S	4/2017	Roh		2011/0127228	A1 *	6/2011	Sagel A47B 49/004 211/144
D783,901	S	4/2017	Kim et al.		2011/0278869	A1	11/2011	Lee et al.
D784,615	S	4/2017	Choi		2011/0290271	A1 *	12/2011	Rabe A41G 5/02 132/216
D796,582	S	9/2017	Beard		2012/0055499	A1	3/2012	Sanbonmatsu
					2012/0305020	A1	12/2012	Byrne
					2013/0110032	A1	5/2013	Luzon
					2013/0298931	A1	11/2013	Samain et al.
					2013/0320025	A1	12/2013	Mazzetta et al.

(56)

References Cited

OTHER PUBLICATIONS

U.S. PATENT DOCUMENTS

2013/0333714	A1	12/2013	Merszei	
2014/0110304	A1*	4/2014	Wu	B65D 25/54 206/776
2015/0136162	A1	5/2015	Brouillet et al.	
2015/0173442	A1	6/2015	Raouf	
2015/0216246	A1	8/2015	Ahn et al.	
2016/0016702	A1	1/2016	Siskindovich et al.	
2016/0037848	A1	2/2016	Lee	
2016/0219959	A1	8/2016	Chipman et al.	
2017/0112214	A1	4/2017	Ahn	
2017/0112264	A1	4/2017	Park	
2017/0358245	A1	12/2017	Dana	
2018/0065779	A1	3/2018	Chiba	
2018/0160755	A1	6/2018	Hansen et al.	
2018/0242672	A1	8/2018	Lotti	
2018/0242715	A1	8/2018	Lotti	
2018/0352886	A1	12/2018	Schroeder et al.	
2019/0133227	A1	5/2019	Le	
2019/0191851	A1*	6/2019	Esposito	A47F 5/0043
2021/0030140	A1	2/2021	Chico	

FOREIGN PATENT DOCUMENTS

CN	104363790	A	2/2015
CN	205274180	U	6/2016
CN	305719777		6/2016
CN	305719777		11/2019
CN	305738664	*	4/2020
CN	305916370	*	7/2020
EM	006381257-0001	*	5/2019
EM	006381257-0002	*	5/2019
EM	006381257-0003	*	5/2019
EP	1839526		7/2009
GB	1272616	A	5/1972
GB	1307107	A	2/1973
GB	6024289		12/2017
JP	2011-177395		9/2011
JP	2015105447	A	6/2015
KR	300906653		8/2002
KR	20020065306	A	8/2002
KR	20090010717		1/2009
KR	101336422	B1	12/2013
WO	WO2018/022914		1/2018
WO	2018119034	A1	6/2018

Born Pretty, False Eyelashes Thick Natural Simulation Recyclable Curly False Eyelash Makeup Cosmetic Tools , <http://www.bornprettystore.com/false-eyelashes-thick-natural-simulation-recyclable-curly-false-eyelash-makeup-cosmetic-tools-p-44675>.

htmldownloaded from internet Oct. 18, 2018 (6 pages).

Buzludsha Monument, Gueorguy Stoilov circa 1980, justanotherbackpacker.com, published by blogger Rich on Apr. 29, 2014 © 2019, online, site visited Aug. 27, 2019. Available from Internet, URL: <http://www.justanotherbackpacker.com/buzludshamonument-bulgaria-ufo/> (Year: 2014).

Cruiser Portable Speaker, NYNE, published at thegamerwithkids.com, posted by Sam Versionone on Apr. 6, 2015 © not listed, <https://thegamerwithkids.com/2015/04/06/nyne-cruiser-review-a-wireless-speaker-for-your-bicycle/>, downloaded from internet Jun. 20, 2018.

Hongjun web page, https://detail.1688.com/offer/574685154983.html?spm=a2615.7691456.newlist.75_22f96dc5Msy00t, downloaded from internet Oct. 31, 2018 (16 pages).

International Search Report and Written Opinion dated Mar. 12, 2018 in related PCT/2017/067513 filed Dec. 20, 2017 (10 pages). International Search Report and Written Opinion dated Dec. 19, 2019 in related PCT/2019/057104 filed Oct. 19, 2019 (8 pages).

International Search Report and Written Opinion dated Nov. 27, 2017 in related PCT/US2017/044217 filed Jul. 27, 2017 (10 pages).

Lashify Gossamer Lash Cartridge <https://lashify.com/collections/shop-1/products/gossamer-eye-lozenge-c-style?variant=783670738950>, downloaded from internet Jun. 15, 2018 (2 pages).

MAC Cosmetics, 34 Lash, <http://www.bornprettystore.com/false-eyelashes-thick-natural-simulation-recyclable-curly-false-eyelash-makeup-cosmetic-tools-p-44675.html>, downloaded from internet Feb. 14, 2019 (1 page).

Peonies and Lilies, Bourjois 2 in 1 Tweezers and Faux & Fabulous Eyelashes, posted Oct. 24, 2012 (2 pages).

Locking Automated Medication Dispenser, StaarAlert, Starralert.com, autor unlisted, published on Aug. 14, 2020 per wayback machine 2020 STAAR Alert, online, site visted Feb. 19, 2021. Available at URL:<https://www.staaralert.com/locking-medication-dispenser> (Year: 2020).

Cartridge, Lashify, Allure.com, published by Salbe Yong on Oct. 10, 2018 2021 Conde Nast, online, site visted on Feb. 17, 2021. Available at URL: <https://allure.com/story/lashify-false-eyelashes-review-photos> (Year: 2018).

* cited by examiner

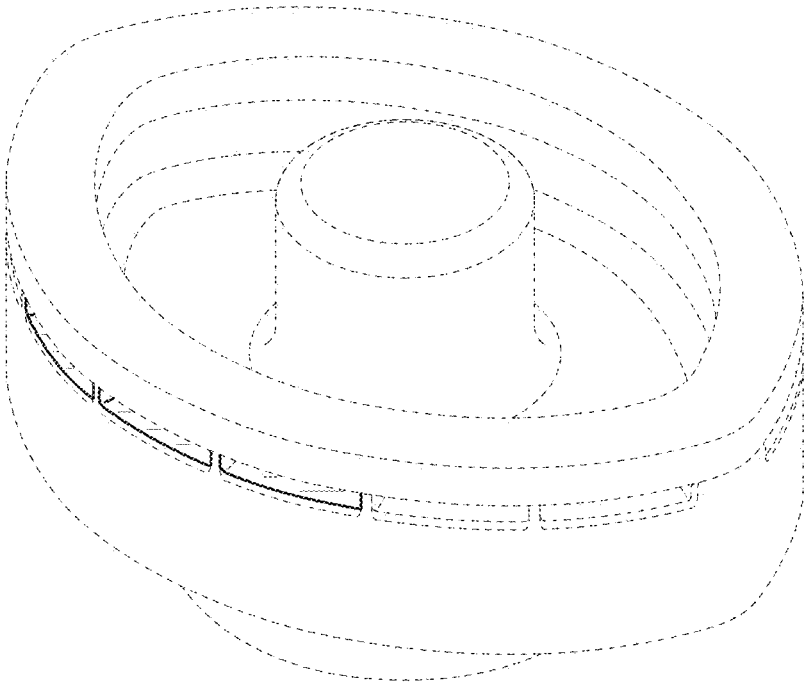

FIG. 1

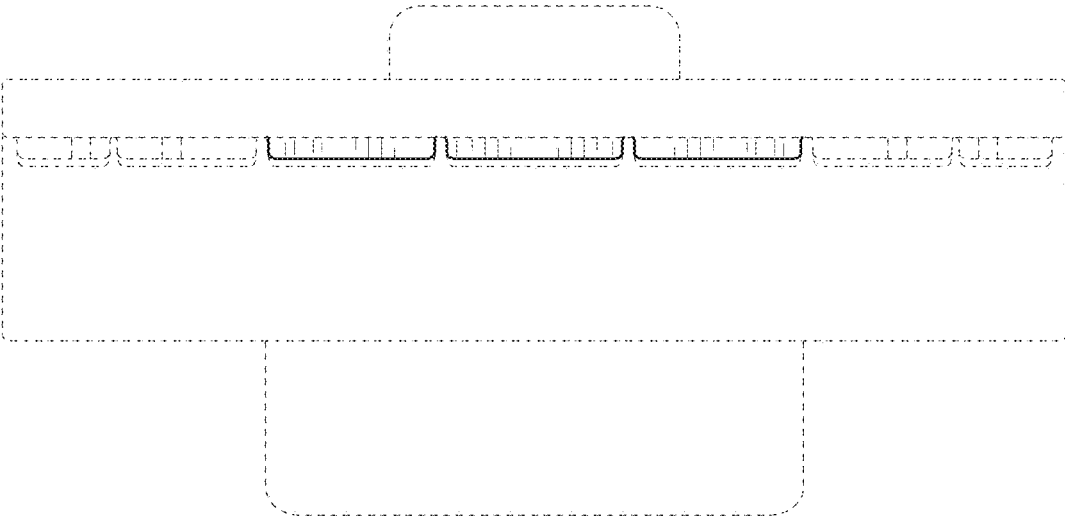

FIG. 2

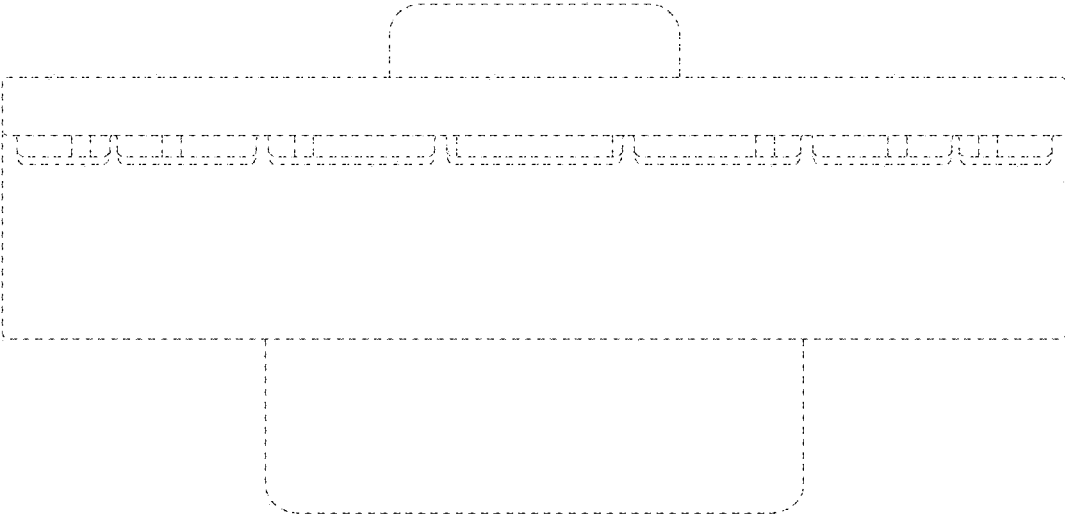

FIG. 3

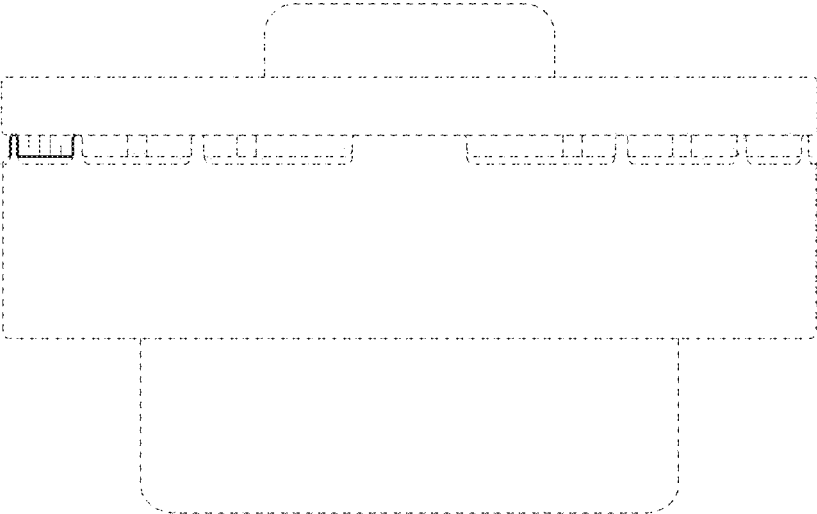

FIG. 4

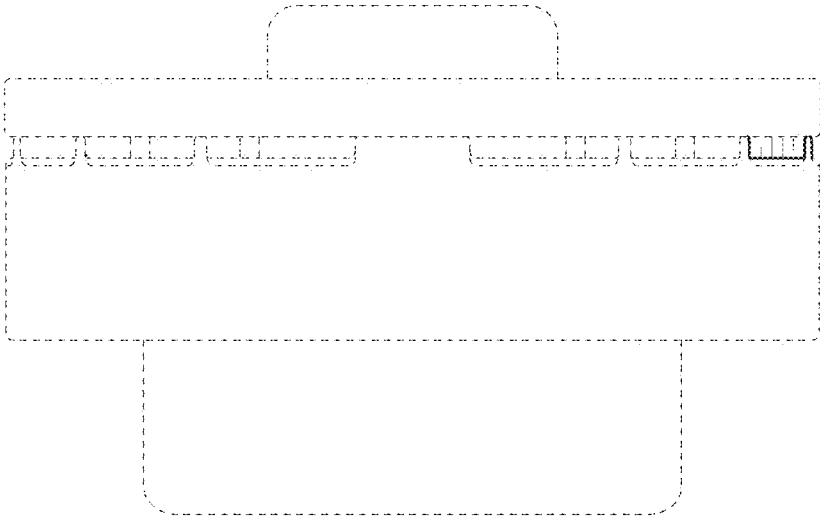

FIG. 5

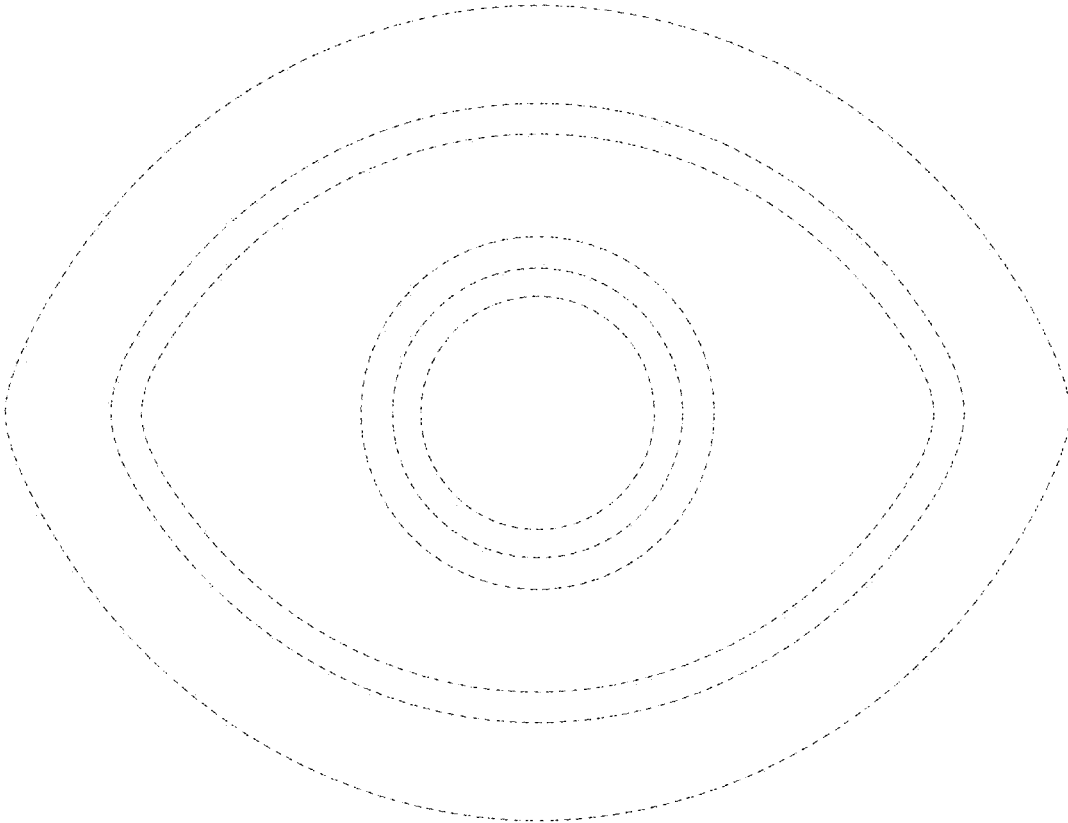

FIG. 6

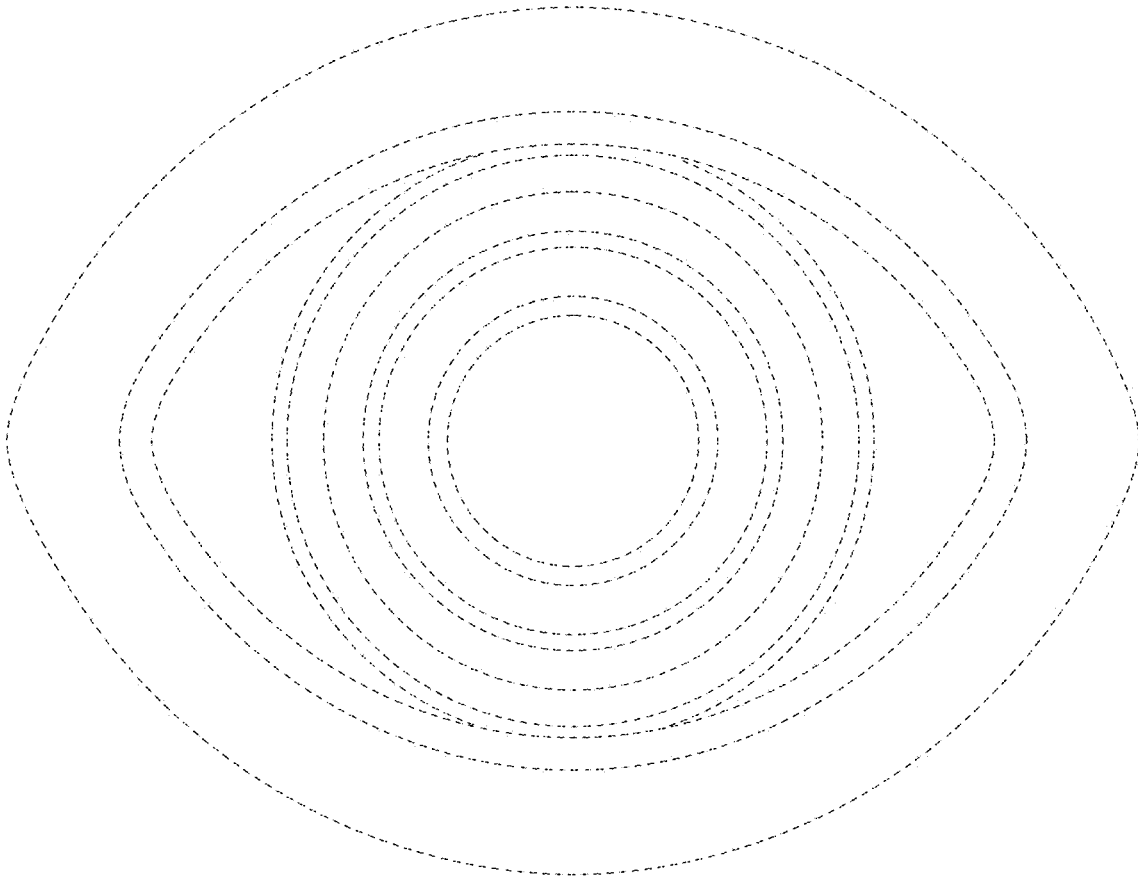

FIG. 7

FIG. 8

